

ENGLISH



Canon

PowerShot Pro1
DIGITAL CAMERA

Camera User Guide



DiG!C

- Please read the *Read This First* section (page 5).
- Please also read the *Software Starter Guide* and the *Direct Print User Guide*.



BUBBLE JET
DIRECT

Canon

Canon DIGITAL CAMERA PowerShot Pro1 Camera User Guide

Flowchart and Reference Guides

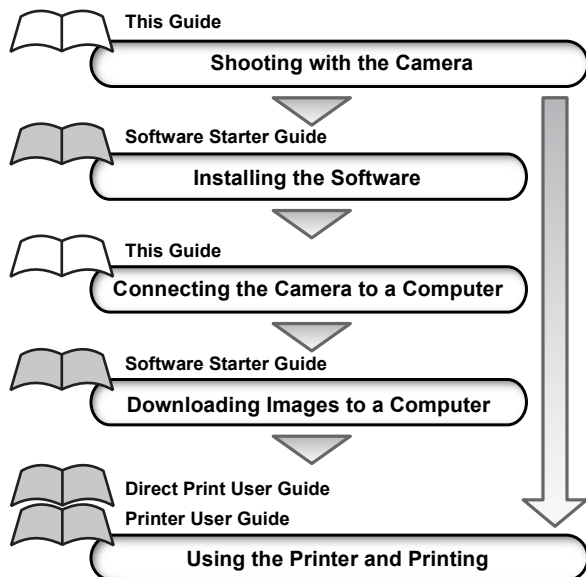

Use of genuine Canon accessories is recommended.

This product is designed to perform optimally when used with genuine Canon accessories. Canon shall not be liable for any damage to this product and/or accidents such as fire, etc., caused by the malfunction of non-genuine Canon accessories (e.g., a leakage and/or explosion of a battery pack). Please note that this warranty does not apply to repairs arising out of the malfunction of non-genuine Canon accessories, although you may request such repairs on a chargeable basis.

(i)

		CMOS	🔄	📷	📺	📺	📺	P	Tv	Av	M	Reference Page	
Macro Mode		○	○	–	○	○	○	○	○	○	○	73	
Super Macro Mode		–	–	–	–	–	–	–	○	○	○	75	
Safety Shift	On	–	–	–	–	–	–	–	○	○	–	86	
	Off	–	–	–	–	–	–	–	○*	○*	–		
Digital Zoom	On	○	○	○	○	–	–	○	○	○	○	78	
	Off	○*	○*	○*	○*	–	–	○*	○*	○*	○*		
Exposure Compensation		–	○	○	○	Δ	○	○	○	○	–	92	
Light Metering System	Evaluative Metering	○	○	○	○	○	○	○*	○*	○*	○*	90	
	Center-Weighted Averaging	–	–	–	–	–	–	○	○	○	○		
	Spot Metering	Center	–	–	–	–	–	–	○*	○*	○*		○*
		AF Point	–	–	–	–	–	–	○	○	○		○
AE Lock/FE Lock		–	–	–	–	–	–	○	○	○	–	104/106	
Bracket	AEB	–	–	–	–	–	–	○	○	○	–	100	
	Focus-BKT (1)	–	–	–	–	–	–	○(1)	○(1)	○(1)	○(1)	102	
White Balance (2)	WB	–(3)	○	○	○	Δ	○(4)	○	○	○	○	93	
Photo Effect		–	○	○	○	Δ	○	○	○	○	○	96	
	Contrast/Sharpness/Saturation	–	–	–	–	–	–	○	○	○	○		
Focus settings	Continuous	○*	○*	○*	○*	Δ*	○	○*	○*	○*	○*	116	
	Single	○	○	○	○	Δ	○	○	○	○	○		
ISO Speed	ISO	–(5)	–(5)	–(5)	–(5)	–(5)	–(5)	○	○	○	○(6)	99	
Color Space	Standard	○	○	○	○	○	–	○*	○*	○*	○*	98	
	Adobe RGB	–	–	–	–	–	–	○	○	○	○		
Reverse Display	On	○*	○*	○*	○*	–	○*	○*	○*	○*	○*	48	
	Off	○	○	○	○	○	○	○	○	○	○		
Auto Rotate	On	○*	○*	○*	○*	Δ*	–	○*	○*	○*	○*	119	
	Off	○	○	○	○	Δ	–	○	○	○	○		
ND Filter	–	–	–	–	–	–	–	○	○	○	○	118	

* Default setting ○: Setting selection is possible. Δ: Setting can only be selected for the first image. –: Setting selection is not possible.

■ (Shaded Area): Setting remains in effect even when the camera is turned off.

The default for the settings changed by the menu and button operations can be restored all at once except for [Date/Time], [Language] and [Video System] (page 52).

- (1) Selectable only in manual focus.
- (2) Cannot be adjusted when the photo effect is set to [Sepia] or [B/W].
- (3) The white balance is set to [AUTO].
- (4) The white balance [flash] cannot be set.
- (5) The ISO speed is automatically set by the camera.
- (6) ISO [AUTO] cannot be selected.

Camera Body Temperature

If your camera is used for prolonged periods, the camera body may become warm. Please be aware of this and take care when operating the camera for an extended period.

About the LCD Monitor and Viewfinder

The LCD monitor and viewfinder are produced with extremely high-precision manufacturing techniques. More than 99.99% of the pixels operate to specification. Less than 0.01% of the pixels may occasionally misfire or appear as red or black dots. This has no effect on the recorded image and does not constitute a malfunction.

Video Format

Please set the camera's video signal format to the one used in your region before using it with a TV monitor (p. 153).

Language Setting

Please see page 28 to change the language setting.

Please read through the "Read This First" section (p. 5) before using your camera.

Disclaimer

- While every effort has been made to ensure that the information contained in this guide is accurate and complete, no liability can be accepted for any errors or omissions.
- Canon reserves the right to change the specifications of the hardware and software described herein at any time without prior notice.
- No part of this guide may be reproduced, transmitted, transcribed, stored in a retrieval system, or translated into any language in any form, by any means, without the prior written permission of Canon.
- Canon makes no warranties for damages resulting from corrupted or lost data due to a mistaken operation or malfunction of the camera, the software, the CompactFlash™ cards (CF cards), personal computers, peripheral devices, or use of non-Canon CF cards.

Trademark Acknowledgements

- Canon and PowerShot are trademarks of Canon, Inc.
- CompactFlash is a trademark of SanDisk Corporation.
- iBook and iMac are trademarks of Apple Computer, Inc.
- Macintosh, PowerBook, Power Macintosh and QuickTime are trademarks of Apple Computer, Inc, registered in the United States and other countries.
- Microsoft, Windows, and Windows NT are either registered trademarks or trademarks of Microsoft Corporation in the United States and/or other countries.
- Other names and products not mentioned above may be registered trademarks or trademarks of their respective companies.

About this Camera User Guide

Symbols Used



: This mark denotes issues that may affect the camera's operation.



: This mark denotes additional topics that complement the basic operating procedures.

Question? Look Here First.

- **What settings are available under each function?**
- **Will my settings remain in effect even after I've turned the camera off?**

Functions Available in Each Shooting Mode (p. 202)

- **What functions are available through the menus?**

FUNC. Menu (p. 43)

Rec. Menu (p. 46)

Play Menu (p. 48)

Set up Menu (p. 49)

My Camera Menu (p. 51)

- **What do the icons listed in the *Camera User Guide* mean?**

Information Displayed on the LCD Monitor/Viewfinder (p. 35)

Selecting Menus and Settings (p. 43)

The above sections are shaded on the right edges to make them easy to find.

Thumb Index

Introduces you to all of the camera components, and explains how to load batteries and use the shutter button, among other basic functions.

Preparing the
Camera, Basic
Functions

Describes shooting with the camera, from each shooting mode to using the camera's various shooting features.

Shooting

Explains how to review recorded images or select playback settings, how to protect images or erase them, and how to edit movies.

Playback, Erasing

Explains how to make DPOF print settings, and how to select images for transferring to e-mail.
Refer to the *Direct Print User Guide* for printing instructions.

Print Order,
Transferring

Explains how to transfer images to a computer. Also explains how to use a TV set for shooting and playing back images.

You must read this section before connecting your camera to a computer.

Connecting

Explains how to customize the camera using My Camera settings and how to set the camera's start-up image, and start-up, shutter and operation sounds.





My Camera
Settings



















Shows the error messages. Also explains how to use the wireless controller and various separately sold accessories such as the power kit, externally mounted flash units and conversion lenses.

Appendix

Table of Contents

: Functions and operations tables. These pages are shaded on the right edges to make them easy to find.

Read This First	5
Components Guide	11
Front View	11
Back/Bottom View	12
Controls	13
Mode Dial	14
Main Dial	15
Display Panel	16
Preparing the Camera	18
Charging the Battery Pack	18
Installing the Battery Pack/CF card	21
Attaching the Neck Strap	24
Attaching the Lens Cap	24
Attaching the Lens Hood	25
Attaching the Filter Adapter	25
Setting the Date/Time	26
Setting the Language	28
Basic Functions	29
Turning the Power On/Off	29
Using the LCD Monitor/Viewfinder	32
Checking the information on the LCD Monitor/Viewfinder ..	34
Using the Zoom (Focal Length)	39
Pressing the Shutter Button	41
Selecting Menus and Settings	43
Resetting the Settings to Default	52
Shooting – Letting the Camera Select Settings	53
 Auto Mode	53
Reviewing an Image Right after Shooting	54
Changing the Resolution and Compression	57
Changing the File Format	60
 Using the Built-In Flash	62
 Portrait Mode	66
 Landscape Mode	66

	Night Scene Mode	67
	Shooting Panoramic Images (Stitch Assist)	68
	Movie Mode	71
	Macro Mode	73
	Super Macro Mode	75
	Self-Timer	77
	Digital Zoom	78
	Continuous Shooting	79
Shooting – Selecting Particular Effects		81
P	Program AE	81
Tv	Setting the Shutter Speed	82
Av	Setting the Aperture	85
M	Manually Setting the Shutter Speed and Aperture	87
	Selecting an AF Frame	89
	Switching between Light Metering Modes	90
	Adjusting the Exposure	92
WB	Adjusting the Tone (White Balance)	93
	Changing the Photo Effect	96
	Shooting in Adobe RGB Color Space	98
	Changing the ISO Speed	99
	Auto Exposure Bracketing (AEB Mode)	100
	Focus Bracketing (Focus-BKT Mode)	102
	Locking the Exposure Setting (AE Lock)	104
	Locking the Flash Exposure Setting (FE Lock)	106
	Switching between Flash Adjustment Settings	107
	Switching the Timing at which the Flash Fires	109
	Shooting Images at Set Intervals (Intervalometer)	110
	Shooting Problem Subjects for the Autofocus	112
	Switching between Focus Settings	116
C1 C2	Saving Custom Settings	116
	Using the ND Filter	118
	Setting the Auto Rotate Function	119
	Resetting the File Numbers	120
Playback		122
	Displaying Images Individually	122
	Magnifying Images	123
	Viewing Nine Images at a Time (Index Playback)	124
JUMP	Jumping Between Images	125
	Viewing Movies	126

Editing Movies	128
Rotating Images in the Display	130
Attaching Sound Memos to Images	131
Automated Playback (Slide Show)	133
Protecting Images	137
Erasing	138
Erasing Images Individually	138
Formatting a CF Card	139
Print Order	140
About Printing	140
Print Settings (DPOF Print Settings)	142
Image Transmission Settings (DPOF Transfer Order)	147
Selecting Images for Transferring	147
Downloading Images to a Computer	149
Connecting the Camera to a Computer Via the USB Cable	149
Downloading Directly from a CF Card	152
Viewing Images on a TV Set	153
Customizing the Camera (My Camera Settings)	154
Changing My Camera Settings	154
Registering the My Camera Settings	156
List of Error/Message Codes	159
List of Messages	160
Troubleshooting	162
Appendix	168
Using the Wireless Controller	168
Using an Externally Mounted Flash (Sold Separately)	171
Using the Tele-converter (Sold Separately)/Close-up Lens (Sold Separately)	177
Using a Compact Power Adapter (Sold Separately)	182
Using a Battery Charger (Sold Separately) and Car Battery Cable (Sold Separately)	183
Replacing the Date Battery	184
Camera Care and Maintenance	185
Specifications	186
Index	195
Functions Available in Each Shooting Mode	202

Test Shots

Before you try to photograph important subjects, we highly recommend that you shoot several trial images to confirm that the camera is operating and being operated correctly.

Please note that Canon, its subsidiaries and affiliates, and its distributors are not liable for any consequential damages arising from any malfunction of a camera or accessory, including CompactFlash™ cards, that results in the failure of an image to be recorded or to be recorded in a format that is machine readable.

Warning Against Copyright Infringement

Please note that Canon digital cameras are intended for personal use and should never be used in a manner that infringes upon or contravenes international or domestic copyright laws and regulations. Please be advised that in certain cases the copying of images from performances, exhibitions, or commercial properties by means of a camera or other device may contravene copyright or other legal rights even if the image was recorded for personal use.

Warranty Limitations

This camera's warranty is only effective in the country of sale. If a problem arises while the camera is in use abroad, please convey it back to the country of sale before proceeding with a warranty claim to a Canon Customer Support Help Desk.

For Canon Customer Support contacts, please see the Canon Limited Warranty supplied with your camera.

Safety Precautions

- Before using the camera, please ensure that you read and understand the safety precautions described below. Always ensure that the camera is operated correctly.
- The safety precautions noted on the following pages are intended to instruct you in the safe and correct operation of the camera and its accessories to prevent injuries or damage to yourself, other persons and equipment.
- In the next few pages, the term "equipment" refers primarily to the camera, its power supply accessories and a separately sold compact power adapter.

Warnings

- **Do not aim the camera directly into the sun or at other intense light sources** which could damage your eyesight.

- **Do not trigger the flash in close proximity to human or animal eyes.** Exposure to the intense light produced by the flash may damage eyesight. In particular, remain at least one meter (39 inches) away from infants when using the flash.

- **Store this equipment out of the reach of children and infants.** Accidental damage to the camera or batteries by a child could result in serious injury. In addition, placement of the strap around the child's neck could result in asphyxiation.

- **Be particularly careful to keep the date battery used in the camera away from children.** Seek medical assistance immediately if a child swallows a battery.

- **Do not attempt to disassemble or alter any part of the equipment that is not expressly described in this guide.** Disassembly or alteration may result in high voltage electrical shock. Internal inspections, alterations and repairs should be conducted by qualified service personnel authorized by your camera distributor or a Canon Customer Support Help Desk.

- **To avoid the risk of high-voltage electrical shock, do not touch the flash portion of the camera if it has been damaged.** Similarly, never touch internal portions of the equipment that become exposed as a result of damage. There is a risk of high voltage electrical shock. Please take the first opportunity to consult your camera distributor or a Canon Customer Support Help Desk.

- **Stop operating the equipment immediately if it emits smoke or noxious fumes.** Failure to do so may result in fire or electrical shock. Immediately turn the camera's power off, remove the camera battery or unplug the power cord from the power outlet. Confirm that smoke and fume emissions have ceased. Please consult your camera distributor or the closest Canon Customer Support Help Desk.

- **Stop operating the equipment if it is dropped or the casing is damaged.** Failure to do so may result in fire or electrical shock. Immediately turn the camera's power off, remove the camera battery or unplug the power cord from the power outlet. Please consult your camera distributor or the closest Canon Customer Support Help Desk.

-
- **Do not allow the equipment to come into contact with, or become immersed in, water or other liquids.** Do not allow liquids to enter the interior. The camera has not been waterproofed. If the exterior comes into contact with liquids or salt air, wipe it dry with a soft, absorbent cloth. In the event that water or other foreign substances enter the interior, immediately turn the camera's power off and remove the camera battery or unplug the power cord from the power outlet. Continued use of the equipment may result in fire or electrical shock. Please consult your camera distributor or the closest Canon Customer Support Help Desk.
-
- **Do not use substances containing alcohol, benzene, thinners or other flammable substances to clean or maintain the equipment.** The use of these substances may lead to fire.
-
- **Remove the power cord on a regular periodic basis and wipe away the dust and dirt that collects on the plug, the exterior of the power outlet and the surrounding area.** In dusty, humid or greasy environments, the dust that collects around the plug over long periods of time may become saturated with humidity and short-circuit, leading to fire.
-
- **Do not cut, damage, alter or place heavy items on the power adapter cord.** Any of these actions may cause an electrical short circuit, which may lead to fire or electrical shock.
-
- **Do not handle the power cord if your hands are wet.** Handling it with wet hands may lead to electrical shock. When unplugging the cord, ensure that you hold the solid portion of the plug. Pulling on the flexible portion of the cord may damage or expose the wire and insulation, creating the potential for fires and electrical shocks.
-
- **Use only the recommended power accessories.** Use of power sources not expressly recommended for this equipment may lead to overheating, distortion of the equipment, fire, electrical shock or other hazards.
-
- **Do not place the batteries near a heat source or expose them to direct flame or heat.** Neither should you immerse them in water. Such exposure may damage the batteries and lead to the leakage of corrosive liquids, fire, electrical shock, explosion or serious injury.
-

-
- **Do not attempt to disassemble, alter or apply heat to the batteries.** There is serious risk of injury due to an explosion. Immediately flush with water any area of the body, including the eyes and mouth, or clothing, that comes into contact with the inner contents of a battery. If the eyes or mouth contact these substances, immediately flush with water and seek medical assistance.
-
- **Avoid dropping or subjecting the batteries to severe impacts that could damage the casings.** It could lead to leakage and injury.
-
- **Do not short-circuit the battery terminals with metallic objects, such as key holders.** It could lead to overheating, burns and other injuries. Use the supplied terminal cover to transport or store the battery pack.
-
- **Before you discard a battery, cover the terminals with tape or other insulators to prevent direct contact with other objects.** Contact with the metallic components of other materials in waste containers may lead to fire or explosions. Discard the batteries in specialized waste facilities if available in your area.
-
- **Use only recommended batteries and accessories.** Use of batteries not expressly recommended for this equipment may cause explosions or leaks, resulting in fire, injury and damage to the surroundings.
-
- **Disconnect the compact power adapter from both the camera and power outlet after recharging and when the camera is not in use to avoid fires and other hazards.** Continuous use over a long period of time may cause the unit to overheat and distort, resulting in fire.
-
- **The camera terminal of the separately sold compact power cord is designed for exclusive use with your camera.** Do not use it with other products or batteries. There is a risk of fire and other hazards.
-
- **Exercise due caution when screwing on the separately sold tele-converter lens, close-up lens and conversion lens adapter.** If they loosen, fall off and shatter, the glass shards may cause an injury.
-

⚠ Cautions

- **Avoid using, placing or storing the equipment in places subject to strong sunlight or high temperatures, such as the dashboard or trunk (boot) of a car.** Exposure to intense sunlight and heat may cause the batteries to leak, overheat or explode, resulting in fire, burns or other injuries. High temperatures may also cause deformation of the casing. Ensure that there is good ventilation when using the compact power adapter to charge the battery pack or power the camera.

- **Do not store the equipment in humid or dusty areas.** Storage in such areas could lead to fire, electrical shock or other damage.

- **Be careful not to bang the camera or subject it to strong impacts or shocks** that could lead to injury or damage the equipment when wearing or holding it by the strap.

- **Be careful not to cover the flash with your fingers or clothing when shooting.** The flash may be damaged and emit smoke or noise. In addition, do not touch the surface of the flash after taking several pictures in rapid succession. Either action could result in burns.

- **Do not operate the flash with dirt, dust or other items stuck to its lens.** The resulting heat build-up could damage the flash.

- **Ensure that the battery charger is plugged into a power outlet of the specified rating, not over the specified rating.** The plug of the battery charger varies according to region.

- **Do not use the battery charger or compact power adapter if the cable or plug is damaged, or if the plug is not fully inserted into the power outlet.**

- **Do not allow metal objects (such as pins or keys) or dirt to contact the charger terminals or plug.**

- **If your camera is used for prolonged periods, the camera body may become warm.** Please take care when operating the camera for an extended period as your hands may experience a burning sensation.

Preventing Malfunctions

■ Avoid Strong Magnetic Fields

Never place the camera in close proximity to electric motors or other equipment generating strong electromagnetic fields. Exposure to strong magnetic fields may cause malfunctions or corrupt image data.

■ Avoid Condensation Related Problems

Moving the equipment rapidly between hot and cold temperatures may cause condensation (water droplets) to form on its external and internal surfaces.

You can avoid this by placing the equipment in an airtight, resealable plastic bag and letting it adjust to temperature changes slowly before removing it from the bag.

■ If Condensation Forms Inside the Camera

Stop using the camera immediately if you detect condensation. Continued use may damage the equipment. Remove the CF card, and battery or a household power source, from the camera and wait until the moisture evaporates completely before resuming use.

■ Extended Storage

When not using the camera for extended periods of time, remove the battery from the camera or battery charger and store the equipment in a safe place. Storing the camera for extended periods with batteries installed will run down the battery. (Do not remove the date battery.)

Front View

Remote Sensor (p. 169)

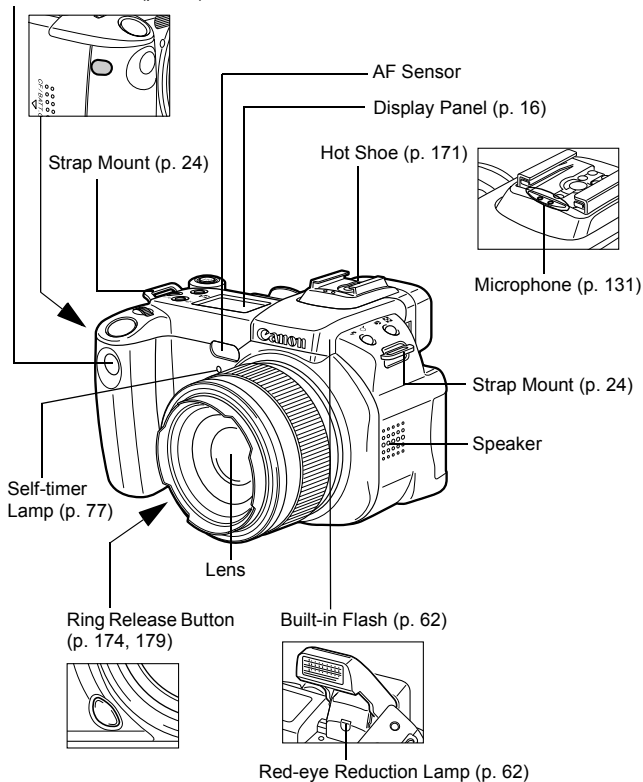

Back/Bottom View

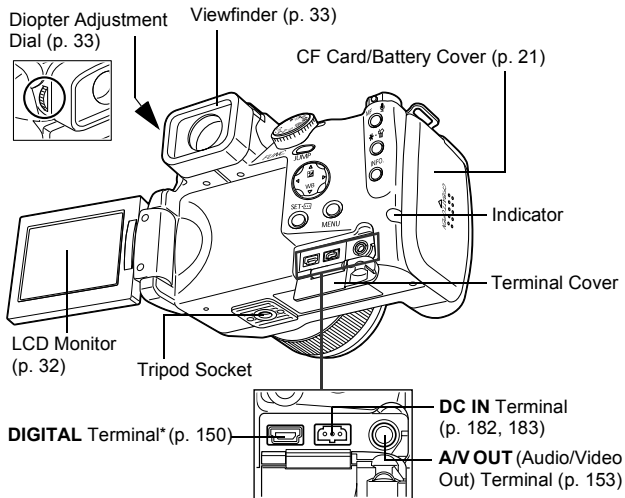

* To connect the camera to a computer or printer, use one of the following cables.

Computer: Interface Cable IFC-400PCU (supplied with the camera)

Direct Print Compatible Printers (Sold Separately)

- CP Printers: Interface Cable IFC-400PCU (supplied with the camera) or the Direct Interface Cable DIF-100 (supplied with CP-100/CP-10).
- Bubble Jet Printers
 - *Bubble Jet Direct* Compatible Printers: Please refer to your Bubble Jet printer user guide.
 - *PictBridge* Compliant Printers: Interface Cable IFC-400PCU (supplied with the camera)
- *PictBridge* Compliant Non-Canon Printers: Interface Cable IFC-400PCU (supplied with the camera)

Please refer to the *System Map* or the *Direct Print User Guide* supplied with the camera for direct print compatible printer information.

Controls

Top

⚡ (Flash)/🔍 (Zoom in) Button (p. 62, 123)

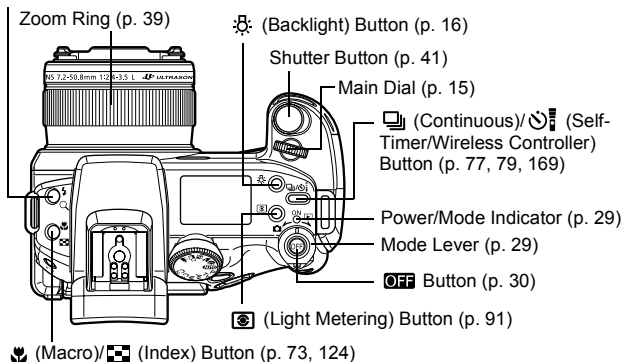

Back

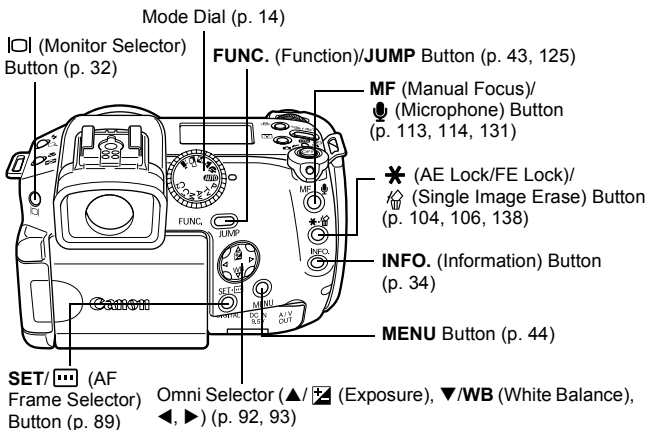

Mode Dial

Use the mode dial to switch between the shooting modes.

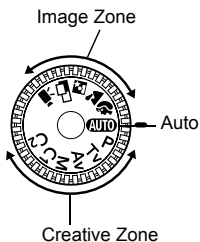

● **AUTO** : Auto (p. 53)

The camera automatically selects settings.

● **Image Zone**

The camera automatically selects settings according to the image composition type.

 : Portrait (p. 66)

 : Landscape (p. 66)

 : Night Scene (p. 67)

 : Stitch Assist (p. 68)

 : Movie (p. 71)

● **Creative Zone**

The user selects exposure, aperture or other settings to achieve special effects.

P : Program AE (p. 81)

Tv : Shutter Speed-Priority AE (p. 82)

Av : Aperture-Priority AE (p. 85)

M : Manual Exposure (p. 87)

C1 : Custom 1 (p. 116)

C2 : Custom 2 (p. 116)

Main Dial

The main dial is used for selecting certain menus and for displaying images. You can easily and swiftly select, confirm and switch menus.

Turning the Main Dial

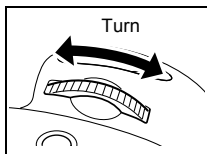

● In Shooting Mode

- Selects aperture value and shutter speed (p. 82, 85, 87)
- Selects menu settings by pressing the **FUNC.** button (p. 43)
- Selects exposure compensation and white balance (p. 92, 93)

● In Playback Mode

- Displays the previous and next image (p. 122)

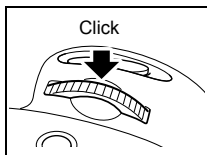

Clicking the Main Dial



● In Shooting Mode





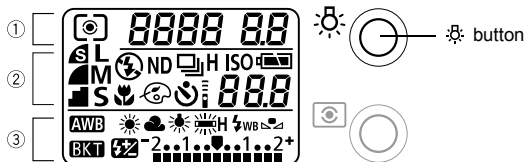

- Fixes menu items set by pressing the **FUNC.** button (p. 43)
- Switches between shutter speeds and aperture values in **M** mode (p. 87)

Display Panel

The display panel shows the camera settings, the remaining image capacity, movie shooting time, battery charge and other information. In Shooting mode (p. 29), you can turn on the backlight of the display panel for six seconds by pressing the  button. To turn off the backlight within six seconds, press the  button again.



	Icons	Indication	Reference pages
		Evaluative Metering/Spot Metering/ Center-Weighted Average Metering	90
①	8888	Shutter Speed/Movie Shooting Time/ White Balance/ISO Speed/Photo Effect/ Bracket/Resolution Setting Value (for each function setting)	57, 71, 82, 87, 93, 96, 99, 100, 102
	8.8	Aperture Setting	85, 87
		Compression	57
	L L M M S S	Resolution (Not displayed with RAW images)	57
		Flash On/Flash Off (Not displayed with Auto)	62
②	ND	ND filter	118
		Single Shot/Standard Continuous Shooting/High-speed Continuous Shooting	79
	ISO	ISO speed	99
		Battery Charge State	22
		Macro Mode*	73

	Photo Effect	96
	Self-Timer/Wireless Controller	77, 168
	Remaining Image Capacity/Message Code/Error Code/ <i>int</i> (Intervalometer)/Interval Shooting Remaining Shots	110, 159
	White Balance Settings	93
	Bracket	100, 102
	Flash Exposure Compensation/Flash Output Adjustment	107
	Exposure Compensation Level/AEB Level/Flash Exposure Compensation Level	92, 100, 107

③



* Goes off in Super Macro mode. The Super Macro mode icon appears on the LCD monitor (or in the viewfinder). (p. 75)



- The diagram above shows all the icons appearing at once. Normally, only the icons applicable to the selected mode and camera state appear.

Preparing the Camera

Charging the Battery Pack

Use the following procedures to charge the battery pack the first time and subsequently when the “Change the battery pack” message displays on the LCD monitor (or in the viewfinder) or the low battery icon () and Lb () message are lit on the Display Panel.

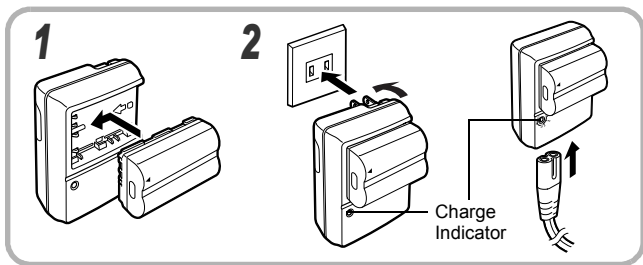

1 Align the edge of the battery pack with the line on the battery charger, then slide the battery in the direction of the arrow.

2 Battery charger model names and types vary by region.

(For CG-580)

Plug the battery charger into a power outlet.

(For CB-5L)

Attach the power cord to the battery charger and plug the other end into a power outlet.

- The charge indicator blinks while the battery pack is charging and lights steadily once charging is complete.
- After charging, unplug the battery charger and remove the battery pack.



- This is a lithium ion battery pack so there is no need to completely use or discharge it before recharging. It can be recharged at any time. However, since the maximum number of charge cycles is approximately 300 (battery life), you are recommended to only charge the battery pack after having discharged it completely to prolong battery life.
- It takes approximately 90 minutes to bring a fully discharged battery pack to a fully charged state (based on Canon's testing standard).
- Charging times will vary according to the surrounding humidity and battery pack charge state.
- The separately sold Battery Pack BP-511, BP-512 and BP-514 can also be used in this camera.

Battery Pack Handling Precautions

- Keep the battery pack and camera terminals (+ - ⊕ ⊗) clean at all times. Dirty terminals may cause a poor contact between the battery pack and camera. Polish the terminals with a tissue or a dry cloth before charging or using the battery pack.
- Do not cover the battery charger with anything, such as a tablecloth, cushion or blanket, when it is charging. Heat will build up internally and possibly lead to fire.
- Do not charge batteries other than Battery Pack BP-511A, BP-511, BP-512 or BP-514 with the supplied equipment. This may cause a malfunction.
- The battery pack continues to discharge a small amount when left in the camera even with the power turned off. This shortens the battery life. Remove the battery pack from the camera when it is not in use.
- Do not allow any metal objects such as keyrings to touch the “+” and “-” terminals (Fig. A), as this can damage the battery pack. To carry the battery pack, or store it during periods of disuse, always replace the terminal cover (Fig. B) or place it in the supplied case and store it in a cool, dry place.

Charging the Battery Pack (continued)

When using Battery Pack BP-511A or BP-514, you can distinguish between the discharged battery pack and fully charged battery pack by changing the direction of the battery cover (Fig. C and D). Recharge the battery fully before using it again.

Fig. A

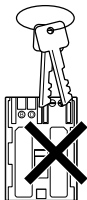

Fig. B

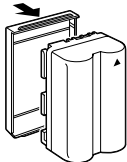
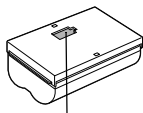

Fig. C

Fully Charged Battery



Attach so the blue portion of the battery pack can be seen through the window.

Fig. D

Used Battery

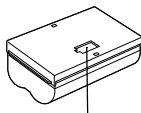

Attach in the opposite way of Fig. C.

- Even charged battery packs continue to discharge naturally. You are advised to charge the battery on the day of use, or one day before, to ensure a full charge.
- Since storing a fully charged battery pack for long periods of time (about 1 year) can shorten its lifecycle or affect performance, you are recommended to use the battery pack in the camera until the **Lb** symbol displays and to store it at normal temperature (30 °C/ 86 °F) or lower. If you do not use the battery pack for long periods of time, charge it fully and discharge it fully in the camera at least once a year before returning it to storage.
- The camera consumes the battery charge when the power is on even when a function is not being used. To conserve the battery charge, be particularly attentive in turning the camera off.
- Although the battery pack's maximum operating range is 0 to 40 °C (32 to 104 °F), the optimal range is 10 to 30 °C (50 to 86 °F). At cold temperatures, such as those experienced when skiing, performance will temporarily decline, reducing the usable time before recharging.
- If the usable time of a battery pack diminishes substantially even when fully charged, it should be replaced.

Installing the Battery Pack/CF card

Install Battery Pack BP-511A (supplied) and the CF card (supplied) into the camera as follows.

Use the Compact Power Adapter CA-560 (sold separately) to power the camera for extended periods (p. 182).

- Charge the battery pack before using it for the first time (p. 18).

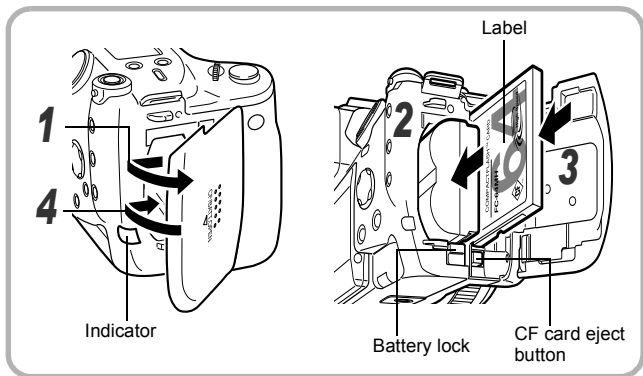

1 Check that the power is off (p. 29) and slide the CF card/battery cover in the direction of the arrow.

2 Insert the battery pack.

- The terminal side of the battery pack should face downward.
- Insert the battery pack all the way in until the battery lock clicks. To remove the battery pack, push the battery lock.

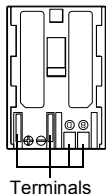

CF Card Handling Precautions

- CF cards are high-precision electronic devices. Do not bend, force, or subject them to shocks or vibration.
- Do not attempt to disassemble or alter a CF card.
- Moving a CF card rapidly between temperature extremes may cause condensation to form in the card, leading to potential malfunctions. To avoid condensation formation, place the CF card in a sealed plastic bag before moving it into a different temperature zone and allow it to adjust slowly to the new temperature.

If condensation forms on the CF card, put it aside until the water droplets have evaporated completely.

- Place the CF card in the supplied case for storage.
- Do not use or store CF cards in the following types of locations.
 - Locations subject to dust or sand
 - Locations subject to high humidity and high temperatures

Microdrives are a recording medium with a hard disk. Their merits are a large capacity and a low price per megabyte of capacity. However, they can be more susceptible to vibrations and shocks than CF cards, which use durable flash memories. Please be careful, therefore, not to subject the camera to vibrations or shocks when using a microdrive, especially while recording or during playback.

Attaching the Neck Strap

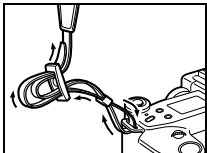

Attach the strap as illustrated on the left. Pull the strap tight in the buckle so that it does not slip. Perform the same steps on the other side of the camera (p. 11).

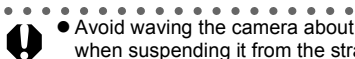

- Avoid waving the camera about or catching it on other items when suspending it from the strap.

Attaching the Lens Cap

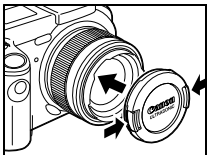

Attach the lens cap as illustrated on the left. Always replace the lens cap after use. To remove the lens cap, press the tabs on the lens cap and pull.

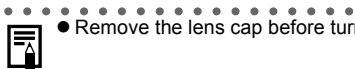

- Remove the lens cap before turning on the camera's power.

Attaching the Lens Hood

When shooting backlit scenes without a flash with the lens set to a wide angle, you should attach the lens hood to prevent light outside the scene from coming into the lens. Be sure to turn off the camera before you attach the lens hood.

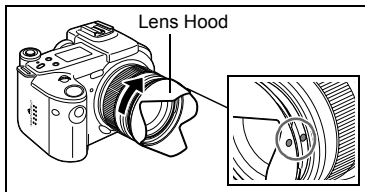

Attach the lens hood so that its ● meets the lens' ●, then turn the lens hood clockwise until the lens' ● meets —°.

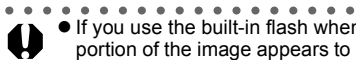

- If you use the built-in flash when the lens hood is attached, a portion of the image appears to be blocked by the lens hood and appears dark.

Attaching the Filter Adapter

If you wish to attach a commercially available filter (58 mm diameter), attach the filter adapter in advance. Be sure to turn off the camera before you attach the filter adapter.

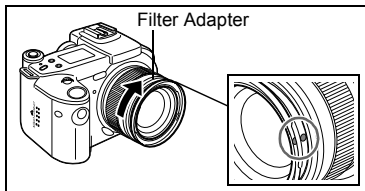

Attach the filter adapter so that its ● meets the lens' ●, then turn the filter adapter clockwise until the lens' ● meets —°.



- The filter adapter is exclusively for use with a filter. If you wish to attach Close-up Lens 500D (sold separately) to the camera, use Conversion Lens Adapter LA-DC58C (sold separately) (p. 177).
- Attaching more than one filter at the same time may cause dark shadows on the image depending on the zoom position.

Setting the Date/Time

The Set Date/Time menu will appear the first time the camera power is turned on or whenever the date lithium battery charge is low. Start from Step 5 to set the date and time.

1 Turn on the camera (p. 29).

2 Press the MENU button.

- The [] (Rec.) or [] (Play) menu appears.

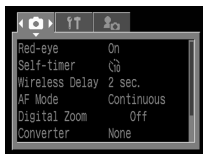

[] (Rec.) Menu in Auto mode

3 Press the ► arrow on the omni selector to select the [] (Set up) menu.

- Pressing the JUMP button also switches between menus.



4 Press the ▲ or ▼ arrow on the omni selector to select [Date/Time] then press the SET button.

- The factory default for the date format may differ from that shown here in some regions.

5 Set the date and time.

- Press the ◀ or ▶ arrow on the omni selector to select a field to change.
- Press the ▲ or ▼ arrow on the omni selector to set the values.
- The date can be set up to the year 2030.

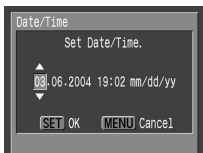

6 Press the SET button.

- After adjusting the settings, press the MENU button to close the menu window.





- The Date/Time cannot be inserted in the actual image even if the Date/Time have been set. For printing images with the date on them, refer to the *Direct Print User Guide* or *Software Starter Guide*.
- *Replacing the Date Battery* (p. 184)

Setting the Language

Use this feature to select the language used in the menus and messages.

1 Turn on the camera (p. 29).

2 Press the MENU button.

- The [ (Rec.)] or [ (Play)] menu appears.

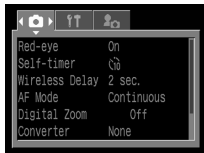

 (Rec.) Menu in Auto mode

3 Press the arrow on the omni selector to select the [(Set up)] menu.

- Pressing the **JUMP** button also switches between menus.



4 Press the or arrow on the omni selector to select [Language] and press the SET button.

5 Press the , , or arrow on the omni selector to select a language.



6 Press the SET button.

- After adjusting the settings, press the **MENU** button to close the menu window.



- In playback mode, you can change the language by holding the **SET** button while you press the **JUMP** button, except when a separately sold printer is connected or during movie playback.

Turning the Power On/Off

The power/mode indicator remains lit while the power of the camera is on. The power/mode indicator indicates the state of the camera as follows.

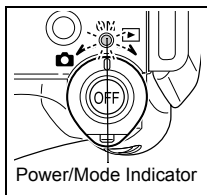

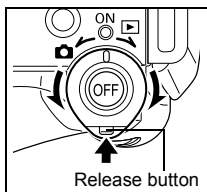

- Orange:** Shooting mode
- Green:** Playback mode/Printer connection mode*
- Yellow:** Computer connection mode*
- Off:** The power of the camera is off.

* For printer connection mode information, see the *Direct Print User Guide*. For computer connection mode information, see the *Software Starter Guide*.



Mode Lever

Use this lever to turn the power on.

To operate the mode lever, press the release button as shown on the left. The mode lever will not operate if the release button is not pressed. After the camera is turned on in  or , release the lever. The mode lever returns to its original position (center).

Powering the Camera in Shooting Mode

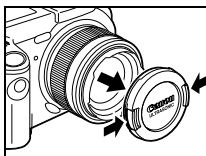
1

Remove the lens cap.

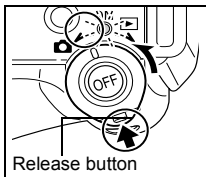
2

Turn the mode lever to  (Shooting) while pressing the release button.

- The power/mode indicator lights orange.
- Open the LCD monitor if needed (p. 32).

Powering the Camera in Playback Mode

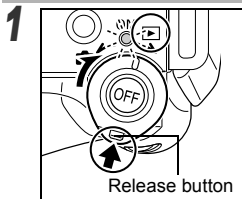

Turn the mode lever to  (Playback) while pressing the release button.

- The power/mode indicator lights green and **Pb** appears on the display panel.
- Open the LCD monitor if needed (p. 32).

Turning the Power Off

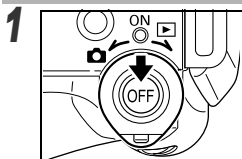

Press the **OFF** button.

- The power goes off.





- Be careful not to touch the lens when shooting. Please also refrain from forcing the lens with fingers or other objects. It could lead to malfunctions or damage the camera. If this occurs, turn the camera off and back on.
- You will hear a start-up sound and see the start-up image when the power comes on. (To change the start-up sound and image, see pages 31, 51 and 154.)
- The start-up image does not appear in the following cases: when the camera is powered in Shooting mode after the monitor was switched to the viewfinder (p. 32) or when the **A/V OUT** terminal is connected to a TV.

Turning on the camera without the start-up sound and image

Press and hold the  button, then turn on the power. You can also turn the camera on with the LCD monitor closed.

Power Saving Function

This camera is equipped with a power saving function. When this function is turned on and it activates, restore power by turning the mode lever toward  or .

Shooting Mode: Powers down approximately 3 minutes after the last control is accessed on the camera.

The LCD monitor (or viewfinder) also shuts off approximately 1 minute* after the last control is accessed on the camera. Press any button except the mode lever to turn the LCD monitor (or viewfinder) back on.

* This time can be changed (p. 50).

Playback Mode: Powers down approximately 5 minutes after the last control is accessed on the camera.

Printer Connection Mode: Powers down approximately 5 minutes after the last control is accessed on the camera or connected printer.

- The power saving function is disabled while a slide show plays on the camera or during a computer connection (p. 133, 149).
- You can turn off the power saving function in the Set up menu (p. 50).

Switching between Shooting and Playback

You can quickly switch between Shooting mode and Playback mode. This is convenient when you wish to shoot again after checking or erasing an image immediately after it is shot.

● Shooting Mode ➔ Playback Mode

Turn the mode lever to  (Playback) while pressing the release button (p. 30).

- The camera switches to Playback mode. In this case, the lens does not retract. (If the mode lever is turned to  (Playback) again, the lens retracts.)

● Playback Mode ➔ Shooting Mode

Remove the lens cap and press the shutter button halfway, or turn the mode lever to  (Shooting) while pressing the release button (p. 29).

Using the LCD Monitor/Viewfinder

Switching between the LCD Monitor and Viewfinder

You can switch between the LCD monitor and viewfinder both in Shooting mode and Playback mode.

● When the LCD Monitor is Closed

The viewfinder turns on.

● When the LCD Monitor is Open

The LCD monitor turns on. (The viewfinder goes off.)

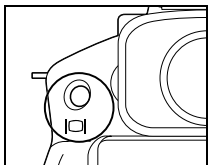

You can switch between the LCD monitor and viewfinder by pressing the  button.

The camera turns on the last selected monitor when powered on in Shooting mode. The camera always turns on the LCD monitor when powered on in Playback mode.

Using the LCD Monitor

If you wish to use the LCD monitor for shooting, playing back images and adjusting menu settings, follow the explanation below.

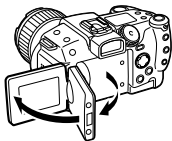

Opened from left to right 180 degrees. It locks temporarily at 90 degrees.

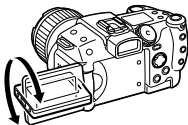

Tilted forward 180 degrees toward the lens or backward 90 degrees.



The LCD monitor will automatically turn off and the viewfinder will turn on when the LCD monitor clicks shut against the camera body facing in.

The LCD monitor can also be positioned as below.

1

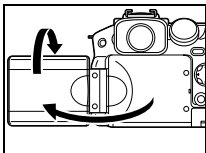

Open the LCD monitor left 180 degrees and tilt it 180 degrees toward the lens.

- In this position, icons and messages do not appear on the LCD monitor.
- The image shown on the LCD monitor is automatically flipped and reversed (the Reverse Display function) so that it appears correctly from in front of the lens. (You can disable the Reverse Display function (p. 48).)

2

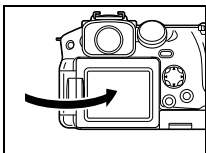

Fold the LCD monitor back against the camera body.

- Fold it until it clicks into place against the camera body. If it is not fully closed, the image will appear reversed and icons and messages will not display.
- Icons and messages will appear and images will show properly (not reversed) when the LCD monitor is folded right against the camera until it clicks.



- In Playback mode, images do not appear reversed. Also, icons and messages always show properly.

Using the Viewfinder

If the surroundings are too bright (for example, when you are shooting outdoors) and images on the LCD monitor are not clear, use the viewfinder for shooting. (The same image and information as the LCD monitor appear in the viewfinder.)

- You can adjust the viewfinder with the diopter adjustment dial to adapt to your vision so that the displayed information (p. 36) appears in crisp focus.

Diopter Adjustment Dial

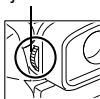

Viewfinder

Checking the information on the LCD Monitor/Viewfinder

Each time you press the **INFO.** button the LCD monitor (or the viewfinder) cycles to the next information mode. Both the LCD monitor and the viewfinder have a field of vision of 100% of the actual shooting image.

Shooting Mode

Each time you press the **INFO.** button the information view switches as follows.

No Information ↔ Information View*

* Depending on the LCD monitor's position, the information view may not display.

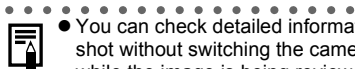

- You can check detailed information about the image you just shot without switching the camera to Playback mode. To do so, while the image is being reviewed right after being taken, press the **SET** button, then **INFO.** button.
- The last selected Information View mode appears the next time you power on the camera.

Playback Mode

Each time you press the **INFO.** button the information view mode cycles as follows.

Single Image Playback (p. 122):

Standard Information View → Detailed Information View → No Information
↑

Index Playback (p. 124):

Standard Information View ↔ No Information

Information Displayed on the LCD Monitor/ Viewfinder



The LCD monitor displays information in Shooting or Playback mode, such as the camera settings, remaining image capacity and shooting date/time.

● Shooting Mode

The information appears for approximately 6 seconds when you operate the camera (such as making a change in shooting settings) even if the LCD monitor/viewfinder is set to No Information.

(Sometimes no information appears depending on the camera setting at that time.)



- A slow shutter speed has likely been selected because of insufficient lighting if the camera shake icon  appears after metering preparations are complete. Set the flash to  (On) or  (Auto), or affix the camera to a tripod to shoot.

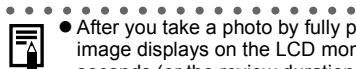

- After you take a photo by fully pressing the shutter button, the image displays on the LCD monitor for approximately two seconds (or the review duration you set from 2 to 10 seconds). If you press the **SET** button while the image is displayed, it will continue to display (p. 54).
- You can check the brightness of the image during the image review after shooting using the histogram (p. 39), a graph which allows you to judge the brightness of the recorded image and other information appearing with the image. You can adjust the exposure according to the results, then shoot again if necessary. (If no histogram appears, press the **INFO.** button.)

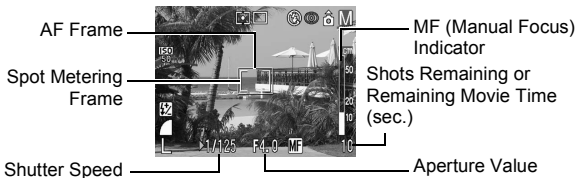

Checking the information on the LCD Monitor/Viewfinder (continued)

The following displays in information view.



-2...+2	Exposure Compensation	p. 92
	White Balance (WB)	p. 93
	Drive Mode	p. 77, 79
	ISO Speed	p. 99
	Photo Effect	p. 96
	Bracket	p. 100, 102
	Flash Exposure Compensation/Flash Output	p. 107, 108
	Compression Settings	p. 57
L M1 M2 M3 S	Resolution Settings	p. 57
RAW	File Format	p. 60
7.0x 8.8x 11x 14x 18x 22x	Digital Zoom Setting*	p. 78
	Converter (Lens) Settings	p. 180
	Low Battery	p. 22
	Flash	p. 62
	Red-eye Reduction	p. 64
	Macro Mode/Super Macro Mode	p. 73, 75
	Light Metering Mode	p. 90
	Auto Rotate	p. 119
	Shooting Mode	p. 14
ND	ND Filter	p. 118
	Camera Shake Warning	p. 35
*	AE Lock/FE Lock	p. 104, 106

MF	Manual Focus	p. 114, 115
● (Red)	Movie Recording Mode	p. 71

- * Zoom powers reflect the combined optical and digital zoom effects. These figures appear when the digital zoom is activated. ("7.0x" is the telephoto-end setting of the optical zoom.)
- The icons in the shaded boxes () above and  appear even when the information view is turned off.
 - In addition to the above, the messages, AF frame, Spot Metering Frame, shutter speed, aperture value, MF indicator (when manual focus is selected) and zoom bar (during the zoom operation) are shown as in the upper screen example.

● Playback Mode





In standard display mode, the following information appears.

Image Number and
Total
(Display Image/Total)



File Number

Shooting Date/Time

  	Compression Settings	p. 57
L M1 M2 M3 S	Resolution Settings	p. 57
RAW	File Format	p. 60
	Sound memo (wave file)	p. 131
AVI	Movie	p. 126
	Protection Status	p. 137

Checking the information on the LCD Monitor/Viewfinder (continued)

In detailed display mode, the following information also appears.



Adobe RGB	Color Space (Adobe RGB)	p. 98
ISO 50 100 200 400	ISO Speed	p. 99
	Photo Effect	p. 96
	Shooting Mode	p. 14
	Resolution Settings (Movie)	p. 57
-2...±0 ...+2	Exposure level	p. 92
-2...±0 ...+2	Flash Exposure Compensation	p. 107
	White Balance	p. 93
	Light Metering Mode	p. 90
	Macro Mode/Super Macro Mode	p. 73, 75
MF	Manual Focus	p. 114, 115

- In addition to the above, the shutter speed, aperture setting, movie length, histogram and overexposure warning appear.

The following information may also appear with some image files.

	An audio file other than a wave file, or a file with an unrecognized format, is attached.
	JPEG file with format not conforming to Design rule for Camera File System Standards (p. 188).
	File with unrecognized format.



- Please note that image information recorded by this camera may not display correctly on other cameras and image information recorded by other cameras may not display correctly on this camera.

About the Histogram

The histogram is a graph that allows you to judge the brightness of the recorded image. The greater the bias toward the left in the graph, the darker the image. The greater the bias toward to the right, the brighter the image.

If the image is dark, adjust the exposure compensation to a positive number. Similarly, adjust the exposure compensation to a negative number if the image is bright. (p. 92)

Sample
Histograms



Dark Image



Balanced Image



Bright Image

Overexposure Warning

In the following conditions, overexposed portions of the image blink.

- When an image just shot is being reviewed on the LCD monitor (Information view) or in the viewfinder.
- In the detailed display mode of the Playback mode.

Using the Zoom (Focal Length)

The zoom can be adjusted from 28 to 200 mm (equivalent to 35mm film format).

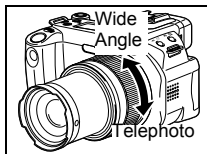

Telephoto/Wide Angle

You can zoom in (telephoto) and zoom out (wide angle) by turning the zoom ring. The zoom bar appears during the zoom operation.

- The zoom speed varies according to how fast you turn the zoom ring.

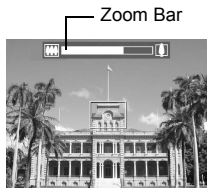

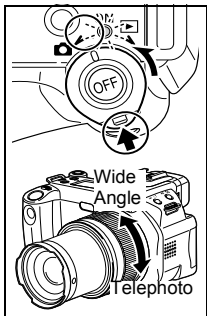

Zooming Rapidly

To zoom in or out rapidly, turn the mode lever to  (Shooting) and hold it, then turn the zoom ring in either the zoom in or zoom out direction. The swift zooming continues while you hold the mode lever.

To reverse the zooming direction, turn the zoom ring a little in the opposite direction while holding the mode lever.

Digital Zoom

An image already zoomed with the optical zoom lens can be further zoomed digitally up to an approximate factor of 22 (p. 78). The factor displays after the zoom operation.

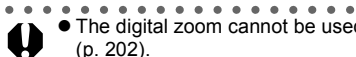

- The digital zoom cannot be used with certain Shooting modes (p. 202).

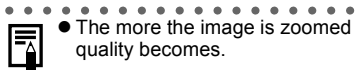

- The more the image is zoomed digitally, the coarser its image quality becomes.

Pressing the Shutter Button

The shutter button features a two-stage action.

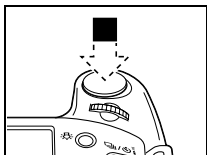

● Pressing Halfway

Pressing halfway automatically sets the exposure and focus.

- The following camera settings appear on the LCD monitor (or in the viewfinder).



AF Frame

Pressing the shutter button halfway



Shutter Speed AF Frame Aperture Value

Ready for shooting	The AF frame displays in green and the beep sounds twice.
Focusing difficulty	The AF frame displays in yellow and a beep sounds. In this case, use the focus lock, or manually focus, to shoot (p. 112).
Flash fires	The built-in flash pops up and ⚡ appears.
Camera shake warning/ underexposure	📷 appears.

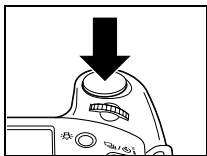



● Pressing Fully

Pressing fully releases the shutter.

- The indicator blinks while the image is recording onto the CF card.
- You will hear the shutter sound when the shot is complete. Do not move the camera until you hear this sound.

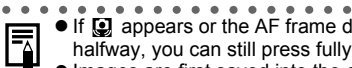
Pressing the Shutter Button (continued)



- If  appears or the AF frame displays in yellow while you press halfway, you can still press fully to take the shot.
- Images are first saved into the camera's internal memory before being recorded onto the CF card, allowing the next images to be taken immediately as long as sufficient space is available in the internal memory.
- The beep and shutter sound can be set On/Off using the menu (p. 49).
- When the shutter sound is set to On and [Mute] is set to On, no sound will be heard.
- There is no shutter sound in Movie mode.
- Shots cannot be taken while the flash is charging.

Selecting Menus and Settings

● Selecting Settings by Pressing the FUNC. Button (Only in Shooting Mode)

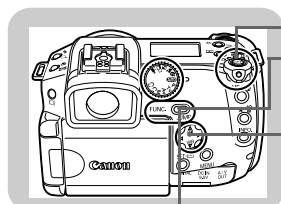

- 1 Turn the mode lever to .
- 2 Press the **FUNC.** button.
- 3 Press the **▲** or **▼** arrow on the omni selector to select a function item.
- 4 Press the **◀** or **▶** arrow on the omni selector to select setting contents.
- 5 Press the **FUNC.** button.

2 FUNC. 

3 Select a function item
using .

ISO Speed [ 50] (p. 99)



Photo Effect [ Off] (p. 96)

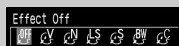

Bracket [ Off] (p. 100, 102)

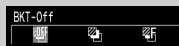

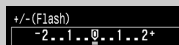

Flash Exposure
Compensation (p. 107)



or
Flash Output (p. 108)



4 Select setting contents
using .

Compression []
(p. 57)



Resolution [L]/File
Format (p. 57, 60)



or
Resolution (Movie)
[ 320] (p. 58)



The default values
are bracketed.

5 FUNC. 

In Steps 4 and 5, you can also use the main dial.

4 Turn



5 Click



● Selecting Settings by Pressing the MENU Button

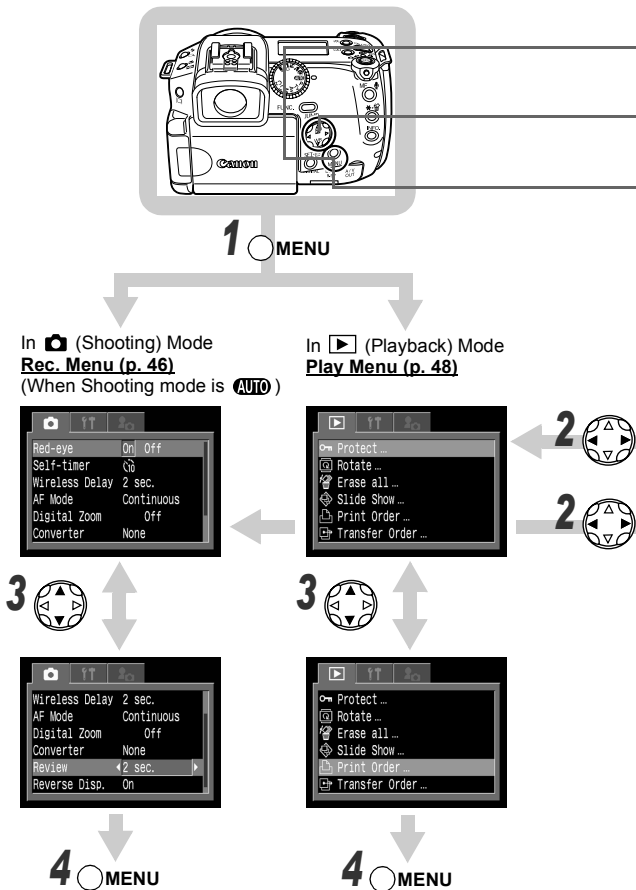

- 1 Press the **MENU** button.
- 2 Press the ◀ or ▶ arrow on the omni selector to switch between menu tabs.
- 3 Press the ▲ or ▼ arrow on the omni selector to select a menu item, then press the ◀ or ▶ arrow on the omni selector to select setting contents.
- 4 Press the **MENU** button.

- In Step 2, you can also use the **FUNC./JUMP** button, ⚡/Q button and 📶/📷 button.
- Settings cannot be selected with the main dial.
- Press the **SET** button for items followed by an ellipsis (...) and then select a setting. Press the button again to confirm the setting.
- In Shooting mode, the menu can be closed by pressing the shutter button halfway. (In Playback mode, the menu closes when the shutter button is pressed halfway and the camera switches to shooting mode.)

Set up Menu (p. 49)



My Camera Menu (p. 51, 154)



Selecting Menus and Settings (continued)





- Displayed menu items will vary according to the shooting mode and setting contents (p. 202).
- You can apply a desired image and sound to [L2] and [L3] in the My Camera menu. For details, see *Registering the My Camera Settings* (p. 156) or the *Software Starter Guide*.
- The default of all the settings changed by the menu and button operations except for [Date/Time], [Language] and [Video System] can be restored all at once (p. 52).

Menu Items Selectable with the MENU Button and Default Settings

This chart shows the options for each menu and the default settings.

● (Rec.) Menu

Menu Item	Setting Content	Reference Page
Flash Sync	Sets the timing at which the flash fires. 1st-curtain*/2nd-curtain	109
Slow Synchro	Sets whether or not the flash will fire with a slow shutter speed. On/Off*	64
Flash Adjust	Sets whether or not the flash is adjusted automatically. Auto*/Manual	107
Red-eye	Sets whether or not the red-eye reduction lamp fires when the flash fires. On*/Off	64
Flash Pop-up	Sets whether or not the flash pops up automatically. On*/Off	65
Cont. Shooting	In the Continuous Shooting mode, choose whether you view the subject as you shoot continuously (standard) or shoot with a short shutter interval without viewing (high speed).  * (standard)/  (high speed)	79

Menu Item	Setting Content	Reference Page
Self-timer	Sets the duration before the self-timer releases the shutter once the shutter button is pressed. 10 sec./2 sec.	77
Wireless Delay	Sets the duration before the self-timer releases the shutter once the remote control shutter button is pressed. 0 sec./2 sec./10 sec.	168
Spot AE Point	Sets the option of [Spot AE Point] (one of the light metering modes), Center (the AE point is fixed to the center) or AF Point (the AE point corresponds to the AF point). Center*/AF Point	90
ND Filter	Sets the ND filter. On/Off*	118
Safety Shift	Sets whether or not the Safety Shift function works. In Av (Aperture-Priority AE) and Tv (Shutter Speed-Priority AE) modes, the Safety Shift function automatically adjusts the values set manually to obtain the correct exposure if the exposure is incorrect when the shutter button is pressed halfway. On/Off*	86
MF-Point Zoom	Sets whether or not the focusing point is magnified when using the manual focus. On*/Off	114
AF Mode	Sets the frequency of autofocus activation, Continuous (continuous autofocus) or Single (autofocused only when the shutter button is pressed halfway). Continuous*/ Single	116
Digital Zoom	Sets whether or not the digital zoom combines with the optical zoom to zoom images. On/Off*	78

* Default setting

Selecting Menus and Settings (continued)

Menu Item	Setting Content	Reference Page
Converter	Adjusts the camera most appropriately when separately sold Tele-converter TC-DC58A or Close-up Lens 500D is attached to the camera. None*/TC-DC58A/500D	177
Review	Sets the duration images display on the LCD monitor (or in the viewfinder) after the shutter button is released. Off/2 sec.* to 10 sec.	54
Color Space	Sets whether still images are recorded in the standard RGB color space or Adobe RGB color space. Standard*/Adobe RGB	98
Reverse Disp.	Sets whether or not the image is reversed when the LCD monitor is tilted 180 degrees toward the lens. On*/Off	33
Super Macro	Shoots in the Super Macro mode.	75
Intervalometer	Shoots automatically at set intervals.	110
Save Settings	Saves settings selected in the Rec. menu and the Function menu to the mode dial's C1 or C2 mode.	116

* Default setting

● (Play) Menu

Menu Item	Setting Content	Reference Page
Protect	Protects images from accidental erasure.	137
Rotate	Rotates images 90 or 270 degrees clockwise in the display.	130
Erase all	Erases all images from a CF card (excluding protected images).	138
Slide Show	Plays images in an automated slide show.	133



Menu Item	Setting Content	Reference Page
Print Order	Sets the images that will be printed on a direct print compatible printer or at a photo lab service, the number of copies and other parameters.	142
Transfer Order	Specifies images before downloading to a computer.	147

● [i] (Set up) Menu

Menu Item	Setting Content	Reference Page	
Mute	<p>Set [On] to mute the start-up sound, operation sound, selftimer sound and shutter sound all at once.</p> <p>On/Off*</p> <ul style="list-style-type: none"> • If you set [Mute] to [On], no sound will be heard even when any sound item in the My Camera menu is set to [1], [2] or [3] (On). • Note that the error warning signal beeps even when the Mute setting is [On]. • The main dial does not beep even if it is pressed regardless of the setting. 	42, 127, 132, 155	
Volume	① Start-up Vol.	Adjusts the Start-up Sound volume when the camera powers up.	30, 51
	② Operation Vol.	Adjusts the Operation Sound volume of operation buttons other than the shutter button.	51
	③ Selftimer Vol.	Adjusts the sound volume of the Selftimer Sound informing you that the photo will be taken in 2 seconds.	51, 77
	④ Shutter Volume	Adjusts the Shutter Sound volume when the shutter button is pressed all the way. There is no shutter sound in Movie mode.	42, 51
	⑤ Playback Vol.	Adjusts the sound volume when a sound memo or a movie is played.	126, 127, 131, 132
	Settings of Above Items (① – ⑤)	 <p>Off 1 2* 3 4 5</p>	



* Default setting

Selecting Menus and Settings (continued)

Menu Item		Setting Content	Reference Page
LCD Brightness		Sets the brightness level of the LCD monitor.  (Normal)*/  (Bright)	—
Power Saving	Auto Power Down	Sets whether or not the camera automatically powers down after a specified period of time elapses without camera operation. On*/Off	31
	Display Off	Sets the length of time before the LCD monitor (or viewfinder) goes off when no camera operation is performed. 10 sec./20 sec./30 sec./1 min.*/2 min./3 min.	31
Date/Time		Sets the date, time and date format.	26
Format		Formats (initializes) a CF card.	139
File No. Reset		Sets how file numbers are assigned to images when new CF cards are inserted. On*/Off*	120
Auto Rotate		Sets whether or not images shot with the camera on end are automatically rotated in the display. On*/Off	119
Distance Units		Sets the format of the displayed distance units of the MF indicator. m/cm* or ft/in	114, 115
Language		Sets the language used in the menus and messages on the LCD monitor (or in the viewfinder). English*/Deutsch/Français/Nederlands/Dansk/Suomi/Italiano/Norsk/Svenska/Español/Chinese/Japanese You can change the language during image playback by holding the SET button and pressing the JUMP button.	28
Video System		Sets the video output signal standard. NTSC/PAL	153





* Default setting

● (My Camera) Menu

You can select the theme, start-up image and sound, shutter sound, operation sound and selftimer sound used on this camera. These are called My Camera settings. You can also customize the  and  options for each item with images from the CF card and newly recorded sounds or by using the supplied software.

See the *Software Starter Guide* for details.

- If you wish to apply a common theme to all My Camera menu items, choose [Theme] and set the desired content, otherwise, set each item one by one.

Menu Item	Setting Content	Reference Page
Theme	Selects a common theme for each My Camera settings item.* ¹	154
Start-up Image	Sets the start-up image when you turn on the camera.	154
Start-up Sound	Sets the start-up sound when you turn on the camera.* ¹	154
Operation Sound	Sets the sound when the omni selector or any button other than the shutter button is operated.* ¹	154
Selftimer Sound	Sets the sound informing you that the photo will be taken in 2 seconds.* ¹	154
Shutter Sound	Sets the shutter sound when you depress the shutter button. There is no shutter sound while a movie is being shot.* ¹	154
Settings of Above Items	 (Off) /  * /  / 	

* Default setting

*¹ See also [Mute] in the Set up Menu (p. 49).

Resetting the Settings to Default

You can reset the menu and button operation settings to default.

1 Turn on the camera.

- You can turn on the camera in either Shooting or Playback mode.

2 Press the MENU button for longer than 5 seconds.

- The message “Reset settings to default?” appears on the LCD monitor.

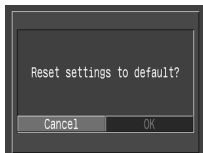

3 Select [OK] using the ◀ or ▶ arrow on the omni selector, then press the SET button.

- The screen on the right appears while resetting. The normal screen resumes when resetting is complete.
- To cancel resetting, select [Cancel] instead of [OK].

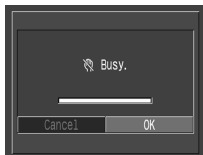

- The following settings cannot be reset to default:
 - The [Date/Time], [Language] and [Video System] options in the  menu (p. 50)
 - White balance data set with the custom white balance function (p. 94)
 - Newly registered My Camera settings (p. 156)
- When the camera is in Shooting mode and the mode dial is set to **C1/C2**, only the **C1/C2** mode settings will revert to default.
- Settings cannot be reset when the camera is connected to a computer or printer.

Shooting – Letting the Camera Select Settings

See *Functions Available in Each Shooting Mode* (p. 202) at the end of this manual to find out which settings can be changed in which shooting modes.

AUTO Auto Mode

In this mode, all you have to do is press the shutter button and let the camera do everything else.

1 Check that the camera is in Shooting mode (p. 29).

2 Turn the mode dial to **AUTO**.



3 Aim the camera at the subject.

4 Use the zoom ring to achieve the desired composition (relative subject size on the LCD monitor (or in the viewfinder)).

5 Press the shutter button halfway (p. 41).

- The camera focuses on the subject. Two beeps will sound when the camera has finished metering.
- The AF frame will appear green on the LCD monitor (or in the viewfinder).
- The shutter speed and aperture value are automatically determined and show on the display panel and the LCD monitor (or in the viewfinder).
- The beep will sound one time and the AF frame will appear yellow if the subject is difficult to focus on.

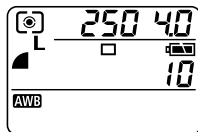

AF Frame

6 Press the shutter button all the way (p. 41).

- You will hear the sound of the shutter when the shutter activates.
- The picture appears for two seconds on the LCD monitor (or in the viewfinder).

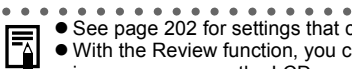

- See page 202 for settings that can be changed in this mode.
- With the Review function, you can change the length of time images appear on the LCD monitor (or in the viewfinder) after shooting, or set it so they do not appear at all. (p. 56)

Reviewing an Image Right after Shooting

Mode Dial

AUTO **P** **Tv** **Av** **M**

Reviewing the Image

After a photo is taken, the image appears on the LCD monitor (or in the viewfinder) for two seconds. In addition, the image will keep on displaying regardless of the review duration setting if one of the following operations is performed.

● Keeping the shutter button pressed

The image continues to appear on the LCD monitor as long as you keep the shutter button fully depressed.

If you turn the zoom ring toward telephoto at this time, the image will be magnified and continue to display even after the shutter button is released. The magnified image will be reduced to the normal size by turning the zoom ring in the opposite direction. To let the camera return to Shooting mode, press the shutter button halfway.

● Pressing the SET button while the image is displayed

The image will continue to display even after the shutter button is released. You can magnify the image (and reduce it to the normal size after that) by using the zoom ring. To let the camera return to Shooting mode, press the shutter button halfway.

● Switching between the LCD Monitor and Viewfinder While the Image is Displayed

You can switch between the LCD monitor and viewfinder by pressing the  button. Using this feature, you can shoot an image using the viewfinder and automatically let the camera display the image on the LCD monitor (or vice versa).

1 Shoot an image using the viewfinder.

2 Pause the image by pressing the SET button.

The shot image continues to appear in the viewfinder.

3 Press the button.

The display will switch to the LCD monitor and you can review the image.

From the next shooting session and onward, review images will automatically appear on the LCD monitor.

- If you press the  button to change the monitor while shooting, this setting will be canceled.



- You can perform the following while images are displayed.
 - Erasing images individually (p. 138)
 - Displaying images in Detailed Display mode (p. 34)
 - Changing the recording format (p. 60)
 - Attaching sound memos (p. 131)

Changing the Recording Format Right after Shooting

Mode Dial

P Tv Av M

By following the instructions below, you can save images shot in the JPEG format in the RAW format (p. 60) right after shooting.* You can easily process images saved in the RAW format using a computer to edit the resolution, photo effect and white balance without any loss of quality.

* The JPEG format image will not be saved.

Changing the Resolution and Compression



Mode Dial

AUTO     **P** **Tv** **Av** **M**

You can change the resolution and compression (excluding movies) settings to suit the purpose of the image you are about to shoot. To record the CCD output without compression, select the RAW file format (p. 60).

Resolution		Purpose
L (L) Large	3264 x 2448 pixels	<ul style="list-style-type: none"> • Print A4 size* 210 x 297 mm (8.3 x 11.7 in.) or larger prints • Print letter size* 216 x 279 mm (8.5 x 11 in.) or larger prints
M1 (M) Medium 1	2272 x 1704 pixels	
M2 (M) Medium 2	1600 x 1200 pixels	<ul style="list-style-type: none"> • Print postcard size 148 x 100 mm (6 x 4 in.) prints • Print L size 119 x 89 mm (4.7 x 3.5 in.) prints
M3 (M) Medium 3	1024 x 768 pixels	<ul style="list-style-type: none"> • Print card size 86 x 54 mm (3.4 x 2.1 in.) prints
S (S) Small	640 x 480 pixels	<ul style="list-style-type: none"> • Send images as e-mail attachments • Shoot more images

* Paper sizes vary according to region.
(The icons in the parentheses appear on the display panel.)

Compression			
Display Panel/LCD Monitor/ Viewfinder Display	Indication	Quality	Purpose
	Superfine	High	Shoot higher quality images
	Fine		Shoot normal quality images
	Normal	Normal	Shoot more images

- Movies can be shot with the following resolution.

Resolution	
640	640 x 480 pixels
320	320 x 240 pixels
160	160 x 120 pixels

1 Press the FUNC. button.

2 Select **▲*** (Compression) or **L*** (Resolution) using the **▲** or **▼** arrow on the omni selector.

* The current setting is displayed.



3 Select the compression or resolution you wish to set using the main dial or the **◀** or **▶** arrow on the omni selector.

- You can shoot the image right after selecting settings by pressing the shutter button. This screen will appear again, once the image is shot.

Resolution (Excluding **▶**)



Compression



Number of shots remaining (Only displayed when the resolution, compression or file format is selected)

4 Press the FUNC. button or click the main dial.

5 Shoot the image.



- See *Image File Sizes (Estimated)* (p. 192).
- See *CF Cards and Estimated Capacities (Recordable Images)* (p. 191).
- The resolution and compression settings are affected by the shooting mode selection as follows (only the resolution in **P** mode).

e.g. 1: When the shooting mode is changed from **AUTO** to **M**, the resolution and compression will restore the values set in **M** mode.

e.g. 2: When the shooting mode is changed from **P** to **Tv**, the resolution and compression retain the same values set in **P** mode.

Initial Shooting Mode	Next Shooting Mode	Resolution and Compression after Change
AUTO C1 C2	AUTO P Tv Av M C1 C2	Settings change to those of the next mode.
	 AUTO P Tv Av M C1 C2	Settings do not change.
P Tv Av M	P Tv Av M AUTO C1 C2	Settings do not change.
	AUTO C1 C2	Settings change to those of the next mode.

Changing the File Format

Mode Dial

P Tv Av M

The recording file format can be switched to the RAW format before shooting the image.

With the standard JPEG file format, the camera processes images after capturing them to produce optimal results. The JPEG format compresses images so that more can be stored on a single CF card. However, the compression is irreversible, meaning that the original image data cannot be recovered after processing.

In contrast, the RAW format records the image data as captured by the camera's CCD without further processing. RAW images are compressed, but the compression is reversible* so that a high-quality image can be obtained from the decompressed file without any loss of image quality. In addition, although a RAW file is larger than an equivalent JPEG file, it is still only approximately one-quarter the size* of an uncompressed RGB TIFF format file, making it relatively compact.

With standard uncompressed file formats, such as RGB TIFF, images are processed in the camera and require further processing by retouching software to adjust the image parameters, which reduces image quality. With the RAW format, however, the original data can be used in special software** to adjust the image parameters (white balance, contrast, sharpness and saturation) making it possible to maintain the image quality while making changes. The resolution (3264 x 2448) and compression settings cannot be adjusted for these images.

* As measured by Canon's testing standard.

** **The bundled software can be used to open or adjust the parameters of images recorded in the RAW file format. Please consult the *Software Starter Guide* for details.**

1 Press the **FUNC.** button.

2 Select **L*** (LCD monitor/Viewfinder) OR **L*** (Display Panel) using the **▲** or **▼** arrow on the omni selector.

* The current setting is displayed.



3 Select **RAW** (LCD monitor/Viewfinder) OR **r** (Display Panel) using the main dial or the **◀** or **▶** arrow on the omni selector.

- You can shoot the image right after selecting settings by pressing the shutter button. The previous screen will appear again, once the image is shot.

4 Press the **FUNC.** button or click the main dial.

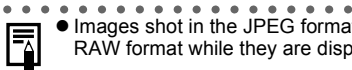

- Images shot in the JPEG format can also be changed to the RAW format while they are displayed right after shooting (p. 55).

⚡ Using the Built-In Flash

Mode Dial

AUTO **P** **Tv** **Av** **M**

Use the flash according to the guidelines below. (In Movie mode, the flash cannot be used.)

	Auto with red-eye reduction	The flash fires automatically as required by the lighting level, and the red-eye reduction lamp fires each time the main flash fires.
	Auto	The flash fires automatically as required by the lighting level.
	Flash on with red-eye reduction	The red-eye reduction lamp and the flash always fire.
	Flash on	The flash always fires.
	Flash off	The flash does not fire.

* No icon appears on the display panel.

• For information on the external flash, see page 171.

1 Press the ⚡ button to switch between flash modes.

- The selected flash mode appears on the display panel and the LCD monitor (or in the viewfinder).
- You can switch between settings by pressing the ⚡ button.

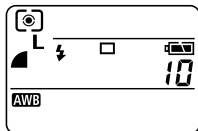

When the red-eye reduction function is on (p. 64)

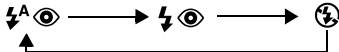

When the red-eye reduction function is off (p. 64)

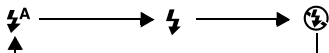

Some settings are not available with certain shooting modes (p. 202).

2 Shoot the image.

- The flash will fire if the built-in flash pops up automatically (Flash Pop-up function) and  appears on the LCD monitor (or in the viewfinder) when the shutter button is pressed halfway.
- Shooting procedures are the same as for the **AUTO** mode (p. 53).



- The flash fires with automatic adjustments when [Flash Adjust] is set to [Auto] in the Rec. menu. When shooting in **M** mode, or with [Flash Adjust] set to [Manual], the flash fires with the manually set adjustments.
- You can turn off the Flash Pop-up function and manually open the built-in flash only when you need it (p. 65).
- Be sure to close the built-in flash after use.
- The flash fires twice. A pre-flash will fire and will be followed by the main flash. The pre-flash is used by the camera to obtain the subject's exposure data so that the main flash can be set to the optimal intensity for the shot.
- The fastest shutter speed for flash synchronization is 1/250 second. The camera automatically resets the shutter speed to 1/250 second if a faster speed is selected.
- The built-in flash may take up to approximately 10 seconds to charge in some cases. Actual times will vary according to usage and the battery charge.
- Shots cannot be taken while the flash is charging.
- The flash exposure and the flash output can be changed (p. 107).
- The flash setting is saved when the camera is turned off in the **P**, **Tv**, **Av** and **M** shooting modes.

Setting the Red-eye Reduction Function

Mode Dial

 AUTO    P Tv Av M

The red-eye reduction lamp fires when the flash is used in dark areas. This reduces light reflecting back from the eyes and making them appear red.

1 In the [(Rec.)] menu, set [Red-eye] to [On].

-  appears on the LCD monitor (or in the viewfinder).



- When shooting with the red-eye reduction function, the subjects must look right at the red-eye reduction lamp for this mode to be effective. Try asking them to look directly at the lamp. Even better results can be obtained by shooting with the lens set to a wide angle, increasing the lighting in indoor settings or approaching closer to the subject.

Setting the Slow Synchro

Mode Dial

  Av

You can shoot images using the slow synchro function when the camera flashes. This helps brighten up dark backgrounds when shooting night scenes or with indoor lighting conditions.

1 In the [(Rec.)] menu, set [Slow Synchro] to [On].



- When shooting with a high ISO sensitivity while using the built-in flash, there is more of a chance of overexposure the closer you are to the subject.





- When shooting with [Slow Synchro] set to [On], we recommend the use of a tripod to prevent camera shake.



Using the Built-In Flash with the Flash Pop-up Function Off

Mode Dial

P Tv Av M

1 In the [ (Rec.)] menu, set [Flash Pop-up] to [Off].

2 When you wish to fire the flash, pop up the built-in flash by pressing the  button.

-  appears on the display panel and LCD monitor (or in the viewfinder) and the flash fires when the shutter button is pressed fully.
- When you do not want the flash to fire, press the built-in flash down until it clicks.  appears on the display panel and the LCD monitor (or in the viewfinder).

Portrait Mode

Use this mode when you want the subject to appear sharp and the background to blur.

1



Turn the mode dial to .

Shooting procedures are the same as for the **AUTO** mode (p. 53).



- See page 202 for settings that can be changed in this mode.
- To best achieve the effect of the background gradually fading, compose the image so that the upper half of the subject's body fills most of the viewfinder or LCD monitor.
- The background gets increasingly indistinct the more you adjust the focal length toward telephoto.

Landscape Mode

Use this mode to shoot expansive landscape scenes.



1



Turn the mode dial to .

Shooting procedures are the same as for the **AUTO** mode (p. 53).



- See page 202 for settings that can be changed in this mode.
- Since a slow shutter speed is often selected in  mode, use a tripod to shoot if the  (camera shake warning) icon appears on the LCD monitor (or in the viewfinder).

Night Scene Mode

Use this mode to capture human subjects against the backdrop of an evening sky or night scene. The people are illuminated with light from the flash while the backdrop is captured at a slow shutter speed so that both appear correctly exposed.

1





Turn the mode dial to .

Shooting procedures are the same as for the **AUTO** mode (p. 53).



- Always use a tripod to prevent camera shake in this mode.



- See page 202 for settings that can be changed in this mode.
- Warn people to stay still for a few seconds after the flash fires because of the slow shutter speed.
- Using the  mode in daylight will produce an effect similar to that of the **AUTO** mode.
- With the  mode, the slow synchro function automatically turns on (p. 64).



- Compose each frame so that it overlaps 30 to 50% of the adjoining image.
Try to keep the vertical misalignment to within 10% of the image height.
- Do not include moving items in the overlap.
- Do not try to stitch images that include both distant and close subjects. Objects may appear warped or doubled up.
- Make the brightness in each image consistent. The final image will appear unnatural if the difference in brightness is too great.
- For good results, pan (swivel) the camera to take successive shots.
- To shoot close-ups, slide the camera over the subject, keeping it parallel as you move.

Shooting

Images can be shot in the following 5 sequences in Stitch Assist mode.

	Horizontally, left to right
	Horizontally, right to left
	Vertically, bottom to top
	Vertically, top to bottom
	Clockwise starting at the top left

1



Turn the mode dial to .

2

Select the shooting sequence using the ◀ or ▶ arrow on the omni selector and press the SET button.

- The shooting sequence is set.
- You can also press the shutter button directly to shoot without pressing the SET button.



3 Shoot the first image.

- The exposure and white balance settings are set and locked with the first image.

4 Compose and shoot the second image so that it overlaps the first.

- Minor discrepancies in the overlap can be corrected with the software.
- An image can be retaken. Press the ◀ or ▶ arrow on the omni selector to return to that frame.



Sequence 📷



Sequence 📷

5 Use the same procedures to shoot the remaining frames.

- A maximum of 26 images can be recorded either horizontally or vertically.

6 Press the SET button after the last shot.

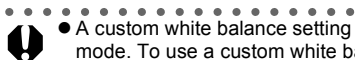

- A custom white balance setting (p. 94) cannot be set in 📷 mode. To use a custom white balance setting, first set it in another shooting mode.
- The settings in place for the first image are locked in and cannot be changed for subsequent shots.
- A TV cannot be used as the monitor for shooting in this mode.



- See page 202 for settings that can be changed in this mode.

Movie Mode

Use this mode to shoot movies. The resolution can be selected from the following settings (p. 57):

- [640] (640 x 480)
- [320] (320 x 240)
- [160] (160 x 120)

1



Turn the mode dial to .

The LCD monitor (or viewfinder) displays the maximum recording time (in seconds).

2 **Press the shutter button all the way.**

- Shooting and sound recording starts simultaneously.
- During shooting a red circle appears in the upper right of the LCD monitor (or viewfinder).

3 **Press the shutter button all the way to stop recording the movie.**

- The maximum length of individual movie clips (15 frames/second) is about 30 seconds* at the [640] setting and 3 minutes at the [320] and [160] settings. (The data reflects Canon's testing standard. The actual figures will vary according to the shooting subjects and conditions.) The clip will end automatically after this time elapses or when the CF card becomes full.

* Using the following CF cards:

- Supplied FC-64MH CF Card
- Separately sold Canon FC-256MH or FC-512MSH CF Card (not sold in some regions)

Macro Mode

Mode Dial



AUTO     Tv Av M

Use the macro mode to shoot close-ups of subjects when the distance from the tip of the lens to the subject is in the following range (varies according to the zoom position):

Zoom Position (35mm film equivalent)	Distance to the subject
Wide angle end – 63 mm	10 – 50 cm (3.9 in. – 1.6 ft.)
63 – 90 mm	30 – 50 cm (1.0 – 1.6 ft.)
90 mm – telephoto end	Macro shooting not available

* The zoom position appears in 35mm film equivalent values.

1 Press the button.

-  appears on the display panel and the LCD monitor (or in the viewfinder).
- Press the  button again to cancel the macro mode.



2 Shoot the image.

- Shooting procedures are the same as for the **AUTO** mode (p. 53).
- When you turn the zoom ring, the zoom bar accompanied by the yellow bar under it appears. The yellow bar shows the zoom range in which you cannot shoot the subject in Macro mode. If the zoom bar enters the yellow bar range, the macro mode icon  will appear in gray after the zoom bar disappears. You can still shoot the image, however, the macro mode is canceled.

Zoom bar Yellow bar



Approx. 2 seconds later



Appears in gray





- In macro mode, the correct image brightness sometimes cannot be obtained with flash photography. Please set the ND filter to [On] and use the separately sold Macro Ring Lite MR-14EX or the Macro Twin Lite MT-24EX for flash photography in the macro mode. Use the **Av** or **M** mode and set the aperture to a higher value as required by the shooting conditions.



- Recordable areas at the minimum shooting range are as follows:

Zoom Position (35mm film equivalent)	Recordable Area
Wide angle end	Approximately 157 x 115 mm (6.2 x 4.5 in.)
63 mm	Approximately 87 x 65 mm (3.4 x 2.6 in.)
90 mm	Approximately 150 x 112 mm (5.9 x 4.4 in.)

- Use Super Macro mode to get even closer to the subject (p. 75).

☞ Super Macro Mode

Mode Dial

P Tv Av M

Compared with normal Macro mode, you can get even closer to the subject and focus on the subject closer to the lens. The background can also be shot with different effects.

You can shoot subjects in Super Macro mode when the distance from the tip of the lens to the subject is in the following range: 3 to 30 cm (1.2 in. to 1.0 ft.) (42 to 90 mm (35mm film equivalent)).

The resolution can only be set to **M1**, **M2**, **M3** or **S**. If the resolution is set to **L** or **RAW** when you set the camera to Super Macro mode, the resolution will automatically be changed to **M1**. (The resolution will return to the previous setting when you cancel Super Macro mode.)

1 In the [] (Rec.) menu, select [Super Macro].

- See *Selecting Menus and Settings* (p. 44).



2 Press the SET button.

- ☞ appears on the LCD monitor (or in the viewfinder) and the camera enters Super Macro mode.
- Super Macro is canceled when you do any of following operations:
 - Press the **MENU** button (If you press the button again, the menu will disappear.)
 - Select another shooting mode
 - Set the camera to Playback mode
 - Turn the power off
- The zoom position moves within the recordable area.



3 Shoot the image.

- Shooting procedures are the same as for the **AUTO** mode (p. 53).
- During Super Macro mode, only the optical zoom operates even when the digital zoom is set to On.
- The zoom bar appearing during zoom operation indicates the following movable zoom range in Super Macro mode: 42 to 90 mm (35mm film equivalent). The MF indicator appearing in manual focus mode also shows the movable range of the zoom.



- Be careful not to bang the lens against the subject when shooting in Super Macro mode.
- Super Macro mode does not work properly when any separately sold lens is attached to the camera. [Super Macro] cannot be selected when [Converter] in the Rec. menu is set to anything other than [None].



- Recordable areas at the minimum shooting range are as follows:





Zoom Position (35mm film equivalent)	Recordable Area
42 mm	Approximately 44 x 33 mm (1.7 x 1.3 in.)
90 mm	Approximately 35 x 26 mm (1.4 x 1.0 in.)

- You can select [Super Macro] in **C1** and **C2** (Custom) modes. However, Super Macro mode cannot be memorized in those Custom modes.

☺ Self-Timer

You can take pictures with the self-timer in any shooting mode.

1 Press the button.

- Press the  button until  appears on the display panel and  or  appears on the LCD monitor (or in the viewfinder).
- You can cancel the self-timer by pressing the  button again.



2 Shoot the image.

- When the self-timer is set to 10 seconds, the self-timer sounds and the self-timer lamp starts blinking when the shutter button is pressed all the way. The blinking gets faster two seconds before the shutter activates.
- When the self-timer is set to 2 seconds, the self-timer lamp blinks fast from the beginning. The shutter activates in two seconds.
- Shooting procedures are the same as for the **AUTO** mode (p. 53).



- You can change the self-timer sound by changing the setting in [Selftimer Sound] in the [ (My Camera)] menu (p. 51).

Setting the Number of Seconds until Shooting

You can set the number of seconds from the time the shutter button is pressed to the time the image is shot to 10 seconds or 2 seconds.

1 Select [Self-timer] from the [(Rec.)] menu.

- See *Selecting Menus and Settings* (p. 44).

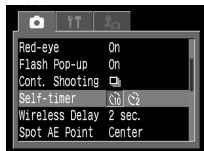

2 Select [] (10 seconds) or [] (2 seconds) and press the MENU button.

Digital Zoom

Mode Dial

AUTO **M**

With the combined optical and digital zoom functions, images can be zoomed as follows:

8.8x, 11x, 14x, 18x and 22x.

1 In the [(Rec.)] menu, select [Digital Zoom].

- See *Selecting Menus and Settings* (p. 44).

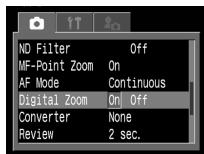

2 Select [On] and press the MENU button.

3 Turn the zoom ring toward telephoto.

- The lens will zoom to the maximum optical telephoto setting and stop. To further zoom the image digitally, turn the zoom ring in the same direction.
- To zoom back out, turn the zoom ring in the opposite direction.

Optical zoom range (white)

Digital zoom range (blue)

Combined magnifications of the optical zoom and digital zoom



Approx. 2 seconds later



4 Shoot the image.

- Shooting procedures are the same as for the **AUTO** mode (p. 53).



- The digital zoom cannot be used with the RAW file format or in Super Macro mode.

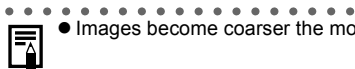



- Images become coarser the more they are digitally zoomed.

Continuous Shooting





Mode Dial

   **P Tv Av M**

Use this mode to shoot successive frames while the shutter button is fully pressed.

	Standard Continuous Shooting	Use this mode to view the subject as you shoot continuously. The shutter interval is longer in this mode than in  mode.
	High Speed Continuous Shooting	Use this mode to shoot continuously with a short shutter interval. You cannot check the subject while shooting continuously.

1 Press the button.

- Press the  button until  or  appears on the display panel and the LCD monitor (or in the viewfinder).
- You can cancel the continuous mode by pressing the  button until  appears.



2 Press the shutter button halfway to lock the focus.

3 Press the shutter button all the way to shoot.

- Shooting will stop when the shutter button is released.
- The shooting speed is as follows.

When [] is selected: Approx. 1.0 frames per second*

When [] is selected: Approx. 2.5 frames per second*

- * Large/Fine (These figures reflect Canon's testing standard. The actual figures will vary according to the shooting conditions and settings.)





- The interval between frames lengthens somewhat when the internal memory becomes full.
- The built-in flash can be used, but the interval between images will lengthen to accommodate the flash recharge time.
- The flash will not fire with an externally mounted flash.

Selecting a Continuous Shooting Mode

1 In the [] (Rec.) menu, select [**Cont. Shooting**].

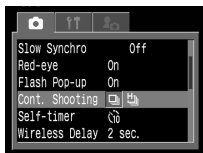
- See *Selecting Menus and Settings* (p. 44).



2 Select [] or [] and press the MENU button.



- Turning the camera off restores the standard shooting mode. However, the selected continuous shooting option will remain effective the next time continuous shooting is activated.

Shooting – Selecting Particular Effects

Camera settings such as shutter speed and aperture value can be freely changed for shooting.

See *Functions Available in Each Shooting Mode* (p. 202) at the end of this manual to find out which settings can be changed in which shooting modes.



- Please see **AUTO** *Auto Mode* (p. 53) for shooting procedures once you have changed a setting.

P Program AE

Use the program AE mode to have the camera automatically set the shutter speed and aperture value to match the brightness of the scene.

1



Turn the mode dial to P.

2

Shoot the image.

- The shutter speed and aperture value will be set automatically and shown on the display panel and LCD monitor (or in the viewfinder).
- The correct exposure has been set if the shutter speed and aperture value appear in white on the LCD monitor (or in the viewfinder).
- You can change the automatically selected combinations of shutter speeds and aperture values without altering the exposure (p. 105).



P Program AE (continued)



- See page 202 for settings that can be changed in this mode.
- If a correct exposure cannot be obtained, the shutter speed and aperture value show in red on the LCD monitor (or in the viewfinder). Use the following methods to obtain the correct exposure and make them show in white.
 - Use the flash.
 - Change the ISO speed setting.
 - Change the light metering mode.

Differences between the P and **AUTO** Modes

- The following settings can be adjusted in **P** mode, but not in **AUTO** mode.
 - Exposure Compensation
 - ISO Speed
 - Flash Exposure Compensation
 - AE Lock
 - Built-In Flash (Flash on, Slow Synchro, 2nd-curtain flash)
 - Continuous Shooting
 - Manual Focus
 - Bracket Mode
 - FE Lock
 - White Balance
 - Photo Effect
 - ND Filter
 - Light Metering Mode
 - Intervalometer
 - AF frame

Tv Setting the Shutter Speed

When you set the shutter speed in the shutter speed-priority AE mode, the camera automatically selects an aperture value to match the brightness. Faster shutter speeds allow you to catch an instantaneous image of a moving subject while slower speeds create a flowing effect and allow you to shoot without a flash in dark areas.

1



Turn the mode dial to Tv.

- The shutter speed will show on the display panel and LCD monitor (or in the viewfinder).

Tv Setting the Shutter Speed (continued)



- See page 202 for settings that can be changed in this mode.
- Please note that camera shake becomes a factor at slow shutter speeds. If the camera shake warning  appears on the LCD monitor (or in the viewfinder), secure the camera to a tripod before shooting.
- The fastest shutter speed for flash synchronization is 1/250 second. The camera automatically resets the shutter speed to 1/250 second if a faster speed is selected.
- The aperture value and shutter speed change according to the zoom state as follows.

	Aperture Value	Shutter Speed (seconds)
Wide Angle	F2.4 – 2.8	to 1/1600
	F3.2 – 5.0	to 1/2000
	F5.6 – 8.0	to 1/4000
Telephoto	F3.5 – 4.0	to 1/1600
	F4.5 – 7.1	to 1/2000
	F8.0	to 1/4000

Shutter Speed Display

The shutter speeds from 4000 to 4 in the display panel are actually the denominator of a fraction of a second. For example, 160 indicates a speed of 1/160 second. For slower speeds, quote marks indicate the decimal place, so that 0"3 indicates 0.3 second and 2" indicates 2 seconds.

15" 13" 10" 8" 6" 5" 4" 3"2 2"5 2" 1"6 1"3 1" 0"8 0"6
 0"5 0"4 0"3
 4 5 6 8 10 13 15 20 25 30 40 50 60 80 100 125 160
 200 250 320 400 500 640 800 1000 1250 1600 2000
 2500 3200 4000

The display of shutter speeds from 1/4 to 1/4000 second differs between the display panel and LCD monitor/viewfinder.

Shutter Speed	15 sec. ... 0.8 sec. ... 1/4 sec. ... 1/4000 sec.
Display Panel	15" ... 0"8 ... 4 ... 4000
LCD Monitor/ Viewfinder	15" ... 0"8 ... 1/4 ... 1/4000

Av Setting the Aperture (continued)



- Depending on the zoom position, certain aperture values may not be available.



- See page 202 for settings that can be changed in this mode.
- Please note that camera shake becomes a factor at slow shutter speeds. If the camera shake warning  appears on the LCD monitor (or in the viewfinder), secure the camera to a tripod before shooting.
- In this mode, the shutter speed with synchronized flash is 1/60 second to 1/250 second. The aperture value setting may therefore be changed automatically to match the synchronized flash speed even if its value was set previously.

Aperture Setting Display

The larger the aperture value, the smaller the lens aperture.

F2.4	F2.8	F3.2	F3.5	F4.0	F4.5
F5.0	F5.6	F6.3	F7.1	F8.0	

The display of aperture settings differs between the display panel and LCD monitor/viewfinder.

Aperture Value	F2.4	...	F8.0
Display Panel	2.4	...	8.0
LCD Monitor/Viewfinder	F2.4	...	F8.0

Safety Shift

If you set [Safety Shift] to [On] in the Rec. menu when the shooting mode is **Tv** or **Av**, the camera automatically changes the shutter speed or aperture value to obtain the correct exposure if necessary.

- The safety shift function does not work when the flash fires.

M Manually Setting the Shutter Speed and Aperture

You can manually set the shutter speed and aperture to achieve a particular effect. This is convenient for shooting fireworks and other images where it is difficult to set the correct exposure automatically.

1



Turn the mode dial to M.

- The shutter speed and aperture value will show on the display panel and LCD monitor (or in the viewfinder).

2

Click the main dial and select a setting content (shutter speed or aperture value).

- Clicking the main dial switches between the shutter speed and the aperture value setting.

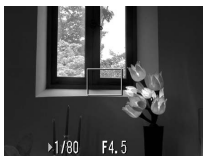

3

Turn the main dial and select a shutter speed or an aperture value.

- If you adjust the zoom after you set the shutter speed/aperture value, the aperture value is sometimes changed according to the zoom position.

4

Shoot the image.

- When you press the shutter button halfway, the exposure compensation bar appears on the display panel and a number on the LCD monitor (or in the viewfinder) indicates the difference between standard exposure* and the selected exposure. If the difference is more than 2 stops, the LCD monitor (or viewfinder) shows a red “-2” or “+2”.



* The standard exposure is calculated by the AE function according to the selected metering method.

Displays in red



M Manually Setting the Shutter Speed and Aperture (continued)



- See page 202 for settings that can be changed in this mode.
- For the correlation between aperture value and shutter speed, see page 84.
- If you wish to change the exposure, adjust the shutter speed or the aperture using the main dial.
- The brightness of the LCD monitor (or viewfinder) matches the selected shutter speed and aperture value. If you select a fast shutter speed or shoot a subject in a dark place, set the flash to  (Flash on with red-eye reduction) or  (Flash on), or affix an external flash to the camera and then the LCD monitor will always brighten.

Selecting an AF Frame

Mode Dial

P Tv Av M

The AF frame indicates the area of the composition on which the camera focuses and can be set manually to the desired area. This is convenient for focusing accurately on an off-center subject to obtain the composition you desire.

However, the AF frame is fixed to center-point when the digital zoom is used, even if you previously set the AF frame to the position you desire.

1 Press the button.

- The AF frame appears in green on the LCD monitor (or in the viewfinder).

2 Move the AF frame to the desired area using the ▲, ▼, ◀ or ▶ arrow on the omni selector.



3 Press the button.

- You can immediately shoot the image using the selected AF frame by pressing the shutter button instead of pressing the  button.





- The AF frame will move back to its original position (Center) if you hold down the  button.
- The AF frame can also be moved in the macro mode.
- The AF frame can be set in both the macro mode and the standard mode.
- The AF frame cannot be moved in the super macro mode and while the manual focus is being used (p. 114).
- When the Spot AE Point is selected as the light metering mode, you can use the selected AF frame as the Spot AE Point (p. 90).
- For an explanation of the AF frame colors, please refer to page 41.
- Auto focusing may become slower after the AF frame is moved.

Switching between Light Metering Modes

Mode Dial

P Tv Av M

Evaluative Metering is the default light metering mode. This can be switched to another metering mode.

	Evaluative Metering		Appropriate for standard shooting conditions, including backlit scenes. The camera divides images into several zones for light metering. The camera evaluates the complex lighting conditions, such as the position of the subject, the brightness, the background, the direct light, and the backlighting, and adjusts the settings to the correct exposure for the main subject.
	Center-Weighted Averaging		Averages the exposure from the entire image, but places more weight on the subject at the center.
	Spot AE Point	Center	Meters the area within the spot AE point frame at the center of the LCD monitor (or viewfinder). Use this mode when the subject is backlit or surrounded by bright light.
		AF Point	Meters the spot AF point corresponding to the AF frame.

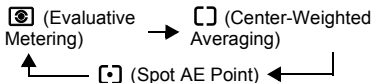

1 Press the button to select the metering mode.

- Each press of the  button changes the metering mode as follows.



- The icon of the currently selected light metering mode appears on the display panel and LCD monitor (or in the viewfinder).

If you have selected  (Spot AE Point), go to step 2.

If you have selected  (Evaluative Metering) or  (Center-Weighted Averaging), shoot the image.



2 In the [(Rec.)] menu, select [Spot AE Point].

- See *Selecting Menus and Settings* (p. 44).

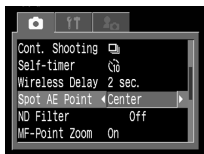

3 Select the [Center] or [AF Point] option, then press the MENU button.

- When [Spot AE Point] is set to [Center], the spot AE point frame appears at the center of the LCD monitor (or viewfinder). When [Spot AE Point] is set to [AF Point], it appears inside the AF frame.



e.g. Center

Spot AE Point Frame

Adjusting the Exposure

Mode Dial



Adjust the exposure compensation setting to avoid making the subject too dark when it is backlit or shot against a bright background.

1 Press (▲ on the omni selector).

- The exposure compensation bar appears on the display panel and LCD monitor (or in the viewfinder).

2 Select a setting using the main dial or the ◀ or ▶ arrow on the omni selector.

- The settings can be adjusted in 1/3 stops in the range of -2EV to +2EV.
- You can shoot the image right after selecting settings by pressing the shutter button. The menu displays again after the shot, allowing you to change the settings easily.



3 Press or click the main dial.









- To cancel the exposure compensation, return the setting to 0.

WB Adjusting the Tone (White Balance)

Mode Dial

 P Tv Av M

When the white balance mode is set to match the light source, the camera reproduces colors more accurately.

AWB (AWB)	Auto	Settings are automatically set by the camera
	Daylight	For recording outdoors on a bright day
	Cloudy	For recording under overcast, shady or twilight skies
	Tungsten	For recording under tungsten and bulb-type 3-wavelength fluorescent lighting
	Fluorescent	For recording under warm-white, cool-white or warm-white (3-wavelength) fluorescent lighting
	Fluorescent H	For recording under daylight fluorescent, or daylight fluorescent-type 3-wavelength fluorescent lighting
	Flash	For flash photography
	Custom1	For setting a custom value with a white sheet of paper, etc., to obtain the optimal white balance for the conditions. There are two custom values: custom1 and custom2.
	Custom2	

The icons in parentheses are the ones on the display panel. (Shown only when there is a difference between the display panel icon and LCD monitor/viewfinder icon.)

1 Press WB (▼ on the omni selector).

- The current white balance mode will appear on the display panel and the white balance setting menu will appear on the LCD monitor (or in the viewfinder).



2 Select the desired setting using the main dial or the ◀ or ▶ arrow on the omni selector.

- Please see below regarding the  custom setting.
- You can shoot the image right after selecting settings by pressing the shutter button. The menu displays again after the shot, allowing you to change the settings easily.





3 Press WB or click the main dial.



- The white balance cannot be adjusted when the photo effect is set to  (Sepia) or  (B/W).





Setting a Custom White Balance

You can set a custom white balance to obtain the optimal setting for the shooting conditions by having the camera evaluate a subject such as a white piece of paper or cloth, or a photo-quality gray card. You can set two different custom settings. Shoot after reading the white balance data in  (Custom1) or  (Custom2) in the following cases since the white balance may not be correctly adjusted in **AWB** (Auto):

- Shooting close-ups
- Shooting subjects of monotone color (such as sky, sea or forest)
- Shooting with a peculiar source of light (such as a mercury-vapor lamp)

1 Press WB (▼ on the omni selector).

- The current white balance mode will appear on the display panel and the white balance setting menu will appear on the LCD monitor (or in the viewfinder).

- 2** Select  (Custom1) or  (Custom2) using the main dial or the  or  arrow on the omni selector.

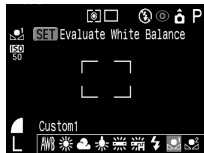



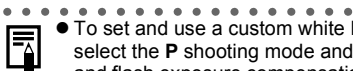

- 3** Aim the camera at the white paper or cloth, or gray card and press the **SET** button.

- Aim the camera so that the white paper or cloth, or gray card, completely fills the frame on the LCD monitor (or viewfinder) before pressing the **SET** button. When you press the **SET** button, the camera reads the white balance data.
- You can shoot the image right after selecting settings by pressing the shutter button. The menu displays again after the shot, allowing you to change the settings easily.

- 4** Press **WB** or click the main dial.



- To set and use a custom white balance setting, it is advisable to select the **P** shooting mode and set the exposure compensation and flash exposure compensation to zero (± 0). The correct white balance may not be obtained when the exposure is incorrect (image is completely black or white).
- You should also zoom to the maximum telephoto setting. Also, the digital zoom should be set to [Off].
- Since the white balance data cannot be read in  mode, preset the white balance in another shooting mode first before selecting  mode.
- Shoot with the same settings as when reading the white balance data. If the settings differ, the optimal white balance may not be set. Especially the following should not be changed.
 - Flash
Setting the flash to on or off is recommended. If the flash fires when reading the white balance data with the flash set to  or , make sure that you also use the flash when you shoot.
 - ISO Speed
- The custom white balance setting is not canceled even if settings are reset to default settings (p. 52).

Changing the Photo Effect

Mode Dial

P Tv Av M

You can shoot with different photo effects.

()	Photo Effect Off	Records with no effect.
()	Vivid	Emphasizes the contrast and color saturation to record in bold color.
()	Neutral	Tones down the contrast and color saturation to record neutral hues.
()	Low Sharpening	Records subjects with softened outlines.
()	Sepia	Records in sepia tones.
()	B/W	Records in black and white.
()	Custom Effect	You can freely set the contrast, sharpness and color saturation.

The icons in parentheses are the ones on the display panel.

- 1 Press the FUNC. button and select * (LCD monitor/Viewfinder) or * (Display Panel) using the ▲ or ▼ arrow on the omni selector.**

* The current setting is displayed.

- The Photo Effect setting menu appears on the LCD monitor (or in the viewfinder).

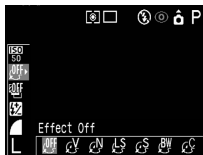

- 2 Select the desired setting using the main dial or the ◀ or ▶ arrow on the omni selector.**

When is selected

A screen allowing you to set the contrast, sharpness and color saturation appears when you press the **SET** button.



In this screen, select the item you wish to set using the ▲ or ▼ arrow on the omni selector and set it using the ◀ or ▶ arrow on the omni selector.



Contrast

- Select from – (Weak), 0 (Neutral) and + (Strong).
- This function allows you to adjust the degree of brightness.

Sharpness

- Select from – (Weak), 0 (Neutral) and + (Strong).
- This function allows you to adjust how sharply outlines are defined.



Saturation

- Select from – (Low), 0 (Neutral) and + (High).
- This function allows you to adjust the color depth.

You can shoot the image right after selecting settings by pressing the shutter button. The menu displays again after the shot, allowing you to change the settings easily.

3 Press the FUNC. button or click the main dial.



- The white balance cannot be set when  (Sepia) or  (B/W) mode is selected.

Shooting in Adobe RGB Color Space

Mode Dial

P Tv Av M

This camera can record still images in Adobe RGB color space.

Standard	Normally select this option.
Adobe RGB*	Select this option when: - Doing commercial printing in the Adobe RGB environment - Using software, monitors and printers compliant with Exif 2.21

* Use of this function is not recommended if you do not have image processing and Adobe RGB technical knowledge.

1 In the [(Rec.)] menu, select [Color Space].

- See *Selecting Menus and Settings* (p. 44).

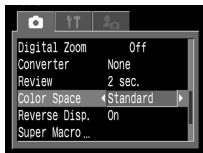

2 Select [Adobe RGB] or [Standard] and press the MENU button.

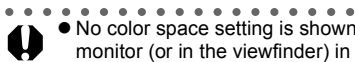

- No color space setting is shown on the display panel or LCD monitor (or in the viewfinder) in Shooting mode. Please check the setting using the Rec. menu. (“Adobe RGB” appears in Playback mode detailed display.)



- When you play back an image shot in Adobe RGB in detailed display mode, “Adobe RGB” is displayed (p. 38).
- Adobe RGB supports both the JPEG format and RAW format (p. 60).
- Images shot in Adobe RGB will be desaturated when played back or printed using software programs, monitors or printers not compliant with Exif 2.21.

ISO Changing the ISO Speed

Mode Dial

P Tv Av M

Raise the ISO speed to prevent camera shake when shooting in dark places, when you want to shoot without the flash or with a faster shutter speed.

- 1 Press the FUNC. button and select ISO AUTO* (LCD monitor/Viewfinder) OR ISO AUTO* (Display Panel) using the ▲ or ▼ arrow on the omni selector.**

* The current setting is displayed.

- The ISO speed setting menu appears on the LCD monitor (or in the viewfinder).



- 2 Select the desired setting using the main dial or the ◀ or ▶ arrow on the omni selector.**

- You can shoot the image right after selecting settings by pressing the shutter button. The menu displays again after the shot, allowing you to change the settings easily.

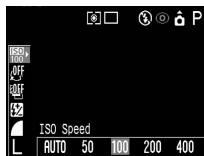

- 3 Press the FUNC. button or click the main dial.**



- Higher ISO speeds increase the image noise. To take clean images, use as low an ISO speed as possible.
- The AUTO setting selects the optimal ISO speed. It will automatically raise the speed when the light from the flash is insufficient to illuminate the subject matter.

Auto Exposure Bracketing (AEB Mode)

Mode Dial

P Tv Av

In this mode, the camera automatically changes the exposure within a set range to take three shots after you press the shutter button once. You can adjust AEB settings in 1/3EV steps within the range of -2EV to +2EV of the standard exposure setting. AEB settings can be combined with exposure compensation settings (p. 92) to extend the adjustment range.

The images are shot in the following order: Standard exposure, underexposure and overexposure.

- 1 Press the FUNC. button and select * (LCD monitor/Viewfinder) or **BKT OFF*** (Display Panel) using the **▲** or **▼** arrow on the omni selector.**

* The current setting is displayed.

- The Bracket setting menu appears on the LCD monitor (or in the viewfinder).



- 2 Select  (LCD monitor/Viewfinder) or **BKT AE-b** (Display Panel) using the main dial or the **◀** or **▶** arrow on the omni selector, then press the SET button.**

- The range indicator appears. If you wish to use the currently set exposure range, press the **FUNC.** button to end the mode setting operation and shoot the image.



3 Expand or contract the range using the main dial or the ◀ or ▶ arrow on the omni selector.

- Use ▶ to expand the range and ◀ to contract it.
- The camera returns to the Step 2 screen if you press the **SET** button.
- You can shoot the image right after selecting settings by pressing the shutter button. The menu displays again after the shot, allowing you to change the settings easily.



4 Press the FUNC. button or click the main dial.

- Select **OFF** or **BKT OFF** in Step 2 to cancel AEB mode.

5 Shoot the image.

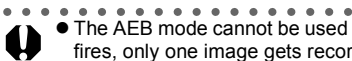

- The AEB mode cannot be used for flash photography. If the flash fires, only one image gets recorded.

Focus Bracketing (Focus-BKT Mode)

Mode Dial

P Tv Av M

You can shoot three images while the focus changes automatically when shooting with the manual focus (p. 114). Three ranges -small, medium or large- can be selected. Images are shot with the focus position changing in the following order: selected position, further away and closer.

- 1 Press the FUNC. button and select * (LCD monitor/Viewfinder) or **BKT OFF*** (Display Panel) using the **▲** or **▼** arrow on the omni selector.**

* The current setting is displayed.

- The Bracket setting menu appears on the LCD monitor (or in the viewfinder).



- 2 Select  (LCD monitor/Viewfinder) or **BKT FC-b** (Display Panel) using the main dial or the **◀** or **▶** arrow on the omni selector, then press the SET button.**

- The range indicator appears. If you wish to use the currently set focus range, press the **FUNC.** button to end the mode setting operation and shoot the image in manual focus (p. 114).



3 Expand or contract the range using the main dial or the ◀ or ▶ arrow on the omni selector.

- Use ▶ to expand the range and ◀ to contract it.
- The camera returns to the Step 2 screen if you press the **SET** button.
- You can shoot the image right after selecting settings by pressing the shutter button. The menu displays again after the shot, allowing you to change the settings easily.



4 Press the FUNC. button or click the main dial.

5 Shoot the image in manual focus (p. 114).



- The Focus-BKT mode is not available when shooting with the flash on. The camera will revert to shooting only one image when the flash is on.

* Locking the Exposure Setting (AE Lock)

Mode Dial

P Tv Av

You can set the exposure and focus separately. This is effective when the contrast is too strong between the subject and background or when a subject is backlit.

1 Focus the AF frame or the spot metering frame on the subject on which you wish to lock the exposure setting and press the shutter button halfway.

- *Selecting an AF Frame* (p. 89)
- *Switching between Light Metering Modes* (p. 90)

2 While pressing the shutter button halfway, press the * button.

- The exposure setting locks (AE lock) and the * icon appears on the LCD monitor (or in the viewfinder).
- Using any button or lever other than the main dial cancels the AE lock.



AE Lock Icon

3 Recompose the image and shoot.

- The AF frame focuses on the subject.





- The automatically selected combinations of shutter speeds and aperture values can be freely changed without altering the exposure with the following procedure.
 1. Turn the mode dial to **P**, **Tv** or **Av**.
 2. Focus on the subject on which you wish to lock the exposure.
 - Press the shutter button halfway.
In **Tv** and **Av** modes, the Safety Shift function works if [Safety Shift] is set to [On] (p. 86).
 3. Press the ***** button.
 - The exposure setting will lock and the ***** icon will appear on the LCD monitor (or in the viewfinder).
 4. Turn the main dial until the desired shutter speed or aperture value is reached.
 5. Recompose the image and shoot.
 - The setting will cancel after the shot is taken.

* Locking the Flash Exposure Setting (FE Lock)

Mode Dial

P Tv Av



You can obtain the correct exposure with flash photography regardless of the location of your subject in the composition.

1 Press the  (Flash) button and set the flash to fire (p. 62).

- If you are using an externally mounted flash, please refer to its manual for setting instructions.

2 Focus the AF frame or the spot metering frame on the subject on which you wish to lock the flash exposure setting and press the shutter button halfway.

3 While pressing the shutter button halfway, press the .

- The exposure setting locks (FE lock) and the  icon appears on the LCD monitor (or in the viewfinder).
- The flash will fire a pre-flash and lock the flash exposure to the required intensity to illuminate the subject.
- Each time you press the , the flash exposure fires a pre-flash and locks at the required intensity for that composition.
- Using any button or lever other than the main dial cancels the FE lock.

4 Recompose the image and shoot.



- The FE lock only functions with the built-in flash, an externally mounted EX series Speedlite, a Macro Ring Lite or a Macro Twin Lite.
- The FE lock function is not available when [Flash Adjust] is set to [Manual].

Switching between Flash Adjustment Settings

Mode Dial

Tv Av

The built-in flash and the externally mounted flash* fire with automatic flash adjustments (except in the **M** mode), but it is possible to set them so that they fire without any adjustments.

* Speedlite 220EX/380EX/420EX/550EX, Macro Ring Lite MR-14EX, Macro Twin Lite MT-24EX

- 1 Select **[Flash Adjust]** from the **[ (Rec.)]** menu.
 - See *Selecting Menus and Settings* (p. 44).
- 2 Select **[Auto]** or **[Manual]** and press the **MENU** button.

Compensating the Flash Adjustment ((Flash))

Mode Dial

 P Tv Av

The flash adjustment can be changed when **[Flash Adjust]** is set to **[Auto]**. The settings can be adjusted in 1/3-stop increments in the range of -2EV to +2EV. By combining this function with the camera's exposure compensation function, you can adjust the exposure of the background as well as the subject.

- 1 Press the **FUNC.** button, then select  using the **▲** or **▼** arrow on the omni selector.
- 2 Adjust the compensation using the main dial or the **◀** or **▶** arrow on the omni selector.
 - You can shoot the image right after selecting settings by pressing the shutter button. The menu displays again after the shot, allowing you to change the settings easily.



3 Press the FUNC. button or click the main dial.

- To cancel the compensation, return the setting to .

Compensating the Flash Output

In **M** mode or when [Flash Adjust] is set to [Manual], the flash output can be controlled in three steps, starting from FULL, when shooting. This setting is also active with slave flash photography where multiple flashes are fired at the subject from different positions because the pre-flash does not fire. When an externally mounted flash is attached, its flash output can be controlled (Up to 1/16 from Full, in 1/3 steps).

1 Press the FUNC. button, then select  using the ▲ or ▼ arrow on the omni selector.

2 Adjust the output using the main dial or the ◀ or ▶ arrow on the omni selector.

- You can shoot the image right after selecting settings by pressing the shutter button. The menu displays again after the shot, allowing you to change the settings easily.

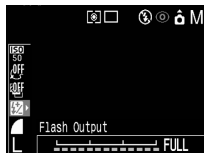

3 Press the FUNC. button or click the main dial.

Switching the Timing at which the Flash Fires

Mode Dial

P Tv Av M

1st-curtain	The flash fires right after the shutter opens, regardless of the shutter speed. Usually, the 1st-curtain is used when shooting.
2nd-curtain	The flash fires right before the shutter closes, regardless of the shutter speed. Compared with the 1st-curtain, the flash fires later and this allows you to shoot images in which, for example, a car's rear lamps seem to trail off behind.



Image shot with the 1st-curtain setting



Image shot with the 2nd-curtain setting

- From the  (Rec.) menu, select [1st-curtain] or [2nd-curtain] in [Flash Sync].

Shooting Images at Set Intervals (Intervalometer)

Mode Dial

P Tv Av M

You can shoot images at a set interval. This function can be used for fixed-point observation of plants and blooming flowers. The shooting interval time can be set from 1 to 60 minutes and 2 to 100 images can be shot.



- Since the camera may shoot continuously for an extended period of time, the use of the separately sold Compact Power Adapter CA-560 is recommended (p. 182).

1 Select [Intervalometer] from the [Rec.] menu.

- See *Selecting Menus and Settings* (p. 44).



2 Select an interval time using the ◀ or ▶ arrow on the omni selector.

- If you press the omni selector continuously, the interval time increases in units of 5 minutes at a time.

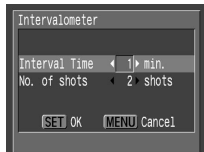

3 Press the ▼ arrow on the omni selector, then select the number of shots using the ◀ or ▶ arrow on the omni selector.

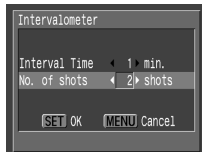

- If you press the omni selector continuously, the number of shots increases in units of 5 shots at a time.
- The maximum number of shots* is determined according to the CF card's remaining capacity.

* The maximum number of shots may decrease according to the images shot.

4 Press the SET button

- **Int.** appears on the LCD monitor (or in the viewfinder) and *int* appears on the display panel.

5 Press the shutter button.

- The first image is shot and the interval shooting session starts.
- Once the set number of shots is taken, the camera automatically powers down regardless of the power saving function settings.
- If the below operations are accessed while the interval shooting is in process, the interval shooting session will be canceled.
 - Turning the mode dial or pressing the shutter button halfway while the camera is waiting to shoot the next image
 - Opening the CF card/battery cover
 - Switching to Playback mode
 - Turning off the power



- Once the interval shooting session is started, all operation buttons become inactive.
- The lens stays extended until the next image is shot.
- Images are not displayed on the LCD monitor (or in the viewfinder) right after being shot.
- Interval shooting is not available when the date and time are not set.
- Super Macro mode, Continuous Shooting (normal, high-speed) and Self-timer are not available.
- The AEB mode and the Focus-BKT mode settings cannot be set.

Shooting Problem Subjects for the Autofocus

The autofocus may not work well on the following types of subjects.

- Subjects with extremely low contrast to the surroundings
- Subjects mixing close and far objects
- Subjects with extremely bright objects at the center of the composition
- Subjects that are moving quickly
- Subjects with horizontal stripes

To shoot these subjects, first aim the camera at an object at a similar distance, lock the focus (focus lock) or autofocus (AF lock) and recompose the image with the desired subject. You can also use manual focus.

Shooting with Focus Lock



- 1 Aim the AF frame at an object at a similar distance to the subject you wish to shoot.**
- 2 Press the shutter button halfway to lock the focus.**
 - The AE setting will also lock when you do this. The exposure may occasionally be incorrect if the difference between the two items is too great. Use the AF lock function or the AE lock procedure (p. 104) when this happens.
- 3 Keep it pressed while you recompose the image and press the shutter button all the way to shoot the image.**

Shooting with AF Lock

Mode Dial



1 Press the shutter button halfway to lock the focus. Keep it pressed and press the MF button.

- The **MF** icon appears on the LCD monitor (or in the viewfinder).
- The focus setting will lock even if the shutter button and the **MF** button are released.
- The AF lock will cancel if the **MF** button is pressed again.

2 Recompose the image and press the shutter button all the way to shoot the image.



- The AF lock function is convenient because you can let go of the shutter button to recompose the image. Moreover, the focus remains locked after the picture is taken, allowing you to capture a second image with the same focus.
- When shooting through glass, get as close as possible to avoid reflection off the glass.

Shooting in Manual Focus Mode



Mode Dial



The focus can be manually set.

1 Press and hold the MF button, then turn the zoom ring to focus on the subject.

- The **MF** icon and the MF indicator will appear on the LCD monitor (or in the viewfinder).
- The AF frame area is magnified when [MF-Point Zoom] is set to [On] in the [ (Rec.)] menu.*

* Except in the  and  modes, when the digital zoom is activated or a TV is used as the display.

* Can also be set so that the image displayed is not magnified (p. 47).

- The MF indicator shows approximate figures. Use them as a shooting guideline only.
- Adjust the focus by turning the zoom ring until the image appears focused on the LCD monitor (or in the viewfinder).
- If you let go of the **MF** button without operating the zoom ring, Manual Focus mode will be canceled.



MF indicator

2 Shoot the image.

Using the Manual Focus in Combination with the Auto Focus

Mode Dial

 P Tv Av M

The camera automatically searches for a more suitable focusing point from the current manually focused location.

1 Focus the camera with the manual focus, then press the SET button.

- The camera focuses automatically to a more accurate focusing point near the current focusing point.



- You cannot change the AF frame setting while focusing manually. Cancel the manual focus mode, then change the AF frame setting.



- You can use manual focus in the macro focal distance (p. 73). In this case, the fine scale is adopted.
- You can change the MF indicator displayed distance units (p. 50).

Switching between Focus Settings

Mode Dial

AUTO     P Tv Av M

You can switch between focus settings to shoot.

Continuous	The camera is continually focusing on whatever it is aimed even when the shutter button is not pressed, allowing you to shoot without missing opportunities. This is the default setting.
Single	The camera only focuses when the shutter button is pressed halfway, conserving battery power.

1 In the [(Rec.)] menu, select [AF Mode].

- See *Selecting Menus and Settings* (p. 44).

2 Select [Continuous] or [Single] and press the MENU button.

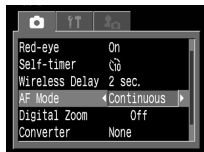

C1 C2 Saving Custom Settings

You can save frequently used shooting modes and various shooting settings to the **C** (custom) mode. This camera is equipped with two modes (**[C1]** and **[C2]**), allowing you to save two types of custom settings. When necessary, you can then shoot images with previously saved settings by simply turning the mode dial to **C1** or **C2**. Settings that are usually forgotten when the shooting mode is changed or when the power is turned off (such as Macro mode or Drive mode) are also remembered.

Settings that can be saved to the C1/C2 mode

- Shooting Mode (**P**, **Tv**, **Av** and **M**)
- Rec. menu settings
- Manual Focus location
- Functions available in **P**, **Tv**, **Av** and **M** except for Super Macro mode (p. 202)
- Zoom location

1 Turn the mode dial to **P**, **Tv**, **Av** or **M**.

2 Set the setting contents you wish to save.

3 Select [Save settings] from the [] (Rec.) menu.

- See *Selecting Menus and Settings* (p. 44).



4 Select [**C1**] or [**C2**] and press the SET button.

- Selects a save destination (**C1** or **C2**).

5 Press the MENU button.



- When you wish to re-save partially modified settings (except shooting mode) that were previously saved in the **C1** or **C2** mode, select **C1** or **C2** in Step 1.
- The setting contents do not influence other shooting modes.
- Saved settings can be reset (p. 52).

Setting the Auto Rotate Function

Mode Dial

AUTO     P Tv Av M

This camera is equipped with an Intelligent Orientation sensor that detects the orientation of an image shot with the camera on end and automatically rotates it to the correct viewing orientation in the display. You can set this function on/off.



1 Select [Auto Rotate] in the [M] (Set up) menu.

- See *Selecting Menus and Settings* (p. 44).



2 Select [On] and press the MENU button.

- When this function is On, an icon showing the orientation of the camera appears at the upper right corner of the LCD monitor (or viewfinder).

	Normal
	Camera on right end
	Camera on left end



- This function may not operate correctly when the camera is pointed straight up or down. Check that the correct camera orientation icon (e.g. ) is displayed and if it is not, then set the Auto Rotate function to Off.
- Even if the Auto Rotate function is set to On, the orientation of images downloaded to a computer will depend upon software used to download the images.



- When the camera is held on end to shoot, the Intelligent Orientation sensor judges the upper end to be “up” and the lower end to be “down”. It then regulates the optimal white balance and exposure for vertical photography. This function operates regardless of the On/Off status of the Auto Rotate function.
- When changing the camera’s orientation between the horizontal and vertical positions, you may hear noise coming from the orientation detection mechanism. This is not a malfunction.

Resetting the File Numbers

You can select the way file numbers are assigned.

On	The file numbers are reset to the start (100-0001) each time a new CF card is inserted. New images recorded on CF cards with existing files are assigned the next available number.
Off	The file number of the last image to be shot is memorized so that images recorded to a new CF card start from the next number.

1 In the [M] (Set up) menu, select [File No. Reset].

- See *Selecting Menus and Settings* (p. 44).

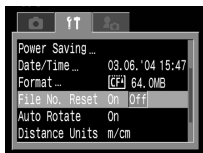

2 Select [On] or [Off] and press the MENU button.



- Setting the [File No. Reset] to [Off] is useful for avoiding file name duplication when images are downloaded to a computer.

About File and Folder Numbers

Images are assigned file numbers from 0001 to 9900, and folders are assigned folder numbers from 100 to 998 (folder numbers cannot contain 99 in the last two digits).

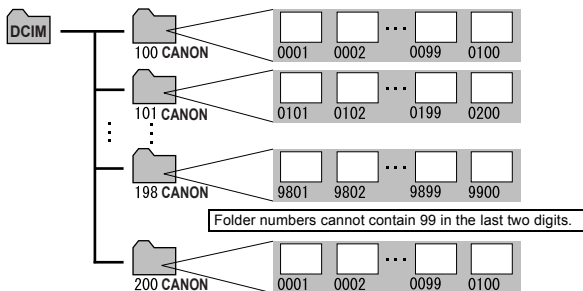

Folder File Capacity

Each folder usually contains up to 100 images.

However, since images shot in Continuous mode or Stitch Assist mode are always saved into the same folder, a folder may contain more than 100 images. The number of images may also exceed 100 if a folder contains images copied from a computer or images shot with other cameras. Please note, however, that the images in folders containing 2001 or more images cannot be replayed in this camera.

Displaying Images Individually

You can view the recorded images on the LCD monitor (or in the viewfinder).

1

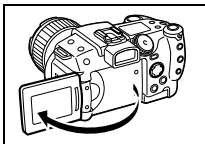



Open the LCD monitor.

- The LCD monitor can be freely opened to any position (p. 32).
- You can use the viewfinder for playback without opening the LCD monitor.

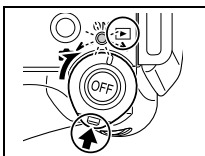
2









Turn the mode lever to .

- The last recorded image appears (single image playback).
- You can switch between the LCD monitor and viewfinder by pressing the  button.
-  appears on the display panel.

3

Move between images turning the main dial or using the or arrow on the omni selector.

- Use  to move to the previous image and  to move to the next. Holding  or  moves more rapidly between images, but the images will not appear as clearly.
- Turn the main dial to the left to move to the previous image and to the right to move to the next.
- Turn the main dial or press the  or  arrow on the omni selector after having pressed the **JUMP** button, to jump 10 images behind or ahead. (A black screen appears while the camera is jumping images.) If you press the **JUMP** button once more, the camera returns to the single image playback screen.



- You may not be able to play back images that have been shot with another camera or edited on a computer or with other software applications.



- Press the **INFO.** button to show the data for the displayed image (p. 34).
- Press the  button to quickly delete the displayed image (p. 138).

🔍 Magnifying Images

Images can be magnified up to approximately 10 times while in single image playback.

1 While in single image playback, press the 🔍 button or turn the zoom ring toward telephoto.

- Press the ◀, ▶, ▲ or ▼ arrow on the omni selector to move the magnified area around the image.
- To reduce the size of the magnified image, press the 📐 button or turn the zoom ring toward wide angle.
- You can also magnify images by pressing the 🔍 button while holding the **SET** button. Each press of the 🔍 button magnifies the image approx. 2.5 times, approx. 5 times and 10 times in order. Also, the magnified image can be reduced to approx. 5 times, 2.5 times and normal size in order by pressing the 📐 button repeatedly while holding the **SET** button.



Approximate position

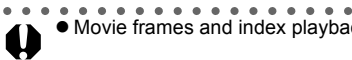

- Movie frames and index playback images cannot be magnified.

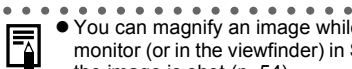

- You can magnify an image while it is displayed on the LCD monitor (or in the viewfinder) in Shooting mode immediately after the image is shot (p. 54).
- Use the main dial to choose another image when the image is magnified.

Viewing Nine Images at a Time (Index Playback)

Up to nine images can be viewed at once in index playback.

1 While in single image playback, press the button.

- Nine images appear at once (index playback).

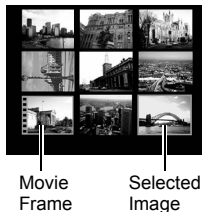

2 Change the image selection by turning the main dial or using the ▲, ▼, ◀ or ▶ arrow on the omni selector.



← Pressing the ▲ arrow in this row displays the previous set of nine images.

← Pressing the ▼ arrow in this row displays the next set of nine images.

3 Press the button.

- Index playback cancels and the display reverts to single image playback.



- Press the **INFO.** button to show the data for the displayed image (p. 34).

JUMP Jumping Between Images

The display can be advanced or set back 9 images in either single image playback or index playback.

1 Press the JUMP button while in single image playback (p. 122) or index playback (p. 124).

- The jump bar appears.

2 The displayed image(s) change.

Single Image Playback

- Jump 9 images behind or ahead by turning the main dial or using the ◀ or ▶ arrow on the omni selector.
- Display the first or last image by pressing the ◀ or ▶ arrow on the omni selector while holding the SET button.

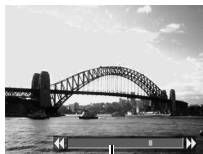

Jump Bar

Index Playback

- Jump to the previous or next set of nine images by turning the main dial or using the ◀ or ▶ arrow on the omni selector.
- Display the first or last 9 images by pressing the ◀ or ▶ arrow on the omni selector while holding the SET button.



Jump Bar

3 Press the JUMP button.

- The jump bar disappears and the jump mode cancels.

Viewing Movies

You can play back movies shot in  mode.

1 Turn the mode lever to .

- Movies cannot be viewed in index playback.

2 Select a movie by turning the main dial or using the or arrow on the omni selector.



- A movie displays with the instruction  on it.



3 Press the SET button.

- The movie playback panel appears.

4 Select (Play) using the or arrow on the omni selector and press the SET button.

- The movie images and sound will play.
- You can adjust the volume using the  or  arrow on the omni selector.
- When a movie has finished playing, it will display the last frame. If the **SET** button is pressed in this state, the camera will revert to the movie playback display. If the **SET** button is pressed again, the movie will start playing from the first frame.



Volume

Pausing and Resuming Play





- Press the **SET** button to pause the movie. Press it again to resume.

Exiting Movie Playback

- Press the **MENU** button (the Play menu appears). To select another movie or image, press the **MENU** button again (the screen returns to Step 2).

Fast Forwarding/Rewinding

- Select one of the following operations using the ◀ or ▶ arrow on the omni selector and press the **SET** button.

 (Exit)	: Return to single image playback
 (First Frame)	: First Frame
 (Previous Frame)	: Previous Frame (Rewinds if the SET button is held down)
 (Next Frame)	: Next Frame (Fast-forwards if the SET button is held down)
 (Last Frame)	: Last Frame



- You may experience frame dropping and audio breakup when playing back a movie on a computer with insufficient system resources.



- The volume at which movies play back can also be adjusted in the Set up menu (p. 49).
If you set [Mute] to [On] in the Set up menu (p. 49), no sound is reproduced. However, you can resume the sound and adjust the volume during movie playback by pressing the ▲ or ▼ arrow on the omni selector.
- Please adjust the audio sound level on the TV when viewing movie files on a TV.

Editing Movies

You can delete unwanted portions from the first or second half of a movie clip.

1 Select the movie you wish to edit and press the **SET** button.

- See *Viewing Movies* (p. 126).

2 Select **[Scissors]** (Edit) using the **◀** or **▶** arrow on the omni selector and press the **SET** button.

- The movie editing panel and the movie editing bar appear.



3 Select an editing method using the **▲** or **▼** arrow on the omni selector.

- [Scissors]** (Cut beginning) : Deletes frames in the first half of the movie
- [Scissors]** (Cut end) : Deletes frames in the second half of the movie
- [Exit]** (Exit) : Reverts to the movie playback panel



Movie
Editing
Panel

Movie
Editing
Bar

4 Select the range you wish to edit using the **◀** or **▶** arrow on the omni selector.



Editing position

5 Select **[Play]** (Play) using the **▲** or **▼** arrow on the omni selector and press the **SET** button.

- The temporarily edited movie will start playing.
- The movie will stop if you press the **SET** button while it is playing.

6 Select (Save) using the ▲ or ▼ arrow on the omni selector and press the SET button.

- When  is selected, the edited movie is not saved and the camera reverts to the movie editing panel.



7 Select [Overwrite] or [New File] using the ◀ or ▶ arrow on the omni selector and press the SET button.

- [Overwrite]: Saves the edited movie under the same file name as the original movie. The original data is deleted.
- [New File]: Saves the edited movie under a new file name. The original data is not deleted.
- When there is not enough space left on the CF card, only the overwrite function is available.



- Protected movies cannot be edited.



- It may take approximately 3 minutes to save an edited movie. If the battery pack runs out of charge partway through, edited movie clips cannot be saved. When editing movies, use a fully charged battery pack or separately sold Compact Power Adapter CA-560 (p. 182).

- Movies with an original length of 1 second or more can be edited in 1-frame units.



Rotating Images in the Display

Images can be rotated 90° and 270° clockwise on the LCD monitor (or in the viewfinder).

Original



90°



270°



1 Select [Rotate] from the [▶] (Play) menu.

- See *Selecting Menus and Settings* (p. 44).

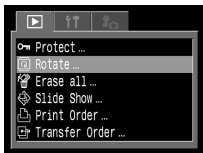

2 Select an image you want to rotate by turning the main dial or by using the ◀ or ▶ arrow on the omni selector and press the SET button.

- The image cycles to the next orientation (90° → 270° → original) each time the **SET** button is pressed.



3 Press the MENU button.

- The Play menu appears again. Press the **MENU** button again to close the menu.



- Movie images cannot be rotated.
- When images are downloaded to a computer, the orientation of images rotated by the camera will depend upon the software used to download the images.



- Images can be magnified when rotated (p. 123).
- Images taken vertically with the auto rotate function (p. 119) set to [On] will automatically be rotated to the vertical position when viewed on the LCD monitor (or in the viewfinder).

Attaching Sound Memos to Images

In playback mode (including single image playback, index playback, magnified playback and the review immediately after shooting in Shooting mode) you can attach sound memos (up to 60 seconds) to an image. The sound data is saved in WAVE format.

1 Press the button while playing back images.

- The Sound Memo panel appears.





2 Select using the or arrow on the omni selector, then press the **SET** button.

- The recording starts and the elapsed time is displayed. Speak towards the microphone of the camera.
- To stop recording, press the **SET** button. To restart recording, press the **SET** button again.
- You can add as many sound memos as you like until their total time reaches 60 seconds.
- Press the  button to end the sound memo settings.



Sound Memo Panel

Playing back the Sound Memos

Select  in step 2 above. Images with sound memos are displayed with the  mark (standard display or detailed display). To stop playback, press the **SET** button. To restart playback, press the **SET** button again. You can adjust the volume using the  or  arrow on the omni selector.

Erasing the Sound Memos

Select  in Step 2 on the previous page.



- You cannot attach sound memos to movies.
- You cannot record or playback sound notes for images that already have an incompatible sound file attached. If you attempt to record or play such images, the “Incompatible WAVE format” message will display. Incompatible sound files can be deleted with this camera.
- Sound memos for protected images cannot be erased (p. 137).



- The volume can be adjusted in the Set up menu (p. 49).
If you set [Mute] to [On] in the Set up menu (p. 49), no sound is reproduced, however, you can resume the sound and adjust the volume during movie playback by pressing the ▲ or ▼ arrow on the omni selector.

Automated Playback (Slide Show)

Slide show image settings are based on DPOF standards (p. 147).

Starting a Slide Show

All images or a selection of images on a CF card can be displayed one-by-one in an automated slide show.

All Images	Plays all the images on the CF card in order
Slide Show 1 – 3	Plays the images selected for each show in order.

1 In the [▶] (Play) menu, select [Slide Show] and press the SET button.

- See *Selecting Menus and Settings* (p. 44).

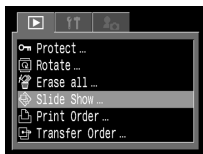

2 Press the ▲ or ▼ arrow on the omni selector to select [Program]. Press the ◀ or ▶ arrow to select between [All Images] or any one of slide [Show 1] – [Show 3].

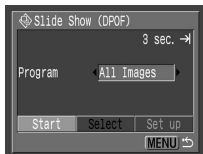

3 Press the ▲ or ▼ arrow on the omni selector to select [Start] and press the SET button.

- The slide show will start and automatically stop when the show is done.

Pausing and Resuming a Slide Show

- Press the SET button to pause the show. Press it again to resume.

Fast Forwarding/Rewinding a Slide Show

- Turn the main dial or use the ◀ or ▶ arrow on the omni selector to move to the previous or next image.

Stopping a Slide Show

Press the MENU button during a slide show to stop it and display the slide show menu.

4 When the slide show is over, press the MENU button.

- The slide show menu appears again. Press the **MENU** button again to close the menu.



- Movie images play for the length of time that they were recorded regardless of the time set in the slide show settings.
- The power saving function is disabled while a slide show plays on the camera (p. 31).

Selecting Images for Slide Shows

You can mark images for inclusion in slide shows 1-3. Up to 998 images may be marked per slide show. Images display in the order of their selection.

1 Display the slide show menu (p. 133).

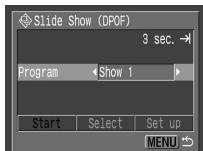

2 Press the ▲ arrow on the omni selector to select [Program]. Press the ◀ or ▶ arrow to select [Show 1], [Show 2] or [Show 3].

- A check mark will appear beside a show already containing images.

3 Press the ▼, and ◀ or ▶ arrow on the omni selector to choose [Select] and press the SET button.

4 Mark images to include in the show.

Single Image Playback

- Move between images using the main dial or the ◀ or ▶ arrow on the omni selector and mark or remove marks from images using the ▲ or ▼ arrow on the omni selector.
- The selection number and a check mark appear at the top of selected images.



Index Playback

- Press the  button to switch to index playback (3 images).
- Select an image using the main dial or the ◀ or ▶ arrow on the omni selector and mark or remove marks from images using the ▲ or ▼ arrow on the omni selector.
- The selection number and a check mark appears at the bottom of selected images.
- After you press the **SET** button, you can select all the images by selecting [Mark all] using ▲ or ▼ on the omni selector and pressing the **SET** button again. (You can deselect all the images by selecting [Clear all].)
- You can select images using the main dial or the ◀ or ▶ arrow on the omni selector and change the settings using the ▲ or ▼ arrow on the omni selector after [Mark all] or [Clear all] has been selected.



5 Press the MENU button.

- The image selection screen will close.

Adjusting the Play Time and Repeat Settings

You can change the play time for all the images in a show and have the show repeat itself continuously.

Play Time	Sets the duration that each image in a slide show is displayed. The options are any one of 3 – 10 seconds, 15 seconds, 30 seconds and Manual.
Repeat	Sets whether the slide show stops when all the slides have been displayed or continues to display until stopped.

1 Display the slide show menu.

2 Select [Set up] using the ◀ or ▶ arrow on the omni selector and press the SET button.

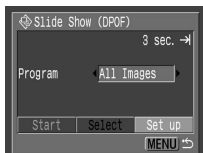

3 Select [Play Time] or [Repeat] using the ▲ or ▼ arrow on the omni selector.

4 Select a setting using the ◀ or ▶ arrow on the omni selector.

Play Time

- Select a play time.

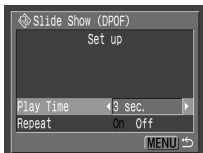

Repeat

- Select [On] or [Off].



5 Press the MENU button.

- The set up menu closes.



- The display interval may vary somewhat for some images.
- Slide shows can be easily edited on a computer with the supplied ZoomBrowser EX or ImageBrowser software programs.

Protecting Images



You can protect important images from accidental erasure.

1 In the [(Play)] menu, select [Protect] and press the SET button.

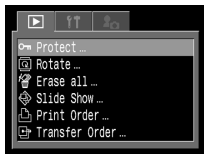
- See *Selecting Menus and Settings* (p. 44).



2 Select an image you want to protect and press the SET button.

- The  icon appears on protected images.
- To remove the protection, press the SET button again (in protection mode).
- You can make the selection of images easier by toggling between single image playback and index playback with the  button.



3 Press the MENU button.

- The protect window closes.



- Please note that formatting (initializing) a CF card erases all data, including protected images (p. 139) and other file types. Please check the contents of a CF card before formatting it.

Erasing Images Individually

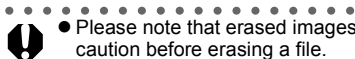

- Please note that erased images cannot be recovered. Exercise caution before erasing a file.

1 Select the image you wish to erase and press the  button.

2 Select [Erase] using the ◀ or ▶ arrow on the omni selector and press the **SET** button.

- To cancel instead of erasing, select [Cancel] and press the **SET** button.

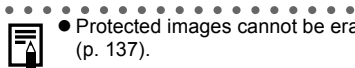

- Protected images cannot be erased with the erase function (p. 137).

Erasing All Images

1. In the [ (Play)] menu, select [Erase all] and press the **SET** button.

- See *Selecting Menus and Settings* (p. 44).

The “Erase all images?” message appears.

2. Press the ◀ or ▶ arrow on the omni selector to select [OK] and press the **SET** button.

- To cancel instead of erasing, select [Cancel] and press the **SET** button.

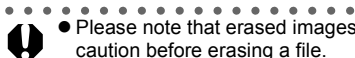

- Please note that erased images cannot be recovered. Exercise caution before erasing a file.



- Protected images cannot be erased with the erase function (p. 137).

Formatting a CF Card

You should always format a new CF card or one from which you wish to erase all images and other data. Formatting may restore a CF card if it returns an error or if the “LF” message displays.

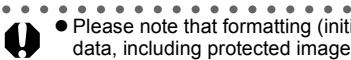

- Please note that formatting (initializing) a CF card erases all data, including protected images and other file types. Please check the contents of the CF card before formatting it.

1 In the [1] (Set up) menu, select [Format] and press the SET button.

- See *Selecting Menus and Settings* (p. 44).

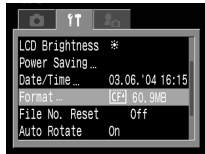

2 Press the ◀ or ▶ arrow on the omni selector to select [OK] and press the SET button.

- To cancel formatting instead, select [Cancel] and press the SET button.
- The capacity of the CF card displayed after formatting will be less than the rated capacity written on the label of the CF card. This is not a malfunction of the CF card or camera.

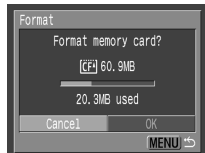

- If the camera does not work properly, the inserted CF card may be malfunctioning. Reformatting the CF card may solve the problem.
- When a non-Canon brand CF card is malfunctioning, reformatting it may solve the problem.
- CF cards formatted in another camera, computer or peripheral device may not operate correctly. When that happens, reformat the CF card with this camera. If formatting in the camera does not work properly, turn the camera off and reinsert the CF card. Then turn the camera back on and format again.

About Printing

You can easily print images stored on the CF card by connecting the camera to a direct print compatible printer with a cable and operating the camera buttons. In addition, you can specify the images on your CF card you want to print and how many copies you want (DPOF* Print Settings), and then take the CF card to a participating photo lab to have them printed out later.

This camera complies with the industry standard *PictBridge*, therefore, you can connect the camera to non-Canon *PictBridge* compliant printers and print images.

* Digital Print Order Format

This manual explains the DPOF print settings. For information on how to print images, refer to the *Direct Print User Guide* supplied with the camera. Also, refer to your printer's manual.

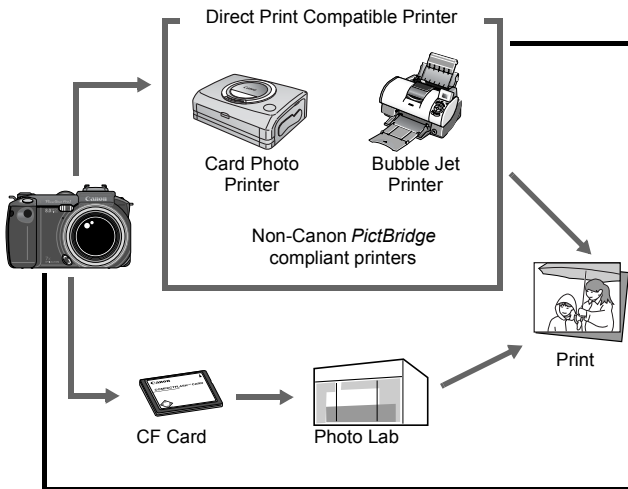

Refer to the *System Map* supplied with your camera for direct print compatible printer (CP series or Bubble Jet printers) information.

Direct Print Compatible Printing

- Connect the camera to the printer
- Set various print settings (except DPOF print settings)
- Print



For details, see the *Direct Print User Guide*.

DPOF Print Settings

- See *Selecting Images for Printing* (p. 142).



- Set the number of print copies (p. 142).



- See *Setting the Print Style* (p. 144).

- Standard/Index/Both
- Date: On/Off
- File Numbers: On/Off

For details, see the *Direct Print User Guide*.

DPOF Transfer Order

- Select the images to download to a computer (p. 147).

Print Settings (DPOF Print Settings)

You can select images on a CF card for printing and specify the number of print copies in advance using the camera. This is extremely convenient for sending the images to a photo developing service or for printing on a direct print function compatible printer. Refer to the *Direct Print User Guide* for instructions on how to select print settings from the printer.





- The  mark may appear on images that have had print marks set by another DPOF compliant camera. These settings will be overwritten by any print marks set by your camera.
- The output of some digital printers or photo lab services may not reflect the specified print settings.
- Print settings cannot be set for movie images or RAW images.

Selecting Images for Printing

1 In the [ (Play)] menu, select [Print Order] and press the SET button.

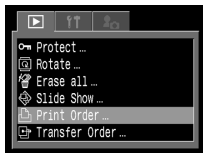
- See *Selecting Menus and Settings* (p. 44).





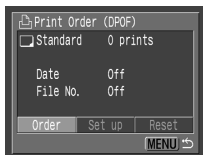

2 Press the  or  arrow on the omni selector to select [Order] and press the SET button.



3 Select images for printing.

Single Images

- When the print type (p. 144) is set to [Standard] or [Both], select an image using the main dial or the  or  arrow on the omni selector. You can set the number of copies (up to 99) to be printed using the  or  arrow on the omni selector.



- When the print type (p. 144) is set to [Index], select an image using the main dial or the ◀ or ▶ arrow on the omni selector and mark or remove marks from images using the ▲ or ▼ arrow on the omni selector. A check mark appears on the marked image.
- You can use the same procedures to select images in index playback (3 images). Press the  button to switch between single image playback and index playback.



All the Images on a CF Card

- Press the  button to switch to index playback (3 images).
- You can set one copy of each image to print by pressing the **SET** button, then selecting [Mark all] using the ▲ or ▼ arrow on the omni selector, and pressing the **SET** button again.
- When the print type is set to [Standard] or [Both], the setting for the number of print copies can be changed for each image. When [Index] is selected, the print settings can be deleted. For the instructions on changing settings, please reread Step 3 from the beginning.
- You can cancel all the settings by selecting [Clear all].



4 Press the MENU button.

- The selection mode will turn off and the Print Order menu will reappear.







- Images are printed in order from oldest to newest by the shooting date.
- A maximum of 998 images can be marked per CF card.
- When [Print Type] is set to [Both], the number of copies can be set. When it is set to [Index], the number of copies cannot be set (only one copy will be printed).
- Print settings can also be assigned to images with the supplied software programs on a computer.

Setting the Print Style

Always select a print style after having selected the image you wish to print.

The following print settings can be selected.

Print Type	 Standard	Prints one image per page
	 Index	Prints the selected images together at a reduced size in an index format
	 Both	Prints the images in both the standard and index formats
Date		Adds the date to the print
File No.		Adds the file number to the print

1 In the [ (Play)] menu, select [Print Order] and press the SET button.

- See *Selecting Menus and Settings* (p. 44).

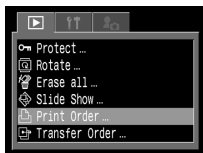

2 Press the ◀ or ▶ arrow on the omni selector to select [Set up] and press the SET button.

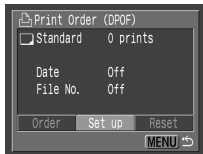

3 Press the ▲ or ▼ arrow on the omni selector to select [Print Type], [Date] or [File No.].

4 Press the ◀ or ▶ arrow on the omni selector to select a setting.

Print Type

- Select [Standard], [Index] or [Both].

Date

- Select [On] or [Off].

File No.

- Select [On] or [Off].

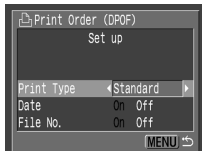

5 Press the MENU button.

- The set up menu will close and the Print Order menu will reappear.



- When [Print Type] is set to [Index], the [Date] and [File No.] cannot be set to [On] at the same time.
- With CP printers, if [Print Type] is set to [Both], both [Date] and [File No.] can be set to [On], however, only the file number is printed for the index print.



- The date prints as the date and time in the format specified in the Set Date/Time menu (p. 26).

Resetting the Print Settings

The print settings can all be removed at once. The print type is reset to [Standard] and the date and file number options are set to [Off].

- 1** In the [ (Play)] menu, select [Print Order] and press the SET button.

- See *Selecting Menus and Settings* (p. 44).



- 2** Press the ◀ or ▶ arrow on the omni selector to select [Reset] and press the SET button.

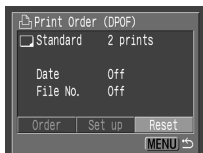

- 3** Press the ◀ or ▶ arrow on the omni selector to select [OK] and press the SET button.

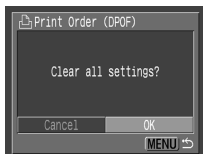



Image Transmission Settings (DPOF Transfer Order)

You can use the camera to specify settings for images before downloading to a computer. Refer to the *Software Starter Guide* for instructions on how to transfer images to your computer. You cannot use this function to transfer several images at once on Mac OS X computers.

The settings used on the camera comply with the Digital Print Order Format (DPOF) standards.

- The  mark may appear on images that have had transfer marks set by another DPOF compliant camera. These settings will be overwritten by any transfer marks set by your camera.

Selecting Images for Transferring

- 1** In the [ (Play)] menu, select [Transfer Order] and press the SET button.

- See *Selecting Menus and Settings* (p. 44).

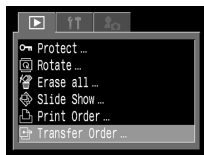

- 2** Select [Order] using the ◀ or ▶ arrow on the omni selector and press the SET button.

- Pressing [Reset] cancels the transfer settings for all images on the CF card.

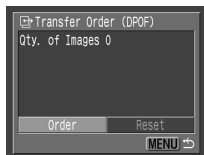

3 Select images for transferring.

Single Images

- Select an image using the main dial or the ◀ or ▶ arrow on the omni selector and mark or remove marks from images using the ▲ or ▼ arrow on the omni selector. A check mark appears on the marked image.
- You can use the same procedures to select images in index playback (3 images). Press the  button to switch between single image playback and index playback.



All the Images on a CF Card

- Press the  button to switch to index playback (3 images).
- Then press the **SET** button, and select [Mark all] using the ▲ or ▼ arrow on the omni selector and press the **SET** button again. (If you select [Clear all] instead of [Mark all], you can remove marks from all the images.)
- You can select images using the main dial or the ◀ or ▶ arrow on the omni selector and change the settings using the ▲ or ▼ arrow on the omni selector after [Mark all] or [Clear all] has been selected.



4 Press the MENU button.

- The selection mode will turn off and the Transfer Order menu will reappear.



- Images are transferred in order from oldest to newest by the shooting date.
- A maximum of 998 images can be marked per CF card.

Downloading Images to a Computer

Download images taken with the camera to a computer in one of the following ways:

- Connect the camera to a computer with the USB cable
You can then download images directly from the camera to a computer.
- Directly from the CF card
Using a card adapter or a card reader, you can download images directly from the CF card.

Connecting the Camera to a Computer Via the USB Cable

IMPORTANT

You must install the software and driver bundled on the supplied Canon Digital Camera Solution Disk onto your computer if you are using any of the following operation systems:

Windows 98 (including Second Edition)/Windows 2000/
Windows Me/Mac OS 9.0 – 9.2

After the software is installed, you can use it to easily download images and print them or send them by e-mail.

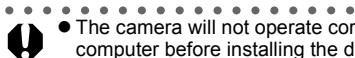

- The camera will not operate correctly if you connect it to your computer before installing the driver and software. If this happens, please refer to the *Troubleshooting* section of the *Software Starter Guide*.

1 Install the driver and the software applications bundled on the Canon Digital Camera Solution Disk.

- Please see the *Software Starter Guide* for information on system requirements and installation instructions.

2 Connect the supplied interface cable to the computer's USB port and the camera's **DIGITAL** terminal.

- You do not need to turn off the computer or camera when making a USB connection.
- Please refer to your computer manual for information regarding the location of the USB port.
- The camera's LCD monitor (or viewfinder) will blank out when the connection to the computer is complete and the power/mode indicator will light yellow.

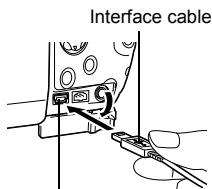
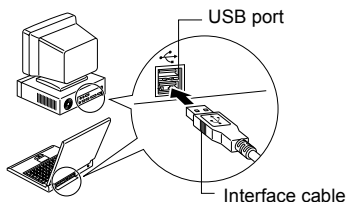

DIGITAL terminal

1. Open the terminal cover with your fingernail.
2. Hold the USB connector so the ← side is up, then insert it into the **DIGITAL** terminal securely.

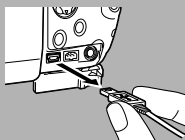

To disconnect the cable from the camera: Hold the cable connector firmly at both sides and pull it straight out.

For information about what to do after making the connection, please refer the *Software Starter Guide*.

Downloading Images without Installing the Software (Windows XP and Mac OS X (v.10.1 or v.10.2) only)

If you are using Windows XP or Mac OS X (v.10.1 or v.10.2), you can use the software distributed with these operating systems to download images (JPEG format only) without installing the software bundled on the Canon Digital Camera Solution Disk. This is useful for downloading images to a computer in which the software is not installed.

However, please note that there are certain limitations to downloading images with this method. For more details, please refer to the supplied *For Windows® XP and Mac OS X Users* leaflet.

1. Connect the supplied interface cable to the computer's USB port and the camera's **DIGITAL** terminal. (Refer to Step 2 of page 150)
2. Follow the onscreen instructions to download the images.



- It is recommended to power the camera with the separately sold Compact Power Adapter CA-560 when connected to a computer (p. 182).
- All procedures performed with a connection to a USB 2.0 compliant board are not guaranteed.

Downloading Directly from a CF Card

1

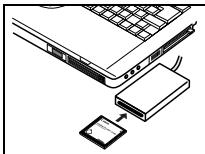

Eject the CF card from the camera, and insert it into a CF card reader connected to the computer.

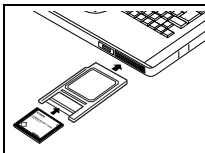

- If you are using a PC card reader or PC card slot in your computer, first insert the CF card into a PC card adapter (sold separately), and then insert the PC card adapter into the computer's PC card reader or PC card slot.

2

Double-click the icon of the drive with the CF card.

3

Copy images from the card into a folder of your choice on the hard disk.

- The images are stored in the [xxxCANON] folders located under the [DCIM] folder (where xxx is a three-digit number from 100 to 998) (p. 120).

Viewing Images on a TV Set

A video-compatible television connected via the supplied AV cable AVC-DC300 can be used to view images as you shoot or replay them.

1 Turn off the camera (p. 30).

- Also turn the television off.

2

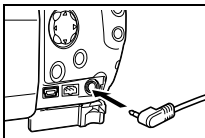

Attach AV Cable AVC-DC300 to the AV OUT terminal on the camera.

3

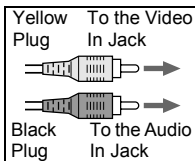

Plug the other ends of the AV cable to the video in and audio in jacks on the TV.

4

Turn on the TV and switch it to Video mode.

5

Turn the mode lever to  or  (p. 29, 30).

- The image will appear on the TV. Shoot or play back images as usual.



- No image will appear on the LCD monitor (or in the viewfinder) when the camera is connected to a TV monitor.
- The video output signal can be switched (NTSC or PAL) to accommodate different regional standards (p. 50). The default setting will vary between regions.
NTSC: Japan, U.S.A., Canada, Taiwan, etc.
PAL: Europe, Asia (excluding Taiwan), Oceania, etc.
If an incorrect video system is set, the output image will not display properly.
- If the TV is a stereo model, you can plug the audio plug into either the left or right Audio In jack. Please refer to the TV's manual for details.
- A TV set cannot be used in  mode.

Customizing the Camera (My Camera Settings)

My Camera allows you to customize the start-up image and start-up, shutter, operation and self-timer sounds. Each menu item has three choices.

e.g. Start-up image



[1]

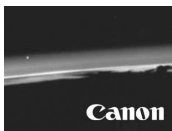

[2]



[3]

The [2] option features science fiction related images and sounds. The [3] option features animals.

Changing My Camera Settings

1 Turn on the camera and press the MENU button.

- The [Rec.] or [Play] menu appears.

2 Select the [My Camera] menu using the ► arrow on the omni selector.

- Pressing the JUMP button also switches between the menu tabs.



3 Select a menu item using the ▲ or ▼ arrow on the omni selector, then select setting content using the ◀ or ▶ arrow on the omni selector.

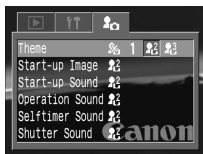



4 Press the MENU button.

- Pressing the **MENU** button closes the menu and makes the settings take effect.
- In Shooting mode, the menu can be closed by pressing the shutter button halfway. (In Playback mode, the menu closes when the shutter button is pressed halfway and the camera switches to shooting mode.)



- If you select [Theme] in Step 3, you can select a consistent theme for each of the My Camera Settings.
- If [Mute] in the [**ff**] (Set up) menu is set to [On], no sound is reproduced even if each sound item such as [Start-up Sound], [Shutter Sound], [Operation Sound] and [Selftimer Sound] is set to another setting than [**ff**] (Off). (Note that the error warning sound beeps even when the Mute setting is [On].)

Registering the My Camera Settings

Images recorded onto the CF card and newly recorded sounds can be added as My Camera settings to the [] and [] menu items. You can also use the supplied software to upload your computer's images and sounds to the camera.



The following menu items can be saved to the camera.

- Start-up Image
- Start-up Sound
- Operation Sound
- Selftimer Sound
- Shutter Sound

Registering CF Card Images and Sounds





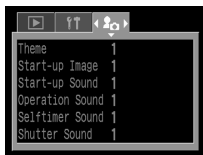

1 Turn the mode lever to  (Playback) and press the **MENU** button.

- The [] (Play) menu appears.

2 Select the [] (My Camera) menu using the  arrow on the omni selector.

- Pressing the **JUMP** button also switches between the menu tabs.



3 Select the menu item you wish to register using the  or  arrow on the omni selector, then select [] or [] using the  or  arrow on the omni selector.

- []  appears.

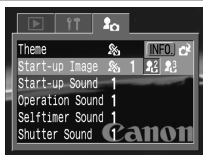

4 Press the **INFO.** button.

- An image appears.
[Start-up Image] → Step 5a, 6a
[Start-up Sound], [Shutter Sound],
[Operation Sound], [Selftimer Sound] →
Step 5b, 6b



File Format of My Camera Settings

My Camera settings should conform to the below file formats. However, CF card images shot with this camera can be registered as My Camera settings regardless of the below formats.

● Start-up Image

- Recording image format JPEG (Base line JPEG)
- Sampling rate 4:2:0 or 4:2:2
- Image size 320 x 240 pixels
- File size 20 KB or less

● Start-up Sound, Operation Sound, Selftimer Sound and Shutter Sound

- Recording format WAVE (monaural)
- Quantization bit 8 bit
- Sampling frequency 11.025 kHz and 8.000 kHz
- Recording time

	11.025 kHz	8.000 kHz
Start-up Sound	1.0 sec. or less	1.3 sec. or less
Operation Sound	0.3 sec. or less	0.4 sec. or less
Selftimer Sound	2.0 sec. or less	2.0 sec. or less
Shutter Sound	0.3 sec. or less	0.4 sec. or less

Any file format other than those described above cannot be used with this camera.

An example of this function is to record "Say cheese" as a self-timer sound so the camera will replay this sound 2 seconds before the photo is taken. You could also record cheerful music to bring out the natural smiles of your subjects, or so they can strike a pose fitting the music. In these ways you can customize your camera by creating and adding new My Camera settings.

See the supplied *Software Starter Guide* for more information on creating and adding My Camera files.



List of Error/Message Codes

The following error and message codes may appear on the display panel.

Error Codes

E_{xx} (XX: number)	: The camera has experienced a problem. Turn off the power, wait a second, and then try shooting or playing back. If the error code appears repeatedly, there is a problem. Note the error code number and take the camera in for servicing. If an error code appears immediately after a shot, there is a chance that the image was not recorded. Check the image in playback mode.
---------------------------------------	--

Message Codes

P_b	: Playing back image.
P_C	: Connected to computer in PC connection mode.
	: Adequate battery charge.
	: Low battery charge. Charge the battery as soon as possible to use for any length of time.
	: Battery charge low, camera will not operate. Immediately recharge or replace the battery pack with a charged one.
L_b	
CF	: No CF card in camera, CF card/battery cover is open, or CF card error.
LENS	: Power turned on while holding the lens. Turn power off and on again.
Int	: Intervalometer is set (shoots images automatically at set time intervals). (The number of remaining shots display after the first images is shot.)

List of Messages





The following messages may appear on the LCD monitor (or in the viewfinder).

- For messages which may appear when a printer is connected, refer to the *Direct Print User Guide*.

Resetting:	Resetting all the camera and menu settings to default
Busy... :	Image is being recorded to, or read from, CF card. Resetting settings to default.
No memory card:	You attempted to shoot or play back images without a CF card installed.
Cannot record!:	You attempted to shoot an image without a CF card installed.
Memory card error!:	CF card has experienced an anomaly.
Memory card full:	CF card is too full to accommodate more images or print settings.
Naming error!:	The file could not be created because there is a file with the same name as the directory that the camera is attempting to create, or the highest possible file number has already been reached. In the Set up menu, please set [File No. Reset] to [On]. After you save all the images you wish to retain onto a computer, format the CF card (p. 139). Please note that formatting will erase all the existing images and other data.
Change the battery pack:	Battery charge is insufficient to operate the camera. Replace it immediately with a charged battery pack or recharge it.
No image:	No images recorded on CF card.
Image too large:	You attempted to play back an image larger than 4064 x 3048 pixels.
Incompatible JPEG format:	You attempted to play back an incompatible JPEG file.
Corrupted data:	You attempted to play back an image with corrupted data.
RAW:	You attempted to play back an image recorded in an incompatible RAW format.

Cannot magnify!:	You attempted to magnify an image that was photographed with another camera, recorded in a different format, or edited on a computer.
Cannot rotate:	You attempted to rotate an image that was photographed with another camera, recorded in a different format, or edited on a computer.
Unidentified Image:	You attempted to play back an image that was recorded in a special format (proprietary format used by the camera of another manufacturer, etc.) or a movie clip recorded by another camera.
Incompatible WAVE format:	Cannot attach sound memos to the image because the image has some sound file recorded in an inappropriate format.
Protected!:	You attempted to erase a protected image.
Too many marks:	Too many images have been marked with print settings, transfer settings or slide show settings. Cannot process any more.
Unselectable image:	You attempted to set the print settings for a non-JPEG file.
Cannot complete!:	Couldn't save the print, transfer or slide show settings.
Cannot edit:	Slide show settings file is corrupted.
Cannot register this image!:	You attempted to register an image recorded with another camera or shot in the RAW format as a start-up image.
Cannot change!:	You attempted to change to the RAW format an image that was shot with the digital zoom or that was already recorded in the RAW format.

Troubleshooting

Problem	Cause	Solution
Camera will not operate	Power is not turned on	<ul style="list-style-type: none"> ● Turn on the camera. → <i>Turning the Power On/ Off</i> (p. 29)
	CF card/battery cover opened	<ul style="list-style-type: none"> ● Confirm that the CF card/ battery cover is securely closed.
	Insufficient battery voltage ([ ]) lights in display panel)	<ul style="list-style-type: none"> ● Fully charge the battery before installing it in the camera. ● Use a compact power adapter.
	Poor contact between camera and battery terminals	<ul style="list-style-type: none"> ● Wipe the terminals with a clean, dry cloth.
Camera will not record	Camera is in playback or computer/printer connection mode	<ul style="list-style-type: none"> ● Switch the camera to Shooting mode. → See <i>Switching between Shooting and Playback</i> (p. 31). ● During a computer or printer connection, disconnect the interface cable before switching the camera to shooting mode.
	Flash is charging (Blinking  on LCD monitor/in viewfinder)	<ul style="list-style-type: none"> ● Wait until  stops blinking and lights steadily, signaling that the flash is charged, then press the shutter button.
	CF card full	<ul style="list-style-type: none"> ● Insert a new CF card. ● If required, download the images to a computer and erase them from the CF card to make space.

Problem	Cause	Solution
Camera will not record	CF card not formatted correctly	<ul style="list-style-type: none"> ● Format CF card. → See <i>Formatting a CF Card</i> (p. 139). ● If reformatting doesn't work, the CF card logic circuits may be damaged. Contact the nearest Canon Customer Support Help Desk.
Cannot play back	You attempted to play back images shot with another camera or images edited at a computer.	<ul style="list-style-type: none"> ● Computer images can be added to the camera using the bundled software program ZoomBrowser EX or ImageBrowser. See the <i>ZoomBrowser EX/ImageBrowser Software User Guide</i> (PDF).
	File name was changed with a computer or file location was changed.	<ul style="list-style-type: none"> ● Set the file name or location to the file format/structure of the camera. (See <i>About File and Folder Numbers</i> (p. 120).)
Lens will not retract	CF card/battery cover opened with camera on	<ul style="list-style-type: none"> ● Close the CF card/battery cover, then turn off the camera.
	CF card/battery cover opened while camera was recording to CF card (warning signal)	<ul style="list-style-type: none"> ● Close the CF card/battery cover, then turn off the camera.
Battery pack consumed quickly	Battery pack capacity reduced because of disuse for one year or more after being fully charged	<ul style="list-style-type: none"> ● Replace the battery pack with a new one.
	Battery life exceeded	<ul style="list-style-type: none"> ● Replace the battery pack with a new one.
Battery pack will not charge	Battery life exceeded	<ul style="list-style-type: none"> ● Replace the battery pack with a new one.



Troubleshooting (continued)

Problem	Cause	Solution
Battery pack will not charge	Poor contact between battery pack and battery charger	<ul style="list-style-type: none"> ● Clean the battery terminals with a clean dry cloth. ● Attach the battery pack to the battery charger securely. ● Insert the plug of the battery charger firmly into the power outlet.
Image is blurred or out of focus	Camera moved	<ul style="list-style-type: none"> ● Be careful not to move the camera when pressing the shutter button. ● Use a tripod at slow shutter speeds when the camera shake warning  appears.
	Subject out of focal range	<ul style="list-style-type: none"> ● Ensure that there is at least 50 cm (1.6 ft.) between the camera lens and subject. ● Use Macro mode when the distance to the subject is as follows: 10 – 50 cm (3.9 – 1.6 ft) (Wide angle end – 63 mm)* 30 – 50 cm (1.0 – 1.6 ft) (63 – 90 mm)* ● You can also use Super Macro mode when the distance to the subject is 3 to 30 cm (1.2 in. to 1.0 ft.) (42 to 90 mm)*. <p>* Zoom position (35mm film equivalent)</p>
	Subject is hard to focus on	<ul style="list-style-type: none"> ● Use the focus lock or the manual focus to shoot the image. → See <i>Shooting Problem Subjects for the Autofocus</i> (p. 112).

Problem	Cause	Solution
Subject in recorded image is too dark	Insufficient light for shooting	<ul style="list-style-type: none"> ● Set the built-in flash to on. ● Use a high-output externally mounted flash.
	Subject dark in comparison to the background	<ul style="list-style-type: none"> ● Set the exposure compensation to a positive (+) setting. ● Use the AE lock or spot metering function. → See <i>Locking the Exposure Setting (AE Lock)</i> (p. 104) and <i>Switching between Light Metering Modes</i> (p. 90).
	Subject too far for flash to reach	<ul style="list-style-type: none"> ● To use the built-in flash, shoot within 50 cm to 5.0 m (1.6 to 16 ft.) of the subject at the maximum wide angle and within 1 to 3.5 m (3.3 to 11 ft.) at the maximum telephoto setting. ● Use an externally mounted flash with a large output. ● Raise the ISO sensitivity and then shoot. → See <i>Changing the ISO Speed</i> (p. 99).
	The ND filter is On.	<ul style="list-style-type: none"> ● Set [ND Filter] to [Off]. → See <i>Using the ND Filter</i> (p. 118).

Troubleshooting (continued)

Problem	Cause	Solution
Subject in recorded image is too bright	Subject too close causing flash to be too bright	● Adjust the flash output with the flash exposure compensation function (p. 107).
	Subject bright in comparison to the background	● Set the exposure compensation to a negative (-) setting. ● Use the AE lock or spot metering function. → See <i>Locking the Exposure Setting (AE Lock)</i> (p. 104) and <i>Switching between Light Metering Modes</i> (p. 90). ● Set [ND Filter] to [On]. → See <i>Using the ND Filter</i> (p. 118).
	Light shining directly on subject or reflected off subject into camera	● Change the shooting angle.
	Flash set to On	● Set the flash to Auto or Off.
A vertical bar of light (red, purple) appears on the LCD monitor/ in the viewfinder	Subject too bright	● This is a normal occurrence in devices containing CCDs and does not constitute a malfunction. (This red bar of light will not be recorded when shooting still photos, but it will be recorded when shooting movies.)

Problem	Cause	Solution
White dots or white asterisks appear on the image	Light from the flash has reflected off dust particles or insects in the air. This occurs more frequently in the following conditions: <ul style="list-style-type: none"> • When shooting at the wide angle end. • When shooting with a high aperture value in the aperture-priority AE mode. 	● This is a phenomenon that occurs with digital cameras and does not constitute a malfunction.
Flash will not fire	Flash set to Off	● Set the flash to Auto or On.
Image not showing on TV	Incorrect video system setting	● Set the video system to the appropriate setting, NTSC or PAL, for your TV (p. 50).
	Shooting mode set to  (Stitch Assist)	● The output will not appear on a TV monitor in  (Stitch Assist) mode. Shoot in a different mode.
Zoom will not operate	Zoom ring turned while shooting in movie mode	● Operate the zoom before shooting in movie mode.
	[Convert] set to other than [None]	● If any conversion lens is mounted, remove it and set [Converter] to [None]. → See <i>Setting the Camera Lens to the Most Appropriate Position</i> (p. 180).
	Camera set to Super Macro mode	● Cancel Super Macro mode. → See <i>Super Macro Mode</i> (p. 75).
CF card image reading is slow Recording images on the CF card takes too long	Currently used CF card has been formatted in a different device.	● Use a CF card formatted with this camera. → See <i>Formatting a CF Card</i> (p. 139).

Using the Wireless Controller

Installing the Battery

Install the date battery (CR2025) into the Wireless Controller WL-DC100 before use.



- Be particularly careful to keep the date batteries out of the reach of children. Seek medical assistance immediately if a child swallows a battery since corrosive battery fluids could damage the stomach or intestinal wall.

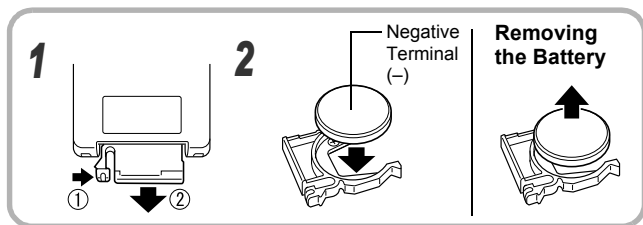

1 Place your fingertip on ① and press it in the direction of the arrow while placing another fingertip on ② and removing the battery holder.

2 Place the date battery in the battery holder with the negative terminal (-) facing up. Then replace the battery holder into the wireless controller.

Removing the Battery

To remove the date battery, pull it in the direction of the arrow.

If you ever dispose of your camera, first remove the date battery for recycling according to the recycling system of your country.



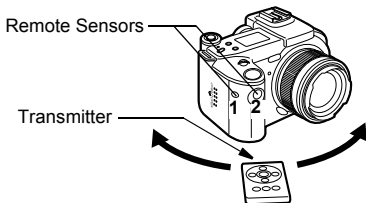

Shooting/Playback

The wireless controller can be used to shoot or play back. The wireless controller can be operated from an approximate distance of up to 5 m (16.4 ft.) from the front remote sensor (2) and approximately 1 m (3.3 ft.) from the side remote sensor (1).



When Macro Ring Lite MR-14EX or Macro Twin Lite MT-24EX is mounted on the camera, it will block the front remote sensor 2. In this case, aim the wireless controller toward the side remote sensor 1.

● Shooting

Press the / button on the camera until the  icon appears in the display panel, then shoot the image.

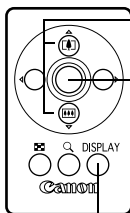

① Compose the image with the zoom ring.

② Press the shutter button. The camera will shoot the image after the time set in [Wireless Delay] in the Rec. menu has elapsed (0 seconds, 2 seconds or 10 seconds).

● Each press of this button switches the information view mode between No Information and Information View.

● Playback

 appears on the display panel.

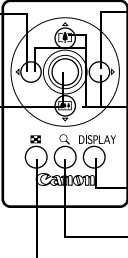
- Display the previous image
 - Display the next image
 - In magnified mode, these buttons move the magnified area around the image.
 - In index playback, these buttons move the image selection.
 - Each press of this button cycles the information view mode.
 - The display cycles between magnifications of approximately 2.5, 5 and 10.
 - Display images in sets of nine (index playback).
- 



- The operable range of the wireless controller will shorten under the following circumstances.
 - When the wireless controller is used at an angle to the remote sensor.
 - When strong light strikes the camera.
 - When the battery is weak.



- The movie editing and printing functions are not available.
- When you fix the camera to a tripod and shoot still images, aim the remote controller's transmitter at remote sensor 1 (see the first illustration on page 169) to operate the camera from the side without touching the camera. This prevents camera shake when shooting just like using a remote release. You should set [Wireless Delay] in the Rec. menu to [0 sec.] when you use this method.

Using an Externally Mounted Flash (Sold Separately)

You can make your flash photography even clearer and more natural appearing with the use of a separately sold externally mounted flash.

The camera's auto exposure function will operate with a Canon Speedlite 220EX, 380EX, 420EX, 550EX, a Macro Ring Lite MR-14EX or a Macro Twin Lite MT-24EX (p. 174). (Except with the **M** mode or when [Flash Adjust] is set to [Manual].) Other flashes may fire manually or not fire at all.

Please check the manual for your flash.

* Certain functions noted in the manuals for the Canon Speedlite 220EX, 380EX, 420EX, 550EX, the Macro Ring Lite MR-14EX and Macro Twin Lite MT-24EX cannot be performed when mounted on this camera. Please read this guide before using one of these flashes on the camera.

1

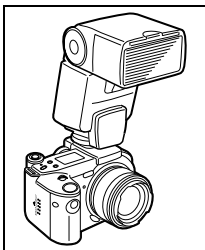





Attach the flash to the camera's hot shoe.

2

Turn the external flash on and turn the mode lever to  (Shooting).

3 Turn the mode dial to a position other than or .

Speedlite 220EX, 380EX, 420EX, 550EX, Macro Ring Lite MR-14EX or Macro Twin Lite MT-24EX

- The flash will automatically adjust its output in the **AUTO**, , , , , **P**, **Tv** and **Av** modes when [Flash Adjust] is set to [Auto]. The maximum flash synchro shutter speed is 1/250 second.
- In **M** mode or when [Flash Adjust] is set to [Manual], the flash will fire with manual adjustments. The maximum flash synchro shutter speed in this case is 1/250 second. Set the aperture to an appropriate value according to the flash's guide number and the distance to the subject. Check the camera's ISO sensitivity setting since the flash's guide number will change with the ISO value.
- When [Flash Adjust] is set to [Manual], the flash output can be adjusted. When [Flash Adjust] is set to [Auto] the flash exposure compensation can be adjusted (p. 107).
- In **M** mode or when [Flash Adjust] is set to [Manual], the output of an externally mounted flash can be adjusted in the flash output adjustment screen (p. 108). When a Speedlite 550EX, a Macro Ring Lite MR-14EX or a Macro Twin Lite MT-24EX is mounted on the camera, you can adjust the flash output from either the flash or the camera. (The flash setting overrides the camera setting when both are set.) To set it from the flash, you are recommended to use the flash's manual mode. You can also adjust the flash output even when the camera is set to the E-TTL automatic flash exposure compensation mode by changing the flash exposure compensation setting. In this situation, the +2 step setting fires the flash at full intensity.

To shoot with the flash, you are recommended to set the white balance to the  **WB** (Flash) setting.

Other Canon Flashes

- Since other flashes fire at full strength, set the shutter speed and aperture accordingly. Set the shutter speed to 1/125 second or slower, and set the aperture to a value appropriate to the flash's guide number and the distance to the subject.



You are recommended to set the white balance to  **WB** (Flash) to shoot.

4 Press the shutter button halfway.

- The flash is charged when its pilot lamp lights up.
-

5 Press the shutter button all the way to shoot the image.



- The externally mounted flash will not fire in ,  or continuous shooting.
- The Bracket mode cannot be used for flash photography. If the flash fires, only one image gets recorded.
- Flashes (especially high-voltage flashes) or flash accessories made by other manufacturers may override certain camera functions or cause a camera malfunction.



- The following functions can be used with a Speedlite 220EX, 380EX, 420EX or 550EX.
 - Auto Exposure (Use the E-TTL mode with a 550EX)
 - FE Lock (Not available in **M** mode)
 - Flash Sync (1st-curtain/2nd-curtain) (2nd-curtain priority with Speedlite 550EX)
 - Daylight Synchro
 - Slow Synchro
 - Flash Exposure Compensation (When Speedlite 550EX is used, if flash exposure adjustments are made both from the camera and the flash, the 550EX's flash exposure compensation setting takes precedence when the flash is set to E-TTL mode. The camera's flash exposure compensation setting will not activate.)
 - Auto Zoom (Not available with the 220EX)

How to Mount Macro Ring Lite MR-14EX and Macro Twin Lite MT-24EX

The separately sold Conversion Lens Adapter LA-DC58C is required to mount Macro Ring Lite MR-14EX or Macro Twin Lite MT-24EX on the camera.

- Conversion Lens Adapter LA-DC58C can be divided into the rear and front parts. Normally, it should be used joined together. However, if you wish to use the whole range of the zoom, remove the front part and attach only the rear part to the camera.

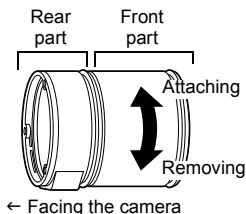

⊘ When Only the Rear Part of Conversion Lens Adapter LA-DC58C is Used

- Never attach any filters or close-up lenses. The lens hits the filter or close-up lens when zoomed in and that may cause damage.

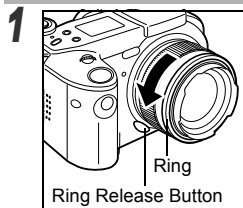

Turn off the camera. Then press and hold the ring release button and remove the outer ring on the lens.

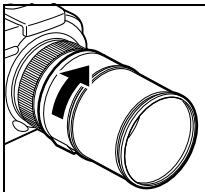
2

Attach the conversion lens adapter so that its ● meets the lens' ● and turn it in the direction of the arrow until ● meets ▲.

- If you plan to attach Close-up Lens 500D (p. 178), do it after you attach this adapter.

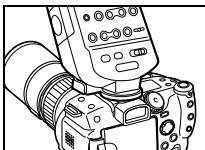
3

Attach the controller to the camera's hot shoe.

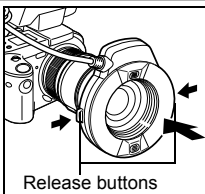
4

Macro Ring Lite MR-14EX
Press and hold the release buttons on both sides of Macro Ring Lite MR-14EX and fit it into the conversion lens adapter.

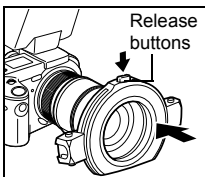

Macro Twin Lite MT-24EX
Press and hold the release button on the top of the external ring and fit it into the conversion lens adapter.

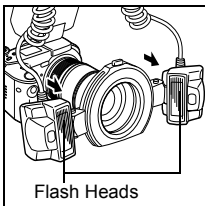

- Attach the flash heads to their respective flash head mounts.

5 Press the  button to set the camera to Macro mode and set [ND Filter] to [On].

- Macro mode (p. 73)
- ND filter (p. 118)



- When Macro Ring Lite MR-14EX or Macro Twin Lite MT-24EX is mounted on the camera using Conversion Lens Adapter LA-DC58C with its two parts joined, shooting in wide angle could cause dark shadows on the image.
- When Macro Ring Lite MR-14EX or Macro Twin Lite MT-24EX is mounted on the camera using only the rear part of Conversion Lens Adapter LA-DC58C, shooting in telephoto could block flash light.
- When you are using Macro Ring Lite MR-14EX or Macro Twin Lite MT-24EX, you can shoot in E-TTL automatic flash exposure compensation mode just by setting the camera's shooting mode to **P**, **Av** or **Tv**.
You are recommended to set the aperture in **Av** or **M** mode for full-fledged macro flash photography.
- The following functions can be used with Macro Ring Lite MR-14EX or Macro Twin Lite MT-24EX mounted.
 - E-TTL Automatic Flash Exposure Compensation
 - FE Lock
 - Flash Sync (1st-curtain/2nd-curtain)
(The flash's 2nd-curtain setting takes precedence.)
 - Daylight Synchro
 - Slow Synchro
 - Flash Exposure Compensation
- When exposure compensation settings are selected on both the camera and the Macro Ring Lite MR-14EX and Macro Twin Lite MT-24EX, the macro ring lite setting takes precedence (when in E-TTL mode) and the camera setting is overridden.

Tele-converter TC-DC58A

This 58 mm-threaded diameter magnifying conversion lens is for taking telephoto shots. The lens changes the focal length of the camera body's lens by a factor of 1.5x.



- Use the tele-converter lens with the focal length set to the maximum telephoto setting. Using the zoom at other settings may cause dark shadows on the image. If you set [Converter] in the Rec. menu to [TC-DC58A], the zoom will move to the telephoto end automatically (p. 180).
- An externally mounted flash may not automatically adjust its flash coverage when a conversion lens is mounted on the camera.
- Do not attach filters or lens hoods to the tele-converter.
- If you use the built-in flash, a portion of the image appears to be blocked by the lens hood.

Close-up Lens 500D (58 mm)

This lens, with a 58 mm-threaded diameter, makes close-up shooting easier. You can magnify a subject 33 cm (1.0 ft.) away from the tip of the lens more than by using the camera's Macro mode.



- Set the focal length of the camera's lens close to the telephoto end when using the close-up lens. If you set [Converter] in the Rec. menu to [500D], the zoom will move to the telephoto end automatically (p. 180).
- You are recommended to use Macro Ring Lite MR-14EX or Macro Twin Lite MT- 24EX for flash photography with the close-up lens mounted on the camera.
- If you use the built-in flash, a portion of the image appears to be blocked and dark.
- Be sure to use Conversion Lens Adapter LA-DC58C when you attach the close-up lens.
It is possible to attach the close-up lens to the camera using the supplied filter adapter, however, the camera will not shoot properly.

Mounting the Lenses

1

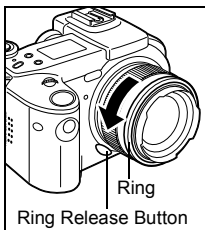

Turn off the camera. Then press and hold the ring release button and remove the outer ring of the lens.

2

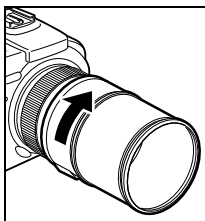

Attach the conversion lens adapter so that its ● meets the lens' ● and turn it in the direction of the arrow until ● meets ▲.

3

Mount the lens by turning it in the direction of the arrow.

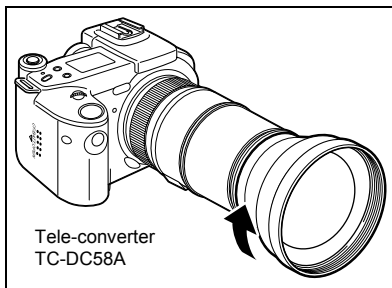

Setting the Camera Lens to the Most Appropriate Position

1 Turn the mode lever to (Shooting) and press the **MENU** button.

- The [ (Rec.)] menu appears.

2 Select [**Converter**] using the **▲** or **▼** arrow on the omni selector, then select the name of the mounted lens using the **◀** or **▶** arrow on the omni selector.

- If you select [TC-DC58A], the zoom moves to the telephoto end. Zoom operation is possible, however, it is limited to the area near the telephoto end.
- If you select [500D], the zoom will be fixed to the telephoto end.

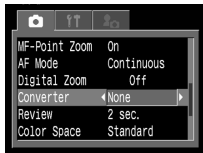

3 Press the **MENU** button.

- The icon of the selected lens in Step 2 appears on the LCD monitor (or in the viewfinder) at the position where the zoom magnifications usually appear. (Zoom magnifications do not appear when you see this icon.)
 - Ⓧ : Tele-converter
 - Ⓞ : Close-up lens
- The [Converter] setting is stored in the camera's memory. Therefore, when you turn on the camera next time, the zoom moves to the telephoto end. Be sure to set [Converter] to [None] after you remove the tele-converter/close-up lens.

Icon of the selected lens





- The distance shown with the MF indicator (p. 114, 115) does not change even if you change the [Converter] setting from [None].
- The camera does not enter Macro mode when [Converter] is set to any setting other than [None]. If the camera is currently in Macro mode, Macro mode will be canceled when [Converter] is set to another setting than [None].
- Please note that the images will not merge properly with the PhotoStitch program on a computer when they are shot in  mode with a conversion or close-up lens.
- To protect the conversion lens, hold the camera's lens with one hand and screw the conversion lens onto the camera with the other hand.
- Completely remove all dust and dirt from conversion lenses with a lens blower brush before use. The camera may focus on any dirt that remains.
- Be careful when handling the lenses so as not to get fingerprints on them.

Using a Compact Power Adapter (Sold Separately)

You should use the separately sold Compact Power Adapter CA-560 when using the camera for long periods of continuous use or for connecting to a computer or printer.

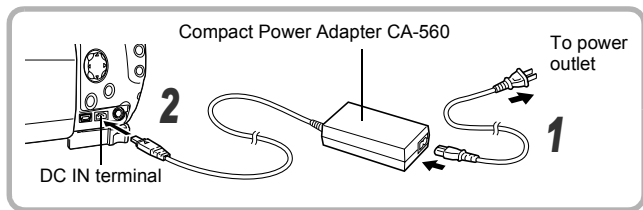

1 Attach the power cord to the compact power adapter and plug it into a power outlet.

2 Open the terminal cover and connect the DC plug of the compact power adapter to the camera's DC IN terminal.

- Always disconnect and unplug the compact power adapter after use.



- Always turn the camera's power off before connecting or disconnecting the compact power adapter.
- Do not use Compact Power Adapter CA-560 with any devices other than those for which Battery Pack BP-511A, Battery Pack BP-511, Battery Pack BP-512 or Battery Pack BP-514 are specified.

Using a Battery Charger (Sold Separately) and Car Battery Cable (Sold Separately)

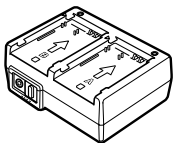

Battery Charger CG-570

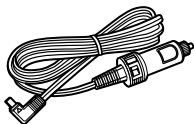

Car Battery Cable CB-570

Combined use of Battery Charger CG-570 (sold separately) and Car Battery Cable CB-570 (sold separately) lets you charge battery packs (up to 2 at the same time) from a car's cigarette lighter socket. It is also possible to charge up to 2 battery packs at the same time from a power outlet if you connect Compact Power Adapter CA-560 (sold separately) or Compact Power Adapter CA-570 (sold separately) to Battery Charger CG-570. Battery Pack BP-511A, Battery Pack BP-511, Battery Pack BP-512 and Battery Pack BP-514 can be charged with these combinations. Refer to each product's manual on how to charge battery packs.

Replacing the Date Battery

If the Set Date/Time menu appears when you turn on the camera power, the date battery charge is low and the date and time settings have been lost. Please replace the battery with a generic CR2016 lithium coin battery with the following procedures.

Please note that the first date battery may appear to expire relatively quickly after you purchase the camera. This is because it is installed in the camera at the point of manufacture, not when you make the purchase.



- Be particularly careful to keep the date batteries out of the reach of children. Seek medical assistance immediately if a child swallows a battery since corrosive battery fluids could damage the stomach or intestinal wall.

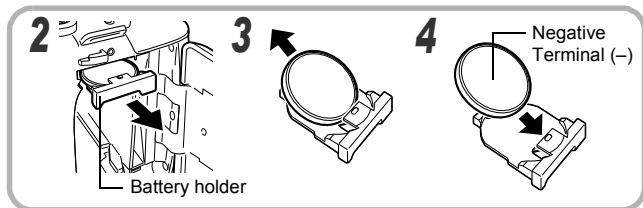

- 1** Turn off the power and open the CF card/battery cover (p. 21).
- 2** Remove the battery pack, then pull out the battery holder by hooking your fingertip under the bottom of the battery holder edge.
- 3** Push up the edge of the date battery with your fingertip, then pull it in the direction of the arrow.
- 4** Place a new date battery into the date battery holder with the negative terminal (-) facing upward.

5 Replace the date battery holder, replace the battery pack and close the battery cover.

If you ever dispose of your camera, first remove the date battery for recycling according to the recycling system of your country.



Camera Care and Maintenance

Use the following procedures to clean the camera body, lens, viewfinder, LCD monitor and other parts.

-
- Camera body** : Wipe the body clean with a soft cloth or eyeglass lens wiper.
-
- Lens** : First use a lens blower brush to remove dust and dirt, then remove any remaining dirt by wiping the lens lightly with a soft cloth.
- Never use synthetic cleansers on the camera body or lens. If dirt remains, contact the nearest Canon Customer Support Help Desk as listed on the separate Canon Customer Support leaflet.
-
- Viewfinder
LCD Monitor** : Use a lens blower brush to remove dust and dirt. If necessary, gently wipe the viewfinder and LCD monitor with a soft cloth or an eyeglass lens wiper to remove stubborn dirt.
- Never rub or press forcefully on the LCD monitor or viewfinder. These actions may damage them or lead to other problems.
-



- Never use thinners, benzene, synthetic cleansers or water to clean the camera. These substances may distort or damage the equipment.

Specifications

All data is based on Canon's testing standard. Subject to change without notice.

PowerShot Pro1

Camera Effective Pixels	Approx. 8.0 million
Image Sensor	2/3-inch CCD (Total number of pixels: Approx. 8.3 million)
Lens	7.2 (W) – 50.8 (T) mm (35mm film equivalent: 28 (W) – 200 (T) mm) f/2.4 (W) – f/3.5 (T)
Digital Zoom	Approx. 3.2x (Up to approx. 22x in combination with the optical zoom)
Viewfinder	Color LCD viewfinder Picture coverage 100% Dioptic adjustment –5.5 to +1.5 m ⁻¹ (dpt equivalent)
LCD Monitor	2.0-inch, low-temperature polycrystalline silicon TFT color LCD (Picture coverage 100%)
AF System	Hybrid autofocus (TTL + external metering sensor) (continuous or single) AF lock and Manual focus are available Focusing frame: 1-point AF (any position is available)
Shooting Distance (from the front of the lens)	Normal AF: 50 cm (1.6 ft.) – infinity (W – 90 mm)* 1 m (3.3 ft.) – infinity (90 mm – T)* Macro AF: 10 – 50 cm (3.9 in. – 1.6 ft.) (W – 63 mm)* 30 – 50 cm (1.0 – 1.6 ft.) (63 – 90 mm)* Super Macro AF: 3 – 30 cm (1.2 in. – 1.0 ft.) (42 – 90 mm)* Manual focus: 10 cm – infinity (3.9 in. – infinity) (W – 63 mm)* 30 cm – infinity (1.0 ft. – infinity) (63 – 90 mm)* 1 m (3.3 ft.) – infinity (90 mm – T)* *Zoom position (35mm film equivalent)
Shutter:	Mechanical shutter + electronic shutter
Shutter Speeds	15 – 1/4000 sec. 1.3 sec. or slower shutter speeds are available in Shutter-priority mode or Manual mode. Slow shutter speeds of 1.3 sec. or slower operate with noise reduction.
Light Metering System	Evaluative, Center-weighted average or Spot (Center or AF-point)

Exposure Control System	Program AE, Shutter-priority AE, Aperture-priority AE or Manual exposure control AE lock is available.
Exposure Compensation	± 2.0 stops in 1/3-stop increments Auto exposure bracketing (AEB) is available.
Sensitivity	Auto, ISO 50/100/200/400 equivalent
White Balance	TTL auto, pre-set (available settings: Daylight, Cloudy, Tungsten, Fluorescent, Fluorescent H or Flash) or custom (Custom1/Custom2)
Built-in Flash	Auto*, on*, off * Red-eye reduction is available.
Flash Range	50 cm – 5.0 m (1.6 – 16 ft.) (W), 1.0 – 3.5 m (3.3 – 11.5 ft.) (T) (When sensitivity is set to ISO 100 equivalent.)
Terminals for External Flash	Sync-terminals on accessory shoe Use of the following external flashes is recommended: Canon Speedlite 220EX, 380EX, 420EX, 550EX, Macro Ring Lite MR-14EX and Macro Twin Lite MT-24EX.
Flash Exposure Compensation	±2.0 stops in 1/3-stop increments, FE Lock, Slow synchro and 1st-curtain/2nd-curtain flash are available.
Shooting Modes	Auto Creative zone: Program, Shutter-speed priority, Aperture priority, Manual, Custom1 and Custom2 Image zone: Portrait, Landscape, Night scene, Stitch assist and Movie
Continuous Shooting	High-speed: Approx. 2.5 shots/sec. Standard: Approx. 1.0 shots/sec. (Large/Fine mode)
Interval Shooting	Shooting interval: approx. 1 – 60 min. (1-min. increments) Number of shots: 2 – 100 shots (Maximum number of shots varies according to CF memory card capacity.)
Self-timer	Activates shutter after an approx. 10-sec./approx. 2-sec. delay

(W): Wide angle end/(T): Telephoto end

Wireless Control	Shooting and playback are available (wireless controller is included in the camera kit). When shooting, image is captured instantly/ approx. 2-sec./approx. 10-sec. after shutter button is pressed.
PC-controlled Shooting	Available (USB connection only. Exclusive software program is included in the camera kit.)
Recording Media	CompactFlash™ (CF) card (Type I and Type II)
File Format	Design rule for camera file system and DPOF compliant
Image Recording Format	Still images: JPEG (Exif 2.21)** or RAW Movies: AVI (Image data: Motion JPEG; Audio data: WAVE (monaural))
Color Space	Standard or Adobe RGB
Compression	Super fine, Fine, Normal
Number of Recording Pixels	Still images: Large: 3264 x 2448 pixels Medium 1: 2272 x 1704 pixels Medium 2: 1600 x 1200 pixels Medium 3: 1024 x 768 pixels Small: 640 x 480 pixels Movies: 640 x 480 pixels (approx. 30 sec.)* 320 x 240 pixels (approx. 3 min.)* 160 x 120 pixels (approx. 3 min.)* 15 frames/second * The data in parentheses refer to the maximum movie length per shooting.
Playback Modes	Single (histogram displayable), Index (9 thumbnail images), Magnified (approx. 10x (max.) in LCD monitor/viewfinder), Sound memos (up to 60 sec.) or Slide show.
Direct Print	<i>Canon Direct Print/Bubble Jet Direct/PictBridge</i> compatible
Display Languages	12 languages available for menus and messages (English, German, French, Dutch, Danish, Finnish, Italian, Norwegian, Swedish, Spanish, Chinese and Japanese)

My Camera Settings	The start-up image, start-up sound, shutter sound, operation sound and self-timer sound can be customized using the following methods: <ol style="list-style-type: none"> 1. Using the images and sounds recorded on a camera. 2. Using downloaded data from your computer using the supplied software.
Interface	USB (mini-B, PTP [Picture Transfer Protocol]) Audio/Video output (NTSC or PAL selectable, monaural audio)
Power Source	<ol style="list-style-type: none"> 1. Rechargeable lithium-ion battery (type: BP-511A) (included in the camera kit/sold separately) 2. Rechargeable lithium-ion battery (type: BP-511/512/514) (sold separately) 3. Compact Power Adapter (CA-560) (sold separately) 4. Car battery adapter (separately sold Charge Adapter/Car Battery Cable Kit CR-560 is required)
Operating Temperature	0 – 40 °C (32 – 104 °F)
Operating Humidity	10 – 90%
Dimensions	117.5 x 72.0 x 90.3 mm (4.6 x 2.8 x 3.6 in.) (Excluding viewfinder eyepiece and protrusions)
Weight:	Approx. 545 g (19.2 oz.) (camera body only)

*1 This digital camera supports Exif 2.21 (also called “Exif Print”). Exif Print is a standard for enhancing the communication between digital cameras and printers. By connecting to an Exif Print-compliant printer, the camera’s image data at the time of shooting is used and optimized, yielding extremely high quality prints.

Battery Performance

	Number of Images Shot		Playback Time
	LCD Monitor On	Viewfinder On	
Battery Pack BP-511A (Fully charged)	Approx. 420 images	Approx. 420 images	Approx. 400 minutes

- The data above reflects standard Canon testing conditions. The actual figures will vary according to the shooting conditions and settings.
- Movie data is excluded.
- At low temperatures, the battery pack performance may diminish and the low battery icon appear very rapidly. In these circumstances, the performance can be improved by warming the battery pack in a pocket before use.

<Test Conditions>

Shooting: Normal temperature (23 °C, 73 °F), alternating wide angle end and telephoto end shots at 20-second intervals with flash fired once every four shots and camera power turned off and on every eighth shot. CF card used.



















Playback: Normal temperature (23 °C, 73 °F), continuous playback at one image per 3 seconds. CF card used.



- *Battery Pack Handling Precautions* (p. 19)

CF Cards and Estimated Capacities (Recordable Images)

 CF card included with the camera

		FC-32M	FC-64MH	FC-128M	FC-256MH	FC-512MSH	
L (Large) 3264 x 2448 pixels		8	17	35	72	144	
		14	29	59	120	240	
		30	62	125	252	503	
M1 (Medium 1) 2272 x 1704 pixels		14	30	61	123	247	
		27	54	110	222	442	
		54	110	220	443	879	
M2 (Medium 2) 1600 x 1200 pixels		30	61	122	246	491	
		54	109	219	440	879	
		108	217	435	868	1734	
M3 (Medium 3) 1024 x 768 pixels		53	107	215	431	855	
		94	189	379	762	1522	
		174	349	700	1390	2714	
S (Small) 640 x 480 pixels		120	241	482	962	1891	
		196	393	788	1563	3122	
		337	676	1355	2720	5203	
RAW	3264 x 2448 pixels	2	6	13	26	54	
Movie	640 x 480 pixels		30 sec	61 sec	124 sec	249 sec	499 sec
	320 x 240 pixels		91 sec	183 sec	368 sec	735 sec	1451 sec
	160 x 120 pixels		242 sec	486 sec	973 sec	1954 sec	3902 sec













- The display panel can only display 3 digits. (Any value exceeding “1000” will appear as “999”.)
- These figures reflect standard shooting conditions established by Canon. Actual totals may vary according to the subject, shooting conditions and shooting mode.
- The following are the approximate maximum recording times for movie clips:
: 30 seconds, : 3 minutes, : 3 minutes. The maximums in the chart reflect continuous shooting.
-  (Superfine),  (Fine) and  (Normal) indicate the relative compression ratio.
- Some CF cards are not sold in some regions.

Image File Sizes (Estimated)

Resolution	Compression		
			
L (3264 x 2448 pixels)	3436 KB	2060 KB	980 KB
M1 (2272 x 1704 pixels)	2002 KB	1116 KB	556 KB
M2 (1600 x 1200 pixels)	1002 KB	558 KB	278 KB
M3 (1024 x 768 pixels)	570 KB	320 KB	170 KB
S (640 x 480 pixels)	249 KB	150 KB	84 KB
RAW (3264 x 2448 pixels)	9020 KB		
 (640 x 480 pixels)	990 KB/sec		
Movie  (320 x 240 pixels)	330 KB/sec		
 (160 x 120 pixels)	120 KB/sec		

Battery Charger CG-580*

Input voltage:	AC 100 V – 240 V (50/60 Hz) 22 VA (100 V) – 30 VA (240 V)
Rated output:	DC 8.4 V, 1.2 A
Operating temperatures:	0 – 40 °C (32 – 104 °F)
Dimensions:	91 x 31 x 67 mm (3.6 x 1.2 x 2.6 in.)
Weight:	Approx. 115 g (4.1 oz.)

Battery Charger CB-5L*

Input voltage:	AC 100 V – 240 V (50/60 Hz)
Rated output:	DC 8.4 V
Operating temperatures:	0 – 40 °C (32 – 104 °F)
Dimensions:	67 x 32.3 x 91 mm (2.6 x 1.3 x 3.6 in.)
Weight:	Approx. 105 g (3.7 oz.)

* Sold separately in some regions.

Battery Pack BP-511A

Type:	Rechargeable lithium ion cell
Nominal voltage:	7.4 V
Nominal capacity:	1390 mAh
Charge cycles:	Approx. 300
Operating temperatures:	0 – 40 °C (32 – 104 °F)
Dimensions:	38 x 55 x 21 mm (1.5 x 2.2 x 0.8 in.)
Weight:	Approx. 82 g (2.9 oz.)

Wireless Controller WL-DC100

Power supply:	Lithium button battery CR2025
Operating temperatures:	0 – 40 °C (32 – 104 °F)
Dimensions:	35 x 6.5 x 56.6 mm (1.4 x 0.3 x 2.2 in.)
Weight:	Approx. 10 g (0.4 oz.)

CompactFlash™ Card

Card slot type:	Type I
Dimensions:	36.4 x 42.8 x 3.3 mm (1.4 x 1.7 x 0.1 in.)
Weight:	Approx. 10 g (0.4 oz.)

Compact Power Adapter CA-560 (Sold Separately)

Input voltage:	AC 100-240 V (50/60 Hz) 60 VA (100 V) – 75 VA (240 V)
Rated output:	DC 9.5 V/2.7 A
Operating temperatures:	0 – 40 °C (32 – 104 °F)
Dimensions:	57 x 28 x 104 mm (2.2 x 1.1 x 4.1 in.) (body only)
Weight:	Approx. 180 g (6.3 oz.)

Tele-converter TC-DC58A (Sold Separately)

Magnification:	Approx. 1.5x
Focal length:	Infinity
Lens configuration:	5 elements in 3 groups
Focusing range (from tip of lens):	2.2 m – Infinity (7.2 ft. – Infinity) (when attached to PowerShot Pro1 at 126 mm – telephoto end)
Thread diameter:	58 mm Standard filter threads (Conversion Lens Adapter LA-DC58C is required to install the lens on a PowerShot Pro1)
Dimensions:	Diameter: 92 mm (3.6 in.)/Length: 70 mm (2.7 in.)
Weight:	Approx. 520 g (18.3 oz.)

Close-up Lens 500D (58 mm) (Sold Separately)

Focal length:	500 mm
Focusing range (from tip of lens):	33 – 50 cm (13.0 – 19.7 in.) (when attached to PowerShot Pro1)
Thread diameter:	58 mm Standard filter threads (Conversion Lens Adapter LA-DC58C is required to install the lens on a PowerShot Pro1)
Dimensions:	Diameter: 60 mm (2.4 in.)/Length: 10.5 mm (0.4 in.)
Weight:	Approx. 60 g (2.1 oz.)

A

- Adobe RGB 98
- AEB Mode 100
- AE Lock 104
- AF Frame 53, 89, 90
- AF Mode 47, 116
- Aperture-Priority AE (**Av**) .. 85
- Aperture Value .. 81, 82, 85, 87
- Automated Playback
(Slide Show) 48, 133
- Auto Mode (**AUTO**) 53
- Auto Power Down 50
- Auto Rotate 50, 119

B

- Battery
 - Battery pack change
status 22
 - Charging 18
 - Handling Precautions .. 19
 - Installing 21
 - Performance 190
 - Status 22
- Beep 41, 53
- Black and White Mode 96

C

- CF Card
 - Formatting 50
 - Handling Precautions .. 23
 - Installing 21
 - Recording Capacity ... 191
- CF Card/Battery Cover .. 12, 21
- Close-up Lens 177
- Color Space 48, 98
- Compact Power Adapter .. 182

- Compression 57
- Continuous Shooting () 46, 79
- Contrast 97
- Conversion Lens
 - Adapter 174, 177
- Converter 48, 177
- Creative Zone 14
- Custom Settings 116

D

- Date Battery 168, 184
- Date/Time 26, 50
- Default Setting 46, 52
- Design rule for Camera File
system 188
- Digital Zoom 40, 47, 78
- Display
 - Detailed 38
 - Off 50
 - Standard 37
- Display Panel 16, 159
- Distance Units of the MF
Indicator 50
- DPOF
 - Print Settings 142
 - Transfer Order
(Image Transmission
Settings) 147

E

- Erasing 138
 - All Images 48, 138
 - Single Images 138
- Exposure Compensation ... 92

F

FE Lock	106
File Format	55, 60
File Number	37, 50, 120
Reset	50, 120
Flash	
Exposure	
Compensation	107
Externally Mounted	
Flash	171
Flash Adjust	46, 107
Flash Output	108
Switching the	
Timing	46, 109
Flash Pop-up	
Function	46, 63, 65
Focus Bracketing	
(Focus-BKT Mode)	102
Focus Lock	112
Formatting	50, 52, 139

H

Histogram	39
-----------	----

I

Image Zone	14
Index Playback	124, 170
Indicator	12, 21
Information	
View	34, 36, 169, 170
Intervalometer	48, 110
ISO Speed	99

J

Jump	125
------	-----

L

Landscape Mode ()	66
Language Settings	28, 50
LCD Monitor	32
Brightness	50
Lens Cap	24
Light Metering Modes	47, 90

M

Macro Mode	73
Macro Ring Lite	174
Macro Twin Lite	174
Magnifying Images	123, 170
Manual Exposure (M)	87
Manual Focus	47, 114
Menu	
My Camera	51
Play	48
Rec.	46
Selecting Menus and	
Settings	43
Set up	49
Metering Mode	47, 90
MF-Point Zoom	47, 114
Mode Dial	14
Movie ()	71
Editing	128
Playback	126, 170
Resolution	58
Mute	49, 155
My Camera	154

N

ND Filter	47, 118
Night Scene Mode ()	67

O

Operation Sound . . . 49, 51, 154
Overexposure Warning 39

P

Photo Effect 96
Playback 122
 Auto Playback
 (Slide Show) 133
 Movies 126, 170
 Single Image 122
 TV 153
 Volume 49
Playback Mode 30, 31
Portrait Mode (📷) 66
Power/Mode Indicator 29
Power On/Off 29
Power Saving 31, 50
Pressing
 Fully 41
 Halfway 41
Printing
 Print Order 49, 140
 Print Style 141, 144
 Resetting 146
 Selecting Images 142
 Settings 142
Program AE (P) 81
Protect 48, 137

R

RAW File Format . . . 55, 57, 60
Red-eye Reduction 46, 64
Remote Sensor 11, 169
Reset 52
Reverse Display 33, 48
Review 48, 54, 56
Rotate 48, 130

S

Safety Shift 47, 83, 85, 86
Saturation 97
Save Settings 48
Self-Timer 47, 77
 Sound 49, 51, 154
Sharpness 97
Shooting
 Checking Images
 (Reviewing) . . 48, 54, 56
 Using a TV for
 Viewing 153
Shooting Mode 29, 31
 Functions Available . . 202
Shutter Button 41, 169
Shutter Sound . . 41, 51, 54, 154
 Volume 49
Shutter Speed . . 81, 82, 85, 87
Shutter Speed-Priority
 AE (Tv) 82
Single Image Playback . . . 122
Slide Show 48, 133
 Play Time 136
 Repeat 136
 Selecting Images 134
 Starting 133
Slow Synchro 46, 64
Sound Memos 131
Speaker 11
Spot AE Point 90
Spot Metering 36, 47
Start-up Image . . . 30, 51, 154
Start-up Sound . . 30, 49, 51, 154
Stitch Assist
 Mode (📷) 68, 69
Strap 24
Super Macro Mode 48, 75

T

- Tele-converter 177
- Telephoto 39
- Terminal Cover 12, 19
- Transfer Order
(Image Transmission
Settings) 49, 147
 - Selecting Images 147

U

- Using the Built-In Flash 62

V

- Video System 50, 153
- Viewfinder 12, 33, 34
- Volume 49

W

- White Balance 93
- Wide Angle 39
- Wireless Controller 168
 - Wireless Delay 47

Z

- Zoom 39, 54, 78, 123, 169

MEMO

MEMO

FCC Notice

Digital Camera, Model PC1057

This device complies with Part 15 of the FCC Rules. Operation is subject to the following two conditions;

- (1) this device may not cause harmful interference, and
- (2) this device must accept any interference received, including interference that may cause undesired operation.

Note: This equipment has been tested and found to comply with the limits for Class B digital devices, pursuant to Part 15 of the FCC rules. These limits are designed to provide reasonable protection against harmful interference in a residential installation. This equipment generates, uses and can radiate radio frequency energy and, if not installed and used in accordance with the instructions, may cause harmful interference to radio communications. However, there is no guarantee that interference will not occur in a particular installation. If this equipment does cause harmful interference to radio or television reception, which can be determined by turning the equipment off and on, the user is encouraged to try to correct the interference by one or more of the following measures:

- Reorient or relocate the receiving antenna.
- Increase the separation between the equipment and receiver.
- Connect the equipment into an outlet on a circuit different from that to which the receiver is connected.
- Consult the dealer or an experienced radio/TV technician for help.

The cables with the ferrite core provided with the digital camera must be used with this equipment in order to comply with Class B limits in subpart B of Part 15 on FCC rules.

Do not make any changes or modifications to the equipment unless otherwise specified in the manual. If such changes or modifications should be made, you could be required to stop operation of the equipment.

Canon U.S.A. Inc.

One Canon Plaza, Lake Success, NY 11042, U.S.A.
Tel No. (516) 328-5600

Canadian Radio Interference Regulations

THIS CLASS B DIGITAL APPARATUS MEETS ALL REQUIREMENTS OF THE CANADIAN INTERFERENCE CAUSING EQUIPMENT REGULATIONS.

Réglementation canadienne sur les interférences radio

CET APPAREIL NUMERIQUE DE LA CLASSE B RESPECTE TOUTES LES EXIGENCES DU REGLEMENT SUR LE MATERIEL BROUILLEUR DU CANADA.

Functions Available in Each Shooting Mode

This chart shows the functions available in each shooting mode. You can shoot with the settings saved in the **C1** or **C2** mode (p. 116).

		AUTO						P	Tv	Av	M	Reference Page
Resolution	Large L	○*	○*	○*	○*	△*	-	○*	○*	○*	○*	57
	Medium 1 M1	○	○	○	○	△	-	○	○	○	○	
	Medium 2 M2	○	○	○	○	△	-	○	○	○	○	
	Medium 3 M3	○	○	○	○	△	-	○	○	○	○	
	Small S	○	○	○	○	△	-	○	○	○	○	
Resolution	Movie	-	-	-	-	-	○	-	-	-	-	58
	Movie	-	-	-	-	-	○*	-	-	-	-	
	Movie	-	-	-	-	-	○	-	-	-	-	
Compression	Superfine	○	○	○	○	△	-	○	○	○	○	57
	Fine	○*	○*	○*	○*	△*	-	○*	○*	○*	○*	
File Format	JPEG	○	○	○	○	○	-	○*	○*	○*	○*	60
	RAW	-	-	-	-	-	-	○	○	○	○	
Flash Pop-up	On	○	○	○	○	○	○	○*	○*	○*	○*	65
	Off	-	-	-	-	-	-	○	○	○	○	
Flash	Auto	○*	○*	○	○*	-	-	○	-	-	-	62
	On	-	○	○	○	△	-	○	○	○	○	
	Off	○	○	○*	○	△*	○	○*	○*	○*	○*	
Red-eye Reduction	○	○	○	○	△	-	○	○	○	○	64	
Slow Synchro	On	-	-	○	○	△	-	○	-	○	-	64
	Off	○	○	-	-	△*	-	○*	○*	○*	○	
Flash Adjust	On	○	○	○	○	○	-	○	○*	○*	-	107
	Off	-	-	-	-	-	-	-	○	○	○	
Flash Sync	1st-curtain	○	○	○	○	○	-	○*	○*	○*	○*	109
	2nd-curtain	-	-	-	-	-	-	○	○	○	○	
Drive Mode	Single Shot	○*	○*	○*	○*	△*	○*	○*	○*	○*	○*	-
	Standard Continuous Mode	-	○	○	○	-	-	○	○	○	○	79
	High Speed Continuous Mode	-	○	○	○	-	-	○	○	○	○	
	Self-Timer (10 sec.)	○	○	○	○	○	○	○	○	○	○	77
	Self-Timer (2 sec.)	○	○	○	○	○	○	○	○	○	○	
Intervalometer	-	-	-	-	-	-	-	○	○	○	○	110
AF Frame	Center Point	○	○	○	○	○	○	○*	○*	○*	○*	89
	Manual	-	-	-	-	-	-	○	○	○	○	
AF Lock	-	○	○	○	○	○	○	○	○	○	○	113
Manual Focus	-	○	○	○	○	○	○	○	○	○	○	114