



ENGLISH



Canon
DIGITAL CAMERA
PowerShot S230
DIGITAL ELPH
DIGITAL IXUS V3

Canon

PowerShot S230
DIGITAL ELPH

DIGITAL
IXUS V3

Camera User Guide



Canon



Camera User Guide

Exif Print



- Please read the *Read This First* section (p. 7).
- Please refer to the *Software Starter Guide* for information on installing the software and downloading images.
- Please also read the printer user guide included with your Canon printer.

CDI-E072-010 XX01XXX.X © 2002 CANON INC. PRINTED IN JAPAN





Flowchart and Reference Guides

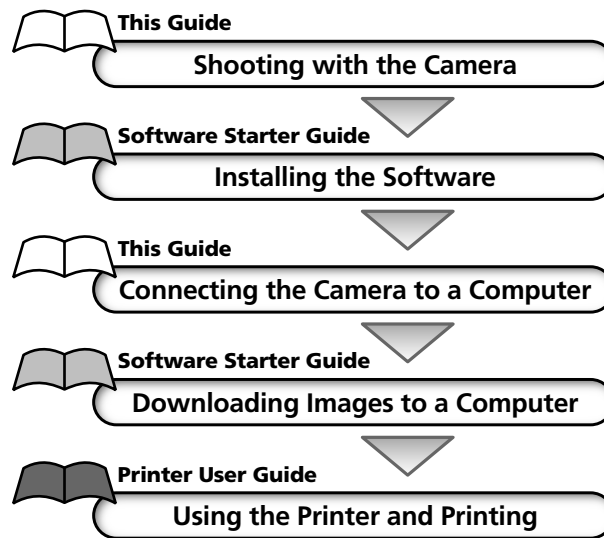

Precautions

This digital camera is designed to perform optimally when used with genuine Canon-brand digital camera accessories ("Canon Brand Accessories"). You may use non-Canon brand accessories with this digital camera. However, Canon makes no warranties concerning, and is not responsible for damages resulting from, use of non-Canon brand accessories.





1

Camera Body Temperature

If your camera is used for prolonged periods, the camera body may become warm. Please be aware of this and take care when operating the camera for an extended period.

About the LCD Monitor

The LCD monitor is produced with extremely high-precision manufacturing techniques. More than 99.99% of the pixels operate to specification. Less than 0.01% of the pixels may occasionally misfire or appear as red or black dots. This has no effect on the recorded image and does not constitute a malfunction.

Video Format

Please set the camera's video signal format to the one used in your region before using it with a TV monitor (p. 124).



Charging the Date/Time Battery

- The camera has a built-in rechargeable lithium battery that maintains the date, time and other camera settings. This battery recharges when the main battery pack is inserted into the camera. When you first purchase the camera, place a charged battery pack in it or use the AC adapter kit (sold separately) for at least 4 hours to charge the date/time battery. It will charge even when the camera power is set to Off.
- If the Set Date/Time menu appears when the camera power is turned on, it means that the date/time battery charge is depleted. Recharge it as described above.





About This Guide

Conventions Used in the Text

Icons on the right end of title bars show the applicable operating modes. As in the example below, the mode dial should be set to , , or .

Using the Self-timer



White buttons indicate the button that will be pushed in the particular procedure. In the example here, for instance, you should press the **MENU** button.

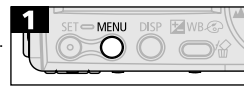

This mark denotes issues that may affect the camera's operation.

This mark denotes additional topics that complement the basic operating procedures.

Question? Look Here First

- How do I navigate the Menu?
Selecting Menus and Settings (p. 37)
- What settings are available under each function?
and
Will my settings remain in effect even after I've turned the camera off?
Functions Available in Each Shooting Mode (p. 148)
- How do I go about printing?
About Printing (p. 90)
- What functions are available through the menu?
Rec. Menu (p. 118)
Play Menu (p. 121)
Set up Menu (p. 123)





Table of Contents

Items marked with  are lists or charts that summarize camera functions or procedures.

Read This First

Please Read	7
Safety Precautions	7
Preventing Malfunctions	11

Quick Start Section

Quick Start Section	12
---------------------------	----

Components Guide

Front View	14
Back View	15
Operation Panel	16
Indicators	17

Preparing the Camera

Charging the Battery Pack	18
Installing the Battery Pack	20
Installing a CF Card	22
Setting the Date and Time	23
Setting the Language	25

Basic Functions

Turning the Power On/Off	26
Switching between Shooting/Replay	28
Using the LCD Monitor	29
Using the Viewfinder	33
Pressing the Shutter Button	34
Using the Zoom	36
 Selecting Menu and Settings	37





4 | Table of Contents

Shooting

- Selecting a Shooting Mode 42
- Reviewing an Image Right after Shooting 44
- Changing Resolution/Compression Settings 45
- Using the Flash 47
- Shooting Close-Ups/Infinity Shots 49
- Using the Digital Zoom 50
- Continuous Shooting 51
- Using the Self-timer 52
- Shooting in Stitch Assist Mode 53
- Shooting a Movie 56
- Locking the Focus (AF Lock) 58
- Locking the Exposure Setting (AE Lock) 60
- Locking the Flash Exposure Setting (FE Lock) 61
- Switching between Autofocus Modes 62
- Switching between Light Metering Modes 63
- Adjusting the Exposure Compensation 64
- Shooting in Long Shutter Mode 65
- WB** Setting the White Balance 67
- Changing the Photo Effect 70
- Adjusting the ISO Speed 71
- Setting the Auto Rotate Function 72
- Resetting the File Number 73



Replaying

- Displaying Images Individually 74
- Magnifying Images 75
- Viewing Images in Sets of Nine (Index Replay) 76
- Viewing Movies 77
- Editing Movies 79
- Rotating Images in the Display 81
- Automated Playback (Slide Shows) 82
- Protecting Images 86





Table of Contents | 5

Erasing

-  Erasing Single Images 87
- Erasing All Images 88
- Formatting CF Cards 89

Printing

- About Printing 90
- Connecting a Printer 94
- Printing 97
- Setting the Print Settings (Direct Print function) 99
- Setting the DPOF Print Settings 103

Image Transmission Settings (DPOF Transfer Order)

- Selecting Images for Transferring 111

Shooting/Replaying with a TV

- Shooting/Replaying with a TV 113

Downloading Images to a Computer

- Downloading Directly from a CF Card 114
- Connecting the Camera to a Computer
with a USB Cable 115

Lists of Menu Options and Messages

- Rec. Menu 118
- Play Menu 121
- Set up Menu 123
- Resetting Settings to Their Default Values 125
- List of Messages 126





6 | Table of Contents

Appendices

- Using an AC Adapter Kit 130
- Using a Car Battery Charger 131
- Camera Care and Maintenance 132
- Troubleshooting 133

Specifications

- Specifications 137

Index

- Index 143

List of Functions

- Functions Available in Each Shooting Mode 148





Read This First

Please Read

Test Shots

Before you try to photograph important subjects, we highly recommend that you shoot several trial images to confirm that the camera is operating and being operated correctly. Please note that Canon, its subsidiaries and affiliates, and its distributors are not liable for any consequential damages arising from any malfunction of a camera or accessory, including CompactFlash™ cards, that results in the failure of an image to be recorded or to be recorded in a format that is machine readable.

Warning Against Copyright Infringement

Please note that Canon digital cameras are intended for personal use and should never be used in a manner that infringes upon or contravenes international or domestic copyright laws and regulations. Please be advised that in certain cases the copying of images from performances, exhibitions, or commercial properties by means of a camera or other device may contravene copyright or other legal rights even if the image was shot for personal use.

Warranty Limitations

This camera's warranty is only effective in the country of sale. If a problem arises while the camera is in use abroad, please convey it back to the country of sale before proceeding with a warranty claim to a Canon Customer Support Help Desk.

For Canon Customer Support contacts, please see the Canon Limited Warranty supplied with your camera.

Safety Precautions

- Before using the camera, please ensure that you read and understand the safety precautions described below. Always ensure that the camera is operated correctly.
- The safety precautions noted on the following pages are intended to instruct you in the safe and correct operation of the camera and its accessories to prevent injuries or damage to yourself, other persons and equipment.
- In the next few pages, the term "equipment" refers primarily to the camera and its power supply accessories, such as the battery charger and optional compact power adapter or car battery charger.





8 | Read This First

Warnings

- Do not aim the camera directly into the sun or at other intense light sources that could injure your eyesight.
- Do not trigger the flash in close proximity to human or animal eyes. Exposure to the intense light produced by the flash may injure eyesight. In particular, remain at least one meter (39 inches) away from infants when using the flash.
- Store this equipment out of the reach of children and infants. Accidental damage to the camera or batteries by a child could result in serious injury. In addition, placement of the strap around the child's neck could result in asphyxiation.
- Do not attempt to disassemble or alter any part of the equipment that is not expressly described in this guide. Disassembly or alteration may result in high-voltage electrical shock. Internal inspections, alterations and repairs should be conducted by qualified service personnel authorized by your camera distributor or a Canon Customer Support Help Desk.
- To avoid the risk of high-voltage electrical shock, do not touch the flash portion of the camera if it has been damaged. Similarly, never touch internal portions of the equipment that become exposed as a result of damage. There is a risk of high-voltage electrical shock. Please take the first opportunity to consult your camera distributor or the closest Canon Customer Support Help Desk.
- Stop operating the equipment immediately if it emits smoke or noxious fumes. Failure to do so may result in fire or electrical shock. Immediately turn the camera's power off, remove the camera battery and unplug the power cable from the power outlet. Confirm that smoke or fume emissions have ceased. Please consult your camera distributor or the closest Canon Customer Support Help Desk.
- Stop operating the equipment if it is dropped or the casing is damaged. Failure to do so may result in fire or electrical shock. Immediately turn the camera's power off, remove the camera battery and unplug the power cable from the power outlet. Please consult your camera distributor or the closest Canon Customer Support Help Desk.





Read This First | 9

- Do not allow the equipment to come into contact with, or become immersed in, water or other liquids. Do not allow liquids to enter the interior. The camera has not been waterproofed. If the exterior comes into contact with liquids or salt air, wipe it dry with a soft, absorbent cloth. If water or other foreign substances enter the interior, immediately turn the camera's power off and remove the camera battery or unplug the power cable from the power outlet. Continued use of the equipment may result in fire or electrical shock. Please consult your camera distributor or the closest Canon Customer Support Help Desk.
- Do not use substances containing alcohol, benzene, thinners or other flammable substances to clean or maintain the equipment. The use of these substances may lead to fire.
- Remove the power cable on a regular periodic basis and wipe away the dust and dirt that collects on the plug, the exterior of the electrical outlet and the surrounding area. In dusty, humid or greasy environments, the dust that collects around the plug over long periods of time may become saturated with humidity and short-circuit, leading to fire.
- Do not cut, damage, alter or place heavy items on the power adapter cable. Any of these actions may cause an electrical short circuit, which may lead to fire or electrical shock.
- Do not handle the power cable if your hands are wet. Handling it with wet hands may lead to electrical shock. When unplugging the cable, ensure that you hold the solid portion of the plug. Pulling on the flexible portion of the cable may damage or expose the wire and insulation, creating the potential for fires or electrical shocks.
- Use of power sources not expressly recommended for this equipment may lead to overheating, distortion of the equipment, fire, electrical shock or other hazards. Use only the recommended power accessories.
- Do not place the batteries near a heat source or expose them to direct flame or heat. Neither should you immerse them in water. Such exposure may damage the batteries and lead to the leakage of corrosive liquids, fire, electrical shock, explosion or serious injury.
- Do not attempt to disassemble, alter or apply heat to the batteries. There is serious risk of injury due to an explosion. Immediately flush with water any area of the body - including the eyes and mouth, or clothing - that comes into contact with the inner contents of a battery. If the eyes or mouth contact these substances, immediately flush with water and seek medical assistance.





10 | Read This First

- Avoid dropping or subjecting the batteries to severe impacts that could damage the casings. It could lead to leakage and injury.
- Do not short-circuit the battery terminals with metallic objects, such as key holders. It could lead to overheating, burns and other injuries. Use the supplied terminal cover or battery case to transport or store the battery pack.
- Before you discard a battery, cover the terminals with tape or other insulators to prevent direct contact with other objects. Contact with the metallic components of other materials in waste containers may lead to fire or explosions. Discard the batteries in specialized waste facilities if available in your area.
- Use of batteries not expressly recommended for this equipment may cause explosions or leaks, resulting in fire, injury and damage to the surroundings. Use only recommended batteries and accessories.
- Use the specified battery charger to charge Battery Pack NB-1LH or NB-1L. Use of other chargers may lead to overheating, distortion of the equipment, fire or electrical shock.
- Disconnect the battery charger and compact power adapter from both the camera and the power outlet after recharging and when they are not in use to avoid fire and other hazards. Continuous use over a long period may cause a unit to overheat and distort, resulting in fire.
- The camera terminal of the supplied compact power cord is designed for exclusive use with your camera. Do not use it with other products or batteries. There is a risk of fire and other hazards.



Cautions

- Avoid using, placing or storing the equipment in places subject to strong sunlight or high temperatures, such as the dashboard or trunk (boot) of a car. Exposure to intense sunlight and heat may cause the batteries to leak, overheat or explode, resulting in fire, burns or other injuries. High temperatures may also cause deformation of the casing. Ensure that there is good ventilation when using the compact power adapter to charge the battery pack or power the camera.
- Do not store the equipment in humid or dusty areas. Storage in such areas could lead to fire, electrical shock or other damage.
- Be careful not to bang the camera or subject it to strong impacts or shocks that could lead to injury or damage the equipment when wearing or holding it by the strap.





Read This First | 11

- Be careful not to cover the flash with your fingers when shooting. In addition, do not touch the surface of the flash after taking several pictures in rapid succession. Either action could result in burns.
- If your camera is used for prolonged periods, the camera body may become warm. Please take care when operating the camera for extended periods as your hands may experience a burning sensation.

Preventing Malfunctions

Avoid Strong Magnetic Fields

Never place the camera in close proximity to electric motors or other equipment generating strong electromagnetic fields. Exposure to strong magnetic fields may cause malfunctions or corrupt image data.

Avoid Condensation Related Problems

Moving the equipment rapidly between hot and cold temperatures may cause condensation (water droplets) to form on its external and internal surfaces. You can avoid this by placing the equipment in an airtight, resealable plastic bag and letting it adjust to temperature changes slowly before removing it from the bag.

If Condensation Forms Inside the Camera

Stop using the camera immediately if you detect condensation. Continued use may damage the equipment. Remove the CF card and battery or Compact Power Adapter (if connected) from the camera and wait until the moisture evaporates completely before resuming use.

Extended Storage

When not using the camera for extended periods of time, remove the battery pack and store the equipment in a safe place. Storing the camera for extended periods with a battery pack installed will run down the battery pack and may damage the camera. Please note, however, that the date, time and other camera settings may reset to the default settings if the battery pack has been removed for more than three weeks. Follow the instructions in this guide to reset the desired settings.



Quick Start Section

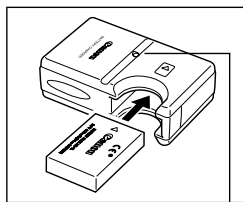

Charge Indicator

1 Charge the Battery Pack (p. 18).

Place the battery pack in the battery charger and plug the charger into a power outlet. The charge indicator lights red while charging and changes to green when the battery pack is charged.

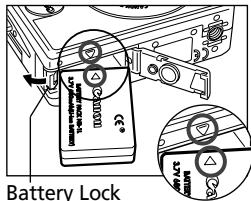

Battery Lock

2 Install the Battery Pack (p. 20).

Slide the battery cover open and press the battery lock while you insert the battery pack. Insert the battery pack correctly by aligning the arrows on the camera and battery pack.

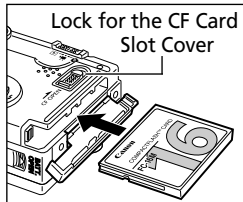

Lock for the CF Card Slot Cover

3 Install the CF Card (p. 22).

Slide the lock on the CF card cover to open it and insert the CF card.





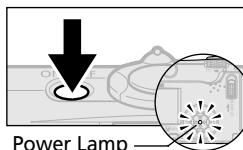

4 Set the Mode Switch to (Shooting) (p. 42).



Power Lamp

5 Turn on the Power (p. 26).

Press the ON/OFF Button until the power lamp in the center of the 4  /  /  /  buttons lights.

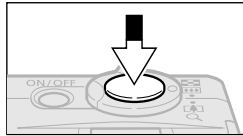

6 Focus (p. 34).

Aim the camera and lightly press (halfway) the shutter button. Two beeps will sound when the autofocus is set.

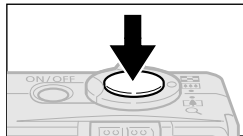

7 Shoot (p. 35).

Press the shutter button all the way. One beep will sound when the shot is complete.



8 View the Recorded Image (p. 44).

The recorded image displays for approximately 2 seconds. To continue displaying the image, keep the shutter button pressed or hold the shutter button until you press the **SET** button and then release both.



To Immediately Delete the Displayed Image

1. Press the  button while the image is displayed.
2. Confirm that [Erase] is selected and press the SET button.

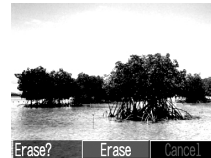

- Set the date and time if the Set Date/Time menu appears (p. 23).
- You can change the language in which menus are displayed (p. 25).
- To view the other images you have photographed, refer to the *Replaying* section (p. 74).
- After you finish using the camera, press the ON/OFF Button to shut the power off.



Components Guide

Front View

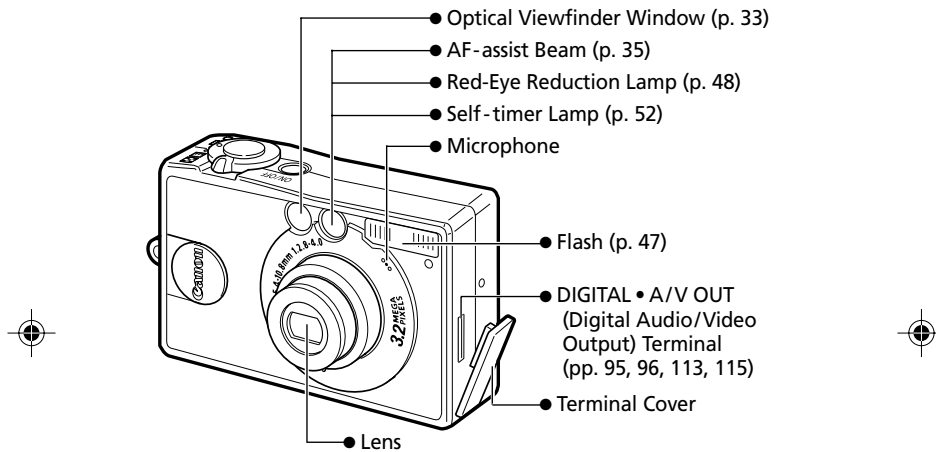

• **The following cables are used to connect the camera to a computer or printer.**

- Computer (p. 115)
USB Interface Cable IFC-200PCU (supplied with camera)
- Direct Print Function Compatible Printer (sold separately) (p. 94)
Direct Interface Cable DIF-200 (supplied with printer)
- Direct Print Function Compatible Bubble Jet Printer (sold separately) (p. 95)
Please refer to your Bubble Jet Printer user guide.

Please refer to the *System Map* supplied with the camera for direct print function compatible printers.



Back View

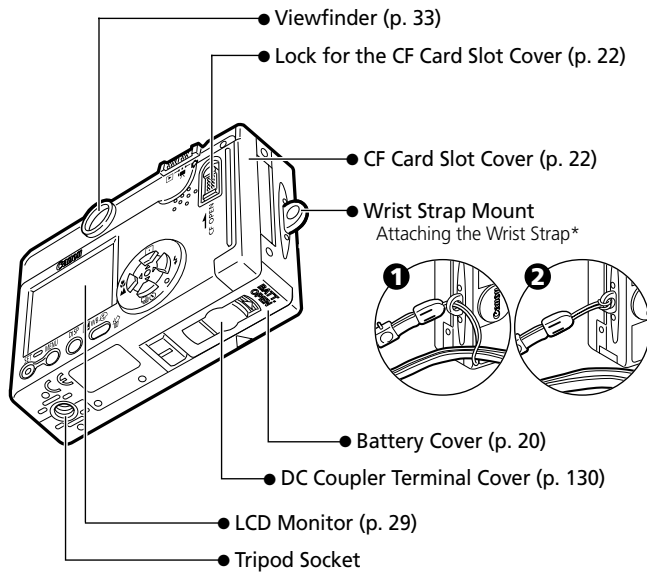

* Be careful not to wave the camera about or catch it on other items when dangling it from the wrist strap.



Operation Panel

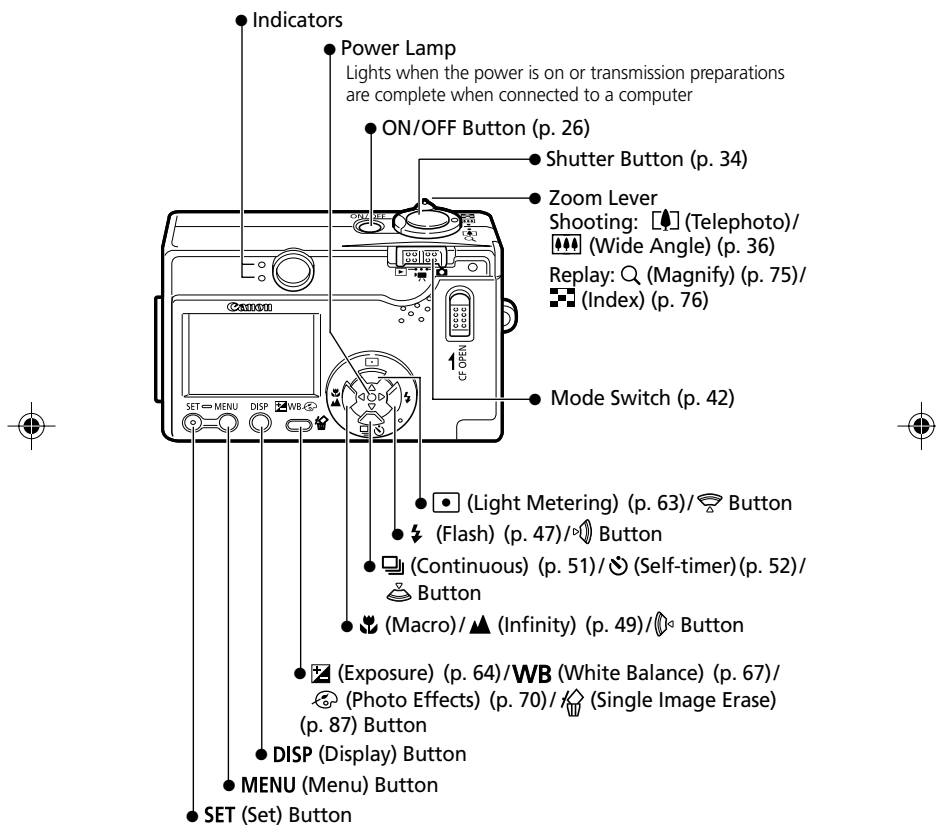



Indicators

The indicators light or blink when the ON/OFF Button or shutter button is pressed.

Upper Indicator

Green:	Ready to shoot/Connection preparations complete (during a computer connection)
Blinking Green:	Initializing camera/Recording to CF card / Reading CF card/Erasing from CF card/Transmitting data (during a computer connection)
Orange:	Ready to shoot with slow shutter speed (flash on)
Blinking Orange:	Ready to shoot but shutter speed is slow (camera shake warning)

Lower Indicator

Yellow:	Macro mode/Infinity mode/Focus lock (Method 2, p. 58)
Blinking Yellow:	Focusing difficulty (1 beep sounds). Although you can press the shutter button, you are recommended to use the focus lock (p. 58).



Preparing the Camera

Charging the Battery Pack

Use the following procedures to charge the battery pack the first time you use the camera or when the "Change the battery pack" message displays.

Battery charger model names and types vary by region.

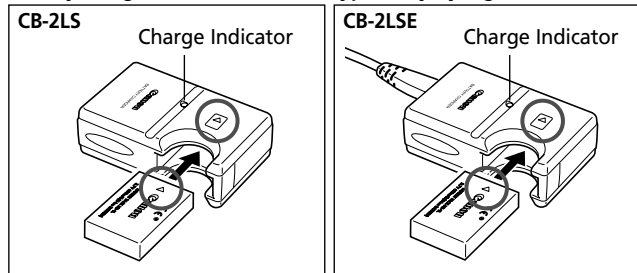

- Insert the battery pack all the way into the battery charger as shown and insert the charger's plug into a power outlet.
- Align the battery pack correctly with the arrows on it and the charger.
- The charge indicator will light red while the battery pack is charging. It will change to green when the charge is complete.
- After charging, unplug the battery charger and remove the battery pack.



- To protect the battery pack and prolong its life, do not charge it for longer than 24 hours continuously.



- Since this is a lithium ion battery pack, you need not completely discharge it before recharging. It can be recharged at any point.
- It takes approximately 130 minutes to fully charge the battery pack from a fully discharged state (based on Canon's testing standard). Please charge it at an ambient temperature ranging between 5° and 40° C (41° and 104° F).
- Charge times may vary according to the ambient temperature and the battery pack's charge state.
- See *Battery Capacity* (p. 139).
- You may hear a noise during charging. This is not a malfunction.

Handling Precautions

- Keep the battery pack terminals (⊕⊖) clean at all times. Dirty terminals may cause poor contact between the battery pack and camera. Polish the terminals with a tissue or a dry cloth before charging or using the battery pack.
- Do not rapidly overturn or wave the battery charger around when it contains the battery pack. The battery pack could fly out.
- At low temperatures, battery pack performance may be reduced and the low battery icon may appear earlier than usual. Under these conditions, resuscitate the battery pack by warming it in a pocket immediately before use. However, ensure that there are no metallic items in the pocket that could cause a short circuit, such as a key holder, etc.
- Do not place anything, such as tablecloths, carpets, bedding or cushions, on top of the battery charger while it is charging. Heat will build up and could result in a fire.
- Do not charge batteries other than Battery Pack NB-1LH or NB-1L in this charger.
- The battery pack continues to discharge a minimal portion of its power while installed in the camera, even with the power off, or in the charger. This will shorten battery life.
- Do not allow any metal objects such as keyrings to touch the "+" and "-" terminals (Fig. A), as this can damage the battery pack. To carry the battery pack or store it during periods of disuse, always replace the terminal cover (Fig.B) or place it in the supplied case and store it in a cool, dry place. Recharge it fully before using it again.

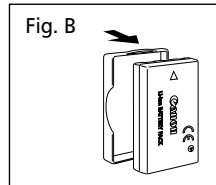
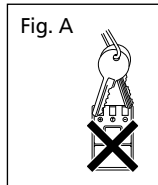

- If the performance of the battery pack diminishes substantially even when it is fully charged, its life has been exceeded and it should be replaced.

Installing the Battery Pack

Install Battery Pack NB-1LH (supplied) as shown below. Battery Pack NB-1L (optional) can also be used with the camera.



- Please recharge the battery pack (p. 18) before you use it for the first time.

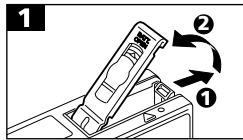

- Slide the battery cover in the direction of the arrows.

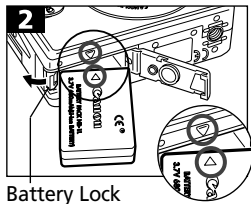

Battery Lock

- Press the battery lock while inserting the battery pack all the way in until the lock clicks.
- Insert the battery pack correctly by aligning the arrows on the camera and the battery pack.
- To remove the battery pack, press the battery lock and pull the battery pack out.

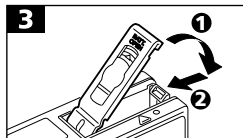

- Slide the battery cover closed.



- Do not turn off the power or open the battery cover while the camera's indicator blinks green. The camera is writing, reading, erasing or transmitting an image to or from the CF card.
- Remove the battery pack when the camera is not in use. Please note, however, that the date, time and other camera settings may reset to the default settings if the battery pack has been removed for more than three weeks.



- Please use an AC Adapter Kit ACK500 (sold separately) for extended use of the camera (p. 130).

Battery Pack Charge

The following icons and messages will display when the battery pack charge is low.

	Battery pack charge is low. Recharge it as soon as possible before it is required for an extended period. When the LCD monitor is off, this icon will display when you press the , , , DISP or button (mode).
Change the battery pack	Battery charge is insufficient to operate the camera. Replace the battery pack immediately.



- See *Battery Capacity* (p. 139).



22 | Preparing the Camera

Installing a CF Card

Turn the camera power off and insert the CF card with the following procedures.

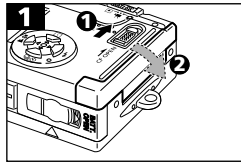

- Slide the lock up and open the CF card slot cover.

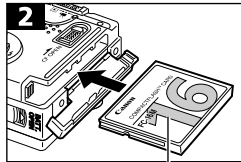

- Insert the CF card with its label facing upward until the slot's eject button fully extends. Close the CF card slot cover.

Label

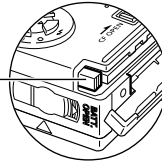

CF Card Eject Button

- To remove the CF card, push the eject button and pull the CF card out.



- Since the camera is writing, reading, erasing or transmitting data to or from the CF card when the indicator blinks green, never perform the following actions during this time. It could corrupt the image data.
 - Subject the camera body to vibration or shocks.
 - Turn the camera's power off, or open the battery cover or CF card slot cover.
- Please note that CF cards formatted with other manufacturers' cameras or a computer, or formatted or edited with application programs, may not operate correctly in the camera.
- You are recommended to use CF cards that have been formatted in your camera (p. 89). The card supplied with the camera may be used without further formatting.



Preparing the Camera | 23



- See *CF Cards and Estimated Capacities* (p. 140).

Handling Precautions for CF Cards

- CF cards are high-precision electronic devices. Do not bend them, apply force to them, or subject them to shocks or vibration.
- Do not attempt to disassemble or alter a CF card.
- Moving a CF card rapidly between temperature extremes will cause condensation to form in the card and lead to a malfunction. To avoid condensation, place the CF card in a sealed plastic bag before moving it into a different temperature zone and allow it to adjust slowly to the new temperature. If condensation forms on the CF card, store it at room temperature until the water droplets have evaporated naturally.
- Do not use or store CF cards in the following types of location.
 - Locations subject to dust or sand
 - Locations subject to high humidity and high temperatures



Setting the Date and Time



The Set Date/Time menu will appear the first time the camera power is turned on or whenever the built-in rechargeable lithium battery charge is low. Start from Step 3 to set the date and time.

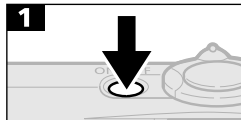

- Press the ON/OFF Button until the power lamp lights.

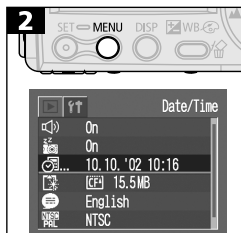

- Press the **MENU** button to display the Rec. or Play menu.
- Use the or button to select the (Set up) menu.
- Use the or button to select .





24 | Preparing the Camera

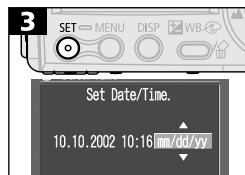

- Use the or button to select a field (year, month, day, hour, minute and date format), and the or button to change its value.

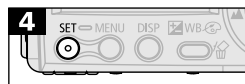

- To put the settings into effect, press the **SET** button after setting the date format.

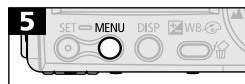

- Press the **MENU** button to redisplay the Rec. or Play screen.



- Please note that the date and time settings may reset to the default settings if the camera battery has been removed for more than three weeks. Reset them when this occurs.
- Setting the date and time settings does not cause the date/time stamp to appear on images.



- Charging the Date/Time Battery
 - The camera has a built-in rechargeable lithium battery for saving settings such as the date and time. This battery is recharged by the battery pack while it is in the camera. Right after purchasing the camera, leave a charged battery pack in the camera, or plug in AC Adapter Kit ACK500, for about 4 hours to charge the date/time battery. It will charge even when the camera's power switch is off.
 - If the Set Date/Time menu appears when the camera power is turned on, the date/time battery charge is low. Use the above method to recharge it.
- You can print the date on images (p. 99).



Setting the Language

The language in which menus and messages are displayed can be selected with this function.

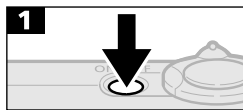

- Press the ON/OFF Button until the power lamp lights.



- Press the **MENU** button to display the Rec. or Play menu.
- Use the or button to select the (Set up) menu.
- Use the or button to select .



- Use the , , or button to select a language.

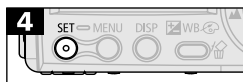

- Press the **MENU** button to redisplay the Rec. or Play screen.

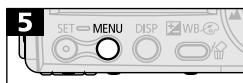

- The Language menu can also be displayed in replay mode by holding down the **SET** button and pressing the **MENU** button. However, language settings cannot be adjusted while a printer is connected.



Basic Functions

Turning the Power On/Off

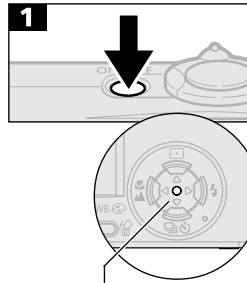

Power Lamp

- Press the ON/OFF Button until the green power lamp lights.
 - The upper indicator beside the viewfinder will blink green.
 - The lens will extend when the mode switch is set to the or position.
 - The lens will retract approximately 1 minute after the mode switch is set to from the or position.
 - The LCD monitor will always turn on when the mode switch is set to the or position.
- Press the ON/OFF Button again to turn off the power.



- The Set Date/Time menu will appear the first time the camera power is turned on or whenever the charge of the built-in rechargeable lithium date/time battery is low. Reset the date and time when this occurs (p. 23).
- If the power-saving function activates, press the ON/OFF Button to restore power.





• **Power-Saving Function**

This camera is equipped with a power-saving function. The power will automatically shut down under the following circumstances when this function is set to On. Press the ON/OFF Button to restore power.

Shooting Mode

Powers down approximately 3 minutes after the last control is accessed on the camera. (The LCD monitor automatically turns off 3 minutes after the last control is accessed even if this function is set to Off. Press any button except the ON/OFF Button to turn the LCD monitor back on.)

Replay Mode

Powers down approximately 5 minutes after the last control is accessed on the camera.

Connected to a Printer (optional)

Powers down approximately 5 minutes after the last control is accessed on the camera or something is printed on a connected printer.

Connected to a Computer

A warning message displays on the computer screen approximately 5 minutes after the last control is accessed. Powers down approximately 1 minute later if no control is accessed.

- **The power-saving function will not activate while the Communication mode is set to PTP (p. 116).**
- **The power-saving function will not activate during a slide show.**
- **The camera's settings can be changed to turn off the power-saving function (p. 123).**





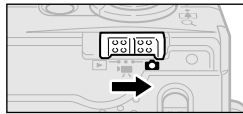

28 | Basic Functions

Switching between Shooting/Replay

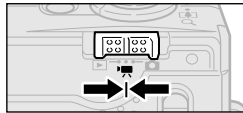

- **To Shoot Still Images (Shooting Mode)**
Slide the mode switch to .



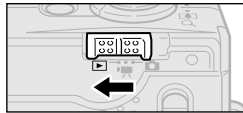

- **To Shoot Movies (Movie Mode)**
Slide the mode switch to .



- **To Replay Images (Replay Mode)**
Slide the mode switch to 
 - Recorded images can be printed when a printer (sold separately) is connected (p. 90).
 - Recorded images can be downloaded to and viewed with a computer when it is connected (p. 115).



- The  or  icon displays on the LCD monitor when a connection to a printer is opened.
- The LCD monitor shuts off while a computer is connected.



Using the LCD Monitor

The LCD monitor can be used to compose images while shooting, adjust settings menus and replay images.



- The image in the LCD monitor will darken in strong sunlight or bright light. This does not constitute a malfunction.

Shooting Mode (📷 or 📹 on the mode switch)



- The LCD monitor turns on or changes the display mode as follows with each press of the **DISP** button.

Standard (No Information) → Detailed (Information View) → Off
 ↑



- The LCD monitor setting (On or Off) is saved by the camera when the power is turned off so that the same setting is automatically available when the power is turned on again. However, the setting may be lost when the power has been turned off after the “Change the battery pack” message has displayed, while the LCD monitor was on in shooting mode.
- In the 📷, 📹 or 📺 mode, the LCD monitor turns on regardless of its On/Off setting.
- Set the flash to 📷, 📷 or affix the camera to a tripod when the upper indicator blinks orange and the camera shake warning icon (📷) appears in the LCD monitor after the metering preparations are complete.

Notice Concerning Shooting

When using this camera to shoot scenes containing extremely bright subjects, a vertical, red bar of light may appear on the LCD monitor. This is a normal occurrence in devices containing CCDs and does not constitute a malfunction. This red bar of light will not be recorded when shooting still photos, but it will be recorded when shooting movies.



30 | Basic Functions

Replay Mode (▶ on the mode switch)



- The LCD monitor will turn on when the mode switch is set to the ▶ position.
- In replay mode, pressing the **DISP** button cycles the information view mode each time the button is pressed.

Single Image Replay (p. 74)

Standard → Detailed → No Display



Multi Image Replay (9 Images) (p. 76)

Standard ↔ No Display

Information Displayed on the LCD Monitor

Shooting Mode

In shooting mode, information about the current settings and remaining image capacity will display on the LCD monitor for approximately six seconds when the actions below are taken, regardless of whether the LCD monitor is set to On or Off.

- The power is turned on.
- The **DISP**, , , or button (Ⓜ mode) is pressed.
- The camera settings are changed.
- The Set up menu is closed.

While this information is displayed, you may set the flash, continuous mode, self-timer, macro and infinity settings.



- After you press the shutter button and take a shot, the recorded image appears on the LCD monitor for 2 - 10 seconds (1-second increments). It will continue to display if you press the **SET** button while it is shown on the screen. See *Changing the Review Duration* (p. 44) .
- While a recorded image is displayed on the LCD monitor, you can check the exposure with the graph (see Histogram, p. 32) that shows the distribution of the brightness data. (Press the **DISP** button if the histogram and other information is not shown) If the exposure requires adjustment, set the exposure compensation and reshoot.



In movie mode, only the resolution shows (not compression).

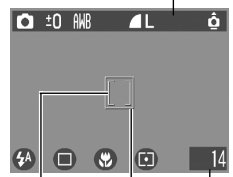

AF Frame (p. 62)

Recordable Images or Recordable Movie Time (sec.)

Spot AE Point Frame (mode)

Information Displayed

	Shooting Mode	p. 42
	Exposure Compensation	p. 64
	Long Shutter Mode	p. 65
	White Balance	p. 67
	Photo Effects	p. 70
	Compression	p. 45
	Resolution	p. 45
	ISO Speed	p. 71
	Auto Rotate	p. 72
	Focus Lock	p. 58
	AE Lock	p. 60
	FE Lock	p. 61
	Flash	p. 47
	Shooting Method	p. 51-52
	Macro/Infinity	p. 49
	Metering Mode	p. 63
	Movie Recording	p. 56
	Digital Zoom	p. 50
	Camera Shake Warning	p. 29
	Low Battery	p. 21

- The icons in the shaded boxes above display regardless of the selected display mode.
- Zoom powers reflect the optical and digital zoom functions in combination. These figures display when the digital zoom is activated.

Replay Mode (Standard Display)

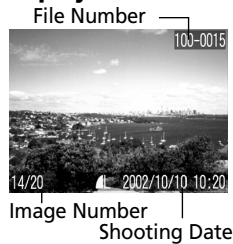

File Number

Image Number
Shooting Date

The following information is displayed in standard display mode.

	Compression	p. 45
	Resolution (still image)	p. 45
	Wave Format Sound	p. 57
	Movie	p. 57
	Protection Status	p. 86



32 | Basic Functions

Replay Mode (Detailed Display)

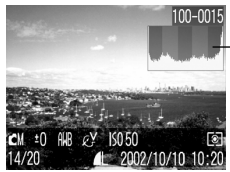

Histogram

In detailed display mode, the following supplementary information is displayed.

	Long Shutter Mode	p. 65
	Shooting Mode	p. 42
	Exposure Compensation	p. 64
	White Balance	p. 67
	Photo Effects	p. 70
	ISO Speed	p. 71
	Flash	p. 47
	Macro/Infinity	p. 49
	Metering Method	p. 63
	Resolution (Movie)	p. 45
	Movie Length Shown on Movie Files	p. 56

The following information may also be displayed with some images.



	A sound file in a format other than the WAV format is attached or the file format is not recognized.
	JPEG file with format not conforming to Design rule for Camera File System Standards
	RAW format file
	File with unrecognized format



- The image information may not display correctly if images shot with this camera are replayed on other cameras or images from other cameras are replayed on this camera.

- Histogram Function**

The histogram is a graph that allows you to judge the brightness of the recorded image. The greater the bias toward the left, the darker the image. The more it trends to the right, the brighter the image. If the image is dark, adjust the exposure to a positive value. Similarly, adjust the exposure to a negative value to darken a bright image (p. 64).

Histogram Examples



Dark Image



Balanced Image



Bright Image





Using the Viewfinder

The optical viewfinder can be used to conserve power by setting the LCD monitor to Off (p. 29) while shooting. The field of vision is approximately 82% at the telephoto end setting.

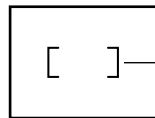

Shows the center of the image

Viewfinder



- **About the Autofocus Function**

This camera employs AiAF (artificial intelligence autofocus) technology which uses a broad metering field to calculate the focal distance with high precision. It delivers a crisp focus even when the photographic subject is slightly off-center. The AiAF function can be turned off so that the autofocus is metered from a fixed AF frame at the center of the field to accommodate difficult shooting conditions (p. 62).

- **Image Seen in Viewfinder vs. Recorded Image**

Please note that the actual image may differ from the image seen in the optical viewfinder due to the physical separation between the viewfinder and lens. This is called the parallax phenomenon and is more noticeable the closer the subject is to the lens. In some cases, portions of images shot up close that appear in the viewfinder will not appear in the recorded image. You are recommended to use the LCD monitor to shoot images up close.





Pressing the Shutter Button

The shutter button features a two-stage action.

Pressing Halfway

Pressing halfway automatically sets the exposure, focus and white balance.

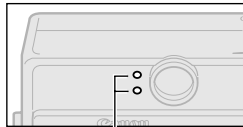
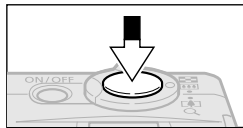

Indicator

- **Indicator Status**

- **Upper Indicator**

- Green: Metering complete (two beeps sound)
- Orange: Flash will fire
- Blinking Orange: Camera shake warning/Insufficient exposure

- **Lower Indicator**

- Yellow: Macro mode/Infinity mode/Focus lock (Method 2, p. 58)
- Blinking Yellow: Focusing difficulty* (single beep sounds)

* When the indicator blinks yellow, lock the focus before shooting (p. 58).

- **AF Frame Status (LCD Monitor On)**

- **AiAF On**

- Green Frame: Metering complete (AF frame when focus achieved)
- No Frame: Focusing difficulty

- **AiAF Off (Center AF Frame)**

- Green Frame: Metering complete
- Yellow Frame: Focusing difficulty





Pressing Fully

Pressing the shutter button down fully activates the shutter and causes one shutter sound to sound.

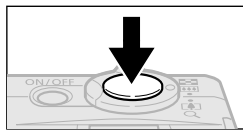

- While the image is being recorded to the CF card, the indicator blinks green.



• AF-assist Beam

- The AF-assist Beam will sometimes emit when the shutter button is pressed halfway to assist focusing in certain conditions, i.e., dark conditions.
- The AF-assist Beam can be turned off (p. 119). If animals are your subject, turn off the beam when shooting in the dark to avoid startling them (this may however, make it more difficult for the camera to focus).







36 | Basic Functions

Using the Zoom

The zoom can be adjusted from 35 mm to 70 mm in 35 mm film equivalent terms.

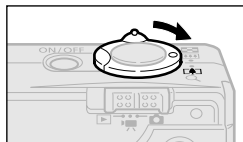
Telephoto/Wide Angle



- Press the zoom lever toward  to zoom in (telephoto).

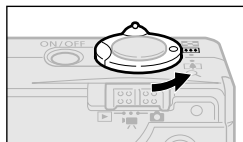

- Press the zoom lever toward  to zoom out (wide angle).



Digital Zoom

When the LCD monitor is on, you can shoot with a combined optical and digital zoom factor of up to 6.4 (p. 50).



- The digital zoom is unavailable in some modes (p. 148).



- Please note that the image appears grainier, the more the image is digitally zoomed.



Selecting Menus and Settings

Menus are used to adjust shooting and replay settings. The procedures for using menus are shown below. For a complete list of the settings and options, please see *Menu Settings and Factory Defaults* (p. 40).

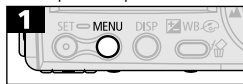

- Press the **MENU** button.

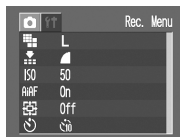

- Menu when the mode switch is set to or . (* The menu will appear slightly different in mode.)



- Menu when the mode switch is set to .

- Use the or buttons to select the Rec., Play or Set up menu.

- Use the or buttons to select an option.

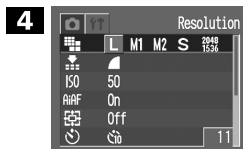

- With some Rec./Set up menu items, the or buttons select the options for the items.

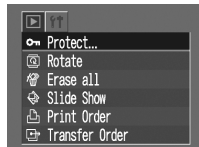

- With some Play/Set up menu items, a submenu appears after you press the **SET** button.

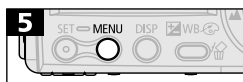

- Press the **MENU** button. The menu will close.



38 | Basic Functions

Selecting Menus and Settings (Cont'd)

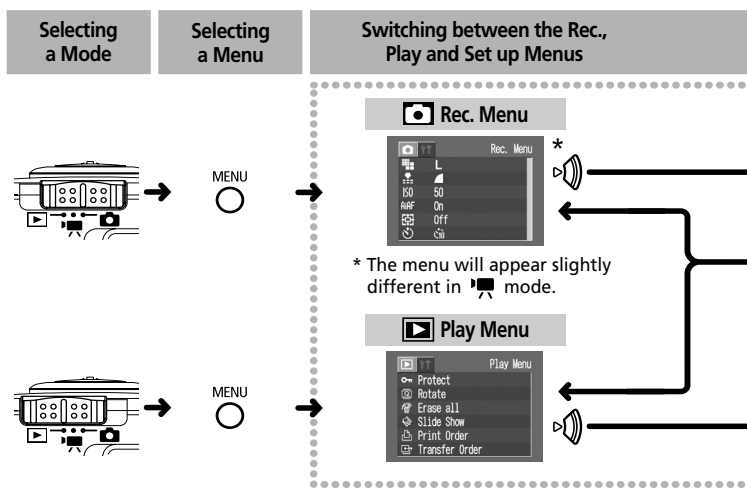

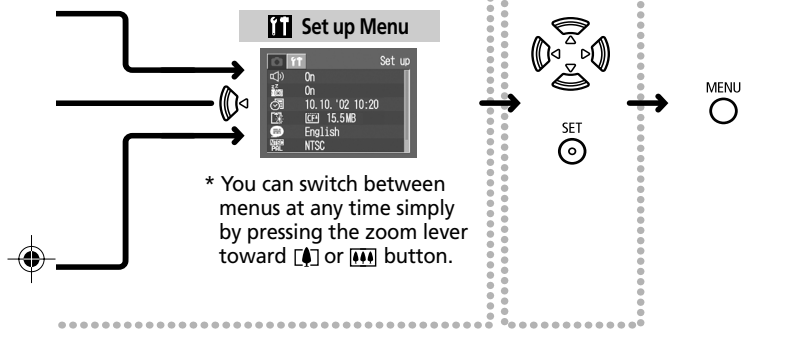

- See *Print Menu Settings* (p. 92) for the procedures used with the  (Print Order) item in the Play menu.





40 | Basic Functions

Menu Settings and Factory Defaults









This chart shows the options and default settings for each menu.

Menu Item	Available Settings	Reference Page
Resolution (Still images)	L 2048 x 1536* / M1 1600 x 1200 / M2 1024 x 768 / S 640 x 480	p. 45
Resolution (Movies)	L 640 x 480 / M 320 x 240* / S 160 x 120	p. 45
Compression	S Superfine / F Fine* / N Normal	p. 45
ISO Speed	50* / 100 / 200 / 400 / AUTO	p. 71
AiAF	On*/Off	p. 62
Digital Zoom	On/Off*	p. 50
Self-timer	10 * / 30	p. 52
Image Review	Off/2*-10 sec.	p. 44
AF-assist Beam	On*/Off	pp. 35, 119
File No. Reset	On/Off*	p. 73
Auto Rotate	On*/Off	p. 72
Long Shutter	On/Off*	p. 65
Protect	Turns image protection On/Off.	p. 86
Rotate	Rotates the image in the display.	p. 81
Erase all	Erases all images on the CF card.	p. 88
Slide Show	Replays selected images in a slide show.	p. 82
Print Order	Sets the print settings.	p. 92
Transfer Order	Sets the transfer settings.	p. 111





Basic Functions | 41

	Menu Item	Available Settings	Reference Page
 Set up Menu (Yellow)	 Beep	On*/Off	p. 123
	 Power Save	On*/Off	p. 27
	 Date/Time	Sets the date and time	p. 23
	 Format	Formats (initializes) the CF card	p. 89
	 Language	English*/ Deutsch / Français / Nederlands / Dansk / Suomi / Italiano / Norsk / Svenska / Español / Chinese / Japanese	p. 25
	 Video System	NTSC/PAL	p. 113
	 Communication	Normal*/PTP	p. 116

* Default setting. Default video system setting varies between regions.

- Some menu items are not available in certain shooting modes.
- With the exception of the [Date/Time], [Language] and [Video System] settings, all the other menu settings and changes made with the camera buttons can be reset to the default values in a single operation (p. 125).





Shooting

Selecting a Shooting Mode

The camera features the following shooting modes.

	Auto	Most settings are automatically selected by the camera.
	Manual	The exposure compensation, white balance and other settings can be manually selected.
	Stitch Assist	Images are shot in overlapping series to create single panoramic images.
	Movie	Shoots movie clips.

- Some settings selected in each shooting mode are saved when the power is turned off (p. 148).



Selecting the , , or mode

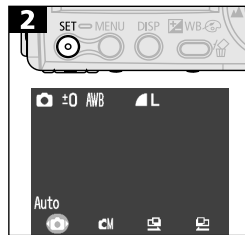
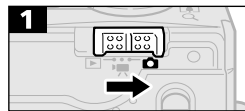

- Use the or button to select a shooting mode.

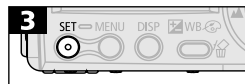



Selecting the mode

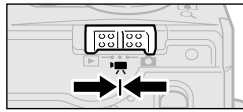

In the descriptions of the shooting functions that follow, the icons beside the titles indicate the applicable shooting modes. Before you proceed with Step 1 in each case, set the camera to one of the shooting modes indicated by the icons in the title (p.2).





44 | Shooting

Reviewing an Image Right after Shooting

Right after a shot is taken, the image appears in the LCD monitor for 2 seconds even if you release the shutter button regardless of whether the LCD monitor is on or off. You can also review it with the following procedures.

- By keeping the shutter button pressed after a shot.
- By pressing the **SET** button while the image is displayed on the LCD monitor. Press the shutter button halfway to stop displaying it.





- You can do the following while the image is displayed.
 - Check the image brightness in the histogram (p. 32).
 - Erase the image (p. 87).
 - Zoom the image in the display (p. 75).

Changing the Review Duration

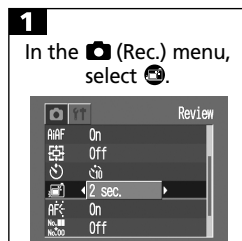
The default review time is 2 seconds. The review function can be set to Off or changed to any time in the range of 2 to 10 seconds in one-second increments.



- See *Selecting Menus and Settings* (p. 37).
- Use the  or  button to select [Off], or a time from [2 sec.] to [10 sec.].
- With the Off option, the image will not automatically display. However, if you keep the shutter button fully pressed after a shot, the image will display.
- In the [2 sec.] to [10 sec.] range, the image will continue to display for the specified time even if the shutter button is released. You can display the image for longer than the set duration by keeping the shutter button pressed all the way.
- Another picture can be taken even while the last is displayed.

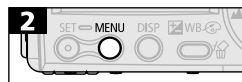

- The display will return to the Rec. screen.











Changing Resolution / Compression Settings

You can change the resolution and compression (excluding movies) settings to suit the purpose of the image you are about to shoot.

Resolution		Purpose	
L (Large)	2048 x 1536 pixels	High ↑ ↓ Low	- Print large prints
M1 (Medium 1)	1600 x 1200 pixels		- Send images as e-mail attachments
M2 (Medium 2)	1024 x 768 pixels		- Shoot more images
S (Small)	640 x 480 pixels		- Print on small labels

Compression		Purpose	
 Superfine	High Quality ↑ ↓ Normal	- Shoot higher quality images	
 Fine		- Shoot normal quality images	
 Normal		- Shoot more images	

Movies can be shot with the following resolution.



Resolution	
 640	640 x 480 pixels
 320	320 x 240 pixels
 160	160 x 120 pixels







46 | Shooting

1

In the  (Rec.) menu, select  or .

- See *Selecting Menus and Settings* (p. 37).

- Use the  or  button to select an option.

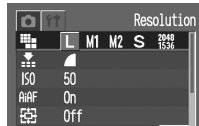

-  Resolution (Still Images)
Select **L**, **M1**, **M2** or **S**.

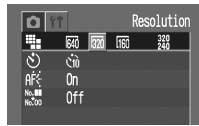

-  Resolution (Movies)
Select **640**, **670** or **160**.

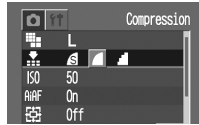

-  Compression
Select **S**,  or .



2



- The display will return to the Rec. screen.



- See *Functions Available in Each Shooting Mode* (p. 148).
- See *Image File Sizes* (p. 140).
- See *CF Cards and Estimated Capacities* (p. 140).





⚡ Using the Flash



	Auto	The flash fires automatically as required by the light level.
	Red-Eye Reduction Auto	The red-eye reduction lamp fires with each shot, automatically adjusting the intensity to suit lighting levels.
	Flash On	The flash fires with every shot.
	Flash Off	The flash will not fire.
	Slow-Synchro	The flash timing is adjusted to slow shutter speeds. This reduces the chance that the background will be dark when shots are taken at night or in rooms with artificial lighting. The red-eye reduction lamp fires with each shot. Use of a tripod is recommended.

	●	●	—	—
	●	●	—	—
	—	●	▲	—
	●	●	▲	—
	—	●	▲	—

- Setting available
- ▲ Can be selected for the first image only.

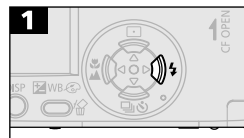

- Press the ⚡ button to cycle through the flash settings.





48 | Shooting





- When you use flash photography at higher ISO speeds, the chances of white streaks appearing in the image increase the closer you approach to the subject.
- Since a slow shutter speed is selected in dark places when the flash is set to Off or Slow-Synchro, take care to avoid blurring the image.

- Shooting in Mode

Be careful to hold the camera still to avoid camera shake.

- Shooting in , or Mode



Fix the camera to a tripod to shoot in these modes since the shutter speed will be slower than in the  mode. If an image is dark in  mode, reshooting it in  mode will make it brighter.

- When shooting with the flash, light may reflect off dust particles or insects in the air and appear as white spots or white asterisks on the image. This occurs more frequently with wide-angle shots. This phenomenon is common to digital cameras and does not indicate a malfunction.



- The flash can be fired when the upper indicator lights a steady orange.
- The flash may take up to approximately 10 seconds to charge. The recharging time will vary with such factors as the shooting conditions and battery charge.
- The flash fires twice. The main flash follows a preparatory pre-flash. The exposure reading obtained from the subject with the pre-flash is used to set the optimal flash intensity for the main flash, which is used to capture the image.

Red-Eye Reduction

- Light reflecting back from eyes can make them appear red when the flash is used in dark areas. Under these conditions, use the red-eye reduction mode. For this mode to be effective, the subject must be looking right at the red-eye reduction lamp. Try asking them to look directly at the lamp. Even better results can be obtained by shooting with the lens set to a wide angle, increasing the lighting in indoor settings or approaching closer to the subject.
- The shutter will not activate for approximately 1 second after the red-eye reduction lamp fires in order to improve the effect. If you want a more immediate shutter response, set the flash to ,  or .





Shooting Close-Ups/Infinity Shots

	Macro	Use this mode to record subjects in the range of 10 to 47 cm (3.9 in. to 1.5 ft.) from the lens tip when at wide-angle end and in the range of 27 to 47 cm (10.6 in. to 1.5 ft.) when at the telephoto end setting.
	Infinity	Use this mode to record landscapes and distant objects. It can also be used for compositions combining both near and distant objects.

								● Setting available. ▲ Selectable for first image only.
	●	●	▲	●	●	●	●	
	—	●	▲	●	●	●	●	

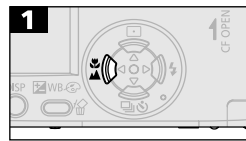

- Display or .

- Use the LCD monitor to compose close-ups in macro mode since the parallax phenomenon may cause images composed with the optical viewfinder to be off-center. (p. 33)
- The exposure may not be optimal when the flash is used in macro mode in the range of 10 to 27 cm (3.9 to 10.6 in.).

Image Area in Macro Mode

	Distance from Lens to Subject	Image Area
Telephoto End	27 cm (10.6 in.)	138 x 103 mm (5.4 x 4.1 in.)
Wide-Angle End	10 cm (3.9 in.)	102 x 76 mm (4.0 x 3.0 in.)





50 | Shooting

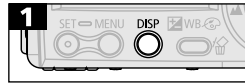

Using the Digital Zoom

When the LCD monitor is on, images can be zoomed to approximately 2.6, 3.2, 4.0, 4.9 or 6.4 times with the combined optical and digital zoom functions.

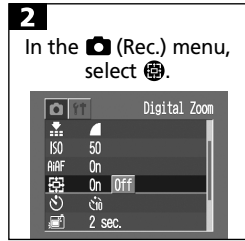

- Turn the LCD monitor on.





- See *Selecting Menus and Settings* (p. 37).
- Use the  or  button to select [On].

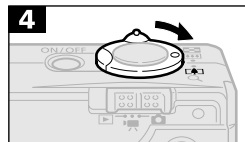

- The display will return to the Rec. screen.



- Press the zoom lever toward  until the lens reaches the maximum optical telephoto setting and stops. Press it again to activate the digital zoom and to advance through the settings.
- Press the  button to zoom back out.



The combined optical and digital zoom factor displays.



- The digital zoom cannot be used when the LCD monitor is turned off.



- Images become coarser the more they are digitally zoomed.





Continuous Shooting



In this mode, the camera shoots continuously at approximately 2 images per second* (Large/Fine, LCD monitor off) while the shutter button is held down. Recording ceases when the shutter button is released.

* This figure reflects standard shooting criteria established by Canon. Actual figures may vary according to the subject and shooting conditions.

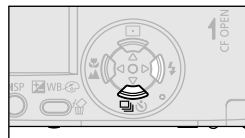

- Display 





- The interval between shots may lengthen slightly when the camera's built-in memory fills.
- If the flash is firing, the interval between shots will lengthen to accommodate the flash's charging requirements.



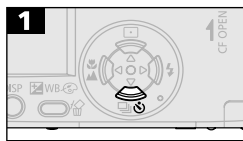

Using the Self-timer





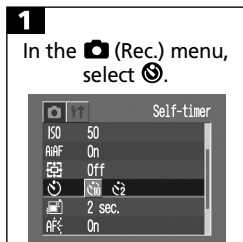

- Display .
- When the shutter button is pressed, the self-timer will activate and the self-timer lamp will blink.

Changing the Self-timer Countdown Time



- See *Selecting Menus and Settings* (p. 37).

- Use the  or  button to select [10 sec.] or [2 sec.]
- When [ (10 sec.)] is selected, the self-timer sounds and the blinking gets faster 2 seconds before the shutter activates.
- When [ (2 sec.)] is selected, the self-timer sounds at the same time as the shutter button is pressed. The shutter activates in 2 seconds.

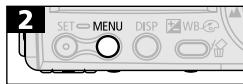

- The display will return to the Rec. screen.





Shooting in Stitch Assist Mode

Stitch Assist mode can be used to shoot overlapping images that can later be merged (stitched) to create one panoramic image on a computer.



The overlapping seams of several adjacent images can be joined into a single panoramic image.



- To merge the images on a computer, use PhotoStitch, one of the supplied programs.

Framing a Subject

The PhotoStitch program detects the overlapping portions of adjoining images and merges them. When shooting, try to include a distinctive item (landmark) in the overlapping portions.



- Compose each frame so that it overlaps 30 - 50% of the adjoining image. Try to keep the vertical misalignment to less than 10% of the image height.
- Do not include moving items in the overlap.





54 | Shooting

- Do not try to stitch images that include both distant and close items. These items may appear warped or doubled up in the merged image.
- Make the brightness in each image consistent. The final image will appear unnatural if the contrast in brightness is too great.
- To shoot landscapes, swivel (pan) the camera around its own vertical axis.
- To shoot close-ups, slide the camera over the subject, keeping it parallel to the subject as you move it.

Shooting

Images can be shot in two sequences in Stitch Assist mode.

	Left to right horizontally
	Right to left horizontally

1
Select the shooting mode (p. 42).

- The LCD monitor turns on when the shooting mode is set to or .



Left to right horizontally

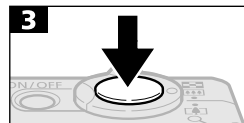

- Shoot the first frame in the sequence.
- The exposure and white balance are set and locked with the first image. Successive images use the same settings.

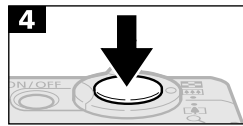

Second Image

- Compose the second image so that it overlaps a portion of the first and shoot.



- Use the or button to check or retake the recorded images.
- Minor discrepancies in the overlapping portions can be corrected when the images are stitched together.

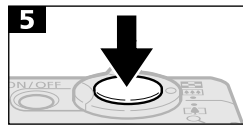

Third Image

- Repeat the procedure for additional images. A sequence may contain up to 26 images.

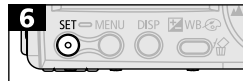

- Press the **SET** button to close Stitch Assist mode.



- A custom white balance setting cannot be set in or mode. To use a custom white balance setting, first set it in another shooting mode (p. 68).
- The settings for the first image are used to take subsequent images in the sequence.
- It is not possible to display images on the TV when shooting in Stitch Assist mode.



- See the *Functions Available in Each Shooting Mode* (p. 148).





Shooting a Movie



Use the movie mode to shoot movie clips. Select a resolution in the **Movie** menu from the **640** (640 x 480), **320** (320 x 240, Default) and **160** (160 x 120) options (p. 45).

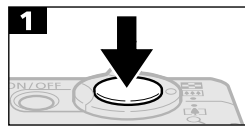

- Press the shutter button fully to start recording images and sounds.
- During shooting the recording time (in seconds) and a red circle appear on the LCD monitor.

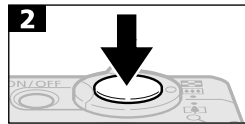

- Press the shutter button again to stop recording.
- The maximum length of a movie clip (at approximately 15 frames/sec.) is approximately 30 sec.* (**640**), 3 min. (**320**) or 3 min. (**160**) according to Canon's testing standard.

* Using an optional Canon FC-256MH CF Card (not sold in some regions)

When using the CF card supplied with the camera, the maximum length is approximately 14 sec.

These times may vary with the subject and shooting conditions. Recording will automatically stop when the maximum is reached or when the CF card runs out of free capacity.

Filming may stop unexpectedly with certain types of CF card (if it is a slow-recording card, if it has been formatted on a different camera or a computer, or if images have been shot and erased repeatedly).





- You are recommended to use a CF card that has been formatted in your camera to shoot movies (p. 89). The card supplied with the camera may be used without further formatting. In addition, you are recommended to use the optional FC-256MH CF Card (not sold in some regions) to shoot movies with the  setting.
- Be careful not to touch the microphone while recording.
- The AE, AF, white balance and zoom settings remained fixed for subsequent frames at the values selected for the first frame.
- After a clip is shot, the upper indicator will blink green while the clip is being written to the CF card. You cannot shoot again until the blinking stops.



- See the *Functions Available in Each Shooting Mode* (p. 148).
- Sound is recorded monaurally.
- The shutter sound will not sound when you fully press the shutter button to record a movie clip.
- QuickTime 3.0 or later is required to replay movie files (AVI/Motion JPEG) on a computer. QuickTime (for Windows) is included on the Canon Digital Camera Solution Disk. On the Macintosh platform, this program is generally bundled with Mac OS 8.5 or later operating systems.





Locking the Focus (AF Lock)



It may be difficult to focus on the following types of subjects. Use the focus lock in these situations.

- Subjects with extremely low contrast to the surroundings
- Subjects with extremely bright objects at the center of the composition
- Subjects that are moving quickly
- Subjects through glass :
Try to shoot as close to the glass as possible to reduce the chances of light reflecting back off the glass.

Shooting with the Focus Lock

Method 1

1. Aim the camera so that an object at the same focal distance as the main subject is centered in the AF frame in the viewfinder or LCD monitor.
2. Press the shutter button halfway and wait until two beeps sound.
3. Re-aim the camera to compose the shot as desired and press the shutter button all the way.



Method 2



- Turn the LCD monitor on.
- Aim the camera so that an object at the same focal distance as the main subject is centered in the AF frame.

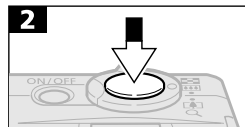

- Press and hold the shutter button halfway until two beeps sound. Without releasing your finger, press the / button.

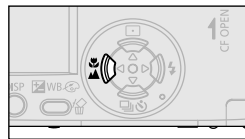



- The icon will display and the lower indicator will light yellow.



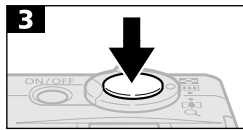

Shooting | 59



- Re-aim the camera to compose the shot as desired and press the shutter button all the way.
- Release the focus lock by pressing the  /  button.



- Method 2 is convenient because you can let go of the shutter button to recompose the image. Moreover, the focus remains locked after the picture is taken, allowing you to capture a second image with the same focus.
- In Method 2, pressing the zoom lever, MENU button or DISP button, or changing the shooting mode also releases the focus lock.





Locking the Exposure Setting (AE Lock)

You can set the exposure and focus separately. This is effective when the contrast is too strong between the subject and background or when a subject is backlit.



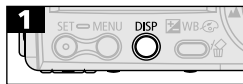

- You must set the flash to . The AE lock cannot be set if the flash fires.

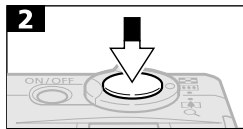

- Turn on the LCD monitor.
- Focus the camera on the subject on which you wish to lock the exposure setting.



- Press the shutter button halfway and wait until two beeps sound.
- Without releasing your finger, press the  button.
- The  icon will display.

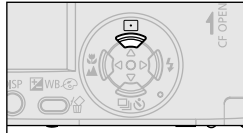

- Re-aim the camera to compose the shot.
- To release the AE lock, press the  button.

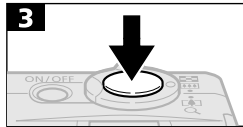

- The AE lock may release if you press any button other than the  button.





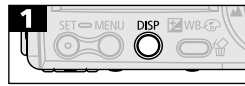

Locking the Flash Exposure Setting (FE Lock)

You can lock the flash exposure so that the exposure settings are correctly set for a particular portion of your subject.

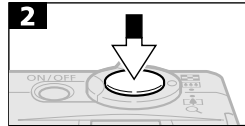

- Turn on the LCD monitor.
- Set the flash to  and focus on the part of the subject on which you wish to lock the flash exposure setting.



- Press the shutter button halfway and wait until two beeps sound.
- Without releasing your finger, press the  button.
- The flash will fire a pre-flash and lock the flash exposure to the required intensity to illuminate the subject.
- The  icon will display.

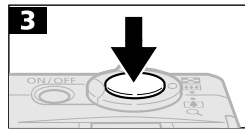
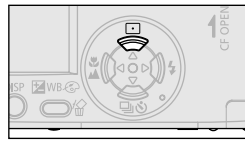

- Re-aim the camera to compose the shot and press the shutter button all the way.
- To release the FE lock, press the  button.



- The FE lock may release if you press any button other than the  button.





Switching between Autofocus Modes

Although the autofocus function is preset to the AiAF setting (nine AF frames), you can set the AF frame to center-point. When center-point is selected, the AF frame will appear in the LCD monitor if it is turned on (p. 29). The AF frame will not appear when AiAF is selected.

No frame	<input checked="" type="checkbox"/> On	The camera detects the subject and highlights the AF frames, from 9 available points, that it will use to determine the focus.
	<input type="checkbox"/> Off	The camera focuses using the center AF frame. This is convenient for focusing on a specific part of a subject with greater certainty.

• The symbol represents the AF frames as they appear in the LCD monitor.

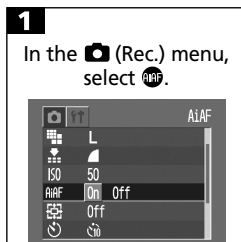

• See *Selecting Menus and Settings* (p. 37).



• Use the  or  button to select [On] or [Off].



• A shot can be taken immediately after.

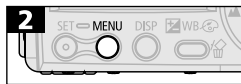



• The display will return to the Rec. screen.





Switching between Light Metering Modes

You can switch between metering modes to shoot.

	Evaluative Light Metering	Appropriate for standard shooting conditions, including backlit scenes. The camera divides images into several zones for light metering. It evaluates the complex lighting conditions, such as the position of the subject, the brightness, the direct light, and the backlighting, and adjusts the settings to the correct exposure for the main subject.
	Spot AE Point	Meters the area within the spot AE point at the center of the LCD monitor. Use this mode when the subject is backlit or surrounded by strong light.

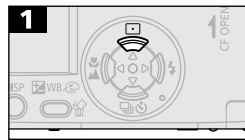

- Display  or .







64 | Shooting

Adjusting the Exposure Compensation

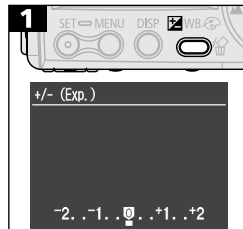
Adjust the exposure compensation setting to avoid making the subject too dark when it is backlit or shot against a bright background or to avoid making lights appear too bright in night shots.



- Use the  or  button to adjust the exposure compensation.
- The settings can be adjusted in ± 2 stops in 1/3-stop increments.
- You can confirm the effect of the exposure compensation setting in the LCD monitor when the LCD monitor is on.
- A shot can be taken immediately after. The menu will reappear after the shot, allowing you to further adjust the setting.



- Reset the exposure compensation by returning the setting to 0.



Shooting in Long Shutter Mode

You can set the shutter speed to a slow setting to make dark subjects appear brighter.



- See *Selecting Menus and Settings* (p. 37).

- Use the **(On)** or **(Off)** button to select [On].

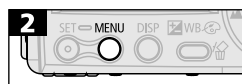

- The display will return to the Rec. screen.

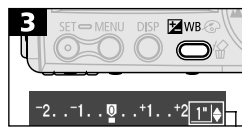

Long Shutter Menu

- Use the **(WB)** or **(WB)** button to select the long shutter menu and the **(WB)** or **(WB)** button to select a shutter speed.

- A shot can be taken immediately after. The menu will reappear after the shot, allowing you to further adjust the setting.
- While the menu is displayed, press the long shutter mode and finish the procedure.

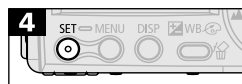



66 | Shooting



- The nature of CCD image sensors is such that noise in the recorded image increases at long shutter speeds. This camera, however, applies special processing to images shot at shutter speeds slower than 1.3 seconds to eliminate the noise, thereby producing high-quality images. Nevertheless, a certain amount of processing time may be required before the next image can be shot.



- Use the LCD monitor to confirm that the image was recorded at the desired brightness.
- Use of the flash may result in an over-exposed image. If that occurs, shoot with the flash set to .
- The following are unavailable:
 - Exposure Compensation
 - Light Metering
 - AE Lock
 - ISO speed [AUTO]

- **Available Shutter Speeds**

The following shutter speeds (in seconds) are available.
1, 1.3, 1.6, 2, 2.5, 3.2, 4, 5, 6, 8, 10, 13, 15



WB Setting the White Balance



When the white balance mode is set to match the light source, the camera reproduces colors more accurately.

	Auto	The camera sets the white balance automatically according to shooting conditions.
	Daylight	For recording outdoors on a bright day.
	Cloudy	For recording under overcast, shady or twilight skies.
	Tungsten	For recording under tungsten and bulb-type 3-wavelength fluorescent lighting.
	Fluorescent	For recording under warm-white, cool-white or warm-white (3-wavelength) fluorescent lighting.
	Fluorescent H	For recording under daylight fluorescent, or daylight fluorescent-type 3-wavelength fluorescent lighting.
	Custom	For setting a custom value with a white sheet of paper, etc., to obtain the optimal white balance for the conditions.



- Press the **WB** button repeatedly until the White Balance Settings menu displays.
- Use the or button to select a setting. (See the next page for)
- You can confirm the effect of the setting in the LCD monitor when the LCD monitor is on.
- A shot can be taken immediately after. The menu will reappear after the shot, allowing you to further adjust the setting.



- This setting cannot be adjusted when the (Sepia) or (B/W) photo effects are selected.





68 | Shooting

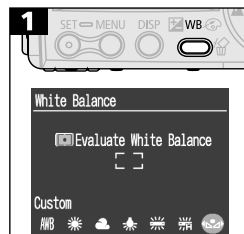

Setting a Custom White Balance

You can set a custom white balance to obtain the optimal setting for the shooting conditions by having the camera evaluate an object, such as a piece of white paper or cloth, or a photo-quality gray card that you wish to establish as the standard white color.



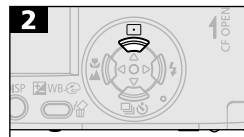



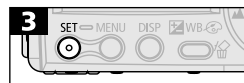

- Press the **WB** button repeatedly until the White Balance Settings menu displays.
- Use the  or  button to select .



- Aim the camera at the white paper, cloth or gray card and press the  button.
- Aim the camera so that the white paper, cloth or gray card completely fills the frame on the LCD monitor or the entire viewfinder before pressing the  button. The camera reads the white balance data when you press the  button.
- A shot can be taken immediately after. The menu will reappear after the shot, allowing you to further adjust the setting.





- You are recommended to set the shooting mode to  and the exposure compensation setting to zero (± 0) before setting a custom white balance. The correct white balance may not be obtained when the exposure setting is incorrect (image appears completely black or white).
- It is also advisable to use the LCD monitor to compose the shot and to zoom in to the telephoto end setting.
- Since the white balance data cannot be read in  and  mode, preset the white balance in another shooting mode first before selecting the  or  mode.
- Set the flash on or off when setting a custom white balance. The white balance may not be accurate if the setting conditions and shooting conditions are not the same. If the flash fires when setting a custom white balance with the flash set to  or , ensure that you also use the flash when you go to shoot.





Changing the Photo Effect



You can shoot with different photo effects.

	Photo Effect Off	Records with no effect.
	Vivid	Emphasizes the contrast and color saturation to record bold colors.
	Neutral	Tones down the contrast and color saturation to record neutral hues.
	Low Sharpening	Records subjects with softened outlines.
	Sepia	Records in sepia tones.
	B/W	Records in black and white.

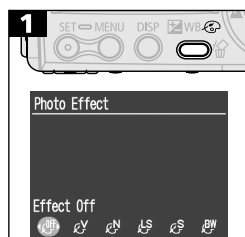

- Press the button repeatedly until the Photo Effect Setup menu displays.
- Use the or button to select [Photo Effect].
- You can confirm the photo effect in the LCD monitor when the LCD monitor is on.
- A shot can be taken immediately after. The menu will reappear after the shot, allowing you to further adjust the setting.

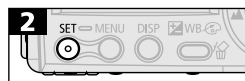



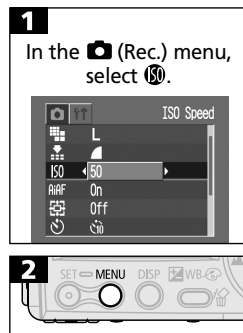

Adjusting the ISO Speed

Adjust the ISO speed when you wish to shoot in a dark area or use a fast shutter speed.



- See *Selecting Menus and Settings* (p. 37).
- Use the  or  button to select a setting.
- The display will return to the Rec. screen.



- Higher ISO speeds increase image noise. To take clean images, use as low an ISO speed as possible.





Setting the Auto Rotate Function



Your camera is equipped with an Intelligent Orientation sensor that detects the orientation of an image shot with the camera on end and automatically rotates it to the correct viewing orientation in the display. You can set this function on/off.

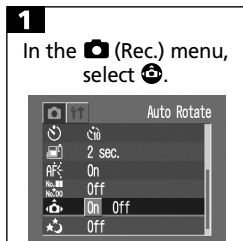

- See *Selecting Menus and Settings* (p. 37).

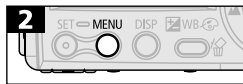

- Use the or button to select [On] or [Off].

- The display will return to the Rec. screen.
- When the Auto Rotate function is set to On and the LCD monitor is set to the detailed display mode, the icon (normal), icon (right end is down) or icon (left end is down) will appear in the upper right of the display.



- When the camera is held on end to shoot, the Intelligent Orientation sensor judges the upper end to be “up” and the lower end to be “down.” It then regulates the optional white balance, exposure and focus for vertical photography. This function operates regardless of the On/Off status of the Auto Rotate function.
- When changing the camera’s orientation between the horizontal and vertical positions, you may hear noise coming from the orientation detection mechanism. This is not a malfunction.



- This function may not operate correctly when the camera is pointed straight up or down. Check that the arrow is pointing in the right direction and if it is not, then set the Auto Rotate function to [Off].
- Even if the Auto Rotate function is set to on, the orientation of images downloaded to a computer will depend upon the software used to download the images.



Resetting the File Number



You can select the way file numbers are assigned.

On	The file number is reset to the start (100-0001) each time a new CF card is inserted. New images recorded on CF cards with existing files are assigned the next available number.
Off	The file number of the last image to be shot is memorized so that images recorded to a new CF card start from the next number.

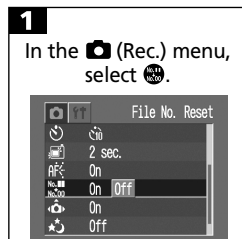

- See *Selecting Menus and Settings* (p. 37).

- Use the or button to select [On] or [Off].

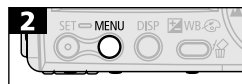

- The display will return to the Rec. screen.



- Setting the File No. Reset to Off is useful for avoiding file name duplication when images are downloaded to a computer.

• About File Numbers

Images are assigned file numbers from 0001 to 9900 and organized in folders generally containing up to 100 images. Folders are assigned numbers from 100 to 998 (a folder with 99 in the last two digits cannot be created). Since images shot in the , , or mode are always saved in the same folder, some folders may contain 101 or more images.



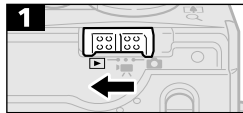

Replaying

Displaying Images Individually

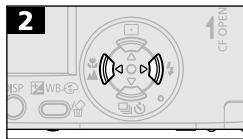

- Turn the mode switch to the  position.
- The last recorded image will appear in the display (single image replay).



- Use the  button to move to the previous image and the  button to move to the next. Holding the button down advances the images more rapidly, but the images will not appear as clearly.





🔍 Magnifying Images

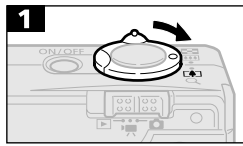

- Images can be magnified up to approximately 10 times.



Approximate Location of the Magnified Area

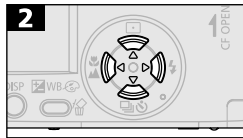

- Use the / / / buttons to move around the image.
- Hold the **SET** button down and press the zoom lever toward to cycle through each setting, from approximately 2.5 times, to approximately 5 and 10 times.
- Press the zoom lever toward to cease magnifying the image.



- Movie frames and index replayed images cannot be magnified.





76 | Replaying

Viewing Images in Sets of Nine (Index Replay)

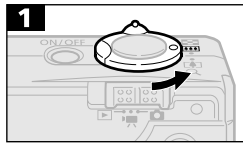

- Up to nine images can be viewed at once in index replay.

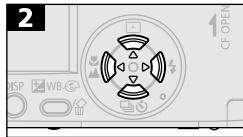

- Use the / / / buttons to change the image selection.
- Press the zoom lever toward to display the selected image in single image replay.



Switching between Sets of Nine Images

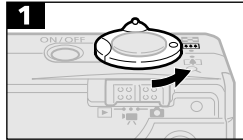

- Successive sets of nine images can be shown in the display.

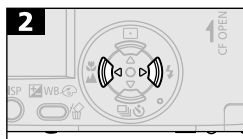

- Use the button to move to the previous set and the button to move to the next.
- Hold the **SET** button down and press the or button to jump to the first or last set.
- Press the zoom lever toward to return to standard index replay.





Viewing Movies



Movie clips can be replayed with the following procedures.



- Movies cannot be played in the index replay mode.

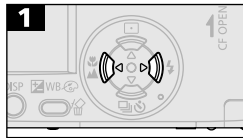

- Use the or button to select a movie.
- Images with a **SET** icon are movies.

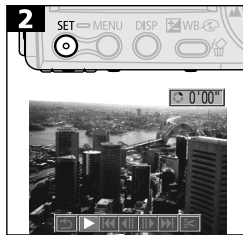

- The movie control panel will display.
- Use the or button to select (Play).



- The movie images will play.
- When a movie is finished, it stops and displays its last frame.





78 | Replaying

Pausing and Resuming Play



- Press the **SET** button to pause the movie. Press it again to resume.

Fast Forwarding/Rewinding

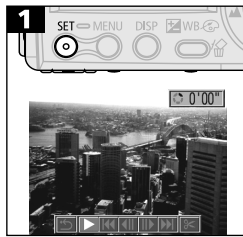

- Use the or button to select one of the following.

Return to Single Image View

Play

Previous Frame

[Rewinds if **SET** button is held down]

Next Frame

[Fast Forwards if **SET** button is held down]

First Frame

Last Frame

Switch to Movie Editing Mode (p. 79)

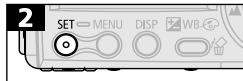

- The sound can also be played when a movie is displayed on a TV (p. 113).



- You may experience frame dropping and audio breakup when replaying a movie on a computer with insufficient system resources.
- Movies shot with other cameras may not replay on this camera. See the *List of Messages* (p. 126).



Editing Movies



Selecting (Edit) in the movie control panel enables you to cut unwanted portions at the start or end of a movie clip.



- Protected movies and movies less than 1 second in duration cannot be edited.

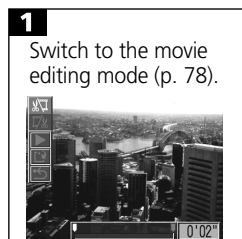

- Use the or button to select (Cut Beginning) or (Cut End) and the or button to set the portion to which the cut is applied.
- When (Cut Beginning) is selected, the left hand cursor moves and when (Cut End) is selected, the right hand cursor moves.



- Use the or button to select (Play).

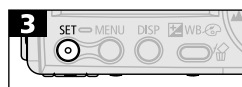

- A preview of the temporarily edited movie clip plays. To stop it, press the **SET** button again.

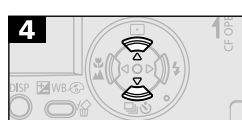

- Use the or button to select (Save) to keep the edits (p. 80). If you use the or button to select (Close Movie Editing/Return to Movie Control Panel), the edits are not saved and the editing mode is canceled.



80 | Replaying



- Use the or button to select [New File] or [Overwrite].
 - [New File] saves the edited movie under a new file name. The pre-edit data is left unchanged.
 - [Overwrite] saves the edited movie with its original file name. The pre-edit data is lost.

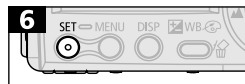

- When the CF card lacks sufficient space to create a new file, only [Overwrite] can be selected. A small ▲ symbol will appear in the time display on the movie in that case.



- The minimum duration of an edited movie is 1 second.
- It may take approximately 3 minutes to save an edited movie. If the battery pack runs out of charge partway through, edited movie clips cannot be saved. When editing movies, use a fully charged battery pack or the optional AC Adapter Kit ACK500 (P. 130).



Rotating Images in the Display

Images can be rotated clockwise 90° or 270° in the display.



0°(Original)

90°

270°



- See *Selecting Menus and Settings* (p. 37).

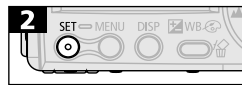

- Use the  or  button to select the image to be rotated.

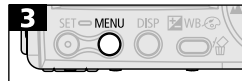

- Cycle through the 90°/270°/0° orientations with each press of the **SET** button.
- Press the **MENU** button repeatedly until the replay screen reappears to finish the procedure.



- Movies cannot be rotated.
- When images are downloaded to a computer, the orientation of images rotated by the camera will depend upon the software used to download the images.



- Images taken vertically with the Auto Image Rotate (p. 72) set to [On] will automatically be rotated to the vertical position when viewed on the camera's LCD monitor.



82 | Replaying

Automated Playback (Slide Shows)

Starting a Slide Show

A selection of images or all the images on a CF card can be displayed one-by-one in an automated slide show.

Slide show image settings are based on DPOF standards (p. 90).



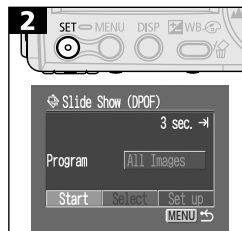

All Images	Plays all images on the CF card in order.
Slide Show 1-3	Plays the images selected for each slide show in order.

1
In the  (Play) menu, select .

- See *Selecting Menus and Settings* (p. 37).



- The Slide Show menu will display.

- Use the  or  button to select [Program] and the  or  button to select [All Images], [Show 1], [Show 2] or [Show 3].

- Use the  or  button to select [Start].

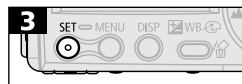

- The slide show will start and automatically stop at the end of the show.



- Press the **MENU** button repeatedly until the replay screen reappears to finish the procedure.



- Movies play for their entire recorded length regardless of the time set in the slide show settings.
- The power-saving function does not activate during a slide show (p. 27).



Pausing / Resuming a Slide Show

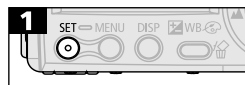

- Press the **SET** button to pause the slide show. Press the **SET** button again to restart it.

Fast Forwarding / Rewinding a Slide Show

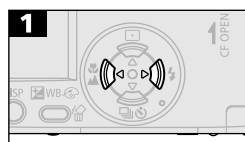

- Use the or button to display the previous or next image. Hold down the button to advance through the images more rapidly.

Stopping a Slide Show

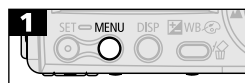

- Press the **MENU** button to stop the slide show and redisplay the Slide Show menu.

Selecting Images for Slide Shows

You can mark images for inclusion in slide shows 1-3. Up to 998 images may be marked per slide show. Images display in the order of their selection.

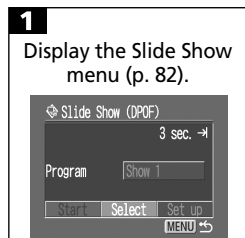

- Use the button to select [Program] and the or button to select [Show 1], [Show 2] or [Show 3].
- Use the button and the or button to choose [Select].



84 | Replaying

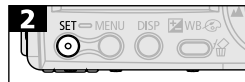

- A white checkmark will appear beside a show already containing images.

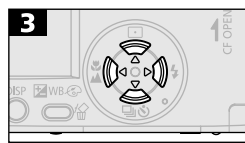

- Use the or button to move between images and the or button to select or deselect them. Selected images display a number corresponding to their selection order and a white checkmark .



- You can press the zoom lever toward to switch to the index mode (3 images) and use the same procedures to select images.



- While in index replay, you can clear all of the images by pressing the **SET** button, using the or button to select [Clear all] and pressing the **SET** button again.





- Press the **MENU** button repeatedly until the replay screen reappears to finish the procedure.



Adjusting the Play Time and Repeat Settings





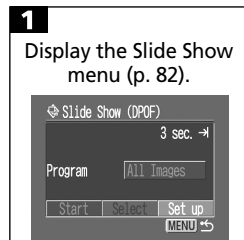

You can change the play time for all the images in a show and have the show repeat continuously.

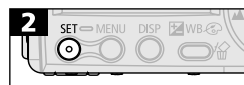
 Play Time	Sets the duration that each image displays. Choose between 3-10 seconds, 15 seconds, 30 seconds and Manual.
 Repeat	Sets whether the slide show stops when all the slides have been displayed or continues until stopped.



- Use the  or  button to select [Set up].



- Use the  or  button to select  or  and the  or  button to select an option.



-  Select a play time.



-  Select [On] or [Off].

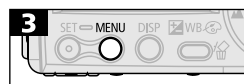

- Press the **MENU** button repeatedly until the replay screen reappears to finish the procedure.



- The display interval may vary slightly from the set time for some images when played.
- Slide shows are easy to arrange on a computer with the supplied software. See the *Software Starter Guide*.



86 | Replaying





Protecting Images

You can protect important images from accidental erasure.

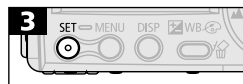

- See *Selecting Menus and Settings* (p. 37).



- Use the  or  button to select an image to protect.
- Press the **SET** button to protect the image. Press the **SET** button again to remove the protection.
- You can make the selection of images easier by toggling between single image replay and index replay by pressing the zoom lever toward  / .



Protection Icon

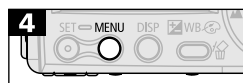

- Press the **MENU** button repeatedly until the replay screen reappears to finish the procedure.



- Please note that formatting (initializing) a CF card erases all data, including protected images.







Erasing

Erasing Single Images



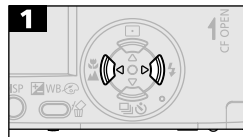

- Please note that erased images cannot be recovered. Exercise adequate caution before erasing a file.
- Protected images cannot be erased with this function.

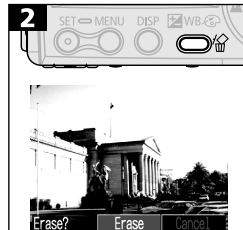

- Use the  or  button to select an image for deletion.



- Use the  or  button to select [Erase].
- To exit instead of erasing, select [Cancel].

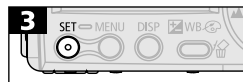



88 | Erasing

Erasing All Images



- Please note that erased images cannot be recovered. Exercise adequate caution before erasing a file.
- Protected images cannot be erased with this function.



1

In the  (Play) menu, select .

- See *Selecting Menus and Settings* (p. 37).

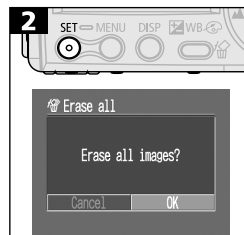
2



- Use the  or  button to select [OK].
- To exit instead of erasing, select [Cancel].

3



Formatting CF Cards

New CF cards must be formatted with the following procedures before use.

- Please note that formatting (initializing) a CF card erases all data, including protected images and other file types.

1
In the **SET** (Set up) menu, select **CF**.

- See *Selecting Menus and Settings* (p. 37).

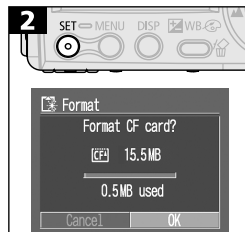

- Use the **OK** or **DISP** button to select [OK].
- To exit instead of formatting, select [Cancel].

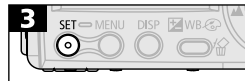

- When the camera is malfunctioning, a corrupted CF card might be the cause. Reformatting the CF card may solve the problem.
- When a non-Canon brand CF card is malfunctioning, reformatting it may solve the problem.
- CF cards formatted in other cameras, computers, or peripheral devices may not operate correctly in this camera. When that happens, reformat the CF card with this camera. If formatting in the camera doesn't work properly, turn the camera off and re-insert the CF card. Then turn the camera back on and format again.



Printing

About Printing

This camera supports direct printing. By connecting the camera to an optional printer or Bubble Jet printer (sold separately) that supports the camera's direct print function, you can send the images from the CF card directly to the printer using the camera buttons. In addition, you can have prints made to specification by a photo developing service by sending your CF card with the DPOF (Digital Print Order Format) print settings set in advance on your camera. Please refer to the *System Map* supplied with your camera for direct print function compatible printer information.



Digital Camera



DPOF Print Settings

- Select the images you wish to print (p. 103).
▼
- Set the number of print copies (p. 104).
▼
- Set the print style (p. 106).
 - Standard/Index.
 - Date: On/Off.
 - File Numbers: On/Off.

DPOF Transfer Order

- Select the images to send by email (p. 111)
Software that supports DPOF transfer order settings is required

CF Card



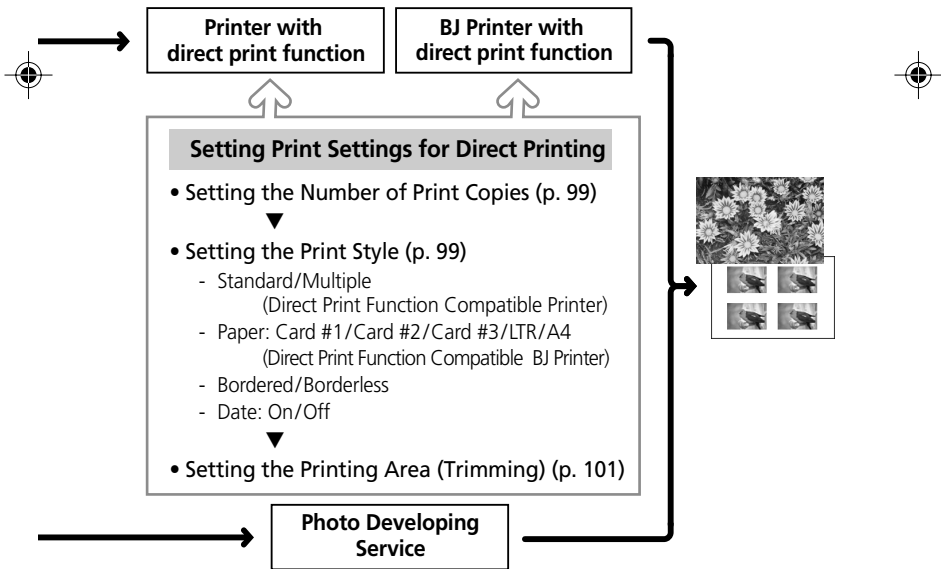



92 | Printing

Print Menu Settings

Use the Print menu to set print related settings. The following diagrams illustrate how to use the Print menu.

Direct Print Function

Set the Mode Switch to

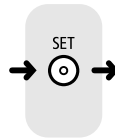

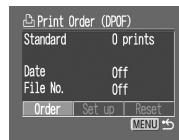
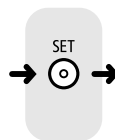
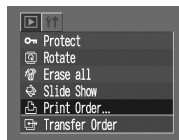

DPOF Print Settings

Set the Mode Switch to





-  MENU
Turn the menu On/Off.
-  Selects items and settings.
-  SET
Sets items and settings.

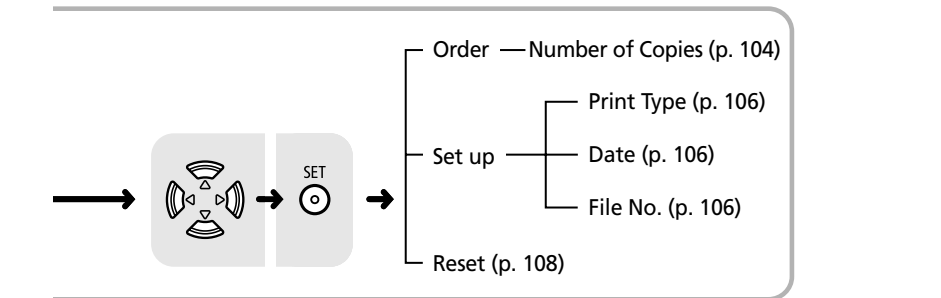
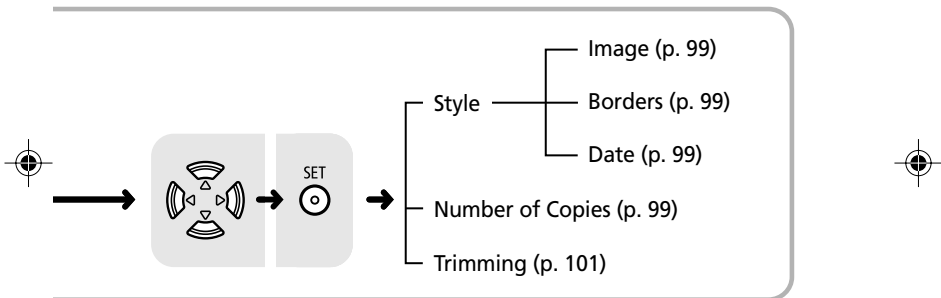



Connecting a Printer

You can make clear prints swiftly and easily when you connect the camera to a direct print function compatible printer (sold separately) or a direct print function compatible BJ printer (sold separately). You can also print using DPOF print settings.



- You are recommended to use the optional AC Adapter Kit ACK500 (sold separately) rather than the battery pack to power the camera when it is connected to a printer. If you do use a battery pack, ensure that it is fully charged and monitor the battery charge while printing.



- Please see the *System Map* supplied with your camera for the list of direct print function compatible printers.
- Please see your printer's user guide for information about installing paper and ink cassettes/tanks.



Connecting to a Direct Print Function Compatible Printer

Your printer should come equipped with two direct interface cables. To connect to this camera, please use the cable (DIF-200) that has the ► symbol on its connector.

1

Shut the camera's power off (p. 26).

2

To an Electrical Outlet

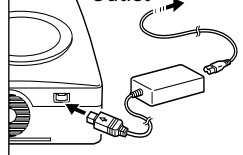

- Attach the power cable to the printer and insert its plug into a power outlet.
- You can also power the printer with a rechargeable battery if it is so equipped. Please see your printer's user guide.



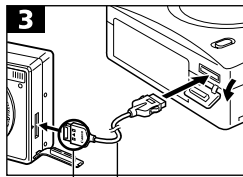



Direct Interface Cable (DIF-200)

Align the ► symbols on the camera and cable to connect them.

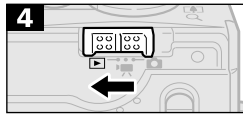
- Attach the direct interface cable to the printer.
- Open the terminal cover on the camera and insert the cable's connector into the camera's DIGITAL • A/V OUT terminal. Orient the cable so that the connector's ► symbol faces the camera's front panel.



- Press the printer's ON/OFF button to turn on its power. (If you are using Card Photo Printer CP-10, the printer's power will turn on in Step 2 when printer and power cable are connected.)
- Set the mode switch to the  position and turn on the camera's power.
-  will display when the printer is correctly connected.



This shows when a direct print function compatible printer is connected.



Connecting to a Bubble Jet Printer



- Please read the *Quick Start Guide* supplied with your BJ printer to see if it is compatible with the camera's direct print function, and for instructions regarding the connection cables and the printer's general operation.

1

Shut the camera's power off (p. 26).





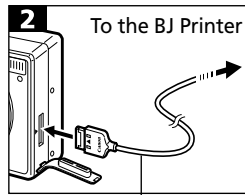

96 | Printing

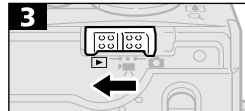

Interface Cable



- Turn the BJ printer's power on after you have connected the power cord to the BJ printer and inserted the other end in a power outlet.
- Attach the interface cable to the BJ printer.
- Open the terminal cover on the camera and insert the cable's connector into the camera's DIGITAL • A/V OUT terminal. Orient the cable so that the word Canon on the connector faces the camera's front panel.

- Set the mode switch to the  position and turn on the camera's power.
-  will display when the printer is correctly connected.





This shows when a BJ printer is connected.



- Ensure that you push the [Push] button on the connector to remove the cable from the camera's DIGITAL • A/V OUT terminal.



- The following cannot be conducted while the printer is connected.
 - Playing movies
 - Setting the language with the SET and the MENU button combination.
- When the printer is disconnected, the  or  symbol will disappear from the LCD monitor and the camera will revert to the standard replay mode.





Printing

- The following illustrations show examples from a direct print function compatible printer. Options for the Style category will differ slightly for BJ printers.

Print images displayed in single image replay or index replay mode.

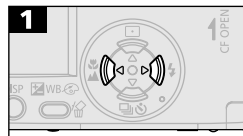

- Use the or button to select the images you wish to print.

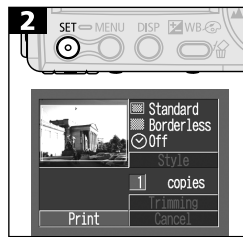

- Specify the number of print copies, print style and print area as required.
 - Setting the Number of Print Copies (p. 99)
 - Setting the Print Style (p. 99)
 - Setting the Printing Area (Trimming) (p. 101)
- Use the / / / buttons to select [Print].
- To quit the procedure instead, select [Cancel].

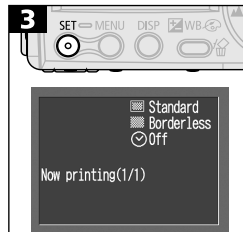

- Press the **SET** button to start printing.
- The replay screen will reappear when printing is successfully concluded.



- Movies cannot be printed.





98 | Printing



- **Canceling Printing**

Press the **SET** button to stop printing. A confirmation message will display. Use the **⏪** or **⏩** button to select [OK] and press the **SET** button.

- **Direct Print Function Compatible Printers**

A print in progress cannot be stopped. The printer will stop after the current print is complete and the camera will display its replay screen at that point.

- **BJ Printers**

The printer will stop printing the current image and eject the paper.

- **Printing Errors**

An error message will display if an error occurs while printing (p. 128, 129). Use the **⏪** or **⏩** button to select [Stop] or [Resume] and press the **SET** button. (With a BJ printer, the print will automatically restart if the error is resolved.)

- **Direct Print Function Compatible Printers**

The Resume option may not appear with some types of error. In that case, select Stop.

- **BJ Printers**

The type of error will determine whether the Continue or Stop options appear. An error number will appear on the BJ printer's operation panel. See the printer's user guide for the recommended course of action for each error type.



Setting the Print Settings (Direct Print Function)

Setting the Number of Print Copies

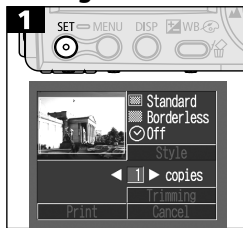

- Use the or button to select [Copies] and the or button to select the number. Up to 99 copies may be specified.

Setting the Print Style

You can select from among the following print styles.

Direct Print Function Compatible Printer

	Standard	Prints one image per page.
	Multiple*	Prints eight copies of the same image on one page.
	Borderless	Prints right to the edges of the paper.
	Bordered	Prints with a border.
	Date	Prints the image's creation date.

* This option is only available for printing on card-size paper.

BJ Printer

	Paper	Select a paper size from the following: Card #1, Card #2, Card #3, LTR and A4. See the printer's user guide for its media specifications.
	Borderless	Prints right to the edges of the paper.
	Bordered	Prints with a border.
	Date	Prints the image's creation date.

- If you are using a direct print function compatible printer, the date and borders settings cannot be selected when the Multiple option is selected. (Images are printed without a date or border.)



100 | Printing

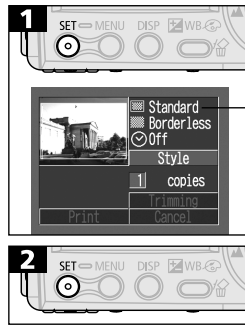

Current print style selection

- Use the or button to select [Style].

- Use the or button to select , , or and the or button to select an option.



(Image Settings)

(Direct Print Function Compatible Printer)
Select [Standard] or [Multiple].



(Paper)

(BJ Printer)
Select [Card #1], [Card #2], [Card #3], [LTR] or [A4].



(Borders)

Select [Borderless] or [Bordered].



(Date)

Select [On] or [Off].



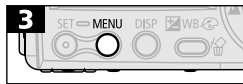

- Press the **MENU** button to finish the procedure.
- Practically all of the image area is printed on Bordered prints.
- With borderless or multiple prints, the image is printed with its top, bottom and sides trimmed.



- The date settings are overridden by the DPOF print settings if you are using them to print (p. 106).

Setting the Printing Area (Trimming)

You can print a portion of an image.



- The shape of the trimming frame is determined by the print style selection (image, paper, borders, date). Set the print style before setting the printing area (p. 99).

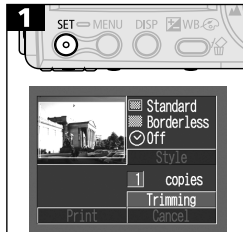

- Use the or button to select [Trimming].





102 | Printing

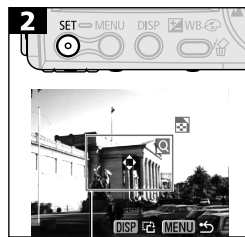

Trimming Frame

Changing the Size of the Trimming Frame

- Press the zoom lever toward or .
- The trimming frame can be resized to approximately half the image size at minimum and practically as large as the image at maximum.
- You can cancel the trimming setting by sliding the zoom lever toward the again when the trimming frame is already set to the maximum size.
- When printing an image that has been magnified using the trimming option, the image quality may become coarser and grainier depending on the magnifying rate. With direct print function compatible printers, the trimming frame displays in red.

Moving the Trimming Frame

- Use the or button to set the trimming frame's position.

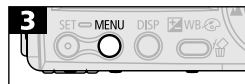

Rotating the Trimming Frame

- Press the **DISP** button to rotate the trimming frame.



- The trimming frame will appear on images that have already had one assigned.
- Trimming settings can only be set for one image.
- Trimming settings are canceled with the following operations:
 - When the trimming settings are set for another image.
 - When the print mode is closed (camera power shut off, mode dial turned, or direct interface cable detached).
 - When the zoom lever is pressed further toward with the trimming frame at its maximum.



Setting the DPOF Print Settings

You can select images on a CF card for printing and specify the number of print copies in advance using the camera. This is extremely convenient for sending the images to a photo developing service or for printing on a direct print function compatible printer or a direct print function compatible BJ printer.

Selecting Images for Printing

There are two ways to select images.

- Singly
- All images on a CF card (the number of print copies is set to one per image)

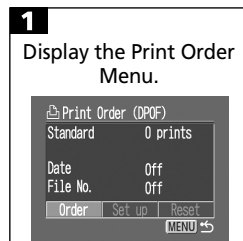

- See *Print Menu Settings* (p. 92).

- Use the  or  button to select [Print Order].





104 | Printing

Single Images

- As shown below, selection methods differ according to the options chosen for the (Print Type) settings (p. 106).

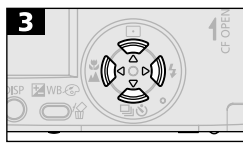

(Standard) / (Both)

- Use the or button to select an image and the or button to select the number of print copies (up to maximum of 99).

Number of Print Copies



(Index)

- Use the or button to move to an image and the or button to select or deselect it. A checkmark displays on selected images.

Selected for an Index Print



- You can use the same procedures to select images in index replay (3 images). Press the zoom lever toward to switch between single image replay and index replay.



- Press the **MENU** button repeatedly until the replay screen reappears to complete the procedure.



All the Images on a CF Card

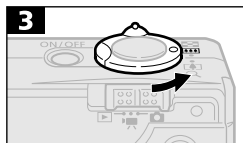

- Switch to index replay (3 images).

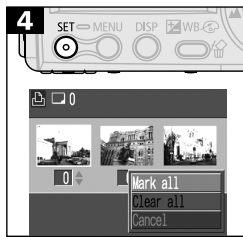

- Use the or button to select [Mark all].
- Selecting [Mark all] selects all of the card's images.

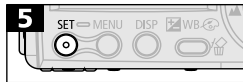

- Press the **SET** button to set the number of print copies to 1 for each image.
- When the print type is set to Standard or Both, the number of print copies can be set individually for each image. When Index is selected, the print settings can be deleted (p. 104).

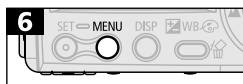

- Press the **MENU** button repeatedly until the replay screen reappears to complete the procedure.



- The symbol will display on images that have had print settings set by other DPOF-compliant cameras. These settings will be overwritten by those set by your camera.
- The output of some printers or photo developing services may not reflect the specified print settings.
- Print settings cannot be set for movie images.





106 | Printing



- Images are printed in order from oldest to newest by the shooting date.
- A maximum of 998 images can be selected per CF card.
- When [Both] is selected, the number of print copies can be set, but it applies to Standard prints only. The Index setting only produces one print copy.
- Print settings can also be assigned to images with the bundled software on a computer.

Setting the Print Style

Set the print style after selecting the image to print.
The following print settings can be selected.

	<input checked="" type="checkbox"/> Standard	Prints one image per page.
	<input type="checkbox"/> Index	Prints the selected images together at a reduced size in an index format.
	<input type="checkbox"/> Both	Prints the images in both the standard and index formats.
<input checked="" type="checkbox"/> Date	Adds the date to the print.	
<input type="checkbox"/> File No.	Adds the file number to the print.	

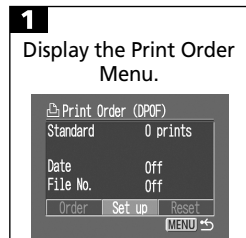

- See *Print Menu Settings* (p. 92).
- Use the or button to select [Set up].

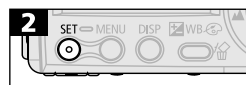



Printing | 107

- Use the or button to select , or , and the or button to select an option.

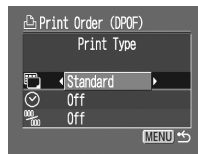

(Print Type)

- Select [Standard], [Index] or [Both].

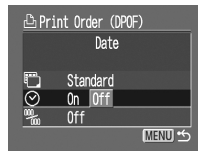

(Date)

- Select [On] or [Off].



(File No.)

- Select [On] or [Off].

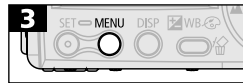

- Press the **MENU** button repeatedly until the replay screen reappears to complete the procedure.



- The date prints as the date and time in the format specified in the Set Date/Time menu (p. 23).



- When the print type is set to [Index], only one of the [Date] and [File No.] options can be set to [On] at the same time.





Resetting the Print Settings

The print settings can all be removed at once. The print type resets to Standard and the Date and File No. options to Off.

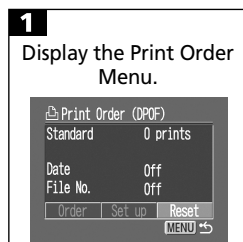

- See *Print Menu Settings* (p. 92).

- Use the or button to select [Reset].

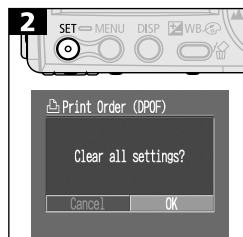

- Use the or button to select [OK].
- To exit without resetting, select [Cancel].

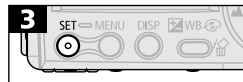

Printing with DPOF Print Settings

The DPOF print settings can be used to print on a direct print function compatible printer or a direct print function compatible BJ printer.

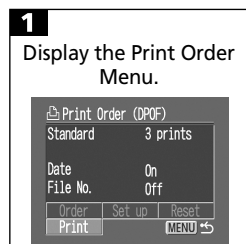

- See *Print Menu Settings* (p. 92).

- Use the / / / button to select [Print].

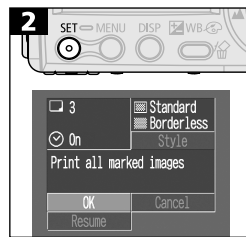

- Set the print style as required (p. 106).
- The print style cannot be set for images that have had the print type set to Index in the DPOF print settings. (You can also select the type of paper when printing with a BJ printer.)
- Use the / / / buttons to select [OK].

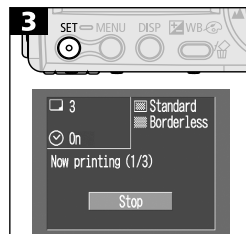

- Press the **SET** button to start printing.
- The replay screen will reappear when printing is successfully concluded.



110 | Printing



- To include the date in the prints, set the Date setting in the Set up menu in Step 1 above to [On]. You cannot set the date to print with the Style menu in Step 2 above. Please note however, that the date will not print if the print type is set to Index even if it is turned On in Step 1.
- When the print type is set to [Both], it is possible to have both the [Date] and [File No.] options set to [On], but only the file number will print on the Index print. (BJ printers cannot print the date or file number on Index prints.)
- When the print type is set to [Standard], file numbers will not be printed even if they are set to [On].



- The maximum number of images printed on one page in the Index print type depends upon the selected paper size.
 - Card Size: 20 images
 - L Size: 42 images
 - Postcard Size: 63 images(Please refer to your *Bubble Jet Printer Quick Start Guide* for an explanation of the number of images printed with a Bubble Jet Printer)



- **Canceling Printing**

See page 98.

- **Restarting Printing**

In the Print Order menu, use the (⏪) or (⏩) button to select [Resume] and press the SET button. The remainder of the selected images will print.

Printing cannot be resumed under the following circumstances:

- If the print settings were changed before printing is restarted,
- If images with print settings were deleted before printing is restarted,
- If there was insufficient spare capacity on the CF card when printing was halted.

Under these circumstances, you can select [OK] in the Print menu and reprint starting from the first image.

If printing was stopped because of a low battery charge, you are recommended to resume printing using the AC Adapter Kit ACK500 (sold separately). If you do use a battery pack, ensure that it is fully charged. Remember to turn the camera power on again before printing.

- **Printing Errors**

See page 98.





Image Transmission Settings (DPOF Transfer Order)

You can use the camera to specify settings for images that you wish to send by email. Please use the software supplied with the camera to actually transfer the images to an email program. Please read the *Software Starter Guide* for image transfer instructions. The settings used on the camera comply with the Digital Print Order Format (DPOF) standards.



- The  symbol will display on images that have had print settings set by other DPOF-compliant cameras. These settings will be overwritten by those set by your camera.



Selecting Images for Transferring

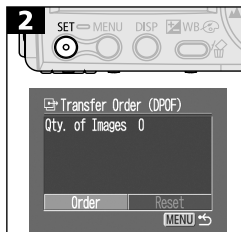

1
In the  (Play) menu, select .

- See *Selecting Menus and Settings* (p. 37).



- The Transfer Order menu will display.
- Use the  or  button to select [Order].
- Pressing [Reset] cancels the transfer settings for all images on the CF card.

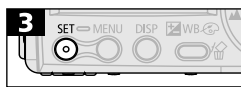



112 | Image Transmission Settings (DPOF Transfer Order)

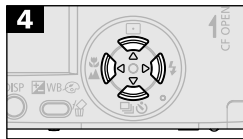

Selected for Transfer



- Use the or button to move to an image and the or button to select or deselect it. A checkmark displays on selected images.

- You can use the same procedures to select images in index replay (3 images). Press the zoom lever toward to switch between single image replay and index replay.
- While in index replay, you can select all of the images by pressing the **SET** button, using the or button to select [Mark all] and pressing the **SET** button again.



- Press the **MENU** button to complete the transfer settings and redisplay the Transfer Order menu.



- Images are transferred in order from oldest to newest by the shooting date.
- A maximum of 998 images can be selected per CF card.
- Transfer settings can also be assigned to images with the supplied software programs on a computer.





Shooting/Replaying with a TV

You can use a video-compatible television as a monitor to shoot or replay images when it is connected to the camera with the supplied AV Cable AVC-DC200. You must shut the TV and camera power off before you attach or detach the AV cable.

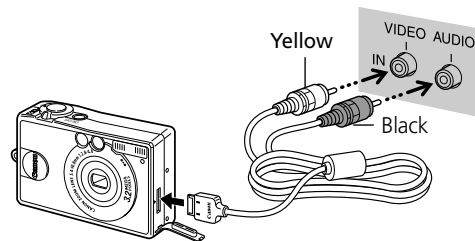

- After you have attached the AV cable at both ends, turn on the TV and set its TV/Video switch to Video.
- Set the mode switch to , or and turn the camera power on. You can shoot or replay images using the normal procedures.
- If the images are not appearing on the TV when shooting, press the **DISP** button.



- A TV cannot be used in or mode.
- No image will appear on the LCD monitor when the camera is connected to a TV.
- If the TV is a stereo model, you can plug the audio plug into either the left or right Audio In jack. Please refer to the TV's manual for details.



- The video output signal can be switched (NTSC or PAL) to accommodate different regional standards. The default setting varies between regions.
 - NTSC: Japan, U.S.A., Canada, Taiwan, etc.
 - PAL: Europe, Asia (excluding Taiwan), Oceania, etc.If the video system is set incorrectly, the camera output may not display properly.



Downloading Images to a Computer

Download images taken with the camera to a computer in one of the following ways:

- Directly from the CF card.
- By connecting the camera to a computer with the USB cable.

You must install the software and USB driver bundled on the Canon Digital Camera Solution Disk before connecting the camera to the computer.

After installing the supplied software, download images automatically by simply connecting the camera to a computer with the supplied USB cable.

- Please refer to the *Software Starter Guide* for installation instructions, image download instructions and system requirements.

Downloading Directly from a CF Card



Images can be loaded directly from a CF card if you have a slot-equipped notebook computer, a PC card reader or a CF card reader.



- 1** Eject the CF card from the camera and insert it into a CF card reader connected to the computer.

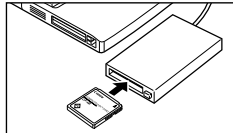

If you are using a PC card reader, first insert the CF card into a PC card adapter (optional), and then insert the PC card adapter into the computer's PC card reader.

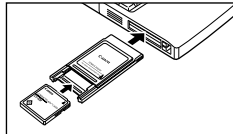

- 2** Double-click the icon of the drive containing the CF card.





Downloading Images to a Computer | 115

- 3** Copy the CF card's images to the desired folder on the hard disk.
The images are contained in the [XXXCANON] folder, which is a subfolder of the [DCIM] folder on the CF card. The XXX represents a number from 100 to 998.



- Some computers or memory card readers require the power to be off when the CF card is inserted into the slot. Since this requirement varies between products, please consult the manual for your equipment.

Connecting the Camera to a Computer with a USB Cable

You must install the software and USB driver bundled on the Canon Digital Camera Solution Disk before connecting the camera to the computer. Please refer to the *Software Starter Guide* for installation instructions.

- 1** Use the supplied USB cable to connect the computer's USB port to the DIGITAL • A/V OUT Terminal on the camera.

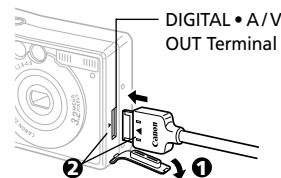
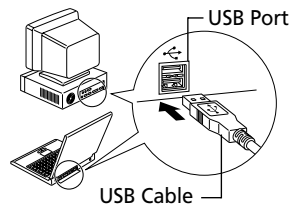

- 1 Slip a fingernail under the upper edge of the terminal cover to open it.
- 2 Insert the connector with the ► symbols on the camera and cable aligned.



- You do not need to shut off the camera or computer to attach or detach USB interface cables.
- Please refer to your computer's manual for the locations of the computer's USB ports.

- 2** Set the camera's mode switch to the  position.
The LCD monitor will turn on in replay mode and then blank out when the connection to the computer is complete.





116 | Downloading Images to a Computer

• Setting the Communication Mode

Sets the communication mode when downloading images with a camera connected to the computer.

Normal (Default)	Usual setting. You must install the USB driver bundled on the Canon Digital Camera Solution Disk before using this mode.
PTP (Picture Transfer Protocol)	The following functions are available even if the software and USB driver bundled on the Canon Digital Camera Solution Disk have not been installed. - Viewing the camera's images - Downloading the camera's images to a computer - Deleting the camera's images These functions are available with Windows XP or Mac OS X (10.1)*. *Select the [Normal] option for all other operating systems.

*With any other OS, [PTP] cannot be used. Please select [Normal].



1
Check that the camera is not connected to the computer.

2
In the **ii** (Set up) menu, select **iv**.



- See *Selecting Menus and Settings* (p. 37)
- Use the **Q** or **R** button to select [Normal] or [PTP].

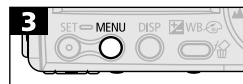



Downloading Images to a Computer | 117



- Some problems may occur when downloading images to a computer in the PTP mode with certain file types. Please refer to the supplied *Picture Transfer Protocol (PTP) Mode* leaflet.



- Ensure that you push the [Push] button on the connector to remove the USB cable from the camera's DIGITAL•A/V OUT terminal.

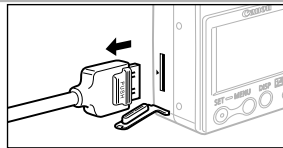

- It is recommended to power the camera from a household power outlet with the optional AC Adapter Kit ACK500 when connected to a computer (p. 130).
- If the USB cable is detached while the camera power is on, the camera will power down.
- When the camera is connected to a computer, a warning displays on the computer display after 5 minutes if the camera is not used. The camera shuts down if a further minute passes without a button being pressed. (Except when the camera's power-saving function is set to off) To restore power, press the main switch again. However, the power-saving function will not activate if the Communication mode is set to [PTP].
- All procedures performed with a connection to a USB 2.0 compliant board are not guaranteed.



Please refer to the *Software Starter Guide* for the subsequent procedures.





Lists of Menu Options and Messages

The following charts list the various menu contents. See *Selecting Menus and Settings* (p. 37) to learn how to select a setting.

Rec. Menu



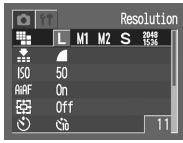
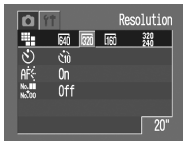
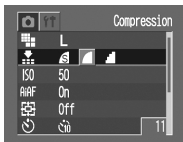
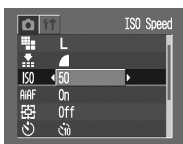

* Default setting

Item/Menu Screen	Options	Reference Page
<p>Resolution (Stills)</p> 	<p>Sets the number of pixels used to record images to CF cards.</p> <ul style="list-style-type: none"> • L (Large)* 2048 x 1536 pixels • M1 (Medium 1) 1600 x 1200 pixels • M2 (Medium 2) 1024 x 768 pixels • S (Small) 640 x 480 pixels 	p. 45
<p>Resolution (Movies)</p> 	<p>Sets the number of pixels used to record movies to CF cards.</p> <ul style="list-style-type: none"> • 640 640 x 480 pixels • 320 320 x 240 pixels* • 160 160 x 120 pixels 	p. 45
<p>Compression</p> 	<p>Sets the relative compression ratio used to record images to CF cards.</p> <ul style="list-style-type: none"> • Superfine • Fine* • Normal 	p. 45
<p>ISO Speed</p> 	<p>Sets the sensitivity at which images are recorded.</p> <ul style="list-style-type: none"> • 50* • 100 • 200 • 400 • AUTO 	p. 71



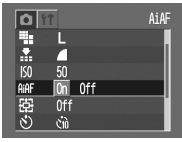
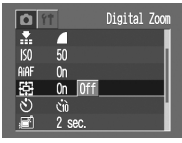



List of Menu Options and Messages | 119

Item/Menu Screen	Options	Reference Page
	Sets whether or not the camera automatically selects one of nine AF frames or a fixed center AF frame. <ul style="list-style-type: none"> • On* • Off 	p. 62
	Sets whether or not the optical zoom is supplemented by digital processing. <ul style="list-style-type: none"> • On • Off* 	p. 50
	Sets the duration before the selftimer releases the shutter. <ul style="list-style-type: none"> • 10 seconds* • 2 seconds 	p. 52
	Sets the duration images display on the LCD monitor after the shutter button releases. <ul style="list-style-type: none"> • Off • 2*-10 seconds (1-second increments) 	p. 44
	Sets the AF-assist Beam to on or off. <ul style="list-style-type: none"> • On* • Off 	p. 35



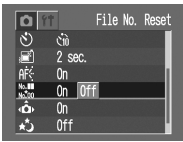
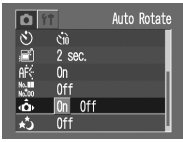

120 | List of Menu Options and Messages

Item/Menu Screen	Options	Reference Page
<p>File No. Reset</p> 	<p>Sets how file numbers are assigned to images when new CF cards are inserted.</p> <ul style="list-style-type: none"> • On • Off * 	p. 73
<p>Auto Rotate</p> 	<p>Sets whether or not images shot with the camera on end are automatically rotated in the display.</p> <ul style="list-style-type: none"> • On* • Off 	p. 72
<p>Long Shutter</p> 	<p>Sets the shutter speed to slow settings.</p> <ul style="list-style-type: none"> • On • Off * 	p. 65





List of Menu Options and Messages | 121

Play Menu

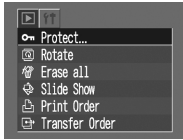
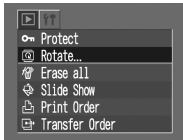
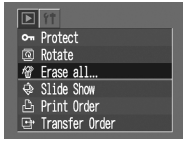
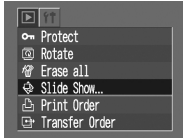
Item/Menu Screen	Options	Reference Page
	Protects images from accidental erasure.	p. 86
	Rotates images clockwise 90° or 270° in the display.	p. 81
	Deletes all images from a CF card (except for protected images).	p. 88
	Plays images in automated slide shows.	p. 82





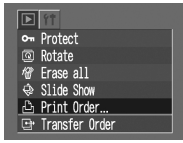
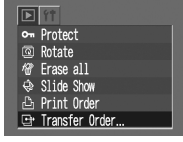

122 | List of Menu Options and Messages

Item/Menu Screen	Options	Reference Page
	Selects images and the number of print copies for output to a DPOF - compatible printer or a photo developing service.	p. 103
	Selects the images that will be transferred to your email software.	p. 111



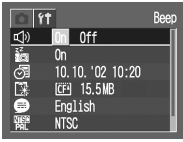

Set up Menu

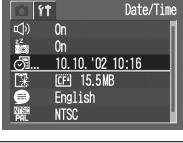
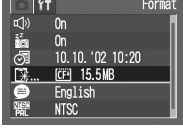
* Default setting

Item/Menu Screen	Options	Reference Page
	<p>Sets whether or not a beep sounds when the shutter button is pressed or a menu operation is performed.</p> <ul style="list-style-type: none"> • On* • Off <p>A beep still sounds to warn of errors even when Off is selected.</p>	p. 34
	<p>Sets whether or not the camera automatically powers down after a set period of time elapses without something being pressed.</p> <ul style="list-style-type: none"> • On* • Off 	p. 27
	<p>Sets the date and time and the date format.</p>	p. 23
	<p>Formats (initializes) CF cards.</p>	p. 89



124 | List of Menu Options and Messages

Item/Menu Screen	Options	Reference Page
<p>Language</p> 	<p>Sets the language used in menus and messages on the LCD monitor.</p> <ul style="list-style-type: none"> • English* • Italiano • Deutsch • Norsk • Français • Svenska • Nederlands • Español • Dansk • Chinese • Suomi • Japanese <p>You can also change the language in replay mode by holding the SET button and pressing the MENU button.</p>	p. 25
<p>Video System</p> 	<p>Sets the video output signal standard.</p> <ul style="list-style-type: none"> • NTSC • PAL 	p. 113
<p>Communication</p> 	<p>Sets the camera and computer communication settings.</p> <ul style="list-style-type: none"> • Normal* • PTP 	p. 116





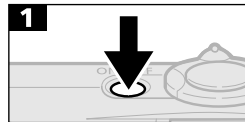

Resetting Settings to Their Default Values

You can reset the menu and button settings to the default settings in one operation except for the Date/Time, Language and Video System settings.

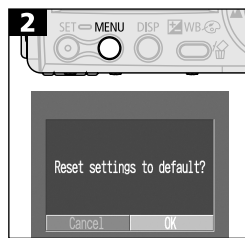

- Press the ON/OFF button until the green power lamp lights.
- Set the mode switch to any position.



- Press and hold the **MENU** button for more than 5 seconds.
- Use the  or  button to select [OK].
- To exit without resetting, select [Cancel].

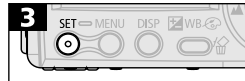

- White balance data recorded with the custom white balance function is not reset by this function (p. 68).
- Settings cannot be reset when the camera is connected to a computer, to a direct print function compatible printer (optional) or to a direct print function compatible BJ printer (optional).





126 | List of Menu Options and Messages

List of Messages

The following messages may appear on the LCD monitor while shooting or replaying.

Busy...	Image is being recorded to, or read from, CF card
No CF card	You attempted to shoot or replay images without a CF card installed.
Cannot record!	You attempted to shoot an image without a CF card installed.
CF card error!	CF card has experienced an anomaly.
CF card full	CF card is too full to accommodate more images or print settings.
Naming error!	The file could not be created because there is a file with the same name as the directory that the camera is attempting to create, or the highest possible file number has already been reached. In the Rec. Menu, set the File Reset option to On. Save all the images you wish to retain onto a computer, then reformat the CF card. Please note that formatting will erase all the existing images and other data.
Change the battery pack	Battery charge is insufficient to operate the camera. Replace it at once with a charged one or recharge the battery pack.
No image	No images recorded on CF card.
Image too large	You attempted to replay an image larger than 3200 x 2400 pixels or a movie clip recorded by another camera.
Incompatible JPEG format	You attempted to replay an incompatible JPEG file.





List of Menu Options and Messages | 127

Corrupted Data	You attempted to replay an image with corrupted data.
RAW	You attempted to replay an image recorded in the RAW format.
Unidentified Image	You attempted to replay an image that was recorded in a special format (proprietary format used by the camera of another manufacturer, etc.) or a movie clip recorded by another camera.
Cannot magnify!	You attempted to magnify an image which was photographed with another camera, recorded in a different format, or edited on a computer.
Cannot rotate	You attempted to rotate an image which was photographed with another camera, recorded in a different format, or edited on a computer.
Protected!	You attempted to erase a protected image.
Too many marks	Too many images have been marked with print settings, transfer settings or slide show settings. Cannot process any more.
Unselectable image	You attempted to set the print settings for a non-JPEG file.
Exx:	(xx: number) Camera malfunction. Turn the power off and then back on, then shoot or replay. A problem exists if the error code reappears. Note the number and contact your Canon Customer Support Help Desk. If an error code displays directly after taking a picture, the shot may not have been recorded. Check image in replay mode.





128 | List of Menu Options and Messages

List of Messages Displayed while a Direct Print Function Compatible Printer is Connected

The following messages may appear on the camera's LCD monitor while a direct print function compatible printer (sold separately) is connected.

No Paper	Paper cassette is empty or incorrectly installed. Paper feed may not be operating correctly.
No Ink	The ink cassette is empty or missing.
Incompatible paper size	You attempted to print with a paper size incompatible with this camera.
Incompatible ink size	You attempted to print with an ink cartridge type incompatible with this camera.
Ink Cassette Error	There is a problem with the ink cassette.
Paper and ink do not match	The paper and ink are from different sets.
Paper Jam	Paper jammed during printing.
Paper has been changed	The paper size was changed between the time the Print Style menu was displayed and the time printing started.
Recharge the printer battery	The printer's battery is out of power.
Communication Error	A communication error has occurred.
Reajust trimming	You attempted to print the image with a different style than the one used when the trimming settings were set.
Cannot print!	You attempted to print an image shot by a different camera, one recorded in an incompatible format, or one downloaded to and edited with a computer.
Could not print XX images	You attempted to print XX number of images with DPOF print settings that were shot by a different camera, recorded in an incompatible format, or downloaded to and edited with a computer.





List of Menu Options and Messages | 129

List of Messages Displayed while a Direct Print Function Compatible Bubble Jet Printer is Connected

The following messages may appear on the camera's LCD monitor while a direct print function compatible Bubble Jet printer (sold separately) is connected.

Check the error number displayed on the control panel of Bubble Jet printer and refer to the Bubble Jet Printer *Quick Start Guide*.

Printer in use	Printer is busy printing from a memory card in computer or printer. Printer will automatically start printing from camera when the current print queue empties.
Printer warming up	Printer is warming up. When it is ready, the printer will start printing automatically.
No printhead	No printhead installed in printer.
Printer cover open	Secure the printer front cover.
Media type error	You selected a paper type incompatible with the printer. Select a compatible paper type in the Print Style menu.
Paper lever error	Adjust the paper thickness lever to the proper position.
Low ink level	Ink tank needs replacement soon. Prepare a new ink tank. Select [Continue] in the error message to resume printing.
Waste tank full	Restart printing by pressing RESUME/CANCEL button on printer, but request a replacement waste ink tank from your retailer or service center (see printer <i>Quick Start Guide</i> or the Contact List provided with the printer) soon.
Printer error	Turn printer off and on again. If error persists, consult service center listed in printer <i>Quick Start Guide</i> or in the Contact List provided with the printer.



Appendices

Using an AC Adapter Kit (Sold Separately)

It is best to power the camera with AC Adapter Kit ACK500 (sold separately) when you are using it for long periods of time or connecting it to a computer.



- Turn the camera power off before connecting or disconnecting the AC adapter.

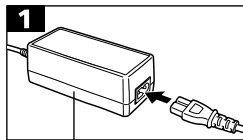

Compact Power Adapter
CA-PS500

- Connect the power cord to the compact power adapter first and then plug the other end into the power outlet.

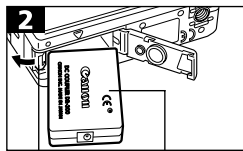

Battery Lock DC Coupler
DR-500

- Open the battery cover and press the battery lock in the direction shown while inserting DC Coupler DR-500. Insert the DC coupler all the way in until the battery lock clicks. Slide the battery cover closed.

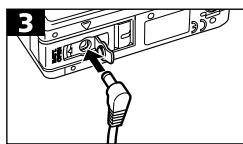

- Open the DC coupler terminal cover and attach the cord to the DC terminal.
- After you have finished using the camera, unplug the AC adapter from the power outlet.



- Use of an AC adapter kit other than ACK500 may cause a malfunction in the camera or kit.

Using a Car Battery Charger (Optional)

Car Battery Charger CBC-NB1 (sold separately) can be used to charge battery packs from an automobile's cigarette lighter socket.

-  Always ensure that the automobile's engine is running when you use the car battery charger. Use of it with the engine off may flatten the battery in some automobiles. Always unplug the car battery charger before turning off the engine.

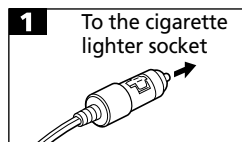

- With the engine running, plug the car battery cable into the cigarette lighter socket and the battery charger.

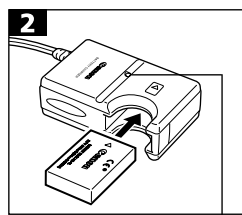

- Insert the battery pack all the way into the battery charger as shown.
- The charge indicator will light red while the battery pack is charging. It will change to green when the charge is complete.
- After charging, unplug the car battery cable from the cigarette lighter socket and remove the battery pack.



- The battery will stop charging whenever you turn the engine off, so be sure to unplug the car battery cable from the cigarette lighter socket.
- Wait until the engine is running again to plug the car battery cable into the cigarette lighter socket.
- The car battery charger can only be used in a negative ground car. It cannot be used in a positive ground car.



Camera Care and Maintenance

Use the following procedures to clean the camera body, lens, viewfinder and LCD monitor.

- Never use thinners, benzene, synthetic cleansers or water to clean the camera. These substances may distort or damage the equipment.

Camera Body

Gently wipe dirt off the camera body with a soft cloth or eyeglass lens wiper.

Lens

First use a lens blower brush to remove dust and dirt, then remove any remaining dirt by wiping the lens lightly with a soft cloth.

- Never use synthetic cleansers on the camera body or lens.
- If dirt remains, contact the closest Canon Customer Support Help Desk as listed on the separate Canon Customer Support leaflet.



Viewfinder and LCD Monitor

Use a lens blower brush to remove dust and dirt. If necessary, gently wipe with a soft cloth or an eyeglass lens wiper to remove stubborn dirt.

- Never rub or press strongly on the LCD monitor. These actions may damage it or lead to other problems.



Troubleshooting

Problem	Cause	Solution
Camera will not operate	Power is not turned on	<ul style="list-style-type: none"> Press the ON/OFF button for a moment.
	Battery cover or CF card slot cover is open	<ul style="list-style-type: none"> Confirm that the battery cover and CF card slot cover are securely closed.
	Insufficient battery voltage	<ul style="list-style-type: none"> Insert a fully charged battery into the camera. Use the AC Adapter Kit ACK500 (sold separately).
	Poor contact between camera and battery terminals	<ul style="list-style-type: none"> Wipe the terminals with a clean dry cloth.
Camera will not record	Mode switch is set to  (Replay)	<ul style="list-style-type: none"> Turn the mode dial to the  or  position.
	Flash is charging	<ul style="list-style-type: none"> Wait until the flash charges. You can press the shutter button when the indicator lights orange.
	CF card is full	<ul style="list-style-type: none"> Insert a new CF card. If required, download the images to a computer and erase them from the CF card to make space.
	CF card is not formatted correctly	<ul style="list-style-type: none"> Format CF card (See <i>Formatting CF Cards</i> p. 89). If reformatting doesn't work, the CF card logic circuits may be damaged. Consult the nearest Canon Customer Support Help Desk.



134 | Appendices

Problem	Cause	Solution
Lens will not retract	Battery cover or CF card slot cover was opened with power on	<ul style="list-style-type: none">• First close the battery cover or CF card slot cover and then turn the power off.
	Battery cover or CF card slot cover was opened while recording to the CF card (warning signal sounds)	<ul style="list-style-type: none">• First close the battery cover or CF card slot cover and then turn the power off.
Battery pack consumed quickly	Battery life exceeded if battery pack loses its charge quickly at normal temperature (23° C / 73° F)	<ul style="list-style-type: none">• Replace the battery pack with a new one.
Battery pack will not charge	Battery pack life exceeded	<ul style="list-style-type: none">• Replace the battery pack with a new one.
	Poor contact between battery pack and battery charger	<ul style="list-style-type: none">• Insert battery pack securely into battery charger.• Ensure that battery charger plug is securely plugged into the power outlet.
Image is blurred or out of focus	Camera moved	<ul style="list-style-type: none">• Be careful not to move the camera while pressing the shutter button.
	Autofocus function hampered by obstruction to AF-assist Beam	<ul style="list-style-type: none">• Be careful not to block the AF-assist Beam with fingers or other items.









Appendices | 135

Problem	Cause	Solution
Image is blurred or out of focus	AF-assist Beam is set to off	<ul style="list-style-type: none"> • Set the AF-assist Beam to on. (p. 119)
	Subject is out of focal range	<ul style="list-style-type: none"> • Ensure there is at least 47 cm (1.5 ft.) between the camera lens and subject. • Use the Macro mode to shoot close-ups between 10 and 47 cm (3.9 in. to 1.5 ft.) from the lens when set to wide angle and between 27 and 47 cm (10.6 in. to 1.5 ft.) when set to telephoto. • Use the Infinity mode to shoot distant subjects.
Subject in recorded image is too dark	Insufficient light for shooting	<ul style="list-style-type: none"> • Set the flash to on.
	Subject is dark in contrast to the background	<ul style="list-style-type: none"> • Set the exposure compensation to a positive (+) setting or use the spot metering function.
	Subject is too far away for flash to reach	<ul style="list-style-type: none"> • Shoot within 3 m (9.8 ft.) of the subject at the maximum wide angle or 2 m (6.6 ft.) of the subject at the telephoto end setting when using the flash.
Subject in recorded image is too bright	Subject is too close, making the flash too strong	<ul style="list-style-type: none"> • When using the flash, stay at least 27 cm (10.6 in.) from the subject.
	Subject is bright in contrast to the background	<ul style="list-style-type: none"> • Set the exposure compensation to a negative (-) setting or use the spot metering function.





136 | Appendices

Problem	Cause	Solution
Subject in recorded image is too bright	Light is shining directly on the subject or reflected off the subject into the camera	• Change the shooting angle.
	Flash is set to on	• Set the flash to off.
Flash does not fire	Flash is set to off	• Set the flash to on.
Image not showing on TV monitor	Incorrect video system setting	• Set the video system to the appropriate setting, NTSC or PAL, for your TV (p. 124).
	Shooting mode set to  or  (Stitch Assist)	• The output will not appear on a TV in  or  (Stitch Assist) mode. Shoot in a different mode.
Zoom does not work	Zoom lever pressed during movie recording	• Adjust the zoom before shooting a movie.
Reading images from CF card is slow	CF card was formatted in another device	• Use a CF card formatted in your camera. See Formatting CF Cards (p. 89).
Recording images to CF card takes a long time		





Specifications

All data is based on Canon's standard testing methods.
Subject to change without notice.

PowerShot S230 DIGITAL ELPH / DIGITAL IXUS v³

Camera Effective Pixels:	Approx. 3.2 million
Image Sensor:	1/2.7 in. CCD (Total number of pixels: approx. 3.3 million)
Lens:	5.4 (W) - 10.8 (T) mm (35 mm film equivalent: 35-70mm) F2.8 (W) - 4 (T)
Digital Zoom:	Maximum 3.2 x (Maximum 6.4 x with optical zoom)
Optical Viewfinder:	Real-image optical zoom viewfinder
LCD Monitor:	1.5 in. low-temperature polycrystalline silicon TFT color LCD, approx. 120,000 pixels
Autofocus:	TTL 9-point AiAF/TTL 1-point center AF Focus lock possible
Focusing Range:	Normal: 47 cm (1.5 ft.) - ∞ Macro AF: 10-47 cm (3.9 in. - 1.5 ft.) (W) 27-47 cm (10.6 in. - 1.5 ft.) (T)
Shutter:	Mechanical + electronic
Shutter Speed:	15 - 1/1500 sec. • 1 - 1/6 sec. possible at flash-off or slow-synchro in manual mode • 15 - 1 sec. possible in long shutter mode • Noise reduction processing on speeds between 15 - 1.3 sec.
Light Metering System:	Evaluative metering (linked to focusing point)/ Spot metering
Exposure Control:	Program AE
Exposure Compensation:	+/- 2 stops in 1/3-stop increments
Sensitivity:	ISO 50/100/200/400 equivalent and Auto

(W): wide angle (T): telephoto





138 | Specifications

White Balance:	TTL auto/preset (daylight, cloudy, tungsten, fluorescent, fluorescent H) or custom white balance
Flash:	Red-eye reduction auto/auto/on/off/slow-synchro
Flash Shooting Range:	Normal mode: 47 cm - 3.0 m (1.5 - 9.8 ft.) (W) 47 cm - 2.0 m (1.5 - 6.6 ft.) (T) Macro Mode: 27-47 cm (10.6 in. - 1.5 ft.) (W/T)
Shooting Modes:	Auto/manual/stitch assist/movie
Continuous Shooting:	Approx. 2 images/sec. (Large/Fine mode, LCD monitor off)
Self-timer:	Shoots after approx. 10 sec. or approx. 2 sec.
PC Connected Shooting:	Available (USB connection only. Exclusive software program "RemoteCapture" is included in the camera kit.)
Recording Media:	CompactFlash™ card (Type I)
File Format:	Design rule for Camera File System, DPOF-compliant
Image Recording Format	Still images: JPEG (Exif 2.2)* ¹ Movies: AVI - Image data: Motion JPEG - Audio data: WAVE (monaural)
Compression:	Superfine/fine/normal
Number of Recording Pixels:	Still images: large 2048 x 1536 pixels medium 1 1600 x 1200 pixels medium 2 1024 x 768 pixels small 640 x 480 pixels Movies: 640 x 480 pixels (Approx. 30 sec.)* ² 320 x 240 pixels (Approx. 3 min.) 160 x 120 pixels (Approx. 3 min.) Approx. 15 frames/sec. • The data in parentheses refer to the maximum movie length per clip.
Replay Modes:	Single image view/index view (9 thumbnails)/zoomed view (LCD monitor zooms images up to 10 x)/slide show/printing with Card Photo Printer CP-100, CP-10 or Bubble Jet Printer (Direct Print)
Display Languages:	English, Deutsch, Français, Nederlands, Dansk, Suomi, Italiano, Norsk, Svenska, Español, Chinese and Japanese
Interface:	USB (Normal or PTP selectable), Audio/Video output (NTSC or PAL selectable, Monaural audio)

(W): wide angle (T): telephoto





Specifications | 139

Power Source:	Rechargeable Lithium-ion battery (type: NB-1LH/NB-1L) AC Adapter Kit ACK500 Car Battery Charger CBC-NB1
Operating Temperatures:	0°- 40° C (32°- 104° F)
Operating Humidity:	10% -90%
Dimensions (w x h x d):	87.0 x 57.0 x 26.7 mm (3.4 x 2.2 x 1.1 in.) (excluding protrusions)
Weight:	Approx. 180 g (6.4 oz.) (camera body only)

*¹ This digital camera supports Exif 2.2 (also called "Exif Print"). Exif Print is a standard for enhancing the communication between digital cameras and printers. By connecting to an Exif Print-compliant printer, the camera's image data at the time of shooting is used and optimized, yielding extremely high quality prints.

*² This is the maximum recording time per movie clip for the optional Canon FC-256MH CF card (not sold in some regions).

Battery Capacity

Battery Pack NB-1LH (fully charged)

Number of recordable images	LCD monitor on	Approx. 170 images
	LCD monitor off	Approx. 420 images
Replay	Approx. 130 minutes	

- Excludes movie data.
- At low operating temperatures, the battery performance may drop and the low battery icon may appear sooner than at high temperature. To improve performance at these temperatures, warm the battery in your pocket just before using it in the camera.

Test Criteria















- Shooting:** Normal temperature (23° C/73° F), alternating between wide angle and telephoto every 20 seconds, flash used one in four shots, power turned off and on again after every eighth shot.
- Replaying:** Normal temperature (23° C/73° F), continuous replay at 3 seconds per image.











140 | Specifications



CF Cards and Estimated Capacities (Recordable Images)

		FC-16M	FC-32M	FC-64M	FC-128M	FC-256MH
L (2048 x 1536 pixels)		8	18	38	76	154
		16	33	68	137	276
		32	67	136	274	548
M1 (1600 x 1200 pixels)		14	30	61	122	246
		26	54	109	219	440
		52	108	217	435	868
M2 (1024 x 768 pixels)		25	53	107	215	431
		46	94	189	379	762
		84	174	349	700	1390
S (640 x 480 pixels)		58	120	241	482	962
		94	196	393	788	1563
		165	337	676	1355	2720
MOVIE	 (640 x 480 pixels)	14 sec.	30 sec.	61 sec.	124 sec.	249 sec.
	 (320 x 240 pixels)	44 sec.	91 sec.	183 sec.	368 sec.	735 sec.
	 (160 x 120 pixels)	118 sec.	242 sec.	486 sec.	973 sec.	1954 sec.

• The maximum movie clip length is approximately 30 sec. ()* or 3min. ( , ). The times shown are the maximum continuous recording times.







* When used with the FC-256MH CF card (sold separately).

• **L** (Large), **M1** (Medium 1), **M2** (Medium 2), **S** (Small),  ,  and  indicate the recording resolution.

•  (Superfine),  (Fine) and  (Normal) indicate the compression setting.

• The FC-256 MH CF card is not sold in some regions.

Image File Sizes (Estimated)

Resolution	Compression		
			
L (2048 x 1536 pixels)	1602 KB	893 KB	445 KB
M1 (1600 x 1200 pixels)	1002 KB	558 KB	278 KB
M2 (1024 x 768 pixels)	570 KB	320 KB	170 KB
S (640 x 480 pixels)	249 KB	150 KB	84 KB
 (640 x 480 pixels)	990 KB/sec.		
Movies  (320 x 240 pixels)	330 KB/sec.		
 (160 x 120 pixels)	120 KB/sec.		





Specifications | 141

CompactFlash™ Card

Card Slot Type:	Type I
Dimensions:	36.4 x 42.8 x 3.3 mm (1.4 x 1.7 x 0.1 in.)
Weight:	Approx. 10 g (0.4 oz.)

Battery Pack NB-1LH

Type:	Rechargeable Lithium Ion Cell
Nominal Voltage:	3.7 V
Typical Capacity:	840 mAh
Cycle Life:	Approx. 300 times
Operating Temperatures:	0-40 °C (32-104 °F)
Dimensions:	32.3 x 49.8 x 10.6 mm (1.3 x 1.9 x 0.4 in.)
Weight:	Approx. 29 g (1.0 oz.)

Battery Charger CB-2LS/CB-2LSE

Rated Input:	100-240 V AC (50/60 Hz) 0.075 A (100 V)-0.045 A (240 V)
Rated Output:	4.2 V DC/0.5 A
Charging Time:	Approx. 130 minutes*
Operating Temperatures:	0-40 °C (32-104 °F)
Dimensions:	90.4 x 56.0 x 28.0 mm (3.6 x 2.2 x 1.1 in.)
Weight:	Approx. 78 g (2.8 oz.)

* When charging Battery Pack NB-1LH

Compact Power Adapter CA-PS500

(Included with the optional AC Adapter Kit ACK500)

Rated Input:	100-240 V AC (50/60 Hz) 0.17 A
Rated Output:	4.3 V DC/1.5 A
Operating Temperatures:	0-40 °C (32-104 °F)
Dimensions:	42.6 x 104.4 x 31.4 mm (1.7 x 4.1 x 1.2 in.)
Weight:	Approx. 180 g (6.3 oz.)





142 | Specifications

Car Battery Charger CBC-NB1 (Optional)

Rated Input:	DC 12-24 V, 4.3 W
Rated Output:	4.2 V DC, 0.55 A
Charging Time:	Approx. 130 minutes*
Operating Temperatures:	0-40°C (32-104°F)
Dimensions:	90.4 x 56.0 x 28.0 mm (3.6 x 2.2 x 1.1 in.)
Weight:	Approx. 106 g (3.7 oz.)

* When charging Battery Pack NB-1LH





Index

A

- AC Adapter Kit (ACK500) 130
- AE Lock 60
- AF Frame 31, 62
- AF-assist Beam 35
- AF Lock 58
- AiAF 33
- Autofocus 33, 62
- Autofocus Lock 58
- Auto Mode 42
- Auto Rotate 72
- AV Cable AVC-DC200 113

B

- Battery
 - Battery Pack Charge 18
 - Capacity 139
 - Handling 19
 - Installing 20
 - Recharging 18
 - Battery Pack 18

C

- Care and Maintenance 132
- CF Card
 - Capacities 139
 - Formatting 89
 - Handling 23
 - Installing 22
- Car Battery Charger 131
- Communication mode 116
- Compression 45
- Continuous Shooting 51
- Custom White Balance 68

D

- Date/Time 23
- DIGITAL • A/V OUT Terminal 95, 96, 115
- Digital Zoom 36, 50
- Direct Interface Cable
 - DIF-200 94

- Direct Print function Compatible BJ
 - Printer 95
- Direct Print function Compatible
 - Printer 94
- Direct Printing 90
- DPOF 90, 92, 103, 111
- DPOF Print Order 90
 - Printing 104
 - Print Style 106
 - Resetting 108
 - Selecting Images 103
 - DPOF Transfer Order 111
- Downloading Images to a Computer 114

E

- Erasing
 - All Images 88
 - Single Images 87
- Exposure 60, 64

F

- FE Lock 61
- File Number 73
- File Sizes 140
- Flash 47
- Focus Lock 58
- Formatting 89
- Functions Available in Each Shooting Mode 148

H

- Histogram 32

I

- Image File Sizes 140
- Index Replay 76
- Indicator 17
- ISO Speed 71



L

Language 25
 LCD Monitor
 Information Displayed 30
 Using the LCD Monitor 29

M

Macro Mode 49
 Magnify 75
 Manual Mode 42
 Menu
 Play 121
 Rec. 118
 Set up 123
 Messages
 List of Messages 126
 Messages Displayed while a Direct
 Print Compatible Bubble Jet
 Printer is Connected 129
 Messages Displayed while a Direct
 Print Compatible Printer is
 Connected 128
 Metering Method 63
 Mode Switch 16, 42
 Movie
 Movie Mode 28, 56
 Replaying 77
 Editing 79

O

On/Off Button 26
 Optical Viewfinder 33

P

Photo Effect 70
 Play Menu 121
 Power On/Off 26
 Power Lamp 16
 Power Save 27
 Print Settings (Direct Print Printers)
 Number of Print Copies 99
 Print Area (Trimming) 101
 Print Style 99
 Selecting Images 97
 Protect 86

R

Rec. Menu 118
 Red-Eye Reduction Function 48
 Replay Mode 28
 Resolution 45
 Review Duration 44
 Rotate 81

S

Self-Timer 52
 Set up Menu 123
 Shooting Mode 28, 42
 Shutter Button 34
 Pressing Fully 35
 Pressing Halfway 34
 Shutter Speed 65
 Single Image Replay 74
 Slide Show 82
 Play Time 85
 Repeat Settings 85
 Spot AE Point Frame 31, 63
 Stitch Assist Mode 53

T

Telephoto 36

U

USB Cable 115

V

Video Output System 113
 Viewfinder 33
 Viewing
 Single Image Replay 74
 Index Replay 76

W

White Balance 67
 Wide Angle 36
 Wrist Strap 15





Disclaimer

- While every effort has been made to ensure that the information contained in this guide is accurate and complete, no liability can be accepted for any errors or omissions. Canon reserves the right to change the specifications of the hardware and software described herein at any time without prior notice.
- No part of this guide may be reproduced, transmitted, transcribed, stored in a retrieval system, or translated into any language in any form, by any means, without the prior written permission of Canon.
- Canon makes no warranties for damages resulting from corrupted or lost data due to a mistaken operation or malfunction of the camera, the software, the CompactFlash™ cards (CF cards), personal computers, peripheral devices, or use of non-Canon CF cards.



Trademark Acknowledgments

- Canon and PowerShot are trademarks of Canon, Inc.
- CompactFlash is a trademark of SanDisk Corporation.
- iBook and iMac are trademarks of Apple Computer, Inc.
- Macintosh, PowerBook, Power Macintosh and Quick Time are trademarks of Apple Computer, Inc., registered in the United States and other countries.
- Microsoft, Windows and Windows NT are either registered trademarks or trademarks of Microsoft Corporation in the United States and/or other countries.
- Other names and products not mentioned above may be registered trademarks or trademarks of their respective companies.

Copyright © 2002 Canon Inc. All rights reserved.





FCC Notice

(Digital Camera, Model PC1037)

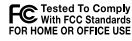

This device complies with Part 15 of the FCC Rules. Operation is subject to the following two conditions;

- (1) this device may not cause harmful interference, and
- (2) this device must accept any interference received, including interference that may cause undesired operation.

Note: This equipment has been tested and found to comply with the limits for Class B digital devices, pursuant to Part 15 of the FCC rules. These limits are designed to provide reasonable protection against harmful interference in a residential installation. This equipment generates, uses and can radiate radio frequency energy and, if not installed and used in accordance with the instructions, may cause harmful interference to radio communications. However, there is no guarantee that interference will not occur in a particular installation. If this equipment does cause harmful interference to radio or television reception, which can be determined by turning the equipment off and on, the user is encouraged to try to correct the interference by one or more of the following measures:

- Reorient or relocate the receiving antenna.
- Increase the separation between the equipment and receiver.
- Connect the equipment into an outlet on a circuit different from that to which the receiver is connected.
- Consult the dealer or an experienced radio/TV technician for help.

The cable with the ferrite core provided with the digital camera must be used with this equipment in order to comply with Class B limits in Subpart B of Part 15 of the FCC rules.

Do not make any changes or modifications to the equipment unless otherwise specified in the manual. If such changes or modifications should be made, you could be required to stop operation of the equipment.

Canon U.S.A. Inc.
One Canon Plaza, Lake Success, NY 11042, U.S.A.
Tel No. (516) 328-5600

Canadian Radio Interference Regulations

THIS CLASS B DIGITAL APPARATUS MEETS ALL REQUIREMENTS OF THE CANADIAN INTERFERENCE CAUSING EQUIPMENT REGULATIONS.

Réglementation canadienne sur les interférences radio

CET APPAREIL NUMERIQUE DE LA CLASSE B RESPECTE TOUTES LES EXIGENCES DU REGLEMENT SUR LE MATERIEL BROUILLEUR DU CANADA.





Functions Available in Each Shooting Mode

The chart below is a reference for the settings available for various shooting conditions. The settings selected in each shooting mode are saved after you finish shooting.

Function		Auto	Manual	Stitch Assist	Movie	Reference Page
Resolution	Large	L ●*	●*	▲*	—	p. 45
	Medium 1	M1 ●	●	▲	—	p. 45
	Medium 2	M2 ●	●	▲	—	p. 45
	Small	S ●	●	▲	—	p. 45
	Movie	640 —	—	—	●	p. 45
	Movie	820 —	—	—	●*	p. 45
	Movie	160 —	—	—	●	p. 45
Compression	Superfine	●	●	▲	—	p. 45
	Fine	●*	●*	▲*	—	p. 45
	Normal	●	●	▲	—	p. 45
Flash	Auto	●	●	—	—	p. 47
	Red-Eye Reduction Auto	●*	●*	—	—	p. 47
	On	—	●	▲	—	p. 47
	Off	●	●	▲*	●	p. 47
	Slow-Synchro	—	●	▲	—	p. 47
Macro Mode	●	●	▲	●	p. 49	
Infinity Mode	—	●	▲	●	p. 49	
Focus Lock	—	●	—	—	p. 58	
AE Lock	—	●	—	—	p. 60	
FE Lock	—	●	—	—	p. 61	
Shooting Method	Single	●*	●*	▲*	●*	—
	Continuous	—	●	—	—	p. 51
	Self-timer	●	●	▲	●	p. 52
Autofocus Modes	—	●	—	—	p. 62	





Function	Auto	Manual	Stitch Assist	Movie	Reference Page
AF-assist Beam	●	●	▲	●	p. 35
Light Metering	—	●	—	—	p. 63
Digital Zoom	●	●	—	—	p. 50
Exposure Compensation	—	●	▲	●	p. 64
Long Shutter	—	● ⁽¹⁾	—	—	p. 65
White Balance	—	●	▲	●	p. 67
Photo Effect	—	●	▲	●	p. 70
ISO Speed	— ⁽²⁾	●	— ⁽²⁾	— ⁽²⁾	p. 71
Auto Rotate	●	●	▲	—	p. 72

* Default setting.

● Setting available.

▲ Setting can only be selected for the first image.

■ (Shaded Area): Setting is memorized even when the camera power is shut off.

• With the exception of the [Date/Time], [Language] and [Video System] settings, all the other menu settings and changes made with the camera buttons can be reset to the default values in a single operation. (p. 125)

(1) The ISO speed cannot be set to [AUTO].

(2) The ISO speed is automatically set.

