

ENGLISH



Canon DIGITAL CAMERA

Canon

PowerShot S500
DIGITAL ELPH

DIGITAL
IXUS 500

PowerShot S410
DIGITAL ELPH

DIGITAL
IXUS 430

Canon

PowerShot S500 DIGITAL ELPH
DIGITAL IXUS 500
PowerShot S410 DIGITAL ELPH
DIGITAL IXUS 430

Camera User Guide



DiG!C



Camera User Guide

Please read the *Read This First* section (p. 7).
Please also read the *Software Starter Guide* and the *Direct Print User Guide*.

Flowchart and Reference Guides



This Guide

Shooting with the Camera



Software Starter Guide

Installing the Software



This Guide

Connecting the Camera to a Computer



This Guide



Software Starter Guide

Downloading Images to a Computer



Direct Print User Guide



Printer User Guide

Using the Printer and Printing

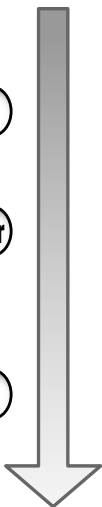

Use of genuine Canon accessories is recommended.

This product is designed to perform optimally when used with genuine Canon accessories. Canon shall not be liable for any damage to this product and/or accidents such as fire, etc., caused by the malfunction of non-genuine Canon accessories (e.g., a leakage and/or explosion of a battery pack). Please note that this warranty does not apply to repairs arising out of the malfunction of non-genuine Canon accessories, although you may request such repairs on a chargeable basis.

Camera Body Temperature

If your camera is used for prolonged periods, the camera body may become warm. Please be aware of this and take care when operating the camera for an extended period.

About the LCD Monitor

The LCD monitor is produced with extremely high-precision manufacturing techniques. More than 99.99% of the pixels operate to specification. Less than 0.01% of the pixels may occasionally misfire or appear as red or black dots. This has no effect on the recorded image and does not constitute a malfunction.





Video Format

Please set the camera's video signal format to the one used in your region before using it with a TV monitor (p. 127).

Charging the Date/Time Battery

- The camera has a built-in rechargeable lithium battery that maintains the date, time and other camera settings. This battery recharges when the main battery pack is inserted into the camera. When you first purchase the camera, place a charged battery pack in it or use the AC adapter kit (sold separately) for at least 4 hours to charge the date/time battery. It will charge even when the camera power is set to Off.
- If the Date/Time menu appears when the camera power is turned on, it means that the date/time battery charge is depleted. Recharge it as described above.

Conventions Used in the Text

Icons on the right end of title bars show the applicable operating modes. As in the example below, the procedure can be performed in  (Auto),  (Manual),  (Stitch Assist) or  (Movie) mode.

Using the Self-timer



This mark denotes issues that may affect the camera's operation.



This mark denotes additional topics that complement the basic operating procedures.

Question? Look Here First

What settings are available under each function?

Will my settings remain in effect even after I've turned the camera off?

- See *Functions Available in Each Shooting Mode* (p. 160).

What can be accomplished with each function?

- See *FUNC. MENU* (p. 44).
- See *Rec. Menu* (p. 47).
- See *Play Menu* (p. 48).
- See *Set up Menu* (p. 48).
- See *My Camera Menu* (p. 51).

What do the icons listed in the *Camera User Guide* mean?



- See *Information Displayed on the LCD Monitor* (p. 35).
- See *Menu Settings and Factory Defaults* (p. 47).

Thumb Index



Preparing the Camera	18
Basic Functions	30
Shooting	53
Playback	89
Erasing	105
Print Settings/Transferring	108
Connecting the Camera to a Computer/TV	118
My Camera Settings	129
List of Messages	134
Troubleshooting	136
Appendix	140
Photo Tips and Information	153

Items marked with ☆ are lists or charts that summarize camera functions or procedures.

Read This First	7
Please Read	7
Safety Precautions.....	8
Preventing Malfunctions	13
Components Guide	14
Preparing the Camera	
Charging the Battery Pack	18
Installing the Battery Pack	21
Installing the CF Card	23
Setting the Date and Time	26
Setting the Language.....	28
Basic Functions	
Turning the Power On.....	30
Switching Between Shooting/Playback.....	32
Using the LCD Monitor	33
Information Displayed on the LCD Monitor	35
Using the Viewfinder	39
Using the Zoom.....	40
Pressing the Shutter Button	41
☆ Selecting Menus and Settings	43
☆ Menu Settings and Factory Defaults	47
Resetting Settings to Their Default Values.....	52
Shooting	
📷 Shooting in Auto Mode	53
Reviewing an Image Right after Shooting.....	54
Changing Resolution/Compression Settings	55
Quick Shots	57
⚡ Using the Flash	58
🌸 Shooting Close-Ups/ ▲ Infinity Shots.....	60
Using the Digital Zoom	62
📄 Continuous Shooting	63
🕒 Using the Self-timer.....	64
📷M Shooting in Manual Mode	66
📷 Shooting Panoramic Images (Stitch Assist).....	67

 Shooting a Movie.....	70
Shooting Hard-to-Focus Subjects (Focus Lock, AF Lock)	72
Locking the Exposure Setting (AE Lock)	74
Locking the Flash Exposure Setting (FE Lock)	75
Switching between Focusing Modes	76
 Switching between Light Metering Modes	77
Adjusting the Exposure Compensation	78
Shooting in Long Shutter Mode	79
Adjusting the Tone (White Balance)	81
Changing the Photo Effect.....	84
Adjusting the ISO Speed	85
Setting the Auto Rotate Function	86
Resetting the File Number.....	87

Playback

Displaying Images Individually.....	89
 Magnifying Images.....	90
 Viewing Images in Sets of Nine (Index Playback)	91
Viewing Movies.....	93
Editing Movies	95
Rotating Images in the Display	97
Attaching Sound Memos to Images.....	98
Automated Playback (Slide Shows)	100
Protecting Images.....	104

Erasing

 Erasing Single Images	105
Erasing All Images	106
Formatting CF Cards	107

Printing

About Printing.....	108
Setting the DPOF Print Settings	110

Image Transmission Settings (DPOF Transfer Order)

Selecting Images for Transferring.....	116
--	-----

Connecting the Camera to a Computer

Connecting the Camera to a Computer	119
Computer System Requirements.....	119
Downloading Images by Direct Transfer	123

Connecting the Camera to the Computer to Download Images without Installing Software	125
Downloading Directly from a CF Card	126
Viewing Images on a TV set.....	127
Customizing the Camera (My Camera Settings)	
Changing My Camera Settings	129
Registering My Camera Settings	131
List of Messages	134
Troubleshooting	136
Appendix	
Using an AC Adapter Kit (Sold Separately)	140
Using a Car Battery Charger (Sold Separately)	141
Camera Care and Maintenance	142
Specifications	143
Photo Tips and Information	
Tip for Using the Self-timer	153
How to adjust the exposure	153
ISO Speed.....	154
Advanced Technique for the Macro mode	154
Index	155
☆ Functions Available in Each Shooting Mode	160

Please Read

Test Shots

Before you try to photograph important subjects, we highly recommend that you shoot several trial images to confirm that the camera is operating and being operated correctly.

Please note that Canon, its subsidiaries and affiliates, and its distributors are not liable for any consequential damages arising from any malfunction of a camera or accessory, including CF cards, that results in the failure of an image to be recorded or to be recorded in a format that is machine readable.

Warning Against Copyright Infringement

Please note that Canon digital cameras are intended for personal use and should never be used in a manner that infringes upon or contravenes international or domestic copyright laws and regulations. Please be advised that in certain cases the copying of images from performances, exhibitions, or commercial properties by means of a camera or other device may contravene copyright or other legal rights even if the image was shot for personal use.

Warranty Limitations

This camera's warranty is only effective in the country of sale. If a problem arises while the camera is in use abroad, please convey it back to the country of sale before proceeding with a warranty claim to a Canon Customer Support Help Desk.

For Canon Customer Support contacts, please see the Canon Limited Warranty supplied with your camera.

Safety Precautions

- Before using the camera, please ensure that you read and understand the safety precautions described below. Always ensure that the camera is operated correctly.
- The safety precautions noted on the following pages are intended to instruct you in the safe and correct operation of the camera and its accessories to prevent injuries or damage to yourself, other persons and equipment.
- In the next few pages, the term “equipment” refers primarily to the camera and its power supply accessories, such as the battery charger and optional compact power adapter or car battery charger.

Warnings

-
- **Do not aim the camera directly into the sun or at other intense light sources that could damage your eyesight.**
-
- **Do not trigger the flash in close proximity to human or animal eyes.** Exposure to the intense light produced by the flash may damage eyesight. In particular, remain at least one meter (39 inches) away from infants when using the flash.
-
- **Store this equipment out of the reach of children and infants.** Accidental damage to the camera or batteries by a child could result in serious injury. In addition, placement of the strap around the child’s neck could result in asphyxiation.
-
- **Do not attempt to disassemble or alter any part of the equipment that is not expressly described in this guide.** Disassembly or alteration may result in high-voltage electrical shock. Internal inspections, alterations and repairs should be conducted by qualified service personnel authorized by your camera distributor or a Canon Customer Support Help Desk.
-
- **To avoid the risk of high-voltage electrical shock, do not touch the flash portion of the camera if it has been damaged.** Similarly, never touch internal portions of the equipment that become exposed as a result of damage. There is a risk of high-voltage electrical shock. Please take the first opportunity to consult your camera distributor or the closest Canon Customer Support Help Desk.
-

-
- **Stop operating the equipment immediately if it emits smoke or noxious fumes.** Failure to do so may result in fire or electrical shock. Immediately turn the camera power off, remove the camera battery or unplug the power cable from the power outlet. Confirm that smoke or fume emissions have ceased. Please consult your camera distributor or the closest Canon Customer Support Help Desk.
-
- **Stop operating the equipment if it is dropped or the casing is damaged.** Failure to do so may result in fire or electrical shock. Immediately turn the camera power off, remove the camera battery or unplug the power cable from the power outlet. Please consult your camera distributor or the closest Canon Customer Support Help Desk.
-
- **Do not allow the equipment to come into contact with, or become immersed in, water or other liquids.** Do not allow liquids to enter the interior. The camera has not been waterproofed. If the exterior comes into contact with liquids or salt air, wipe it dry with a soft, absorbent cloth. If water or other foreign substances enter the interior, immediately turn the camera power off and remove the camera battery or unplug the power cable from the power outlet. Continued use of the equipment may result in fire or electrical shock. Please consult your camera distributor or the closest Canon Customer Support Help Desk.
-
- **Do not use substances containing alcohol, benzene, thinners or other flammable substances to clean or maintain the equipment.** The use of these substances may lead to fire.
-
- **Remove the power cable on a regular periodic basis and wipe away the dust and dirt that collects on the plug, the exterior of the power outlet and the surrounding area.** In dusty, humid or greasy environments, the dust that collects around the plug over long periods of time may become saturated with humidity and short-circuit, leading to fire.
-
- **Do not cut, damage, alter or place heavy items on the power adapter cable.** Any of these actions may cause an electrical short circuit, which may lead to fire or electrical shock.
-
- **Do not handle the power cable if your hands are wet.** Handling it with wet hands may lead to electrical shock. When unplugging the cable, ensure that you hold the solid portion of the plug. Pulling on the flexible portion of the cable may damage or expose the wire and insulation, creating the potential for fires or electrical shocks.
-

-
- **Use only recommended power accessories.** Use of power sources not expressly recommended for this equipment may lead to overheating, distortion of the equipment, fire, electrical shock or other hazards.
-
- **Do not place the batteries near a heat source or expose them to direct flame or heat.** Neither should you immerse them in water. Such exposure may damage the batteries and lead to the leakage of corrosive liquids, fire, electrical shock, explosion or serious injury.
-
- **Do not attempt to disassemble, alter or apply heat to the batteries.**
There is serious risk of injury due to an explosion. Immediately flush with water any area of the body - including the eyes and mouth, or clothing - that comes into contact with the inner contents of a battery. If the eyes or mouth contact these substances, immediately flush with water and seek medical assistance.
-
- **Avoid dropping or subjecting the batteries to severe impacts that could damage the casings.** It could lead to leakage and injury.
-
- **Do not short-circuit the battery terminals with metallic objects, such as key holders.** It could lead to overheating, burns and other injuries. Use the supplied terminal cover to transport or store the battery pack.
-
- **Before you discard a battery, cover the terminals with tape or other insulators to prevent direct contact with other objects.** Contact with the metallic components of other materials in waste containers may lead to fire or explosions. Discard the batteries in specialized waste facilities if available in your area.
-
- **Use only recommended batteries and accessories.** Use of batteries not expressly recommended for this equipment may cause explosions or leaks, resulting in fire, injury and damage to the surroundings.
-
- **Use the specified battery charger to charge Battery Pack NB-1LH or NB-1L.** Use of other chargers may lead to overheating, distortion of the equipment, fire or electrical shock.
-
- **Disconnect the battery charger and compact power adapter from both the camera and the power outlet after recharging and when it is not in use to avoid fire and other hazards.** Continuous use over a long period may cause a unit to overheat and distort, resulting in fire.
-

-
- **The camera terminals of the battery charger and compact power adapter are designed for exclusive use with your camera.** Do not use them with other products or batteries. There is a risk of fire and other hazards.
-

Caution about magnetic fields

Keep objects that are sensitive to magnetic fields (such as credit cards) away from the speaker of the camera (p. 14). Such items may lose data or stop working.

Cautions

- **Avoid using, placing or storing the equipment in places subject to strong sunlight or high temperatures, such as the dashboard or trunk (boot) of a car.** Exposure to intense sunlight and heat may cause the batteries to leak, overheat or explode, resulting in fire, burns or other injuries. High temperatures may also cause deformation of the casing. Ensure that there is good ventilation when using the battery charger to charge the battery pack.

 - **Do not store the equipment in humid or dusty areas.** Storage in such areas could lead to fire, electrical shock or other damage.

 - **Be careful not to bang the camera or subject it to strong impacts or shocks that could lead to injury or damage the equipment when wearing or holding it by the strap.**

 - **Be careful not to cover the flash with your fingers or clothing when shooting.** The flash may be damaged and emit smoke or noise. In addition, do not touch the surface of the flash after taking several pictures in rapid succession. Either action could result in burns.

 - **Do not operate the flash with dirt, dust or other items stuck to its lens.** The resulting heat build-up could damage the flash.

 - **Ensure that the battery charger is plugged into a power outlet of the specified rating, not over the specified rating.** The plug of the battery charger varies according to region.

 - **Do not use the battery charger or compact power adapter if the plug or cable is damaged, or if the plug is not fully inserted into the power outlet.**

 - **Do not allow metal objects (such as pins or keys) or dirt to contact the charger terminals or plug.**

 - **If your camera is used for prolonged periods, the camera body may become warm.** Please take care when operating the camera for extended periods as your hands may experience a burning sensation.
-

Preventing Malfunctions

Avoid Strong Magnetic Fields

Never place the camera in close proximity to electric motors or other equipment generating strong electromagnetic fields. Exposure to strong magnetic fields may cause malfunctions or corrupt image data.

Avoid Condensation Related Problems

Moving the equipment rapidly between hot and cold temperatures may cause condensation (water droplets) to form on its external and internal surfaces. You can avoid this by placing the equipment in an airtight, resealable plastic bag and letting it adjust to temperature changes slowly before removing it from the bag.

If Condensation Forms Inside the Camera

Stop using the camera immediately if you detect condensation. Continued use may damage the equipment. Remove the CF card, battery pack or compact power adapter from the camera and wait until the moisture evaporates completely before resuming use.

Extended Storage

When not using the camera for extended periods of time, remove the battery pack and store the equipment in a safe place. Storing the camera for extended periods with a battery pack installed will run down the battery pack and may damage the camera. The date, time and other camera settings may reset to default settings if the battery pack has been removed for more than three weeks. Follow the instructions in this guide to reset the desired settings.

Front View

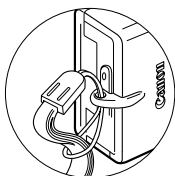
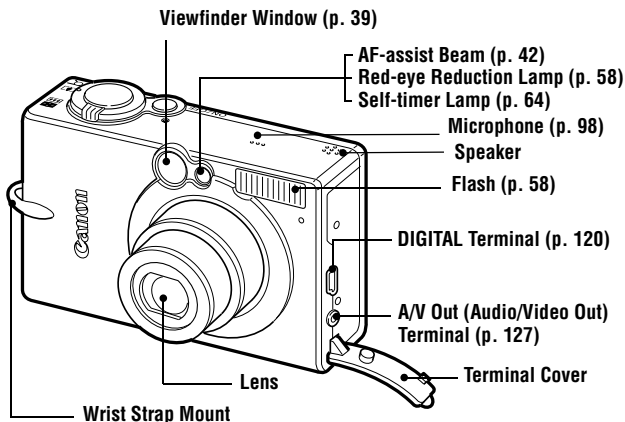

Attaching the Wrist Strap*

* Be careful not to wave the camera about or catch it on other items when dangling it from the wrist strap.

Back View

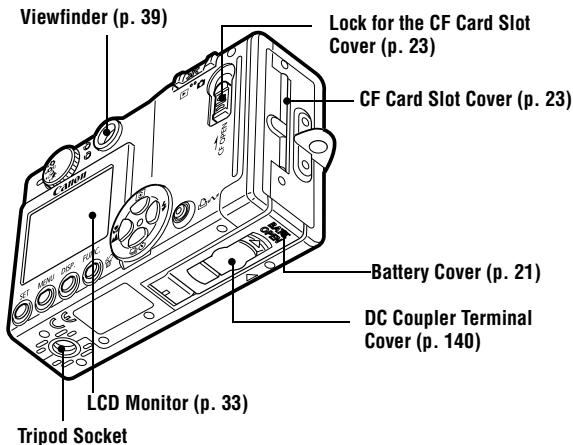

The following cables are used to connect the camera to a computer or printer.

Computer (p. 118)

Interface Cable IFC-400PCU (supplied with the camera)

Direct Print Compatible Printers (Sold Separately)

• CP Printers

Interface Cable IFC-400PCU (supplied with camera) or the Direct Interface Cable DIF-100 (supplied with the CP-100/CP-10).

• Bubble Jet Printers

- *Bubble Jet Direct* Compatible Printers:

Please refer to your Bubble Jet printer user guide.

- *PictBridge* Compliant Printers:

Interface Cable IFC-400PCU (supplied with the camera)

• *PictBridge* Compliant Non-Canon Printers:

Interface Cable IFC-400PCU (supplied with the camera)

Please refer to the *System Map* or the *Direct Print User Guide* supplied with the camera for direct print compatible printer information.

Operation Panel

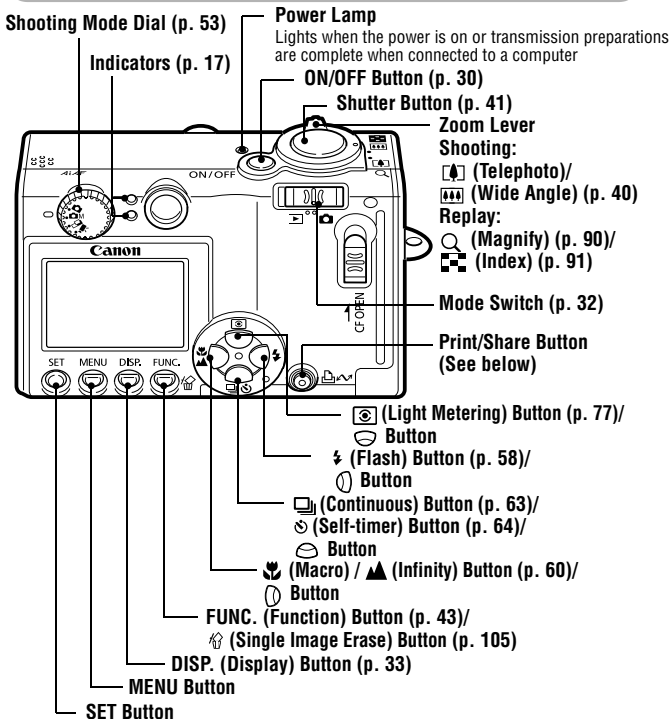

The following operations are accessible through one easy press of the  (Print/Share) button.

- Printing: See the *Direct Print User Guide* (separate from this guide)
- Downloading images (Windows only): See p.118 of this guide and the *Software Starter Guide* (separate from this guide)

The indicator blinks or lights during a printer or computer connection.

Blue: Ready to print/Ready to transfer images

Blinking blue: Printing/Transferring

Indicator

The indicator lights or blinks when the **ON/OFF** button or shutter button is pressed.

Upper Indicator

Green: Ready to shoot

Blinking Green: Recording to CF card / Reading CF card / Erasing from CF card/Transmitting data (during a computer connection)

Orange: Ready to shoot (flash on)

Blinking Orange: Ready to shoot (camera shake warning)

Lower Indicator

Yellow: Macro mode / Infinity mode/ AF lock

Blinking Yellow: Focusing difficulty (single beep).

Although you can still press the shutter button when the indicator blinks yellow, you are recommended to shoot using the focus lock or AF lock (p. 72).

Charging the Battery Pack

Use the following procedures to charge the battery pack the first time you use the camera or when the “Change the battery pack” message displays.

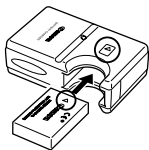

1 Insert the battery pack into the battery charger.

Align the battery pack according to the arrows on the battery and the charger. Insert the battery securely.

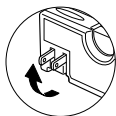

2 Battery charger model names and types vary by region.

(For CB-2LS)

Plug the battery charger into a power outlet.

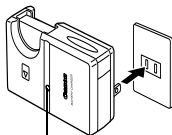

Charge Indicator

(For CB-2LSE)

Attach the power cord to the battery charger and plug it into a power outlet.

- The charge indicator will light red while the battery pack is charging. It will change to green when the charge is complete.
- After charging, unplug the battery charger and remove the battery pack.



To protect the battery pack and prolong its life, do not charge it for longer than 24 hours continuously.



- Since this is a lithium ion battery pack, you need not completely discharge it before recharging. It can be recharged at any point. However, since the maximum number of charge cycles is approximately 300 times (battery life), you are recommended to charge the battery pack after having discharged it completely to prolong battery life.
- It takes approximately 130 minutes to fully charge the battery pack from a fully discharged state (based on Canon's testing standard). Charging it within a temperature range of 5° to 40 °C (41° to 104 °F) is recommended.
- Charge times may vary according to the ambient temperature and the battery pack's charge state.
- See *Battery Capacity* (p. 147).
- You may hear a noise during charging. This is not a malfunction.

Handling Precautions

- Keep the battery pack terminals (\oplus T \ominus) clean at all times. Dirty terminals may cause poor contact between the battery pack and camera. Polish the terminals with a tissue or a dry cloth before charging or using the battery pack.
- Do not rapidly overturn or wave the battery charger around when it contains the battery pack. The battery pack could fly out.
- At low temperatures, battery pack performance may be reduced and the low battery icon may appear earlier than usual. Under these conditions, resuscitate the battery pack by warming it in a pocket immediately before use. However, ensure that there are no metallic items in the pocket that could cause a short circuit, such as a key holder, etc.
- Do not place anything, such as tablecloths, carpets, bedding or cushions, on top of the battery charger while it is charging. Heat will build up and could result in a fire.
- Do not charge batteries other than Battery Pack NB-1LH or NB-1L in this charger.
- The battery pack continues to discharge a minimal portion of its power while installed in the camera, even with the power off, or in the charger. This will shorten battery life.

- Do not allow any metal objects such as key rings to touch the \oplus and \ominus terminals (Fig. A), as this can damage the battery pack. To carry the battery pack or store it during periods of disuse, always replace the terminal cover (Fig. B).

Fig. A



Fig. B



- Even charged battery packs continue to discharge naturally. You are advised to charge the battery on the day of use, or one day before, to ensure a full charge.
- Since storing a fully charged battery pack for long periods of time (about 1 year) can shorten its life cycle or affect performance, you are recommended to use the battery pack in the camera until it is completely discharged and to store it at normal temperature (23 °C/73 °F) or lower. If you do not use the battery pack for long periods of time, charge it fully and discharge it fully in the camera at least once a year before returning it to storage.
- If the performance of the battery pack diminishes substantially even when it is fully charged, its life has been exceeded and it should be replaced.

Installing the Battery Pack

Install Battery Pack NB-1LH (supplied) as shown below. Battery Pack NB-1L can also be used with the camera.



Please recharge the battery pack (p. 18) before you use it for the first time.

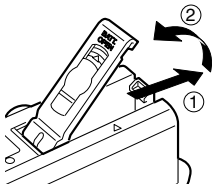

1 Slide the battery cover in the direction of the arrows.

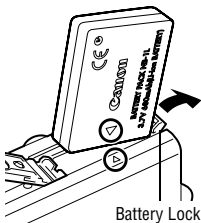

2 Press the battery lock while inserting the battery pack all the way in until the lock clicks.

- Insert the battery pack correctly by aligning the arrows on the camera and the battery pack.
- To remove the battery pack, press the battery lock and pull the battery pack out.

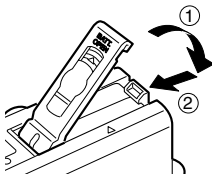

3 Slide the battery cover closed.



- Do not turn off the power or open the battery cover while the upper indicator beside the viewfinder blinks green. The camera is writing, reading, erasing or transmitting an image to or from the CF card.
- Remove the battery pack when the camera is not in use. Please note, however, that the date, time and other camera settings may reset to the default settings if the battery pack has been removed for more than three weeks.



Please use an AC Adapter Kit ACK500 (sold separately) for extended use of the camera (p. 140).

Battery Pack Charge

The following icons and messages will display when the battery pack charge is low.

	Battery pack charge is low. Recharge it as soon as possible before it is required for an extended period. When the LCD monitor is off, this icon will display when you press any button other than the ON/OFF, SET or MENU button.
Change the battery pack	Battery charge is insufficient to operate the camera. Replace the battery pack immediately.



See *Battery Capacity* (p. 147).

Installing the CF Card

Turn the camera power off and insert the CF card with the following procedures.

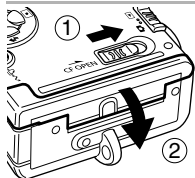

- 1** Slide the lock up and open the CF card slot cover.

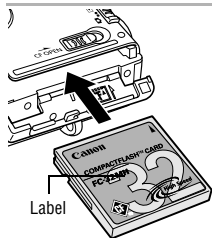

- 2** Insert the CF card with its label facing upward until the CF card eject button fully extends.

Insert the card firmly into the slot, following the diagram on the CF card slot cover.

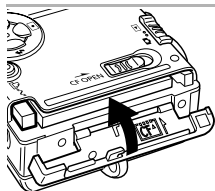

- 3** Close the CF card slot cover.

To remove the CF card

Push the eject button and pull the CF card out.

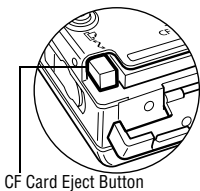



-
- Since the camera is writing, reading, erasing or transmitting data to or from the CF card when the upper indicator beside the viewfinder blinks green, never perform the following actions during this time. It could corrupt the image data.
 - Subject the camera body to vibration or shocks.
 - Turn the camera's power off, or open the battery cover or CF card slot cover.
 - Please note that CF cards formatted with other manufacturers' cameras or a computer, or formatted or edited with application programs, may slow down writing to the CF card or may not operate correctly in the camera.
 - You are recommended to use CF cards that have been formatted in your camera (p. 107). The card supplied with the camera may be used without further formatting.



See *CF Cards and Estimated Capacities* (p. 148).

Handling Precautions for CF Cards

- CF cards are high-precision electronic devices. Do not bend them, apply force to them, or subject them to shocks or vibration.
- Do not attempt to disassemble or alter the CF card.
- Moving a CF card rapidly between temperature extremes will cause condensation to form in the card and lead to a malfunction. To avoid condensation, place the CF card in a sealed plastic bag before moving it into a different temperature zone and allow it to adjust slowly to the new temperature.
- If condensation forms on the CF card, store it at room temperature until the water droplets have evaporated naturally.
- Do not use or store CF cards in the following locations.
 - Locations subject to dust or sand
 - Locations subject to high humidity and high temperatures

Setting the Date and Time

The Date/Time menu will appear the first time the camera power is turned on or whenever the built-in rechargeable lithium date/time battery charge is low. Start from Step 5 to set the date and time.

Power Lamp

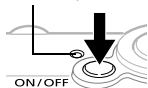



1 Press the ON/OFF button until the power lamp lights.

MENU



2 Press the MENU button.

The  (Rec.) or  (Play) menu is displayed.



3 Use the  or  button to select the  (Set up) menu.

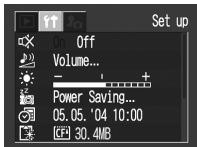

4 Use the  or  button to select  and press the SET button.

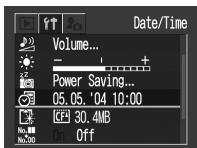





SET





5 Set the date and time.

- Use the  or  button to select a field (year, month, day, hour, minute and date format).
- Use the  or  button to change its value.

SET



6 Press the SET button.

The setting is complete.

MENU



7 Press the MENU button.

The display will return to the Shooting or Playback screen.



- Please note that the date and time settings may reset to the default settings if the camera battery has been removed for more than three weeks. Reset them when this occurs.
- Setting the date and time settings does not cause the date/time stamp to appear on images. For printing images with the date on them, refer to the *Direct Print User Guide* or *Software Starter Guide*.



Charging the Date/Time Battery

- The camera has a built-in rechargeable lithium battery for saving settings such as the date and time. This battery is recharged by the battery pack while it is in the camera. Right after purchasing the camera, leave a charged battery pack in the camera, or plug in AC Adapter Kit ACK500 (sold separately), for about 4 hours to charge the date/time battery. It will charge even when the camera power is turned off.
- If the Date/Time menu appears when the camera power is turned on, the date/time battery charge is low. Use the above method to recharge it.

Setting the Language

Use this feature to select the language for the LCD monitor display.

Power Lamp

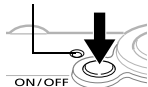



1 Press the ON/OFF button until the power lamp lights.

MENU



2 Press the MENU button.

The  (Rec.) or  (Play) menu is displayed.



3 Use the  or  button to select the  (Set up) menu.

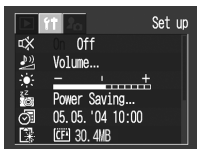

4 Use the  or  button to select  and press the SET button.







SET





Language	
English	Italiano
Deutsch	Norsk
Français	Svenska
Nederlands	Español
Dansk	汉语
Suomi	日本語



- 5** Use the , ,  or  button to select a language and press the **SET** button.



- 6** Press the **MENU** button.
The display will return to the Shooting or Playback screen.





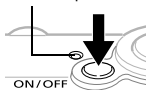

The Language menu can also be displayed in playback mode by holding down the **SET** button and pressing the **MENU** button. This function cannot be used while a movie clip is played back, or a separately sold printer is connected to the camera.

Turning the Power On

Power Lamp



Press the ON/OFF button until the power lamp lights green.

- The lens extends when the mode switch is set to .
- The lens retracts approximately 1 minute after sliding the mode switch from  to .
- When the mode switch is set to , the upper indicator beside the viewfinder will blink green and the LCD monitor will turn on.

To turn the power off

Press the **ON/OFF** button again.



- The Date/Time menu will appear the first time the camera power is turned on or whenever the built-in rechargeable lithium battery charge is low. Reset the date and time when this occurs (p. 26).
- If the power saving function activates, press the **ON/OFF** button to restore power. (p. 31)
- You will hear a start-up sound and see the start-up image when the power is turned on. (To change the start-up sound and image, see p.49, 51, 129)
- The start-up image does not display when the LCD monitor is turned off in shooting mode or when the camera is connected to a TV via the A/V Out terminal.

Turning On the Camera without the Start-Up Sound and Start-Up Image

Hold the **SET** button down while turning on the power.

Power Saving Function

This camera is equipped with a power saving function.

When this function is turned on and it activates, restore power by pressing the **ON/OFF** button.

Shooting Mode: Powers down approximately 3 minutes after the last control is accessed on the camera. The LCD monitor automatically turns off 1 minute* after the last control is accessed even if [Auto Power Down] is set to [Off]. (Press any button except the **ON/OFF** button to turn the LCD monitor back on.)

* This time can be changed (p. 49).

Playback Mode: Powers down approximately 5 minutes after the last control is accessed on the camera.

Connected to a Printer (sold separately):

Powers down approximately 5 minutes after the last control is accessed on the camera or on a connected printer.

- The power saving function will not activate during slide show or while the camera is connected to a computer.
- The power saving function can be turned off (p. 49).

Switching Between Shooting/Playback

The mode switch is used to select Shooting and Playback functions.

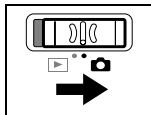

To Shoot Images (Shooting Mode)

Slide the mode switch to .

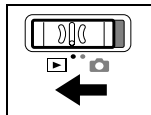



To Play Back Images (Playback Mode)

Slide the mode switch to .

- When a printer (sold separately) is connected, images can be printed (see the *Direct Print User Guide*).
- When a camera is connected, recorded images can be downloaded to and viewed with a computer (p. 119).



When a printer (sold separately) is properly connected, the ,  or  icon appears on the LCD monitor.

Using the LCD Monitor

The LCD monitor can be used to compose images while shooting, adjust menu settings and play back recorded images. Icons showing the camera's status and setting contents appear on the LCD monitor.



The image in the LCD monitor will darken in strong sunlight or bright light. This does not constitute a malfunction.

Shooting Mode (📷)

DISP.



Press the DISP. button.

The display mode changes as follows with each press.

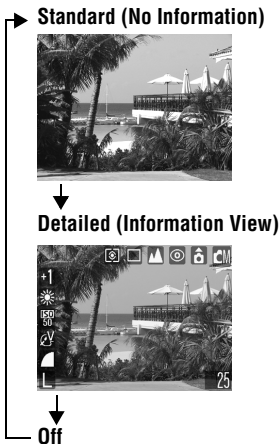

- The LCD monitor setting (On or Off) is saved by the camera when the power is turned off so that the same setting is automatically available when the power is turned on again. However, the setting may be lost when the power has been turned off after the “Change the battery pack” message has displayed, while the LCD monitor was on in shooting mode.
- In the 📷 or 📺 mode, the LCD monitor turns on regardless of its On/Off setting.

Playback Mode (▶▶)

When the mode switch is set to ▶▶, the LCD monitor will turn on.

DISP.



Press the DISP. button.

The display mode changes as follows with each press.

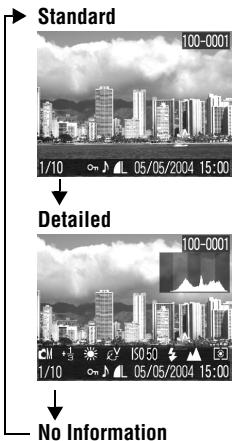

In Index playback mode (p. 91), the detailed display is not available.



Information Displayed on the LCD Monitor

When shooting or playing back images, the shooting information or play back information appears on the LCD monitor.

Shooting Mode

When setting the flash, continuous mode, self-timer, macro mode, infinity mode, or the metering method, the shooting information displays on the LCD monitor for approximately 6 seconds even if the LCD monitor is set to [Standard (No Information)] or [Off]. (It may not display under some circumstances, depending on the selected settings.)



A slow shutter speed has likely been selected because of insufficient lighting if the upper indicator beside the viewfinder blinks orange after the metering preparations are complete and the camera shake icon  appears in the LCD monitor. Set the flash to  or , or affix the camera to a tripod to shoot.



- Right after a shot is taken, the image and its information appear in the LCD monitor for 2 seconds (or for the number of seconds selected if the review time was changed (2 - 10 sec.)) even if you release the shutter button. If the **SET** button is pressed while an image is displayed, it will continue to display (p. 54)
- While a recorded image is displayed on the LCD monitor, you can check the exposure with the graph (see *Histogram Function* p.38) that shows the distribution of the brightness data. If the exposure requires adjustment, set the exposure compensation and reshoot. (Press the **DISP.** button if the histogram and other information is not shown)

Exposure Compensation (p. 78)
Long Shutter Mode (p. 79)
White Balance (p. 81)
ISO Speed (p. 85)
Photo Effect (p. 84)
Compression (p. 55)
Resolution (p. 55)
Camera Shake Warning (p. 35)

Low Battery (p. 22)
Quick Shot (p. 57)
Metering Mode (p. 77)
Shooting Method (p. 63, 64)
Macro/Infinity (p. 60)
Flash (p. 58)
Auto Rotate (p. 86)

Shooting Mode (p. 53)
Movie Recording (p. 70)

Digital Zoom (p. 62)
 PowerShot S500 DIGITAL ELPH/DIGITAL IXUS 500:
 3.8x, 4.9x, 6.1x, 7.6x, 9.3x, 12.0x
 PowerShot S410 DIGITAL ELPH/DIGITAL IXUS 430:
 4.3x, 5.3x, 6.7x, 8.2, 11.0x

AE Lock (p. 74)
FE Lock (p. 75)
AF Lock (p. 72)

Shots Remaining or Remaining
 Movie Time/Elapsed Time



Spot AE Point Frame (Mode)
AF Frame (p. 76)

* Appears even if the LCD monitor is set to [Standard (No Information)].

(1) is not available with the PowerShot S410 DIGITAL ELPH/DIGITAL IXUS 430.

Zoom powers indicate the combined optical and digital amount of zoom.

These figures appear when the digital zoom is activated.

Playback Mode (Standard Display)

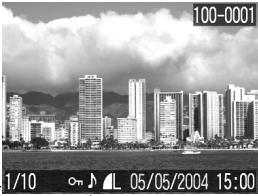

100-0001 — File Number

Image Number — 1/10 05/05/2004 15:00 — Shooting Date

Protection Status (p. 104)

WAVE Format Sound (p. 98)

Resolution (Still Images) (p. 55)

Movie (p. 93)

Compression (Still Images) (p. 55)

Playback Mode (Detailed Display)



Histogram

100-0001

... Long Shutter Mode (p. 79)

Shooting Mode (p. 53)

... Exposure Compensation (p. 78)

White Balance (p. 81)

Photo Effect (p. 84)

ISO 50 ISO100 ISO200 ISO400
ISO Speed (p. 85)

(1) Resolution (Movies) (p. 55)

Flash (p. 58)





Macro/Infinity (p. 60)

Metering Mode (p. 77)

Movie Length Shown on Movie Files (p. 70)

(1) is not available with the PowerShot S410 DIGITAL ELPH/DIGITAL IXUS 430.

The following information may also be displayed with some images.

	A sound file in a format other than the WAVE format is attached or the file format is not recognized.
	JPEG file with format not conforming to Design rule for Camera File System Standards
	RAW format file
	File with unrecognized format



Please note that image information recorded by this camera may not display correctly on other cameras and image information recorded by other cameras may not display correctly on this camera.

Histogram Function

The histogram is a graph that allows you to judge the brightness of the shot image. The greater the bias toward the left in the graph, the darker the image. The greater the bias toward the right, the brighter the image. If the image is too dark, adjust the exposure compensation to a positive value. Similarly, adjust the exposure compensation to a negative value if the image is too bright (p. 78).

Sample Histograms



Dark Image



Balanced Image



Bright Image

Using the Viewfinder

The viewfinder can be used to conserve power by setting the LCD monitor to Off (p. 33) while shooting.

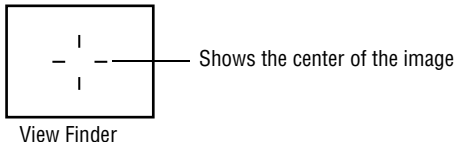

Image Seen in Viewfinder vs. Recorded Image

Usually the recorded image is wider than the image seen in the viewfinder. Confirm the actual image size with the LCD monitor. The image recorded may differ from the image seen in the viewfinder due to the distance between the viewfinder and lens (especially with close-ups). If you use the viewfinder to take close-up shots, portions of the close-up subject may not appear in the recorded image. Use the LCD monitor when taking close-up shots.

About the Autofocus Function

This camera employs AiAF (artificial intelligence autofocus) technology which uses a broad metering field to calculate the focal distance with high precision. It delivers a crisp focus even when the photographic subject is slightly off-center.

The AiAF function can be turned off so that the autofocus is metered from a fixed AF frame at the center of the field (p. 76).



Using the Zoom

The zoom can be adjusted from 36 mm to 108 mm in 35 mm film equivalent terms.

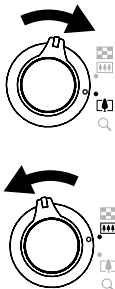
Telephoto/Wide Angle



1 Press the zoom lever toward or .

- Press the zoom lever toward  to zoom in (telephoto).
- Press the zoom lever toward  to zoom out (wide angle).

Digital Zoom

When the LCD monitor is on, you can shoot with a combined optical and digital zoom up to approximately 12x with the PowerShot S500 DIGITAL ELPH/DIGITAL IXUS 500 and 11x with the PowerShot S410 DIGITAL ELPH/DIGITAL IXUS 430 (p. 62).



The digital zoom is unavailable in some modes (p. 160).



Images become coarser the more they are digitally zoomed.

Pressing the Shutter Button

The shutter button features a two-stage action.

Pressing Halfway

Pressing halfway automatically sets the exposure and focus.

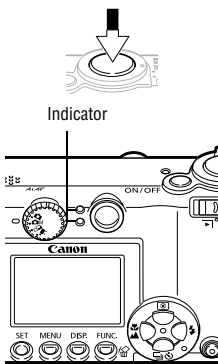

Press the shutter button halfway.

● Indicator Status

Upper Indicator

- Green: Metering complete (two beeps sound)
- Orange: Flash will fire
- Blinking Orange: Camera shake warning/Insufficient exposure

Lower Indicator

- Yellow: Macro mode/Infinity mode/AF lock (p. 72)
- Blinking Yellow: Focusing difficulty* (single beep sounds)

* Use the focus lock or AF lock to shoot when the indicator blinks yellow (p. 72).

● AF Frame Status (LCD Monitor On)

AiAF On (p. 76)

- Green Frame: Metering complete (focused AF frame)
- No Frame: Focusing difficulty (single beep sounds)

AiAF Off (p. 76) (Center AF Frame)

- Green Frame: Metering complete
- Yellow Frame: Focusing difficulty (single beep sounds)

Pressing Fully

Pressing the shutter button down fully activates the shutter and causes the shutter sound to sound.



Press the shutter button fully.

While the image is being recorded to the CF card, the upper indicator beside the viewfinder blinks green.





Shots cannot be taken while the flash is charging.

AF-assist Beam

- The AF-assist Beam will sometimes emit when the shutter button is pressed halfway to assist focusing in certain conditions, i.e., dark conditions.
- The AF-assist Beam can be turned off (p. 47).

For example, if animals are your subject, turn off the beam when shooting in the dark to avoid startling them.









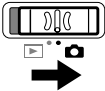

However, please keep in mind the following facts.

- Turning the AF-assist Beam off or shooting in dark places may make it more difficult for the camera to focus.
- The red-eye reduction lamp may emit when the flash is set to  or  even if the AF-assist Beam is turned off.

Selecting Menus and Settings

Menus are used to adjust shooting and playback settings, as well as other camera settings like the Date/Time and sounds. Menus are displayed by pressing the **FUNC.** or **MENU** button according to the circumstances. Use the LCD monitor to perform the following procedures.

Selecting Menu Settings with the **FUNC.** Button (Shooting Mode only)

	<p>1 Slide the mode switch to  (Rec.).</p>
<p>FUNC.</p> 	<p>2 Press the FUNC. button.</p> <p>The icons of the items that can be adjusted appear at the LCD monitor's left edge.</p>
	<p>3 Use the  or  button to select an item.</p> <p>See <i>FUNC Menu</i> on the next page for the menu items available.</p>
	<p>4 Use the  or  button to select an option.</p> <ul style="list-style-type: none"> • Some menu items can only be selected after pressing the SET button to display the next menu. Press the SET button again to confirm the setting. • You can shoot right after performing these steps. The menu displays again after the shot, allowing you to change the settings easily.
<p>FUNC.</p> 	<p>5 Press the FUNC. button.</p> <p>The menu will close.</p>

FUNC. MENU

() Exposure Compensation (p. 78)



() Photo Effect (p. 84)

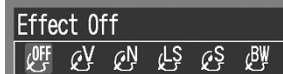

(1) Long Shutter Mode (p. 79)



() Compression (p. 55)



() White Balance (p. 81)



() Resolution (p. 55)

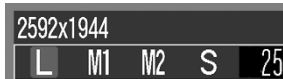

() ISO Speed (p. 85)



() Resolution (Movie)* (p. 55)



() Items in parentheses show default settings.





















*The PowerShot S410 DIGITAL ELPH/DIGITAL IXUS 430 menu is different because it does not feature the  option.

Selecting Menu Settings with the MENU Button



1

Slide the mode switch to  (Rec.) or  (Play).

	<p>2 Press the MENU button.</p> <p>In Shooting mode, the  (Rec.) menu appears. In Playback mode, the  (Play) menu appears.</p>
	<p>3 Use the  or  button to select a menu.</p> <ul style="list-style-type: none"> • Select the menu with the  /  ,  or  icon in the upper left corner of the LCD monitor selected. • The zoom lever lets you select the menu even if the  /  ,  or  icon is not selected.
	<p>4 Use the  or  button to select an item.</p> <p>See <i>Menu Settings and Factory Defaults</i> (p. 47) for the menu items.</p>
	<p>5 Use the  or  button to select an option.</p> <p>Menu items followed by an ellipsis (...) can only be selected after pressing the SET button to display the next menu. Press the SET button again to confirm the setting.</p>
	<p>6 Press the MENU button.</p> <p>In Shooting mode, the menu can be closed by pressing the shutter button halfway.</p>



See *Setting the DPOF Print Settings* for the procedures for the  (Print Order) item in the Play menu.

Shooting Mode



Rec. Menu



(The menu will appear slightly different depending on the Shooting mode)

Playback Mode



Play Menu

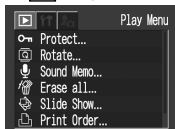

Set up Menu

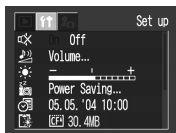

My Camera Menu



- When the My camera menu is displayed, pressing the button returns to the Rec./Play menu.
- When the Rec./Play menu is displayed, pressing the button displays the My camera menu.

: Selects items.
 : Selects options.

Shooting Mode
 Playback Mode















Menu Settings and Factory Defaults







This chart shows the options and default settings for each menu.

* Default setting



Rec. Menu















Menu Item	Options	Reference Page
 Quick Shot	Sets the Quick Shot option to on or off. <ul style="list-style-type: none">• On• Off*	p. 57
 AiAF	Sets whether or not the camera automatically selects the AF frame or a fixed center AF frame. <ul style="list-style-type: none">• On*• Off	p. 76
 Cont. Shooting	Sets the speeds of the continuous shooting mode. <ul style="list-style-type: none">•  Standard continuous shooting*•  High-speed continuous shooting	p. 63
 Self-timer	Sets the duration of the self-timer delay. <ul style="list-style-type: none">•  10 seconds*•  2 seconds	p. 64
 AF-assist Beam	Sets the AF-assist Beam to on or off. <ul style="list-style-type: none">• On*• Off	p. 42
 Digital Zoom	Sets the digital zoom to on or off. <ul style="list-style-type: none">• On• Off*	p. 62
 Review	Sets the duration images display on the LCD monitor after the shutter button releases. <ul style="list-style-type: none">• Off• 2* to 10 seconds	p. 54
 Long Shutter	Sets the shutter speed to slow settings. <ul style="list-style-type: none">• On• Off*	p. 79







Play Menu

Menu Item	Options	Reference Page
 Protect	Protects images from accidental erasure.	p. 104
 Rotate	Rotates images clockwise 90° or 270° in the display.	p. 97
 Sound Memo	Adds sound memos to images.	p. 98
 Erase all	Deletes all images from a CF card (except for protected images).	p. 106
 Slide Show	Plays images automatically one after the other.	p. 100
 Print Order	Selects images and the number of print copies for output to a direct print compatible printer or photo developing service.	p. 110
 Transfer Order	Specifies settings for images before downloading to a computer.	p. 116

Set up Menu

Menu Item	Options	Reference Page
 Mute	<p>Sets whether or not a beep sounds when the shutter button is pressed or when a menu operation is performed.</p> <p>See <i>How the [Mute] option in the  (Set up) Menu and Sound in the  (My Camera) Menu Interact</i> (p. 51).</p> <ul style="list-style-type: none"> • On • Off* <p>(Still beeps to warn of an error even when set to On.)</p>	—

Menu Item	Options	Reference Page
 Volume	Adjusts the volume of the start-up sound, operation sound, self-timer sound, shutter sound and playback sound. The volume cannot be adjusted if [Mute] is set to [On]. <div style="text-align: center;">  </div> Off 1 2* 3 4 5	-
 Start-up Vol.	Adjusts the volume of the start-up sound when the camera power is turned on.	p. 30
 Operation Vol.	Adjusts the volume of the operation sound that beeps when any button other than the shutter button is pressed.	-
 Selftimer Vol.	Adjusts the volume of the self-timer sound played 2 sec. before the shutter is released.	p. 64
 Shutter Volume	Adjusts the volume of the sound played when the shutter releases. The shutter sound does not play when a movie is recording.	p. 41
 Playback Vol.	Adjusts the volume of movie sounds and sound memos.	p. 93 p. 98
 LCD Brightness	Adjusts the LCD brightness of the LCD monitor. • -7 to 0* to +7 Use the  or  button to adjust the brightness. If you press the  or  button, the display returns to the Set up menu. You can check the brightness in the LCD monitor while you are adjusting the setting.	-
 Power Saving	Sets the [Auto Power Down] and [Display Off] options.	
 Auto Power Down	Sets whether or not the camera automatically powers down after a set period of time elapses without something being pressed. • On* • Off	p. 31
 Display Off	Sets the length of time before the LCD monitor goes off when no camera operation is performed. • 10 sec. • 20 sec. • 30 sec. • 1 min.* • 2 min. • 3 min.	

Menu Item	Options	Reference Page
 Date/Time	Sets the date and time and the date format.	p. 26
 Format	Formats (initializes) CF cards.	p. 107
 File No. Reset	Sets how file numbers are assigned to images when new CF cards are inserted. • On • Off*	p. 87
 Auto Rotate	Sets whether or not images shot with the camera held vertically are automatically rotated in the display. • On* • Off	p. 86
 Language	Sets the language used in menus and messages on the LCD monitor. • English* • Italiano • Deutsch • Norsk • Français • Svenska • Nederlands • Español • Dansk • Chinese • Suomi • Japanese You can also change the language in playback mode by holding the SET button and pressing the MENU button.	p. 28
 Video System	Sets the video output signal standard. • NTSC • PAL	p. 127

My Camera Menu

You can select the theme, start-up image and sound, shutter sound, operation sound and selftimer sound used on this camera.

These are called the My Camera settings. You can also customize the **[P2]** and **[P3]** options for each item with images recorded on the CF card and newly recorded sounds or by using the supplied software.

See the *Software Starter Guide* for details.







Menu Item	Available Settings	Reference Page
[P1] Theme	Selects a common theme for each My Camera settings item.	p. 129
[P2] Start-up Image	Sets the image displayed when the camera power is turned on.	
[P3] Start-up Sound	Sets the sound emitted when the camera power is turned on.	
[P4] Operation Sound	Sets the sound emitted when any button other than the shutter button is pressed.	
[P5] Selftimer Sound	Sets the sound emitted 2 seconds before the shutter releases in self-timer mode.	
[P6] Shutter Sound	Sets the sound emitted when the shutter button is pressed. There is no shutter sound for movies.	
My Camera Menu Contents	[P7] (Off) / [1] * / [P2] / [P3]	

• How the [Mute] option in the **[1]** (Set up) Menu and Sounds in the **[P6]** (My Camera) Menu Interact

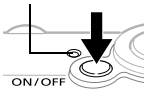
To turn off each sound, such as the start-up sound, shutter sound, operation sound and selftimer sound, [Mute] must first be set to [On] in the **[1]** (Set up) menu. When [Mute] is set to [On], each sound option will not sound even if they are set individually to [On]. The warning sound, however, will emit even when [Mute] is set to [On].

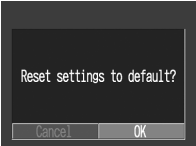
Resetting Settings to Their Default Values

You can reset the menu and button settings to the default settings in one operation.

 <p>Power Lamp</p>	1 Press the ON/ OFF button until the power lamp lights green. Set the mode switch to any position.
<p>MENU</p> 	2 Press and hold the MENU button for more than 5 seconds.
  <p>SET</p> 	3 Use the  or  button to select [OK] and press the SET button. To exit without resetting, select [Cancel].



- Settings cannot be reset when the camera is connected to a computer or to a separately sold printer.
- The following cannot be reset.
 - The [Date/Time], [Language] and [Video System] options in the  (Set up) menu (p. 50)
 - White balance data recorded with the custom white balance function (p. 82).
 - Newly added My Camera settings (p. 131)

📷 Shooting in Auto Mode



In this mode, all you have to do is press the shutter button and let the camera do everything else.

	<p>1 Slide the mode switch to and turn the mode dial to .</p>
	<p>2 Aim the camera at the subject.</p>
	<p>3 Use the zoom lever to achieve the desired composition (relative subject size in the viewfinder) (p. 40).</p>
	<p>4 Press the shutter button halfway (p. 41).</p> <ul style="list-style-type: none"> • Two beeps will sound when the camera has finished metering, and the upper indicator beside the viewfinder will light green or orange. If the LCD monitor is on, the AF frame will appear green. • If the subject is difficult to focus on, the lower indicator beside the viewfinder will blink yellow and the beep will sound one time.
	<p>5 Press the shutter button fully (p. 42).</p> <ul style="list-style-type: none"> • You will hear the sound of the shutter when the shutter activates. • The picture appears for two seconds on the LCD monitor.



- See *Functions Available in Each Shooting Mode* (p. 160).
- With the Review function, you can change the length of time images show on the LCD monitor after shooting, or set it so they do not show at all (p. 54).

Reviewing an Image Right after Shooting



Right after a shot is taken, the image appears in the LCD monitor for 2 seconds. In addition, the images will keep on displaying regardless of the review duration setting if one of the following operations is performed.

- **Keeping the shutter button pressed after a shot.**
 - **Pressing the SET button while the image is displayed on the LCD monitor.**
- Press the shutter button halfway to stop displaying it so that you can shoot the next frame.





- You can do the following while the image is displayed.
 - Display the image's detailed information (p. 34).
 - Erase the image (p. 105).
 - Magnify the image in the display (When pressing the SET button while the image is displayed) (p. 90).

Changing the Review Duration

The default review time is 2 seconds. The review function can be set to [Off] or changed to any time in the range of 2 to 10 seconds in one-second increments.





1 In the  (Rec.) menu, select .

See *Selecting Menus and Settings* (p. 43).



MENU



2 Use the  or  button to select review setting and press the MENU button.

- With the [Off] option, the image will not automatically display.
- In the [2 sec.] to [10 sec.] range, the image will continue to display for the specified time even if the shutter button is released.
- Holding the shutter button down after a shot holds the image in the display regardless of the setting.

Changing Resolution/Compression Settings

You can change the resolution and compression (excluding movies) settings to suit the purpose of the image you are about to shoot.



PowerShot S500 DIGITAL ELPH/DIGITAL IXUS 500

Resolution		Purpose
L (Large)	2592 x 1944 pixels	 <ul style="list-style-type: none"> • Print larger than A4 size* 210 x 297 mm (8.3 x 11.7 in.) prints • Print larger than Letter size* 216 x 279 mm (8.5 x 11 in.) prints • Print up to A4 size* 210 x 297 mm (8.3 x 11.7 in.) prints • Print up to Letter size* 216 x 279 mm (8.5 x 11 in.) prints • Print postcard size 148 x 100 mm (6 x 4 in.) prints • Print L-size 119 x 89 mm (4.7 x 3.5 in.) prints • Send images as e-mail attachments • Shoot more images
M1 (Medium 1)	2048 x 1536 pixels	
M2 (Medium 2)	1600 x 1200 pixels	
S (Small)	640 x 480 pixels	



PowerShot S410 DIGITAL ELPH/DIGITAL IXUS 430

Resolution		Purpose
L (Large)	2272 x 1704 pixels	 <ul style="list-style-type: none"> • Print larger than A4 size* 210 x 297 mm (8.3 x 11.7 in.) prints • Print larger than Letter size* 216 x 279 mm (8.5 x 11 in.) prints • Print postcard size 148 x 100 mm (6 x 4 in.) prints • Print L-size 119 x 89 mm (4.7 x 3.5 in.) prints • Print card size 86 x 54 mm (3.4 x 2.1 in.) prints • Send images as e-mail attachments • Shoot more images
M1 (Medium 1)	1600 x 1200 pixels	
M2 (Medium 2)	1024 x 768 pixels	
S (Small)	640 x 480 pixels	

* Paper sizes vary according to region.

Compression		Purpose
	Superfine	<ul style="list-style-type: none"> • Shoot higher quality images • Shoot normal quality images • Shoot more images
	Fine	
	Normal	

Movies can be shot with the following resolution.

Resolution	
	640 x 480 pixels (Not featured on the PowerShot S410 DIGITAL ELPH/DIGITAL IXUS 430)
	320 x 240 pixels
	160 x 120 pixels

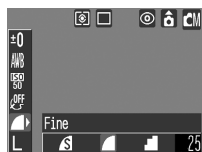



1 In the **FUNC.** menu, select  * or  *.

See *Selecting Menus and Settings* (p. 43).

* The current setting is displayed.



2 Use the  or  button to select an option.

Compression (Excluding Movies)

Select ,  or .

Resolution (Still Images)

Select , ,  or .

Resolution (Movies)

Select  *,  or .

You can shoot right after selecting an option. The menu displays again after the shot, allowing you to change the settings easily.

*  is not available with the PowerShot S410 DIGITAL ELPH/DIGITAL IXUS 430.

FUNC.



3 Press the FUNC. button.

The display will return to the Shooting screen.



- See *Image File Sizes (Estimated)* (p. 150).
- See *CF Cards and Estimated Capacities* (p. 148).

Quick Shots



You can reduce shutter lag time to capture those fleeting “photo opportunities”.



- You cannot select the quick shot method for use with the viewfinder (LCD monitor must be on).
- The LCD monitor display freezes while the camera is autofocusing.

DISP.



1 Press the DISP. button to turn the LCD monitor on.

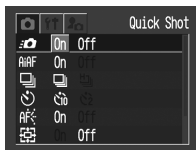

2 In the (Rec.) menu, select .

See *Selecting Menus and Settings* (p. 43).



MENU

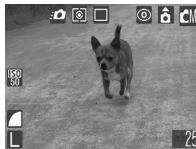

3 Use the or button to select [On] and press the MENU button.

- The display will return to the Shooting screen.
- The  icon will display on the LCD monitor (detailed display on) when the “Quick Shot” option is set to On.

⚡ Using the Flash



Use the flash according to the guidelines below.

	Auto	The flash fires automatically as required by the light level.
	Auto with Red-eye Reduction	The flash fires automatically as required by the lighting level, and the red-eye reduction lamp fires each time the main flash fires.
	Flash On	The flash fires with every shot.
	Flash Off	The flash will not fire.
	Slow Synchro	The flash timing is adjusted to slow shutter speeds. This reduces the chance that the background will be dark when shots are taken at night or in rooms with artificial lighting. The red-eye reduction lamp fires with each shot. Use of a tripod is recommended.

	○	○	—
	○	○	—
	—	○	△
	○	○	△
	—	○	△

- Setting available
- △ Can be selected for the first image only.



1 Press the ⚡ button to switch between flash modes.

The selected flash mode appears on the LCD monitor.



- When you use flash photography at higher ISO speeds, the chances of white streaks appearing in the image increase the closer you approach to the subject.
- Since a slow shutter speed is selected in dark places when the flash is set to Off or Slow Synchro, take care to avoid blurring the image.
 - Shooting in Mode
Be careful to hold the camera still to avoid camera shake.
 - Shooting in Mode or Mode
Fix the camera to a tripod to shoot in these modes since the shutter speed will be slower than in the mode. If an image is dark in mode, reshooting it in mode will make it brighter.











- The flash can be fired when the indicator lights a steady orange after pressing the shutter button halfway.
- The flash may take up to approximately 10 seconds to charge. The recharging time will vary with such factors as the shooting conditions and battery charge. Shots cannot be taken while the flash is charging.
- The flash fires twice. The main flash follows a preparatory pre-flash. The exposure reading obtained from the subject with the pre-flash is used to set the optimal flash intensity for the main flash, which is used to capture the image.
- When using the flash, be sure to shoot from at least 46 cm (1.5 ft.) away from your subject for standard photography and at least 30 cm (1.0 ft.) for macro photography.

Red-eye Reduction

- Light reflecting back from eyes can make them appear red when the flash is used in dark areas. Under these conditions, use the red-eye reduction mode. For this mode to be effective, the subject must be looking right at the red-eye reduction lamp. Try asking them to look directly at the lamp. Even better results can be obtained by increasing the lighting in indoor settings or approaching closer to the subject.
- The shutter will not activate for approximately 1 second after the red-eye reduction lamp fires in order to improve the effect (excluding when using the quick shot function). If you want a more immediate shutter response, set the flash to , or .

🌸 Shooting Close-Ups/▲ Infinity Shots

	Macro	Use this mode to record subjects in the range of 5 to 46 cm (2.0 in. to 1.5 ft.) from the lens tip when at wide-angle end and in the range of 30 to 46 cm (1.0 ft. to 1.5 ft.) when at the telephoto end setting.
	Infinity	Use this mode to record landscapes and distant objects. It can also be used for compositions combining both near and distant objects.

				
	○	○	△	○
	—	○	△	○



○ Setting available
 △ Can be selected for the first image only.



1 Press the 🌸 / ▲ button to select the macro/infinity mode.

The selected macro/infinity mode appears on the LCD monitor.

To cancel the macro/infinity mode

Press the 🌸 / ▲ button to remove  or  from the display.



- Use the LCD monitor to compose close-ups in macro mode since images composed with the viewfinder may be off-center (p. 39).
- The exposure may not be optimal when the flash is used in macro mode in the range of 5 to 30 cm (2.0 in. to 1.0 ft.).



Image Area in Macro Mode

When the zoom is set between the telephoto end and the wide-angle end, the distance from lens to subject is the same as when the zoom is set to the telephoto end.

	Distance from Lens to Subject	Image Area
Telephoto End	30 cm (1.0 ft.)	107 x 80 mm (4.2 x 3.1 in.)
Wide-Angle End	5 cm (2.0 in.)	58 x 43 mm (2.3 x 1.7 in.)

Using the Digital Zoom



When the LCD monitor is on, images can be zoomed to the following powers with the combined optical and digital zoom functions.

PowerShot S500 DIGITAL ELPH/DIGITAL IXUS 500: Approx. 3.8x, 4.9x, 6.1x, 7.6x, 9.3x, 12.0x

PowerShot S410 DIGITAL ELPH/DIGITAL IXUS 430: Approx. 4.3x, 5.3x, 6.7x, 8.2x, 11.0x

DISP.



1 Press the DISP. button to turn the LCD monitor on.



2 In the [Rec.] menu, select [Digital Zoom].
See *Selecting Menus and Settings* (p. 43).



3 Use the [Left] or [Right] button to select [On] and press the MENU button.

The display will return to the Rec. screen.



4 Press the zoom lever toward [Zoom In].

- The combined optical and digital zoom factor appears in the upper right of the LCD monitor.
- When you press the zoom lever toward [Zoom In], the zoom stops when the lens reaches the maximum optical telephoto setting. Press the zoom lever toward [Zoom In] again to activate the digital zoom and further zoom the image digitally.
- Press the zoom lever toward [Zoom Out] to zoom out.



The digital zoom cannot be used when the LCD monitor is turned off.



Images become coarser the more they are digitally zoomed.

Continuous Shooting



In this mode, the camera shoots continuously while the shutter button is held down. Recording ceases when the shutter button is released.

	Standard Continuous Shooting	Use this mode to view images on the LCD monitor as you shoot continuously. The shutter interval is longer in this mode than in mode.
	High-Speed Continuous Shooting	Use this mode to shoot continuously with a short shutter interval. You cannot check images while shooting continuously.

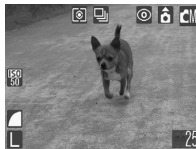

1 Press the / button to display or .

- The continuous shooting function shoots at the following rates.*

Approximately 1.5 frames/sec.

PowerShot S500 DIGITAL ELPH/DIGITAL IXUS 500:

Approximately 2.2 frames/sec.

PowerShot S410 DIGITAL ELPH/DIGITAL IXUS 430:

Approximately 2.5 frames/sec.

* Large/Fine, LCD monitor off mode. (These figures reflect Canon's testing standard. The actual figures will vary according to the shooting conditions and settings.)

To cancel continuous shooting

Press the / button twice to display .

To change the continuous shooting speed

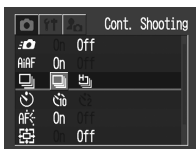

- 1 In the (Rec.) menu, select .
See *Selecting Menus and Settings* (p. 43).



- 2 Use the or button to select or and press the MENU button.
The display will return to the Shooting screen.



- The interval between shots may lengthen slightly when the camera's built-in memory fills.
- If the flash is firing, the interval between shots will lengthen to accommodate the flash's charging requirements.

Using the Self-timer



With this function, images are shot 10 or 2 seconds after the shutter button is pressed. This is useful when you want to take a memorable photo with everyone including yourself in the picture. The self-timer can be used in any shooting mode.



- 1 Press the / button to display or .
 - When the shutter button is pressed fully, the self-timer will activate and the self-timer lamp will blink.
 - When the self-timer is set to (), the shutter activates 10 (2) seconds after the shutter button is pressed fully.

To cancel the self-timer

Press the / button to display .

Changing the Self-timer Countdown Time



1 In the (Rec.) menu, select .



See *Selecting Menus and Settings* (p. 43).



MENU



2 Use the or button to select or and press the MENU button.

- The display will return to the Shooting screen.
- When  is selected, the self-timer sounds and the blinking gets faster 2 seconds before the shutter activates.
- When  is selected, the self-timer sounds at the same time as the shutter button is pressed. The shutter activates in 2 seconds.



The self-timer sound can be changed with the Selftimer Sound item in the  (My Camera) menu (p. 51).

Shooting in Manual Mode



In this mode, you can change various settings and shoot as you wish.



1 Slide the mode switch to  (Rec.) and turn the mode dial to .

2 Change the settings.

See *Functions Available in Each Shooting Mode* (p. 160).



3 Shoot (p. 53).

If the subject is difficult to focus on when the shutter button is pressed halfway, the beep will sound one time and the lower indicator beside the viewfinder will blink yellow.

The AF frame will also appear yellow. (If the AiAF option is set to [On] (p. 76), the AF frame will not appear.)

Shooting Panoramic Images (Stitch Assist)

Stitch Assist can be used to shoot overlapping images that can later be merged (stitched) to create one panoramic image on a computer.

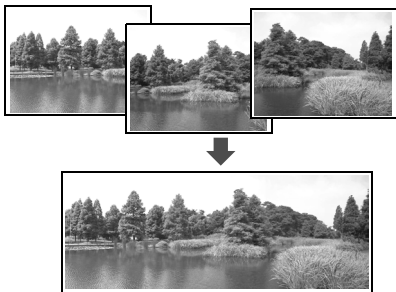

The overlapping seams of several adjacent images can be joined into a single panoramic image.



To merge the images on a computer, use PhotoStitch, one of the supplied programs.

Framing a Subject

The PhotoStitch program detects the overlapping portions of adjoining images and merges them. When shooting, try to include a distinctive item (landmark) in the overlapping portions.









- Compose each frame so that it overlaps 30 - 50% of the adjoining image. Try to keep the vertical misalignment to less than 10% of the image height.
- Do not include moving items in the overlap.
- Do not try to stitch images that include both distant and close items. These items may appear warped or doubled up in the merged image.
- Make the brightness in each image consistent. The final image will appear unnatural if the contrast in brightness is too great.
- To shoot landscapes, swivel (pan) the camera around its own vertical axis.

- To shoot close-ups, slide the camera over the subject, keeping it parallel to the subject as you move it.

Shooting

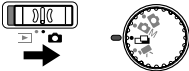

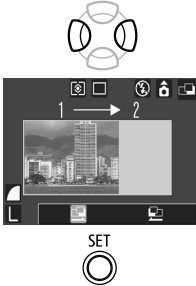
Images can be shot in two sequences in Stitch Assist.

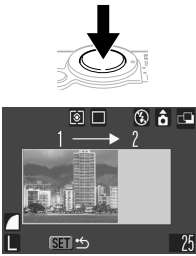
	Left to right horizontally
	Right to left horizontally

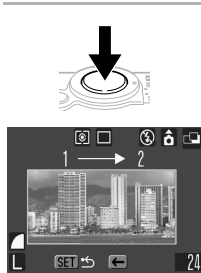
	<p>1 Slide the mode switch to  (Rec.) and turn the mode dial to .</p>
	<p>2 Use the  or  button to select the sequence direction and press the SET button.</p>
	<p>3 Shoot the first frame in the sequence.</p> <p>The exposure and white balance are set and locked with the first image.</p>



4 Compose the second image so that it overlaps a portion of the first and shoot.

- Use the  or  button to check or retake the recorded images.
- Minor discrepancies in the overlapping portions can be corrected when the images are stitched together.

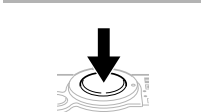

5 Repeat the procedure for additional images.

A sequence may contain up to 26 images.



6 Press the SET button after the last shot.



- A custom white balance setting cannot be set in [Stitch Assist] mode. To use a custom white balance setting, first set it in another shooting mode (p. 82).
- The settings for the first image are used to take subsequent images in the sequence.
- It is not possible to display images on the TV when shooting in Stitch Assist.



See *Functions Available in Each Shooting Mode* (p. 160).



	PowerShot S500 DIGITAL ELPH DIGITAL IXUS 500	PowerShot S410 DIGITAL ELPH DIGITAL IXUS 430
640	640 x 480 pixels	—
320	320 x 240 pixels	
160	160 x 120 pixels	

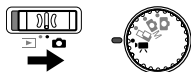

1 Slide the mode switch to (Rec.) and turn the mode dial to .

The LCD monitor turns on and displays the maximum recording time (in seconds).



2 Press the shutter button fully.

- Shooting and sound recording starts simultaneously.
- During shooting the recording time (in seconds) and a red circle appear on the LCD monitor.



3 Press the shutter button fully again to stop recording.

- The maximum length of a movie clip (10 frames/sec. at **640**, 15 frames/sec. at **320**, **160**) is approximately 30 sec. at **640**, 3 min. at **320**, 3 min. at **160** (according to Canon's standardized tests).
- Recording time vary by the CF card. See *CF Cards and Estimated Capacities* (p. 148).
- The maximum length of movies may vary with the subject and shooting conditions. Recording will automatically stop when the maximum is reached or when the CF card runs out of free capacity.



- The recording time may not display properly during shooting or filming may stop unexpectedly with the following types of CF cards.
 - Slow recording cards
 - Cards formatted on a different camera or a computer
 - Cards which have had images recorded and erased repeatedlyAlthough the recording time may not display properly during shooting, the movie will be recorded correctly on the CF card. Recording time will display properly if you format the CF card in this camera (excluding slow recording CF cards).
- You are recommended to use a CF card that has been formatted in your camera to shoot movies (p. 107). The card supplied with the camera may be used without further formatting.
- Be careful not to touch the microphone while recording.
- The AE, AF, white balance and zoom settings remain fixed for subsequent frames at the values selected for the first frame.
- After a clip is shot, the upper indicator beside the viewfinder will blink green while the clip is being written to the CF card. You cannot shoot again until the blinking stops.





- See *Functions Available in Each Shooting Mode* (p. 160).
- Sound is recorded monaurally.
- There is no shutter sound in movie mode.
- QuickTime 3.0 or later is required to play back movie files (AVI/ Motion JPEG) on a computer. QuickTime (for Windows) is included on the Canon Digital Camera Solution Disk. On the Macintosh platform, this program is generally bundled with Mac OS 8.5 or later operating systems.

Shooting Hard-to-Focus Subjects (Focus Lock, AF Lock)

It may be difficult to focus on the following types of subjects. Use the focus lock or AF lock in these situations.

- Subjects with extremely low contrast to the surroundings
- Subjects with extremely bright objects at the center of the composition
- Subjects that are moving quickly
- Subjects through glass:
Try to shoot as close to the glass as possible to reduce the chances of light reflecting back off the glass.
- Subjects with horizontal stripes

Shooting with the Focus Lock

	1 Aim the camera so that an object at the same focal distance as the main subject is centered in the viewfinder or in the AF frame displayed on the LCD monitor.
	2 Press the shutter button halfway (two beeps will sound). The focal distance to the object is locked.
	3 Re-aim the camera to compose the shot as desired and press the shutter button fully.

Shooting with the AF Lock

	1 Press the DISP. button to turn the LCD monitor on.
	2 Aim the camera so that an object at the same focal distance as the main subject is centered in the AF frame.

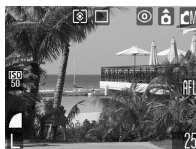

3 Press the shutter button halfway (two beeps will sound) and press the / button.

- The focal distance to the object is locked.
- The **AF-L** icon will display and the lower indicator beside the viewfinder will light yellow.



4 Re-aim the camera to compose the shot as desired and shoot.

To release the focus lock

Press the  /  button.



- The focus lock can be set in any shooting mode.
- When shooting with the focus lock or AF lock using the LCD monitor, setting the AiAF to Off (p. 76) is recommended since the camera focuses using the center AF frame only.
- The AF lock is convenient because you can let go of the shutter button to compose the image. Moreover, the AF lock is still effective after the picture is taken, allowing you to capture a second image with the same focus.
- The AF lock can be released by pressing the zoom lever, **MENU** button, or by changing the shooting mode or by turning the LCD monitor off.

Locking the Exposure Setting (AE Lock)



You can set the exposure and focus separately. This is effective when the contrast is too strong between the subject and background or when a subject is backlit.



You must set the flash to . The AE lock cannot be set if the flash fires.

DISP.



1 Press the **DISP.** button to turn the LCD monitor on.

2 Focus on the part of the subject on which you wish to lock the exposure setting.

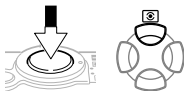

3 Press the shutter button halfway (two beeps will sound) and press the button.

- The exposure setting is locked.
- The **AEL** icon will display.



4 Re-aim the camera to compose the shot as desired and press the shutter button fully.



To release the AE lock

Press the button.









The AE lock may be released by pressing the zoom lever, **MENU** button or button, or by changing the white balance, ISO speed, photo effect or the shooting mode, or by turning the LCD monitor off.

Locking the Flash Exposure Setting (FE Lock)



You can lock the flash exposure so that the exposure settings are correctly set for a particular portion of your subject.

	1 Press the DISP. button to turn the LCD monitor on.
 	2 Press the ⚡ button to set the flash to ⚡ .
	3 Focus on the part of the subject on which you wish to lock the flash exposure setting.
  	4 Press the shutter button halfway (two beeps will sound) and press the AE-L/AF-L button. <ul style="list-style-type: none">• The flash will fire a pre-flash and lock the flash exposure to the required intensity to illuminate the subject.• The FEL icon will display.
	5 Re-aim the camera to compose the shot as desired and press the shutter button fully.

To release the FE lock

Press the **AE-L/AF-L** button.



The FE lock may be released by pressing the zoom lever, **MENU** button or button, or by changing the white balance, ISO speed, photo effect or the shooting mode, or by turning the LCD monitor off.

Switching between Focusing Modes



Although the autofocus function is preset to the AiAF setting (9 AF frames), you can set it to the center AF frame.

When [AiAF] is set to [On], the AF frame does not appear. When [AiAF] is set to [Off], however, the AF frame will appear.

No frame	On	The camera detects the subject and highlights the AF frames, from 9 available points, that it will use to determine the focus.
<input type="checkbox"/>	Off	The camera focuses using the center AF frame. This is convenient for focusing on a specific part of a subject with greater certainty.

The symbol represents the AF frames as they appear in the LCD monitor.



1 In the (Rec.) menu, select **AiAF**.

See *Selecting Menus and Settings* (p. 43).



2 Use the or button to select **[On]** or **[Off]**.

You can shoot right after selecting an option.



3 Press the **MENU** button.



The display will return to the Shooting screen.



The focus is locked to the center AF frame when the digital zoom is used.

Switching between Light Metering Modes

You can switch between metering modes to shoot.

	Evaluative	Appropriate for standard shooting conditions, including backlit scenes. The camera divides images into several zones for light metering. It evaluates complex lighting conditions, such as the position of the subject, the brightness, the direct light, and the backlighting, and adjusts the settings to the correct exposure for the main subject.
	Center-Weighted Average	Averages the light metered from the entire frame, but gives greater weight to the subject matter at the center.
	Spot	Meters the area within the spot AE point at the center of the LCD monitor. Use this setting when you want to set the exposure on the subject in the center of the monitor.



1 Press the button to switch between metering modes.

The selected metering mode appears on the LCD monitor.

Adjusting the Exposure Compensation



Adjust the exposure compensation setting to avoid making the subject too dark when it is backlit or shot against a bright background or to avoid making lights appear too bright in night shots.

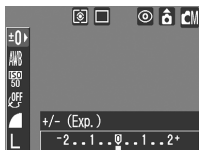

1 In the FUNC. menu, select *.

See *Selecting Menus and Settings* (p. 43).

* The current setting is displayed.



2 Use the or button to adjust the exposure compensation.

- The settings can be adjusted in 1/3 stops in the range -2 to +2.
- You can confirm the effect of the setting in the LCD monitor when it is on.
- You can shoot right after selecting an option. The menu displays again after the shot, allowing you to change the settings easily.



3 Press the FUNC. button.

The display will return to the Shooting screen.

To reset the exposure compensation



Return the setting to 0.

Shooting in Long Shutter Mode



You can set the shutter speed to a slow setting to make dark subjects appear brighter.



1 In the  (Rec.) menu, select .

See *Selecting Menus and Settings* (p. 43).



MENU



2 Use the  or  button to select [On] and press the MENU button.

The display will return to the Shooting screen.



SET





3 In the FUNC. menu, select * and press the SET button.

See *Selecting Menus and Settings* (p. 43).

* The current setting is displayed.



4 Use the  or  button to select a shutter speed.

- The higher the value, the brighter the image and the lower the value, the darker the image.
- You can shoot right after selecting a value. The menu displays again after the shot, allowing you to change the settings easily.



FUNC.



5 Press the FUNC. button.

The display will return to the Shooting screen.



To cancel the long shutter mode

While [Long Shutter] is displayed in the FUNC. menu, press the **SET** button.



The nature of CCD image sensors is such that noise in the recorded image increases at long shutter speeds. This camera, however, applies special processing to images shot at shutter speeds slower than 1.3 seconds to eliminate the noise, thereby producing high-quality images. Nevertheless, a certain amount of processing time may be required before the next image can be shot.



- Use the LCD monitor to confirm that the image was recorded at the desired brightness.
- Please note that camera shake becomes a factor at low shutter speeds. If the camera shake warning  appears on the LCD monitor, secure the camera to a tripod before shooting.
- Use of the flash may result in an over-exposed image. If that occurs, shoot with the flash set to .
- The following are unavailable:
 - Exposure Compensation
 - Light Metering
 - AE Lock
 - FE Lock
 - ISO speed [AUTO]
 - Flash [Auto][Red-eye Reduction Auto]

Available Shutter Speeds

The following shutter speeds (in seconds) are available.

15 13 10 8 6 5 4 3.2 2.5 2 1.6 1.3 1

Adjusting the Tone (White Balance)



When the white balance mode is set to match the light source, the camera reproduces colors more accurately.

	Auto	The camera sets the white balance automatically according to shooting conditions.
	Daylight	For recording outdoors on a bright day.
	Cloudy	For recording under overcast, shady or twilight skies.
	Tungsten	For recording under tungsten and bulb-type 3-wavelength fluorescent lighting.
	Fluorescent	For recording under warm-white, cool-white or warm-white (3-wavelength) fluorescent lighting.
	Fluorescent H	For recording under daylight fluorescent, or daylight fluorescent-type 3-wavelength fluorescent lighting.
	Custom	For setting a custom value with a white sheet of paper, etc., to obtain the optimal white balance for the conditions.

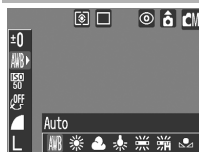

1 In the FUNC. menu, select **AWB** *.

See *Selecting Menus and Settings* (p. 43).

* The current setting is displayed.



2 Use the or button to select an option.

- See *Setting a Custom White Balance* (p. 82).
- You can confirm the effect of the setting in the LCD monitor when it is on.
- You can shoot right after selecting an option. The menu displays again after the shot, allowing you to change the settings easily.

FUNC.



3 Press the FUNC. button.

The display will return to the Shooting screen.



This setting cannot be adjusted when the **S** (Sepia) or **BW** (B/W) photo effects are selected.

Setting a Custom White Balance

You can set a custom white balance to obtain the optimal setting for the shooting conditions by having the camera evaluate an object, such as a piece of white paper or cloth, or a photo-quality gray card that you wish to establish as the standard white color.

Especially in the following cases, as the white balance may not be adjusted in **AWB** (Auto), shoot after reading the white balance data in  (Custom).

- Shooting close-ups
- Shooting subjects of monotone color (such as sky, sea or forest)
- Shooting with a peculiar source of light (such as a mercury-vapor lamp)

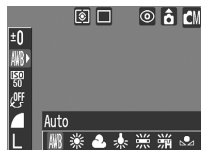

1 In the FUNC. menu, select **AWB** *.

See *Selecting Menus and Settings* (p. 43).

* The current setting is displayed.



2 Use the or button to select .





3 Aim the camera at the white paper, cloth or gray card and press the SET button.





- Aim the camera so that the white paper, cloth or gray card completely fills the frame on the LCD monitor or the entire viewfinder before pressing the **SET** button. The camera reads the white balance data when you press the **SET** button.
- You can shoot right after selecting an option. The menu displays again after the shot, allowing you to change the settings easily.



4 Press the FUNC. button.

The display will return to the Shooting screen.



- You are recommended to set the shooting mode to  and the exposure compensation setting to zero (± 0) before setting a custom white balance. The correct white balance may not be obtained when the exposure setting is incorrect (image appears completely black or white).
- Shoot with the same settings as when reading the white balance data. If the settings differ, the optimal white balance may not be set. Especially the following should not be changed.
 - Flash
Setting the flash to on or off is recommended. If the flash fires when reading the white balance data with the flash set to  or , make sure that you also use the flash when you shoot.
 - ISO Speed
- It is also advisable to use the LCD monitor to compose the shot and to zoom to the telephoto end setting. Also, the digital zoom should be set to [Off].
- Since the white balance data cannot be read in  (Stitch Assist mode), preset the white balance in another shooting mode.

Changing the Photo Effect



By setting a photo effect before you shoot, you can change the look and feel of the pictures you take.

	Photo Effect Off	Records with no effect.
	Vivid	Emphasizes the contrast and color saturation to record bold colors.
	Neutral	Tones down the contrast and color saturation to record neutral hues.
	Low Sharpening	Records subjects with softened outlines.
	Sepia	Records in sepia tones.
	B/W	Records in black and white.

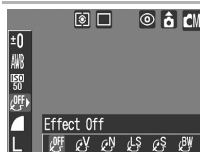

- 1 In the FUNC. menu, select *.**
See *Selecting Menus and Settings* (p. 43).
* The current setting is displayed.



- 2 Use the or button to select an effect.**
 - You can confirm the photo effect in the LCD monitor.
 - You can shoot right after selecting an option. The menu displays again after the shot, allowing you to change the settings easily.



- 3 Press the FUNC. button.**
The display will return to the Shooting screen.

Adjusting the ISO Speed



Raise the ISO speed when you wish to reduce camera shake or turn the flash off when shooting in a dark area, or use a fast shutter speed.

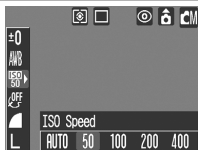

1 In the FUNC. menu, select *.

See *Selecting Menus and Settings* (p. 43).

* The current setting is displayed.



2 Use the or button to select a speed.

You can shoot right after selecting an option. The menu displays again after the shot, allowing you to change the settings easily.



3 Press the FUNC. button.

The display will return to the Shooting screen.



- Higher ISO speeds increase image noise. To take clean images, use as low an ISO speed as possible.
- The AUTO setting selects the optimal ISO speed. It will automatically raise the speed when the light from the flash is insufficient to illuminate the subject matter.

Setting the Auto Rotate Function



Your camera is equipped with an Intelligent Orientation sensor that detects the orientation of an image shot with the camera held vertically and automatically rotates it to the correct viewing orientation in the display. You can set this function on/off.



1 In the **ⓘ** (Set up) menu, select **📷**.

See *Selecting Menus and Settings* (p. 43).



MENU



2 Use the **⬅** or **➡** button to select **[On]** and press the **MENU** button.

- The display will return to the Shooting screen.
- When the Auto Rotate function is set to [On] and the LCD monitor is set to the detailed display mode, the **📷** icon (normal), **📷** icon (right end is down) or **📷** icon (left end is down) will appear in the upper right of the display.



- This function may not operate correctly when the camera is pointed straight up or down. Check that the arrow **📷** is pointing in the right direction and if it is not, then set the Auto Rotate function to [Off].
- Even if the Auto Rotate function is set to [On], the orientation of images downloaded to a computer will depend upon the software used to download the images.



- When the camera is held vertically to shoot, the Intelligent Orientation sensor judges the upper end to be “up” and the lower end to be “down.” It then regulates the optional white balance, exposure and focus for vertical photography. This function operates regardless of the On/Off status of the Auto Rotate function.
- When changing the camera’s orientation between the horizontal and vertical positions, you may hear noise coming from the orientation detection mechanism. This is not a malfunction.

Resetting the File Number



The images you shoot are automatically assigned a file number. You can set whether or not the file numbers of a new CF card consecutively follow the file numbers on the previous CF card.

On	The file number is reset to the start (100-0001) each time a new CF card is inserted. New images recorded on CF cards with existing files are assigned the next available number.
Off	The file number of the last image to be shot is memorized so that images recorded to a new CF card start from the next number.

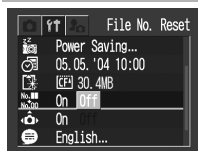

- 1** In the **ⓘ** (Set up) menu, select **No.##** **No:00**.
See *Selecting Menus and Settings* (p. 43).



- 2** Use the **⬅** or **➡** button to select **[On]** or **[Off]** and press the **MENU** button.

The display will return to the Shooting screen.



Setting the File No. Reset to [Off] is useful for avoiding file name duplication when images are downloaded to a computer.

About File Numbers and Folder Numbers

Images are assigned file numbers from 0001 to 9900, and folders are assigned folder numbers from 100 to 998 (Folder numbers cannot contain 99 in the last two digits).

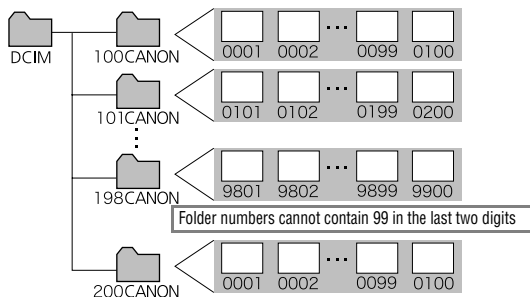

Folder File Capacity

Each folder usually contains up to 100 images.

However, since images shot in continuous shooting and stitch assist are always saved into the same folder, a folder may contain more than 100 images. The number of images may also exceed 100 if a folder contains images copied from a computer or images shot with other cameras. Please note, however, that the images in folders containing 2001 or more images cannot be played back in this camera.

Displaying Images Individually

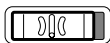



1 Slide the mode switch to (Playback).

The last recorded image will appear in the display (single image playback).



2 Use the or button to move between the images.

Use the  button to move to the previous image and the  button to move the next image.

Holding the button down advances the images more rapidly, but the images will not appear as clearly.



You may not be able to play back images that have been shot with another camera or edited on a computer with other software applications.



Approximate Location
of the Magnified Area

1 Press the zoom lever toward 🔍.

- Images can be magnified up to approximately 10 times in single image playback.
- Hold the **SET** button down and press the zoom lever toward 🔍 to cycle through each setting, from approximately 2.5 times, to approximately 5 and 10 times.
- Hold the **SET** button down and press the zoom lever toward 🗪 to cycle back through the levels of magnification from approximately 5 times, to 2.5 times and the standard view.



2 Use the 🗪, ⬅️, ➡️, or 🔍 button to move around the image.

To cancel the magnified display

Press the zoom lever toward 🗪.



Movie frames and index playback images cannot be magnified.

Viewing Images in Sets of Nine (Index Playback)

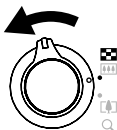

Selected Image



Movie

1 Press the zoom lever toward .

Up to nine images can be viewed at once in index playback.



2 Use the , , or button to change the image selection.

To return to single image playback

Press the zoom lever toward .

Switching between Sets of Nine Images

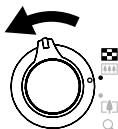





Jump Bar

- 1 Press the zoom lever toward  while in index playback.**

The jump bar will display.



- 2 Use the  or  button to move to the previous set or the next set.**

Hold the **SET** button down and press the  or  button to jump to the first or last set.

To return to index playback

Press the zoom lever toward .

Viewing Movies



You can playback movie clips shot in mode.



Movies cannot be played in the index playback mode.



1 Use the or button to select a movie.

Images with a **SET** icon are movies.



Movie Control Panel

Volume Level

2 Press the SET button.

- The movie control panel will display.
- Use the or button to adjust the sound volume.



3 Use the or button to select (Play) and press the SET button.

- The movie and sound will play.
- When playback ends, the movie stops at the last frame displayed. Press the **SET** button to display the movie control panel. Press the **SET** button again to play from the beginning.

Pausing and Resuming Play



Press the SET button during playback.

The movie playback pauses. Press it again to resume.



Operating the movie control panel

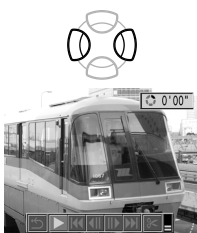

1 Select a movie and press the SET button (p. 93).

The movie control panel will display.





2 Use the  or  button to select one of the following and press the SET button.

: Exit (Ends playback and returns to single image playback. Pressing the **Menu** button also returns to single image playback.)

: Play

: First Frame

: Previous Frame (Rewinds if the **SET** button is held down)

: Next Frame (Fast Forwards if the **SET** button is held down)

: Last Frame

: Edit (Switches to movie editing mode) (p. 95)



- You may experience frame dropping and audio breakup when playing back a movie on a computer with insufficient system resources.
- Movies shot with other cameras may not play back on this camera. See *List of Messages* (p. 134).



- You can adjust the playback volume of movie clips in the  (Set up) menu.
- Use the television's controls to adjust the volume when playing a movie on a TV set (p. 127).

Editing Movies





Selecting  (Edit) in the movie control panel enables you to cut unwanted portions at the start or end of a movie clip.



Protected movies and movies less than 1 second in duration cannot be edited.



1 Use the  or  button to select a movie and press the SET button.

Movie Editing Panel









Movie Editing Bar

2 Switch to the movie editing mode.

- See *Operating the movie control panel* (p. 94).
- The movie editing panel and the movie editing bar will display.



3 Use the  or  button to select  or  and the  or  button to set the portion to which the cut is applied.

 : Cut Beginning

 : Cut End

 : Cursor



SET



4 Use the or button to select (Play) and press the SET button.

- A preview of the temporarily edited movie clip plays.
- To stop it, press the SET button again.



SET



5 Use the or button to select (Save) and press the SET button.

Selecting  (Exit) cancels the edits and returns to the movie control panel display.



SET



6 Use the or button to select [New File] or [Overwrite] and press the SET button.

- [New File] saves the edited movie under a new file name. The pre-edit data is left unchanged.
- [Overwrite] saves the edited movie with its original file name. The pre-edit data is lost.
- When the CF card lacks sufficient space to create a new file, only [Overwrite] can be selected.



- The minimum duration of an edited movie is 1 second.
- It may take approximately 3 minutes to save an edited movie. If the battery pack runs out of charge partway through, edited movie clips cannot be saved. When editing movies, use a fully charged battery pack or the separately sold AC Adapter Kit ACK500 (p. 140).

Rotating Images in the Display



Images can be rotated clockwise 90° or 270° in the display.



0° (Original)



90°





270°



1 In the  (Play) menu, select  and press the **SET** button.

See *Selecting Menus and Settings* (p. 43).

2 Use the  or  button to select the image to be rotated and press the **SET** button.

Cycle through the 90°/270°/0° orientations with each press of the **SET** button.

3 Press the **MENU** button.

The display will return to the Play menu. Pressing the **MENU** button again returns to the Playback screen.



- Movies cannot be rotated.
- When images are downloaded to a computer, the orientation of images rotated by the camera will depend upon the software used to download the images.



- Images can be magnified when rotated (p. 90).
- Images taken vertically with Auto Image Rotate (p. 86) set to [On] will automatically be rotated to the vertical position when viewed on the camera's LCD monitor.

Attaching Sound Memos to Images



In playback mode (including single image playback, index playback, and magnifying playback), you can attach sound memos (up to 60 seconds) to an image. The sound data is saved in WAVE format.

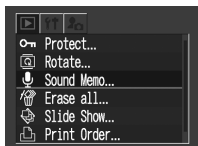

1 In the (Play) menu, select and press the **SET** button.

See *Selecting Menus and Settings* (p. 43).



2 Use the or button to select an image and press the **SET** button.

The sound memo control panel will display.



Sound Memo Panel



3 Use the or button to select (**Record**) and press the **SET** button.

- The recording starts and the elapsed time is displayed. Speak towards the microphone of the camera.
- Press the **SET** button again to stop recording. To resume recording, press the **SET** button again.
- Up to 60 seconds of recordings may be added to any one image.
- To return to the previous screen, select (Exit) and press the **SET** button.

Exiting the Sound Memos

Press the **MENU** button.

Playing/Erasing Sound Memos



SET



1 Display an image with a sound memo attached (p. 98) and press the SET button.

- Images with sound memos attached have the symbols displayed on them.
- The sound memo control panel will display.



Sound Memo Panel

SET



2 Use the or button to select (Play) or (Erase) and press the SET button.

(Play)

- The sound memo will play. Playback will stop when you press the **SET** button. Press the **SET** button again to resume playback.
- Use the or button to adjust the sound volume.

(Erase)

A confirmation menu will display. Use the or button to select [Erase] and press the **SET** button.

To return the playback to the beginning, select (Pause) while stopped and press the **SET** button.



- You cannot attach sound memos to movies.
- The “Memory card full” message will display when the CF card is full and you will be unable to record sound memos to that card.
- If an incompatible sound memo is attached to an image, you will be unable to record or play sound memos for that image, and the “Incompatible WAVE format” message will display. You can erase incompatible sound data using the camera.
- Sound memos for protected images cannot be erased.



The volume can be adjusted in the (Set up) menu (p. 48).

Automated Playback (Slide Shows)



Starting a Slide Show

A selection of images or all the images on a CF card can be displayed one-by-one in an automated slide show.

Slide show image settings are based on DPOF standards (p. 110).

All Images	Plays all images on the CF card in order.
Slide Show 1-3	Plays the images selected for each slide show in order (p. 101).

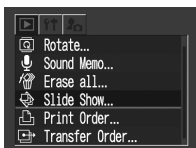

1 In the (Play) menu, select and press the SET button.

- See *Selecting Menus and Settings* (p. 43).
- The Slide Show menu will display.



2 Use the or button to select [Program] and the or button to select [All Images], [Show 1], [Show 2] or [Show 3].

See p.102 from step 3, for selecting the playback images in slide shows 1-3.



3 Use the or button to select [Start] and press the SET button.

The slide show starts. The Slide Show menu will reappear after the playback ends.



4 Press the MENU button.

The display will return to the Play menu. Pressing the **MENU** button again returns to the Playback screen.



- Movies play for their entire recorded length regardless of the time set in the slide show settings.
- The power-saving function does not activate during a slide show (p. 31).

Pausing/Resuming a Slide Show



Press the SET button.

The slide show pauses. Press the **SET** button again to restart it.

Fast Forwarding/Rewinding a Slide Show



Press the or button.

The previous or next image displays. Hold down the button to advance through the images more rapidly.

Stopping a Slide Show



Press the MENU button.

The slide show stops and the Slide Show menu reappears.

Selecting Images for Slide Shows

You can mark images for inclusion in slide shows 1-3. Up to 998 images may be marked per slide show. Images display in the order of their selection.

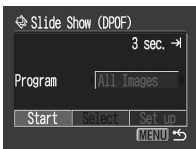

1 Display the Slide Show menu.

See *Starting a Slide Show* (p. 100).



2 Use the or button to select [Program] and the or button to select [Show 1], [Show 2] or [Show 3].









A white checkmark will appear beside a show already containing images.



3 Use the or button and the or button to choose [Select] and press the SET button.



4 Select images for the Slide Show

- Use the  or  button to move between images and the  or  button to select or deselect them. Selected images display a number corresponding to their selection order and a white checkmark .
- You can press the zoom lever toward  to switch to the index mode (3 images) and use the same procedures to select images.
- While in index playback, pressing the SET button displays the menu for selecting or deselecting all images. Use the  or  button to select [Select all] or [Clear all] and press the **SET** button.





5 Press the MENU button.

Press the **MENU** button repeatedly until the Playback screen reappears to finish the procedure.

Adjusting the Play Time and Repeat Settings

You can change the play time for all the images in a show and have the show repeat continuously.

	Play Time	Sets the duration that each image displays. Choose between 3-10 seconds, 15 seconds, 30 seconds and Manual.
	Repeat	Sets whether the slide show stops when all the slides have been displayed or continues until stopped.



1 Display the Slide Show menu.

See *Starting a Slide Show* (p. 100).

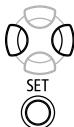

2 Use the or button to select [Set up] and press the SET button.



3 Use the or button to select or and the or button to select an option.

 (Play Time)

Select a play time.

 (Repeat)

Select [On] or [Off].



4 Press the MENU button.

The set up menu will close. Pressing the **MENU** button again returns to the Play menu. Press it again to go back to the Playback screen.



- The display interval may vary slightly from the set time for some images when played.
- Slide shows are easy to arrange on a computer with the supplied software (ZoomBrowser EX/ImageBrowser). See the *Software Starter Guide*.

Protecting Images



You can protect important images and movies from accidental erasure.

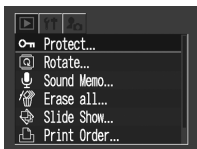

SET



- 1** In the (Play) menu, select and press the **SET** button.

See *Selecting Menus and Settings* (p. 43).



- 2** Use the or button to select an image to protect and press the **SET** button.

- The icon appears on protected images.
- You can make the selection of images easier by toggling between single image playback and index playback by pressing the zoom lever toward or .



Protection Icon

SET



- 3** Press the **MENU** button.

The Play menu displays again. Press it again to return to the Playback screen.

MENU



To cancel protection

After step 1, select an image to remove protection from and press the **SET** button.



Please note that formatting (initializing) a CF card erases all data, including protected images (p. 107).

Erasing Single Images

You can erase images you do not need or are not satisfied with one by one.



- Please note that erased images cannot be recovered. Exercise adequate caution before erasing a file.
- Protected images cannot be erased with this function.



FUNC.





1 Use the  or  button to select an image for deletion and press the  button.



SET



2 Use the  or  button to select [Erase] and press the SET button. To exit instead of erasing, select [Cancel].

Erasing All Images



You can erase all the images saved on the CF card.



- Please note that erased images cannot be recovered. Exercise adequate caution before erasing a file.
- Protected images cannot be erased with this function.

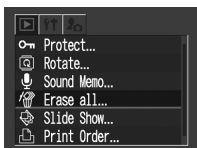

1 In the (Play) menu, select and press the SET button.

See *Selecting Menus and Settings* (p. 43).



2 Use the or button to select [OK] and press the SET button.

To exit instead of erasing, select [Cancel].

Formatting CF Cards



You should always format a new CF card or one from which you wish to erase all images and other data.



Please note that formatting (initializing) a CF card erases all data, including protected images and other file types.

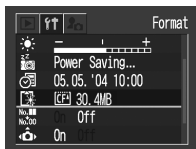



SET



1 In the **[1]** (Set up) menu, select  and press the SET button.

See *Selecting Menus and Settings* (p. 43).



2 Use the  or  button to select **[OK]** and press the SET button.

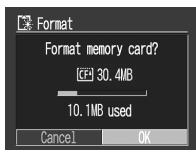

SET



- To exit instead of formatting, select **[Cancel]**.
- The capacity of the CF card displayed after formatting will be less than the rated capacity of the CF card. This is not a malfunction of the CF card or camera.



- When the camera is malfunctioning, a corrupted CF card might be the cause. Reformatting the CF card may solve the problem.
- When a non-Canon brand CF card is malfunctioning, reformatting it may solve the problem.
- CF cards formatted in other cameras, computers, or peripheral devices may not operate correctly in this camera. When that happens, reformat the CF card with this camera. If formatting in the camera does not work properly, turn the camera off and re-insert the CF card. Then turn the camera back on and format again.

About Printing



Images shot with this camera can be printed using one of the following methods.

- Connecting the camera to a direct print compatible printer*¹ with a single cable and pressing the  button on the camera.
- Selecting images and specifying the number of print copies (DPOF*² print settings) with the camera before sending the images (CF card) to a photo developing center

*¹ This camera complies with the *PictBridge* standard, which allows you to print with non-Canon *PictBridge* compliant printers as well.

*² Digital Print Order Format

This guide explains DPOF print settings. For information on how to print images, refer to the *Direct Print User Guide* supplied with the camera. Also, refer to your printer's manual.

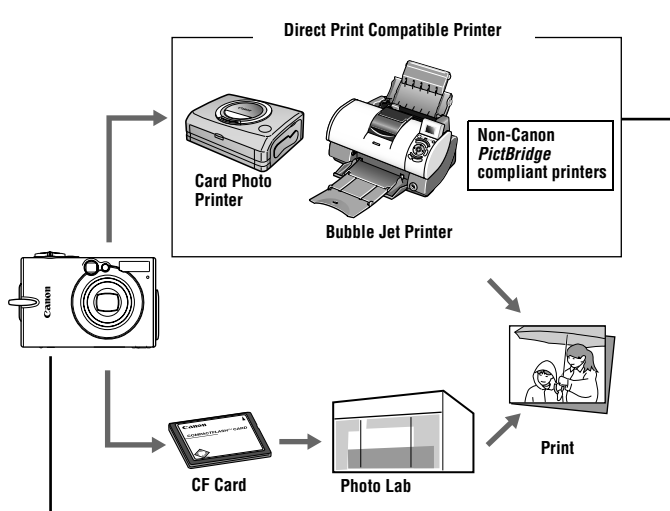

Please refer to the *System Map* supplied with your camera for direct print compatible printer (CP series or Bubble Jet printers) information.

Direct Print Compatible Printing

- Connect the camera to the printer
- Set various print settings (except DPOF print settings)
- Print

For details, see the *Direct Print User Guide* (separate from this guide).

DPOF Print Settings

- See *Selecting Images for Printing* (p. 110).



- Set the number of print copies (p. 111)



- See *Setting the Print Style* (p. 113).
 - Standard/Index/Both
 - Date: On/Off
 - File Numbers: On/Off

For details, see the *Direct Print User Guide* (separate from this guide).

DPOF Transfer Order

- Select the images to download to a computer (p. 116)

Setting the DPOF Print Settings

You can select images on a CF card for printing and specify the number of print copies in advance using the camera. This is extremely convenient for sending the images to a photo developing service, or for printing on a direct print function compatible printer.

See the *Direct Print User Guide* for instructions on how to print.

Selecting Images for Printing

There are two ways to select images.

- Singly
- All images on a CF card (the number of print copies is set to one per image)



SET



1 In the  (Play) menu, select  and press the SET button.

See *Selecting Menus and Settings* (p. 43).



2 Use the  or  button to select [Order] and press the SET button.

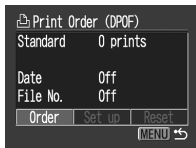

SET



Single Images



Number of Print Copies







Selected for an Index Print







3 Select images for printing.

As shown below, selection methods differ according to the options chosen for the  (Print Type) settings (p. 113).

(Standard)/ (Both)

Use the  or  button to select an image and the  or  button to select the number of print copies (up to maximum of 99).

(Index)

Use the  or  button to move to an image and the  or  button to select or deselect it.

A checkmark displays on selected images.

You can press the zoom lever toward  to switch to the index mode (3 images) and use the same procedures to select images.

4 Press the MENU button.

The Print Order menu will reappear. Pressing the **MENU** button again returns to the Play menu. Press it again to go back to the Playback screen.



All the Images on a CF Card



3 Press the zoom lever toward .



The display switches to index playback (3 images).



4 Press the SET button.



5 Use the or button to select [Mark all] and press the SET button.

- One copy is set to print for each image.
- When the print type is set to  (Standard) or  (Both), the number of print copies can be set individually for each image. When  (Index) is selected, the print settings can be deleted.
- You can cancel all the settings by selecting [Clear all].



6 Press the MENU button.

The Print Order menu will reappear. Pressing the **MENU** button again returns to the Play menu. Press it again to go back to the Playback screen.









- The  icon may display for a CF card that has had print settings set by a different DPOF-compliant camera. These settings will be overwritten by those set by your camera.
- The output of some printers or photo developing services may not reflect the specified print settings.
- Print settings cannot be set for movie images.



- Images are printed in order from oldest to newest by the shooting date.
- A maximum of 998 images can be selected per CF card.
- When [Print Type] is set to [Both], the number of copies can be set. When it is set to [Index], the number of copies cannot be set (only one copy will be printed).
- Print settings can also be assigned to images with the bundled software (ZoomBrowser EX/ImageBrowser) on a computer.

Setting the Print Style

Set the print style after selecting the image to print. The following print settings can be selected.

 Print Type	 Standard	Prints one image per page.
	 Index	Prints the selected images together at a reduced size in an index format.
	 Both	Prints the images in both the standard and index formats.
 Date		Adds the date to the print.
 File No.		Adds the file number to the print.

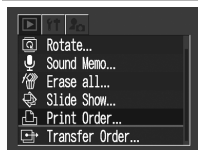



SET



1 In the  (Play) menu, select  and press the SET button.

See *Selecting Menus and Settings* (p. 43).



2 Use the  or  button to select [Set up] and press the SET button.

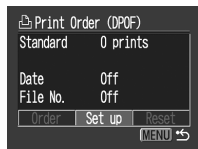

SET





3 Use the or button to select , or and the or button to select an option.

(**Print Type**)

Select [Standard], [Index] or [Both].

(**Date**)

Select [On] or [Off].

(**File No.**)

Select [On] or [Off].

MENU



4 Press the **MENU** button.

The Print Order menu will reappear.

Pressing the **MENU** button again returns to the Play menu. Press it again to go back to the Playback screen.



- When [Print Type] is set to [Index], the [Date] and [File No.] cannot be set to [On] at the same time.
- With CP printers, if [Print Type] is set to [Both], both [Date] and [File No.] can be set to [On], however, only the file number is printed for the index print.



The date prints in the format specified in the Date/Time menu (p. 26).

Resetting the Print Settings

The print settings can all be removed at once. The print type resets to Standard and the Date and File No. options to Off.

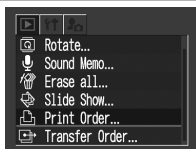

SET



- 1** In the  (Play) menu, select  and press the SET button.

See *Selecting Menus and Settings* (p. 43).

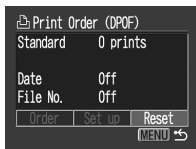

SET



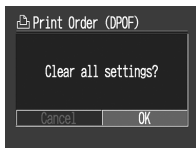

- 2** Use the  or  button to select [Reset] and press the SET button.



SET



- 3** Use the  or  button to select [OK] and press the SET button.

To exit without resetting, select [Cancel].

Image Transmission Settings (DPOF Transfer Order)

You can use the camera to specify settings for images before downloading to a computer. Refer to the *Software Starter Guide* for instructions on how to transfer images to your computer. You cannot use this function to transfer several images at once on Mac OS X computers.

The settings used on the camera comply with the Digital Print Order Format (DPOF) standards.



The  icon may display for a CF card that has had print settings set by a different DPOF-compliant camera. These settings will be overwritten by those set by your camera.

Selecting Images for Transferring

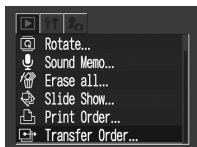

SET



- 1 In the  (Play) menu, select  and press the SET button.

See *Selecting Menus and Settings* (p. 43).



- 2 Use the  or  button to select [Order] and press the SET button.

Selecting [Reset] cancels the transfer settings for all images on a CF card.



SET







Selected for Transfer



3 Use the or button to move between images and the or button to select and deselect them.

- A checkmark displays on selected images.
- You can press the zoom lever toward  to switch to the index mode (3 images) and use the same procedures to select images.
- While in index playback, pressing the **SET** button displays the menu for selecting or deselecting all images. Use the  or  button to select [Mark all] or [Clear all] and press the **SET** button.



4 Press the **MENU** button.

The Transfer Order menu reappears. Pressing the **MENU** button again returns to the Play menu. Press it again to go back to the Playback screen.



- Images are transferred in order from oldest to newest by the shooting date.
- A maximum of 998 images can be selected per CF card.

Connecting the Camera to a Computer

The following methods can be used to download images recorded by the camera to a computer. Some methods are not applicable to all operating systems.

• Downloading via a Camera to Computer Connection

Windows 98	Windows Me	Windows 2000	Windows XP	Mac OS 9	Mac OS X
---------------	---------------	-----------------	---------------	-------------	-------------

With this method, you download images using computer commands after you have installed the appropriate software.

See *Connecting the Camera to a Computer* (p. 119), and the separate *Software Starter Guide*.

Windows 98	Windows Me	Windows 2000	Windows XP
---------------	---------------	-----------------	---------------

With this method, you download images using camera button operations after you have installed the appropriate software (the computer settings only need to be adjusted for the first download).

See *Connecting the Camera to a Computer* (p. 119) and *Downloading Images by Direct Transfer* (p. 123).

Windows XP	Mac OS X
---------------	-------------

With this method, you download images using computer commands without installing any software.

See *Connecting the Camera to a Computer* (p. 119) (Software Installation Not Required) and *Connecting the Camera to the Computer to Download Images without Installing Software* (p. 125).

• Downloading Directly from a CF Card

With this method, you download images using a card adapter or card reader.

See *Downloading Directly from a CF Card* (p. 126).

Connecting the Camera to a Computer

Computer System Requirements

Windows

OS	Windows 98 (First or Second Edition) Windows Millennium Edition (Windows Me) Windows 2000 Windows XP (Home Edition, Professional)
Computer Model	The above OS should be pre-installed on computers with built-in USB ports.
CPU	Windows 98/ Windows Me/ Windows 2000: Pentium 150 MHz or higher processor Windows XP: Pentium 300 MHz or higher processor For all of the above OSs: Pentium 500MHz or higher processor is recommended (for editing movies)
RAM	Windows 98/ Windows Me/Windows 2000: 64 MB or more Windows XP: 128 MB or more For all of the above OSs: 128MB or more is recommended (for editing movies)
Interface	USB
Free Hard Disk Space	<ul style="list-style-type: none">• Canon Utilities<ul style="list-style-type: none">- ZoomBrowser EX: 200 MB or more (Including the PhotoRecord printing program)- PhotoStitch: 40 MB or more• Canon Camera TWAIN Driver: 25 MB or more• Canon Camera WIA Driver: 25 MB or more
Display	800 x 600 pixels/ High Color (16 bit) or better is required 1,024 x 768 pixels or better is recommended

Macintosh

OS	Mac OS 9.0 – 9.2, Mac OS X (v10.1/v10.2)
Computer Model	The above OS should be pre-installed on computers with built-in USB ports.
CPU	PowerPC
RAM	Mac OS 9.0 – 9.2: 64 MB or more of application memory Mac OS X (v10.1/v10.2): 128 MB or more
Interface	USB
Free Hard Disk Space	<ul style="list-style-type: none">• Canon Utilities<ul style="list-style-type: none">- ImageBrowser: 120 MB or more- PhotoStitch: 30 MB or more
Display	800 x 600 pixels/ 32,000 Colors or better is required 1,024 x 768 pixels or better is recommended

IMPORTANT

You must install the software and driver bundled on the supplied Canon Digital Camera Solution Disk onto your computer before connecting the camera to a computer.



The camera will not operate correctly if you connect it to your computer before installing the driver and software. If this happens, please refer to the *Troubleshooting* section of the *Software Starter Guide*.



- You do not need to turn off the camera or computer power when making a USB connection.
- Please refer to your computer's manual for information regarding the location of the USB port.
- You are recommended to use a fully charged battery pack or AC Adapter Kit ACK500 (sold separately) to power the camera when connecting to a computer (pp. 18, 140).
- All procedures performed with a connection to a USB 2.0 compliant board are not guaranteed.

1 Install the driver and the software applications bundled on the Canon Digital Camera Solution Disk.

Please see the *Software Starter Guide* for the installation procedures.

2 Use the supplied interface cable to connect the computer's USB port to the camera's DIGITAL terminal.

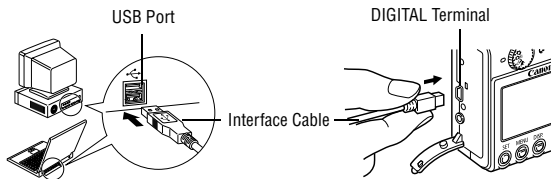

- To connect the interface cable to the camera's DIGITAL terminal, lift the terminal cover with a fingernail under its upper edge and insert the connector until it clicks into place.
- Always grasp the connector's sides to remove the interface cable from the camera's DIGITAL terminal.

3 Slide the camera's mode switch to **▶ (Play)**.

4 Press the **ON/OFF** button until the power lamp lights green.

- **Windows:**

Proceed to steps 5 and 6 below.

- **Macintosh:**

Refer to the *Software Starter Guide* and download images.

5 Select **[Canon CameraWindow]** in the event dialog that appears on the computer and click **[OK]** (first time only).

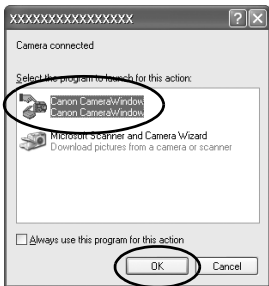

If the event dialog fails to appear, click the [Start] menu, followed by [Programs] or [All Programs], [Canon Utilities], [CameraWindow], and [CameraWindow Set Auto-Launch].

6 Click [Set] in the [CameraWindow - Set Auto-Launch] window (first time only).

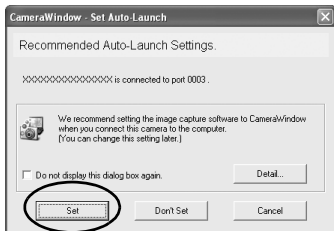





The Download Image window will display.



- **Using the software and computer to download images:**
See the *Software Starter Guide*.
- **Using the Camera to Download Images (Direct Transfer Function)**
See *Downloading Images by Direct Transfer* (next page).

Downloading Images by Direct Transfer

Use this method to download images using camera operations. Install the supplied software and adjust the computer settings before using this method for the first time (p. 120).

	All Images	Transfers and saves all images to the computer.
	New Images	Transfers and saves to the computer only the images that have not been previously transferred.
	DPOF Trans. Images	Transfers and saves to the computer only the images with DPOF Transfer Order settings (p. 116).
	Select & Transfer	Transfers and saves single images to the computer as you view and select them.
	Wallpaper	Transfers and saves single images to the computer as you view and select them. The transferred images display on the computer desktop.



1 Confirm that the Direct Transfer menu is displayed on the camera's LCD monitor.

- The  button will light blue.
- Press the **MENU** button if the Direct Transfer menu fails to appear.

All Images/New Images/DPOF Trans. Images

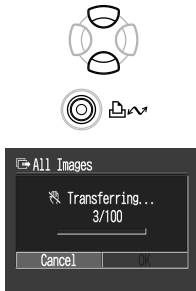







2 Use the or button to select , or , and press the .

- To cancel the transfer, press the **SET** button.
- The images will download and the Direct Transfer menu will reappear.



Select & Transfer/Wallpaper



2 Use the  or  button to select  or , and press the   button (or SET button).



3 Use the  or  button to select images to download and press the   button (or SET button).

The images will download. The   button will blink blue while downloading is in progress.





4 Press the MENU button.

The Direct Transfer menu will reappear.



Only JPEG format images can be downloaded as wallpaper for the computer.



The option selected with the   button is retained even when the camera's power is turned off. The previous setting will be in effect the next time the Direct Transfer menu is displayed. The image selection screen will appear directly when the [Select & Transfer] or the [Wallpaper] option was last selected.

Connecting the Camera to the Computer to Download Images without Installing Software

If you are using Windows XP or Mac OS X (v10.1/v10.2), you can use the software distributed with these operating systems to download images (JPEG format only) without installing the software bundled on the Canon Digital Camera Solution Disk. This is useful for downloading images to a computer in which the software is not installed.

However, please note that there are certain limitations to downloading with this method. For more details, please refer to the supplied *For Windows® XP and Mac OS X Users* leaflet.

1 Use the supplied interface cable to connect the computer's USB port to the camera's DIGITAL terminal.

See steps 2-4 and onward on p.120.

2 Follow the onscreen instructions to proceed with downloading.

Downloading Directly from a CF Card

- 1 Eject the CF card from the camera and insert it into a CF card reader connected to the computer.**

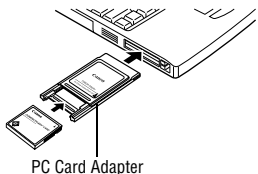
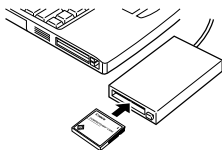

- If you are using a PC card reader or a PC card slot, first place the CF card into a PC card adapter (sold separately) and then insert the loaded adapter into the slot.
- Refer to your card adapter's or card reader's manual for information regarding the connection between the computer and card adapter or card reader.

- 2 Double-click the icon of the drive containing the CF card.**

Depending on the operating system, the drive containing the CF card may display automatically.

- 3 Copy the CF card's images to the desired folder on the hard disk.**

The images are contained in the [xxxCANON] folder, which is a subfolder of the [DCIM] folder on the CF card. The xxx represents a number from 100 to 998 (p. 88).

Viewing Images on a TV set

You can use a video-compatible television as a monitor to shoot or play back images when it is connected to the camera with the supplied AV Cable AVC-DC300.

Power Lamp

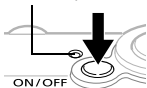

- 1 Press the ON/OFF button to turn the camera off.**

Also turn the television off.

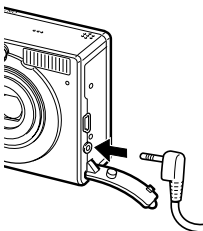

- 2 Connect the AV cable to the camera's A/V Out terminal.**

Slip your fingernail under the upper edge of the terminal cover to open it and insert the cable securely.

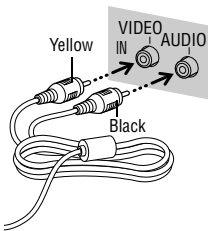

- 3 Plug the other ends of the AV cable to the VIDEO IN and AUDIO IN jacks on the TV.**

- 4 Turn on the TV and switch it to Video mode.**



- 5 Slide the mode switch to  (Shooting) or  (Playback).**

Power Lamp

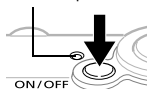

6 Press the ON/OFF button.

- The image will appear on the TV. Shoot or play back images as usual.
- If the images are not appearing on the TV when shooting, press the **DISP.** button.



- A TV set cannot be used in  (stitch assist).
- No image will appear on the LCD monitor when the camera is connected to a TV.
- If the TV is a stereo model, you can plug the audio plug into either the left or right Audio In jack. Please refer to the TV's manual for details.



The video output signal can be switched (NTSC or PAL) to accommodate different regional standards (p. 50). The default setting varies between regions.

- NTSC: Japan, U.S.A., Canada, Taiwan, etc.
- PAL: Europe, Asia (excluding Taiwan), Oceania, etc.

If the video system is set incorrectly, the camera output may not display properly.

Customizing the Camera (My Camera Settings)

My Camera allows you to customize the start-up image and start-up, shutter, operation and self-timer sounds. Each menu item has three choices.

Example: Start-up Image



1

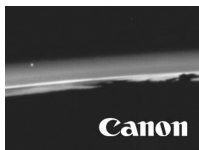

2



3

The **2** option features science fiction related images and sounds. The **3** option features animals.

Changing My Camera Settings



- 1 Select the **My Camera** (My Camera) menu.
See *Selecting Menus and Settings* (p. 43).



- 2 Use the **Left** or **Right** button to select an item.



- 3 Use the **Up** or **Down** button to select an option.

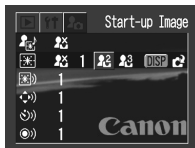





MENU



4 Press the MENU button.

- The menu will close.
 - In Shooting mode, the menu can be closed by pressing the shutter button halfway.
-







- If you select  (Theme) in Step 2, you can select a consistent theme for each of the My Camera settings.
- If the [Mute] option in the  (Set up) menu is set to [On], the beep will not sound even if each sound item is individually set to ,  or  (On) in the My Camera menu (p. 48).

Registering My Camera Settings

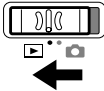
Images recorded onto the CF card and newly recorded sounds can be added as My Camera settings to the **[2]** and **[3]** menu items. You can also use the supplied software to upload your computer's images and sounds to the camera.

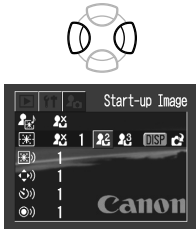
Registering CF Card Images and Sounds

-  Slide the mode switch to **[▶]** (Playback).
-  Select the **[My Camera]** menu.
See *Selecting Menus and Settings* (p. 43).
-  Use the **[Up]** or **[Down]** button to select an item.
-  Use the **[Left]** or **[Right]** button to select **[2]** or **[3]**.
The **DISP**  icon will display.
-  Press the **DISP.** button.

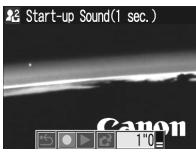

6 Select an image or record a sound.

Start-up Image

Use the or button to select the image you wish to register and press the **SET** button.

Start-up, Operation, Self-timer and Shutter Sounds

- Use the or button to select (Record) and press the SET button. Recording will start and automatically stop when the time is exceeded.
- After recording, use the or button to select (Register Sound) and press the SET button.
- Select (Exit) to return to the My Camera Menu without registering.
- Select (Play) to play the recorded sound.



7 Use the or button to select [OK] and press the SET button.

To cancel the change, select [Cancel].



- Sounds recorded with the movie and sound memo functions cannot be added as My Camera settings.
- The prior setting is erased when a new My Camera setting is added.

File Format of My Camera Settings





My Camera settings should conform to the below file formats. However, CF card images shot with this camera can be registered as My Camera settings regardless of the below formats.

Start-up Image

- Recording Format: JPEG (Baseline JPEG)
- Sampling Rate: 4:2:0 or 4:2:2
- Dimensions: 320 x 240 pixels
- File Size: 20 KB or less

Start-up, Operation, Self-timer and Shutter Sounds

- Recording format: WAVE (monaural)
- Quantization Bits: 8 bit
- Sampling Frequency: 11.025 kHz or 8.000 kHz
- Recorded Length

	11.025 kHz	8.000 kHz
 Start-up Sound	1.0 sec. or less	1.3 sec. or less
 Operation Sound	0.3 sec. or less	0.4 sec. or less
 Selftimer Sound	2.0 sec. or less	2.0 sec. or less
 Shutter Sound	0.3 sec. or less	0.4 sec. or less

* Any file formats other than those described above cannot be used with this camera.

An example of this function is to record “Say Cheese” as a self-timer sound so that the camera will replay this sound 2 seconds before the photo is taken. You could also record cheerful music to bring out the natural smiles of your subjects, or so they can strike a pose fitting the music. In these ways you can customize your camera by creating and adding new My Camera settings.



See the supplied *Software Starter Guide* for more information on creating and adding to the My Camera files.



List of Messages

List of Messages during Shooting/Playback

The following messages may appear on the LCD monitor during shooting or playback. Please refer to the *Direct Print User Guide* for the messages that display during a printer connection.

Busy...	Image is being recorded to, or read from, CF card.
No memory card	You attempted to shoot or play back images without a CF card installed.
Cannot record!	You attempted to shoot an image without a CF card installed.
Memory card error!	CF card has experienced an anomaly.
Memory card full	CF card is too full to accommodate more images or print settings.
Naming error!	The file could not be created because there is a file with the same name as the directory that the camera is attempting to create, or the highest possible file number has already been reached. In the Rec. Menu, set the File Reset option to [On]. Save all the images you wish to retain onto a computer, then reformat the CF card. Please note that formatting will erase all the existing images and other data.
Change the battery pack	Battery charge is insufficient to operate the camera. Replace it at once with a charged one or recharge the battery pack.
No image	No images recorded on CF card.
Image too large	You attempted to play back an image larger than 4064 x 3048 pixels or with a large file size.
Incompatible JPEG format.	You attempted to play back an incompatible JPEG file.
Corrupted Data	You attempted to play back an image with corrupted data.
RAW	You attempted to play back an image recorded in the RAW format.

Unidentified Image	You attempted to play back an image that was recorded in a special format (proprietary format used by the camera of another manufacturer, etc.) or a movie clip recorded by another camera.
Cannot magnify!	You attempted to magnify a movie clip or an image which was photographed with another camera, recorded in a different format, or edited on a computer.
Cannot rotate	You attempted to rotate a movie clip or an image which was photographed with another camera, recorded in a different format, or edited on a computer.
Incompatible WAVE format	A sound memo cannot be added to this image since the format of the existing sound memo is incorrect.
Cannot register this image!	You attempted to add a start-up image that was created with another camera, or a movie clip.
Protected!	You attempted to erase a protected image or a protected movie clip.
Too many marks	Too many images have been marked with print settings or transfer settings. Cannot process any more.
Unselectable image	You attempted to set the print settings for a non-JPEG file.
Exx	(xx: number) Camera malfunction. Turn the power off and then back on, then shoot or play back. A problem exists if the error code reappears. Note the number and contact your Canon Customer Support Help Desk. If an error code displays directly after taking a picture, the shot may not have been recorded. Check image in playback mode.

Problem	Cause	Solution
Camera will not operate	Power is not turned on	<ul style="list-style-type: none"> Press the ON/OFF button for a moment.
	Battery cover or CF card slot cover is open	<ul style="list-style-type: none"> Confirm that the battery cover and CF card slot cover are securely closed.
	Insufficient battery voltage	<ul style="list-style-type: none"> Insert a fully charged battery into the camera. Use the AC Adapter Kit ACK500 (sold separately).
	Poor contact between camera and battery terminals	<ul style="list-style-type: none"> Wipe the terminals with a clean dry cloth.
Camera will not record	Mode switch is set to  (Playback)	<ul style="list-style-type: none"> Slide the mode switch to .
	Flash is charging	<ul style="list-style-type: none"> Wait until the flash charges. You can press the shutter button when the indicator lights orange.
	CF card is full	<ul style="list-style-type: none"> Insert a new CF card. If required, download the images to a computer and erase them from the CF card to make space.
	CF card is not formatted correctly	<ul style="list-style-type: none"> Format CF card. <ul style="list-style-type: none"> ➡(See <i>Formatting CF Cards</i> (p. 107).) If reformatting does not work, the CF card logic circuits may be damaged. Consult the nearest Canon Customer Support Help Desk.
Cannot play back	You attempted to play back images shot with another camera or images edited with a computer	<ul style="list-style-type: none"> Computer images that cannot be played back will playback if they are added to the camera using the bundled software program ZoomBrowser EX or ImageBrowser. See <i>ZoomBrowser EX/ImageBrowser Software Starter Guide</i> (PDF).
	File name was changed with a computer or file location was changed	<ul style="list-style-type: none"> Set the file name or location to the file format/structure of the camera. <ul style="list-style-type: none"> ➡See <i>About File Numbers and Folder Numbers</i> (p. 88).

Problem	Cause	Solution
Lens will not retract	Battery cover or CF card slot cover was opened with power on	<ul style="list-style-type: none"> • First close the battery cover or CF card slot cover and then turn the power off.
	Battery cover or CF card slot cover was opened while recording to the CF card (warning signal sounds)	<ul style="list-style-type: none"> • First close the battery cover or CF card slot cover and then turn the power off.
Battery pack consumed quickly	Battery life exceeded if battery pack loses its charge quickly at normal temperature (23 °C/73 °F)	<ul style="list-style-type: none"> • Replace the battery pack with a new one.
Battery pack will not charge	Battery pack life exceeded	<ul style="list-style-type: none"> • Replace the battery pack with a new one.
	Poor contact between battery pack and battery charger	<ul style="list-style-type: none"> • Insert battery pack securely into battery charger. • Ensure that battery charger plug is securely plugged into the power outlet.
Image is blurred or out of focus	Camera moved	<ul style="list-style-type: none"> • Be careful not to move the camera while pressing the shutter button.
	Autofocus function hampered by obstruction to AF-assist Beam	<ul style="list-style-type: none"> • Be careful not to block the AF-assist Beam with fingers or other items.
	AF-assist Beam is set to [Off]	<ul style="list-style-type: none"> • Set the AF-assist Beam to [On] (p. 47).
	Subject is out of focal range	<ul style="list-style-type: none"> • Ensure there is at least 46 cm (1.5 ft.) between the camera lens and subject. • Use the Macro mode to shoot close-ups between 30 and 46 cm (1.0 to 1.5 ft.) from the lens (5 cm (2 in.) when set to wide angle). • Use the Infinity mode to shoot distant subjects.

Problem	Cause	Solution
Image is blurred or out of focus	The subject is hard to focus on	<ul style="list-style-type: none"> • Use the focus lock or AF lock to shoot. ➔ See <i>Shooting Hard-to-Focus Subjects (Focus Lock, AF Lock)</i> (p. 72).
Subject in recorded image is too dark	Insufficient light for shooting	<ul style="list-style-type: none"> • Set the flash to on.
	Subject is dark in contrast to the background	<ul style="list-style-type: none"> • Set the exposure compensation to a positive (+) setting or use the spot metering function.
	Subject is too far away for flash to reach	<ul style="list-style-type: none"> • Shoot within 3.5 m (11 ft.) of the subject at the maximum wide angle or 2.0 m (6.6 ft.) of the subject at the telephoto end setting using the flash. • Raise the ISO sensitivity and then shoot. See <i>Adjusting the ISO Speed</i> (p. 85).
Subject in recorded image is too bright	Subject is too close, making the flash too strong	<ul style="list-style-type: none"> • When using the flash, stay at least 46 cm (1.5 ft.) from the subject.
	Subject is bright in contrast to the background	<ul style="list-style-type: none"> • Set the exposure compensation to a negative (-) setting or use the spot metering function.
	Light is shining directly on the subject or reflected off the subject into the camera	<ul style="list-style-type: none"> • Change the shooting angle.
	Flash is set to on	<ul style="list-style-type: none"> • Set the flash to off.
A bar of light (red, purple) appears on the LCD monitor	Subject is too bright	<ul style="list-style-type: none"> • This is a normal occurrence in devices containing CCDs and does not constitute a malfunction. (This bar of light will not be recorded when shooting still photos, but it will be recorded when shooting movies.)

Problem	Cause	Solution
White dots appear on the image	Light from the flash has reflected off dust particles or insects in the air. (This is especially noticeable when shooting at wide angle)	<ul style="list-style-type: none"> • This is a phenomenon that occurs with digital cameras and does not constitute a malfunction.
Flash does not fire	Flash is set to off	<ul style="list-style-type: none"> • Set the flash to on.
Image not showing on TV monitor	Incorrect video system setting	<ul style="list-style-type: none"> • Set the video system to the appropriate setting, NTSC or PAL, for your TV (p. 50).
	Shooting in stitch assist	<ul style="list-style-type: none"> • The output will not appear on a TV in stitch assist. Cancel the stitch assist.
Zoom does not work	Zoom lever pressed during movie recording	<ul style="list-style-type: none"> • Adjust the zoom before shooting a movie.
Reading images from CF card is slow	CF card was formatted in another device	<ul style="list-style-type: none"> • Use a CF card formatted in your camera. ➡ See <i>Formatting CF Cards</i> (p. 107).
Recording images to CF card takes a long time		

Using an AC Adapter Kit (Sold Separately)

It is best to power the camera with AC Adapter Kit ACK500 (sold separately) when you are using it for long periods of time or connecting it to a computer.



Turn the camera power off before connecting or disconnecting the AC adapter.

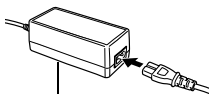

Compact Power Adapter
CA-PS500

- 1 Connect the power cord to the compact power adapter first and then plug the other end into the power outlet.**

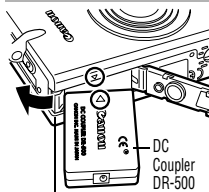

Battery Lock

- 2 Open the battery cover, then insert the DC coupler until it is locked.**

- Insert the DC coupler while pressing the battery lock as the arrow shows.
- Slide the battery cover closed.

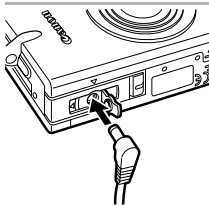

- 3 Open the DC coupler terminal cover and attach the cord to the DC terminal.**

After you have finished using the camera, unplug the AC adapter from the power outlet.



Use of an AC adapter kit other than ACK500 (sold separately) may cause a malfunction in the camera or kit.

Using a Car Battery Charger (Sold Separately)

Car Battery Charger CBC-NB1 (sold separately) can be used to charge battery packs from an automobile's cigarette lighter socket.



Always ensure that the automobile's engine is running when you use the car battery charger. Use of it with the engine off may deplete the battery in some automobiles. Always unplug the car battery charger before turning off the engine .

To the cigarette lighter socket

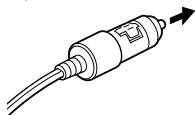

1 With the engine running, plug the car battery cable into the cigarette lighter socket and the battery charger.

Charge Indicator

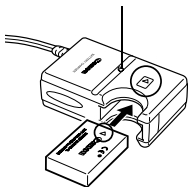

2 Insert the battery pack all the way into the battery charger as shown.

- Align the battery pack according to the arrows on the battery and the charger.
- The charge indicator will light red while the battery pack is charging. It will change to green when the charge is complete.
- After charging, unplug the car battery cable from the cigarette lighter socket and remove the battery pack.



- The battery will stop charging whenever you turn the engine off, so be sure to unplug the car battery cable from the cigarette lighter socket.
- Wait until the engine is running again to plug the car battery cable into the cigarette lighter socket.
- The car battery charger can only be used in a negative ground car. It cannot be used in a positive ground car.

Camera Care and Maintenance

Use the following procedures to clean the camera body, lens, viewfinder and LCD monitor.



Never use thinners, benzene, synthetic cleansers or water to clean the camera. These substances may distort or damage the equipment.

Camera Body

Gently wipe dirt off the camera body with a soft cloth or eyeglass lens wiper.

Lens

First use a lens blower brush to remove dust and dirt, then remove any remaining dirt by wiping the lens lightly with a soft cloth.



Never use synthetic cleansers on the camera body or lens. If dirt remains, contact the closest Canon Customer Support Help Desk as listed on the separate Canon Customer Support leaflet.

Viewfinder and LCD Monitor

Use a lens blower brush to remove dust and dirt. If necessary, gently wipe with a soft cloth or an eyeglass lens wiper to remove stubborn dirt.



Never rub or press strongly on the LCD monitor. These actions may damage it or lead to other problems.

Specifications



All data is based on Canon's standard testing methods. Subject to change without notice.

PowerShot S500 DIGITAL ELPH/DIGITAL IXUS 500 PowerShot S410 DIGITAL ELPH/DIGITAL IXUS 430

(W): wide angle (T): telephoto

Camera Effective Pixels	PowerShot S500 DIGITAL ELPH/DIGITAL IXUS 500: Approx. 5.0 million PowerShot S410 DIGITAL ELPH/DIGITAL IXUS 430: Approx. 4.0 million
Image Sensor	PowerShot S500 DIGITAL ELPH/DIGITAL IXUS 500: 1/1.8-inch CCD (Total number of pixels: Approx. 5.3 million) PowerShot S410 DIGITAL ELPH/DIGITAL IXUS 430: 1/1.8-inch CCD (Total number of pixels: Approx. 4.1 million)
Lens	7.4 (W) – 22.2 (T) mm (35 mm film equivalent: 36 (W) – 108 (T) mm) f/2.8 (W) – f/4.9 (T)
Digital Zoom	PowerShot S500 DIGITAL ELPH/DIGITAL IXUS 500: Approx. 4.1x (Up to approx. 12x in combination with the optical zoom) PowerShot S410 DIGITAL ELPH/DIGITAL IXUS 430: Approx. 3.6x (Up to approx. 11x in combination with the optical zoom)
Optical Viewfinder	Real-image zoom viewfinder
LCD Monitor	1.5-inch, low-temperature polycrystalline silicon TFT color LCD, approx. 118,000 pixels (Picture coverage 100%)
AF System	TTL autofocus Focusing frame: 9-point AiAF/1-point AF (center)
Shooting Distance (From the front of the lens)	Normal AF: 46 cm (1.5 ft.) – infinity Macro AF: 5 – 46 cm (W)/30 – 46 cm (T) (2.0 in. – 1.5 ft. (W)/1.0 – 1.5 ft. (T))
Shutter	Mechanical shutter + electronic shutter

Shutter Speeds	15 – 1/2000 sec. 15 – 1 sec. possible in long shutter mode. Slow shutter speeds of 1.3 sec. or slower operate with noise reduction.
Light Metering System	Evaluative, Center-weighted average or Spot (Center)
Exposure Control System	Program AE
Exposure Compensation	± 2.0 stops in 1/3-stop increments
Sensitivity	Auto, ISO 50/100/200/400 equivalent
White Balance	TTL auto, pre-set (available settings: Daylight, Cloudy, Tungsten, Fluorescent or Fluorescent H) or custom
Built-in Flash	Auto/Red-eye reduction auto/on/off/slow-synchro
Flash Range	Normal: 46 cm – 3.5 m (1.5 – 11 ft.) (W), 46 cm – 2.0 m (1.5 – 6.6 ft.) (T) Macro: 30 cm – 46 cm (1.0 – 1.5 ft.) (W/T) (When sensitivity is set to AUTO.)
Shooting Modes	Auto/manual/stitch assist/movie
Continuous Shooting	High-speed: PowerShot S500 DIGITAL ELPH/DIGITAL IXUS 500: Approx. 2.2 shots/sec. PowerShot S410 DIGITAL ELPH/DIGITAL IXUS 430: Approx. 2.5 shots/sec. Normal: Approx. 1.5 shots/sec. (Large/Fine mode with LCD monitor off)
Self-timer	Activates shutter after an approx. 2-sec./approx. 10-sec. delay
PC-controlled Shooting	Available (USB connection only. Exclusive software program is included in the camera kit.)
Recording Media	CompactFlash™ card (Type I)
File Format	Design rule for camera file system and DPOF compliant
Image Recording Format	Still images: JPEG (Exif 2.2)* ¹ Movies: AVI (Image data: Motion JPEG; Audio data: WAVE (monaural))
Compression	Superfine, Fine, Normal

Number of Recording Pixels	<p>Still images: PowerShot S500 DIGITAL ELPH/DIGITAL IXUS 500</p> <p>Large: 2592 x 1944 pixels</p> <p>Medium 1: 2048 x 1536 pixels</p> <p>Medium 2: 1600 x 1200 pixels</p> <p>Small: 640 x 480 pixels</p> <p>PowerShot S410 DIGITAL ELPH/DIGITAL IXUS 430</p> <p>Large: 2272 x 1704 pixels</p> <p>Medium 1: 1600 x 1200 pixels</p> <p>Medium 2: 1024 x 768 pixels</p> <p>Small: 640 x 480 pixels</p>
Number of Recording Pixels	<p>Movies: PowerShot S500 DIGITAL ELPH/DIGITAL IXUS 500</p> <p>640 x 480 pixels (approx. 30 sec.)</p> <p>320 x 240 pixels (approx. 3 min.)</p> <p>160 x 120 pixels (approx. 3 min.)</p> <p>PowerShot S410 DIGITAL ELPH/DIGITAL IXUS 430</p> <p>320 x 240 pixels (approx. 3 min.)</p> <p>160 x 120 pixels (approx. 3 min.)</p> <p>The data in parentheses refer to the maximum movie length per shooting.</p> <p>(:10 frames/sec.,  :15 frames/sec.)</p>
Playback Modes	Single (histogram displayable), Index (9 thumbnail images), Magnified (approx. 10x (max.) in LCD monitor), Sound memos (up to 60 sec.) or Slide show.
Direct Print	<i>Canon Direct Print</i> and <i>Bubble Jet Direct</i> compatible, and <i>PictBridge</i> compliant
Display Languages	12 languages available for menus and messages (English, German, French, Dutch, Danish, Finnish, Italian, Norwegian, Swedish, Spanish, Chinese and Japanese)
My Camera Settings	<p>The start-up image, start-up sound, shutter sound, operation sound and self-timer sound can be customized using the following methods:</p> <ol style="list-style-type: none"> 1. Using the images and sounds recorded on a camera. 2. Using the downloaded data from your computer using the supplied software.
Interface	USB (mini-B, PTP [Picture Transfer Protocol]), Audio/Video output (NTSC or PAL selectable, monaural audio)

Power Source	Rechargeable lithium-ion battery (type: NB-1LH/NB-1L) AC Adapter Kit ACK500 Car Battery Charger CBC-NB1
Operating Temperature	0 – 40 °C (32 – 104 °F)
Operating Humidity	10 – 90%
Dimensions	87.0 x 57.0 x 27.8 mm (3.4 x 2.2 x 1.1 in.) (excluding protrusions)
Weight	Approx. 185 g (6.5 oz.) (camera body only)

*1 This digital camera supports Exif 2.2 (also called “Exif Print”). Exif Print is a standard for enhancing the communication between digital cameras and printers. By connecting to an Exif Print-compliant printer, the camera’s image data at the time of shooting is used and optimized, yielding extremely high quality prints.

Battery Capacity

Battery Pack NB-1LH (fully charged)

Number of recordable images	LCD monitor on	Approx. 190 images
	LCD monitor off	Approx. 440 images
Playback Time		Approx. 140 minutes

* Excludes movie data.

* At low operating temperatures, battery pack performance may be reduced and the low battery icon may appear earlier than usual. Under these conditions, resuscitate the battery pack by warming it in a pocket immediately before use.

Test Criteria















Shooting: Normal temperature (23° C/73° F), alternating between wide angle and telephoto every 20 seconds, flash used once in four shots, power turned off and on again after every eighth shot, LCD monitor set to default brightness.

Playback: Normal temperature (23° C/73° F), continuous playback at 3 seconds per image, LCD monitor set to default brightness.

CF Cards and Estimated Capacities















PowerShot S500 DIGITAL ELPH/DIGITAL IXUS 500



: With card included with the camera

		FC-32MH	FC-64M	FC-128M	FC-256MH	FC-512MSH
L (2592 x 1944 pixels)		11	24	49	99	198
		21	43	88	177	354
		43	88	176	355	709
M1 (2048 x 1536 pixels)		18	38	76	154	308
		33	68	137	276	552
		67	136	274	548	1095
M2 (1600 x 1200 pixels)		30	61	122	246	491
		54	109	219	440	879
		108	217	435	868	1734
S (640 x 480 pixels)		120	241	482	962	1891
		196	393	788	1563	3122
		337	676	1355	2720	5203
Movie	 (640 x 480 pixels)	46 sec.	92 sec.	186 sec.	374 sec.	742 sec.
	 (320 x 240 pixels)	91 sec.	183 sec.	368 sec.	735 sec.	1451 sec.
	 (160 x 120 pixels)	242 sec.	486 sec.	973 sec.	1954 sec.	3902 sec.

PowerShot S410 DIGITAL ELPH/DIGITAL IXUS 430

: With card included with the camera

		FC-32MH	FC-64M	FC-128M	FC-256MH	FC-512MSH
L (2272 x 1704 pixels)		14	30	61	123	247
		27	54	110	222	442
		54	110	220	443	879
M1 (1600 x 1200 pixels)		30	61	122	246	491
		54	109	219	440	879
		108	217	435	868	1734
M2 (1024 x 768 pixels)		53	107	215	431	855
		94	189	379	762	1522
		174	349	700	1390	2714
S (640 x 480 pixels)		120	241	482	962	1891
		196	393	788	1563	3122
		337	676	1355	2720	5203
Movie	 (320 x 240 pixels)	91 sec.	183 sec.	368 sec.	735 sec.	1451 sec.
	 (160 x 120 pixels)	242 sec.	486 sec.	973 sec.	1954 sec.	3902 sec.

- The maximum movie clip length is approximately : 30 sec., : 3 min.* or : 3 min. The times shown are the maximum continuous recording times.

* When using the 64MB or higher capacity CF card.

















- **L** (Large), **M1** (Medium 1), **M2** (Medium 2), **S** (Small), ,  and  indicate the recording resolution.
- ,  and  indicate the compression setting.
- Some CF cards are not sold in some regions.

Image File Sizes (Estimated)

PowerShot S500 DIGITAL ELPH/DIGITAL IXUS 500

Resolution		Compression		
				
L	(2592 x 1944)	2053 KB	1395 KB	695 KB
M1	(2048 x 1536)	1602 KB	893 KB	445 KB
M2	(1600 x 1200)	1002 KB	558 KB	278 KB
S	(640 x 480)	249 KB	150 KB	84 KB
Movies	 (640 x 480)	660 KB/sec.		
	 (320 x 240)	330 KB/sec.		
	 (160 x 120)	120 KB/sec.		

PowerShot S410 DIGITAL ELPH/DIGITAL IXUS 430

Resolution		Compression		
				
L	(2272 x 1704)	2002 KB	1116 KB	556 KB
M1	(1600 x 1200)	1002 KB	558 KB	278 KB
M2	(1024 x 768)	570 KB	320 KB	170 KB
S	(640 x 480)	249 KB	150 KB	84 KB
Movies	 (320 x 240)	330 KB/sec.		
	 (160 x 120)	120 KB/sec.		

CompactFlash™ Card

Card Slot Type	Type I
----------------	--------

Dimensions	36.4 x 42.8 x 3.3 mm (1.4 x 1.7 x 0.1 in.)
------------	--

Weight	Approx. 10 g (0.4 oz.)
--------	------------------------

Battery Pack NB-1LH

Type	Rechargeable Lithium Ion Cell
------	-------------------------------

Nominal Voltage	3.7 V
-----------------	-------

Typical Capacity	840 mAh
------------------	---------

Cycle Life	Approx. 300 times
------------	-------------------

Operating Temperatures	0 – 40 °C (32 – 104 °F)
------------------------	-------------------------

Dimensions	32.3 x 49.8 x 10.6 mm (1.3 x 2.0 x 0.4 in.)
------------	---

Weight	Approx. 29 g (1.0 oz.)
--------	------------------------

Battery Charger CB-2LS/CB-2LSE

Rated Input	100 – 240 V AC (50 / 60 Hz)
	0.075 A (100 V) – 0.045 A (240 V)

Rated Output	4.2 V DC/0.5 A
--------------	----------------

Charging Time	Approx. 130 minutes*
---------------	----------------------

Operating Temperatures	0 – 40 °C (32 – 104 °F)
------------------------	-------------------------

Dimensions	90.4 x 56.0 x 28.0 mm (3.6 x 2.2 x 1.1 in.)
------------	---

Weight	Approx. 78 g (2.8 oz.)
--------	------------------------

* When charging Battery Pack NB-1LH

Compact Power Adapter CA-PS500

(Included with the optional AC Adapter Kit ACK500)

Rated Input	100 – 240 V AC (50/ 60 Hz)
	0.17 A

Rated Output	4.3 V DC/1.5 A
--------------	----------------

Operating Temperatures	0 – 40 °C (32 – 104 °F)
------------------------	-------------------------

Dimensions	42.6 x 104.4 x 31.4 mm (1.7 x 4.1 x 1.2 in.)
------------	--

Weight	Approx. 180 g (6.3 oz.)
--------	-------------------------

Car Battery Charger CBC-NB1 (Optional)

Rated Input	DC 12 – 24 V, 4.3 W
Rated Output	4.2 V DC/0.55 A
Charging Time	Approx. 130 minutes*
Operating Temperatures	0 – 40 °C (32 – 104 °F)
Dimensions	90.4 x 56.0 x 28.0 mm (3.6 x 2.2 x 1.1 in.)
Weight	Approx. 106 g (3.7 oz.)

* When charging Battery Pack NB-1LH

Tip for Using the Self-timer**(p.64)**

Normally the camera shakes a little when you press the shutter button. Setting the self-timer to  delays the shutter release for 2 seconds and allows the camera to stop shaking, thus preventing a blurred image. Even better results can be obtained by placing the camera on a stable surface or by using a tripod to shoot.

How to adjust the exposure**(p.78)**

This camera automatically adjusts the exposure to shoot images with the optimal brightness. However, recorded images may sometimes be brighter or darker than the actual image depending on the shooting conditions. If this happens, adjust the exposure compensation manually.

**Underexposure**

The whole recorded image is dark, which makes white elements of the image appear gray. Shooting bright subjects or in backlit conditions may cause the image to be underexposed. Adjust the exposure compensation towards the + end.

**Optimal Exposure****Overexposure**

The whole recorded image is bright, which makes black elements of the image appear gray. Shooting dark subjects or in dark places may cause the image to be overexposed. Adjust the exposure compensation towards the - end.

ISO Speed

(p.85)

The ISO speed is the numeric representation of the camera's sensitivity to light. The higher the ISO speed, the higher the sensitivity. A high ISO speed allows you to shoot images in dark indoor or outdoor conditions without a flash and also helps prevent blurred images due to camera shake. This is convenient when shooting images in places where flash photography is prohibited. The ISO speed setting makes full use of the available light, resulting in images that convey the feel of the place they were shot.



ISO 50 equivalent



ISO 400 equivalent

Advanced Technique for the Macro mode (p.60)

Macro mode can make unique images when used with the zoom function. For example, shooting a flower at maximum wide angle in Macro mode allows the camera to bring both the flower and the background into focus. However, shooting at maximum telephoto can throw the background out of focus to make the flower stand out.



Macro with the wide angle zoom



Macro with the telephoto zoom

A

AC Adapter Kit ACK500	140
AE Lock	74
AF Frame	41
AF Lock	72
AF-assist Beam.....	42
AiAF.....	39
Auto Play (Slide Show).....	100
Auto Rotate Function.....	86
Autofocus	39
AV Cable AVC-DC300	127

B

Battery	
Capacity	147
Charging	18
Handling	19
Installing.....	21

C

CF Card.....	23
Formatting	107
Handling	25
Installing.....	23
Compression	55
Computer System Requirements	
.....	119
Connecting the Camera to a	
Computer	118
Continuous Shooting.....	63
Custom White Balance	82

D

Date/Time.....	26
DIGITAL Terminal.....	14, 120
Digital Zoom.....	62
Direct Interface Cable	15
Direct Transfer	123
DPOF Print Order	110
Print Style.....	113
Resetting	115

Selecting Images	110
DPOF Transfer Order.....	116

E

Erasing	105
All Images.....	106
Single Images.....	105
Exposure	78

F

FE Lock	75
File Number.....	87
Flash.....	58
Focus Lock.....	72
FUNC. menu	44

H

Histogram	38
-----------------	----

I

Image File Sizes	150
Index Playback	91
Indicator	17
Infinity	60
Interface Cable	120
ISO Speed	85

L

Language	28
LCD Monitor.....	33
Information Displayed	35
Playback Mode	37
Shooting Mode	35
Using the LCD Monitor.....	33

M

Macro.....	60
Magnifying	90
Menu	
Menu Settings and Factory	
Defaults	47
My Camera Menu	51

Play Menu	48
Rec. Menu	47
Selecting Menus and Settings	43
Set up Menu	48
Messages	
List of Messages during Shooting/Playback	134
Metering Modes	77
Mode Dial	16
Mode switch	32
Movie	70
Edit	95
Playback	93
Shooting	70
Mute Mode	48
My Camera Menu	
Changing	129
Registering	131
My Camera Setting	
File Format	133
My Camera Settings	129

O

ON/OFF Button	30
---------------------	----

P

Photo Effect	84
Play Menu	48
Playback Mode	32
Power-saving	31
Print/Share Button	16
Printing	108
Protect	104

Q

Quick Shot	57
------------------	----

R

Rec. Menu	47
Red-eye Reduction Function	59

Resolution	55
Review Duration	54
Rotate	97

S

Self-Timer	64
Set up Menu	48
Shooting Mode	
Auto	53
Functions Available in Each Shooting Mode	160
Manual	66
Movie	70
Stitch Assist	67
Shutter Button	41
Pressing Fully	42
Pressing Halfway	41
Shutter Speed	79
Single Image Playback	89
Slide Show	
Play Time	103
Repeat Settings	103
Sound Memo	98
Spot AE Point Frame	36, 77
Stitch Assist	67

T

Telephoto	40
-----------------	----

U

USB port	120
----------------	-----

V

Video Output System	128
---------------------------	-----

W

White Balance	81
Wide Angle	40
Wrist Strap	14

MEMO

Disclaimer

- While every effort has been made to ensure that the information contained in this guide is accurate and complete, no liability can be accepted for any errors or omissions. Canon reserves the right to change the specifications of the hardware and software described herein at any time without prior notice.
- Canon reserves the right to change the specifications of the hardware and software described herein at anytime without prior notice.
- No part of this guide may be reproduced, transmitted, transcribed, stored in a retrieval system, or translated into any language in any form, by any means, without the prior written permission of Canon.
- Canon makes no warranties for damages resulting from corrupted or lost data due to a mistaken operation or malfunction of the camera, the software, the CompactFlashTM cards (CF cards), personal computers, peripheral devices, or use of non-Canon CF cards.

Trademark Acknowledgements

- Canon and PowerShot are trademarks of Canon.
- CompactFlash is a trademark of SanDisk Corporation.
- iBook and iMac are trademarks of Apple Computer, Inc.
- Macintosh, PowerBook, Power Macintosh and QuickTime are trademarks of Apple Computer, Inc., registered in the United States and other countries.
- Microsoft, Windows and Windows NT are either registered trademarks or trademarks of Microsoft Corporation in the United States and/or other countries.
- Other names and products not mentioned above may be registered trademarks or trademarks of their respective companies.

FCC Notice

(Digital Camera, Model PC1084/1086)

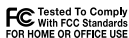

This device complies with Part 15 of the FCC Rules. Operation is subject to the following two conditions;

- (1) this device may not cause harmful interference, and
- (2) this device must accept any interference received, including interference that may cause undesired operation.

Note: This equipment has been tested and found to comply with the limits for Class B digital devices, pursuant to Part 15 of the FCC rules. These limits are designed to provide reasonable protection against harmful interference in a residential installation. This equipment generates, uses and can radiate radio frequency energy and, if not installed and used in accordance with the instructions, may cause harmful interference to radio communications. However, there is no guarantee that interference will not occur in a particular installation. If this equipment does cause harmful interference to radio or television reception, which can be determined by turning the equipment off and on, the user is encouraged to try to correct the interference by one or more of the following measures:

- Reorient or relocate the receiving antenna.
- Increase the separation between the equipment and receiver.
- Connect the equipment into an outlet on a circuit different from that to which the receiver is connected.
- Consult the dealer or an experienced radio/TV technician for help.

The cable with the ferrite core provided with the digital camera must be used with this equipment in order to comply with Class B limits in Subpart B of Part 15 of the FCC rules.

Do not make any changes or modifications to the equipment unless otherwise specified in the manual. If such changes or modifications should be made, you could be required to stop operation of the equipment.

Canon U.S.A. Inc.

One Canon Plaza, Lake Success, NY 11042, U.S.A.

Tel No. (516) 328-5600

Canadian Radio Interference Regulations

































































































THIS CLASS B DIGITAL APPARATUS MEETS ALL REQUIREMENTS OF THE CANADIAN INTERFERENCE CAUSING EQUIPMENT REGULATIONS.





Réglementation canadienne sur les interférences radio

CET APPAREIL NUMERIQUE DE LA CLASSE B RESPECTE TOUTES LES EXIGENCES DU REGLEMENT SUR LE MATERIEL BROUILLEUR DU CANADA.

Functions Available in Each Shooting Mode

The chart below is a reference for the settings available for various shooting conditions. The settings selected in each shooting mode are saved after you finish shooting.

Function		 Auto	 Manual	 Stitch Assist	 Movie	Reference Page
Resolution	Large 	 *	 *	 *	–	p. 55
	Medium 1 				–	
	Medium 2 				–	
	Small 				–	
	Movie ⁽¹⁾ 	–	–	–	 *	
	Movie 	–	–	–	 *	
	Movie 	–	–	–		
Compression	Superfine 				–	p. 55
	Fine 	 *	 *	 *	–	
	Normal 				–	
Flash	Auto 			–	–	p. 58
	Red-eye Reduction Auto 	 *	 *	–	–	
	On 	–			–	
	Off 			 *	–	
	Slow Synchro 	–			–	
Quick Shot 			–	–	p. 57	
Macro Mode 					p. 60	
Infinity Mode 	–					
AF Lock 	–		–	–	p. 72	
AE Lock 	–		–	–	p. 74	
FE Lock 	–		–	–	p. 75	
Shooting Method	Single 	 *	 *	 *	 *	–
	Standard Continuous shooting 	–		–	–	p. 63
	High-speed continuous shooting 	–		–	–	
	10-sec. self-timer 					p. 64
	2-sec. self-timer 					
Autofocus Modes	–		–	–	p. 76	
160 AF-assist Beam					p. 47	

Function		 Auto	 Manual	 Stitch Assist	 Movie	Reference Page
Digital Zoom		○	○	–	–	p. 62
Exposure Compensation		–	○	△	○	p. 78
Light Metering Method	Evaluative	–	○*	–	–	p. 77
	Center-Weighted Average	–	○	–	–	
	Spot	–	○	–	–	
Long Shutter		–	○	–	–	p. 79
White Balance		–	○	△	○	p. 81
Photo Effect		–	○	△	○	p. 84
ISO Speed		– ⁽²⁾	○	– ⁽²⁾	– ⁽²⁾	p. 85
Auto Rotate		○	○	△	–	p. 86

* Default setting

○ Setting available

△ Setting can only be selected for the first image.

■ (Shaded Area): Setting is memorized even when the camera power is shut off.

(1) **640** is not available with the PowerShot S410 DIGITAL ELPH/DIGITAL IXUS 430.

(2) The ISO speed is automatically set.

With the exception of the [Date/Time], [Language] and [Video System] settings, all the other menu settings and changes made with the camera buttons can be reset to the default values in a single operation (p. 52).