

# Panasonic®

## Palmcorder IQ®

Camcorder

### Operating Instructions

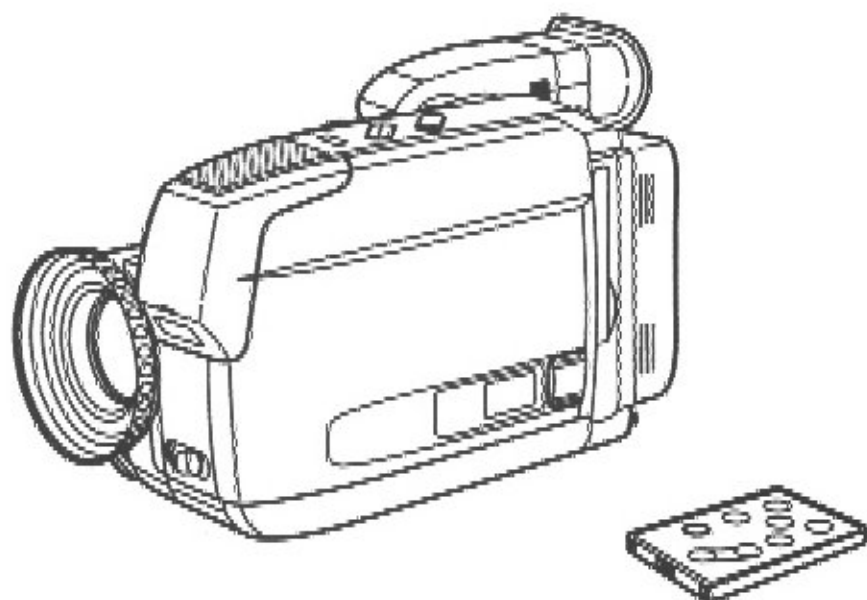

**VHS**

## PV-A296

Before attempting to connect, operate or adjust this product, please read these instructions thoroughly.

**Spanish Quick Use Guide is included.**

**Guía para rápida consulta en español está incluida.**

VOTW000008

# Things You Should Know

## Thank you for choosing Panasonic!

You have purchased one of the most sophisticated and reliable products on the market today. Used properly, we're sure it will bring you and your family years of enjoyment. Please take time to fill in the information at right. The serial number is on the tag located on the underside of your Palmcorder. Be sure to **retain this manual** as your convenient Palmcorder information source.

Date of Purchase \_\_\_\_\_

Dealer Purchased From \_\_\_\_\_

Dealer Address \_\_\_\_\_

Dealer Phone No. \_\_\_\_\_

Model No. \_\_\_\_\_

Serial No. \_\_\_\_\_

## Unpack your Palmcorder

These accessories are provided in order to set up or use your Palmcorder.

1 pc. AC Adaptor  
(PV-A17)  
with DC Power  
Cable

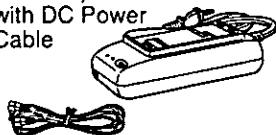

1 pc. Battery Pack  
(PV-BP15)



1 pc. Audio/Video  
Cable (VJAW0032)



1 pc. Shoulder Strap  
(VYCW0108)



1 pc. VHS PlayPak  
(PV-P1/YVMW0009)  
and one "AA" battery

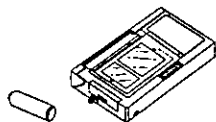

1 pc. 9-Function Remote  
(VSQW0031 or VSQW0033)  
with one CR2025 Battery



1 pc. CR2025 Clock  
Battery (VSBW0004)  
(installed in Palmcorder)



Remote has been loaded with battery and comes stored in Palmcorder. See page 22.

## Safety Precautions

**WARNING: TO PREVENT FIRE OR SHOCK HAZARD, DO NOT EXPOSE THIS EQUIPMENT TO RAIN OR MOISTURE.**

Your Compact VHS Palmcorder is designed to record and play back in Standard Play (SP) and Super Long Play (SLP) modes. You can also play a Compact VHS Palmcorder recording on your VHS VCR using the VHS PlayPak supplied.

This Palmcorder is equipped with the **HQ** System to provide excellent video pictures, and is compatible with standard VHS equipment.

It is recommended that only cassette tapes that have been tested and inspected for use in VCR machines with the **VHS** and/or **VHS** mark be used.



**CAUTION**

RISK OF ELECTRIC SHOCK  
DO NOT OPEN



CAUTION: TO REDUCE THE RISK OF ELECTRIC SHOCK,  
DO NOT REMOVE COVER (OR BACK)  
NO USER-SERVICEABLE PARTS INSIDE  
REFER SERVICING TO QUALIFIED SERVICE PERSONNEL



This symbol warns the user that uninsulated voltage within the unit may have sufficient magnitude to cause electric shock. Therefore, it is dangerous to make any kind of contact with any inside part of this unit.



This symbol alerts the user that important literature concerning the operation and maintenance of this unit has been included. Therefore, it should be read carefully in order to avoid any problems.

The above markings are located on the appliance bottom cover.

# Important Safeguards

1. **Read Instructions** — All the safety and operating instructions should be read before the unit is operated.
2. **Retain Instructions** — The safety and operating instructions should be retained for future reference.
3. **Heed Warnings** — All warnings on the unit and in the operating instructions should be adhered to.
4. **Follow Instructions** — All operating and maintenance instructions should be followed.
5. **Cleaning** — Unplug this video unit from the wall outlet before cleaning. Do not use liquid or aerosol cleaners. Use a dry cloth for cleaning.
6. **Attachments** — Do not use attachments not recommended by the video product manufacturer as they may be hazardous.
7. **Water and Moisture** — Do not use this video unit near water — for example near a bath tub, wash bowl, kitchen sink, or laundry tub, in a wet basement, or near a swimming pool, and the like.
8. **Accessories** — Do not place this video unit on an unstable cart, stand, tripod, bracket, or table. The video unit may fall, causing serious injury to a child or adult, and serious damage to the unit. Use only with a cart, stand, tripod, bracket, or table recommended by the manufacturer, or sold with the video unit. Any mounting of the unit should follow the manufacturer's instructions and should use a mounting accessory recommended by the manufacturer. An appliance and cart combination should be moved with care. Quick stops, excessive force, and uneven surfaces may cause the appliance and cart combination to overturn.



9. **Ventilation** — Slots and openings in the cabinet are provided for ventilation and to ensure reliable operation of the video unit and to protect it from overheating. These openings must not be blocked or covered. Never place the video unit on a bed, sofa, rug, or other similar surface, or near or over a radiator or heat register. This video unit should not be placed in a built-in installation such as a bookcase or rack unless proper ventilation is provided or the manufacturer's instructions have been adhered to.
10. **Power Sources** — This video unit should be operated only from the type of power source indicated on the marking label. If you are not sure of the type of power supply to your home, consult your appliance dealer or local power company. For video units intended to be operated from battery power, or other sources, refer to the operating instructions.

11. **Grounding or Polarization** — This video unit may be equipped with either a polarized 2-wire AC (Alternating Current) line plug (a plug having one blade wider than the other) or 3-wire grounding type plug, a plug having a third (grounding) pin. The 2-wire polarized plug will fit into the power outlet only one way. This is a safety feature. If you are unable to insert the plug fully into the outlet, try reversing the plug. If the plug still fails to fit, contact your electrician to replace your obsolete outlet. Do not defeat the safety purpose of the polarized plug.  
The 3-wire grounding type plug will fit into a grounding type power outlet. This is a safety feature. If you are unable to insert the plug into the outlet, contact your electrician to replace your obsolete outlet. Do not defeat the safety purpose of the grounding type plug.
12. **Power-Cord Protection** — Power-supply cords should be routed so that they are not likely to be walked on or pinched by items placed upon or against them, paying particular attention to cords of plugs, convenience receptacles, and the point where they exit from.
13. **Outdoor Antenna Grounding** — If an outside antenna or cable system is connected to the video unit, be sure the antenna or cable system is grounded so as to provide some protection against voltage surges and built-up static charges. Part 1 of the Canadian Electrical Code, in USA Section 810 of the National Electrical Code, provides information with respect to proper grounding of the mast and supporting structure, grounding of the lead-in wire to an antenna discharge unit, size of grounding conductors, location of antenna discharge unit, connection to grounding electrodes, and requirements for the grounding electrode.

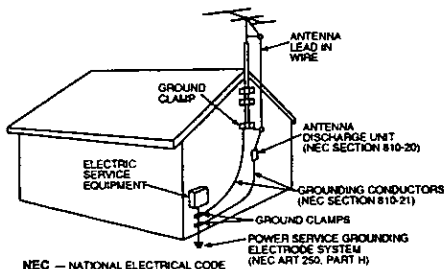

14. **Lightning** — For added protection of this video unit receiver during a lightning storm, or when it is left unattended and unused for long periods of time, unplug it from the wall outlet and disconnect the antenna or cable system. This will prevent damage to the video unit due to lightning and power-line surges.

# Important Safeguards

15. **Power Lines** — An outside antenna system should not be located in the vicinity of overhead power lines or other electric light or power circuits, or where it can fall into such power lines or circuits. When installing an outside antenna system, extreme care should be taken to keep from touching such power lines or circuits as contact with them might be fatal.
16. **Overloading** — Do not overload wall outlets and extension cords as this can result in a risk of fire or electric shock.
17. **Objects and Liquids** — Never push objects of any kind into this video unit through openings as they may touch dangerous voltage points or short out parts that could result in a fire or electric shock. Never spill liquid of any kind onto the video unit.
18. **Servicing** — Do not attempt to service this video unit yourself as opening or removing covers may expose you to dangerous voltage or other hazards. Refer all servicing to qualified service personnel.
19. **Damage Requiring Service** — Unplug this video unit from the wall outlet and refer servicing to qualified service personnel under the following conditions:
  - a. When the power-supply cord or plug is damaged.
  - b. If any liquid has been spilled onto, or objects have fallen into the video unit.
  - c. If the video unit has been exposed to rain or water.
  - d. If the video unit does not operate normally by following the operating instructions. Adjust only those controls that are covered by the operating instructions, as an improper adjustment of other controls may result in damage and will often require extensive work by a qualified technician to restore the video unit to its normal operation.
  - e. If the video unit has been dropped or the cabinet has been damaged.
  - f. When the video unit exhibits a distinct change in performance — this indicates a need for service.
20. **Replacement Parts** — When replacement parts are required, be sure the service technician has used replacement parts specified by the manufacturer or have the same characteristics as the original part. Unauthorized substitutions may result in fire, electric shock or other hazards.
21. **Safety Check**— Upon completion of any service or repairs to this video unit, ask the service technician to perform safety checks to determine that the video unit is in safe operating order.

## Precautions

### USE & LOCATION

- **TO AVOID SHOCK HAZARD ...** Your Camcorder and power supply should not be exposed to rain or moisture. Do not connect the power supply or operate your Camcorder if it gets wet. Your Camcorder has been designed for outdoor use, however it is not designed to sustain direct exposure to water, rain, sleet, snow, sand, dust, or a direct splashing from a pool or even a cup of coffee. This action could permanently damage the internal parts of your Camcorder. Do not attempt to disassemble this unit. There are no user serviceable parts inside. Unplug your Camcorder from the power supply before cleaning.
- **DO NOT AIM YOUR CAMCORDER AT THE SUN OR OTHER BRIGHT OBJECTS**
- **DO NOT LEAVE THE PALMCORDER WITH THE EVF AIMED DIRECTLY AT THE SUN AS THIS MAY CAUSE DAMAGE TO THE INTERNAL PARTS OF THE EVF**
- **DO NOT EXPOSE YOUR CAMCORDER TO EXTENDED HIGH TEMPERATURE ...** Such as, in direct sunlight, inside a closed car, next to a heater, etc... This action could permanently damage the internal parts of your Camcorder.
- **AVOID SUDDEN CHANGES IN TEMPERATURE ...** If the unit is suddenly moved from a cold place to a warm place, moisture may form on the tape and inside the unit.
- **DO NOT LEAVE YOUR CAMCORDER OR THE POWER SUPPLY TURNED ON WHEN NOT IN USE.**
- **STORAGE OF YOUR CAMCORDER ...** Store and handle your Camcorder in a manner that will not subject it to unnecessary movement (avoid shaking and striking). Your Camcorder contains a sensitive pick-up device which could be damaged by improper handling or storage.

### CARE

- **TO CLEAN YOUR CAMCORDER ...** Do not use strong or abrasive detergents when cleaning your Camcorder body.
- **TO PROTECT THE LENS ...** Do not touch the surface of the lens with your hand. Use a commercial camcorder lens solution and lens paper when cleaning the lens. Improper cleaning can scratch the lens coating.
- **TO PROTECT THE FINISH OF YOUR CAMCORDER ...** Before handling your Camcorder, make sure your hands and face are free from any chemical products, such as suntan lotion, as it may damage the finish.

## Getting Started

Things You Should Know .....	2
Important Safeguards .....	3, 4
Precautions .....	4
Quick Operation Guide .....	6
Supplying Power	
Charge the Battery Pack .....	7
Use the Battery Pack .....	7
Battery Refresh Feature .....	8
Battery Care .....	8
AC Adaptor .....	9
Car Battery Cord (Optional) .....	9
Cassette Information .....	10
Setting the Clock	
Set the Time Zone .....	11
Set the Daylight Saving Time .....	12
Set the Date and Time .....	13
Replace the Battery .....	14
Electronic Viewfinder Indications .....	15, 16, 17
Attaching the Shoulder Strap .....	18

## Basic Operation

Camera Recording	
Simple Recording .....	19
Stand-by Mode .....	20
Stand-by Release .....	20
Easy Edit Stand-by .....	21
Manual Easy Editing .....	21
9-Function Remote Control .....	22
Programmed Recording .....	23
Playback your Recordings	
Playback using the EVF .....	24
Playback using the PlayPak .....	25
Playback or View on a TV .....	26

## Special Features

Four-Speed Power Zoom .....	27
One-Touch Auto Fade .....	27
Focus .....	28
High Speed Shutter .....	29
Backlight .....	29
Intelligent Titler .....	30
Copying your Tapes (dubbing) .....	31

## For Your Information

Palmcorder Accessory System .....	32
Notes Regarding Operations .....	33
Specifications .....	34
Before Requesting Service .....	35, 36
Index of Controls .....	37, 38, 39, 40, 41
Index .....	42
Spanish Quick Use Guide/Guía Para Uso Rápido .....	43, Back Cover

# Quick Operation Guide

## Camera Recording

Charge the Battery Pack fully before operation (see page 7).

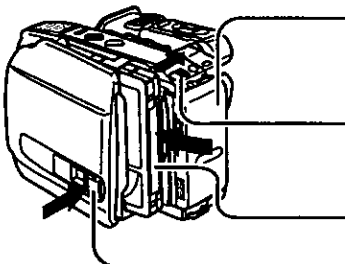
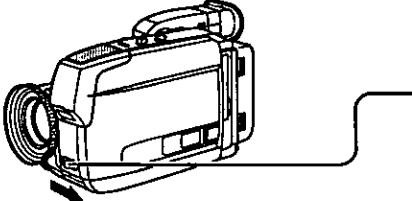
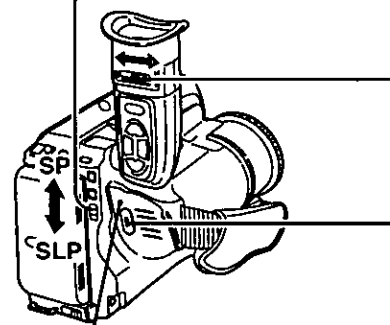
- 
- 1 Attach the Battery (see page 7).  
Make sure Battery is charged before use (see page 7).
- 2 Slide the TAPE EJECT switch to open the door.
- 3 Insert a cassette (see page 10).
- 4 Press here to close the door.
- 
- 5 Set the POWER switch to CAMERA.  
Built-In Lens Cover opens and POWER Lamp lights.
- 6 Slide the TAPE SPEED Selector for SP or SLP (see page 10).
- 7 With the Eye Cup up to your eye, adjust the Vision Adjustment Control to your eyesight.
- 
- 8 Press RECORD/PAUSE to start recording.  
Press RECORD/PAUSE again to pause recording (see page 19).
- POWER Lamp

## To Watch Playback in the EVF (Electronic Viewfinder)

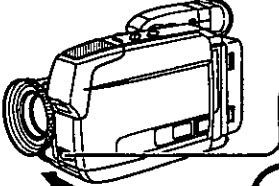
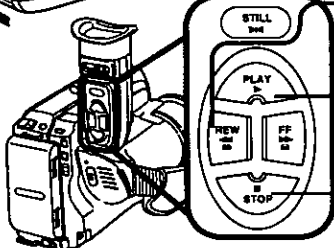
- 
- 1 Set the POWER switch to VCR.
- 
- 2 Press REWIND/SEARCH to rewind the tape.
- 3 Press PLAY to start playback.
- 4 Press STOP to stop playback.

## Charge the Battery Pack

Charge the Battery Pack fully before operation.

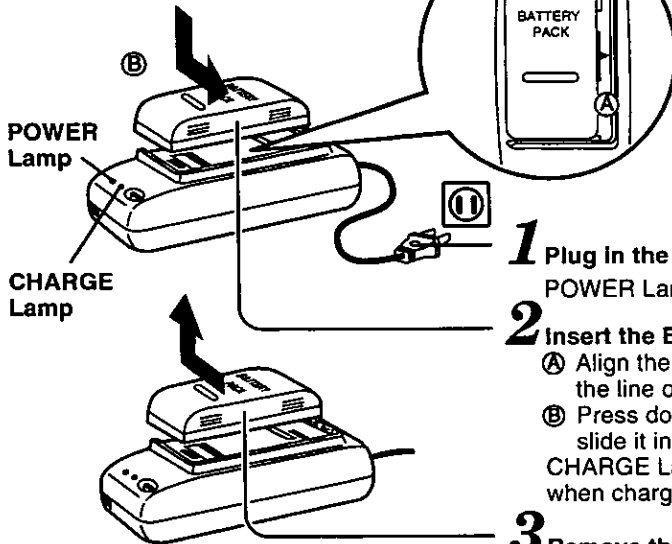

**1** Plug in the AC Adaptor.  
POWER Lamp lights up.

**2** Insert the Battery  
Ⓐ Align the right side of the Battery with the line on the AC Adaptor.  
Ⓑ Press down on the Battery and then slide it in the direction of the arrow.  
CHARGE Lamp lights up. It goes out when charging is done (about one hour).

**3** Remove the Battery  
Slide the Battery out and then lift up.

### Battery Charging Confirmation Marker



Use this marker as a reminder to yourself when the battery is fully charged or in need of a charge. This marker performs no function and is for your reference only.

• The useful operation time of the Battery will gradually decrease after repeated use and recharging. The Battery is no longer serviceable if the operation time is very short, even after a sufficient charge.

### Note:

After recharging the Battery Pack about 5 times, use the BATTERY REFRESH feature as explained on page 8.

## Use the Battery Pack

With a fully charged Battery Pack, you will have a maximum of about one hour of continuous use.

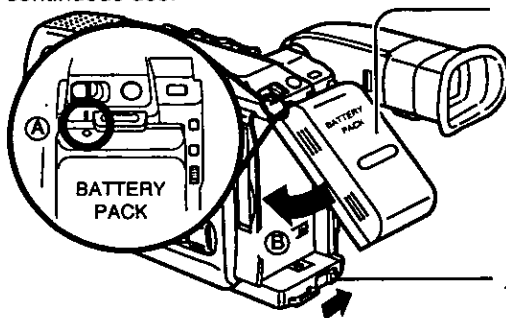

**1** Attach the Battery  
Ⓐ Align the Battery with the top of the mounting surface.  
Ⓑ Press it into place until it locks with a click.

**2** Remove the Battery  
While sliding the BATTERY RELEASE button, remove the Battery.

# Supplying Power

## Battery Refresh Feature

This feature completely discharges the Battery before recharging begins. To maintain your battery's operating capacity, use the refresh feature after about every five charges.

CHARGE Lamp



**1** Plug in AC Adaptor.

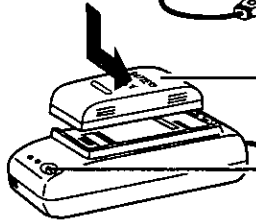

**2** Place the Battery into the AC Adaptor.

**3** Press the BATTERY REFRESH button. The CHARGE Lamp will flash when discharging begins and stop flashing when fully discharged. POWER Lamp will stay lit when fully charged.

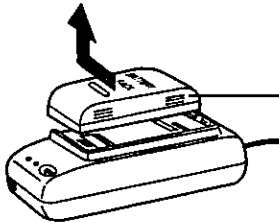

**4** Remove the Battery

- Should you accidentally press the BATTERY REFRESH button, remove Battery and then re-insert it to begin charging.
- It takes about five hours when both Battery Refresh and charging are performed.

ONLY FOR U.S.A.

### ATTENTION:



The product that you have purchased is powered by a rechargeable battery. The battery is recyclable. At the end of its useful life, under various state and local laws, it may be illegal to dispose of this battery into the municipal waste stream. Check with your local solid waste officials for details in your area for recycling options or proper disposal.

## Battery Care

### Caution:

- Charge only with specified charger.
- The Battery can be charged within a temperature range of 32° F (0° C) and 104° F (40° C).
- The Battery may be warm after charging or just after use. This is normal.
- Do not use an insufficiently charged or worn out Battery.

### Safety precautions:

- Do not get the Battery near, or dispose of in fire.
- Do not directly connect (short circuit) the positive (+) and negative (-) terminals.
- Never attempt to disassemble or reassemble the Battery.

### To avoid damage to the Battery:

- Do not drop or jar the Battery.
- Use the Battery with specified units only.
- If the Battery is used in extremely high temperatures, a safety device will automatically prevent operation.

### To insure longer battery life:

- While not in use, remove Battery from the Palmcorder and AC Adaptor and store in a cool, dark, dry place.
- Keep the Battery terminals clean.



## AC Adaptor

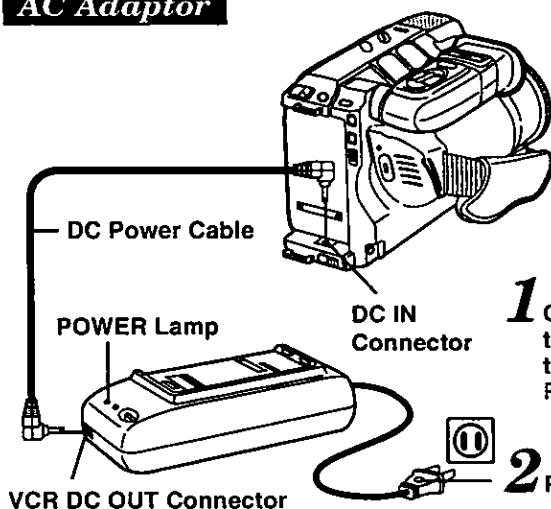

**1** Connect the VCR DC OUT on the AC Adaptor to the DC IN on the Palmcorder with the DC Power Cable (supplied).

**2** Plug in the AC Adaptor.

- The POWER Lamp will light up.

### Note:

- AC Adaptor can not be used to power the Palmcorder while charging the Battery.
- While not in use, unplug the AC Adaptor from the AC outlet. (AC Adaptor consumes 1.2W of electric power if it is plugged into an AC outlet even when not in use.)

## Car Battery Cord (Optional)

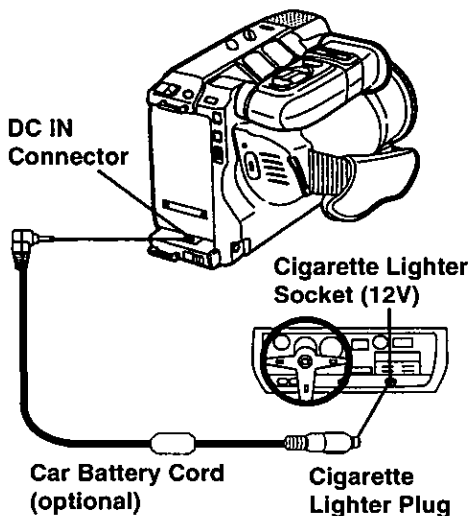

**1** Connect a PV-C16 Car Battery Cord (optional) to the DC IN of the Palmcorder.

**2** Start your car engine and then insert the Car Battery Cord plug into your cigarette lighter socket.

- There is a fuse located in the lighter plug end of the cord.  
Should fuse replacement be necessary use the exact current rating (in amps).

### Note:

- This cord can only be used in vehicles equipped with DC 12V (negative ground) batteries. Use only the specified car battery cord. If you are not sure check with your local car/truck dealer as to what type of DC battery ground you have in your vehicle.
- Be sure to start your car engine before inserting the cigarette lighter plug of the Car Battery Cord into the lighter socket; otherwise, the cigarette lighter plug fuse may burn out.
- Because the car is running while your Palmcorder is in operation, make sure you're in a well ventilated area.
- Disconnect the cigarette lighter plug when your Palmcorder is not being used.

# Cassette Information

## Cassette Insertion/Removal

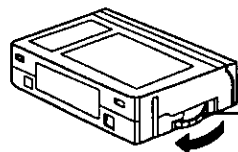

**1** Turn the Tape Wheel in the direction of the arrow until there is no slack.

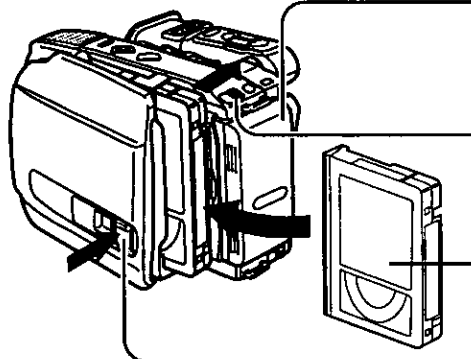

**2** Attach the Battery (see page 7).

**3** Slide the TAPE EJECT switch to open the door.

**4** Insert the cassette vertically with its window side facing out.

**5** Press here to close the door.

• To remove the cassette, slide the TAPE EJECT switch.

## Record/Playback Time

Use tapes with the **VHS-C** mark in this unit.

Tape Speed Selector Position	Cassette type		
	T-20	T-30	T-40
SP (Standard Play)	20 minutes	30 minutes	40 minutes
SLP (Super Long Play)	1 hour	1 hour 30 minutes	2 hours

TAPE SPEED Selector

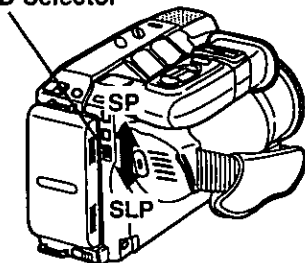

- SP provides the best picture.
- SLP has slightly more picture noise during playback.

## Erase Protection Tab

Cassettes have a record tab to ensure that recordings are not accidentally erased.

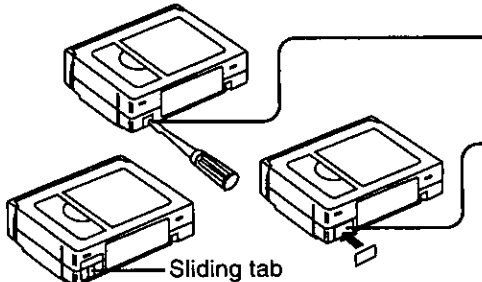

**1** To prevent accidental erasure  
Break off the tab with a screwdriver.  
(Or, slide tab open.)

**2** To record again  
Cover the hole with adhesive tape.  
(Or, slide tab closed.)

Setting the clock is divided into three sections; Set the Time Zone, Set the Daylight Saving Time, and Set the Date and Time. Please follow instructions in the order presented.

## Set the Time Zone

The Palmcorder is set to the Eastern Standard time zone at the factory. If you live in a different time zone, follow the steps below to change it. Then, when traveling, rather than resetting the clock to the local time, you can simply set the appropriate time zone.

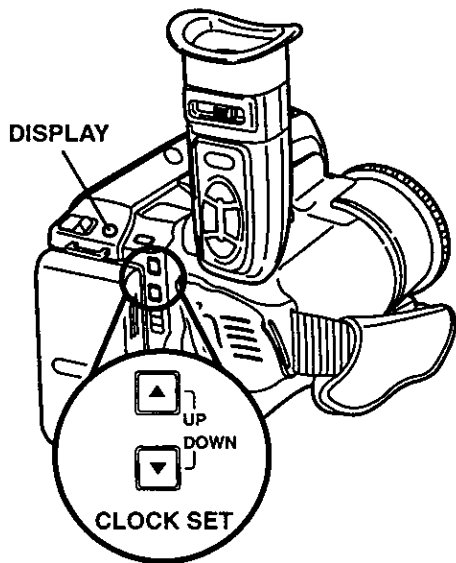

Time Zone chart

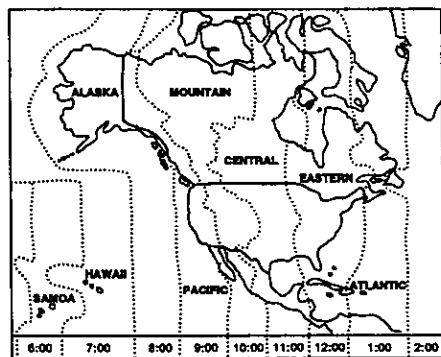

## Before you begin...

- Connect the Palmcorder to a power source.
- Set the POWER switch to VCR or CAMERA.

### Note:

CLOCK SET menu disappears if, after activation, CLOCK SET UP ▲, DOWN ▼ or DISPLAY buttons are not pressed within 30 seconds.

The Palmcorder's clock may lose or gain up to two minutes per month. Please adjust as necessary (refer to page 13).

- 1 Press **CLOCK SET UP ▲** to display the CLOCK SET menu.
- 2 Press **UP ▲** or **DOWN ▼** repeatedly to select **1.SELECT TIME ZONE** from the CLOCK SET menu.

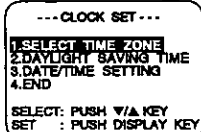

- 3 Press **DISPLAY** to display the SELECT TIME ZONE menu.
- 4 Press **UP ▲** or **DOWN ▼** repeatedly to select one of the eight time zones of the location where you are using the Palmcorder.

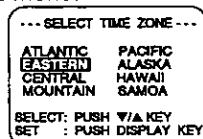

- 5 Press **DISPLAY** to fix the Time Zone. The CLOCK SET menu appears.

To exit from the **CLOCK SET** menu, select **4.END** and press **DISPLAY**.

### Note:

When you travel outside the eight time zones right, please set the clock manually (see page 13).

# Setting the Clock

## Set the Daylight Saving Time

The clock will automatically adjust to daylight saving time.

Daylight Saving Time is preset to **AUTO**. If you do not want the clock to automatically adjust to daylight saving time, please select **OFF** by following steps 1-5 below.

## Before you begin...

- Connect the Palmcorder to a power source.
- Set the POWER switch to VCR or CAMERA.

### Note:

CLOCK SET menu disappears if, after activation, CLOCK SET UP ▲, DOWN ▼ or DISPLAY buttons are not pressed within 30 seconds.

This feature will not function if Hawaii or Samoa Time Zone is selected.

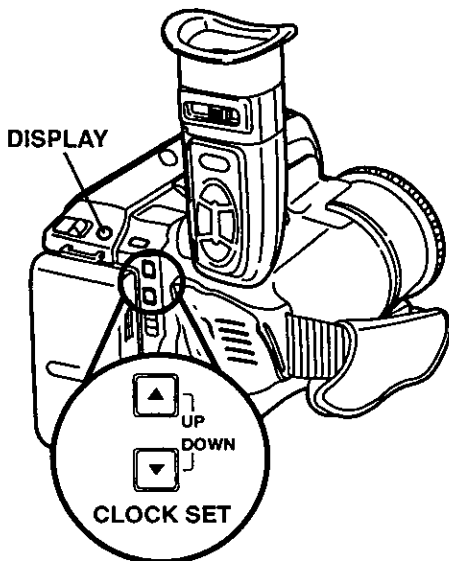

- 1** Press **CLOCK SET UP ▲** to display the **CLOCK SET** menu.
- 2** Press **UP ▲** or **DOWN ▼** repeatedly to select **2.DAYLIGHT SAVING TIME** from the **CLOCK SET** menu.

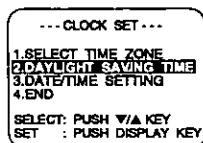

- 3** Press **DISPLAY** to display the **DAYLIGHT SAVING TIME** menu.

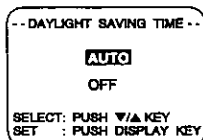

- 4** Press **UP ▲** or **DOWN ▼** to select **AUTO** or **OFF**.

- 5** Press **DISPLAY** to fix the **DAYLIGHT SAVING TIME** setting. The **CLOCK SET** menu appears.

To exit from the **CLOCK SET** menu, select **4.END** and press **DISPLAY**.

### Spring:

First Sunday in April (**DAYLIGHT SAVING TIME: AUTO**) Automatically adds one hour and adjusts the clock.

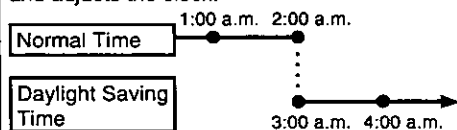

### Autumn:

Last Sunday in October (**DAYLIGHT SAVING TIME: AUTO**) Automatically turns back one hour and adjusts the clock.

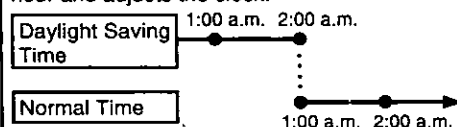

# Setting the Clock

## Set the Date and Time

The date and time is calculated, including leap year, up to DEC 31 2094.

### Before you begin...

- Connect the Palmcorder to a power source.
- Set the POWER switch to VCR or CAMERA.

#### Note:

CLOCK SET menu disappears if, after activation, CLOCK SET UP ▲, DOWN ▼ or DISPLAY buttons are not pressed within 30 seconds.

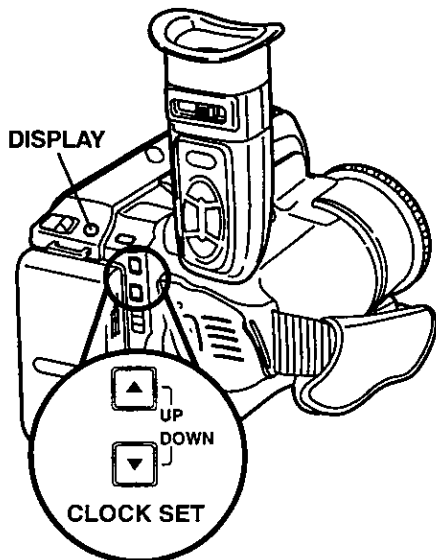

**1** Press **CLOCK SET UP ▲** to display the **CLOCK SET** menu.

**2** Press **UP ▲** or **DOWN ▼** repeatedly to select **3.DATE/TIME SETTING** from the **CLOCK SET** menu.

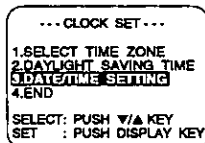

**3** Press **DISPLAY** to display the **DATE/TIME SETTING** menu.

**4** Press **UP ▲** or **DOWN ▼** repeatedly (or hold down) to enter the desired numbers, then, press **DISPLAY** to fix that portion and move to the next.

Adjust the flashing digits for the hour, minute, month, day and year.

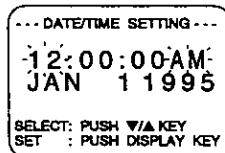
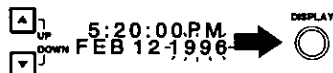
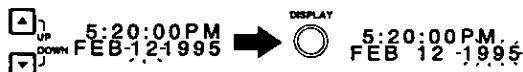
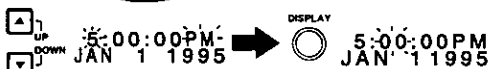

When you finish setting the year, the clock starts operating, and the **CLOCK SET** menu appears.

To exit from the **CLOCK SET** menu, select **4.END** and press **DISPLAY**.

# Setting the Clock

## Replace the Battery

The date and time operates on a miniature battery preinstalled in the underside of your Palmcorder.

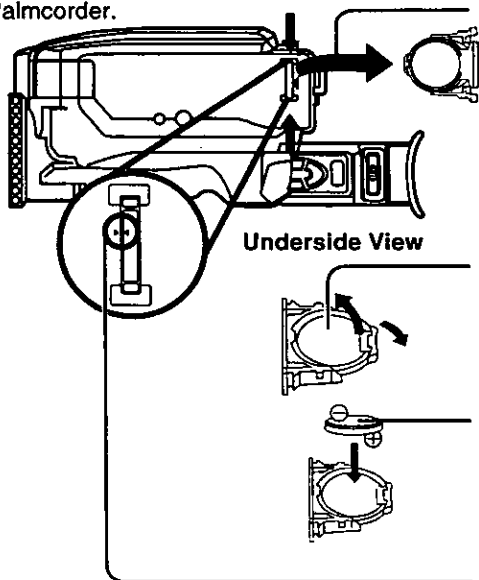

**1** While pinching the stopper tabs, pull the tray out of the Battery Compartment.

**2** Remove the Battery by bending the locking tab outward.

**3** Place the new Battery into the Battery tray with the ⊕ mark facing down until it snaps into place.  
• Do not reverse the polarity.

**4** Replace the Battery tray so that the small triangle marks meet.

Replace battery with Panasonic PART NO. VSBW0004 (CR2025) only. Use of another battery may present a risk of fire or explosion. Caution-battery may explode if mistreated. Dispose of used battery promptly. Keep away from children. Do not recharge, disassemble or dispose of in fire.

### Note:

- Make sure your Palmcorder is off when replacing the Battery.
- Keep the Battery out of the reach of children since swallowing it may be harmful.
- When the Battery is installed improperly, is discharged, or missing, "CLOCK BATTERY" appears in the EVF.
- Battery life is approximately 5 years.

# Electronic Viewfinder Indications

## Tape/Battery Remaining

The tape remaining and battery charge level can be displayed during recording.

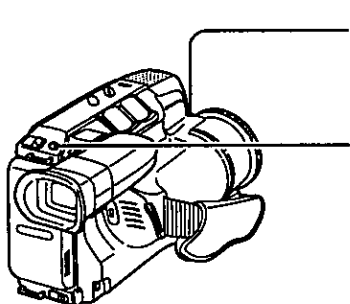

**1** Set the POWER switch to CAMERA.

**2** Press DISPLAY repeatedly to select the desired display.

## EVF Indications

Battery Charge Remaining:

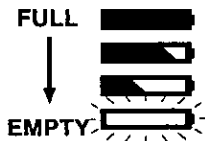

Tape Remaining:

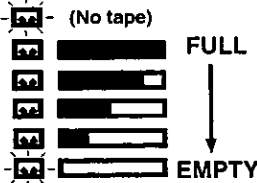

• It will take several seconds for the tape remaining indicator to operate after the tape starts moving.

(Initial screen)

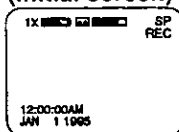

First press

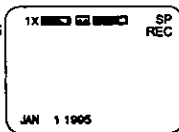

Fourth press

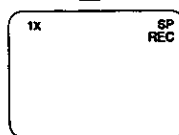

Second press

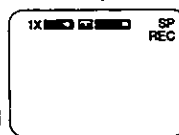

Third press

## Record the Date and Time

**1** Set the POWER switch to CAMERA. When placed in Record mode, the time and date will be recorded on the tape.

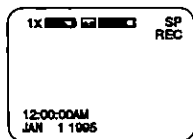

**2** Press DISPLAY once to change the display to date only. Press once or twice more to remove the date/time display.

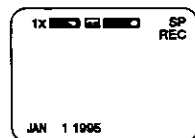

**Note:** Only the Date and/or Time are recorded on the Tape.

## Display-Off Mode

This feature allows you to remove all Electronic Viewfinder Indications.

Before inserting a tape, press DISPLAY and STOP together for more than one second to remove the indications except time and date\*.

To display the Electronic Viewfinder Indications again, turn the Palmcorder Power off and then on again.

\* To remove the time and date, see "Record the Date and Time" above.

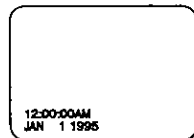

# Electronic Viewfinder Indications

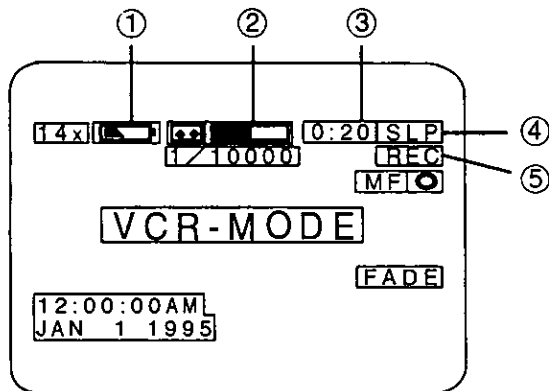

## ① Battery Remaining Indication (see page 15)

 When a battery recharge is necessary, "WARNING" will begin to flash in the EVF and "LOW BATTERY" will appear as the Power Lamp will also flash. The Palmcorder will automatically turn OFF in 15 seconds.

## ② Tape Remaining Indication

- If the Palmcorder is in camera mode with no cassette tape inserted or the record tab is missing, "⏏" will flash for one minute and "CHECK TAPE" will appear for 5 seconds, and recording will not start.
- While recording, as the tape reaches to the end, "TAPE END" will appear for 5 seconds as a warning.

## ③ 10-Second Reminder

An elapsed time indicator appears for one second every 10 seconds that recording continues.

This is a reminder of how long you have been shooting a particular scene and can help keep your recordings fresh and interesting.

0:00 0:10 0:20 . . . . . 59:50

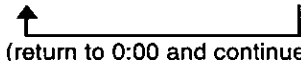

(return to 0:00 and continue)

- The 10-Second Reminder will be reset whenever you press Record/Pause.

## ④ TAPE SPEED Indication (see page 10)

Indicates the tape speed (SP or SLP).

## ⑤ Operating Mode Indications

**REC** (record)

(RECORD will first appear in large characters for one second and then small characters.)

**PAUSE**

(PAUSE will first appear in large characters for one second and then small characters.)

**FF** (fast forward)

**PLAY**

**REW** (rewind)



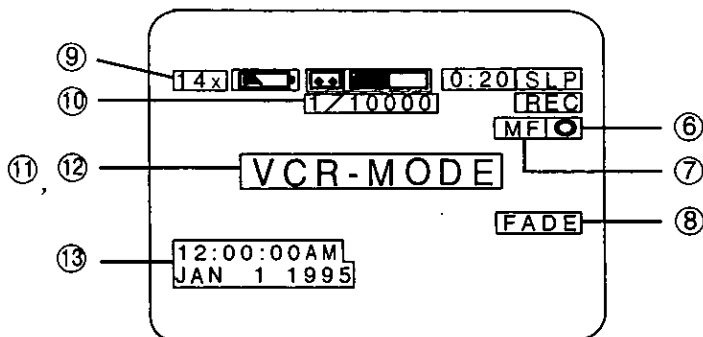

- ⑥ **Backlight Indication** (see page 29).
- ⑦ **Manual Focus Indication** (see page 28).
- ⑧ **Fade Indication** (see page 27).
- ⑨ **Zoom Magnification level** (see page 27).
- ⑩ **High Speed Shutter Indication** (see page 29).
- ⑪ **VCR-MODE Indication**  
"VCR-MODE" will appear for one minute if the POWER switch is set to VCR or the RECORD/PAUSE button is pushed in VCR MODE.
- ⑫ **DEW Indication**  
If excessive moisture condenses in the unit, "WARNING" and Power Lamp will flash, "DEW DETECTED" will appear, and the Palmcorder will automatically turn OFF in 15 seconds.  
In this case, wait until the indicator no longer flashes when your Palmcorder is turned on before using your Palmcorder again.
- ⑬ **Date and time Indication** (see page 13).

# Attaching the Shoulder Strap

Make sure the Battery Pack is not attached.

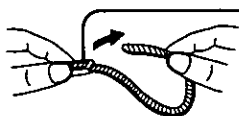

**1** Unthread the strap from the buckle.

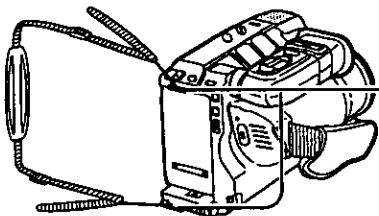

**2** Thread the strap ends through the Strap Attachment Rings.

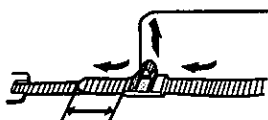

min. 1 inch

**3** Then thread the ends of the strap through the buckle.

• Make sure the strap is not twisted.

## Adjust the Length

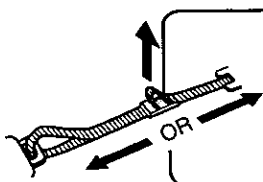

**1** Pull a loop of the strap loose from the buckle.

**2** Pull the strap firmly through the buckle to adjust the length.

## Hand Strap

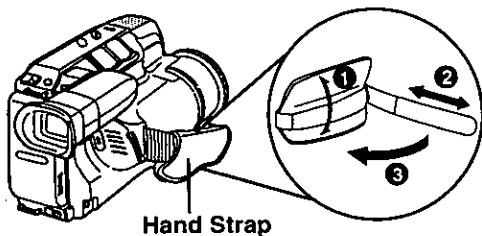

Hand Strap

Adjust the length of the strap to the size of your hand as illustrated at left.

## Simple Recording

### Before you begin...

- Connect the Palmcorder to a power source.
- Insert a cassette with record tab (see page 10).

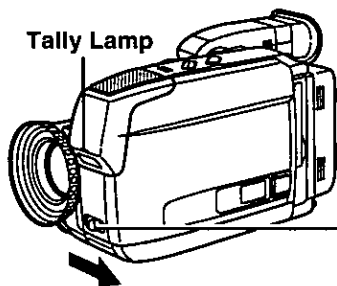

- 1** Set the **POWER** switch to **CAMERA**.  
Built-In Lens Cover opens.

EVF

PAUSE

Record/Pause mode.

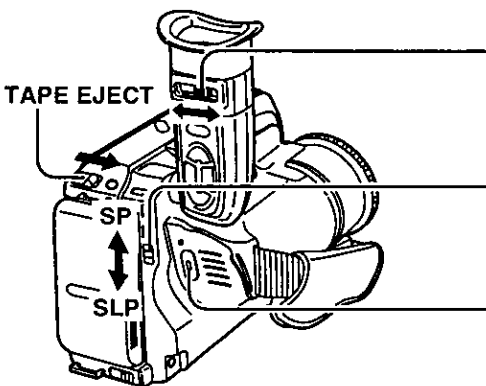

- 2** With the Viewfinder Eye Cup up to your eye, adjust the Vision Adjustment Control to your eyesight.

- 3** Slide the **TAPE SPEED** Selector to **SP** or **SLP** (refer to page 10).

- 4** Press **RECORD/PAUSE** to start recording.  
The Tally Lamp and **RECORD/PAUSE** are lit during recording.

RECORD

Press **RECORD/PAUSE** again to pause recording.

Set the **POWER** switch to **OFF** after recording is finished.

- **To remove the cassette**  
In Record/Pause mode, slide the **TAPE EJECT** switch (refer to page 10).

### Note:

- Do not leave the Palmcorder with the EVF aimed directly at the sun as this may cause damage to the internal parts of the EVF.

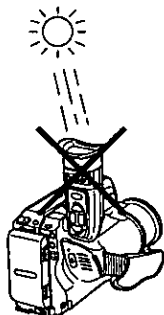

- When your Palmcorder is aimed at excessively bright objects, or bright lights, a vertical bar may appear in the picture. This is a normal characteristic of the CCD pick-up device. Try to avoid this when possible.

# Camera Recording

## Stand-by Mode

Whenever the Palmcorder has been in Record/Pause mode for 5 minutes, it will automatically go into Stand-by mode to conserve power. To resume recording, it is necessary to turn the Palmcorder POWER switch to OFF and then to CAMERA. Or, you may use the following feature to avoid having to turn the Palmcorder off and on again.

## Stand-by Release

This feature allows you to resume recording from Stand-by mode by simply pressing the RECORD/PAUSE button.

## Before you begin...

- Connect the Palmcorder to a power source.
- Insert a cassette with record tab (see page 10).

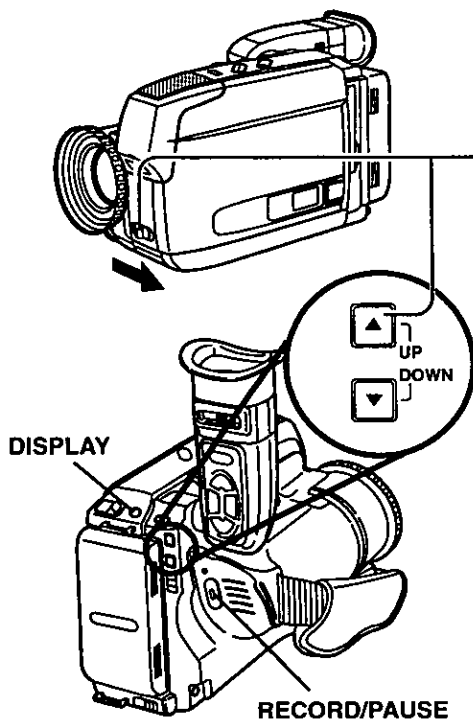

**1** While pressing the UP ▲ button, set the POWER switch to CAMERA.

**2** Press UP ▲ more than 2 seconds to display the STAND-BY RELEASE selection screen.

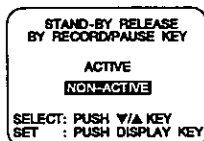

**3** Press UP ▲ or DOWN ▼ as necessary to select **ACTIVE**.

**4** Press DISPLAY to set your selection and exit this screen.

- You may now turn the Palmcorder back on after it has gone into Stand-by mode by pressing the RECORD/PAUSE button.

## Note:

If **NON-ACTIVE** was selected in step 3 above, you must set the POWER switch to OFF and then to CAMERA to resume recording from Stand-by mode.

## Easy Edit Stand-by

If you stop recording but plan to resume within 24 hours, use the Edit Standby feature to make a smooth transition between scenes.

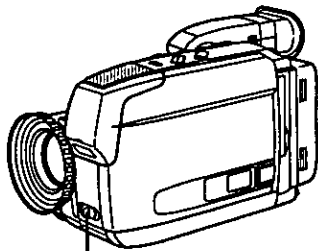

POWER Switch

## Manual Easy Editing

For proper continuity when taping from the Stop mode, or after changing the Battery Pack.

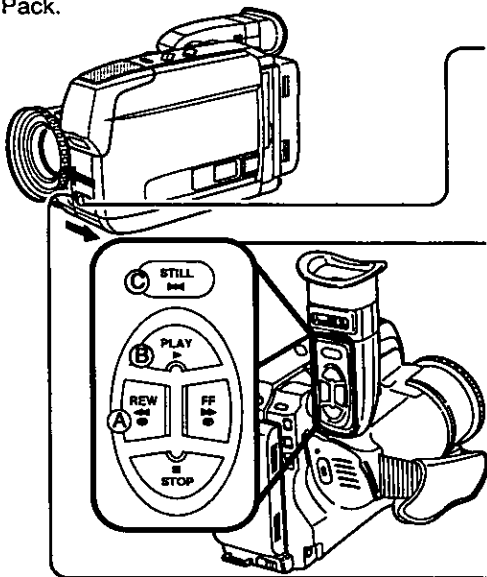

**1** Set the POWER switch to VCR.

- 2**
- A** Press **REWIND/SEARCH** to go back a few seconds on the tape.
  - B** Press **PLAY** to review the picture on the Viewfinder.
  - C** Press **STILL** at the location you wish to continue your recording.

**3** Set the POWER switch to CAMERA.

**4** Press **RECORD/PAUSE** to continue recording.

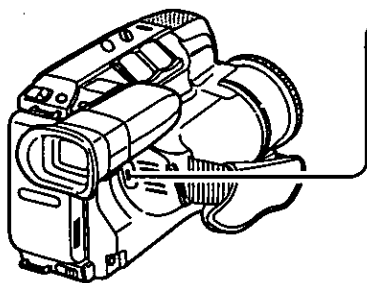

# 9-Function Remote Control

## Removing and Storing the Remote

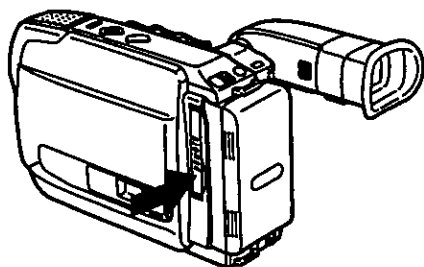

**To remove,**  
press in on the Remote as shown by the arrow and it will release.

**To store,**  
insert the Remote into the slot, the function buttons may face in either direction, press the remote control until it locks into place, as shown by the arrow.

## Remote Control Operation

Operate the major functions of your Palmcorder from up to 16 feet (5 m) (approx.) away. Aim the Remote Control at the Remote Sensor of the Palmcorder and press the desired buttons.

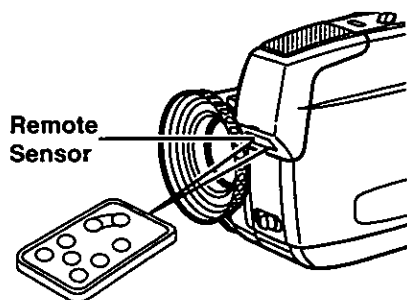

### Controlled Functions

- Rec/Pause (see page 19)
- T (telephoto) Zoom
- W (wide angle) Zoom
- Play (see page 24)
- Fast Forward/Search (see page 24)
- Rewind/Search (see page 24)
- Stop (see page 24)
- Still (see page 24)
- Programmed Recording (see page 23)

### Important Note:

- After 5 minutes in the Rec/Pause mode, the Palmcorder will shut off to conserve battery life. If within 30 minutes, press REC/PAUSE down for about one second, the Palmcorder comes back on and goes into the Record mode. If it is longer than 30 minutes before you resume recording, set the POWER switch to OFF and then to CAMERA.

## Replace the Battery

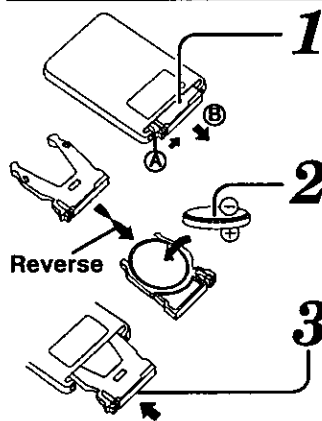

- 1 While pressing the stopper tab, pull the Battery Tray out.

- 2 Insert the battery into the Battery Tray with the ⊕ mark facing down.  
Do not reverse the polarity.

- 3 Replace the Battery Tray.

Replace battery with Panasonic PART NO. VSBW0004 (CR2025) only. Use of another battery may present a risk of fire or explosion. Caution-battery may explode if mistreated. Dispose of used battery promptly. Keep away from children. Do not recharge, disassemble or dispose of in fire.

# Programmed Recording

## Programmed Recording

You can program when to start and stop the recording just like the Stand-by OTR on a VCR deck. This is very convenient when you record something like a blooming flower while you are out. You can also use an interval recording. Two recording lengths, 5-second per minute or 10-second per minute, are available.

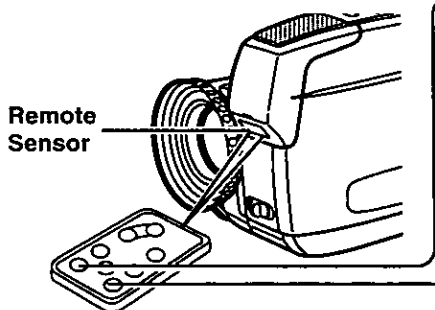

## Before you begin...

- Connect the Palmcorder to a power source. For extended periods of recording, it is recommended to use the AC Adaptor for a power source.
- Insert a cassette with record tab (see page 10).
- Set the POWER switch to CAMERA.

- 1** Aim the Remote Control at the Remote Sensor and press **STANDBY** on the Remote repeatedly until the desired time to start will appear. Start time will increase 30 minutes.

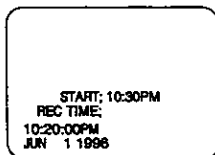

- 2** Press **OTR** on the Remote repeatedly to select desired recording length.

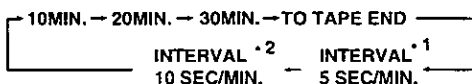
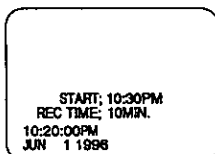

\*1 5-second recording will be made each minute.

\*2 10-second recording will be made each minute.

- 3** After setting, press **REC/PAUSE** on the Remote to go into stand-by mode.

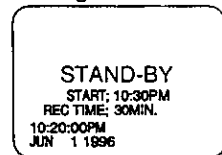

The Palmcorder will start recording at the desired timing. When the recording finishes, the Palmcorder will turn off automatically.

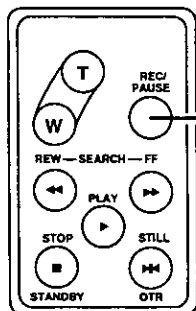

## Note:

- Palmcorder will automatically turn off after 12 hours from recording start time or at tape end.
- Set the POWER switch to OFF to cancel the Programmed Recording feature.

# Playback your Recordings

## Playback using the EVF

### Before you begin...

- Connect the Palmcorder to a power source.
- Insert a recorded cassette.

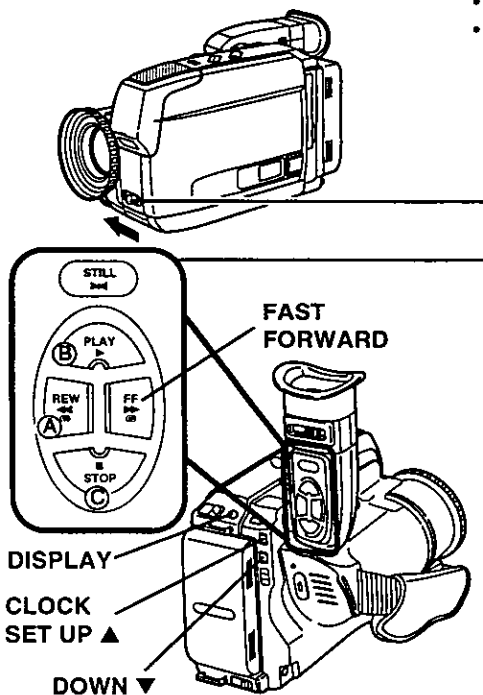

**1** Set the POWER switch to VCR.

- 2**
- Ⓐ Press **REWIND/SEARCH** to rewind the tape.
  - Ⓑ Press **PLAY** to start playback.
  - Ⓒ Press **STOP** to stop playback.

### Auto Play

When the POWER switch is set to VCR, the cassette will automatically begin playback if the record tab has been removed.

### Helpful Note:

#### Search Speed

Standard Play (SP) Search is about 3 times the normal speed, and Super Long Play (SLP) Search is about 9 times the normal speed.

## Special Effects Playback

(Sound is Muted)

### Rapidly Locate a Scene

Press **FAST FORWARD/SEARCH** or **REWIND/SEARCH** for rapid visual search. Press again, or press **PLAY** to resume normal speed.

### View a Still Picture

Press **STILL** to freeze the playback picture. Press again to resume normal playback.

### Note:

- During search playback, horizontal noise bars will appear and there will be no audio.
- To protect the tape and video heads, your Palmcorder's operating modes will revert as follows:  
STILL → STANDBY after 5 minutes.  
STANDBY → POWER OFF after 5 minutes when using a Battery Pack.
- When the tape reaches its end during playback, or fast forward, it will rewind automatically.

## Tracking Control

### Auto Tracking

Continuously analyzes the signal of each recording for optimum picture quality.

### Manual Tracking

To minimize the noise in some recordings, manual tracking may be necessary.

### In Playback mode:

Press **CLOCK SET UP ▲** or **DOWN ▼** until picture clears.

Press **DISPLAY** to return to Auto Tracking.

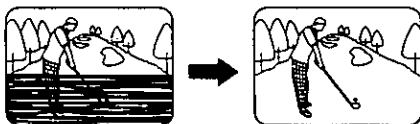



# Playback your Recordings

## Playback using the PlayPak

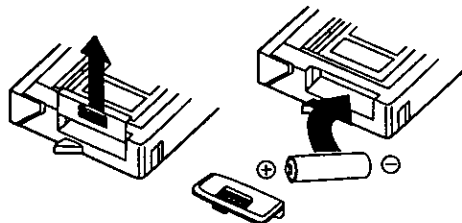

Remove the Battery Compartment lid and insert the AA size battery.

- Make sure polarities are aligned properly.
- When tape loading and unloading time becomes longer than normal, battery replacement is necessary.

## Insert VHS Cassette

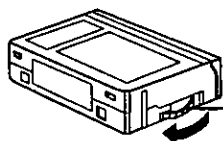

**1** Turn the Tape Wheel on the **VHS** cassette in the direction of the arrow to reduce any slack.

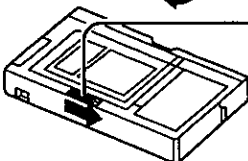

**2** Slide the **RELEASE** button in the direction of the arrow to open the PlayPak door.

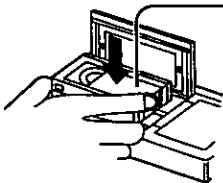

**3** Insert the **VHS** cassette with the window facing up and to the left. Then, snap the lid shut.

- Let the Load Detector fully retract before using the PlayPak in your standard VHS VCR.
- Be sure the cassette reel area under the PlayPak is free to turn while loading.

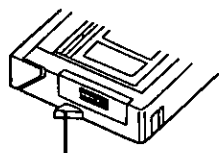

Load Detector

## Remove VHS Cassette

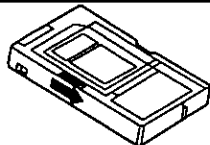

**1** Slide the **RELEASE** button and wait for the lid to open.

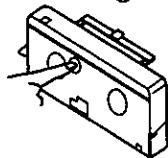

**2** Hold the PlayPak securely in one hand. Put your finger through the hole in the bottom of the PlayPak and push the cassette out.

# Playback your Recordings

## Playback or View on a TV

Your Palmcorder may be connected to a TV to play back tapes or to view what you are recording.

### TV with AUDIO/VIDEO IN Jacks.

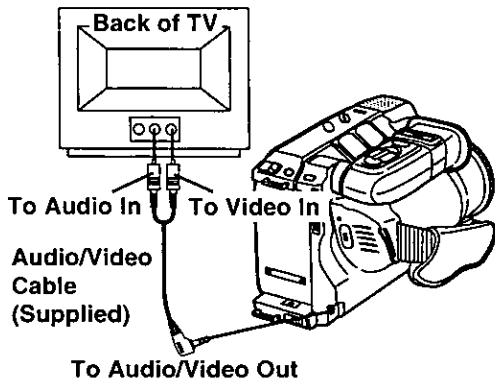

### TV without AUDIO/VIDEO IN Jacks.

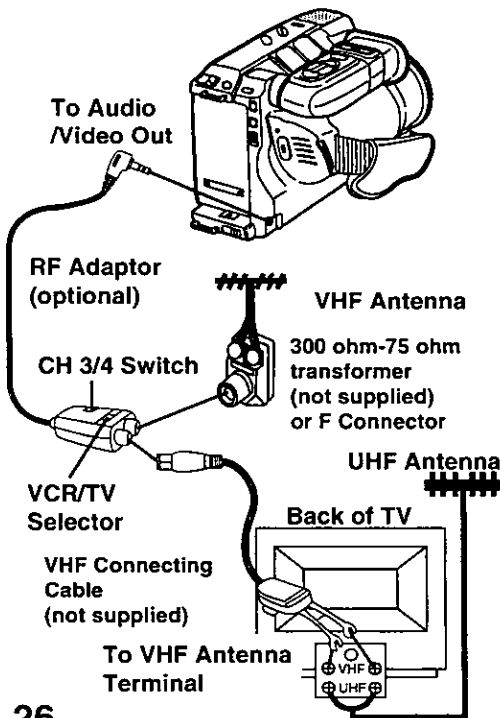

## Before you begin...

- Connect the Palmcorder to a power source.

**1** Set the **POWER** switch to **VCR** to playback a tape.  
Or, set to **CAMERA** to view what your Palmcorder is recording.

**2** Turn the TV **ON** and set it to **LINE INPUT**.  
Check your TV operating instructions for further information.

### Note:

If your TV has no **VIDEO** or **AUDIO IN** Jacks, select **CH 3** or **4** on your TV to match the **RF Adaptor CH 3/4** switch and set the **VCR/TV** selector on the **RF Adaptor** to **VCR**.

**3** Start playback or begin a recording.

## To watch TV only

If you have connected the Palmcorder to your TV using an **RF Adaptor**:  
Set the **POWER** switch to **OFF** on the Palmcorder.

Then, set the **VCR/TV** Selector on the **RF Adaptor** to **TV**.

Now, turn the TV **ON** and select a channel.

## CATV System Installer

This reminder is provided to call the CATV system installer's attention to Article 820-40 of the NEC in USA (and to the Canadian Electrical code in Canada) that provides guidelines for proper grounding and, in particular, specifies that the cable ground shall be connected to the grounding system of the building, as close to the point of cable entry as practical.

# Special Features

## Four-Speed Power Zoom

You can gradually zoom in for close ups or zoom out for wide angle shots.

The zooming speed ranges from a slow speed of 15 seconds to a fast 3.5 seconds according to the pressure applied to the zoom buttons.

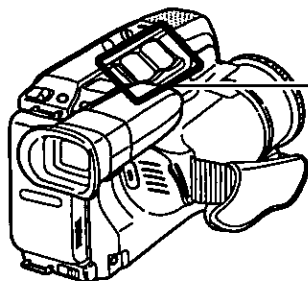

### Zoom In ("T")



### Zoom Out ("W")

Zoom slowly by lightly pressing the "T" (Telephoto) or the "W" (Wide Angle) side of the POWER ZOOM switch.

Zoom quickly by applying more pressure.

- The magnification level is displayed in the EVF.

## One-Touch Auto Fade

This feature allows you to make smoother scene transitions for a professional look.

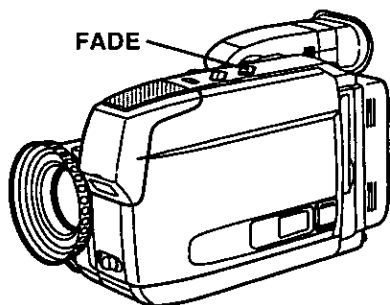

### Fade In:

Starting the first scene with "fade in" is very effective.

- 1** Press **FADE** in Record/Pause mode so that "FADE" flashes in the EVF.
- 2** Press **RECORD/PAUSE** to start recording. The picture and sound fade out, and then will gradually fade in.

### Fade Out:

Use to create a soft ending or, when used together with fade in, a soft transition from one scene to the next.

- 1** Press **FADE** so that "FADE" flashes in the EVF while recording.
- 2** Press **RECORD/PAUSE** to pause recording. The picture and sound gradually fade out.

If **FADE** is accidentally pressed, press again so that "FADE" disappears in the EVF.

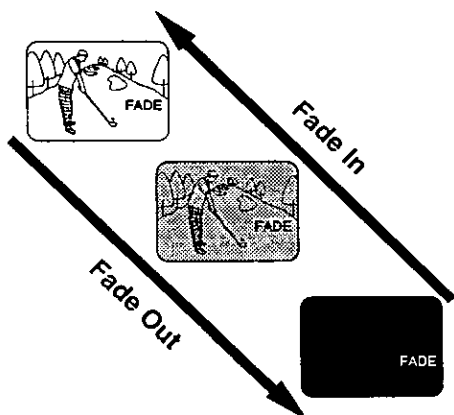

# Special Features

## Auto Focus

The Palmcorder will automatically bring the subject into focus even during zooming.

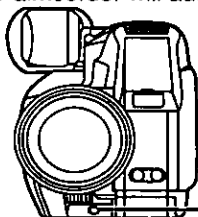

For Auto Focus mode, it may be necessary to **press FOCUS A/M**, so that "MF" does not appear in the EVF.

## Manual Focus

Use Manual Focus (MF) when recording ...

- a subject through glass.
- a scene where the subject is far from the Palmcorder and there are objects in the foreground.
- a subject with distinct horizontal stripes.
- a subject not centered in the Viewfinder.
- subjects with shiny surfaces.

- an obliquely angled subject.
- a bright, flat subject such as a white wall.
- in low light situations.
- a scene with fast motions, like a golf swing.
- **Re-focusing may be required** when your Palmcorder is aimed at a new scene.

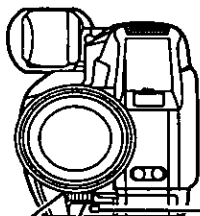

- 1** Press **FOCUS A/M** so that "MF" (Manual Focus) appears in the EVF.

EVF Indication

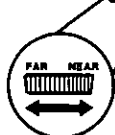
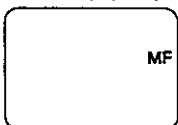

- 2** Press and hold the "T" side of the **POWER ZOOM** switch until the lens is zoomed in all the way (subject at maximum size).

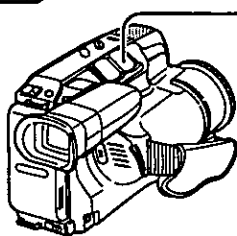

- 3** Turn the **FAR/NEAR** dial until the picture is in focus.
  - It may be necessary to back away from the subject to focus the image properly.

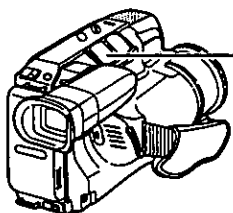

- 4** Press the "W" side of the **POWER ZOOM** switch to frame the picture as desired.

## Macro Focus (for close-ups)

Auto Focus will function down to 1/2 inch (12.7mm) in front of the lens.

Press the "W" side of the **POWER ZOOM** switch to the wide angle position. Then, bring the Palmcorder as close to the subject as necessary.

## High Speed Shutter

To record high speed motion (i.e. a tennis stroke) for improved STILL or SLOW mode playback, when watching the tape on a VHS VCR (3 or 4 head VCR).

## Auto Shutter

In the AUTO mode (no indication in the EVF), the Palmcorder will automatically adjust the shutter speed from 1/60 to 1/250 according to the brightness of the subject. The speed does not appear in the EVF.

- AUTO mode is automatically selected whenever the POWER switch is set to CAMERA.

## Manual Selection

The High Speed Shutter indicator flashes when the light level is inadequate. More light should be provided to achieve better picture quality and color.

Press HIGH SPEED SHUTTER while recording.

Press repeatedly to obtain one of the eight higher shutter speeds shown at right.

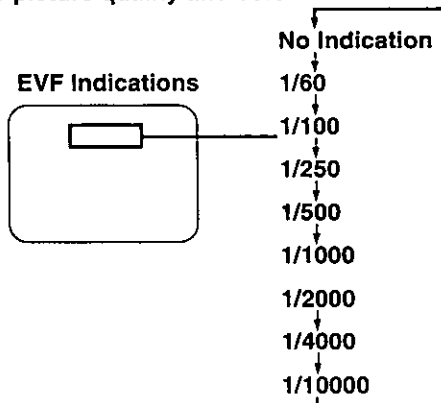
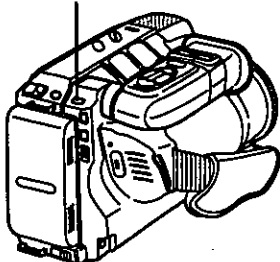

### Note:

- For proper color reproduction, it is recommended that you use this feature outdoors. For indoor High Speed Shutter recording, additional halogen or tungsten light should be provided. Fluorescent light will degrade the picture quality.
- This feature requires ample light. More light is required for the fastest shutter speeds.
- The Auto Focus system may not operate properly in insufficient light when using the High Speed Shutter.

## Backlight

Use when recording a subject that is darker than the surrounding scene, in a shadowed area or when the light source is in back of your subject.

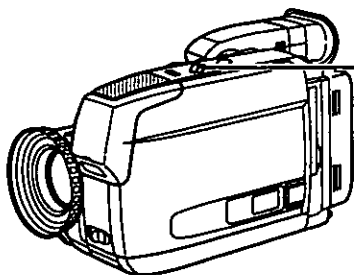

Press BACKLIGHT while recording.

When lighting conditions return to normal, press BACKLIGHT again to disengage.

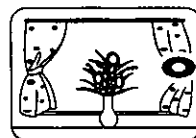
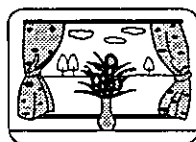

Indication appears in the EVF.

# Special Features

## Intelligent Titler

On specific holidays, such as New Year's Day, the Palmcorder will automatically display the appropriate title (except HAPPY EASTER and PRESIDENT'S DAY) from the pre-programmed titles when the Palmcorder is turned on in the Camera mode on that day.

### Automatic Title Display

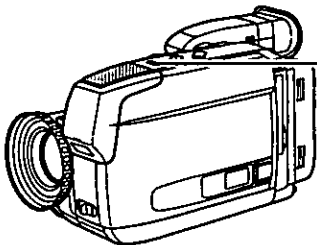

### Before you begin...

- Connect the Palmcorder to a power source.
- Insert a cassette with record tab (see page 10).

Press **RECORD/ PAUSE** to record the displayed title.

Press **TITLE** in **Record/Pause mode** to erase or redisplay the title.

#### Note:

If you erase the title and then turn the Palmcorder off, the title will not be automatically displayed when the power is turned back on.

Dec. 31–Jan. 1	HAPPY NEW YEAR! / CHEERS!
Feb. 14	VALENTINE'S DAY / BE MY VALENTINE
2nd Sunday in May	HAPPY MOTHER'S DAY / WE LOVE YOU!
Last Monday in May	MEMORIAL DAY
3rd Sunday in Jun.	HAPPY FATHER'S DAY
Jul. 4	INDEPENDENCE DAY
1st Monday in Sep.	LABOR DAY
Oct. 31	HAPPY HALLOWEEN
4th Thursday in Nov.	HAPPY THANKSGIVING
Dec. 24–25	MERRY CHRISTMAS / HO! HO! HO!
These Titles must be displayed manually.	HAPPY EASTER PRESIDENT'S DAY

### Manual Title Display

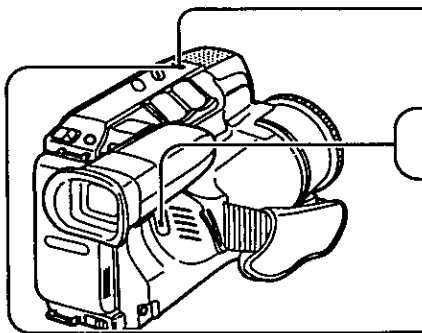

**1** In Record/Pause mode, Press **TITLE** repeatedly to display the desired title from the list show above.

**2** Press **RECORD/PAUSE** to record the displayed title.

**3** Press **RECORD/PAUSE** again to pause the recording.

**4** Press **TITLE** repeatedly until no title appears on-screen.

# Copying your Tapes (dubbing)

## Main Operation

### Before you begin...

- Connect the Palmcorder as shown below.
- Connect the Palmcorder to VCR.
- Turn ON both units.
- Set the recording VCR's Input Signal Selector to LINE.
- Set the Palmcorder POWER switch to VCR.

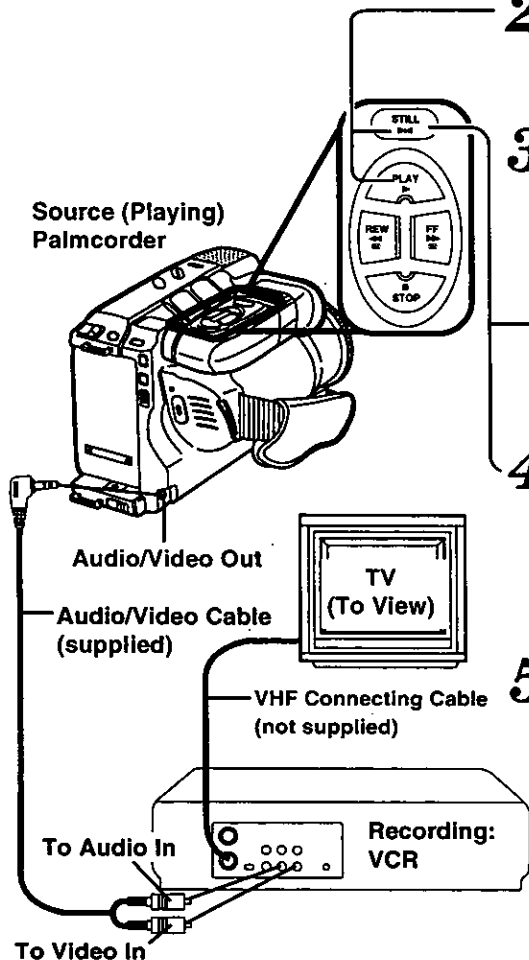

- 1** Insert a pre-recorded tape into the source (playing) Palmcorder and a blank tape with record tab into the recording unit.
- 2** Press **PLAY** on the (playing) Palmcorder. Press **STILL** when the tape reaches the point you want to start dubbing.
- 3** Press **PLAY** and **REC** together then immediately press **STILL** on the recording unit.
- 4** Press **STILL** on the playing Palmcorder and **PAUSE/STILL** on the recording unit to begin copying your tape.
- 5** Press **STOP** on both units when dubbing is complete.

### Note:

- Tapes recorded on other VCRs and used for playback in the Palmcorder must be recorded in SP or SLP mode.
- For technical reasons, dubbing a tape may reduce its quality.

### CAUTION:

Unauthorized exchanging and/or copying of copyrighted recordings may be copyright infringement.

## Monitor with your TV

- Turn the TV ON and select its VCR channel (either CH3 or CH4).
- Set the VCR/TV Selector on the recording VCR to VCR.

# ***Palmcorder Accessory System***

For information and ordering instructions, see the separate Selection Guide and Accessory Order Form.

## ***Power Supplies***

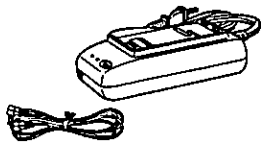

**AC Adaptor with  
DC Power Cable  
Supplied (PV-A17)**



**1.2Ah Battery Pack  
Supplied (PV-BP15)  
Optional (PV-BP15)**



**2.4Ah Battery Pack  
Optional (PV-BP17)**

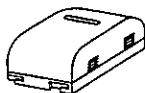

**1.8Ah Battery Pack  
Optional (PV-BP18)**



**Car Battery Cord  
Optional (PV-C16)**

## ***To Transport***



**Shoulder Strap  
Supplied (VYCW0108)**

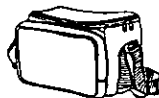

**System Carrying Case  
Optional (PV-H18)**

## ***Connection***



**Audio/Video Cable  
Supplied (VJAW0032)**



**RF Adaptor  
Optional (PV-RF16)**

## ***To Record and Playback***

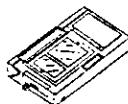

**VHS PlayPak  
Supplied (PV-P1)  
/VYMW0009  
Optional (PV-P1)**

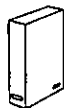

**Compact Video  
Cassette Tape  
Optional  
(NV-TC20P,  
NV-TC30P,  
NV-TC40P)**

## ***For Special Effects***

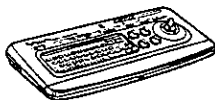

**Video Corrector  
Optional (PV-CC50)**

## ***To Copy your Tapes (with Video/Audio)***



**Audio/Video Cable  
Supplied (VJAW0032)**

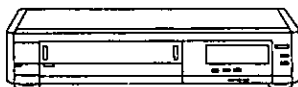

**VCR (not supplied)**



# Notes Regarding Operations

## Attaching Optical Filters and Lenses

Remove the Lens Hood by turning it counterclockwise.

Then attach an optical filter or lens.

- Be careful not to touch the lens itself.
- Replace the Lens Hood after removing the accessory.

## Cleaning the EVF (Electronic View Finder)

To Remove

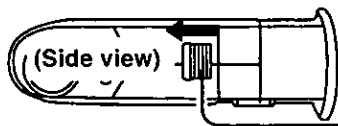

**1** Slide and hold the EYEPIECE RELEASE button.

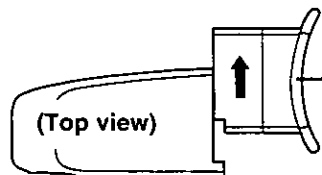

**2** Remove the eyepiece. (Do not twist.)

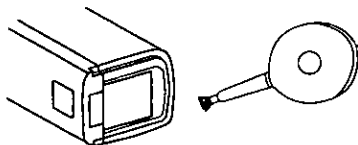

**3** Remove any lint or dust particles with a blower, available at photography stores. Do not touch lenses with fingers. Now, replace the eyepiece.

**FCC Warning:** Any unauthorized changes or modifications to this equipment would void the user's authority to operate.

This device complies with Part 15 of the FCC Rules. Operation is subject to the following two conditions: (1) This device may not cause harmful interference, and (2) this device must accept any interference received, including interference that may cause undesired operation.

**Note:** This equipment has been tested and found to comply with Part 15 and part 18 of the FCC Rules. These limits are designed to provide reasonable protection against harmful interference when operated in a residential environment.

If this equipment does cause interference to radio or television reception, which can be determined by turning the equipment off and on, use the equipment in another location and/or utilize an electrical outlet different from that used by the receiver.

If necessary, consult the dealer or an experienced radio/TV technician for help. You may find the booklet, 'Something About Interference' available from FCC local regional offices helpful.

# Specifications

<b>Power Source:</b>	Compact VHS Palmcorder: DC 6V AC Adaptor: 110/120/220/240V AC, 50/60 Hz Battery: Nickel-Cadmium Type DC 6V
<b>Power Consumption:</b>	Compact VHS Palmcorder: 6V DC 7.8W AC Adaptor: 24W 1.2W (when not in use.)
<b>Video Signal:</b>	EIA Standard (525 lines, 60 fields) NTSC color signal
<b>Video Recording System:</b>	2 rotary heads. helical scanning system
<b>Audio:</b>	1 track
<b>Pick-Up System:</b>	Sequential color difference field reverse system
<b>Pick-Up Device:</b>	One integral color filter Charge Coupled Device (CCD)
<b>Lens:</b>	14:1 zoom lens, F1:1.6 with auto iris control Focal length: 5.3mm - 74.2mm Power zoom function Lens filter diameter: 55mm
<b>Viewfinder:</b>	0.5 inch (12.7mm) Liquid Crystal Color Electronic Viewfinder
<b>Minimum Illumination Required:</b>	1 lx (F1:1.6) 0.1 footcandles
<b>Operating Temperature:</b>	32°F-104°F (0°C-40°C)
<b>Operating Humidity:</b>	10%-75%
<b>Weight:</b>	Compact VHS Palmcorder: 2.0 lbs. 0.91 kg AC Adaptor: 0.77 lbs. 0.35 kg
<b>Dimensions:</b>	Compact VHS Palmcorder: 4-1/8 (W) × 4-5/8 (H) × 6-7/8 (D) inch 106 (W) × 116 (H) × 176 (D) mm AC Adaptor: 2-3/4 (W) × 1-5/8 (H) × 5-3/4 (D) inch 70 (W) × 41 (H) × 145 (D) mm

Weight and dimensions shown are approximate.

Designs and specifications are subject to change without notice.

# Before Requesting Service

## Cleaning Care for Video Heads



Clogged Video Head

(a) **Video Head Cleaning:** Your Palmcorder will not normally require head cleaning; however, it is possible that the heads may become clogged when playing an old or damaged tape. If the image on your screen resembles the photograph on the left while playing back a tape, the heads may require cleaning.

(b) **Cleaning the Heads:** It is recommended that head cleaning be performed by a qualified service technician. Please contact your nearest Panasonic Service Center. An alternate solution is to obtain a head cleaning cassette. There are many types of cleaning cassettes, so be sure to follow the cleaning instructions carefully. Excessive use of the cleaning cassette could shorten head life. Use this cassette only when a head clogging symptom occurs.

Refer servicing to qualified service personnel.

### Auto-Reset

The Palmcorder, provided no tape is inserted, will reset the Backlight, High Speed Shutter and Focus to their AUTO or OFF modes if, after activation, none of these buttons are pressed within 5 minutes.

# Before Requesting Service

If you have a problem with your Palmcorder, it may be something you can correct yourself. Check the list below for symptoms and corrections.

Symptom	Correction
No picture in the EVF ...	<ul style="list-style-type: none"> <li>• Make sure a Power Source is connected. (pp. 7, 9)</li> <li>• Make sure the POWER switch is set to VCR or CAMERA. (pp. 19, 24)</li> <li>• Check the Dew Indicator. (p. 17)</li> <li>• Make sure the battery is fully charged. (p. 7)</li> <li>• Make sure all necessary cables are connected correctly and firmly. (p. 26)</li> </ul>
Video cassette can't be inserted ...	<ul style="list-style-type: none"> <li>• Make sure a Power Source is connected. (pp. 7, 9)</li> <li>• Insert the cassette with the window side facing out. (p. 10)</li> </ul>
Video cassette can't be removed ...	<ul style="list-style-type: none"> <li>• Make sure a Power Source is connected. (pp. 7, 9)</li> </ul>
No operation starts when operation buttons are pressed ...	<ul style="list-style-type: none"> <li>• Check the Dew Indicator. (p. 17)</li> </ul>
Recording cannot be done ...	<ul style="list-style-type: none"> <li>• Make sure the record tab is still intact. (p. 10)</li> <li>• Check the Battery Indicator. (p. 15)</li> <li>• Check the Dew Indicator. (p. 17)</li> </ul>
Auto Focus does not operate ...	<ul style="list-style-type: none"> <li>• Make sure the FOCUS button is set to AUTO. (p. 28)</li> <li>• Make sure the unit is ON, with the POWER switch set to CAMERA (p. 19).</li> </ul>
Sound from microphone can't be monitored ...	<ul style="list-style-type: none"> <li>• Make sure the unit is set to REC or Record/Pause mode.</li> </ul>
Camera picture is too dark ...	<ul style="list-style-type: none"> <li>• Make sure the HIGH SPEED SHUTTER button is OFF (p. 29).</li> </ul>
No playback picture, or the playback picture is noisy or contains streaks ...	<ul style="list-style-type: none"> <li>• Press the Clock Set UP ▲/DOWN ▼ button during playback (Tracking Control) (p. 24).</li> </ul>
During playback, the picture shows motion or blurred action ...	<ul style="list-style-type: none"> <li>• Portions of the still picture where the normal speed motion was particularly rapid may produce this effect. This is normal.</li> </ul>
"Panasonic Palmcorder IQ IT'S VHS! SO ITS TAPES PLAY IN YOUR VCR" appears in the EVF and Monitor ...	<ul style="list-style-type: none"> <li>• Set the POWER switch to OFF and then CAMERA.</li> </ul>
If the top of your playback picture waves back and forth excessively ...	<ul style="list-style-type: none"> <li>• Because the playback signal is not as stable as an off the air TV signal, the top of your TV screen may be bent or unstable when the tape is played back. This symptom is more noticeable when a tape, recorded on another VCR, is played back. To solve this problem, locate the horizontal hold control on your TV. Turn it slowly to correct the wavy picture. If your TV does not have a horizontal hold control or adjusting the control does not help, some modifications may have to be made to the TV set. Technically this is called "Horizontal AFC time constant change." If such a problem exists, please contact your local TV service center. (Some nominal service charges may be required.)</li> </ul>

# Index of Controls

## Front View

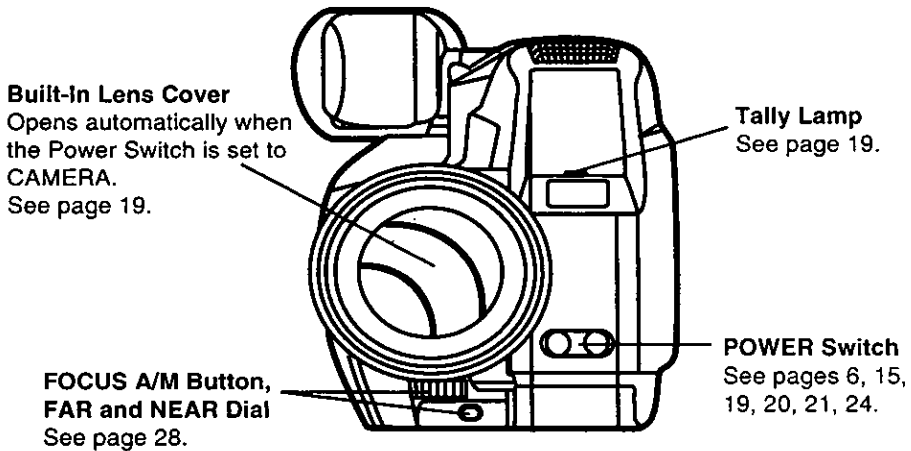
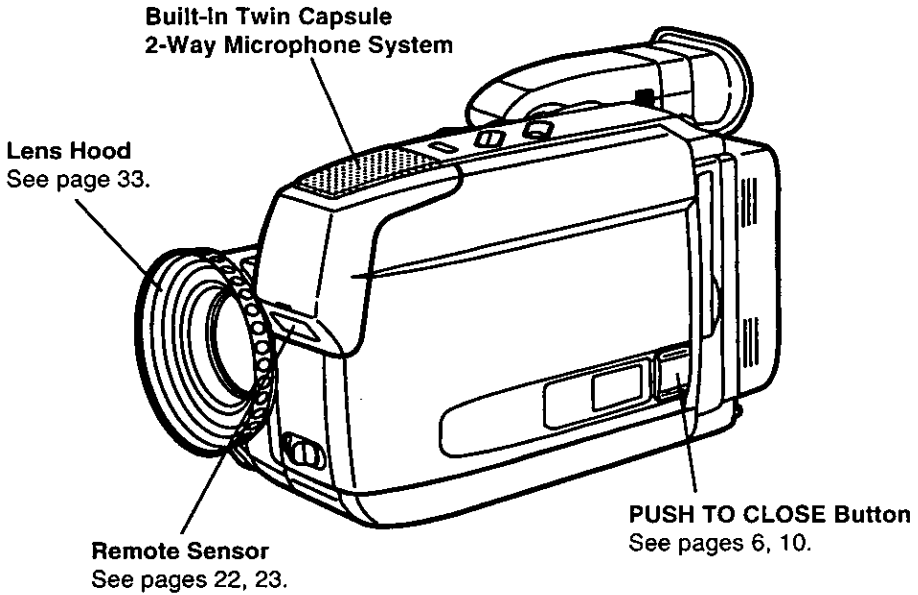

# Index of Controls

## Rear View

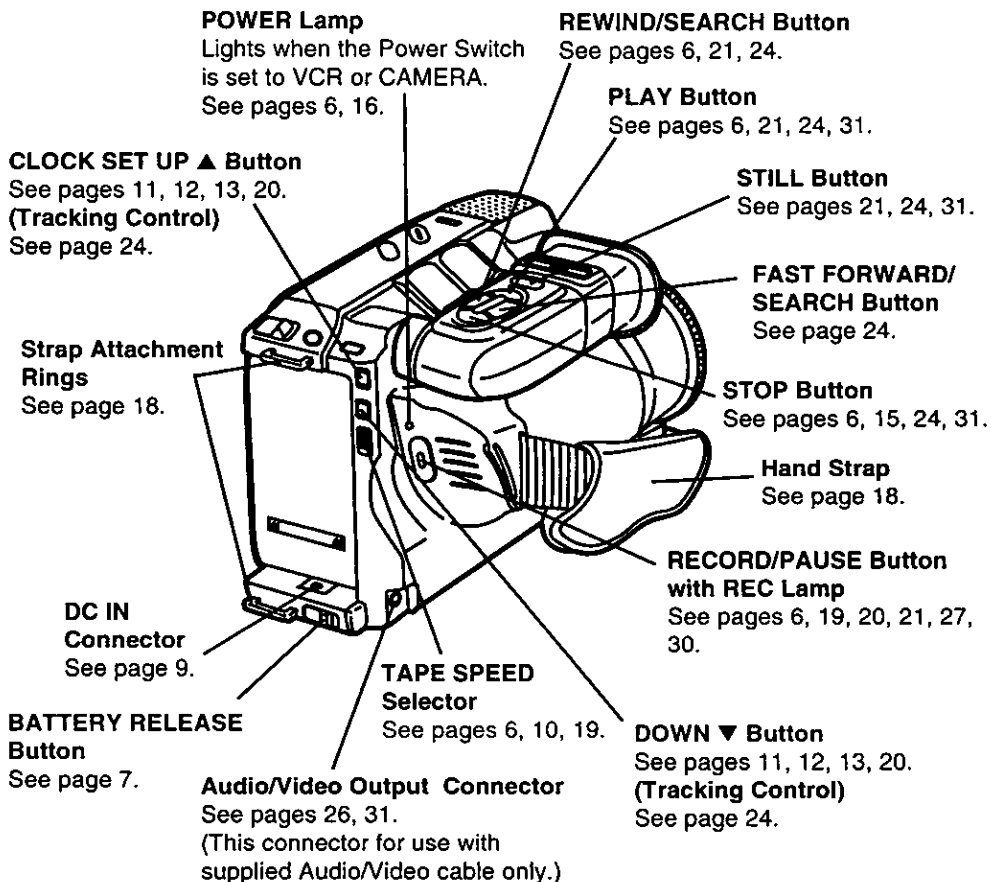

# Index of Controls

## Top View

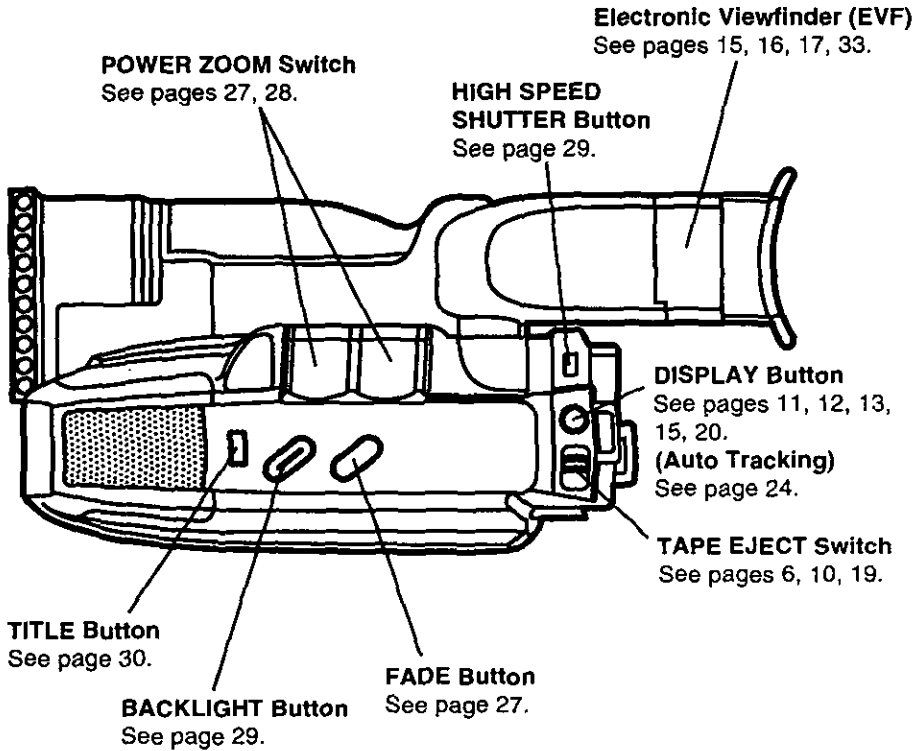

# Index of Controls

## Underside View

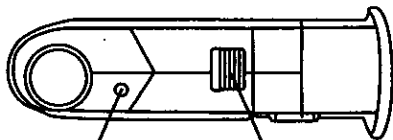
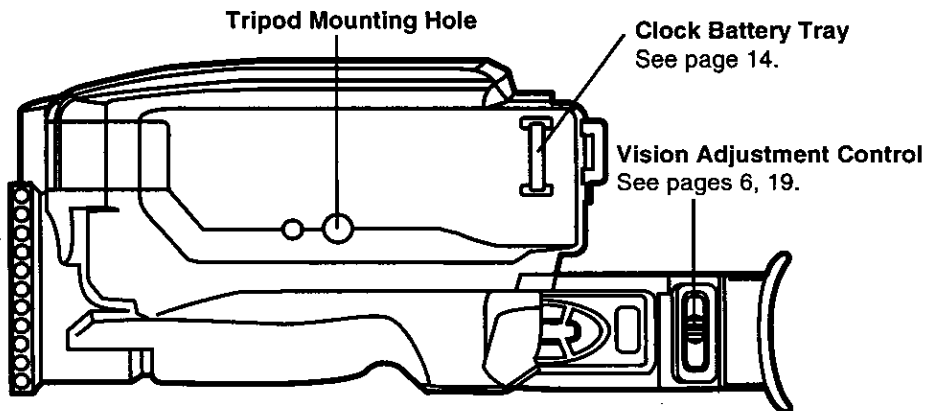

**\*Bright Control**  
Adjust the brightness of  
the picture.

**EYEPiece RELEASE button**  
See page 33.

**\*Note:** These controls have been set at the factory. It is not necessary to adjust these controls under normal circumstances. But, should it become necessary, be careful to make the adjustment with a small, slender screwdriver so as not to damage the miniature control.



# Index of Controls

## 9-Function Remote

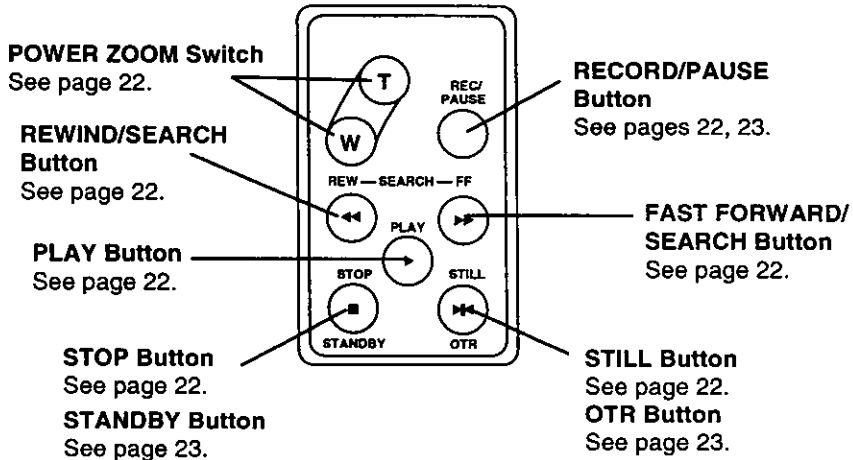

## AC Adaptor

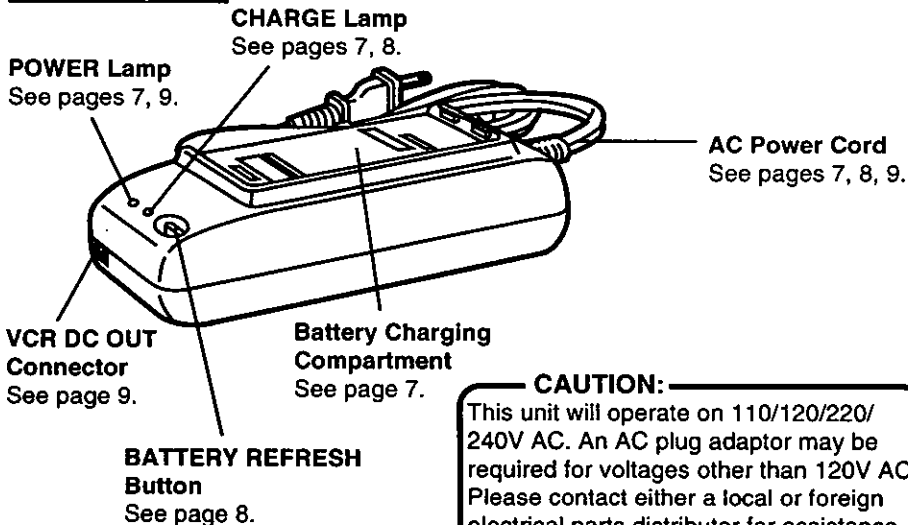

### CAUTION:

This unit will operate on 110/120/220/240V AC. An AC plug adaptor may be required for voltages other than 120V AC. Please contact either a local or foreign electrical parts distributor for assistance in selecting an alternate AC plug. We recommend using the accessory power plug adaptor (VJSS0070) in an area which has special AC outlets.

# Index

- A**  
Accessories (Optional/Supplied) 2, 32  
AC Adaptor 9  
Audio/Video Cable 2, 26, 31, 32  
Auto Daylight Saving Time 12  
Auto Focus 28  
Auto-Reset 35
- B**  
Backlight 29  
Battery Pack 2, 7, 8, 32  
Battery Remaining Indication 15, 16  
Battery Warning 16
- C**  
Camera Recording 19  
Car Battery Cord 9, 32  
CH 3/4 Switch 26  
Charging Battery 7  
Cleaning Care for Video Heads 35  
Clock Battery 2, 14  
Clock Set 11, 12, 13, 14  
Copying your Tapes 31
- D**  
DC Power Cable 2, 9, 32
- Dew Indication 17  
Display-off Mode 15
- E**  
Easy Edit Stand-by 21  
Erase Protection Tab 10  
EVF Indications 15, 16, 17
- F**  
Fade 27
- H**  
High Speed Shutter 29  
High Speed Shutter Indicator 17, 29
- M**  
Macro Focus 28  
Manual Focus 28
- O**  
One-Touch Auto Fade 27
- P**  
Play Indicator 16  
Playback 24  
PlayPak 25  
Power Supply 7, 8, 9  
Programmed Recording 23
- R**  
Rec Indicator 16
- Remote Control 22, 23  
RF Adaptor 26, 32
- S**  
Safety Precautions 2  
Search Speed 24  
Shoulder Strap 2, 18, 32  
Special Effects Playback 24  
Specifications 34  
Stand-by Release 20  
Still Picture 24  
Symptom/Correction 36
- T**  
Tape Speed 10  
Tape Warning 16  
10-Second Reminder 16  
Titler 30  
Tracking Control 24
- V**  
VCR-MODE Indication 17  
VHF Connecting Cable 26, 31  
Video Cassettes (tapes) 10, 32  
Viewing 26
- Z**  
Zoom In/Out 27

# Spanish Quick Use Guide/Guía Para Uso Rápido

## PREPARATIVOS

- Conectar la videocámara a una fuente de alimentación (batería, adaptador de CA o cable para batería de coche).
- Encender el aparato.
- Introducir el casete en el compartimiento de cassetes.

## GRABACION

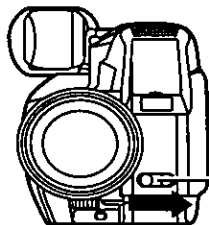

- 1** Fije el interruptor a la posición de CAMERA.

PAUSE

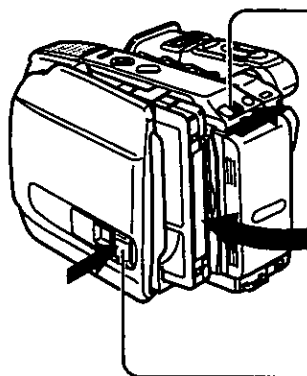

- 2** Deslice el botón EJECT para abrir la puerta.

- 3** Introduzca la cinta.

PAUSE

- 4** Cierre la puerta presionando el botón PUSH TO CLOSE.

- 5** Seleccionar la velocidad de grabación.

- 6** Oprimir el botón de grabación/pausa (RECORD/PAUSE) para comenzar a filmar.

REC

- 7** Volver a oprimir el botón de grabación/pausa (RECORD/PAUSE) cuando se desea hacer una pausa en la grabación.

PAUSE

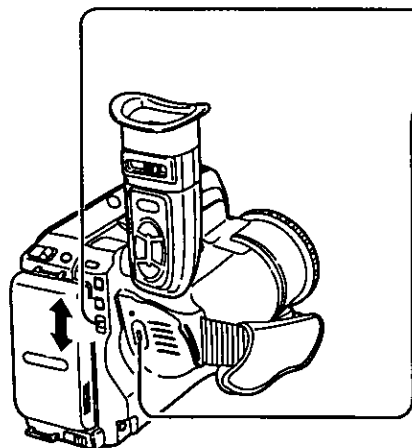

# Spanish Quick Use Guide/Guía Para Uso Rápido

- Conectar la videocámara a una fuente de alimentación (batería, adaptador de CA o cable para batería de coche).
- Encender el aparato.
- Introducir el casete en el compartimiento de cassetes.

## REPRODUCCION NORMAL

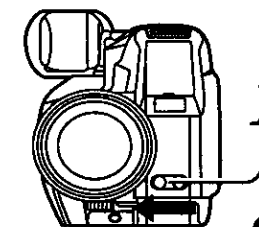

**1** Fije el interruptor a la posición de VCR.

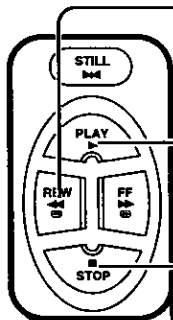

**2** Rebobinar la cinta con el botón de rebobinado (REWIND) (si fuera necesario).

**3** Oprimir el botón de reproducción (PLAY) para que aparezcan las imágenes en la pantalla.

**4** Oprimir el botón de parada (STOP) cuando se desea parar la reproducción.

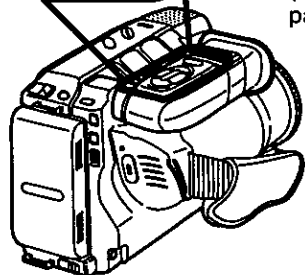

En el visor

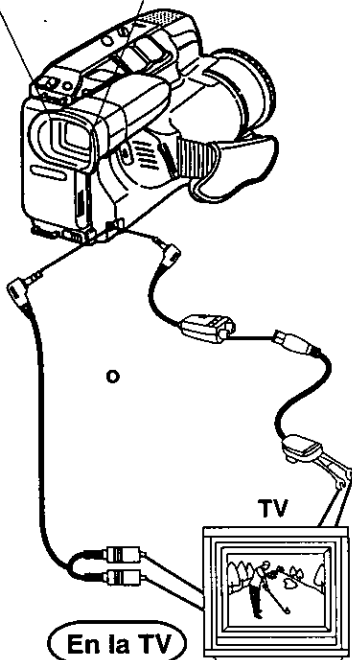

En la TV



## REPRODUCCION CON EFECTOS ESPECIALES

### PARA LOCALIZAR RAPIDAMENTE UNA ESCENA ESPECIFICA

- Oprimir el botón de localización (SEARCH).

### PARA CONGELAR UNA IMAGEN

- Oprimir el botón de pausa/imagen fija (PAUSE/STILL).
- Oprimir nuevamente el botón cuando se desea continuar reproduciendo.

Matsushita Consumer Electronics Company, Division of Matsushita Electric Corporation of America  
One Panasonic Way Secaucus, New Jersey 07094

Panasonic Sales Company, Division of Matsushita Electric of Puerto Rico, Inc. ("PSC")  
Ave. 65 de Infantería, Km. 9.5  
San Gabriel Industrial Park  
Carolina, Puerto Rico 00985

