

Palmcorder® Camcorder

Panasonic®

VHS

Camcorder
Operating Instructions

Model No. **PV-L353**

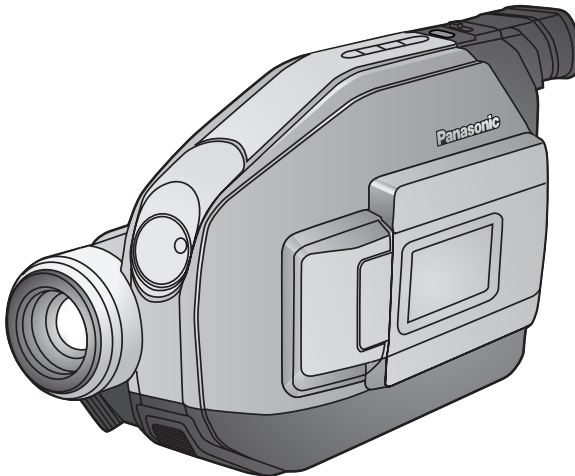

Getting Started

Basic Operation

Special Features

For Your Information

Please read these instructions carefully before attempting to operate this product.
Please save this manual.

Guía para rápida consulta en español está incluida.

For assistance, please call : 1-800-211-PANA(7262) or send e-mail to : consumerproducts@panasonic.com

LSQT0628A

Things You Should Know

Thank you for choosing Panasonic!

You have purchased one of the most sophisticated and reliable products on the market today. Used properly, it will bring you years of enjoyment. Please take time to fill in the information to the right.

The serial number is on the tag located on the rear side of your Camcorder. Be sure to **retain this manual** as your convenient Camcorder information source.

Date of Purchase

Dealer Purchased From

Dealer Address

Dealer Phone No.

Model No.

Serial No.

Unpack your Camcorder

These accessories are provided in order to set up or use your Camcorder.

1 pc. AC Adaptor (PV-A20)
with DC Power Cable
(page 10)



1 pc. Audio/Video Cable
(LSJA0390) (pages 21, 22)



1 pc. Battery Pack
(PV-BP15/LSSB0007)
(pages 9, 10)



1 pc. Shoulder Strap
(LSFC0012) (page 12)



1 pc. CR2025 Clock Battery
(installed in Camcorder)
(page 35)



1 pc. Lens Cap (LSKM0937)
with Lens Cap Strap
(LSGQ0049) (page 12)



Battery Charging Confirmation Marker



Use this marker as a reminder to yourself when the battery is fully charged or in need of a charge. This marker performs no function and is for your reference only.

Things You Should Know

Safety Precautions

WARNING: TO PREVENT FIRE OR SHOCK HAZARD, DO NOT EXPOSE THIS EQUIPMENT TO RAIN OR MOISTURE.

Your Compact VHS Camcorder is designed to record and play back in Standard Play (SP) and Super Long Play (SLP) modes. You can also play a Compact VHS Camcorder recording on your VHS VCR using the supplied VHS PlayPak.

This Camcorder is equipped with the **HQ** System to provide excellent video pictures, and is compatible with standard VHS equipment.

It is recommended that only cassette tapes that have been tested and inspected for use in VCR machines with the **VHS-C** and/or **VHS** mark be used.

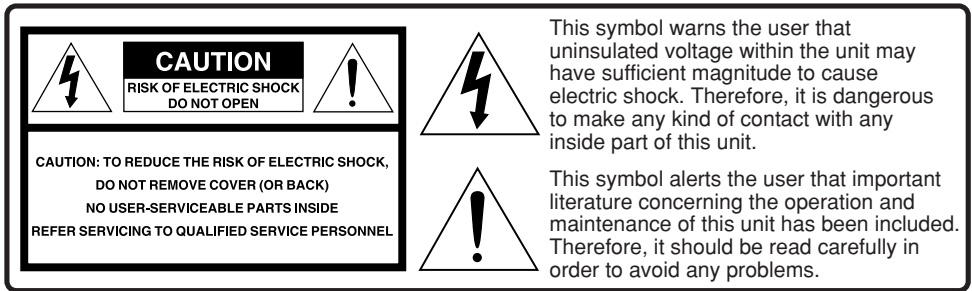

The above markings are located on the appliance's bottom cover.

FCC Warning : Any unauthorized changes or modifications to this equipment would void the users authority to operate.

This device complies with Part 15 of the FCC Rules. Operation is subject to the following two conditions: (1) This device may not cause harmful interference, and (2) this device must accept any interference received, including interference that may cause undesired operation.

Note: This equipment has been tested and found to comply with Part 15 and part 18 of the FCC Rules. These limits are designed to provide reasonable protection against harmful interference when operated in a residential environment.

If this equipment does cause interference to radio or television reception, which can be determined by turning the equipment off and on, use the equipment in another location and/or utilize an electrical outlet different from that used by the receiver.

If necessary, consult the dealer or an experienced radio/TV technician for help. You may find the booklet, 'Something About Interference' available from FCC local regional offices helpful.

This product may cause interference to radio equipment and should not be installed near maritime safety communications equipment or other critical navigation or communication equipment operating between 0.45-30 MHz.

Important Safeguards

- 1. Read Instructions** – All the safety and operating instructions should be read before the unit is operated.
- 2. Retain Instructions** – The safety and operating instructions should be retained for future reference.
- 3. Heed Warnings** – All warnings on the unit and in the operating instructions should be adhered to.
- 4. Follow Instructions** – All operating and maintenance instructions should be followed.
- 5. Cleaning** – Unplug this video unit from the wall outlet before cleaning. Do not use liquid or aerosol cleaners. Use a dry cloth for cleaning.
- 6. Attachments** – Do not use attachments not recommended by the video product manufacturer as they may be hazardous.
- 7. Water and Moisture** – Do not use this video unit near water – for example near a bath tub, wash bowl, kitchen sink, or laundry tub, in a wet basement, or near a swimming pool, and the like.
- 8. Accessories** – Do not place this video unit on an unstable cart, stand, tripod, bracket, or table. The video unit may fall, causing serious injury to a child or adult, and serious damage to the unit. Use only with a cart, stand, tripod, bracket, or table recommended by the manufacturer, or sold with the video unit. Any mounting of the unit should follow the manufacturer's instructions and should use a mounting accessory recommended by the manufacturer. An appliance and cart combination should be moved with care. Quick stops, excessive force, and uneven surfaces may cause the appliance and cart combination to overturn.
- 9. Ventilation** – Slots and openings in the cabinet are provided for ventilation and to ensure reliable operation of the video unit and to protect it from overheating. These openings must not be blocked or covered. Never place the video unit on a bed, sofa, rug, or other similar surface, or near or over a radiator or heat register. This video unit should not be placed in a built-in installation such as a bookcase or rack unless proper ventilation is provided or the manufacturer's instructions have been adhered to.
- 10. Power Sources** – This video unit should be operated only from the type of power source indicated on the marking label. If you are not sure of the type of power supply to your home, consult your appliance dealer or local power company. For video units intended to be operated from battery power, or other sources, refer to the operating instructions.



- 11. Grounding or Polarization** – This video unit may be equipped with either a polarized 2-wire AC (Alternating Current) line plug (a plug having one blade wider than the other) or 3-wire grounding type plug, a plug having a third (grounding) pin.
The 2-wire polarized plug will fit into the power outlet only one way. This is a safety feature. If you are unable to insert the plug fully into the outlet, try reversing the plug. If the plug still fails to fit, contact your electrician to replace your obsolete outlet.
Do not defeat the safety purpose of the polarized plug.
The 3-wire grounding type plug will fit into a grounding type power outlet. This is a safety feature. If you are unable to insert the plug into the outlet, contact your electrician to replace your obsolete outlet. Do not defeat the safety purpose of the grounding type plug.
- 12. Power-Cord Protection** – Power-supply cords should be routed so that they are not likely to be walked on or pinched by items placed upon or against them. Paying particular attention to cords of plugs, convenience receptacles, and the point where they exit from the unit.
- 13. Outdoor Antenna Grounding** – If an outside antenna or cable system is connected to the video unit, be sure the antenna or cable system is grounded so as to provide some protection against voltage surges and built-up static charges. Part 1 of the Canadian Electrical Code, in USA Section 810 of the National Electrical Code, provides information with respect to proper grounding of the mast and supporting structure, grounding of the lead-in wire to an antenna discharge unit, size of grounding conductors, location of antenna discharge unit, connection to grounding electrodes, and requirements for the grounding electrode.

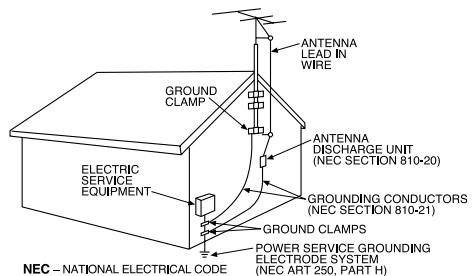

- 14. Lightning** – For added protection of this video unit receiver during a lightning storm, or when it is left unattended and unused for long periods of time, unplug it from the wall outlet and disconnect the antenna or cable system. This will prevent damage to the video unit due to lightning and power-line surges.

Important Safeguards

15. **Power Lines** – An outside antenna system should not be located in the vicinity of overhead power lines or other electric light or power circuits, or where it can fall into such power lines or circuits. When installing an outside antenna system, extreme care should be taken to keep from touching such power lines or circuits as contact with them might be fatal.
16. **Overloading** – Do not overload wall outlets and extension cords as this can result in a risk of fire or electric shock.
17. **Objects and Liquids** – Never push objects of any kind into this video unit through openings as they may touch dangerous voltage points or short out parts that could result in a fire or electric shock. Never spill liquid of any kind onto the video unit.
18. **Servicing** – Do not attempt to service this video unit yourself as opening or removing covers may expose you to dangerous voltage or other hazards. Refer all servicing to qualified service personnel.
19. **Damage Requiring Service** – Unplug this video unit from the wall outlet and refer servicing to qualified service personnel under the following conditions:
 - a. When the power-supply cord or plug is damaged.
 - b. If any liquid has been spilled into, or objects have fallen onto, the video unit.
 - c. If the video unit has been exposed to rain or water.
 - d. If the video unit does not operate normally by following the operating instructions. Adjust only those controls that are covered by the operating instructions, as an improper adjustment of other controls may result in damage and will often require extensive work by a qualified technician to restore the video unit to its normal operation.
 - e. If the video unit has been dropped or the cabinet has been damaged.
 - f. When the video unit exhibits a distinct change in performance – this indicates a need for service.
20. **Replacement Parts** – When replacement parts are required, be sure the service technician has used replacement parts specified by the manufacturer or have the same characteristics as the original part. Unauthorized substitutions may result in fire, electric shock or other hazards.
21. **Safety Check** – Upon completion of any service or repairs to this video unit, ask the service technician to perform safety checks to determine that the video unit is in safe operating order.

Precautions

USE & LOCATION

- **TO AVOID SHOCK HAZARD ...** Your Camcorder and power supply should not be exposed to rain or moisture. Do not connect the power supply or operate your Camcorder if it gets wet. Your Camcorder has been designed for outdoor use, however it is not designed to sustain direct exposure to water, rain, sleet, snow, sand, dust, or a direct splashing from a pool or even a cup of coffee. This action could permanently damage the internal parts of your Camcorder. Do not attempt to disassemble this unit. There are no user serviceable parts inside. Unplug your Camcorder from the power supply before cleaning.
- **DO NOT AIM YOUR CAMCORDER AT THE SUN OR OTHER BRIGHT OBJECTS.**
- **DO NOT LEAVE THE CAMCORDER WITH THE EVF AIMED DIRECTLY AT THE SUN AS THIS MAY CAUSE DAMAGE TO THE INTERNAL PARTS OF THE EVF.**
- **DO NOT EXPOSE YOUR CAMCORDER TO EXTENDED HIGH TEMPERATURE ...** Such as, in direct sunlight, inside a closed car, next to a heater, etc... This action could permanently damage the internal parts of your Camcorder.
- **AVOID SUDDEN CHANGES IN TEMPERATURE ...** If the unit is suddenly moved from a cold place to a warm place, moisture may form on the tape and inside the unit.
- **DO NOT LEAVE YOUR CAMCORDER OR THE POWER SUPPLY TURNED ON WHEN NOT IN USE.**
- **STORAGE OF YOUR CAMCORDER ...** Store and handle your Camcorder in a manner that will not subject it to unnecessary movement (avoid shaking and striking). Your Camcorder contains a sensitive pick-up device which could be damaged by improper handling or storage.

CARE

- **TO CLEAN YOUR CAMCORDER ...** Do not use strong or abrasive detergents when cleaning your Camcorder body.
- **TO PROTECT THE LENS ...** Do not touch the surface of the lens with your hand. Use a commercial camcorder lens solution and lens paper when cleaning the lens. Improper cleaning can scratch the lens coating.
- **TO PROTECT THE FINISH OF YOUR CAMCORDER ...** Before handling your Camcorder, make sure your hands and face are free from any chemical products, such as suntan lotion, as it may damage the finish.

Table of Contents

Getting Started

Things You Should Know	2~3
Important Safeguards	4~5
Precautions	5
Self Demo Mode	7
Quick Operation Guide	8
Supplying Power (Battery Charge/Use/Refresh/Care, AC Adaptor, Car Battery Cord)	9~10
Cassette Information	11
Before Using (Remove the Sensor tag, Using the Shoulder and Hand Straps, Lens Cap)	12
Using MENU Mode	13
Setting the Clock (Time Zone, Auto Daylight Saving Time)	14~15
AccuBrite™ Built-in Light (Using the Light, Replacing the Bulb)	16

Basic Operation

Camera Recording (Basic, Stand-by, Programmed Recording)	17~19
Playing Back Recordings (Basic Playback, Visual Search, Still Picture, Tracking, TV/VCR Playback)	20~21
Copying your Tapes (dubbing)	22

Special Features

Four-Speed Power Zoom	23
Backlight	23
Focus (Auto/Manual Focus)	24
High Speed Shutter (Auto/Manual Shutter)	25
Auto Fade	26
Color Digital Fade	27
Digital Zoom	28
Digital Electronic Image Stabilization (E.I.S.)	29
MotionSensor	30

For Your Information

Viewfinder/LCD Monitor Indications	31~33
Notes On Operations	34
Replacing Clock Battery	35
Palmcorder Accessory System	36
Palmcorder Accessory Order Form	37
Specifications	38
Before Requesting Service (Video Head Cleaning)	39
Request for Service Notice	40
Limited Warranty	41
Customer Services Directory	42
Spanish Quick Use Guide/Guía Para Uso Rápido	43
Index	44

Self Demo Mode

Self Demo mode is on when the screen below appears. To turn it off, follow steps 1-4 below.

EVF or LCD Monitor

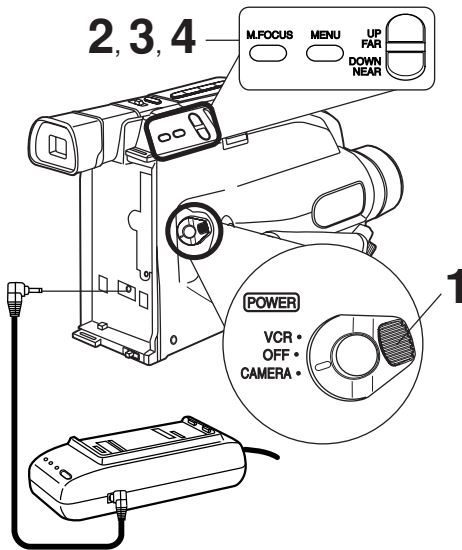

Before you begin...

- Connect Camcorder to power source.

1 Set **POWER** to **CAMERA**.

2 Press **MENU** for MENU mode.
Press **UP** or **DOWN** to select **SELF DEMO**.

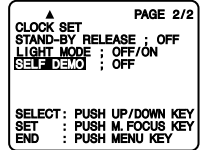

3 Press **M.FOCUS** to select OFF.

4 Press **MENU** to exit.

Note:

- Self Demo stops automatically if battery is attached (page 9) and cassette tape is inserted (page 11).
- Inserting a tape alone (or attaching a partially charged battery) only temporarily stops Self Demo.
- Self Demo stops for 30 seconds when the Back Light is pressed.

To turn Self Demo back on:

- Set to SELF DEMO : ON in MENU screen.

Quick Operation Guide

Charging the Battery Pack

Charge Battery Pack fully before operation (page 9).

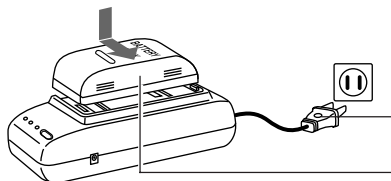

- 1 Plug in **AC Adaptor**.
- 2 Insert **Battery**. CHARGE Lamp flashes, then stays lit when charging is complete.

Insert Cassette

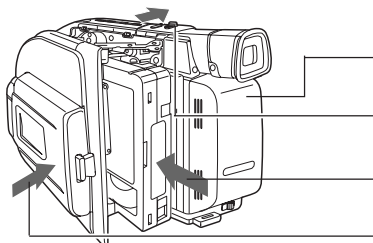

- 1 Attach fully charged **Battery** (page 9).
- 2 Slide **TAPE EJECT** to open door.
- 3 Insert **cassette** (page 11).
- 4 Press here to close door.

Camera Recording

See page 17.

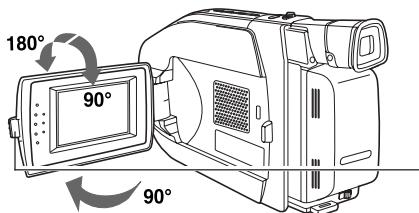

- 1 Press **LCD-OPEN** to unlock the LCD monitor. Swing it fully open and adjust the angle.
- 2 Set **POWER** to **CAMERA**.
- 3 Press **RECORD/PAUSE** to start recording. Press **RECORD/PAUSE** again to pause recording.

Playback using the LCD Monitor

See page 20.

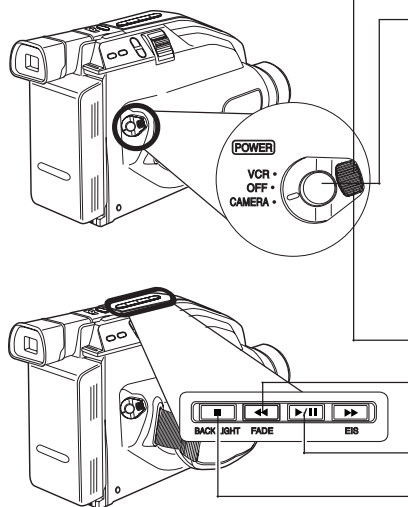

- 1 Press **LCD-OPEN** to unlock the LCD monitor. Swing it fully open and adjust the angle.
- 2 Set **POWER** to **VCR**.
- 3 Press **◀◀ (REWIND/SEARCH)** to rewind tape.
- 4 Press **▶/|| (PLAY/STILL)** to start playback.
- 5 Press **■ (STOP)** to stop playback.

Charging the Battery Pack

Charge Battery Pack fully before use.

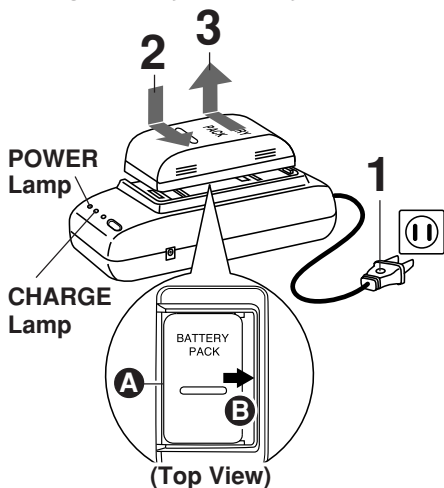

1

Plug in **AC Adaptor**.
POWER Lamp lights.

2

Insert **Battery**.

A Align left side of Battery with left edge of AC Adaptor.

B Press Battery down and slide in direction of arrow.

The CHARGE Lamp flashes, then stays lit when charging is complete.

3

Remove **Battery**.

Slide Battery to the left and lift off.

Note:

- Charging takes about 1 hour.
- While the DC Power Cable (supplied) is connected to the AC Adaptor, the Battery cannot be charged.
- After charging 5 times, use Battery Refresh feature as explained below.
- Battery life gradually decreases after repeated use and recharging. If operation time becomes very short even after a sufficient charge, discard Battery properly (pages 10, 34).

Using the Battery Pack

A fully charged Battery provides a maximum of about 1 hour 10 minutes of continuous use (LCD monitor off) or about 55 minutes (LCD monitor on). Actual time may vary due to operating conditions. Using the Built-in Light decreases operating time.

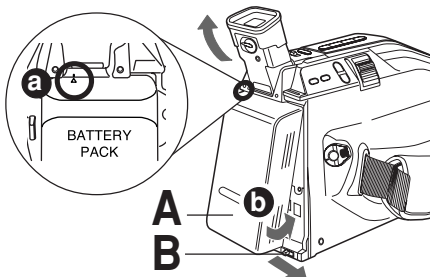

A

Lift up **EVF** and attach **Battery**.

a Insert top of Battery into top of mounting surface.

b Press and snap into place.

B

Remove **Battery**.

Slide **BATTERY RELEASE** and remove Battery.

Battery Refresh

This feature completely discharges Battery before recharging begins. Use after every 5 charges for optimum Battery performance.

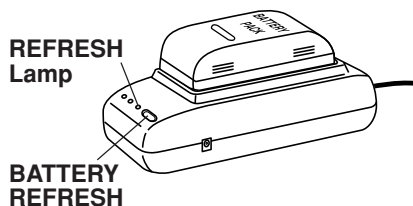

To use battery refresh, insert Battery on AC Adaptor (see steps 1~2 above), then press **BATTERY REFRESH**.

The REFRESH Lamp lights, then goes out when discharge is complete. Battery charging will then start automatically.

If **BATTERY REFRESH** is pressed by mistake, remove Battery from AC Adaptor and reinsert it for normal charging.

Note:

- Charging takes about 5 hours when Battery Refresh is used.
- Battery will not operate in extremely high temperatures.

Supplying Power

Battery Care

Caution:

- Charge only with specified charger.
- Battery can be charged within a temperature range of 10 °C (50 °F) and 35 °C (95 °F).
- Battery is normally warm after charging or just after use.
- Do not use an insufficiently charged or worn-out Battery.

Safety precautions:

- Do not get Battery near, or dispose of in, fire.
- Do not directly connect (short circuit) the positive (+) and negative (-) terminals.
- Never attempt to disassemble or reassemble Battery.

To avoid Battery damage:

- Do not drop or jar Battery.
- Use Battery with specified units only.
- If Battery is used in extremely high temperatures, a safety device will automatically prevent operation.

To prolong Battery life:

- While not in use, remove Battery from the Camcorder and AC Adaptor, and store in a cool, dark, dry place.
- Keep Battery terminals clean.

AC Adaptor

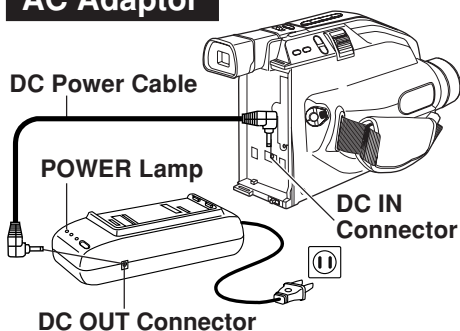

- 1 **Connect AC Adaptor DC OUT to Camcorder DC IN** with supplied DC Power Cable.
- 2 **Plug in AC Adaptor.** POWER Lamp lights.

Note:

- While the DC Power Cable (supplied) is connected to the AC Adaptor, the Battery cannot be charged.
- When not in use, unplug AC Adaptor from AC outlet. (Adaptor uses 1.2 W of electricity while plugged in.)

CAUTION:

This unit will operate on 110/120/220/240 V AC 50/60 Hz. An AC plug adaptor may be required for voltages other than 120 V AC. Please contact either a local or foreign electrical parts distributor for assistance in selecting an alternate AC plug. We recommend using the accessory power plug adaptor (VJSS0070/K2DB42E00001) in an area which has special AC outlets.

Car Battery Cord (Optional)

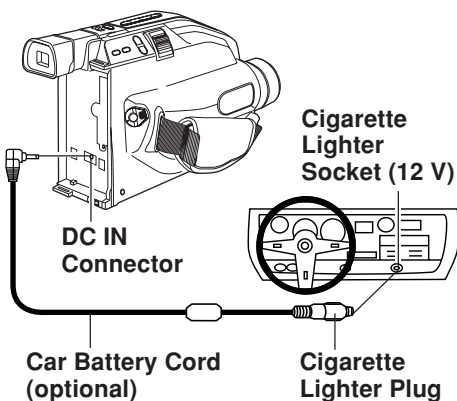

- 1 **Connect PV-C16 Car Battery Cord (optional) to Camcorder DC IN.**
- 2 **(A) Start engine first.**
(B) Plug Car Battery Cord into Cigarette lighter socket.

- If Car Battery cord fuse needs replacing, use exact current rating (in amps).

Note:

- This cord only works in vehicles equipped with **DC 12 V (negative ground)** battery. Check with your car/truck dealer. Use only specified car battery cord.
- To avoid blowing the car battery cord fuse, do step 2 in the proper order.
- Running vehicles must be well ventilated.
- When not in use, disconnect cigarette lighter plug.
- For personal safety the driver of the vehicle should not attempt to operate the camcorder while driving.

Cassette Information

Cassette Insertion/Removal

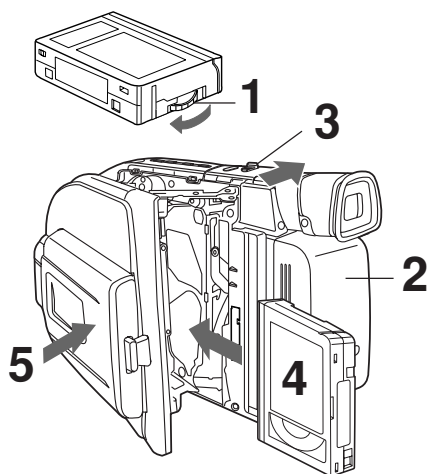

1 Turn **Tape Wheel** in direction of arrow until there is no slack.

2 Attach **Battery** (page 9).

3 Slide **TAPE EJECT** to open door.

4 Insert **cassette** as shown.

5 Press here to close door.

• To remove the cassette, slide the **TAPE EJECT** switch.

Record/Playback Time

Use tapes with the **VHSC** mark in this unit.

Tape Speed Selector Position	Cassette type		
	TC-20	TC-30	TC-40
SP (Standard Play)	20 minutes	30 minutes	40 minutes
SLP (Super Long Play)	1 hour	1 hour 30 minutes	2 hours

• SLP playback may contain more picture noise.

Erase Protection Tab

Protects tapes from being accidentally erased.

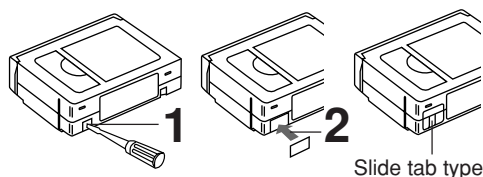

1 To prevent accidental erasing, **break off tab** with screwdriver. (Or, slide tab open.)

2 To record again, **cover hole** with adhesive tape. (Or, slide tab closed.)

Before Using

How to remove the Sensor tag

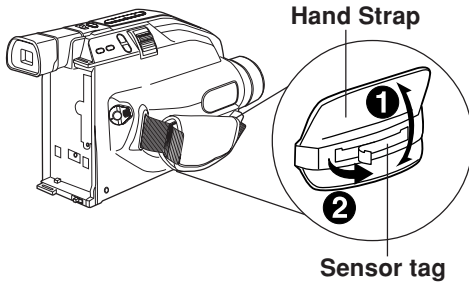

- 1 **Open the Hand Strap** as illustrated at left.
- 2 **Remove the Sensor tag.**
Then, replace the Hand Strap.

Attaching Shoulder Strap

Remove Battery Pack before completing the following steps:

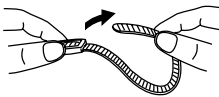
- 1 **Undo strap ends** from buckles. 
- 2 **Thread strap ends through Strap Rings on Camcorder.**

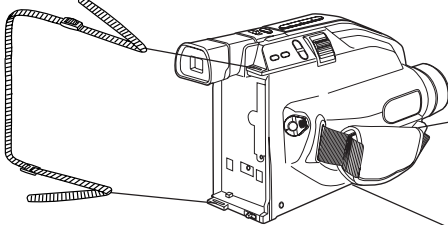

- 3 **Re-insert the strap ends into buckles.** 
min. 25.4 mm (1 inch)

Adjust the Length of the Shoulder Strap

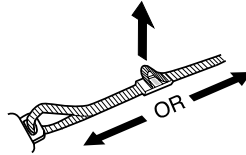

Pull a loop of strap from buckle, then pull strap tight to shorten or lengthen.

Hand Strap

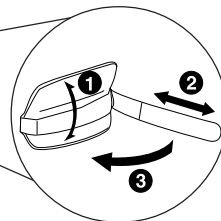

Adjust Hand Strap length to fit your hand as shown.

Lens Cap

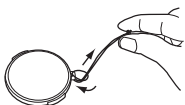

Attaching the Lens Cap Strap:
Thread the Strap through the Lens Cap attachment ring as illustrated at left.

Attaching the Lens Cap Cord to the Hand Strap:
Remove the Hand Strap from the front clasp and thread the Strap through the loop in the Lens Cap Cord. Reattach the Hand Strap.

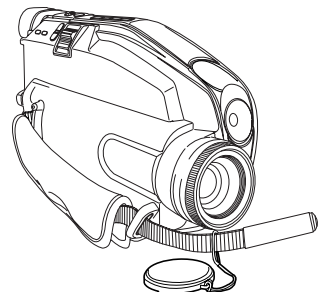

Using MENU Mode

Before you begin...

- Connect Camcorder to power source.
- Set POWER to CAMERA or VCR.

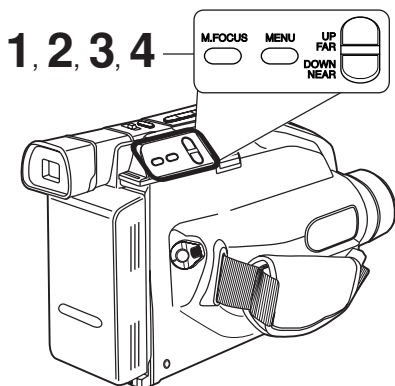

- 1 Press MENU** for MENU mode.
The CAMERA or VCR MENU screen (see below left) appears when Menu mode is entered.
- 2 Press UP or DOWN** to highlight the desired menu item.
- 3 Press M.FOCUS** to set selection.
- 4 Press MENU** to exit.

Note:

- The Menu mode is canceled if UP/DOWN, M.FOCUS, or MENU are not pressed within 5 minutes when Self Demo mode is off with no cassette tape and/or battery inserted.
- The Menu mode is canceled if UP/DOWN, M.FOCUS, or MENU are not pressed within 30 seconds when Self Demo mode is on with no cassette tape and/or battery inserted.

Camera Mode Menu Screen

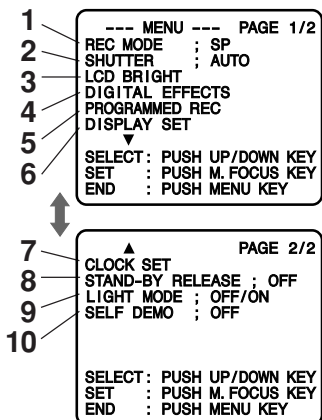

- 1 REC MODE** (page 17).
Change to desired tape speed, SP/SLP.
- 2 SHUTTER** (page 25).
Select desired shutter speed.
- 3 LCD BRIGHT** (pages 17, 20).
LCD BRIGHT SETTING sub menu is displayed. Adjust LCD monitor brightness level.
- 4 DIGITAL EFFECTS** (pages 26~28, 30).
DIGITAL EFFECTS sub menu is displayed. To select DIGITAL ZOOM, MOTIONSENSOR, or FADE.
- 5 PROGRAMMED REC** (page 19).
Camcorder starts and stops recording at a preset time.
- 6 DISPLAY SET** (pages 31, 32).
DISPLAY SET sub menu is displayed. To select DISPLAY or MODE SELECT.
- 7 CLOCK SET** (pages 14, 15).
CLOCK SET sub menu is displayed. Set the Date and Time.
- 8 STAND-BY RELEASE** (page 18).
ON : Enables quick resumption of recording from Stand-by mode.
- 9 LIGHT MODE** (page 16).
OFF/ON : Light can be set ON or OFF.
OFF/ON/AUTO : Light can be set ON, OFF, or AUTO.
- 10 SELF DEMO** (page 7).
ON : SELF DEMO screen is displayed.

VCR Mode Menu Screen

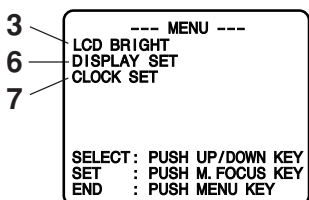

Setting the Clock

Set the following items in order: Time Zone, Daylight Saving Time, Date, and Time.

Before you begin...

- Connect Camcorder to power source.
- Set POWER to CAMERA or VCR.

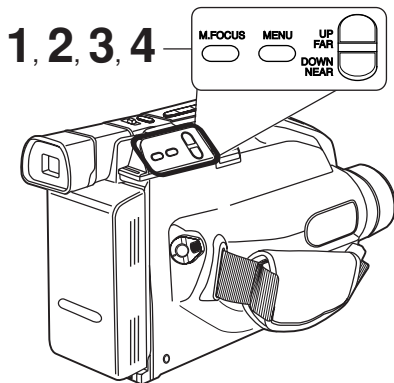

- 1 Press **MENU** for MENU mode.
Press **UP** or **DOWN** to select **CLOCK SET**.

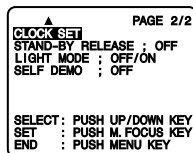

[CAMERA MODE]

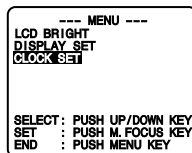

[VCR MODE]

- 2 Press **M.FOCUS** for CLOCK SET menu.
Press **UP** or **DOWN** to select **TIME ZONE**, **DST**, or **DATE/TIME**.

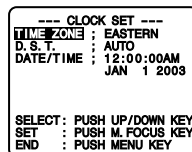

- 3 Press **M.FOCUS** for menu of item selected in step 2.

To change the setting:

TIME ZONE → Go to step **3a** on page 15.

D.S.T. → Go to step **3b** on page 15.

DATE/TIME → Go to step **3c** on page 15.

- 4 Press **MENU** twice to exit.

3a Setting the Time Zone

The Camcorder is preset to Eastern time.

[Time Zone chart]

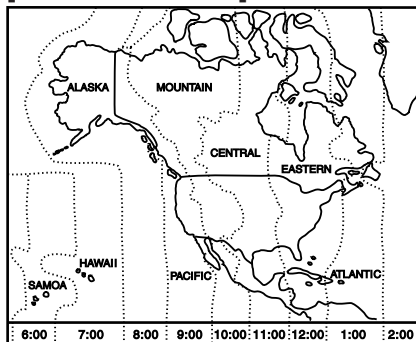

Press **UP** or **DOWN** to select local time zone.

Press **M.FOCUS** to confirm entry.

--- SELECT TIME ZONE ---

ATLANTIC	PACIFIC
EASTERN	ALASKA
CENTRAL	HAWAII
MOUNTAIN	SAMOA

SELECT : PUSH UP/DOWN KEY
SET : PUSH M. FOCUS KEY

- When traveling, repeat this operation and select one of the 8 listed time zones to set the clock to local time.

Note :

- Clock may lose or gain up to 2 minutes per month.
- When traveling outside the listed time zones, set clock to local time manually.
- To adjust or set clock, see "Setting Date and Time" (below).

3b Auto Daylight Saving Time

Clock will auto-adjust to daylight saving time (DST).

DST: AUTO

Spring (First Sunday in April) :
ahead one hour.

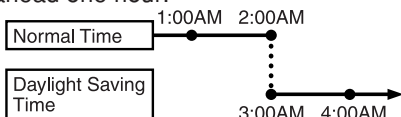

Autumn (Last Sunday in October) :
back one hour.

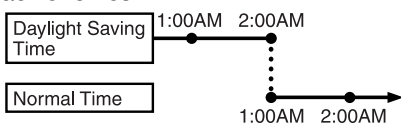

The Camcorder is preset to DST: **AUTO**. If DST is not observed in your area, set to **OFF** by doing the following.

Press **UP** or **DOWN** to select OFF or AUTO.

Press **M.FOCUS** to confirm entry.

---DAYLIGHT SAVING TIME---

AUTO
OFF

SELECT : PUSH UP/DOWN KEY
SET : PUSH M. FOCUS KEY

Note:

- Auto DST does not function if time zone is set to Hawaii or Samoa (see "Setting the Time Zone" above).

3c Setting Date and Time

Date and time including leap year are calculated up to DEC 31, 2099.

EXAMPLE :

UP FAR DOWN NEAR (arrow pointing to screen 1)

M.FOCUS (arrow pointing to screen 2)

SELECT : PUSH UP/DOWN KEY
SET : PUSH M. FOCUS KEY

---DATE/TIME SETTING---

12:00:00AM
JAN 1 2003

SELECT : PUSH UP/DOWN KEY
SET : PUSH M. FOCUS KEY

Press or hold down **UP** or **DOWN** to select hour, then press **M.FOCUS** to fix.

Repeat for minute, month, day, and year.

Clock starts when year is entered and **M.FOCUS** is pressed.

AccuBrite™ Built-in Light

Using the Light

For recording in dim lighting.

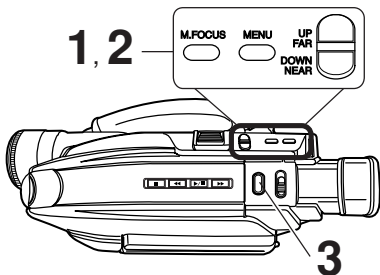

Note:

- Using Light reduces battery operating time.
- Provide proper ventilation when using Light extensively in a hot environment.
- Using Light when the Camcorder is powered by a car battery may shorten bulb life.
- Set Light to OFF when not in use.

CAUTION:



mark is indicated that light becomes hot.
Never cover Light while on.

Replacing the Bulb

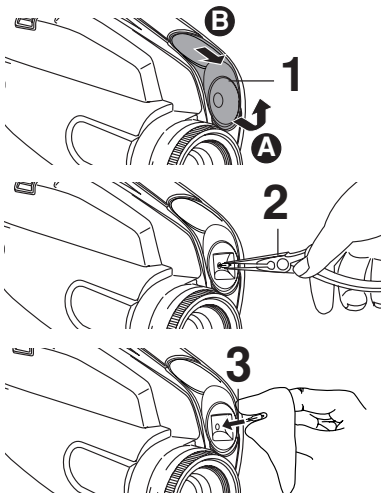

Before you begin...

- Connect Camcorder to power source.
- Set POWER to CAMERA.

1

Press **MENU** for MENU mode. Press **UP** or **DOWN** to select **LIGHT MODE**.

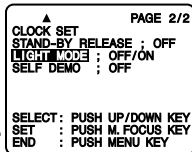

2

Press **M.FOCUS** to set OFF/ON or OFF/ON/AUTO. Press **MENU** to exit.

3

Press **LIGHT** repeatedly for Light ON, AUTO, or OFF.

- In AUTO, light turns itself on/off according to lighting conditions.

EVF or LCD Monitor

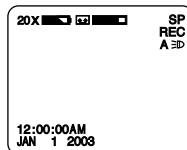

☺ : Light is on.

A ☺ : Light mode is auto.

Before you begin...

- Order Part No. VLLW0015 for replacement bulb.
- Set POWER to OFF.

1

Slightly raise portion **A** of lens cover to unhook, and slide portion **B** forward to remove.

2

Using Tweezers or needle-nose pliers, carefully remove bulb.

- Take unit to service center if you need assistance.

3

Replace bulb using a clean cloth or tissue. (Do not touch with fingers.)

4

Replace lens cover.

Note:

- Handle bulb gently. Excessive force may cause bulb to crack.

DANGER:

Use only replacement bulb (PART NO. VLLW0015) supplied by Panasonic to reduce risk of fire. Handle new bulb with cloth or tissue as skin oils will decrease bulb life. Remove lens cover and allow bulb to cool before replacing to avoid possible burn hazard.

Camera Recording

Recording via EVF or LCD Monitor

View recording scene on EVF (Electronic Viewer Finder) or LCD (Liquid Crystal Display) monitor.

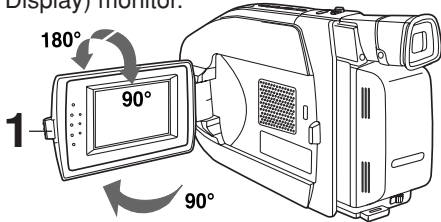

CAUTION :
Rotating partially open LCD monitor may block cassette door and damage Camcorder body.

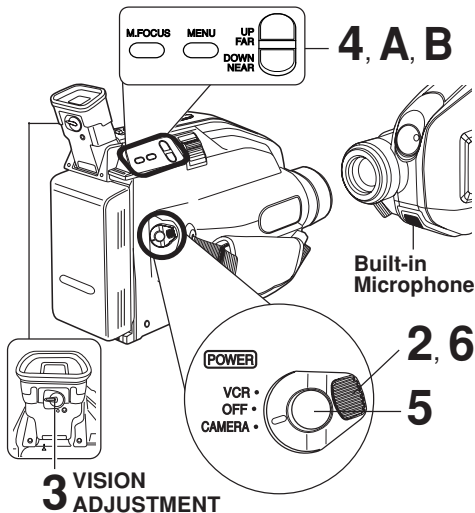

To adjust LCD BRIGHT

A Press **MENU** for MENU mode.
Press **UP** or **DOWN** to select **LCD BRIGHT**.

B Press **M.FOCUS** for LCD BRIGHT SETTING menu.
Press **UP** or **DOWN** to adjust LCD monitor brightness level.

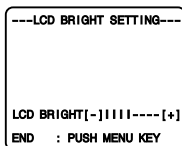
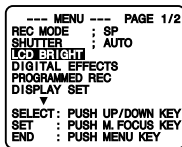

Before you begin...

- Connect Camcorder to power source.
- Insert cassette with record tab (page 11).

1 Press **LCD-OPEN** to unlock the LCD monitor. **Swing LCD monitor fully open and adjust viewing angle.**

2 Set **POWER** to **CAMERA**.

- Be sure **POWER** is fully turned to **EVF or LCD Monitor CAMERA** position. (Record/Pause mode)
- EVF or LCD monitor turns on/off by the **POWER** switch.
- Both EVF and LCD monitor turn on when LCD is at 180° (see above left). This allows both you and the subject to view the recording.



3 **LCD :** Adjust LCD monitor brightness level.

See **To adjust LCD BRIGHT** below.

EVF : Look into **EVF** and adjust **VISION ADJUSTMENT** to your eyesight.

4 Set **REC MODE** to “**SP**” or “**SLP**” in the **CAMERA MODE** Menu (page 13).

5 Press **RECORD/PAUSE** to start or pause recording.

6 Set **POWER** to **OFF** when finished.

- To remove the cassette, slide the **TAPE EJECT** switch (page 11).

Note:

- When Camcorder is aimed at excessively bright objects, or bright lights, a vertical bar may appear in the picture. This is normal for the CCD pick-up. Try to avoid this when possible.
- Using LCD monitor reduces battery operation time. Return LCD monitor to locked position when not in use.

Camera Recording

Before you begin...

- Connect Camcorder to power source.
- Insert cassette with record tab (page 11).

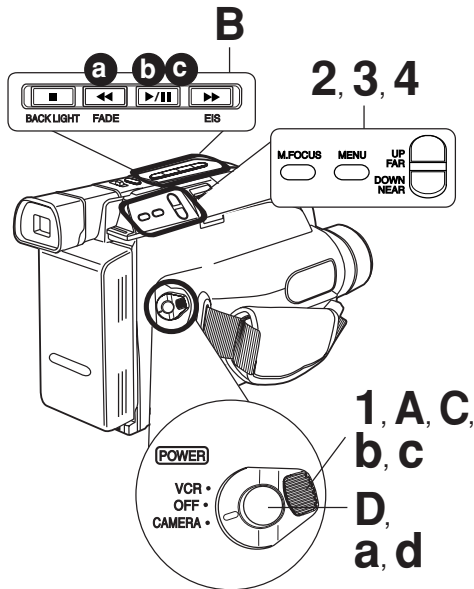

Stand-by Quick Release

If left in RECORD/PAUSE mode for 5 minutes, Camcorder switches to Stand-by mode to conserve battery. When set to ON, Stand-by Quick Release lets you resume recording by pressing RECORD/PAUSE two times. Stand-by Quick Release is set to OFF at the factory.

1 Set POWER to CAMERA.

2 Press MENU for MENU mode.

Press UP or DOWN to select STAND-BY RELEASE.

3 Press M.FOCUS to select ON or OFF.

ON : From Stand-by mode, press RECORD/PAUSE two times to resume recording.

OFF : From Stand-by mode, set POWER to OFF, then to CAMERA. Press RECORD/PAUSE to record.

4 Press MENU to exit.

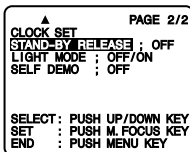

Manual Easy Editing

For proper continuity when taping from Stop mode or after attaching a new Battery.

A Set POWER to VCR.

B **a** Press ◀ (REWIND/SEARCH) to rewind a few seconds of tape.

b Press ▶/|| (PLAY/STILL) to review recording.

c Press ▶/|| (PLAY/STILL) where you want to continue recording.

C Set POWER to CAMERA.

D Press RECORD/PAUSE to resume recording.

Easy Edit Stand-by

For a smooth transition between scenes if recording is stopped, and then started within 24 hours.

a Press RECORD/PAUSE to stop recording.

b Set POWER to OFF and leave cassette in Camcorder.

C To resume recording, set POWER to CAMERA.

d Press RECORD/PAUSE to resume recording.

Note:

- Use Manual Easy Edit (left) if more than 24 hours before recording is resumed.

Camera Recording

Programmed Recording

Set a recording start and stop time. Or, set a 5 or 10 second interval recording to be done each minute.

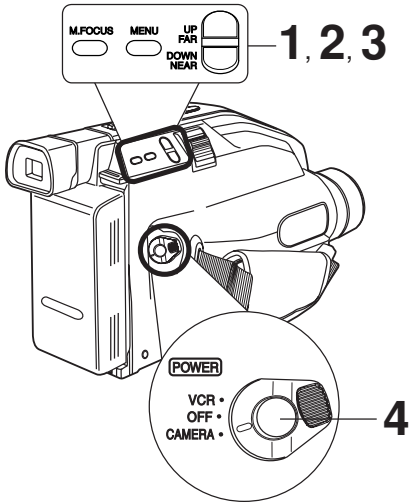

REC TIME :



- *1 Record 5 seconds each minute.
- *2 Record 10 seconds each minute.

Before you begin...

- Connect Camcorder to power source.
Use AC Adaptor for longer recordings.
- Insert cassette with record tab (page 11).
- Set **POWER** to **CAMERA**.

1 Press **MENU** for MENU mode. Press **UP** or **DOWN** to select **PROGRAMMED REC.**

```

--- MENU --- PAGE 1/2
REC MODE : SP
SHUTTER : AUTO
LCD BRIGHT
DIGITAL EFFECTS
PROGRAMMED REC
DISPLAY SET
SELECT: PUSH UP/DOWN KEY
SET : PUSH M. FOCUS KEY
END : PUSH MENU KEY
    
```

2 Press **M.FOCUS**.
(Current time is displayed.)
Each additional press of **M.FOCUS** increases start time by 30 minutes.

```

START : 10:20PM
REC TIME : 10MIN.

SELECT: PUSH UP/DOWN KEY
SET : PUSH M. FOCUS KEY
START : PUSH RECORD KEY
CANCEL: PUSH MENU KEY

10:20:00PM
    
```

3 Press **DOWN** to select **REC TIME**. Press **M.FOCUS** repeatedly to select one of the options shown at left.

```

START : 10:20PM
REC TIME : 10MIN.

SELECT: PUSH UP/DOWN KEY
SET : PUSH M. FOCUS KEY
START : PUSH RECORD KEY
CANCEL: PUSH MENU KEY

10:20:00PM
    
```

To cancel the setup, press **MENU** twice.

4 Press **RECORD/PAUSE** to place Camcorder in stand-by mode.

```

STAND-BY
START : 10:20PM
REC TIME : 10MIN.

10:20:00PM
JUN 1 2003
    
```

Recording will be done as scheduled.

Note:

- Start time may not be set over 24 hours from current time.
- Camcorder shuts off at tape end, or 12 hours after Interval Recording starts.
- To cancel, set **POWER** to **OFF**.

Playing Back Recordings

Before you begin...

- Connect Camcorder to power source.
- Insert recorded tape.

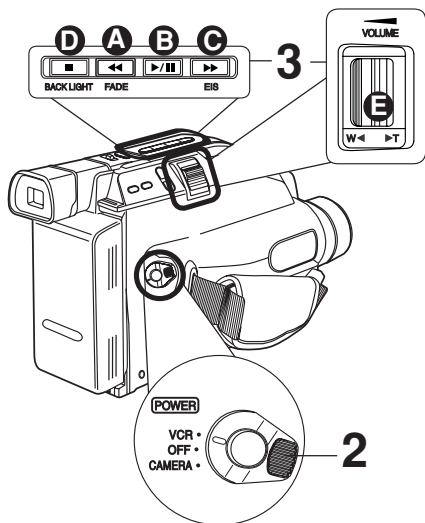
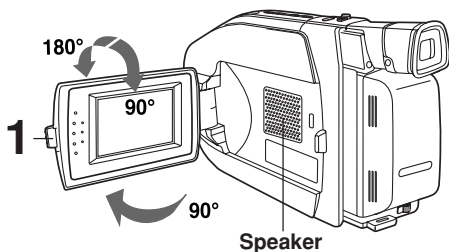

Tracking Control

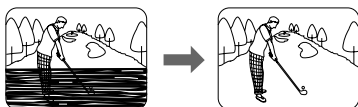

Auto Tracking

Continuously analyzes each recording for optimum picture quality.

Manual Tracking

Some recordings require manual adjustment to reduce noise.

Press **UP** or **DOWN** until Playback picture clears up.

Press **M.FOCUS** to return to Auto Tracking.

Playback on EVF or LCD Monitor

- 1 Press **LCD-OPEN** and swing LCD monitor fully open.
- 2 Set **POWER** to **VCR**.
 - If tape has no record tab, auto playback begins.
 - EVF or LCD monitor turns on/off by the **POWER** switch.
- 3 **Playback function buttons.**
 - A** ◀◀ (**REWIND/SEARCH**) : Rewind tape.
 - B** ▶▶/|| (**PLAY/STILL**) : Play tape.
 - C** ▶▶▶ (**FAST FORWARD/SEARCH**) : Fast Forward tape.
 - D** ■ (**STOP**) : Stop tape.
 - E** **VOLUME** : During playback, adjust volume of speaker.

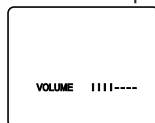

Press "W" : ◀◀ Volume down. Press "T" : ▶▶ Volume up.

Note:

- Using LCD monitor reduces battery operating time. Return LCD monitor to locked position when not in use.
- During playback, press **MENU** to adjust LCD monitor brightness (page 17).

Special Effects

Quick Visual Search

Search Speed

- SP (Standard Play) : 3 times normal.
- SLP (Super Long Play) : 9 times normal.

During playback, press:

- ▶▶▶ (**FAST FORWARD/SEARCH**) : fast forward search
 - ◀◀ (**REWIND/SEARCH**) : rewind search
- Press again or press ▶▶/|| (**PLAY/STILL**) for normal play.

Still Picture

Press ▶▶/|| (**PLAY/STILL**) to freeze picture.

Press again for normal play.

This feature works best in SLP mode (page 11).

Note:

- During search, horizontal noise bars will appear. Audio is muted.
- To protect video heads and tape, operating modes will revert as follows after 5 minutes:
Still → Stand-by
Stand-by → Power off (when Battery Pack is used).
- Tape auto-rewinds if played or fast forwarded to end.

Playing Back Recordings

TV Playback or Viewing

Connect Camcorder to a TV to view playback or recordings in progress.

Connections

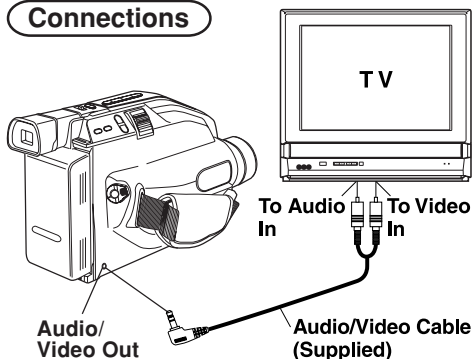

Before you begin...

- Connect Camcorder to power source.
- Make all TV-Camcorder connections.

- 1** Set **POWER** to:
VCR → view playback.
CAMERA → view picture as it is recorded.
- 2** Turn TV ON and set to **LINE INPUT**. See TV owner's manual.
- 3** Begin playback or recording.

VCR Playback using PlayPak (Optional)

Load Battery in PlayPak

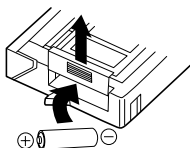

Remove Battery lid and insert AA battery.

- Do not reverse polarity.
- Replace battery when tape loading/unloading takes longer than usual.

Insert VHS Cassette in PlayPak

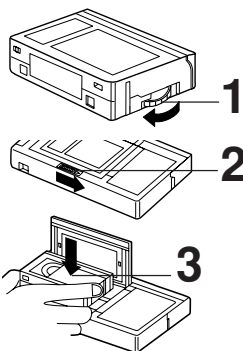

- 1** Turn **VHS** cassette **Tape Wheel** in direction of arrow to take up any slack.
- 2** Slide **RELEASE** to open cassette lid.
- 3** Insert the **VHS** cassette with the window up and on the left, then snap lid shut.

- Do not obstruct cassette reel while loading.
- Allow PlayPak Load Detector to fully retract before using in VHS VCR.

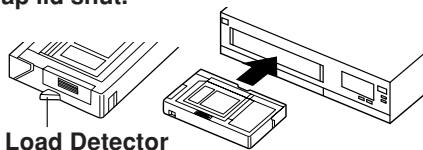

Remove VHS Cassette

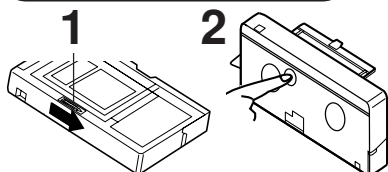

- 1** Slide **RELEASE** and wait for lid to open.
- 2** Push cassette out through hole in bottom of PlayPak with your finger.

Copying your Tapes (dubbing)

Connections

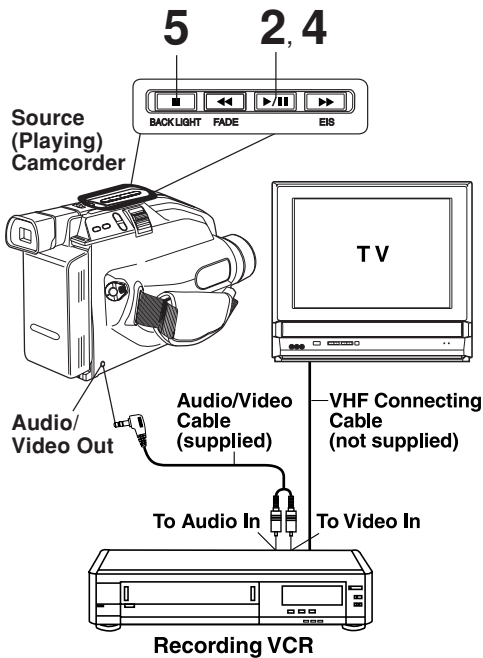

Monitor with your TV

- Turn TV on and tune to VCR channel (CH3 or CH4).
- Set TV/VCR Selector on VCR to VCR.

Before you begin...

- Make Camcorder-VCR connections (see left).
- Turn both units on.
- Set VCR input signal to LINE.
Please see VCR owner's manual.
- Set Camcorder POWER to VCR.

- 1** Insert a pre-recorded tape into Camcorder and a blank tape with record tab into VCR.
- 2** Press **▶/|| (PLAY/STILL)** on Camcorder, then **press again** at starting point.
- 3** Press **REC**, then **STILL/PAUSE** on VCR.
- 4** Press **▶/|| (PLAY/STILL)** on Camcorder and **STILL/PAUSE** on VCR to start copying.
- 5** Press **■ (STOP)** on both units to stop copying.

Note:

- Camcorder will only playback tapes recorded in SP or SLP mode.
- Dubbing may reduce picture quality.

CAUTION:

Unauthorized exchanging and/or copying of copyrighted recordings may be copyright infringement.

Four-Speed Power Zoom

Zoom in (close up) and out (wide angle) in one of four speeds ranging from slow (16 seconds) to fast (2 seconds).

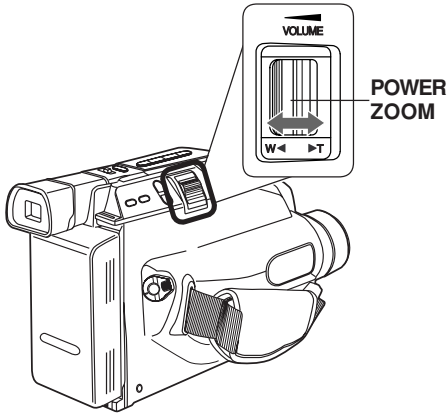

Before you begin...

- Connect Camcorder to power source.
- Set POWER to CAMERA.

Zoom In ("T")

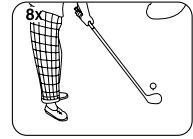

Zoom Out ("W")

• Zoom slowly:

Lightly press "T" (telephoto) or "W" (wide angle) POWER ZOOM button.

• Zoom quickly:

Apply more pressure to the button.

Backlight

Use when subject is darker than surroundings, in shadowed area, or in front of the light source.

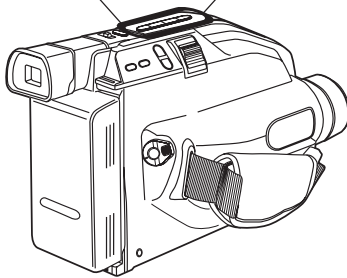

Before you begin...

- Connect Camcorder to power source.
- Set POWER to CAMERA.

Press ■ (BACK LIGHT) while recording to select the level of backlight compensation.

In normal lighting, press ■ (BACK LIGHT) repeatedly until no indicator is displayed.

EVF or LCD Monitor

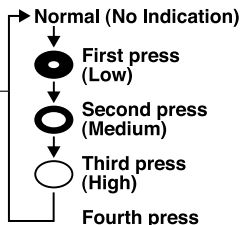
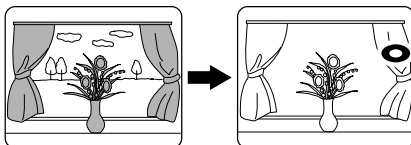

Focus

Before you begin...

- Connect Camcorder to power source.
- Set POWER to CAMERA.

Auto Focus

Camcorder automatically focuses on subject even during zooming.

Auto Focus is on when “MF” is not displayed in EVF or LCD monitor.

Press **M.FOCUS** to remove “MF” in EVF or LCD monitor if necessary.

Manual Focus

Use Manual Focus (MF) when :

- recording through glass.
- lighting is poor.
- subject is far away with objects in foreground.
- subject has distinct horizontal lines.
- subject is not centered in EVF or LCD monitor.
- subject has a shiny surface.
- subject is slanted.
- subject is bright and flat, like a white wall.
- subject has fast motion, like a golf swing.

EVF or LCD Monitor

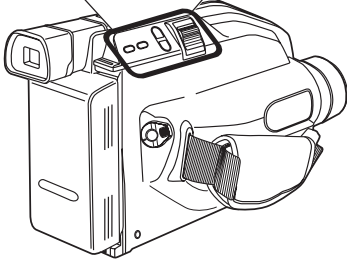
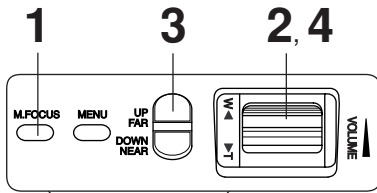

1 Press **M.FOCUS** so “MF” (Manual Focus) appears in EVF or LCD monitor.

2 Press **“T” (telephoto)** on **POWER ZOOM** to maximum zoom in.

3 Press **UP (FAR)** or **DOWN (NEAR)** until subject is in focus.
• Back away from subject if necessary.

4 Press **“W” (wide angle)** on **POWER ZOOM** as desired.

• **Refocus as needed** when aiming at new scenes.

Macro Focus (close-ups)

Auto Focus functions up to 12.7 mm (1/2 inch) from subject.

Press **“W”** on **POWER ZOOM** to maximum wide angle.

Bring Camcorder up close to the subject.

High Speed Shutter

Improves Still or Slow Motion playback picture of high speed subjects (e.g. a tennis stroke), when viewed on Camcorder or 3 or 4 head VCR.

Auto Shutter

In AUTO mode (no indication in EVF or LCD Monitor), shutter speed is auto-adjusted from 1/60 to 1/350 according to subject brightness.

- AUTO mode is selected each time POWER is set to CAMERA.

Manual Selection

The faster the shutter speed, the more light is needed for proper picture and color quality. High Speed Shutter indication flashes if light is inadequate. Provide additional light.

Before you begin...

- Connect Camcorder to power source.
- Insert cassette with record tab (page 11).
- Set POWER to CAMERA.

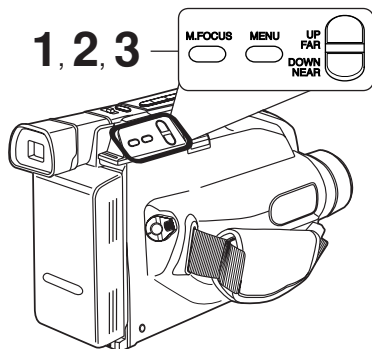

- 1 Press **MENU** for MENU mode.
Press **UP** or **DOWN** to select **SHUTTER**.

- 2 Press **M.FOCUS** repeatedly to select shutter speed.

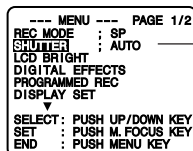

→ AUTO → 1/60 → 1/100 → 1/250 → 1/500
← 1/10000 ← 1/4000 ← 1/2000 ← 1/1000 ←

- 3 Press **MENU** to exit.

Note:

- Shutter speed cannot be set to 1/60 if Digital E.I.S. feature is set to ON.
- Provide additional halogen or tungsten light for use indoors or in poor light. Fluorescent light degrades picture.
- Auto Focus may not function properly if high speed shutter is used in inadequate light.
- Setting reverts to AUTO each time POWER is set to CAMERA.

Auto Fade

An interesting way to open and close scenes.

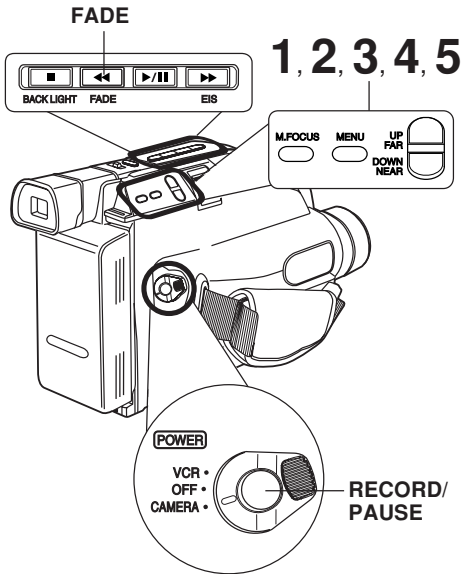

1, 2, 3, 4, 5

Before you begin...

- Connect Camcorder to power source.
- Set POWER to CAMERA.

1 Press **MENU** for MENU mode.
Press **UP** or **DOWN** to select **DIGITAL EFFECTS**.

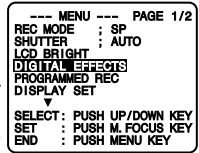

2 Press **M.FOCUS** for DIGITAL EFFECTS menu. Press **UP** or **DOWN** to select **FADE**.

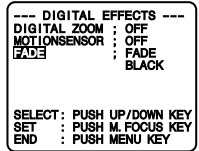

3 Press **M.FOCUS** for FADE menu. Press **UP** or **DOWN** to select **AUTO FADE**.

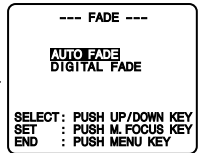

4 Press **M.FOCUS** for AUTO FADE ; COLOR menu. Press **UP** or **DOWN** to select BLACK or WHITE.

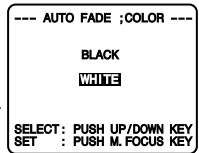

5 Press **M.FOCUS** to confirm entry.
Press **MENU** twice to exit.

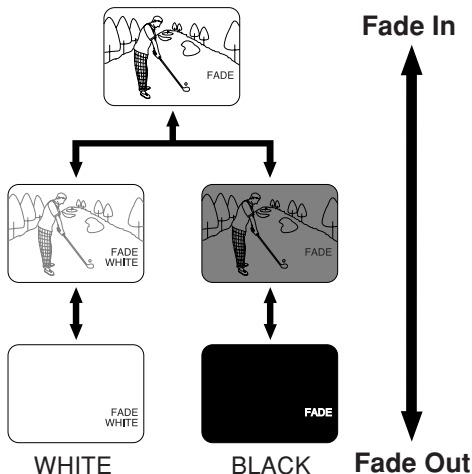

Fade In:

In **RECORD/PAUSE** mode, press **◀ (FADE)** so "FADE" flashes in EVF or LCD monitor.

Press **RECORD/PAUSE**.

Recording starts as picture and sound gradually fade in.

Fade Out:

While recording, press **◀ (FADE)** so "FADE" flashes in EVF or LCD monitor.

Press **RECORD/PAUSE**.

Picture and sound gradually fade out, and recording is paused.

If **◀ (FADE)** is pressed accidentally, press again so "FADE" disappears in EVF or LCD monitor.

Color Digital Fade

Choose from 7 fade effects in 8 different colors.

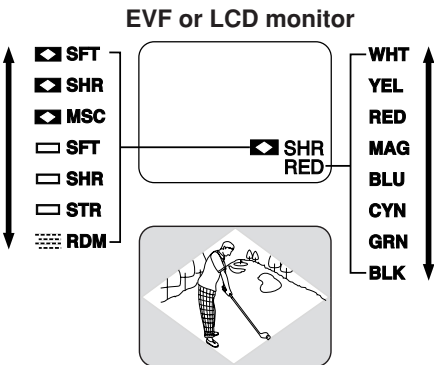
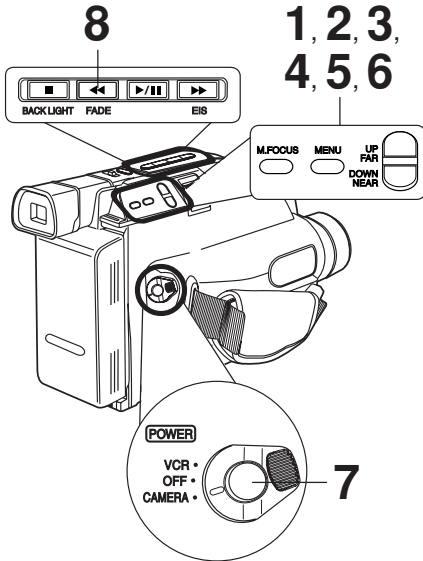

■ For more effects, stop fade in or fade out at any time (except RANDOM mode) by pressing **◀◀** (FADE). Then, press **◀◀** (FADE) to resume fade.

Note:

- Audio is not affected by fade.
- To cancel Digital Fade, do steps 1-3 and 6. In step 3, select AUTO FADE.

Before you begin...

- Connect Camcorder to power source.
- Set POWER to CAMERA.

1 Press **MENU** for MENU mode. Press **UP** or **DOWN** to select **DIGITAL EFFECTS**.

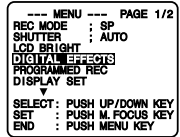

2 Press **M.FOCUS** for DIGITAL EFFECTS menu. Press **UP** or **DOWN** to select **FADE**.

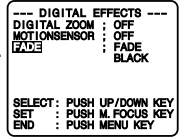

3 Press **M.FOCUS** for FADE menu. Press **UP** or **DOWN** to select **DIGITAL FADE**.

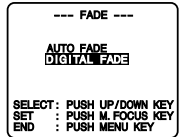

4 Press **M.FOCUS** for DIGITAL FADE menu. Press **UP** or **DOWN** to select **TYPE**. Press **M.FOCUS** for TYPE menu. Press **UP** or **DOWN** to select from 7 different fade types.

- A preview of each fade type is displayed as it is selected.

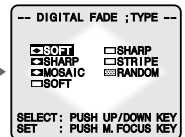
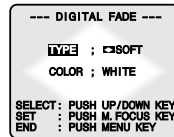

5 Press **M.FOCUS** for DIGITAL FADE menu. Press **UP** or **DOWN** to select **COLOR**. Press **M.FOCUS** for COLOR menu. Press **UP** or **DOWN** to select from 8 colors.

- A preview of each color is displayed as it is selected.

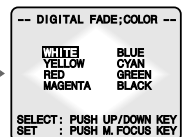
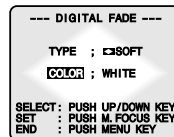

6 Press **M.FOCUS** to confirm entry. Press **MENU** three times to exit.

7 Start recording (page 17).

8 Press **◀◀** (FADE) for about 2 seconds to fade out during recording (selected fade type flashes). Press **◀◀** (FADE) again to fade in.

Special Features

Digital Zoom

Power Zoom magnification is digitally increased.

Before you begin...

- Connect Camcorder to power source.
- Set POWER to CAMERA.

1, 2, 3, 4, 5

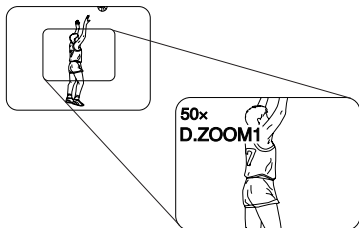
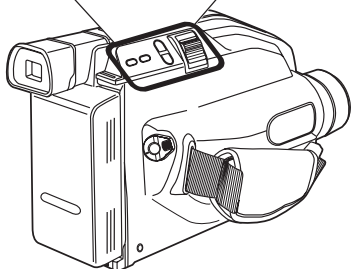
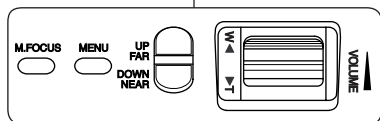

1 Press **MENU** for MENU mode. Press **UP** or **DOWN** to select **DIGITAL EFFECTS**.

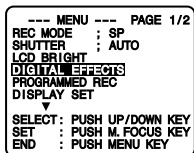

2 Press **M.FOCUS** for DIGITAL EFFECTS menu. Press **UP** or **DOWN** to select **DIGITAL ZOOM**.

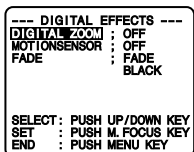

3 Press **M.FOCUS repeatedly** to select D.ZOOM1, D.ZOOM2, or OFF.

D.ZOOM 1 : 150x maximum
 D.ZOOM 2 : 700x maximum
 OFF : Turn off D.ZOOM

The Higher digital magnification levels may cause picture distortion.

4 Press **MENU** twice to exit.

5 Press **"T" on POWER ZOOM**. Digital Zoom starts when normal zoom reaches maximum (20x).

- Zoom level appears in EVF or LCD monitor.
- POWER ZOOM switch controls digital zoom level.
- Normal zoom resumes when level falls to 20x.

6 Repeat steps 2~3 to select OFF to cancel this feature.

Digital Electronic Image Stabilization (E.I.S.)

Helps stabilize picture when recording in unstable situations.

Before you begin...

- Connect Camcorder to power source.
- Set POWER to CAMERA.

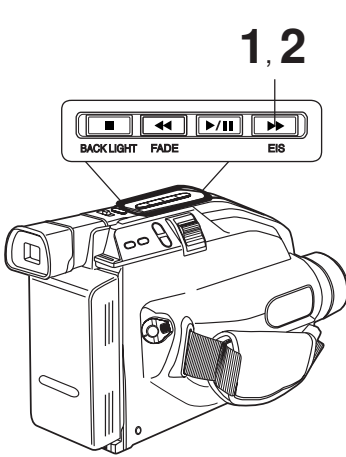

1 Press **▶▶ (EIS)** to display “EIS” in the EVF or LCD monitor.

- Image becomes slightly enlarged and shutter speed auto-adjusts from 1/80 to 1/350 according to brightness.
- Use High Speed Shutter (page 25) if needed. Shutter speed setting remains after EIS is canceled.

2 Press **▶▶ (EIS)** again to cancel when not in use.

E.I.S. may not function during...

- extreme Camcorder movement.
- recording of subjects with distinct horizontal or vertical stripes.
- low light situations (EIS indicator flashes).
- intense fluorescent lighting situations.
- recording of very fast motion.

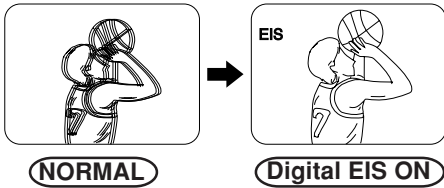

MotionSensor

Recording starts automatically if motion is detected.

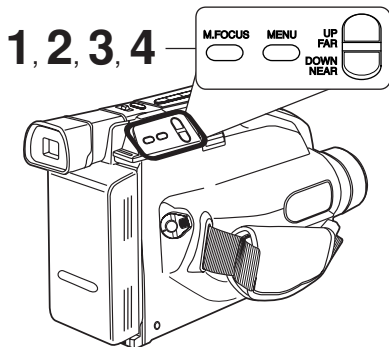

MotionSensor may mistakenly start when:

- background is plain, like a white wall, or has distinct vertical, horizontal, or slanted stripes, like a venetian blind.
- brightness suddenly changes.

MotionSensor may not start when:

- motion is very slow or fast.
- moving object is very small.
- motion occurs only in 1 corner of viewing area.
- in poor lighting (in this case, MOTIONSENSOR flashes).
- background is plain, like a white wall, or has distinct horizontal or vertical stripes.

Before you begin...

- Connect Camcorder to power source.
Use AC Adaptor for longer recordings.
- Insert cassette with record tab (page 11).
- Set POWER to CAMERA.
- Securely position and aim Camcorder.

1 Press **MENU** for MENU mode. Press **UP** or **DOWN** to select **DIGITAL EFFECTS**.

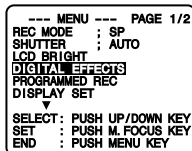

2 Press **M.FOCUS** for DIGITAL EFFECTS menu.
Press **UP** or **DOWN** to select **MOTIONSENSOR**.

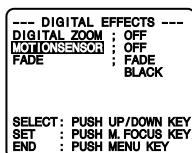

3 Press **M.FOCUS** to select ON.

4 Press **MENU** twice for MotionSensor stand-by mode. (If cassette is not inserted, "REC" will flash.)

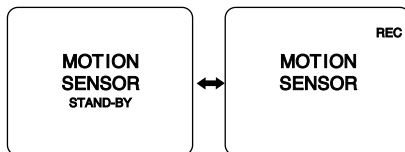

- Recording will start about 3 seconds after motion is detected.
- Date and time are recorded if displayed in EVF or LCD monitor (page 15).
- Recording stops about 30 seconds after motion ceases.

To cancel MotionSensor Mode, set **POWER to OFF**.

Note:

- MotionSensor recording starts if Camcorder is bumped or repositioned.
- This feature is not available during normal recording.
- While in MotionSensor stand-by, the following functions are not available: Record/Pause, Stand-by mode, Digital E.I.S., Video Effects (Auto/Digital Fade).

Viewfinder/LCD Monitor Indications

Tape remaining and battery charge level can be displayed.

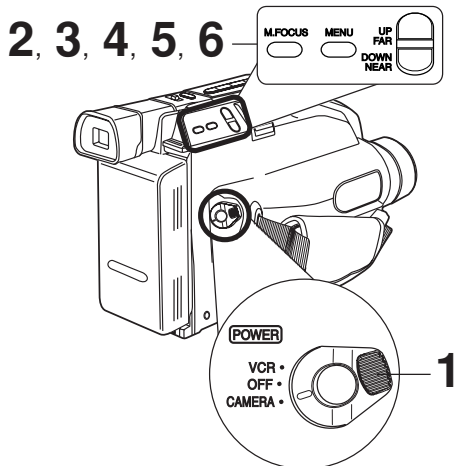

Before you begin...

- Connect Camcorder to power source.

1 Set **POWER** to **CAMERA**.

2 Press **MENU** for MENU mode.
Press **UP** or **DOWN** to select **DISPLAY SET**.

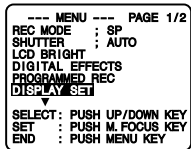

3 Press **M.FOCUS** for DISPLAY SET menu.
Press **UP** or **DOWN** to select **MODE SELECT**.

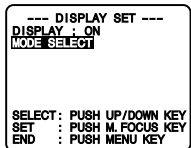

4 Press **M.FOCUS** for MODE SELECT menu.

5 Press **M.FOCUS** repeatedly to select the following displays.

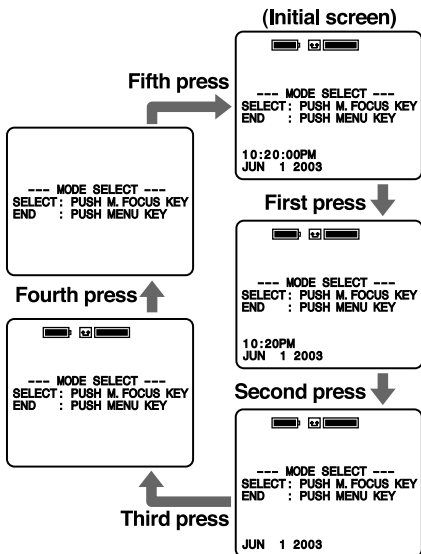
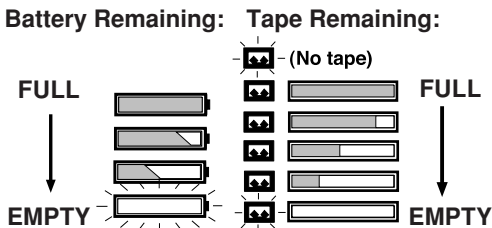

6 Press **MENU** three times to exit.

- Tape remaining indicator operates a few seconds after tape starts moving.

Viewfinder/LCD Monitor Indications

Recording the Date and Time

- 1** Repeat steps 1-5 on page 31 to select time/date, date only, or no display.

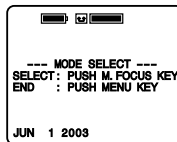
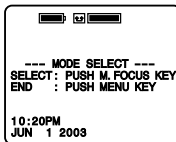

- 2** Start a recording (page 17).
 • Only the Date and/or Time are recorded.

Display-Off Mode

- A** Set **POWER** to **CAMERA** or **VCR**.

- B** Press **MENU** for MENU mode.
 Press **UP** or **DOWN** to select **DISPLAY SET**.

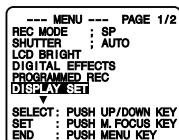

[CAMERA MODE]

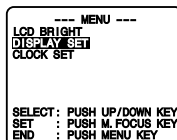

[VCR MODE]

- C** Press **M.FOCUS** for **DISPLAY SET** menu.
 Press **UP** or **DOWN** to select **DISPLAY**.

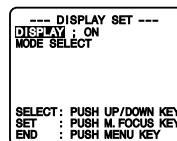

- D** Press **M.FOCUS** to select OFF.
 Press **MENU** twice to exit.

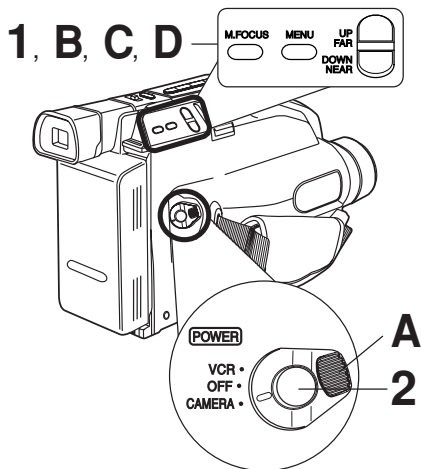
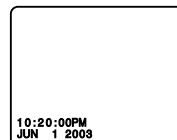

Indications are restored the next time Camcorder is turned on.

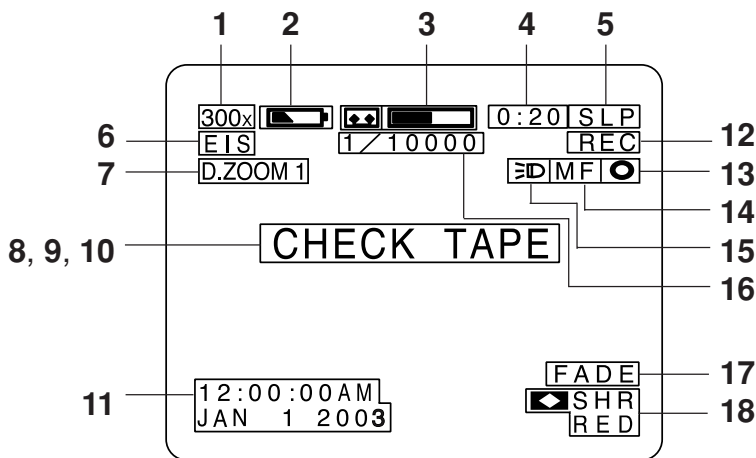

Viewfinder/LCD Monitor Indications

CAMERA/VCR mode

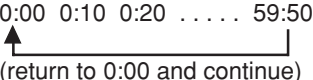

- 1 Zoom Magnification level** (pages 23, 28).
- 2 Battery Remaining**  (page 31).
“WARNING LOW BATTERY” appears and Camcorder shuts off after 15 seconds.
- 3 Tape Remaining** (page 31).
“” flashes and “TAPE END” appears for 5 seconds when:
 - End of tape is reached.
 “” flashes for 1 minute and “CHECK TAPE” appears for 5 seconds when:
 - RECORD/PAUSE is pressed with no cassette, or cassette has no record tab in Camera (RECORD) mode.
 - PLAY, FF or REW is pressed with no cassette inserted in VCR mode.
- 4 10-Second Reminder**
Each time a recording is started, a 10 second incremental display (up to 59:50) lets you monitor how long one scene is recorded.
 0:00 0:10 0:20 59:50

 (return to 0:00 and continue)
- 5 TAPE SPEED** (pages 11, 17).
(SP=standard play, SLP=super long play).
- 6 Digital E.I.S.** (page 29).
- 7 Digital Zoom** (page 28).
- 8 VCR-MODE**
“VCR-MODE” appears for 1 minute when POWER is set to VCR or if RECORD/PAUSE is pressed in VCR mode.
- 9 DEW**
If moisture condensation occurs in unit, “WARNING DEW DETECTED” appears, and Camcorder will shut off in 15 seconds. Wait until “WARNING” no longer indicates when Camcorder is turned on to use.
- 10 MotionSensor** (page 30).
- 11 Date and Time** (pages 14, 15).
- 12 Operating Mode**
 - REC (record) • PAUSE
 - FF (fast forward) • PLAY
 - REW (rewind)
- 13 Backlight** (page 23).
- 14 Manual Focus** (page 24).
- 15 Light ON/OFF/AUTO** (page 16).
- 16 High Speed Shutter** (page 25).
- 17 Fade** (page 26).
- 18 Color Digital Fade** (page 27).

Notes On Operations

Notice

This product has a fluorescent lamp that contains a small amount of mercury. It also contains lead in some components. Disposal of these materials may be regulated in your community due to environmental considerations. For disposal or recycling information please contact your local authorities, or the Electronics Industries Alliance: <<http://www.eiae.org>.>

U.S.A. CONSUMERS: ATTENTION :



A nickel cadmium battery that is recyclable powers the product you have purchased. At the end of its useful life, under various state and local laws, it is illegal to dispose of this battery into your municipal waste stream. Please call 1-800-8-BATTERY for information on how to recycle this battery.

Replacing Clock Battery

The clock battery is pre-installed. Follow the steps below if replacement becomes necessary.

WARNING:

Replace battery with Panasonic or Newsun type CR2025 only. Use of another battery may present a risk of fire or explosion.

Caution: Battery may explode if mistreated. Dispose of used battery promptly. Keep away from children. Do not recharge, disassemble or dispose of in fire.

Clock Battery

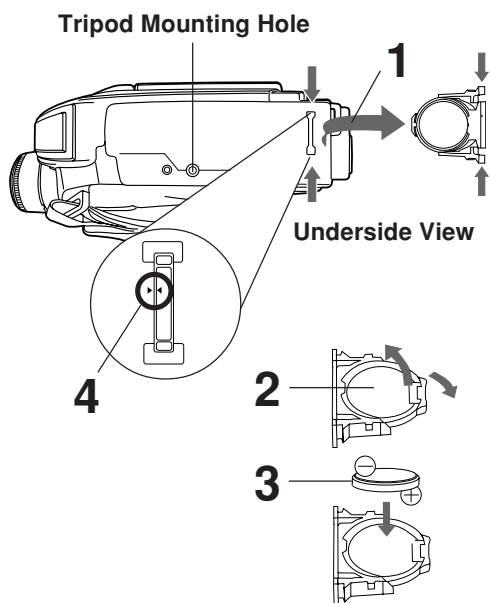

- 1** While pinching the 2 tabs, pull Battery Tray out.
- 2** Bend middle tab out and remove Battery.
- 3** Snap new Battery (\oplus mark down) into Battery Tray.
 - Do not reverse the polarity.
- 4** Insert Battery Tray so the triangle marks meet.







Note:

- Keep Battery out of children's reach. Swallowing it may be harmful.
- Improper installation, discharge, or missing battery causes "CLOCK BATTERY" to appear.
- Battery life is approximately 5 years.

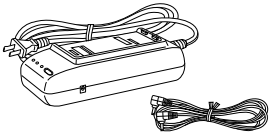
Palmcorder Accessory System

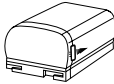
To order instructions, see the Accessory Order Form page.

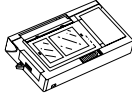
- The listed standard battery use times are based on continuous recording using this Palmcorder.

Accessory #	Figure	Description	Price
PV-A20		AC Adaptor with DC Power Cable (Charging of the Nickel Cadmium Battery or Nickel Metal Hydride Battery)	Call For Pricing
HHR-V60A/1B		Up to 6 hr Battery Pack (Rechargeable Nickel Metal Hydride Battery)	\$119.95
HHR-V40A/1B		Up to 4 hr Battery Pack (Rechargeable Nickel Metal Hydride Battery)	\$69.95
HHR-V20A/1B		Up to 2 hr Battery Pack (Rechargeable Nickel Metal Hydride Battery)	\$59.95
PV-AA6		"AA" Battery Case	\$20.00
PV-C16		Car Battery Cord	\$70.00
PV-P1		VHS PlayPak	\$39.95
PV-H18A		Carrying Case	\$49.95

Note:

- Prices subject to change without notice.

Palmcorder Accessory Order Form

Please photocopy this form when placing an order.

1. Palmcorder Model # _____

2. Items Ordered

Accessory #	Description	Price Each	Quantity	Total Price
Subtotal				
Your State & Local Sales Tax				
Shipping & Handling				6.95
Total Enclosed				

3. Method of payment (check one)

- Check or Money Order enclosed (NO C.O.D.SHIPMENTS)
- VISA Credit Card # _____
- MasterCard Expiration Date _____
- Discover Customer Signature _____

Make Check or Money Order to: PANASONIC ACCESSORIES

(Please do not send cash)

4. Shipping information (UPS delivery requires complete street address)

Ship To:

Mr.

Mrs.

Ms.

First _____ Last _____

Phone #:

Day () _____

Street Address _____

Night () _____

City _____ State _____ Zip _____

TO OBTAIN ANY OF OUR PALMCORDER ACCESSORIES YOU CAN DO ANY OF THE FOLLOWING:

VISIT YOUR LOCAL PANASONIC DEALER

OR

CALL PANASONIC'S ACCESSORY ORDER LINE AT 1-800-332-5368

[6 AM-5 PM M-F, 6 AM-10:30 AM SAT, PACIFIC TIME]

OR

MAIL THIS ORDER TO: PANASONIC SERVICES COMPANY ACCESSORY
ORDER OFFICE

20421 84th Avenue South Kent, WA. 98032

For Your Information

Specifications

Power Source:	Compact VHS Camcorder: DC 6 V AC Adaptor: 110/120/220/240 V AC, 50/60 Hz Battery: Nickel-Cadmium Type DC 6 V
Power Consumption:	Compact VHS Camcorder: 6V DC 8.5 W (Max. 11.5 W) AC Adaptor: 19 W 1.2 W (when not in use.)
Video Signal:	EIA Standard (525 lines, 60 fields) NTSC color signal
Video Recording System:	2 rotary heads plus flying erase head Helical scanning system
Audio:	1 track
Pick-Up System:	Sequential color difference field reverse system
Pick-Up Device:	One integral color filter Charge Coupled Device (CCD)
Lens:	20:1 zoom lens, F1:1.7 with auto iris control Focal length: 2.8 mm - 56.0 mm 4 speed power zoom function
Viewfinder:	8.4 mm (0.33 inch) Electronic Viewfinder
LCD Monitor:	63.5 mm (2.5 inch) Liquid Crystal Display
Minimum Illumination Required:	1.6 lx (F1:1.7) 0.16 footcandles
Operating Temperature:	0 °C~40 °C (32 °F~104 °F)
Operating Humidity:	10 %~75 %
Weight:	Compact VHS Camcorder: 0.874 kg 1.93 lbs. AC Adaptor: 0.3 kg 0.66 lbs.
Dimensions:	Compact VHS Camcorder: 87.2 (W) × 123 (H) × 226 (D) mm 3-3/8 (W) × 4-7/8 (H) × 8-7/8 (D) inch AC Adaptor: 68 (W) × 41 (H) × 140 (D) mm 2-11/16 (W) × 1-5/8 (H) × 5-1/2 (D) inch

Weight and dimensions shown are approximate.
Designs and specifications are subject to change without notice.

Before Requesting Service

If a problem arises, you may be able to correct it yourself.
See Symptom and Correction list below.

Symptom	Correction
No picture in EVF or LCD monitor ...	<ul style="list-style-type: none"> • Connect Power Source. (pp. 9, 10) • Set POWER to VCR or CAMERA. (pp. 17, 20) • Check for Dew Indication. (p. 33) • Use fully charged Battery. (p. 9) • Firmly connect all needed cables. (p. 10)
Video cassette cannot be inserted ...	<ul style="list-style-type: none"> • Connect Power Source. (pp. 9, 10) • Insert cassette, window side facing out. (p. 11)
Video cassette cannot be removed ...	<ul style="list-style-type: none"> • Connect Power Source. (pp. 9, 10)
Operation buttons do not work ...	<ul style="list-style-type: none"> • Check for Dew Indication. (p. 33)
Recording cannot be done ...	<ul style="list-style-type: none"> • Make sure record tab is intact. (p. 11) • Check Battery Indicator. (p. 31) • Check for Dew Indication. (p. 33)
Auto Focus does not operate ...	<ul style="list-style-type: none"> • Set FOCUS to AUTO. (p. 24) • Set POWER to CAMERA. (p. 17)
Sound from microphone can't be monitored ...	<ul style="list-style-type: none"> • Set unit to REC or Record/Pause mode.
Camera picture is too dark ...	<ul style="list-style-type: none"> • Set HIGH SPEED SHUTTER to AUTO. (p. 25)
No playback picture, or the playback picture is noisy or contains streaks ...	<ul style="list-style-type: none"> • Press UP/DOWN button during playback (Tracking Control). (p.20)
"Panasonic ITS TAPES CAN PLAY IN YOUR VCR ..." appears in EVF or LCD Monitor ...	<ul style="list-style-type: none"> • Set POWER to CAMERA, then set SELF DEMO : OFF in MENU screen to cancel Demo mode. (p. 7)
Top of playback picture waves back and forth excessively ...	<ul style="list-style-type: none"> • A playback signal is not as stable as an off the air TV signal, so the top of your TV screen may appear bent or unstable during playback. This is called, "Horizontal AFC time constant change." To correct, slowly turn the TV horizontal hold control. If your TV does not have this control, or adjusting it does not help, contact your TV service center. (Some nominal service charges may be required.)

Video Head Cleaning



Clogged Video Head

While head cleaning is normally not needed, playing old or damaged tapes may clog the heads. When playback picture resembles example at the left, head cleaning is required.

Ideally, head cleaning should be performed by a qualified service technician. When this is not possible, purchase a head cleaning cassette. Be sure to follow cleaning cassette instructions exactly and only use when symptoms occur.

Request for Service Notice

Please photocopy this form when making a request for service notice.

Request for Service Notice:

In the unlikely event this product needs service.

- Please include your **proof of purchase**.
(Failure to do so will delay your repair.)
- To further speed your repair please provide an explanation of what is wrong with the unit and any symptom it is exhibiting.

Mail this completed form and your Proof of Purchase along with your unit to:
Panasonic Services Company
1705 N. Randall Road
Elgin, IL. 60123-7847
Attn: Camcorder Repair

Limited Warranty

PANASONIC CONSUMER ELECTRONICS COMPANY,
DIVISION OF MATSUSHITA ELECTRIC
CORPORATION OF AMERICA
One Panasonic Way Secaucus, New Jersey 07094

PANASONIC SALES COMPANY, DIVISION OF MATSUSHITA
ELECTRIC OF PUERTO RICO, INC.,
AVE. 65 de Infertería, Km. 9.5 San Gabriel Industrial Park,
Carolina, Puerto Rico 00985

Panasonic/Quasar Video Products Limited Warranty

Limited Warranty Coverage

If your product does not work properly because of a defect in materials or workmanship, Panasonic Consumer Electronics Company or Panasonic Sales Company (collectively referred to as "the warrantor") will, for the length of the period indicated on the chart below, which starts with the date of original purchase ("warranty period"), at its option either (a) repair your product with new or refurbished parts, or (b) replace it with a new or a refurbished product. The decision to repair or replace will be made by the warrantor.

Product	Parts	Labor	Service	Contact Number
Camcorder	One (1) Year (except CCD Image Sensor)	Ninety (90) Days	Carry-In or Mail-In	1-800-211-PANA(7262)
	CCD Image Sensor - 6 (Six) Months	Ninety (90) Days		
DVD/VCR Deck, A/V Mixer	One (1) Year	Ninety (90) Days	Carry-In or Mail-In	1-800-211-PANA(7262)
TV/VCR, TV/DVD, TV/DVD/VCR Combination	One (1) Year (except CRT)	Ninety (90) Days	Carry-In: 21" CRT and Smaller In-Home or Carry-In: 22" CRT and Larger	1-800-211-PANA(7262)
	CRT - Two (2) Years	Ninety (90) Days		
TV/HDR Combination	One (1) Year (except CRT)	Ninety (90) Days	In-Home or Carry-In	1-888-843-9788
	CRT - Two (2) Years	Ninety (90) Days		
Rechargeable Batteries (in exchange for defective item)	Ten (10) Days	Not Applicable	Carry-In or Mail-In	1-800-211-PANA(7262)
Tape (in exchange for defective item)	Five (5) Days	Not Applicable	Carry-In or Mail-In	1-800-211-PANA(7262)
Memory Cards (in exchange for defective item)	Ninety (90) Days	Not Applicable	Carry-In or Mail-In	1-800-211-PANA(7262)

During the "Labor" warranty period there will be no charge for labor. During the "Parts" warranty period, there will be no charge for parts. You must carry-in or mail-in your product or arrange for in-home service, as applicable, during the warranty period. If non-rechargeable batteries are included, they are not warranted. This warranty only applies to products purchased and serviced in the United States or Puerto Rico. This warranty is extended only to the original purchaser of a new product which was not sold "as is". A purchase receipt or other proof of the original purchase date is required for warranty service.

Carry-In, Mail-in or In-Home Service

For Carry-In, Mail-In or In-Home Service (as applicable) in the United States call toll free contact number listed above or visit Panasonic Web Site: <http://www.panasonic.com>

For assistance in Puerto Rico call Panasonic Sales Company (787)-750-4300 or fax (787)-768-2910.

In-Home service, if applicable, requires clear, complete and easy access to the product by the authorized servicer and does not include removal or re-installation of an installed product. It is possible that certain in-home repairs will not be completed in-home, but will require that the product, or parts of the product, be removed for shop diagnosis and/or repair and then returned.

Limited Warranty Limits And Exclusions

This warranty ONLY COVERS failures due to defects in materials or workmanship, and DOES NOT COVER normal wear and tear or cosmetic damage, nor does it cover markings or retained images on the picture tube resulting from viewing fixed images (including, among other things, letterbox pictures on standard 4:3 screen TV's, or non-expanded standard 4:3 pictures on wide screen TV's, or onscreen data in a stationary and fixed location). The warranty ALSO DOES NOT COVER damages which occurred in shipment, or failures which are caused by products not supplied by the warrantor, or failures which result from accidents, misuse, abuse, neglect, mishandling, misapplication, alteration, faulty installation, set-up adjustments, misadjustment of consumer controls, improper maintenance, power line surge, lightning damage, modification, or commercial use (such as in a hotel, office, restaurant, or other business), rental use of the product, service by anyone other than a Factory Servicenter or other Authorized Servicer, or damage that is attributable to acts of God.

THERE ARE NO EXPRESS WARRANTIES EXCEPT AS LISTED UNDER "LIMITED WARRANTY COVERAGE". THE WARRANTOR IS NOT LIABLE FOR INCIDENTAL OR CONSEQUENTIAL DAMAGES RESULTING FROM THE USE OF THIS PRODUCT, OR ARISING OUT OF ANY BREACH OF THIS WARRANTY. (As examples, this excludes damages for lost time, cost of having someone remove or re-install an installed unit if applicable, or travel to and from the servicer, loss of media or images, data or other memory or recorded content. The items listed are not exclusive, but are for illustration only.) **ALL EXPRESS AND IMPLIED WARRANTIES, INCLUDING THE WARRANTY OF MERCHANTABILITY, ARE LIMITED TO THE PERIOD OF THE LIMITED WARRANTY.**

Some states do not allow the exclusion or limitation of incidental or consequential damages, or limitations on how long an implied warranty lasts, so the exclusions may not apply to you.

This warranty gives you specific legal rights and you may also have other rights which vary from state to state. If a problem with this product develops during or after the warranty period, you may contact your dealer or Servicenter. If the problem is not handled to your satisfaction, then write to the warrantor's Consumer Affairs Department at the addresses listed for the warrantor.

PARTS AND SERVICE (INCLUDING COST OF AN IN-HOME SERVICE CALL, WHERE APPLICABLE) WHICH ARE NOT COVERED BY THIS LIMITED WARRANTY ARE YOUR RESPONSIBILITY.

For Your Information

Customer Services Directory

For Product Information, Operating Assistance, Literature Request, Dealer Locations, and all Customer Service inquiries please contact:

1-800-211-PANA (7262), Monday-Friday 9 am-9 pm; Saturday-Sunday 9 am-7 pm, EST.

or send e-mail : consumerproducts@panasonic.com

For hearing or speech impaired TTY users, TTY : 1-877-833-8855

Web Site: <http://www.panasonic.com>

You can purchase parts, accessories or locate your nearest servicer by visiting our Web Site.

Accessory Purchases:

1-800-332-5368 (Customer Orders Only)

For hearing or speech impaired TTY users, TTY : 1-866-605-1277

Panasonic Services Company 20421 84th Avenue South, Kent, WA 98032

(Monday-Friday 6 am-5 pm; Saturday 6 am-10:30 am, PST)

(Visa, MasterCard, Discover Card, American Express, Check)

Product Repairs

Centralized Factory Servicenter

MAIL TO :

Panasonic Services Company

1705 N. Randall Road,

Elgin, IL 60123-7847

Attention: Camcorder Repair

Please carefully pack and ship, prepaid and insured, to the Elgin Centralized Factory Servicenter. Customer's in Puerto Rico, please ship or carry in to location below ("Service in Puerto Rico").

Service in Puerto Rico

Matsushita Electric of Puerto Rico, Inc. Panasonic Sales Company/ Factory Servicenter:

Ave. 65 de Infanteria. Km. 9.5, San Gabriel Industrial Park, Carolina, Puerto Rico 00985

Phone (787) 750-4300 Fax (787) 768-2910

As of August 2002

Spanish Quick Use Guide/Guía Para Uso Rápido

Antes de comenzar...

- Inserte un casete con lengüeta para prevención del grabado.

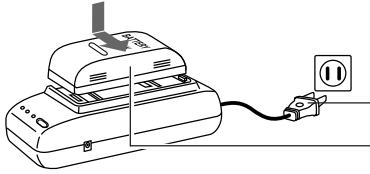

Cargue la batería

Cargue completamente la batería antes de usarla.

- 1 Enchufe el adaptador de CA.
- 2 Instale la batería. El indicador de carga (CHARGE) parpadea, luego queda encendido si ha terminado la carga. Desmonte la batería.

Inserte el casete

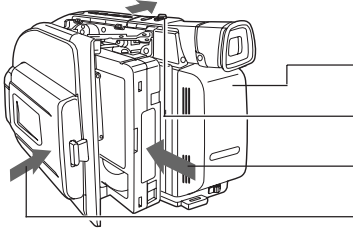

- 1 Coloque la batería cargada.
- 2 Deslice TAPE EJECT para abrir la compuerta.
- 3 Inserte el casete.
- 4 Presione aquí para cerrar la compuerta.

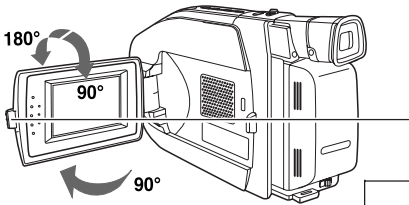

Grabación con la videocámara

- 1 Presione LCD-OPEN para abrir el monitor LCD. Abralo completamente y ajuste el ángulo.
- 2 Ajuste POWER a CAMERA.
- 3 Presione RECORD/PAUSE para comenzar la grabación. Presione RECORD/PAUSE otra vez para hacer una pausa en la grabación.

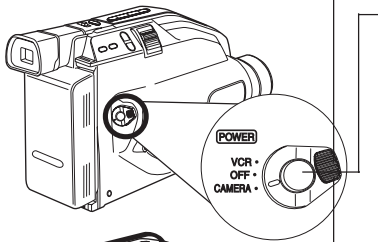

Reproduzca usando el monitor LCD

- 1 Presione LCD-OPEN para abrir el monitor LCD. Abralo completamente y ajuste el ángulo.
- 2 Ajuste POWER a VCR.
- 3 Presione ◀ (REWIND/SEARCH) para rebobinar la cinta.
- 4 Presione ▶/|| (PLAY/STILL) para comenzar la reproducción.
- 5 Presione ■ (STOP) para finalizar la reproducción.

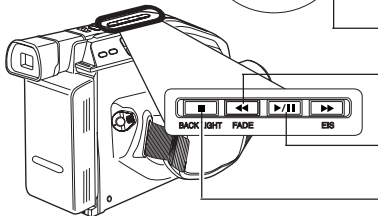

Reproducción con efectos especiales

Para localizar rápidamente una escena específica

- Oprimir el botón de localización (SEARCH).

Para congelar una imagen

- Oprimir el botón de pausa/imagen fija (PAUSE/STILL).
- Oprimir nuevamente el botón cuando se desea continuar reproduciendo.

Index

- A**
AC Adaptor 10
Accessories (Optional) ... 36
Accessories (Supplied) 2
AccuBrite™ Built-in Light 16
Audio/Video Cable ... 21, 22
Audio/Video Out 21, 22
Auto Daylight Saving Time
..... 15
- B**
Backlight 23
BACK LIGHT Button 23
Battery Pack 9, 10
BATTERY RELEASE
Button 9
Before Requesting Service
..... 39
Built-in Microphone 17
- C**
Camera Recording ... 17~19
Car Battery Cord 10
Cassette Information 11
Charging Battery 9
Clock Battery 35
Clock Set 14, 15
Copying your Tapes 22
Customer Servicenter
Directory 42
- D**
DC IN 10
DC Power Cable 10
Digital E.I.S. 29
Digital Zoom 28
Display-off Mode 32
- E**
EIS Button 29
- F**
Fade 26, 27
FADE Button 26, 27
FAST FORWARD/
SEARCH Button 20
Focus 24
- H**
Hand Strap 12
High Speed Shutter 25
- L**
LCD BRIGHT 17, 20
LCD Monitor 17, 20
LCD-OPEN Button ... 17, 20
Lens Cap 12
LIGHT Switch 16
Limited Warranty 41
- M**
MENU Button 13
MENU Mode 13
M.FOCUS Button
..... 13, 20, 24, 31
MotionSensor 30
- P**
PLAY/STILL Button 20
Playback 20, 21
PlayPak (Optional) 21
Power Supply 9, 10
POWER Switch 7, 17, 20
POWER ZOOM Button
..... 23, 24, 28
Programmed Recording . 19
- Q**
Quick Operation Guide 8
- R**
RECORD/PAUSE Button
..... 17
Record/Playback Time 11
Replacing Clock Battery . 35
Request for Service Notice
..... 40
REWIND/SEARCH
Button 20
- S**
Safety Precautions 3
Self Demo Mode 7
Shoulder Strap 12
Speaker 20
Special Effects 20
Specifications 38
Still Picture 20
STOP Button 20
- T**
Tab 11
TAPE EJECT Switch . 11, 17
Tracking Control 20
Tripod Mounting Hole 35
- U**
UP (FAR) / DOWN (NEAR)
Button 13, 20, 24
- V**
VHF Connecting Cable .. 22
Video Cassettes (tapes) .. 11
Video Head Cleaning 39
Viewfinder/LCD Monitor
Indications 31~33
Viewing (TV/VCR) 21
VISION ADJUSTMENT .. 17
VOLUME 20
- Z**
Zoom 23, 28

**Panasonic Consumer Electronics Company,
Division of Matsushita Electric Corporation of America**
One Panasonic Way Secaucus, New Jersey 07094

**Panasonic Sales Company ("PSC"),
Division of Matsushita Electric of Puerto Rico, Inc.**
Ave. 65 de Infanteria, Km. 9.5 San Gabriel Industrial Park Carolina,
Puerto Rico 00985



Printed in Indonesia
LSQT0628A
S1202-0