

Panasonic

DVD/VIDEO CD/CD PLAYER

Operating Instructions



The illustration shows DVD-RV31.

Model No. **DVD-RV41** **DVD-RV31**
DVD-RV26 **DVD-RV21**



This manual was printed with soy based ink.

Before connecting, operating or adjusting this product, please read these instructions completely.

Please keep this manual for future reference.

For U.S.A. only

The servicer list and warranty can be found on pages 33 and 34.

En la página 35 hay una guía de referencia rápida en español.

Dear customer

Thank you for purchasing this product.
For optimum performance and safety, please read these instructions carefully.

These operating instructions are applicable to models DVD-RV41, DVD-RV31, DVD-RV26 and DVD-RV21. Operations in these instructions are described mainly with the remote control, but you can do the operations on the main unit if the controls are the same.

- DVD-RV41**: indicates features applicable to DVD-RV41 only.
- DVD-RV31**: DVD-RV31 only.
- DVD-RV26**: DVD-RV26 only.
- DVD-RV21**: DVD-RV21 only.

Accessories

Please check and identify the supplied accessories. Use numbers indicated in parentheses when asking for replacement parts.

(Only for U.S.A.)

To order accessories contact 1-800-332-5368 or web site (<http://www.panasonic.com>).

(Only for Canada)

To order accessories, call the dealer from whom you have made your purchase.

- Remote control 1
(N2QAHB000012)
(N2QAHB000017: DVD-RV31 for units sold outside U.S.A. and Canada only)



- Batteries 2
for remote control

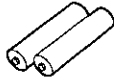

- AC power supply cord 1
For U.S.A. and Canada (RJA0065-A) **For others** (RJA0019-1X)

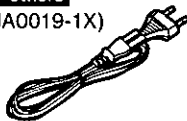
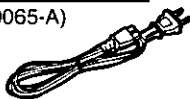

- Audio/video cable 1
(VJA0788-D)

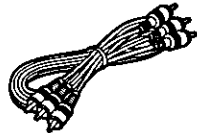

DVD-RV31

For units sold outside U.S.A. and Canada

- Power plug adaptor 1
(VJP2974)



Note

The included AC power supply cord is for use with this unit only. Do not use it with other equipment.

User memo:

DATE OF PURCHASE _____
DEALER NAME _____
DEALER ADDRESS _____
TELEPHONE NUMBER _____

The model number and serial number of this product can be found on either the back or the bottom of the unit. Please note them in the space provided below and keep for future reference.

MODEL NUMBER _____
SERIAL NUMBER _____

Table of contents

Getting started

Accessories	2
SAFETY INFORMATION	3
PRECAUTIONS	4
Disc information	5
Disc handling	5
Control reference guide	6
The remote control	7
Connection to a television	8
Selecting TV screen type	9

Basic operations

Basic play	10
Resume function	11
Starting play from a selected title or track	11
Skipping chapters or tracks	12
Frame-by-frame viewing	12
Fast forward and rewind-SEARCH	12
Slow-motion play	12

Advanced operations

Changing soundtracks, subtitle languages and angles	13
Increasing your enjoyment of movies	14
ADVANCED SURROUND (V.S.S.)	14
BASS PLUS	14
DIALOGUE ENHANCER	15
CINEMA	15
ONE TOUCH CINEMA MEMORY	15
Repeat play	16
Repeat play/A-B repeat play	16
Changing the play sequence	17
Program play/Random play	17
Using On-Screen Menu Icons	18
Common procedures	18
Icons for disc information/Shuttle screen	19
Icons for unit information	20
Changing initial settings	21
Common procedures	21
Summary of initial settings	22
Entering a password	24
Speaker setting	25
Digital output	26

Home Theater

Home Theater	27
Connecting an amplifier with 5.1-channel audio input terminals	28
Connecting an amplifier with a built-in decoder or a decoder-amplifier combination	28
Connecting an analog amplifier or system component	29
Connecting a digital amplifier or system component	29
Connecting an active subwoofer (optional)	29
Recording to MDs or cassette tapes	29

Reference

Troubleshooting guide	30
Product Service	31
Maintenance	31
Glossary	32
Servicenter List (Only for U.S.A.)	33
Limited Warranty (Only for U.S.A.)	34
Guía de referencia rápida en español (Spanish Quick Reference)	35
Specifications	Back cover

SAFETY INFORMATION

CAUTION!

THIS PRODUCT UTILIZES A LASER.
USE OF CONTROLS OR ADJUSTMENTS OR PERFORMANCE OF PROCEDURES OTHER THAN THOSE SPECIFIED HEREIN MAY RESULT IN HAZARDOUS RADIATION EXPOSURE.
DO NOT OPEN COVERS AND DO NOT REPAIR YOURSELF. REFER SERVICING TO QUALIFIED PERSONNEL.

WARNING:

TO REDUCE THE RISK OF FIRE, ELECTRIC SHOCK OR PRODUCT DAMAGE, DO NOT EXPOSE THIS APPLIANCE TO RAIN, SPLASHING, DRIPPING OR MOISTURE.

THE FOLLOWING APPLIES ONLY IN THE U.S.A. AND CANADA.:

CAUTION:

TO PREVENT ELECTRIC SHOCK MATCH WIDE BLADE OF PLUG TO WIDE SLOT, FULLY INSERT.

THE FOLLOWING APPLIES ONLY IN THE U.S.A.:

CAUTION:

This equipment has been tested and found to comply with the limits for a Class B digital device, pursuant to Part 15 of the FCC Rules.

These limits are designed to provide reasonable protection against harmful interference in a residential installation. This equipment generates, uses and can radiate radio frequency energy and, if not installed and used in accordance with the instructions, may cause harmful interference to radio communications. However, there is no guarantee that interference will not occur in a particular installation. If this equipment does cause harmful interference to radio or television reception, which can be determined by turning the equipment off and on, the user is encouraged to try to correct the interference by one or more of the following measures:

- Reorient or relocate the receiving antenna.
- Increase the separation between the equipment and receiver.
- Connect the equipment into an outlet on a circuit different from that to which the receiver is connected.
- Consult the dealer or an experienced radio/TV technician for help.

Any unauthorized changes or modifications to this equipment would void the user's authority to operate this device.

This device complies with Part 15 of the FCC Rules. Operation is subject to the following two conditions: (1) This device may not cause harmful interference, and (2) this device must accept any interference received, including interference that may cause undesired operation.

DANGER	- VISIBLE AND INVISIBLE LASER RADIATION WHEN OPEN. AVOID DIRECT EXPOSURE TO BEAM. (FDA 21 CFR)
CAUTION	- VISIBLE AND INVISIBLE LASER RADIATION WHEN OPEN. AVOID EXPOSURE TO BEAM. (IEC60825-11)
ATTENTION	- RAYONNEMENT LASER VISIBLE ET INVISIBLE EN CAS D'OUVERTURE. EXPOSITION DANGEREUSE AU FASCEAU.
ADVARSEL	- SYMLIG OG USYMLIG LASERSTRÅLING VED ÅBNING. UNDGÅ UDSÆTTELSE FOR STRÅLING.
VARO!	- AVATTAESSA OLET ALTIIRNA NÄKYVÄÄ JA NÄKYMÄTÖN LASERÄLTYLLE. ÄLÄ KATSO SÄTEESEEN.
VARNING	- SYMLIG OCH OSYMLIG LASERSTRÅLNING NÄR DENNA DEL ÄR ÖPPNAD. BETRÄKTA EJ STRÅLEN.
ADVARSEL	- SYMLIG OG USYMLIG LASERSTRÅLING NÄR DEKSEL ÄPNES. UNNGÅ EKSPONERING FOR STRÅLEN.
VORSICHT	- SICHTBARE UND UNSICHTBARE LASERSTRÄHLUNG, WENN ABDECKUNG GEÖFFNET. NICHT DEM STRAHLEN AUSSETZEN.
注意	- 打开时有可见及不可见激光辐射。避免激光束照射。
注意	- この製品は、レーザー光線を放射する可能性があります。レーザー光線を避けてください。RQLS02233

(Inside of unit)

DVD-RV31

For units sold outside U.S.A. and Canada

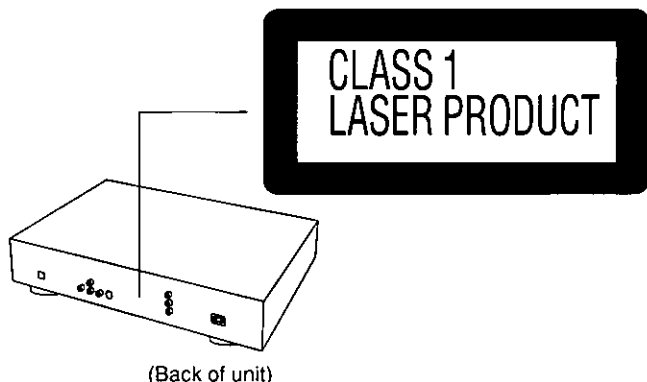

(Back of unit)



CAUTION

**RISK OF ELECTRIC SHOCK
DO NOT OPEN**



CAUTION: TO REDUCE THE RISK OF ELECTRIC SHOCK, DO NOT REMOVE SCREWS. NO USER-SERVICEABLE PARTS INSIDE. REFER SERVICING TO QUALIFIED SERVICE PERSONNEL.

The lightning flash with arrowhead symbol, within an equilateral triangle, is intended to alert the user to the presence of uninsulated "dangerous voltage" within the product's enclosure that may be of sufficient magnitude to constitute a risk of electric shock to persons.

The exclamation point within an equilateral triangle is intended to alert the user to the presence of important operating and maintenance (servicing) instructions in the literature accompanying the appliance.

PRECAUTIONS

Before using this unit please read these operating instructions carefully. Take special care to follow the warnings indicated on the unit itself as well as the safety suggestions listed below. Afterwards keep them handy for future reference.

Safety

- 1. Power Source**—The unit should be connected to a power supply only of the type described in the operating instructions or as marked on the unit. If you are not sure of the type of power supply to your home, consult your appliance dealer or local power company.
- 2. Polarization**—If the unit is equipped with a polarized AC power plug (a plug having one blade wider than the other), that plug will fit into the AC outlet only one way. This is a safety feature. If you are unable to insert the plug fully into the outlet, try reversing the plug. If the plug should still fail to fit, contact your electrician to replace your obsolete outlet. Do not defeat the safety purpose of the polarized plug.
- 3. Power Cord Protection**—AC power supply cords should be routed so that they are not likely to be walked on or pinched by items placed upon or against them. Never take hold of the plug or cord if your hand is wet, and always grasp the plug body when connecting or disconnecting it.
- 4. Overloading**—Do not overload wall outlets and extension cords as this can result in a risk of fire or electric shock.
- 5. Nonuse Periods**—When the unit is not being used, turn the power off. When left unused for a long time, the unit should be unplugged from the household AC outlet.
- 6. Attachments**—Do not use attachments not recommended by the unit manufacturer as they may cause hazards.

Installation

Environment

- 1. Water and Moisture**—Do not use this unit near water—for example, near a bathtub, washbowl, swimming pool, or the like. Damp basements should also be avoided.
- 2. Condensation**—Moisture may form on the lens in the following conditions...
 - immediately after a heater has been turned on.
 - in a steamy or very humid room.
 - when the unit is suddenly moved from a cold environment to a warm one.If moisture forms inside this unit, it may not operate properly. To correct this problem, turn on the power and wait about one hour for the moisture to evaporate.
- 3. Heat**—The unit should be situated away from heat sources such as radiators and the like. It also should not be placed in temperatures less than 5°C (41°F) or greater than 35°C (95°F).

Do not place the unit on amplifiers or equipment that may become hot.

The heat can damage the unit.

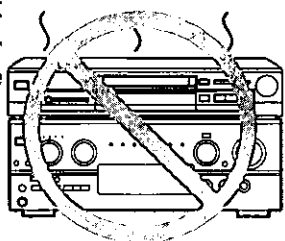

Placement

- 1. Ventilation**—The unit should be situated so that its location or position does not interfere with its proper ventilation. Allow 10 cm (4") clearance from the rear of the unit.
- 2. Foreign Material**—Care should be taken so that objects do not fall into and liquids are not spilled into the unit. Do not subject this unit to excessive smoke, dust, mechanical vibration, or shock.
- 3. Carts and Stands**—The unit should be used only with a cart or stand that is recommended by the manufacturer. The unit and cart combination should be moved with care. Quick stops, excessive force, and uneven surfaces may cause the unit and cart combination to overturn.
- 4. Mounting**—Any mounting of the appliance should follow the manufacturer's instructions, and should use a mounting accessory recommended by the manufacturer.



Maintenance

Disconnect this unit from the AC outlet before cleaning. Clean the cabinet, panel and controls with a soft cloth lightly moistened with a mild detergent solution. Do not use any type of abrasive pad, scouring powder or solvent such as alcohol or benzine.

Service

- 1. Damage Requiring Service**—The unit should be serviced by qualified service personnel when:
 - (a) The AC power supply cord or the plug has been damaged; or
 - (b) Objects have fallen or liquid has been spilled into the unit; or
 - (c) The unit has been exposed to water; or
 - (d) The unit does not appear to operate normally or exhibits a marked change in performance; or
 - (e) The unit has been dropped, or the enclosure damaged.
- 2. Servicing**—The user should not attempt to service the unit beyond that described in the operating instructions. All other servicing should be referred to an authorized service personnel.

In the U.S.A., contact the Panasonic Customer Call Center at 1-800-211-7262, or e-mail consumerproducts@panasonic.com, or web site (<http://www.panasonic.com>).

In Canada, contact Panasonic Canada Inc. Customer Care Centre at 1-800-561-5505, or web site (www.panasonic.ca), or an authorized Service centre nearest you.
- 3. Replacement parts**—When parts need replacing, ensure the servicer uses parts specified by the manufacturer or parts that have the same characteristics as the original parts. Unauthorized substitutes may result in fire, electric shock, or other hazards.
- 4. Safety check**—After repairs or service, ask the servicer to perform safety checks to confirm that the unit is in proper working condition.

Disc information

Discs that can be played

Disc type	Logo	Region number	Video system	Indication used in instructions
DVD-Video		 	NTSC	
Video CD		-	NTSC	
Audio CD		-	-	

Discs that cannot be played

DVD-Audio, PAL discs, DVD-ROM, DVD-R/DVD-RAM, CD-ROM, VSD, CDV, CD-G, DVD+RW, DVD-RW, CVD, SVCD, SACD, Divx Video Discs and Photo CD.

The data on photo CDs can be damaged if you attempt to play them.

DVDs that can be played

This unit has a Dolby Digital decoder so you can play DVDs with this mark.

This unit does not have a DTS decoder. Connect this unit to equipment that has a DTS decoder to enjoy DVDs with this mark.

Region Management Information (DVD only)

This unit responds to the Region Management Information recorded on DVDs. This unit's region number is "1". You cannot play the disc if the region number on the DVD does not correspond to the region number on the unit.

You can play discs with labels containing the region number "1" and "ALL".

Read the disc's instructions carefully.

Playing DVDs and Video CDs

The producer of the material can control how these discs are played. This means that you may not be able to control play of a disc with some operations described in these operating instructions. Read the disc's instructions carefully.

MP3 playback

You can use this unit to play MP3 format audio recorded for personal use with a computer etc. onto CD-R or CD-RW. Play may not be possible in some cases due to the condition of the recording.

Discs recorded using MP3 differ to CDs in the following ways.

Structure of the disc (example)

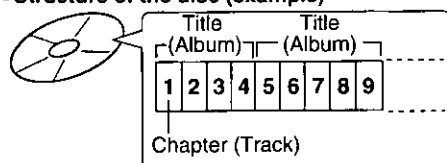

Starting play from a selected chapter

Press the numbered buttons and press [ENTER].

Repeat play

You can use chapter repeat or title repeat.

Program play, random play

You cannot use program play or random play.

Disc handling

Do not use irregularly shaped discs, such as heart-shaped. (These can damage the unit.)

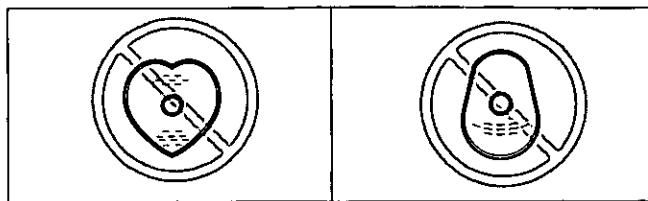

How to hold a disc

Do not touch the recorded surface.

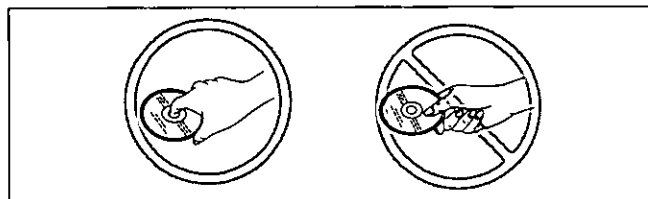

If the surface is dirty

Wipe it with a damp cloth and then wipe dry.

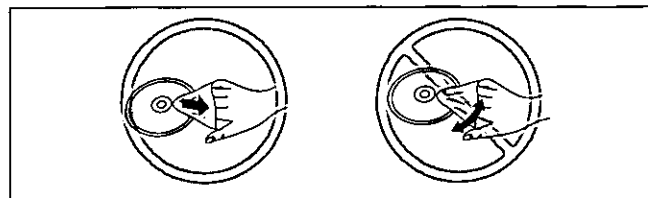

If the disc is brought from a cold to a warm environment, moisture may form on the disc

Wipe with a soft, dry, lint-free cloth before using the disc.

Handling precautions

- Do not write on the label side with a ball-point pen or other writing instrument.
- Do not use record cleaning sprays, benzene, thinner, static electricity prevention liquids or any other solvent.
- Do not attach labels or stickers to discs. (Do not use discs with exposed adhesive from tape or left over peeled-off stickers.)
- Do not use scratch-proof protectors or covers.
- Do not use CDs printed with label printers available on the market.

Do not place or store discs in the following places

- Locations exposed to direct sunlight
- Humid or dusty locations
- Locations directly exposed to a heat vent or heating appliance

Display during play



On-Screen Menu Icons for disc information during play

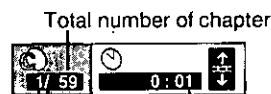

Current chapter Elapsed play time (display only, cannot be changed)

Control reference guide

Getting started

DVD-RV41

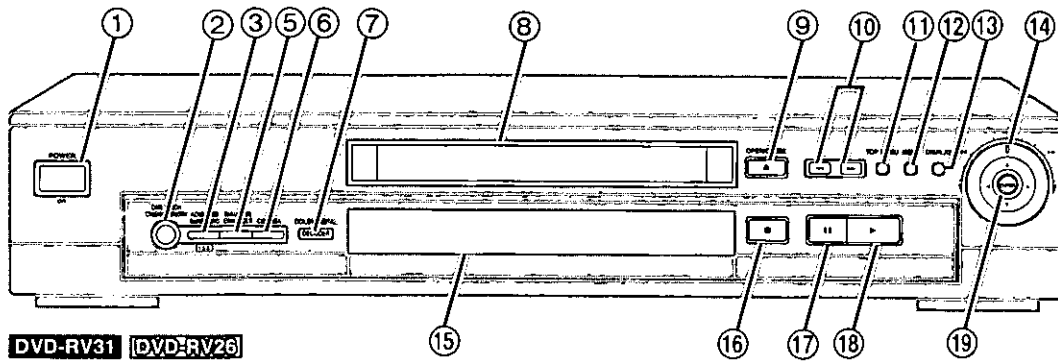

DVD-RV31 [DVD-RV26]

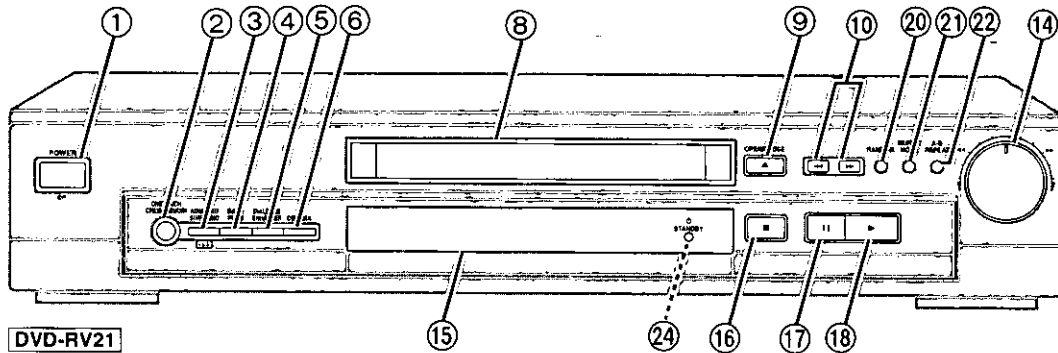

DVD-RV21

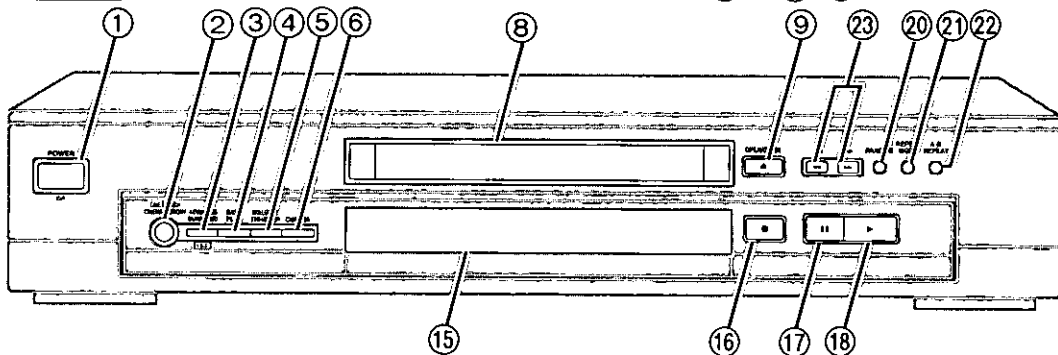

Main unit

	Page
① Standby/on switch (⏻/⏻, POWER)	9
Press to switch the unit from on to standby mode or vice versa. In standby mode, the unit is still consuming a small amount of power.	
② One touch cinema memory button (ONE TOUCH CINEMA MEMORY)	15
③ Advanced Surround (V.S.S.) button (ADVANCED SURROUND, (V.S.S.))	14
④ DVD-RV31 [DVD-RV26] DVD-RV21 Bass plus button (BASS PLUS)	14
⑤ Dialogue Enhancer button (DIALOGUE ENHANCER)	15
⑥ Cinema button (CINEMA)	15
⑦ DVD-RV41 DOLBY DIGITAL indicator (DOLBY DIGITAL, DECODER) Goes out when playing a disc without Dolby Digital.	
⑧ Disc tray	10
⑨ Disc tray open/close button (▲, OPEN/CLOSE)	10
⑩ DVD-RV41 DVD-RV31 [DVD-RV26] Skip buttons (◀◀, ▶▶)	12
⑪ DVD-RV41 Top menu button (TOP MENU)	10
⑫ DVD-RV41 Menu button (MENU)	10

	Page
⑬ DVD-RV41 Display button (DISPLAY)	18
⑭ DVD-RV41 DVD-RV31 [DVD-RV26] Shuttle dial (◀◀, ▶▶)	12
⑮ Display	
⑯ Stop button (■)	10
⑰ Pause button (⏸)	10
⑱ Play button (▶)	10
⑲ DVD-RV41 Joystick (▲, ▼, ◀, ▶)/Enter button (ENTER)	10
⑳ DVD-RV31 [DVD-RV26] DVD-RV21 Random play button (RANDOM)	17
㉑ DVD-RV31 [DVD-RV26] DVD-RV21 Repeat button (REPEAT MODE)	16
㉒ DVD-RV31 [DVD-RV26] DVD-RV21 A-B repeat button (A-B REPEAT)	16
㉓ DVD-RV21 Skip/Search buttons (◀◀, ▶▶, ◀◀, ▶▶)	12
㉔ DVD-RV31 (For units sold outside U.S.A. and Canada) Standby indicator (⏻, STANDBY) When the unit is connected to the AC mains supply, this indicator lights up in standby mode and goes out when the unit is turned on.	

Buttons such as ❶ function the same as the controls on the unit.

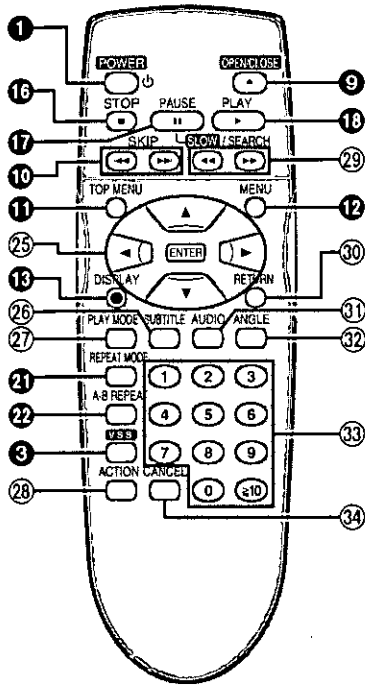

Remote control

Page

❷	Cursor buttons (▲, ▼, ◀, ▶)/Enter button (ENTER)	10
❸	Subtitle button (SUBTITLE)	13
❹	Play mode button (PLAY MODE)	17
❺	Action button (ACTION)	9, 21
❻	Slow/Search buttons (◀◀, ▶▶ SLOW/SEARCH)	12
❼	Return button (RETURN)	10
❽	Audio button (AUDIO)	13
❾	Angle button (ANGLE)	13
❿	Numbered buttons (1-9, 0, ≧10)	10
⓫	Cancel button (CANCEL)	17

Batteries

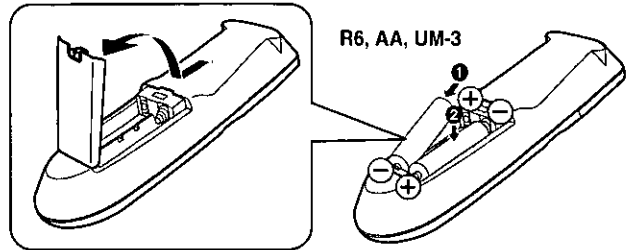

- Insert so the poles (+ and -) match those in the remote control.
- Do not use rechargeable type batteries.

Do not;

- mix old and new batteries.
- use different types at the same time.
- heat or expose to flame.
- take apart or short circuit.
- attempt to recharge alkaline or manganese batteries.
- use batteries if the covering has been peeled off.

Mishandling of batteries can cause electrolyte leakage which can damage items the fluid contacts and may cause a fire. If electrolyte leaks from the batteries, consult your dealer. Wash thoroughly with water if electrolyte comes in contact with any part of your body.

Remove if the remote control is not going to be used for a long period of time. Store in a cool, dark place.

Replace if the unit does not respond to the remote control even when held close to the front panel.

Use

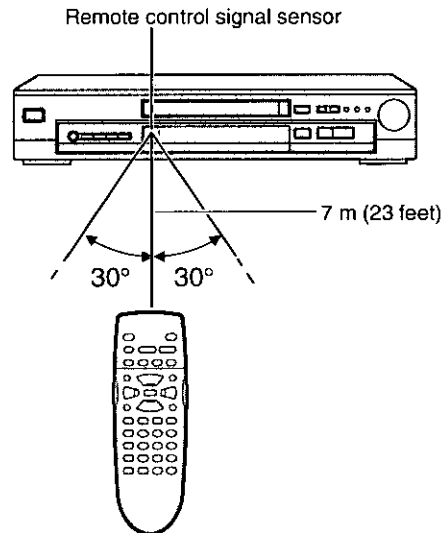

Aim at the sensor, avoiding obstacles, at a maximum range of 7 m (23 feet) directly in front of the unit.

- Keep the transmission window and the unit's sensor free from dust.
- Operation can be affected by strong light sources, such as direct sunlight, and the glass doors on cabinets.

Do not;

- put heavy objects on the remote control.
- take the remote control apart.
- spill liquids onto the remote control.

Connection to a television

DVD-RV41 **DVD-RV31** **DVD-RV26** **DVD-RV21**

These pages explain how to connect the unit to a television and set it up so you hear the audio through the television's speakers. Connections and procedures that enable you to enjoy more powerful sounds are described beginning on page 27.

Before connection

- Disconnect the AC power supply cord.
- Refer to the television's operating instructions.

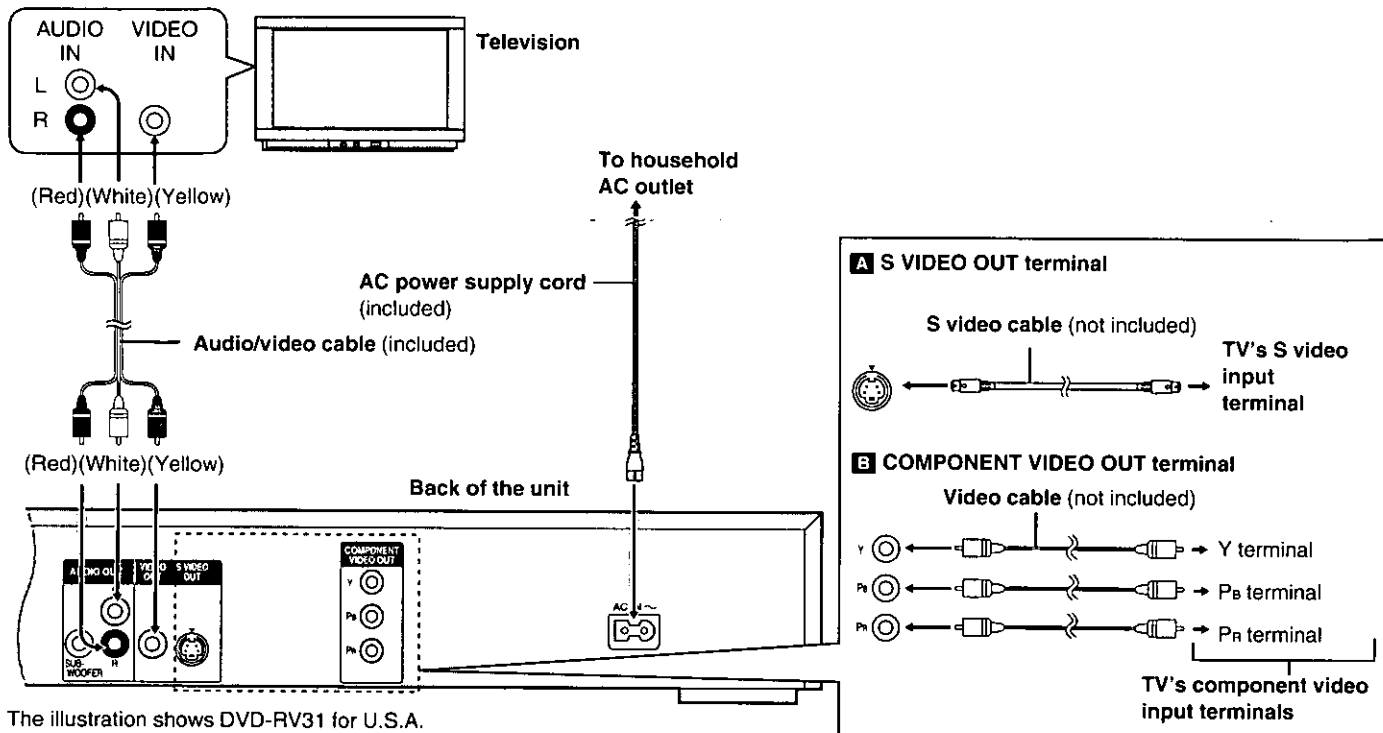

Getting started

A S VIDEO OUT terminal

The S-video terminal achieves a more vivid picture than the VIDEO OUT terminal by separating the chrominance (C) and luminance (Y) signals. (Actual results depend on the television.)

B COMPONENT VIDEO OUT terminal

Connection using these terminals outputs the color difference signals (P_B/P_R) and luminance signal (Y) separately in order to achieve high fidelity in reproducing colors.

- The description of the component video input terminals depends on the television or monitor (e.g. Y/P_B/P_R, Y/B-Y/R-Y, Y/C_B/C_R). Connect to terminals of the same color.
- After making this connection, change the black level for a better picture (→ page 22, Video-Black Level Control).

Conserving power

This unit consumes a small amount of power, even when it is turned off.

- DVD-RV41** : approx. 2.5 W
- DVD-RV31** (For U.S.A. and Canada): approx. 2 W
(For others): approx. 4 W
- DVD-RV26** **DVD-RV21** : approx. 2 W

To save power when the unit is not to be used for a long time, unplug it from the household AC outlet.

DVD-RV31

For units sold outside U.S.A. and Canada

If the power plug does not fit your AC outlet

Use the power plug adaptor (included).

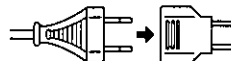

If it still doesn't fit, contact either a local or foreign electrical parts distributor for assistance.

Connect Your Unit Directly To Your Television.

Do not connect the unit through your video cassette recorder when setting up your home entertainment system, because the picture may not be played correctly due to the copy guard.

Selecting TV screen type

DVD-RV41 DVD-RV31 DVD-RV23 DVD-RV21

Remote control only

Change the setting to suit the aspect ratio of your television.

The menu language is set to English, but you can change it to French or Spanish (→ page 22, Display–Menu Language). English is used in the examples.

Preparation

Turn on the television and select the appropriate video input on the television to suit the connections for the player.

- 1 Press [POWER] to turn on the unit.
- 2 Press [ACTION] to show the menus.
- 3 Press [◀, ▶] to select the Video tab.
- 4 Press [▲, ▼] to select “TV Aspect” and press [ENTER].
- 5 Press [▲, ▼] to select the item and press [ENTER].

•4:3 Pan&Scan (Factory preset)

Select if you have a regular television and to view 16:9 software* in the pan and scan style (a).

•4:3 Letterbox

Select if you have a regular television and to view 16:9 software in the letterbox style (b).

•16:9

Select if you have a widescreen television.

*16:9 software prohibited from being shown in the pan and scan style will appear in the letterbox style despite the setting here.

The Video menu is shown.

- 6 Press [ACTION] to end the settings.

To return to the previous screen
Press [RETURN].

For your reference

DVDs are recorded in a variety of aspect ratios. You can change the way software is shown on a regular television (4:3) with the above operation. If you have a widescreen television (16:9), use the television's picture modes.

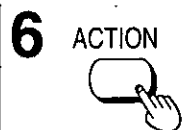
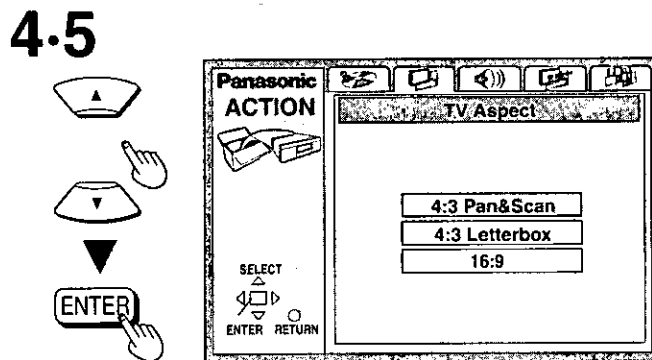
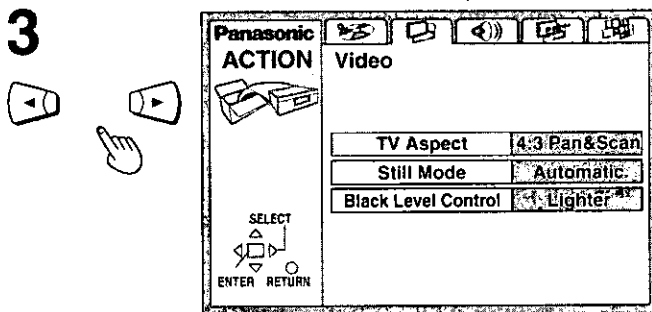
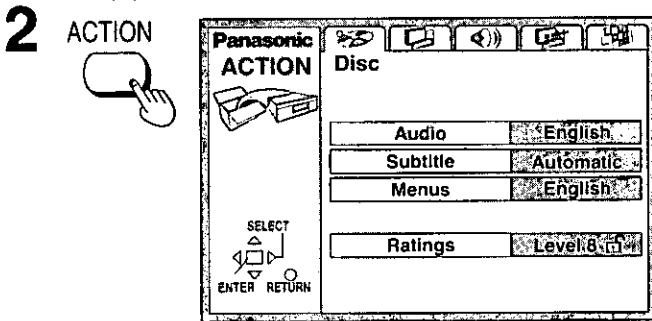
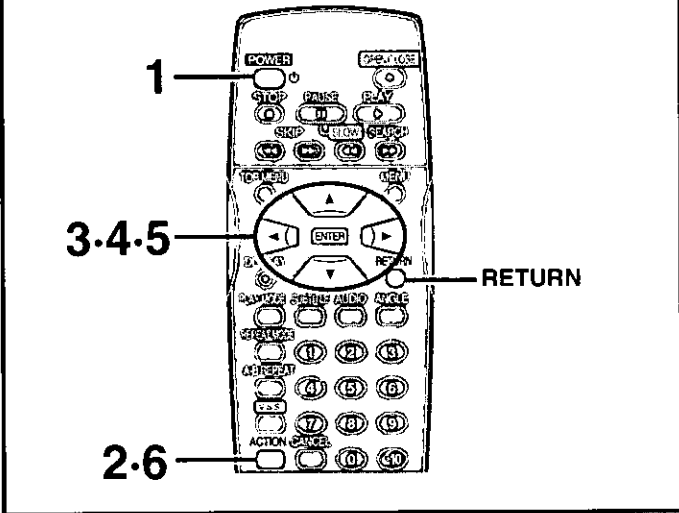

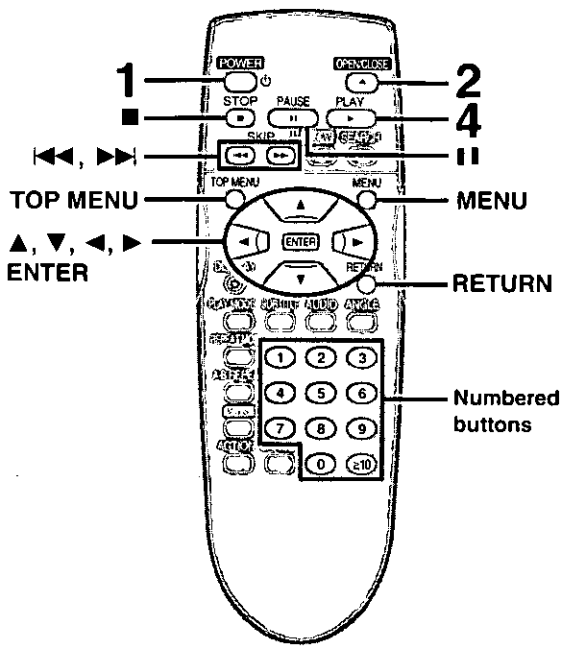

Basic play

DVD-RV41 **DVD-RV31** **DVD-RV26** **DVD-RV21**

DVD **VCD** **CD**

Preparation

Turn on the television and select the appropriate video input on the television to suit the connections for the player.

- 1** Press [POWER] to turn on the unit.
- 2** Press [▲] to open the disc tray.
- 3** Place the disc on the disc tray.
- 4** Press [▶] (play).
The disc tray closes and play begins.

■ To stop play

Press [■] (→ page 11, Resume function).

■ To pause play **A**

Press [||] during play.
Press [▶] (play) to restart play.

Playing CD-R and CD-RW

This unit can play CD-DA (digital audio) format audio CD-R and CD-RW that have been finalized* upon completion of recording.

It may not be able to play some CD-R or CD-RW due to the condition of the recording.

* Finalizing is a process that enables CD-R/CD-RW players to play audio CD-R and CD-RW.

Note

- If "⊙" appears on the television
The operation is prohibited by the unit or disc.
- The disc continues to rotate while the menu is displayed even after you finish playing an item. Press [■] when you finish to preserve the unit's motor and your television screen.
- Volume may be lower when playing DVDs than when playing other discs or during television broadcasts.
If you turn the volume up on the television or amplifier, ensure you reduce the volume again before playing other sources so that a sudden increase in output does not occur.

■ Auto power-off function

The unit switches to the standby mode after about 30 minutes in the stop mode.

When a menu screen appears on the television

DVD **VCD**

Remote control only

Press the numbered buttons to select an item.

To select a 2-digit number

Example: To select item 23, press [≧10], then [2] and [3].

- When playing DVDs, you can also use [▲, ▼, ◀, ▶] to select items. Press [ENTER] to confirm your selection.

Play of the selected item now begins.

Other buttons used to operate menus

Read the disc's instructions for further details about operation.

- [▶▶] or [▶▶, ▶▶]: Shows the next menu.
- [◀◀] or [◀◀, ◀◀]: Shows the previous menu.
- [RETURN]: Shows the menu screen.
- [TOP MENU]: Shows the first menu screen. **DVD**
- [MENU]: Shows the menu screen. **DVD**

B DVD menus

DVDs can have several menus. The menu displayed when you press [TOP MENU] may be different from the menu displayed when you press [MENU].

1 **POWER**

2 **OPEN/CLOSE**

3

Label must face upward.
(With double-sided discs, load so the label for the side you want to play is facing up.)

4 **PLAY**

Unit's display (e.g. DVD is loaded)

A **PAUSE**

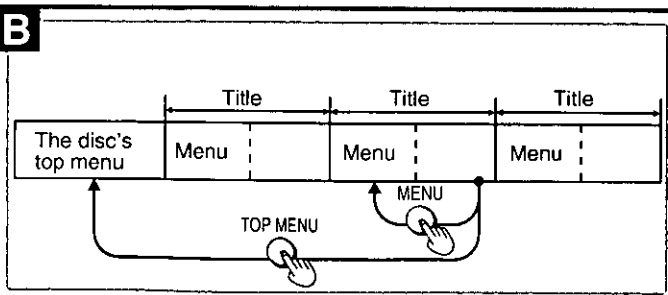

Basic play

DVD-RV41 DVD-RV31 DVD-RV26 DVD-RV21

DVD VCD CD

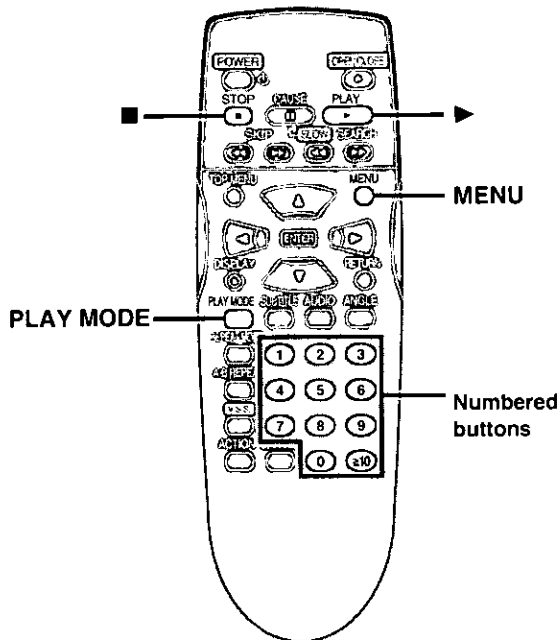

A Resume function

Stop-resume

The unit remembers the point where you stopped play as long as the unit is on.

Standby-resume

During play, press [PLAY MODE] at the point you want to start play again. The unit remembers the point even if you switch the unit to standby mode.

To resume play

Press [▶] (play) while "▷" is flashing on the unit's display.

If you are playing DVD, the illustrated message also appears.

Pressing [▶] (play) while the message is displayed, the beginning portions of each chapter up to the current one are played and full play resumes from the point where you stopped play or you pressed [PLAY MODE] (**Chapter preview**).

(Chapter Preview feature works only within a title.)

If you do not press [▶] (play), the message disappears and play starts from where you stopped it or you pressed [PLAY MODE].

To cancel

Press [■] until "▷" disappears from the unit's display.

Note

- The resume function does not work if the disc's play time is not displayed.
- The position is cleared when the disc tray is opened.
- Stop-resume is canceled if the unit switches to standby automatically (⇒ page 10, Auto power-off function). Use standby-resume if you want to resume play even after the unit switches to standby.

B Starting play from a selected title or track

Remote control only

While stopped

Press the numbered buttons.

To select a 2-digit number

Example: To select track 23, press [≧10], then [2] and [3].

Play starts from the selected title/track.

Note

This may not work with some discs.

For your reference

The numbered buttons also work during play if the disc is a Karaoke DVD, Video CD, or CD.

If the Video CD has playback control (⇒ page 32)

Cancel menu play first.

1. Press [■] during play until "PBC PLAY" is cleared from the unit's display.
 2. Press the numbered buttons to select a track to start play.
- To return to menu play, press [■] and press [MENU].

A

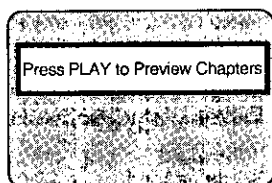

B

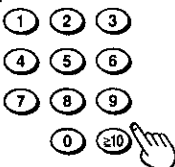

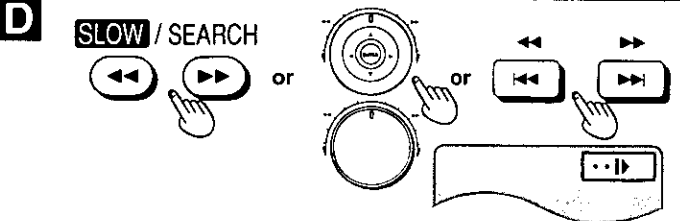
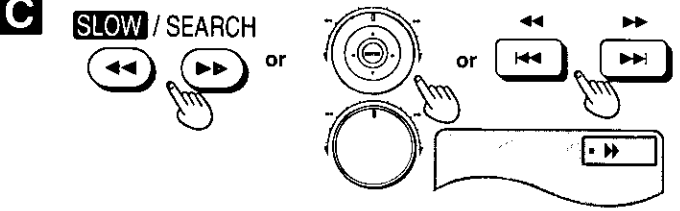
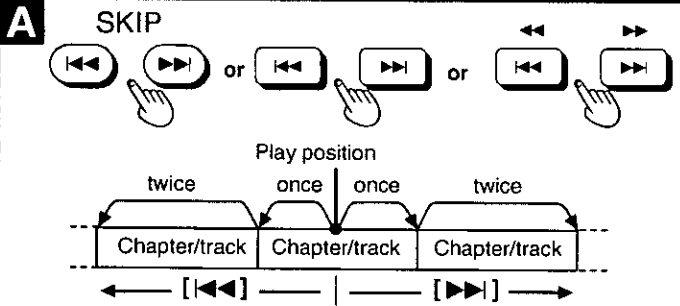
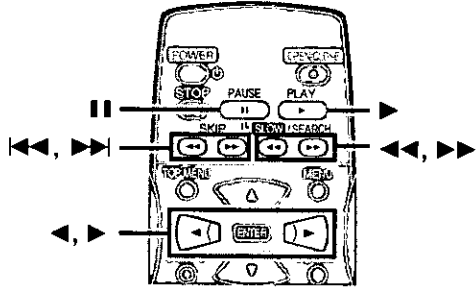
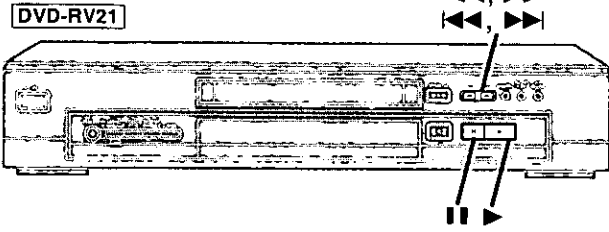
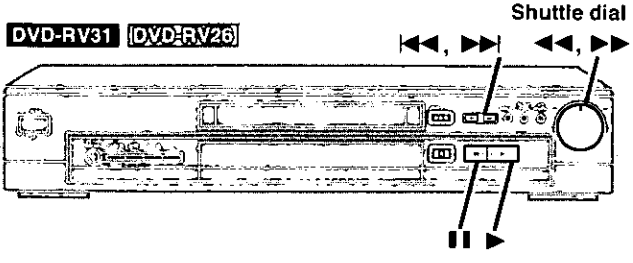
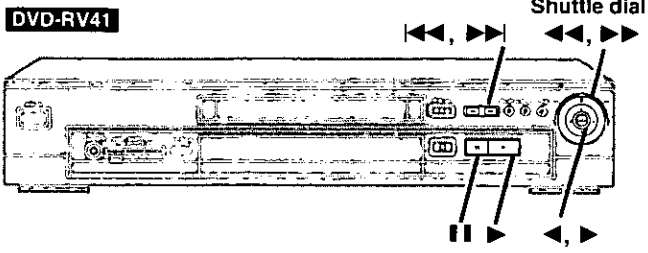

Basic play

DVD-RV41 DVD-RV31 DVD-RV26 DVD-RV21

A Skipping chapters or tracks

DVD VCD CD

During play or while paused

Press [**⏮**] or [**⏭**].

Each press increases the number of skips.

B Frame-by-frame viewing

DVD VCD

DVD-RV31, DVD-RV26, DVD-RV21: Remote control only

While paused

Press [**◀**] or [**▶**].

The frame changes each time you press the buttons.

- The frames change in succession if you press and hold the button.
- Pressing [**⏮**] also activates forward frame-by-frame.

C Fast forward and rewind-SEARCH

DVD VCD CD

During play

Press [**⏮**] or [**⏭**].

For your reference

Audio will be heard during search for most discs. You can turn this audio off if you want to (DVD and Video CD only → page 22, Audio-Audio during Search).

D Slow-motion play

DVD VCD

While paused

Press [**⏮**] or [**⏭**].

Notes

- The speed of search and slow-motion increases up to 5 steps.
- Press [**▶**] (play) to restart play.
- When you release the dial during search or slow-motion, the unit returns to the previous state (play or pause).
- You cannot move backwards with Video CD during frame-by-frame and slow-motion.
- [**⏮**], [**◀**], [**⏪**]: Backward
- [**⏭**], [**▶**], [**⏩**]: Forward

When playing Video CDs with playback control

Turning the shuttle dial or pressing buttons to perform skip, search or slow-motion may take you to a menu screen.

Changing soundtracks, subtitle languages and angles

DVD-RV41 DVD-RV31 DVD-RV26 DVD-RV21

DVD

Remote control only

Some DVDs have multiple soundtracks, subtitle languages and camera angles, and you can change these during play.

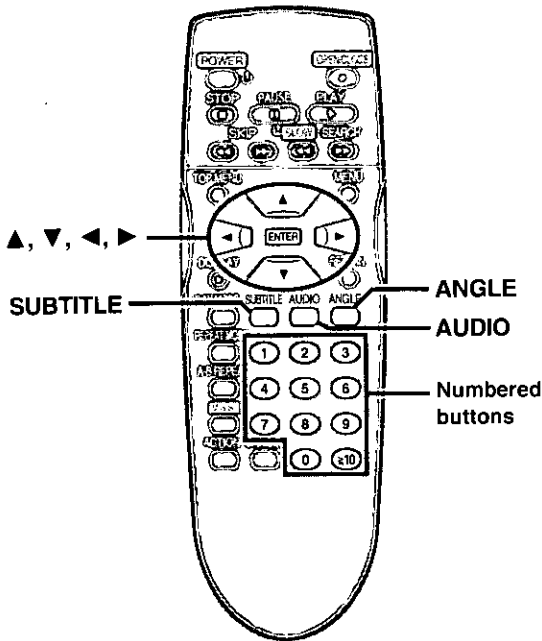

A Soundtracks

During play
Press [AUDIO].

The number changes each time you press the button.

- You can also use this button to turn the vocals on and off on karaoke discs. Read the disc's instructions for details.

B Subtitles

During play
Press [SUBTITLE].

The number changes each time you press the button.

To clear/display the subtitles

1. Press [SUBTITLE].
2. Press [▶].
3. Press [▲, ▼] to select "ON" or "OFF".

C Angles

During play
Press [ANGLE].

The number changes each time you press the button.

Notes regarding soundtracks, subtitle languages and angles

- You can also use [▲, ▼] or the numbered buttons to change the soundtracks, subtitle languages and angles.
- Some discs allow changes to soundtracks, subtitle languages and angles only by using the disc's menus.
- Soundtrack and subtitle languages can be set before play with the initial settings (→ page 22, Disc—Audio and Subtitle).
- "—" or "---" is displayed instead of the language number in circumstances such as when no language is recorded on the disc.
- Some discs allow you to set angles before multi-angle scenes are played. Read the instructions that come with the DVD.
- In some cases, the subtitle language is not changed to the selected one immediately.
- If the subtitles overlap closed captions recorded on discs, turn the subtitles off.

A AUDIO

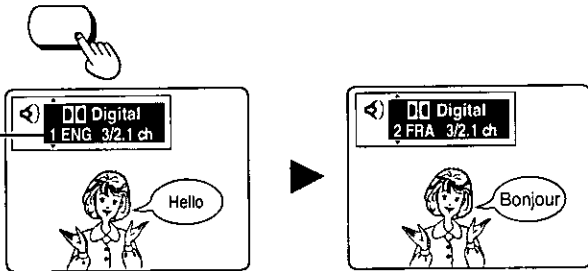

Soundtrack language number

Lights when the audio on a multi-channel disc is down-mixed to 2 channels and output through the AUDIO OUT terminals



B SUBTITLE

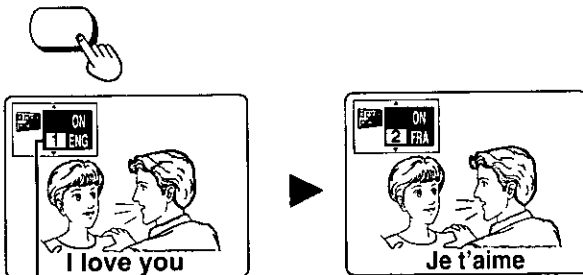

Subtitle language number

C ANGLE

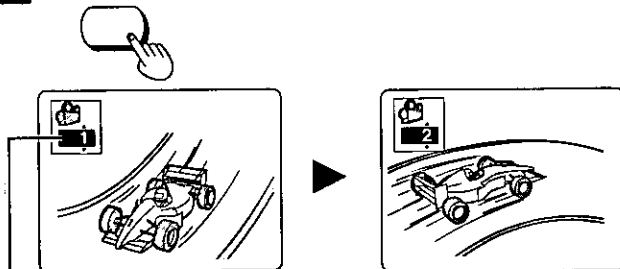

Angle number

DVD-RV41

ADVANCED SURROUND (V.S.S.)

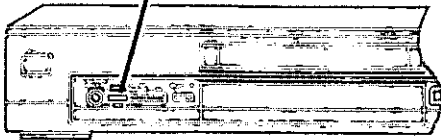

DVD-RV31 [DVD-RV26] DVD-RV21

ADVANCED SURROUND (V.S.S.)



BASS PLUS

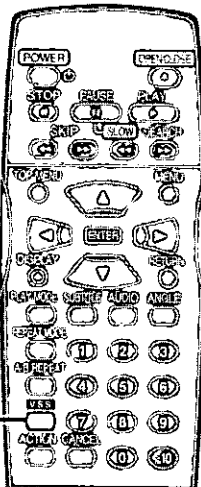

V.S.S.

Increasing your enjoyment of movies

You can easily control the following features, used for increasing your enjoyment of movies, with the buttons on the main unit.

- ADVANCED SURROUND (V.S.S.)
- BASS PLUS [DVD-RV31] [DVD-RV26] DVD-RV21
- DIALOGUE ENHANCER
- CINEMA
- ONE TOUCH CINEMA MEMORY

The one touch cinema memory allows you to reselect the settings you made for the above features with a single button press.

A ADVANCED SURROUND (V.S.S.)

DVD-RV41 DVD-RV31 [DVD-RV26] DVD-RV21

[DVD] (Dolby Digital, 2-channel or over only)

Use Advanced Surround (V.S.S.) (Virtual Surround Sound) to enjoy a surround-like effect if you are using 2 front speakers. If you are playing a disc with surround effects recorded on it, the effect is broadened and sound seems to come from virtual speakers on either side.

Press [ADVANCED SURROUND (V.S.S.)].

Each time you press the button:

- 1: Natural effect
- ↓
- 2: Emphasized effect
- ↓
- OFF: Cancel (Factory preset)

- The V.S.S. indicator lights up when Advanced Surround is on.

Note

- Advanced Surround does not work with Karaoke DVDs.
- Advanced Surround will not work, or will have less effect, with some discs.
- Turn off the surround sound effects on the equipment you have connected when using this effect.
- Turn Advanced Surround off if it causes distortion.
- Sound will only come from the two front speakers if Advanced Surround is on.

Optimum seating position (a)

B BASS PLUS

DVD-RV31 [DVD-RV26] DVD-RV21

[DVD] VCD CD

Main unit only

Turn BASS PLUS on when you have connected an active subwoofer to the SUBWOOFER terminal on the rear of the unit (→ page 29).

Press [BASS PLUS].

Each time you press the button:

- OFF
- ↑
- ON (Factory preset): Indicator lights up.

A
ADVANCED SURROUND



DVD VIDEO

V.S.S.

V.S.S.

(a)

Speaker Speaker



3 to 4 times distance A



Seating position

B
BASS PLUS



DVD VIDEO

TITLE

CHAP

0:00:05

BASS

DVD-RV41

DIALOGUE
ENHANCER CINEMA

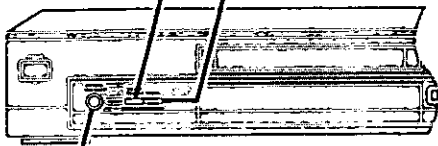

ONE TOUCH
CINEMA MEMORY

DVD-RV31 [DVD-RV26] DVD-RV21

DIALOGUE
ENHANCER CINEMA

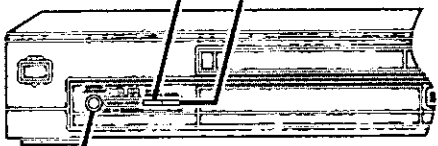

ONE TOUCH
CINEMA MEMORY

A

DIALOGUE
ENHANCER

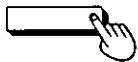

B

CINEMA

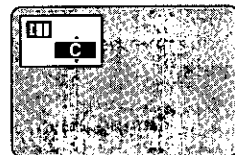
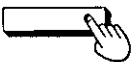

C

ONE TOUCH
CINEMA MEMORY



DVD-RV41 DVD-RV31 [DVD-RV26] DVD-RV21

Main unit only

A DIALOGUE ENHANCER

[DVD] (Dolby Digital, 3-channel or over, where the dialogue is recorded in the center channel)

This mode makes the dialogue in movies easier to hear.

Press [DIALOGUE ENHANCER].

Each time you press the button:

ON: Indicator lights up.



OFF (Factory preset)

B CINEMA

[DVD] VCD

You can enjoy better pictures by changing the picture quality.

Press [CINEMA].

Each time you press the button:

C: Cinema mode: Indicator lights up.

Mellows movies, enhances detail in dark scenes.



N: Normal mode (Factory preset)

For your reference

DVD-RV41 DVD-RV31 [DVD-RV26]

You can make finer adjustments to the picture if desired (→ page 20, Digital picture mode—User mode).

C ONE TOUCH CINEMA MEMORY

This feature allows you to reselect the settings you made for ADVANCED SURROUND (V.S.S.), BASS PLUS, DIALOGUE ENHANCER and CINEMA with one button press.

Putting the settings into memory

After making the settings

Press and hold [ONE TOUCH CINEMA MEMORY] until it lights.

The settings remain in the memory even if you turn the unit off.

Recalling the settings

Press [ONE TOUCH CINEMA MEMORY].

The button's light comes on.

To cancel

Press [ONE TOUCH CINEMA MEMORY] to turn it off and return the settings for the features to the factory preset.

- ADVANCED SURROUND (V.S.S.): OFF
- BASS PLUS: ON
- DIALOGUE ENHANCER: OFF
- CINEMA: OFF (normal)

The button's light also turns off if you press any of the other buttons to change the settings.

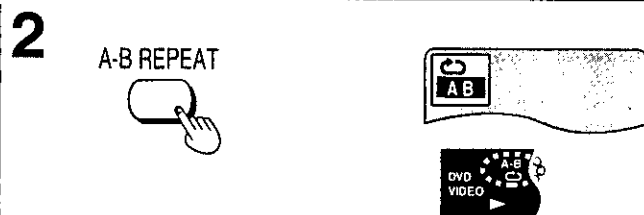
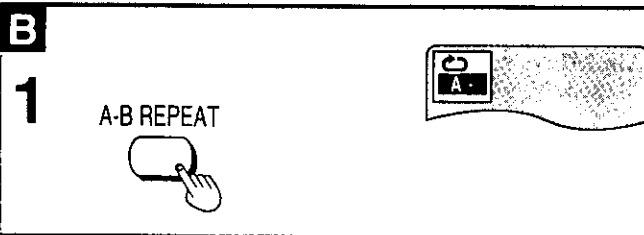
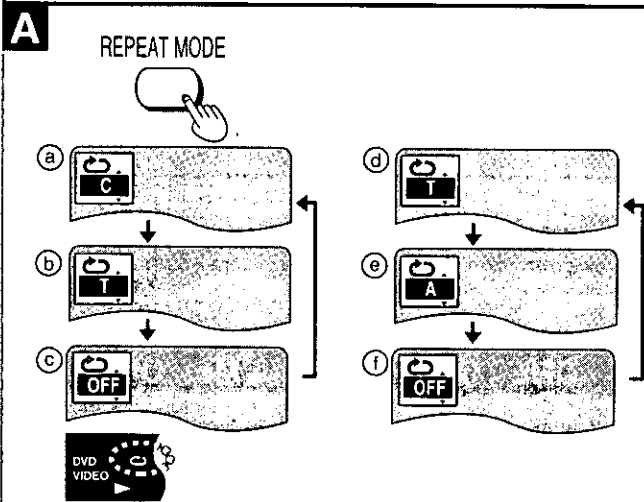
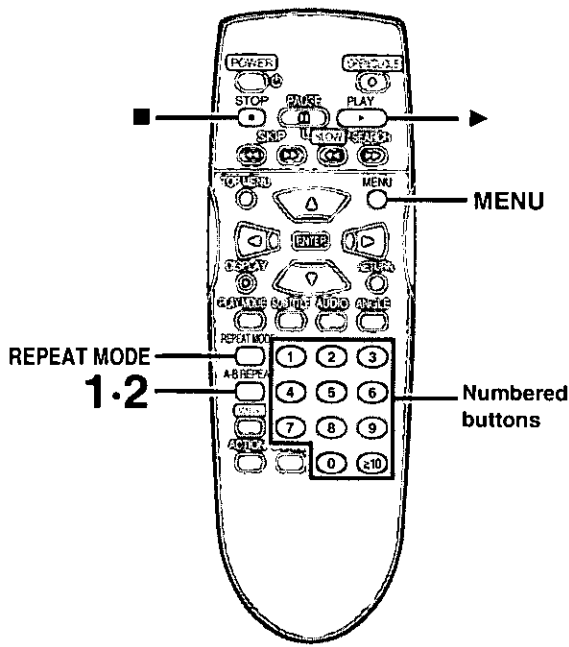

Repeat play

DVD-RV41 : Remote control only

DVD-RV31 [DVD-RV26] [DVD-RV21]

DVD VCD CD

A Repeat play

During play

Press [REPEAT MODE].

The display changes as illustrated.

•DVD

Chapter (C) → Title (T) → off (OFF)

•Video CD/CD

Track (T) → Entire disc (A) → off (OFF)

•If "C" appears on the television, press [■] to clear "▷" on the unit's display, press [▶] (play) then press [REPEAT MODE].

If the Video CD has playback control

Cancel menu play first.

1. Press [■] during play until "PBC PLAY" is cleared from the unit's display.

2. Press the numbered buttons to select a track to start play.

3. Press [REPEAT MODE] (⇒ above).

To return to menu play, press [■] and press [MENU].

Note

•Repeat play may not work as desired with some DVDs.

•Repeat play does not work if the disc's elapsed play time is not shown on the unit's display.

•There is no mode for repeating the whole DVD.

■ To repeat only your favorite tracks

VCD CD

1. Program the tracks you want (⇒ page 17).

2. Press [▶] (play). Play will start.

3. Press [REPEAT MODE] to display "CT" or "CA".

B A-B repeat play

You can repeat a section between points A and B within a title or track.

1

During play

Press [A-B REPEAT] at the starting point (A).

2

Press [A-B REPEAT] at the finishing point (B).

To cancel

Press [A-B REPEAT] until "C••" is displayed.

Note

•A-B repeat play does not work if the DVD's elapsed play time is not shown on the unit's display.

•Some subtitles recorded around point A or B may fail to appear (DVD).

•The unit automatically determines the end of a title/track as point B when the end of the title/track is reached.

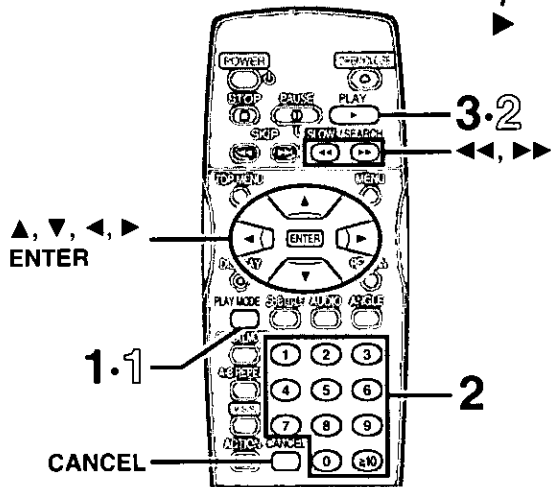
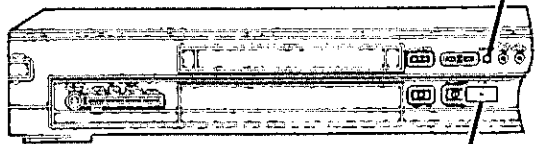

Changing the play sequence

A Program play

Remote control only

You can select up to 32 tracks to play in the order you choose.

- 1 While stopped
Press [PLAY MODE] until the program play screen appears.
- 2 Press the numbered buttons to select the track.
 - To select a 2-digit number
Example: To select track 23, press [≥ 10], then [2] and [3].
 - To select a track using the cursor buttons
Press [ENTER] and [Δ , ∇] to select a track, then press [ENTER] again to register the track number.
 - Repeat step 2 to select another track.
 - "Total Time" tells you the total time of the programmed tracks.
- 3 Press [▶] (play).
Play now begins in the programmed sequence.

To add or change tracks

Press [Δ , ∇] to select an available item, then repeat step 2.

To move to the page before or after the one shown

Press [\ll , \gg].

To clear the programmed tracks one by one

Press [Δ , ∇] to select the track and press [CANCEL]. (Alternatively you can select "Clear" and press [ENTER].)

To clear the whole program

Move to "Clear all" with [Δ , ∇ , \ll , \gg] and press [ENTER].

The whole program is also cleared when the unit is turned off or the disc tray is opened.

To exit the program mode

Press [PLAY MODE] while stopped until the program play screen disappears.

- The program is retained in memory.

B Random play

DVD-RV41: Remote control only

The unit plays the tracks on a disc in random order.

- 1 While stopped
Press [PLAY MODE] until the random play screen appears.
- 2 Press [▶] (play).
Play now begins in random order.

To exit random mode

Press [PLAY MODE] while stopped until the random play screen disappears.

The random play screen also appears if you press [RANDOM] on the main unit.

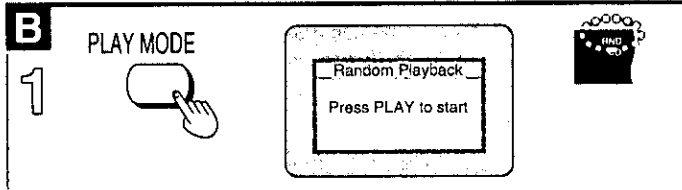
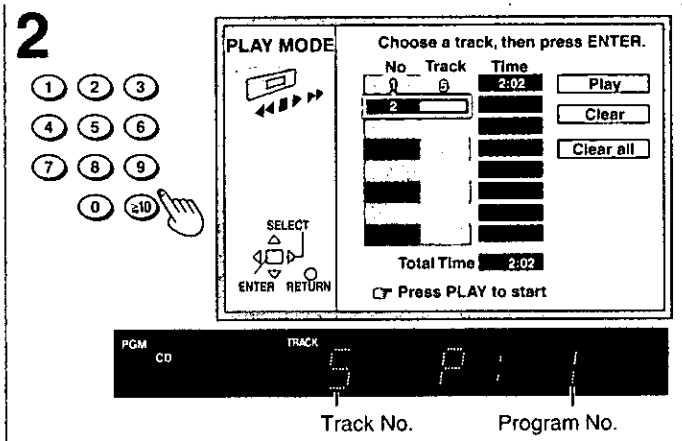
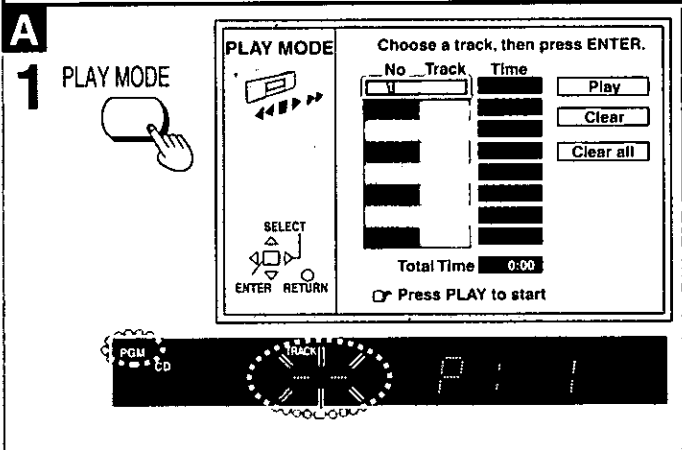

Using On-Screen Menu Icons

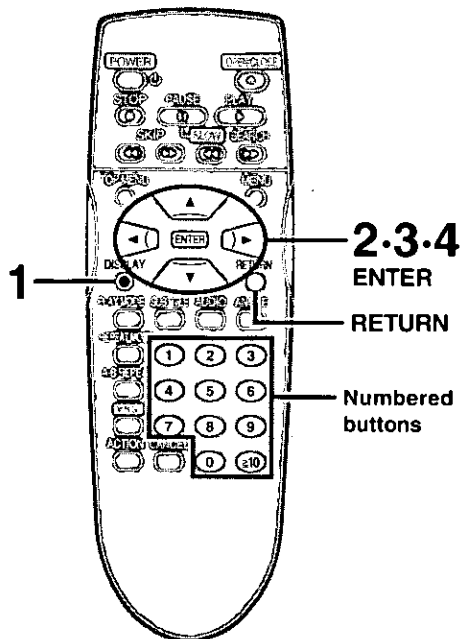

DVD-RV41

DVD-RV31 [DVD-RV26] DVD-RV21 : Remote control only

DVD VCD CD

On-Screen Menu Icons are menus that contain information about the disc or unit. These menus allow you to perform operations by changing this information.

Common procedures

1 Press [DISPLAY].

Each time you press the button:

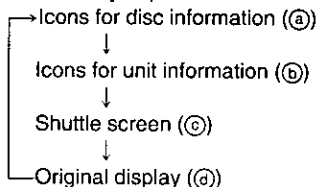

•The screens depend on the disc contents.

2 Icons for unit information only

While the leftmost icon is highlighted

Press [▲, ▼] to select the menu.

Each time you press the button:

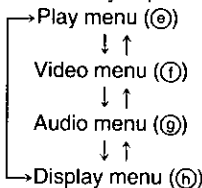

3 Press [◀, ▶] to select the item.

4 Press [▲, ▼] to select the setting.

Items with "▲" or "▼" above and below can be changed by [▲, ▼]. Other items use different buttons. See page 20 for details.

For your reference

- Some functions cannot be accessed from the stop mode (e.g. changing the soundtrack language).
- Press [ENTER] if the setting does not change after pressing [▲, ▼].
- When numbers are displayed (e.g. title No.), the numbered buttons are also effective for setting. When numbers are entered with the numbered buttons, press [ENTER] to register the setting.

To clear the icons

Press [RETURN].

When [RETURN] is pressed while one of the icons for unit information is highlighted, the leftmost icon is highlighted. The icons are cleared when you press [RETURN] while the leftmost icon is highlighted.

■ To change the position of the icons

You can lower the position of the icons on the screen if they are cut off for some reason. There are 5 positions to choose from.

1. Press [◀, ▶] to select the rightmost icon.
2. Press [▲, ▼] to move the icons.

1 DISPLAY

Example: DVD

2

3

4

Icons for disc information

Icon	Content
	DVD Title number VCD CD Track number
	DVD Chapter number
	DVD Time (select a position to start play by specifying a time) VCD CD Changing the time display → Track elapsed time ↓ ↑ Track remaining time ↓ ↑ → Disc remaining time
	DVD Soundtrack language (See A at right for language abbreviations.)
	Audio signal type (See B at right for details.)
	Karaoke vocal on/off (Karaoke DVD only) Solo : OFF or ON Duet : OFF, V1+V2, V1 or V2
	DVD Subtitle language (See A at right for language abbreviations.)
	Subtitles on/off ON ↔ OFF

Icon	Content
	DVD Angle number
	VCD Audio mode LR ↔ L ↔ R ↑
	VCD (with playback control only) Menu play Indicates whether menu play (playback control) is on or off.

A Audio/Subtitle language

ENG: English	SVE: Swedish	CHI: Chinese
FRA: French	NOR: Norwegian	KOR: Korean
DEU: German	DAN: Danish	MAL: Malay
ITA: Italian	POR: Portuguese	VIE: Vietnamese
ESP: Spanish	RUS: Russian	THA: Thai
NLD: Dutch	JPN: Japanese	*: Others

B Signal type/data

LPCM/DD Digital/DTS: Signal type
k (kHz): Sampling frequency
b (bit): Number of bits
ch (channel): Number of channels

Example:

3/2 .1ch

.1:	Subwoofer signal (not displayed if there is no subwoofer signal)
0:	No surround
1:	Mono surround
2:	Stereo surround (left/right)
1:	Center
2:	Front left+Front right
3:	Front left+Front right+Center

Shuttle screen

Icon	Content
	Pause
	Slow-motion play ◀: Backward DVD ▶: Forward DVD VCD
	Play
	Search ◀◀: Backward ▶▶: Forward

- There are five speeds for both backward and forward slow-motion and search.
- The numbers on either side of the shuttle screen indicate the maximum speeds of the search.

Icons for unit information

Icons for play menu



Icon	Content
	A-B repeat (⇒ page 16) [ENTER] (start point) ⇒ [ENTER] (finish point) To cancel [ENTER]
	Repeat play (⇒ page 16) DVD C (Chapter) ↔ T (Title) ↔ OFF VCD CD T (Track) ↔ A (All) ↔ OFF
	VCD CD Play mode display ---: Off PGM: Program play RND: Random play
	Marker You can mark up to 5 positions to play again. [ENTER] (The unit is now ready to accept markers.) ----- To mark a position [ENTER] (at the desired point) ----- To mark another position [◀, ▶] ⇒ [ENTER] ----- To recall a marker [◀, ▶] ⇒ [ENTER] ----- To erase a marker [◀, ▶] ⇒ [CANCEL]

Icons for video menu



Icon	Content
	DVD VCD Digital picture mode N: Normal mode C: Cinema mode (⇒ page 15) U: User mode DVD-RV41 DVD-RV31 DVD-RV26 (⇒ see below) ----- The following items are also displayed when you select "U".
	Contrast (-7 to +7)
	Brightness (0 to +15)
	Color (-7 to +7)

Icons for audio menu



Icon	Content
	DVD (Dolby Digital, 2-channel or over only) Advanced Surround (V.S.S.) (⇒ page 14) 1 ↔ 2 ↔ OFF ↑
	DVD-RV31 DVD-RV26 DVD-RV21 Bass Plus (⇒ page 14) OFF ↔ ON
	DVD (Dolby Digital, 3-channel or over only) Dialogue Enhancer (⇒ page 15) ON ↔ OFF

Icons for display menu



Icon	Content
	DVD IPB display (⇒ page 32) Displays the picture type (I/P/B) in the still picture mode. ON ↔ OFF
	Display dimmer Changes the brightness of the unit's display. BRIGHT ↔ DIM ↔ AUTO* ↑ *The display is dimmed during play, but brightens when you perform operations such as slow-motion, search, and pause.

Advanced operations

Note

- A-B repeat play (DVD), repeat play and marker functions do not work if the disc's elapsed play time is not shown on the unit's display.
- All the markers are cleared when the unit is turned off, or the disc tray is opened.

Changing initial settings

DVD-RV41 **DVD-RV31** **DVD-RV23** **DVD-RV21**

Remote control only

Change the initial settings to suit your preferences and to suit the unit to the environment in which it is being used. These settings are retained in memory until they are changed, even if the unit is turned off.

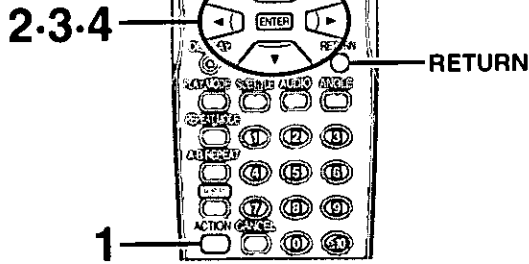

1 ACTION



2

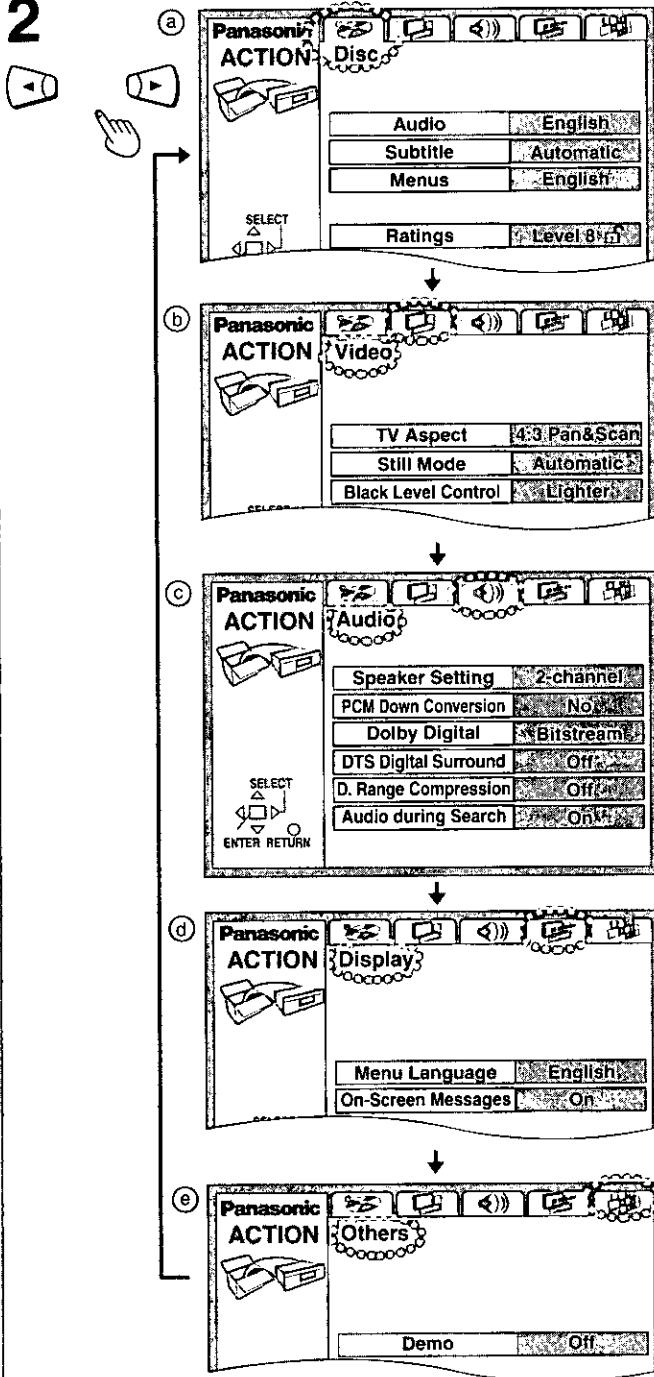

3.4

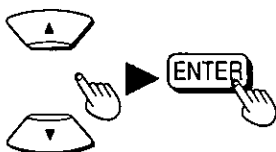

Common procedures

See page 22 for menu and option details.

- 1 Press [ACTION] to show the menus.**
The screen shows the disc settings menu (a) first.
- 2 Press [◀, ▶] to select the menu's tab.**
The screen changes to display the menu.
 - Disc menu (a)
 - ↓
 - Video menu (b)
 - ↓
 - Audio menu (c)*
 - ↓
 - Display menu (d)
 - ↓
 - Others menu (e)

*Speaker Setting: DVD-RV41 only
- 3 Press [▲, ▼] to select the item you want to change and press [ENTER].**
- 4 Press [▲, ▼] to select the option and press [ENTER].**
The screen now shows the menu again.

To return to the previous screen
Press [RETURN].

When you are finished
Press [ACTION].

Changing initial settings

DVD-RV41 DVD-RV31 **DVD-RV20** DVD-RV21

Summary of initial settings

This chart shows the initial settings for this unit. See page 21 for details on menu operation.

- The menu and on-screen message language has been factory preset to English. You can change the language by going to "Menu Language" in the Display menu.

Main menus	Menus	Options
Disc DVD	Audio Choose the preferred audio language.	English French Spanish Original Other ****
	Subtitle Choose the preferred subtitle language.	Automatic English French Spanish Other ****
	Menus Choose the preferred language for disc menus.	English French Spanish Other ****
	Ratings Set a ratings level to limit DVD play.	Setting ratings (When level 8 is selected) 8 No Limit 1 to 7 0 Lock All ----- Changing ratings (When level 0-7 is selected) Unlock Player Change Level Change Password Temporary Unlock
Video DVD VCD	TV Aspect Choose the setting to suit your television and preference (⇒ page 9).	4:3 Pan&Scan 4:3 Letterbox 16:9
	Still Mode Specify the type of picture shown when paused.	Automatic Field Frame
	Black Level Control Change the black level of the picture if you connected a television through the COMPONENT VIDEO OUT terminals.	Lighter Darker
Audio	DVD-RV41 Speaker Setting DVD Choose the settings to suit your audio system and the listening environment (⇒ page 25).	Multi-channel ●Speaker presence and size Front (L/R): Large/Small Center/Surround (L/R): Large/Small/No Subwoofer: Yes/No ●Delay time Center: 0/1.3/2.6/3.9/5.3 ms Surround (L/R): 0/5.3/10.6/15.9 ms ●Channel balance Center/Surround (L/R)/Subwoofer: -6 to 0 to +6 dB ----- 2-channel
	PCM Down Conversion DVD Digital output during play of DVDs recorded in 96 kHz linear PCM (⇒ page 26)	No Yes
	Dolby Digital DVD Digital output during play of DVDs recorded with Dolby Digital (⇒ page 26)	Bitstream PCM
	DTS Digital Surround DVD Digital output during play of DVDs recorded with DTS Digital Surround (⇒ page 26)	Off Bitstream
	D. Range Compression DVD (Dolby Digital only) Change the dynamic range for late night viewing.	Off On
	Audio during Search DVD VCD Choose whether to have sound during search.	On Off
Display	Menu Language Choose the preferred language for these menus and the on-screen messages.	English Français Español
	On-Screen Messages Choose whether to show on-screen messages or not.	On Off
Others	Demo A demonstration of the unit's on-screen displays starts when you select "On".	Off On

• Underlined items are the factory presets.

	Remarks
<p>"Other ****": Input a code number with the numbered buttons (⇒ page 24).</p> <p>"Original": The original language of each disc will be selected.</p> <p>"Automatic": If the language selected for "Audio" is not available, subtitles of that language will automatically appear if available on that disc.</p>	<p>Some discs are designed to start in a certain language despite any changes you make here.</p>
<p>Level 8: All DVDs can be played.</p> <p>Level 1 to 7: Prohibits play of DVDs with corresponding ratings recorded on them.</p> <p>Level 0: Prohibits play of all DVDs.</p>	<p>• The password screen is shown if you choose levels 0 to 7 (⇒ page 24).</p> <p>• Select "Level 0" to prevent play of discs that do not have ratings levels recorded on them.</p> <p>The password screen is shown when you select "Ratings" if levels 0 to 7 have been selected (⇒ page 24).</p>
<p>Field: Less blurred field stills are shown. Select if jittering occurs when "Automatic" is selected.</p> <p>Frame: Sharper frame stills are shown. Select if small text or fine patterns cannot be seen clearly when "Automatic" is selected.</p>	
<p>Lighter: when connected to a TV through the VIDEO OUT or S VIDEO OUT terminal.</p> <p>Darker: when connected to a TV through the COMPONENT VIDEO OUT (Y/P_B/P_R) terminals.</p>	
<p>Multi-channel: when 3 or more speakers are connected.</p> <p>Speaker size – Large: when the speaker supports low-frequency (under 100 Hz) reproduction.</p> <p>Speaker size – Small: Select when the speaker does not support low-frequency reproduction.</p> <p>Delay time: when the center/surround speakers cannot be located in the ideal position.</p> <p>Channel balance: when the speaker level appear to be different when listening to a source.</p> <p>2-channel: when 2 speakers or an amplifier with a Dolby Pro Logic decoder is connected.</p>	<p>The size setting for the front speakers is automatically determined by the setting for the subwoofer. (If you do not connect a subwoofer, it is preferable to connect front speakers capable of producing bass of less than 100 Hz.)</p>
	<p>Dynamic range is the difference between the loudest sound and the softest sound. By compressing this range, you can listen at low volume but still enjoy clear dialog.</p>
	<p>The demonstration stops when you press a button.</p>

DVD-RV41 DVD-RV31 **DVD-RV26** DVD-RV21

DVD

Entering a password

Refer also to "Common procedures" (→ page 21) and the "Disc menu" section in "Summary of initial settings" (→ page 22).

When setting ratings (When the level is 8)

The password screen is shown when you select levels 0 to 7.

1. Input a 4-digit password with the numbered buttons and press [ENTER].

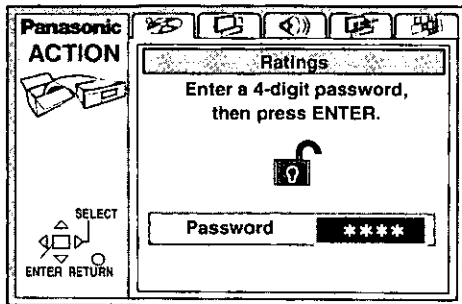

- If you enter a wrong number, press [CANCEL] to erase it before you press [ENTER].

The lock symbol appears closed to show the rating is locked.

Do not forget your password.

2. Press [ENTER] to confirm the 4 digits.

When changing ratings (When the level is 0 to 7)

The password screen is shown when you select "Ratings".

1. Input a 4-digit password with the numbered buttons and press [ENTER].

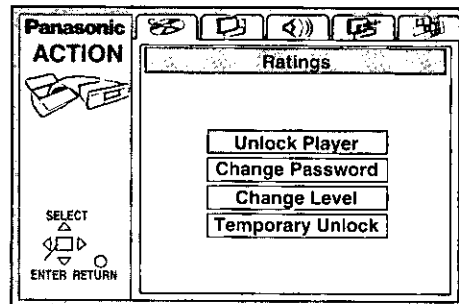

2. Select the item with [▲, ▼] and press [ENTER], and follow the on-screen instructions.

Now, when you insert a DVD that exceeds the ratings limit you set, a message appears on the television. Follow the on-screen instructions.

Language code list

Abkhazian: 6566	Chinese: 9072	Hausa: 7265	Lithuanian: 7684	Romanian: 8279	Telugu: 8469
Afar: 6565	Corsican: 6779	Hebrew: 7387	Macedonian: 7775	Russian: 8285	Thai: 8472
Afrikaans: 6570	Croatian: 7282	Hindi: 7273	Malagasy: 7771	Samoan: 8377	Tibetan: 6679
Albanian: 8381	Czech: 6783	Hungarian: 7285	Malay: 7783	Sanskrit: 8365	Tigrinya: 8473
Ameharic: 6577	Danish: 6865	Icelandic: 7383	Malayalam: 7776	Scots Gaelic: 7168	Tonga: 8479
Arabic: 6582	Dutch: 7876	Indonesian: 7378	Maltese: 7784	Serbian: 8382	Turkish: 8482
Armenian: 7289	English: 6978	Interlingua: 7365	Maori: 7773	Serbo-Croatian: 8372	Turkmen: 8475
Assamese: 6583	Esperanto: 6979	Irish: 7165	Marathi: 7782	Shona: 8378	Twí: 8487
Aymara: 6588	Estonian: 6984	Italian: 7384	Moldavian: 7779	Sindhi: 8368	Ukrainian: 8575
Azerbaijani: 6590	Faroese: 7079	Japanese: 7465	Mongolian: 7778	Singhalese: 8373	Urdu: 8582
Bashkir: 6665	Fiji: 7074	Javanese: 7487	Nauru: 7865	Slovak: 8375	Uzbek: 8590
Basque: 6985	Finnish: 7073	Kannada: 7578	Nepali: 7869	Slovenian: 8376	Vietnamese: 8673
Bengali; Bangla: 6678	French: 7082	Kashmiri: 7583	Norwegian: 7879	Somali: 8379	Volapük: 8679
Bhutani: 6890	Frisian: 7089	Kazakh: 7575	Oriya: 7982	Spanish: 6983	Welsh: 6789
Bihari: 6672	Galician: 7176	Kirghiz: 7589	Pashto, Pushto: 8083	Sundanese: 8385	Wolof: 8779
Breton: 6682	Georgian: 7565	Korean: 7579	Persian: 7065	Swahili: 8387	Xhosa: 8872
Bulgarian: 6671	German: 6869	Kurdish: 7585	Polish: 8076	Swedish: 8386	Yiddish: 7473
Burmese: 7789	Greek: 6976	Laotian: 7679	Portuguese: 8084	Tagalog: 8476	Yoruba: 8979
Byelorussian: 6669	Greenlandic: 7576	Latin: 7665	Punjabi: 8065	Tajik: 8471	Zulu: 9085
Cambodian: 7577	Guarani: 7178	Latvian, Lettish: 7686	Quechua: 8185	Tamil: 8465	
Catalan: 6765	Gujarati: 7185	Lingala: 7678	Rhaeto-Romance: 8277	Tatar: 8484	

Changing initial settings

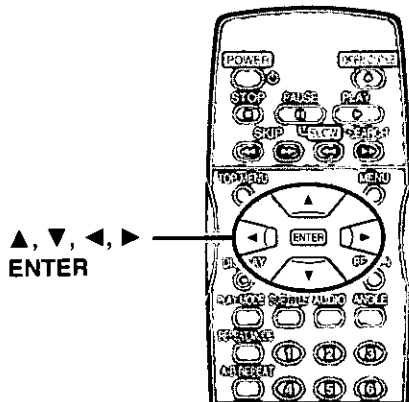

▲, ▼, ◀, ▶
ENTER

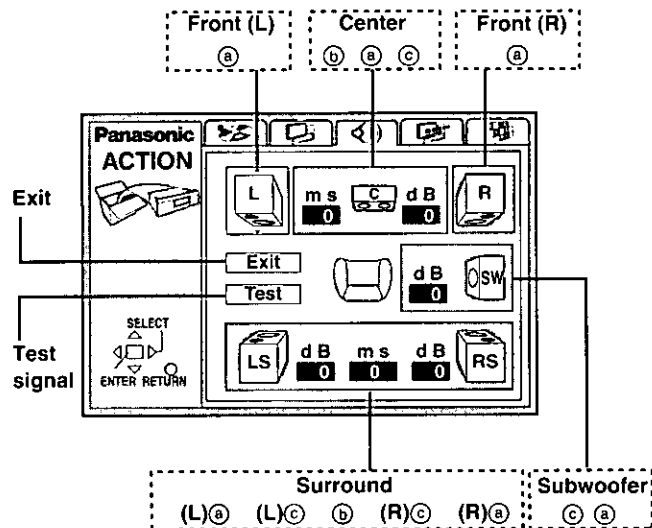

A



B

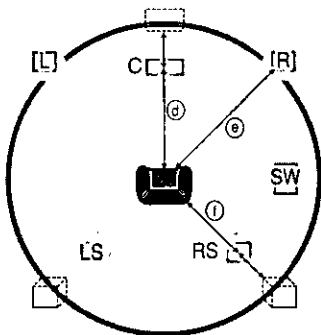

DVD-RV41

DVD

Speaker setting

Select either "2-channel" or "Multi-channel" to suit the speakers you have connected. You can change the following settings when you select "Multi-channel".

A Speaker presence and size (a)

1. Press [▲, ▼, ◀, ▶] to select the item and press [ENTER].
2. Press [▲, ▼] to select the setting and press [ENTER].

Icon examples: Surround speaker (L)

B Delay time (b)

DVD (Dolby Digital, center and surround speakers only)

For optimum listening with 5.1-channel sound, all the speakers, except for the subwoofer, should be the same distance from the seating position. If you have to place the center or surround speakers closer to the seating position, adjust the delay time to make up for the difference.

If distance (a) (from the center speaker) and (f) (from the surround speakers) are the same as or greater than (a) (from the front speakers), leave the delay time as "0", the factory preset.

If either distance (a) or (f) is less than (a), find the difference in the relevant table and change to the recommended setting.

• Center speaker

Difference	Setting
Approx. 50 cm (1 1/2 feet)	1.3 ms
Approx. 100 cm (3 feet)	2.6 ms
Approx. 150 cm (5 feet)	3.9 ms
Approx. 200 cm (6 feet)	5.3 ms

• Surround speakers

Difference	Setting
Approx. 200 cm (6 feet)	5.3 ms
Approx. 400 cm (12 feet)	10.6 ms
Approx. 600 cm (18 feet)	15.9 ms

Changing the delay time

1. Press [▲, ▼, ◀, ▶] to select the delay time box and press [ENTER].
2. Press [▲, ▼] to adjust the delay time and press [ENTER].

Channel balance (c)

1. Press [▲, ▼, ◀, ▶] to select "Test" and press [ENTER].
A test signal is output from one speaker at a time, starting with the front left speaker and proceeding clockwise.
FRONT(L) → CENTER → FRONT(R)
↑ ↓
SURROUND(L) ← SURROUND(R)
2. While listening to the test signal, press [▲, ▼] to adjust the volume of the center and surround speakers so they are the same apparent volume as the front speakers.
(The front speakers cannot be adjusted here.)
3. Press [ENTER].
(The test signals are stopped.)

Note

No signal is output for the subwoofer. To adjust its volume, play something, then return to this screen to adjust to suit your taste.

When you are finished

Press [▲, ▼, ◀, ▶] to select "Exit" and press [ENTER].

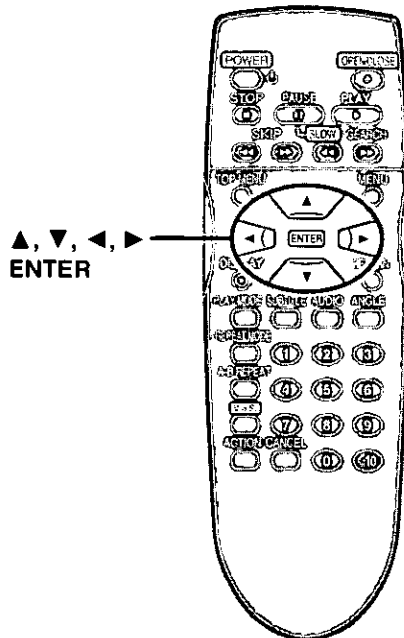

Changing initial setting

DVD-RV41 DVD-RV31 DVD-RV26 DVD-RV21

DVD

Digital output

Refer also to "Common procedures" (⇒ page 21) and the "Audio menu" section in "Summary of initial settings" (⇒ page 22).

PCM Down Conversion

No (Factory preset):

When you have connected an amplifier with audio cables.

Yes:

When you have connected an amplifier with an optical digital audio cable.

Copyright protection limits digital output to 48 kHz/16 bit.

When playing DVDs recorded in 96 kHz

Sound is output as follows in accordance with the connections and settings you have made.

Setting	Connection	
	Digital	Analog
No	No output (If there is no copyright protection, audio is output at 96 kHz.*1)	Output as 96 kHz
Yes	Converted and output as 48 kHz/16 bit	Converted and output as 48 kHz

*1 The connected equipment must be able to handle 96 kHz LPCM in order to take advantage of high quality audio found on these discs.

Dolby Digital

Bitstream (Factory preset):

When you have connected a unit with a built-in Dolby Digital decoder.

PCM:

When you have connected a unit that doesn't have a built-in Dolby Digital decoder.*2

DTS Digital Surround

Off (Factory preset):

When you have connected a unit that doesn't have a built-in DTS decoder.*2 (No digital signal is output.)

Bitstream:

When you have connected a unit with a built-in DTS decoder.

*2 These changes to digital audio output must be made, otherwise bitstream signals the decoder cannot handle will be output. If these signals are output, "noise" will be output which can cause harm to your ears and speakers.

Home Theater—Enjoying more powerful sound

DVD-RV41

This model has a multi-channel (5.1-channel) Dolby Digital decoder so you can enjoy the movie theater-like surround effects found on discs encoded with Dolby Digital merely by connecting it to the 5.1-channel input terminals on an amplifier.

This model does not have a DTS decoder. You must connect a unit with a DTS decoder to enjoy the powerful surround effects this system can provide.

DVD-RV31 | DVD-RV26 | DVD-RV21

These models can play Dolby Digital, but only in two channels. None of these models have a DTS decoder. You must connect a unit with a Dolby Digital or DTS decoder to enjoy surround sound.

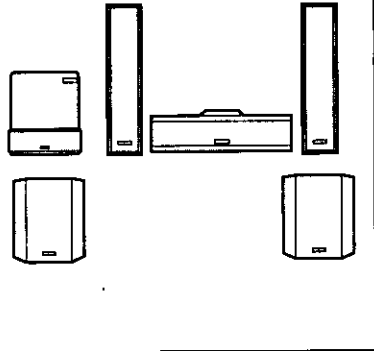
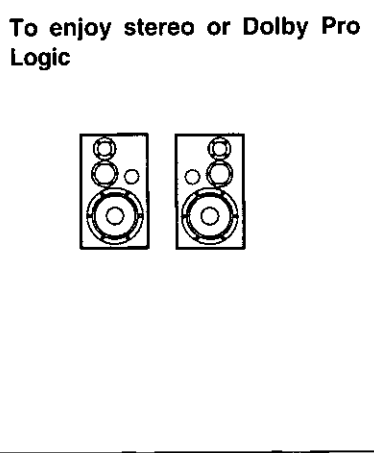
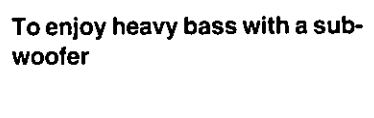
What you want to do	How to do it	Reference page	Settings	Reference page
To enjoy 5.1-channel surround sound 	DVD-RV41 Analog connection Connect to an amplifier with 5.1-channel audio input terminals.	28 A	DVD-RV41 Speaker Setting Select "Multi-channel".	25
	DVD-RV41 DVD-RV31 DVD-RV26 DVD-RV21 Digital connection Connect to an amplifier with built-in decoder or a separate decoder-amplifier combination.	28 B	PCM Down Conversion Select "No".	26
To enjoy stereo or Dolby Pro Logic 	DVD-RV41 DVD-RV31 DVD-RV26 DVD-RV21 Analog connection Connect to an analog amplifier or system component.	29 C	DVD-RV41 Speaker Setting Select "2-channel".	22
	DVD-RV41 DVD-RV31 DVD-RV26 DVD-RV21 Digital connection Connect to a digital amplifier or system component.	29 D	PCM Down Conversion Select "Yes".	26
To enjoy heavy bass with a subwoofer 	DVD-RV31 DVD-RV26 DVD-RV21 Connect an active subwoofer.	29	Bass Plus Select "ON".	14

Other uses

Recording to MDs or cassette tapes (→ page 29).

Note

- The equipment connections described are examples.
- Peripheral equipment and optional cables sold separately unless otherwise indicated.
- Before connection, turn off all equipment and read the appropriate operating instructions.

Manufactured under license from Dolby Laboratories. "Dolby", "Pro Logic" and the double-D symbol are trademarks of Dolby Laboratories. Confidential unpublished works. © 1992–1997 Dolby Laboratories. All rights reserved.

"DTS" and "DTS Digital Surround" are trademarks of Digital Theater Systems, Inc.

A Connecting an amplifier with 5.1-channel audio input terminals

DVD-RV41

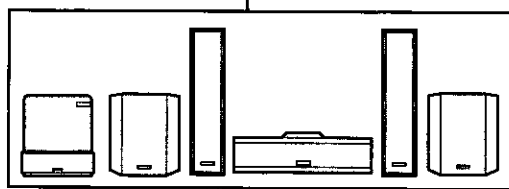
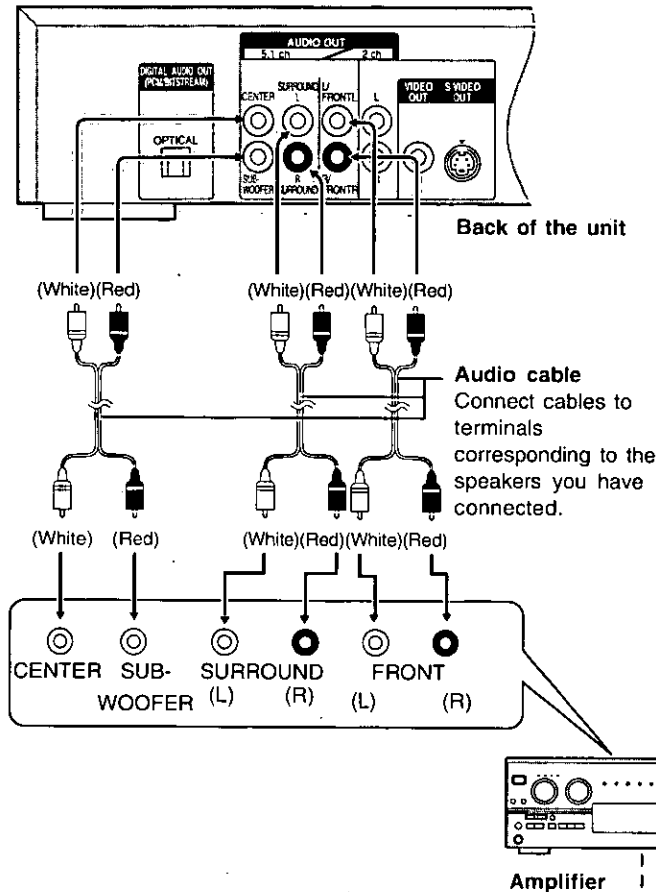

Speakers
You can enjoy surround sound by connecting from three to six speakers.
Example: Six speakers

- Select "Multi-channel" and adjust the settings to suit the speakers you have connected (⇒ page 25).
- Select "No" in "PCM Down Conversion" (⇒ page 26).

Note

- Turn Advanced Surround off (⇒ page 14) if you have connected a center speaker, surround speakers or a subwoofer, as well as the front speakers. Sound will not come from the other speakers if Advanced Surround is on.
- Use the connection described in **B** at right to enjoy DVDs encoded with DTS.
- If you do not connect a subwoofer, it is advisable to connect front speakers (L/R) capable of producing bass of less than 100 Hz.

B Connecting an amplifier with a built-in decoder or a decoder-amplifier combination

DVD-RV41 DVD-RV31 [DVD-RV26] DVD-RV21

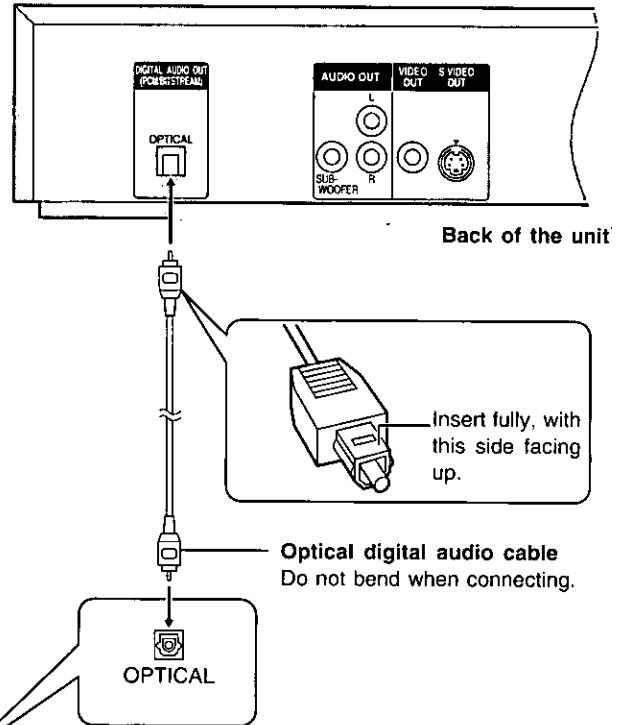

Adjust the settings to suit the equipment you have connected (⇒ page 26).

Note

You cannot use DTS Digital Surround decoders not suited to DVD.

C Connecting an analog amplifier or system component

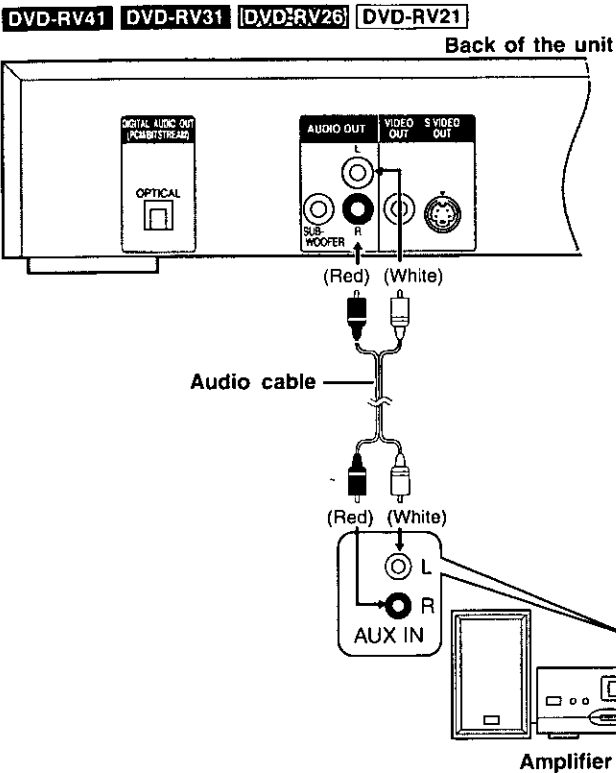

- Select "2-channel" (⇒ page 22). **DVD-RV41**
- Select "No" in "PCM Down Conversion" (⇒ page 26).

D Connecting a digital amplifier or system component

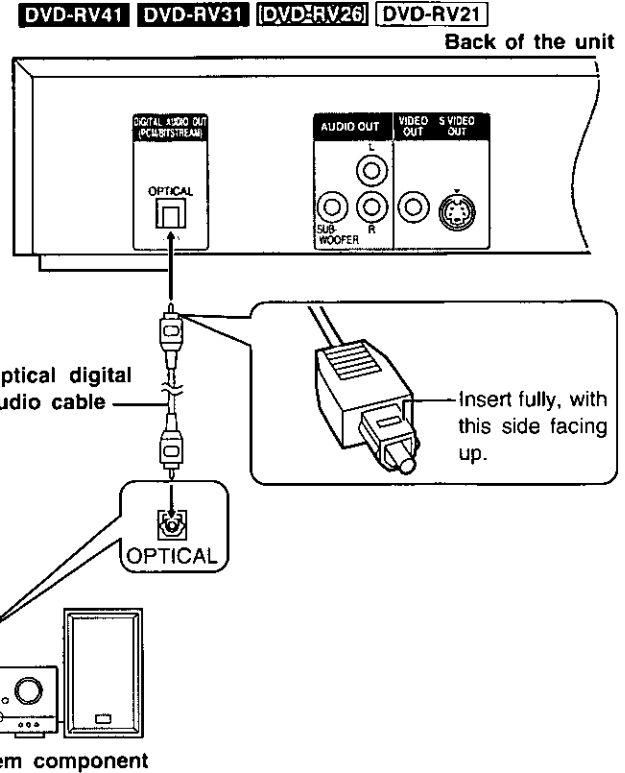

- Adjust the settings to suit the equipment you have connected (⇒ page 26).

To enjoy Dolby Pro Logic

- If you connect an amplifier with a Dolby Pro Logic decoder, you will also need to connect center and surround speakers to enjoy surround sound. Read the instructions for the equipment for connection details.
- Turn Advanced Surround and Bass Plus off (⇒ page 14). The Dolby Pro Logic decoder will not function correctly if Advanced Surround or Bass Plus is on.

Connecting an active subwoofer (optional)

DVD-RV31 [DVD-RV26] DVD-RV21

You can enjoy more powerful bass by connecting an active subwoofer.

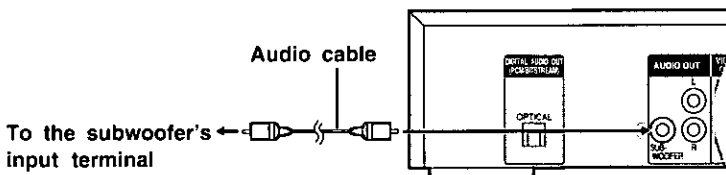

- Place the subwoofer as close as possible to the front center.
- Turn BASS PLUS on to boost the output from the subwoofer (⇒ page 14).
- Adjust the volume on the subwoofer to suit your preference.

Recording to MDs or cassette tapes

DVD-RV41 DVD-RV31 [DVD-RV26] DVD-RV21

■ Analog recording

You can record to an MD or cassette tape. Using analog connection means sound will be unaffected by the copy guards found on DVDs.

To make an analog recording

1. Connect the recording equipment with an audio cable (⇒ C above).

DVD-RV41

2. Set "Speaker Setting" to "2-channel" (⇒ page 22). (If this is set to "Multi-channel", only the audio for the front 2 speakers will be recorded.)

■ Digital recording

You can record the digital signal directly onto an MD.

The signals on DVDs will be converted to 48 kHz/16 bit linear PCM. Ensure the following conditions are met.

- There is no copy guard recorded on the disc.
- The recording equipment can handle a sampling frequency of 48 kHz/16 bit.

To make a digital recording

1. Connect the recording equipment with an optical digital audio cable (⇒ D above).
2. When recording DVDs, change the digital audio output settings (⇒ page 26).
PCM Down Conversion: Yes
Dolby Digital: PCM
DTS Digital Surround: Off

Troubleshooting guide

Before requesting service, make the below checks. If you are in doubt about some of the check points, or if the remedies indicated in the chart do not solve the problem, contact below.

In the U.S.A., contact the Panasonic Customer Call Center at 1-800-211-7262, or e-mail consumerproducts@panasonic.com, or web site (<http://www.panasonic.com>).

In Canada, contact Panasonic Canada Inc. Customer Care Centre at 1-800-561-5505, or web site (www.panasonic.ca), or an authorized Servicentre nearest you.

Reference pages are shown as black circled numbers ⑤.

Power

No power.	<ul style="list-style-type: none"> ● Insert the AC power supply cord securely into the household AC outlet. ⑤
The unit is automatically switched to the standby mode.	<ul style="list-style-type: none"> ● To conserve power, the unit automatically switches to the standby mode after approx. 30 minutes elapse in the stop mode (Auto power-off function). Turn the power back to ON.

Operation

No response when buttons pressed.	<ul style="list-style-type: none"> ● Some operations may be prohibited by the disc. ● The unit may not be operating properly due to lightning, static electricity or some other external factor. Reset procedure: Press [POWER ⏻/⏻] to switch the unit to the standby mode and then back to ON. Alternatively, press [POWER ⏻/⏻] to switch the unit to the standby mode, disconnect the AC power supply cord, and then reconnect it.
No operations can be performed with the remote control.	<ul style="list-style-type: none"> ● Check the batteries are installed with the correct polarities (+ and -). ⑦ ● The batteries are depleted: Replace them with new ones. ⑦ ● Point the remote control at the remote control sensor and operate. ⑦
Play fails to start even when [▶] (play) is pressed. Play starts but then stops immediately.	<ul style="list-style-type: none"> ● Condensation has formed: Wait 1 to 2 hours for it to evaporate. ● This unit cannot play discs other than DVD, Video CD and CD. ⑤ ● This unit cannot play DVDs with a region number other than "1", "ALL" or multiple region numbers including "1". ⑤ ● The disc may be dirty and may require cleaning. ⑤ ● Ensure that the disc is installed with the label of the side to be played facing upwards. ⑩
Alternative languages fail to be selected.	<ul style="list-style-type: none"> ● An alternative language is not selected with discs which do not contain more than one language. ● In the case of some discs, the alternative language cannot be selected with [AUDIO] or [SUBTITLE]. Try selecting it from the disc's menu if one is available. ⑩
No subtitles.	<ul style="list-style-type: none"> ● Subtitles appear only with discs that contain them. ● Subtitles are cleared from the television. Display the subtitles. ⑬
Soundtrack and/or subtitle language is not the one selected at the initial settings.	<ul style="list-style-type: none"> ● The language is not recorded on the disc.
Angle cannot be changed.	<ul style="list-style-type: none"> ● This function is dependent on software availability. Even if a disc has a number of angles recorded, these angles may be recorded for specific scenes only. ⑬
You have forgotten your ratings password. Reset all the settings to Factory Preset.	<ul style="list-style-type: none"> ● While stopped, press and hold [⏮] (DVD-RV41, DVD-RV31, DVD-RV26) or [⏮, ⏮] (DVD-RV21) and [■] on the unit and then also press and hold [▲] on the unit until "Initialized" disappears from the television. Turn the unit off and on again. All initial settings will return to the default values.

Sound

No sound. Distorted sound.	<ul style="list-style-type: none"> ● Check the connections. ⑤ ⑫ ⑭ ● Check the volume on the equipment you have connected. ● Ensure that the input settings for the television and stereo system are correct. ● If you have connected this unit to an amplifier through the AUDIO OUT terminals, go to the Audio menu in the ACTION screen, and change "Speaker Setting" to suit your speakers. Select "Yes" for all the speakers you have connected. ⑫ DVD-RV41 ● Sound will only come from the 2 front speakers if Advanced Surround is on. Turn Advanced Surround off if you are using three or more speakers. ⑫
Piercing noise comes from the speakers.	<ul style="list-style-type: none"> ● If you have connected this unit to other equipment through the DIGITAL AUDIO OUT terminal, ensure you have selected the correct settings for "Dolby Digital" and "DTS Digital Surround" in the ACTION screen's Audio menu. ⑫

Picture

Picture distorted during search.	<ul style="list-style-type: none"> •The picture will be somewhat distorted at times: This is normal.
No picture.	<ul style="list-style-type: none"> •Ensure that the equipment is connected properly. ③ •Make sure the television is on. •Ensure the television's video input setting (e.g., VIDEO 1) is correct.
The picture shown on the television is not normal. (The sides of the picture are cut off or black bands appear at the top and bottom of the screen.)	<ul style="list-style-type: none"> •Go to the Video menu in the ACTION screen, and change "TV Aspect" to suit your television. You may also need to change the screen mode on the television itself. ④ •Ensure that the unit is connected directly to the television, and is not connected through a video cassette recorder.

Displays

"NO PLAY" appears on the unit's display.	<ul style="list-style-type: none"> •You inserted a disc the unit cannot play; insert one it can. ⑤
No on-screen display.	<ul style="list-style-type: none"> •Go to the Display menu in the ACTION screen, and select "On" for "On-Screen Messages". ⑦
On-Screen Menu Icons not displayed or only partially displayed on the television.	<ul style="list-style-type: none"> •Press [▲, ▼] while the rightmost icon is highlighted to move them down. ⑩
The disc's menu is displayed in a different language.	<ul style="list-style-type: none"> •Go to the Disc menu in the ACTION screen, and select the preferred language for "Menus". ⑫
No menu play.	<ul style="list-style-type: none"> •Menus are only displayed if they are recorded on the disc.
"CHECK THE DISC" appears on the unit's display.	<ul style="list-style-type: none"> •Disc is dirty. Wipe the disc clean. ⑤
"H□□" appears on the unit's display. □□ stands for a number.	<ul style="list-style-type: none"> •Trouble is likely to have occurred. The number following "H" depends on the status of the unit. Reset procedure: Press [POWER ⏻/⏻] to switch the unit to the standby mode and then back to ON. Alternatively, press [POWER ⏻/⏻] to switch the unit to the standby mode, disconnect the AC power supply cord, and then reconnect it. •If the service numbers fail to clear, note the service number and contact a qualified service person.
"NO DISC" appears on the unit's display.	<ul style="list-style-type: none"> •You haven't inserted a disc; insert one. •You haven't inserted the disc correctly; insert it correctly.

Product Service

Do not attempt to remove the cover(s) or repair the unit yourself. Refer servicing to qualified personnel only.

Product information

For product service, product information or assistance with product operation, refer to the servicenter directory.

Maintenance

To clean this unit, wipe with a soft, dry cloth.

If the surfaces are extremely dirty, use a soft cloth dampened with a soap and water solution or a weak detergent solution.

- Never use alcohol, paint thinner or benzine to clean this unit.
- Before using chemically treated cloth, read the instructions that came with the cloth carefully.

Bitstream

This is the digital form of multiple channel audio data (e.g., 5.1 channel) before it is decoded into its various channels.

Dolby Digital

This is a method of coding digital signals developed by Dolby Laboratories. Apart from stereo (2-channel) audio, these signals can also be 5.1-channel audio. A large amount of audio information can be recorded on one disc using this method.

Dolby Pro Logic

A surround system where a 4-channel audio track is recorded as 2 channels and then is restored to 4 channels for play. The surround channel is monaural and can reproduce up to 7 kHz.

DTS (Digital Theater Systems)

This surround system is used in many movie theaters around the world. There is good separation between the channels, so realistic sound effects are possible.

Dynamic range

Dynamic range is the difference between the lowest level of sound that can be heard above the noise of the equipment and the highest level of sound before distortion occurs.

Field

One frame is made up of 2 fields. A regular television shows these fields one after the other to create frames.

Frame

Frames are the still pictures that go together to make a moving picture. There are about 30 frames shown each second.

Frame still and field still

A still is shown when you pause a moving picture. A frame still is made up of 2 alternating fields, so the picture may appear blurred, but overall quality is high.

A field still is not blurred, but it has only half the information of a frame still so picture quality is lower.

I/P/B

MPEG 2, the video compression standard adopted for use with DVD-Video, codes frames using these 3 picture types.

I: Intra coded picture (I-picture)

This is the standard picture and is a complete picture in itself.

This means it has the best picture quality and is the best to use when adjusting the picture.

P: Predictive coded picture (P-picture)

This picture is calculated based on past I or P-pictures.

B: Bidirectionally-predictive coded picture (B-picture)

This picture is calculated by comparing past and future I and P-pictures so it has the lowest volume of information.

Linear PCM (pulse code modulation)

PCM is the usual digital method used for music CDs. DVDs have a greater volume so they use linear PCM, which has a higher sampling rate. Compressed PCM signals are called packed PCM (PPCM).

Optical digital audio cable

Electronic signals are converted to optical signals for output to the amplifier. This reduces noise caused by electronic interference.

Playback control

If a Video CD has "playback control" written on it or its jacket, it means that particular scenes or information can be selected for viewing interactively with the television using the menu screen. This unit can play Video CDs with playback control.

Using menus to control play of a Video CD is called "menu play" in these operating instructions.

Title/Chapter

DVDs are divided up into large sections, titles, and smaller sections, chapters. The numbers allocated to these sections are called title numbers and chapter numbers.

Track

Video CDs and CDs are divided up into sections called tracks, and the numbers allocated to these sections are called track numbers.

Panasonic

Technics

Quasar

*For Product Information, Operating Assistance, Literature Request, Dealer Locations, and all Customer Service inquiries please contact:
1-800-211-PANA (7262), Monday-Friday 9 am-9 pm; Saturday-Sunday 9 am-7 pm, EST.*

*Web Site: <http://www.panasonic.com>
You can purchase parts, accessories or locate your nearest servicenter by visiting our Web Site.*

Accessory Purchases:

1-800-332-5368 (Customer Orders Only)
Panasonic Services Company 20421 84th Avenue South, Kent, WA 98032
(6 am to 5 pm Monday-Friday; 6 am to 10:30 am Saturday; PST)
(Visa, MasterCard, Discover Card, American Express, Check)

Factory Servicenters Locations

<p>CALIFORNIA 6550 Katella Avenue Cypress, CA 90630</p> <p>800 Dubuque Avenue S. San Francisco CA 94080</p> <p>20201 Sherman Way Suite 102 Canoga Park, CA 91306</p> <p>3878 Ruffin Road Suite A San Diego, CA 92123</p> <p>COLORADO 1640 South Abilene Street Suite D Aurora, CO 80012</p> <p>FLORIDA 3700 North 29th Avenue Suite 102 Hollywood, FL 33020</p>	<p>GEORGIA 8655 Roswell Road Suite 100 Atlanta, GA 30350</p> <p>ILLINOIS 9060 Golf Road Niles, IL 60714</p> <p>1703 North Randall Road Elgin, IL 60123 (Pick-up/Drop-off only)</p> <p>MARYLAND 62 Mountain Road Glen Burnie, MD 21061</p> <p>MASSACHUSETTS 60 Glacier Drive Suite G Westwood, MA 02090</p>	<p>MICHIGAN 37048 Van Dyke Avenue Sterling Heights, MI 48312</p> <p>MINNESOTA 7850-12th Avenue South Airport Business Center Bloomington, MN 55425</p> <p>OHIO 2236 Waycross Road Civic Center Plaza Forest Park, OH 45240</p> <p>PENNSYLVANIA 2221 Cabot Blvd. West Suite B Langhorne, PA 19047</p>	<p>TEXAS 13615 Welch Road Suite 101 Farmers Branch TX 75244</p> <p>WASHINGTON 20425-84th Avenue South Kent, WA 98032</p> <p>HAWAII 99-859 Iwaiwa Street Aiea, Hawaii 96701 Phone (808) 488-1996 Fax (808) 486-4369</p>
---	--	---	--

Reference

Service in Puerto Rico
Matsushita Electric of Puerto Rico, Inc. Panasonic Sales Company/Factory Servicenter:
Ave. 65 de Infanteria, Km. 9.5, San Gabriel Industrial Park, Carolina, Puerto Rico 00985
Phone (787) 750-4300 Fax (787) 768-2910

Limited Warranty (Only for U.S.A.)

Panasonic Consumer Electronics Company,
Division of Matsushita Electric Corporation
of America
One Panasonic Way Secaucus,
New Jersey 07094

Panasonic Sales Company, Division of Matsushita Electric
of Puerto Rico, Inc.
Ave. 65 de Infantería, Km. 9.5
San Gabriel Industrial Park, Carolina, Puerto Rico 00985

Panasonic/Technics DVD Player Limited Warranty

Panasonic Consumer Electronics Company or Panasonic Sales Company (collectively referred to as "the warrantor") will repair this product and all included accessories with new or refurbished parts, free of charge, in the USA or Puerto Rico, from the date of original purchase in the event of a defect in materials or workmanship as follows.

Parts—New or rebuilt parts in exchange for defective parts for one (1) year from the date of original purchase.

Labor—Carry-in or mail-in service for ninety (90) days from the date of original purchase. After the ninety (90) day labor period, purchaser pays for all labor charges.

Batteries—(if included) New rechargeable batteries in exchange for defective rechargeable batteries for ten (10) days from the date of the original purchase. Non-rechargeable batteries are not warranted.

Carry-in or mail-in service in the USA can be obtained during the warranty period by contacting a Panasonic Services Company (PASC) Factory Servicer listed in the Servicer Directory. Or call, toll free, 1-800-211-7262 to locate an authorized PASC Servicer. Carry-in or mail-in service in Puerto Rico can be obtained during the warranty period by calling the local telephone number in the Servicer Directory.

This warranty is extended only to the original purchaser.

A purchase receipt or other proof of date of original purchase will be required before warranty service is rendered.

This warranty only covers failures due to defects in materials and workmanship which occur during normal use and does not cover normal maintenance. The warranty does not cover damages which occurred in shipment, or failures which are caused by products not supplied by the warrantor, or failures which result from accident, misuse, abuse, neglect, mishandling, faulty installation, misapplication, improper set-up adjustments, operation or maintenance, alteration, modification, power line surge, lightning damage, interference, commercial use such as hotel, office, restaurant, or other business or rental use of the product, or serviced by anyone other than an PASC Factory Servicer or an authorized PASC Servicer, or damage that is attributable to acts of God.

LIMITS AND EXCLUSIONS

There are no express warranties except as listed above.

THE WARRANTOR SHALL NOT BE LIABLE FOR INCIDENTAL OR CONSEQUENTIAL DAMAGES RESULTING FROM THE USE OF THIS PRODUCT, OR ARISING OUT OF ANY BREACH OF THIS WARRANTY, INCLUDING WITHOUT LIMITATIONS, DAMAGE TO DISCS. ALL EXPRESS AND IMPLIED WARRANTIES, INCLUDING THE WARRANTIES OF MERCHANTABILITY, AND FITNESS FOR A PARTICULAR PURPOSE, ARE LIMITED TO THE APPLICABLE WARRANTY PERIOD SET FORTH ABOVE.

Some states do not allow the exclusion or limitation of incidental or consequential damages, or limitations on how long an implied warranty lasts, so the above exclusions or limitations may not apply to you.

This warranty gives you specific legal rights and you may also have other rights which vary from state to state.

If a problem with this product develops during or after the warranty period, you may contact your dealer or Servicer. If the problem is not handled to your satisfaction, then write to the Consumer Affairs Department at the company address indicated above.

If you ship the product

Carefully pack and send it prepaid, adequately insured and preferably in the original carton. Attach a postage-affixed letter, detailing the complaint, to the outside of the carton.

Do NOT send the product to the Executive or Regional Sales offices. They are NOT equipped to make repairs.

Customer's Record

Model No. _____	Dealer's Name _____
Serial No. _____ or _____	_____
Code No. _____	Dealer's Address _____
Date of Purchase _____	_____

DVD-RV41 DVD-RV31 [DVD-RV26] DVD-RV21

Conexión a un televisor

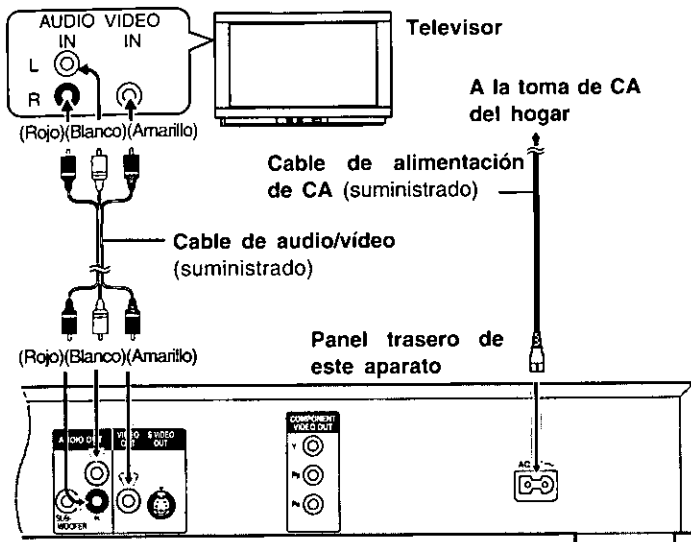

Cambio del idioma de la pantalla

Mando a distancia solamente

- 1 Pulse [POWER] para encender el aparato.
- 2 Pulse [ACTION] para visualizar los menús.
- 3 Pulse [◀, ▶] para seleccionar la lengüeta Display.
- 4 Pulse [▲, ▼] para seleccionar "Menu Language" y pulse [ENTER].
- 5 Pulse [▲, ▼] para seleccionar "Español" y pulse [ENTER].
- 6 Pulse [ACTION] para finalizar los ajustes.

Selección del tipo de pantalla del televisor

Mando a distancia solamente

- 1 Pulse [ACTION] para visualizar los menús.
- 2 Pulse [◀, ▶] para seleccionar la lengüeta Video.
- 3 Pulse [▲, ▼] para seleccionar "Pantalla de la TV" y pulse [ENTER].
- 4 Pulse [▲, ▼] para seleccionar el elemento y pulse [ENTER].
4:3 Pan&Scan (ajuste de fábrica)/4:3 Letterbox/16:9
- 5 Pulse [ACTION] para finalizar los ajustes.

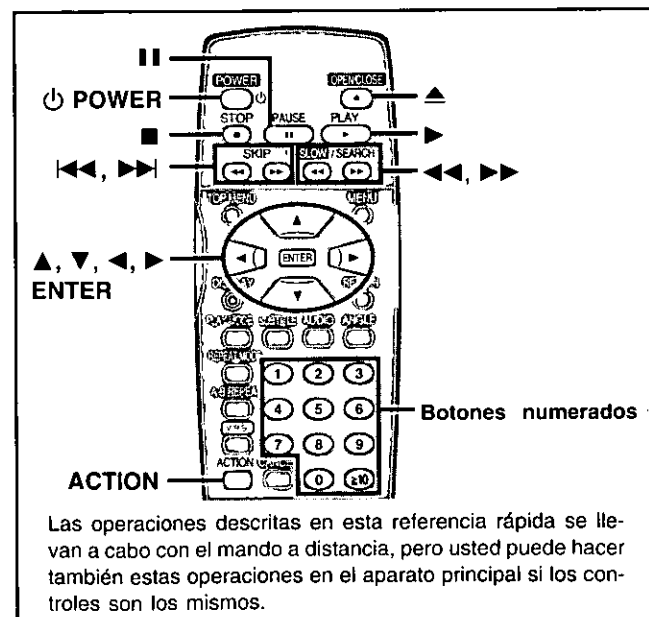

Reproducción básica

DVD VCD CD

- 1 Pulse [▶] para abrir la bandeja del disco y coloque el disco.
- 2 Pulse [▶] (reproducción).
La bandeja del disco se cierra y la reproducción empieza.

- Para detener la reproducción, pulse [■].
- Para hacer una pausa, pulse [⏸] durante la reproducción.

Cuando una pantalla de menús aparece en el televisor

DVD VCD

Mando a distancia solamente

Pulse los botones numerados para seleccionar un elemento.

Función de reanudación

Parada-reanudación

El aparato recuerda el punto donde usted detuvo la reproducción siempre que se encuentra encendido.

Espera-reanudación

Durante la reproducción, pulse [PLAY MODE] en el punto donde desee empezar de nuevo la reproducción. El aparato recuerda el punto aunque usted lo ponga en el modo de espera.

Para reanudar la reproducción

Pulse [▶] (reproducción) mientras parpadea "▷" en el visualizador del aparato.

Salto de capítulos o pistas

Durante la reproducción o durante la pausa
Pulse [◀◀] o [▶▶].

Visión cuadro a cuadro

DVD VCD

Durante la pausa
Pulse [◀] o [▶].

Avance rápido y rebobinado—SEARCH

Durante la reproducción
Pulse [◀◀] o [▶▶].

Reproducción a cámara lenta

DVD VCD

Durante la pausa
Pulse [◀◀] o [▶▶].

- Pulse [▶] (reproducción) para iniciar la reproducción.
- Durante la visión cuadro a cuadro y la reproducción a cámara lenta, con CDs de vídeo no puede retroceder.
- [◀◀], [◀], [▶], [▶▶]: Retroceso
- [▶▶], [▶], [▶▶]: Avance

Specifications

Power supply:

For U.S.A. and Canada

AC 120 V, 60 Hz

For others

AC 110–240 V, 50/60 Hz

Power consumption:

14 W

Dimensions:

430 (W)×247 (D)×82 (H) mm

[16⁵/₁₆" (W)×9³/₄" (D)×

3¹/₄" (H)]

(excluding protrusions)

Mass:

2.6 kg (5.7 lb.)

Signal system:

NTSC

Operating temperature range:

+5 to +35 °C (+41 to +95 °F)

Operating humidity range:

5–90 % RH (no condensation)

Discs played:

(1) DVD-Video disc

(2) Compact disc (CD-DA, Video CD)

(3) CD-R/CD-RW

Video output:

Output level: 1 Vp-p (75 Ω)

Output terminal: Pin jack (1 system)

S video output:

Y output level: 1 Vp-p (75 Ω)

C output level: 0.286 Vp-p (75 Ω)

Output terminal: S terminal (1 system)

Component video output:

Y output level: 1 Vp-p (75 Ω)

P_B output level: 0.7 Vp-p (75 Ω)

P_R output level: 0.7 Vp-p (75 Ω)

Output terminal: Pin jack

(Y: green, P_B: blue, P_R: red)

Audio output:

Output level: 2 Vrms (1 kHz, 0 dB,
10 kΩ load impedance)

Output terminal:

Mixed output (L/R): Pin jack (1 system)

DVD-RV41

5.1ch discrete output (5.1ch): Pin jack (1 system)

DVD-RV31 **DVD-RV26** **DVD-RV21**

Subwoofer output: Pin jack (1 system)

Audio signal output characteristics:

(1) Frequency response:

•DVD (linear audio): 4 Hz–22 kHz (48 kHz sampling)

4 Hz–44 kHz (96 kHz sampling)

•CD audio: 4 Hz–20 kHz

(2) S/N ratio:

•CD audio: 115 dB

(3) Dynamic range:

•DVD (linear audio): 102 dB

•CD audio: 98 dB

(4) Total harmonic distortion:

•CD audio: 0.0025 %

Digital audio output:

Optical digital output: Optical terminal

Pickup: Wave length: 658 nm/790 nm

Laser power: CLASS IIa/CLASS I

Power consumption in standby mode:

DVD-RV41 : approx. 2.5 W

DVD-RV31 (For U.S.A. and Canada): approx. 2 W

(For others): approx. 4 W

DVD-RV26 **DVD-RV21** : approx. 2 W

Note

Specifications are subject to change without notice.

Mass and dimensions are approximate.

Apparatus Claims of U.S. Patent Nos. 4,631,603, 4,577,216, and 4,819,098, licensed for limited viewing uses only.

This product incorporates copyright protection technology that is protected by method claims of certain U.S. patents and other intellectual property rights owned by Macrovision Corporation and other rights owners. Use of this copyright protection technology must be authorized by Macrovision Corporation, and is intended for home and other limited viewing uses only unless otherwise authorized by Macrovision Corporation. Reverse engineering or disassembly is prohibited.

Panasonic Consumer Electronics Company, Division of Matsushita

Electric Corporation of America

One Panasonic Way Secaucus,

New Jersey 07094

<http://www.panasonic.com>

Matsushita Electric Industrial Co., Ltd.

Corporate Management Division for the Americas

Sales Office for North America

Tokyo Panasonic Sales Section

32nd Floor, World Trade Center 4-1,

Hamamatsu-cho, 2-Chome, Minato-Ku,

Tokyo 105-6132, Japan

Panasonic Sales Company, Division of Matsushita Electric

of Puerto Rico, Inc. ("PSC")

Ave. 65 de Infantería, Km. 9.5

San Gabriel Industrial Park,

Carolina,

Puerto Rico 00985

Panasonic Marketing Europe

G.M.B.H. Wiesbaden N. (a Division

of Panasonic Marketing G.M.B.H.)

Military Sales Department

6200 Wiesbaden-Biebrich,

Hagenauerstr. 43

Germany

Panasonic Canada Inc.

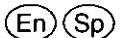

5770 Ambler Drive

Mississauga, Ontario

L4W 2T3

www.panasonic.ca