



Panasonic®

TV/DVD Combination Operating Instructions

Models No. **PV-20D52/PV-25D52/PV-D27D52**



• Initial Setup and Connection Procedures are on pages 10 to 15.



As an ENERGY STAR Partner, Matsushita Electric Corporation of America has determined that this product or product model meets the ENERGY STAR guidelines for energy efficiency.

Please read these instructions carefully before attempting to connect, operate, or adjust this product. Please save this manual. Spanish Quick Use Guide is included. (Guía para rápida consulta en español está incluida.)

For assistance, please call : 1-800-211-PANA(7262) or send e-mail : consumerproducts@panasonic.com

Initial Setup

Basic Operation

TV Operation

Advanced Operation

For Your Information

LSQT0592A

Important Safeguards and Precautions

READ AND RETAIN ALL SAFETY AND OPERATING INSTRUCTIONS. HEED ALL WARNINGS IN THE MANUAL AND ON UNIT

INSTALLATION

1 POWER SOURCE CAUTION

Operate only from power source indicated on unit or in this manual. If uncertain, have your Electric Utility Service Company or Video Products Dealer verify your home power source.

2 POWER CORD PLUG

For safety, this unit has a polarized type plug (one wide blade), or a three-wire grounding type plug. Always hold the plug firmly and make sure your hands are dry when plugging in or unplugging the AC power cord. Regularly remove dust, dirt, etc. on the plug.

POLARIZED PLUG CAUTION:

The plug fits into outlet only one way. If it cannot be fully inserted, try reversing it. If it still will not fit, have an electrician install the proper wall outlet. Do not tamper with the plug.

GROUNDING PLUG CAUTION:

The plug requires a three-hole grounding outlet. If necessary, have an electrician install the proper outlet. Do not tamper with the plug.

3 POWER CORD

To avoid unit malfunction, and to protect against electrical shock, fire or personal injury:

- Keep power cord away from heating appliances and walking traffic. Do not rest heavy objects on, or roll such objects over the power cord.
- Do not tamper with the cord in any way.
- An extension cord should have the same type plug (polarized or grounding) and must be securely connected.
- Overloaded wall outlets or extension cords are fire hazards.

- Frayed cords, damaged plugs, and damaged or cracked wire insulation are hazardous and should be replaced by a qualified electrician.

4 DO NOT BLOCK VENTILATION HOLES

Ventilation openings in the cabinet release heat generated during operation. If blocked, heat build-up may result in a fire hazard or heat damage to discs.

For your protection:

- Never cover ventilation slots while unit is ON, or operate unit while placed on a bed, sofa, rug, or other soft surface.
- Avoid built-in installation, such as a book case or rack, unless properly ventilated.

5 AVOID EXTREMELY HOT LOCATIONS OR SUDDEN TEMPERATURE CHANGES

Do not place unit over or near a heater or radiator, in direct sunlight, inside closed vehicles, in high temperature [over 95 °F (35 °C)], or in over 75% humidity. If unit is suddenly moved from a cold place to a warm one, moisture may condense in unit and on the tape causing damage. Never subject unit to vibration, impact, or place it so that the surface is tilted as internal parts may be seriously damaged.

6 TO AVOID PERSONAL INJURY

- Never place unit on support or stand that is not firm, level, and adequately strong. The unit could fall causing serious injury to a child or adult and damage to the unit.
- Move any appliance and cart combination with care. Quick stops, excessive force, and uneven surfaces may cause objects to overturn.
- Carefully follow all operating instructions.



OUTDOOR ANTENNA INSTALLATION

1 SAFE ANTENNA AND CABLE CONNECTION

An outside antenna or cable system must be properly grounded to provide some protection against built up static charges and voltage. Section 810

of the National Electrical Code, ANSI/NFPA 70 (in Canada, part 1 of the Canadian Electrical Code) provides information

regarding proper grounding of the mast and supporting structure, grounding of the lead-in wire to an antenna discharge unit, size of grounding conductors, location of antenna discharge unit, connection to grounding electrodes, and requirements for the grounding electrode.

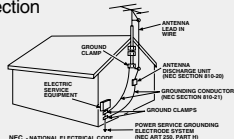

2 KEEP ANTENNA CLEAR OF HIGH VOLTAGE POWER LINES OR CIRCUITS

Locate an outside antenna system well away from power lines and electric light or power circuits so it will never touch these power sources should it ever fall. When installing antenna, absolutely never touch power lines, circuits or other power sources as this could be fatal.

USING THE UNIT

Before unit is brought out of storage or moved to a new location, refer again to the INSTALLATION section of these safeguards.

1 KEEP UNIT WELL AWAY FROM WATER OR MOISTURE

such as vases, sinks, tubs, etc.

2 IF EXPOSED TO RAIN, MOISTURE, OR STRONG IMPACT

unplug unit and have it inspected by a qualified service technician before use.

3 ELECTRICAL STORMS

During a lightning storm, or before leaving unit unused for extended periods of time, disconnect all equipment from the power source as well as the antenna and cable system.

4 WHEN UNIT IS PLUGGED IN

• DO NOT OPERATE IF:

- liquid has spilled into unit.
- unit was dropped or otherwise damaged.
- unit emits smoke, odours, or noises.

Immediately unplug unit, and have it inspected by a service technician to avoid potential fire and shock hazards.

- Never drop or push any object through openings in unit. Touching internal parts may cause electric shock or fire hazard. Do not put any foreign object on the tray.
- Keep magnetic objects, such as speakers, away from unit to avoid electrical interference.

5 USING ACCESSORIES

Use only accessories recommended by the manufacturer to avoid risk of fire, shock, or other hazards.

6 CLEANING UNIT

Unplug unit. Use a clean, dry, chemically untreated cloth to gently remove dust or debris. DO NOT USE cleaning fluids, aerosols, or forced air that could over-spray, or seep into unit and cause electrical shock. Any substance, such as wax, adhesive tape, etc. may mar the cabinet surface. Exposure to greasy, humid, or dusty areas may adversely affect internal parts.

SERVICE

1 DO NOT SERVICE PRODUCT YOURSELF

If, after carefully following detailed operating instructions, the unit does not operate properly, do not attempt to open or remove covers, or make any adjustments not described in the manual. Unplug unit and contact a qualified service technician.

2 REPLACEMENT OF PARTS

Make sure the service technician uses only parts specified by the manufacturer, or have equal safety characteristics as original parts. The use of unauthorized substitutes may result in fire, electric shock, or other hazards.

3 SAFETY CHECK AFTER SERVICING

After unit is serviced or repaired, request that a thorough safety check be done as described in the manufacturer's service literature to ensure video unit is in safe operating condition.

Safety Precautions/Mesures de sécurité

Warning : To prevent fire or shock hazard, do not expose this equipment to rain or moisture.

Caution : To prevent electric shock, match wide blade of plug to wide slot, fully insert.

Avertissement : Afin de prévenir tout risque d'incendie ou de chocs électriques, ne pas exposer cet appareil à la pluie ou à une humidité excessive.

Attention : Pour éviter les chocs électriques, introduire la lame la plus large de la fiche dans la borne correspondante de la prise et pousser jusqu'au fond.

FCC WARNING : Any unauthorized changes or modifications to this equipment would void the user's authority to operate.

This television receiver provides display of television closed captioning.

CAUTION:

UNIT IS A CLASS I LASER PRODUCT. HOWEVER THIS UNIT USES A VISIBLE LASER BEAM WHICH COULD CAUSE HAZARDOUS RADIATION EXPOSURE IF DIRECTED. BE SURE TO OPERATE THE UNIT CORRECTLY AS INSTRUCTED.

WHEN THIS UNIT IS PLUGGED TO THE WALL OUTLET, DO NOT PLACE YOUR EYES CLOSE TO THE OPENING OF THE DISC TRAY AND OTHER OPENINGS TO LOOK INTO THE INSIDE OF THIS UNIT. USE OF CONTROLS OR ADJUSTMENTS OR PERFORMANCE OF PROCEDURES OTHER THAN THOSE SPECIFIED HEREIN MAY RESULT IN HAZARDOUS RADIATION EXPOSURE.

DO NOT OPEN COVERS AND DO NOT ATTEMPT TO REPAIR THE UNIT YOURSELF. REFER SERVICING TO QUALIFIED PERSONNEL.

CAUTION:

LASER RADIATION WHEN OPEN. DO NOT STARE INTO BEAM.

ATTENTION:

RAYONNEMENT LASER EN CAS D'OUVERTURE. NE PAS REGARDER DANS LE FAISCEAU.

(Inside of product)

FCC NOTICE:

This equipment has been tested and found to comply with part 15 of the FCC Rules. These limits are designed to provide reasonable protection against harmful interference when operated in a residential environment. If this equipment does cause interference to radio or television reception, which can be determined by turning the equipment off and on, use the equipment in another location and/or utilize an electrical outlet different from that used by the receiver. If necessary, consult the dealer or an experienced radio/TV technician for help. You may find the booklet, 'Something About Interference' available from FCC local regional offices helpful.

This product utilizes both a Cathode Ray Tube (CRT) and other components that contain lead. Disposal of these materials may be regulated in your community due to environmental considerations. For disposal or recycling information please contact your local authorities, or the Electronics Industries Alliance: <<http://www.eiae.org>>



This symbol warns the user that uninsulated voltage within the unit may have sufficient magnitude to cause electric shock. Therefore, it is dangerous to make any kind of contact with any inside part of this unit.

This symbol alerts the user that important literature concerning the operation and maintenance of this unit has been included. Therefore, it should be read carefully in order to avoid any problems.

Region Management Information

Region Management Information: This unit is designed and manufactured to respond to the Region Management Information that is recorded on a DVD disc. If the Region number described on the DVD disc does not correspond to the Region number of this unit, this unit cannot play this disc.

The Region number for this unit is 1.



Before Using

Congratulations

on your purchase of one of the most sophisticated and reliable products on the market today. Used properly, it will bring you and your family years of enjoyment. Please fill in the information below. The serial number is on the tag located on the back of your unit.

Date of Purchase _____
Dealer Purchased From _____
Dealer Address _____
Dealer Phone No. _____
Model No. _____
Serial No. _____

Accessories

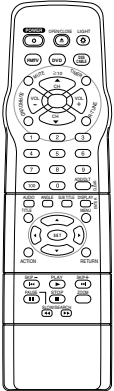

Remote Control
LSSQ0346

Batteries 2 "AA"

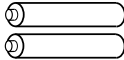

**To order accessories,
call toll free
1-800-332-5368.**

Loading the Batteries

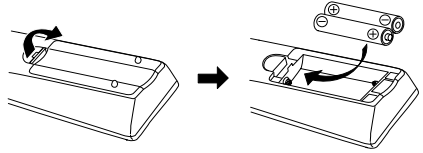

Battery replacement caution

- Do not mix old and new batteries.
- Do not mix alkaline with manganese batteries.

Apparatus Claims of U.S. Patent Nos.
4,631,603, 4,577,216, and 4,819,098,
licensed for limited viewing uses only.

This product incorporates copyright protection technology that is protected by method claims of certain U.S. Patents and other intellectual property rights owned by Macrovision Corporation and other rights owners. Use of this copyright protection technology must be authorized by Macrovision Corporation, and is intended for home and other limited viewing uses only unless otherwise authorized by Macrovision Corporation. Reverse engineering or disassembly is prohibited.

Table of Contents

Initial Setup

TV

Important Safeguards and Precautions / Safety Precautions	2 ~ 3
Before Using	4
Information (Unit, Disc)	6, 7
Location of Controls	8, 9
Connections / Initial Setup	10, 11
Reset Language, Channels, Clock, Time Zone Adjust	12, 13
Audio Connections	14, 15

Initial Setup

DVD Operation

DVD

Basic DVD Operation	16, 17
---------------------------	--------

DVD Operation

TV Operation

TV

TV Operation	18
MTS Broadcast / TV Stereo System	19
Closed Caption System	20, 21
TV Timer Features	22
On-Screen Display (OSD)	23
FM Radio	24, 25

TV Operation

Advanced Operation

TV

Cable Box Universal Remote Control Feature	26, 27
Special Features	28, 29
V-Chip Control Feature	30 ~ 33
Video / Audio Menu	34
Video / Audio Adjustment	35

DVD

Disc Operation	36 ~ 40
DVD Operation using On-Screen Displays	41 ~ 43
MP3 Playback Operation	44
DVD Lock Feature	45
Settings for DVD Operation	46 ~ 48
Language Code List	49

Advanced Operation

For Your Information

TV

Before Requesting Service	50, 51
Warning and Instruction Displays	51
Limited Warranty	52, 53
Customer Services Directory	53
Spanish Quick Use Guide / Guía para rápida consulta	54 ~ 61
Index	62, 63

For Your Information

Information (Unit, Disc)

Specifications

Display

Picture Tube: 20 inch measured diagonal 90° Picture Tube (PV-20D52)
25 inch measured diagonal 110° Picture Tube (PV-25D52)
27 inch measured diagonal 100° Picture Tube (PV-27D52)

Tuner

Broadcast Channels: VHF 2 ~ 13, UHF 14 ~ 69
CABLE Channels: Midband A through I (14 ~ 22)
Superband J through W (23 ~ 36)
Hyperband AA ~ EEE (37 ~ 64)
Lowband A-5 ~ A-1 (95 ~ 99)
Special CABLE channel 5A (01)
Ultraband 65 ~ 94, 100 ~ 125

FM Radio

Band range: 87.5 ~ 108.1 MHz

General

Power Source: 120V AC, 60 Hz
Power Consumption: Power On
Approx. 122 watts (PV-20D52)
Approx. 150 watts (PV-25D52)
Approx. 161 watts (PV-27D52)
Power Off
Approx. 3.5 watts

Television System: EIA Standard NTSC color

Speaker: 2 pieces (5.0W x 2)

Operating Temperature: 5 °C ~ 35 °C (41 °F ~ 95 °F)

Operating Humidity: 10% ~ 75%

Weight: 23 kg (50.6 lbs.) (PV-20D52)

32 kg (70.4 lbs.) (PV-25D52)

39 kg (85.8 lbs.) (PV-27D52)

Dimensions:

515 (W) x 505 (H) x 474 (D) mm

20-5/16" (W) x 19-7/8" (H) x 18-11/16" (D) (PV-20D52)

634 (W) x 590 (H) x 464 (D) mm

24-15/16" (W) x 23-1/4" (H) x 18-1/4" (D) (PV-25D52)

688 (W) x 653 (H) x 550 (D) mm

27-1/16" (W) x 25-11/16" (H) x 21-11/16" (D) (PV-27D52)

Discs played

(1) DVD-VIDEO disc 5" (12 cm) single-sided, single-layer
5" (12 cm) single-sided, double-layer
5" (12 cm) double-sided, double-layer
(one layer per side)

3" (8 cm) single-sided, single-layer

3" (8 cm) single-sided, double-layer

3" (8 cm) double-sided, double-layer
(one layer per side)

(2) Compact disc
(CD-DA, VIDEO CD) 5" (12 cm) disc
3" (8 cm) disc

Digital audio output:

Optical digital output:

Optical connector

Pickup:

Wavelength: 655 nm (DVD), 790 nm (Video CD/CD)

Laser power: CLASS II

Note : Designs and specifications are subject to change without notice.

If the disc cannot be removed...

First, unplug unit.

Then, prepare a rigid wire (e.g. an extended paper clip) and, applying moderate force, insert it straight into the hole at the base of the tray. The tray will eject a little.

Then, pull the tray all the way out and remove the disc.

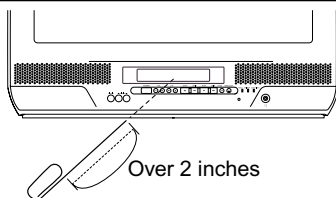

Disc formats supported by this unit

The unit can play back discs bearing any of the following marks:



DVD

3" (8 cm) disc / 5" (12 cm) disc



Video CD

3" (8 cm) disc / 5" (12 cm) disc



CD

3" (8 cm) disc / 5" (12 cm) disc

Discs which cannot be played with this unit

- DVD with Region No. other than "1" or "ALL"
- DVD of PAL system
- DVD-ROM
 - DVD-R/DVD-RAM
- DVD-R/DVD-RAM
 - CD-ROM
- CDV
 - CD-G
- **Do not try to play a Photo CD.**



is a registered trademark.

Definition of Terms

Angle

Some DVD discs feature scenes simultaneously shot from different angles. The ANGLE button can be used to view the scene from different angles. (ANGLE Indicator lights up on the unit when a scene recorded at different angles is detected.)

Chapter Number

Titles are subdivided into numbered sections. You can quickly search for a favorite scene using these numbers.

DVD

A high-density optical disc on which high-quality pictures and sound have been digitally recorded. DVD incorporates new video compression technology (MPEG II) and high-density recording technology which allow entire movies to be recorded with incredible playback quality.

Playback Control

With Video CD (version 2.0), scenes or information may be selected for viewing or listening from an interactive menu that appears on the TV screen.

Subtitles

Written dialogue which appears at the bottom of the screen.

Time Number

The elapsed play time from the start of a disc or title. Use to quickly find scenes. (May not work with some discs.)

Title Number

For DVD discs with two or more titles, the title is numbered as title 1, title 2, etc.

Track Number

Numbers assigned to tracks on Video CDs and CDs to allow specific tracks to be quickly located.

Video CD

CD containing picture and sound with same quality level as video tape. This unit also supports Video CDs with playback control (version 2.0).

Disc Handling

Handling precautions

- Only hold disc by edges as shown. Fingerprints, dirt, and scratches can cause skipping and distortion.
- Do not write on label side of disc.
- Never use record cleaning sprays, benzene, thinner, static electricity prevention liquids, or any other solvent.
- Be careful not to drop or bend disc.
- Do not place more than 1 disc on disc tray.
- Do not try to close disc tray when disc is not properly placed.
- Always store discs in their proper cases when not in use.

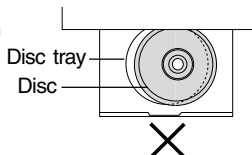
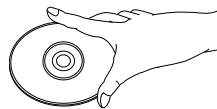

To clean disc surface

With a soft, damp (water only) cloth, gently wipe from the center hole to the outer edge as shown below. (Wiping in a circular pattern will scratch the surface.)

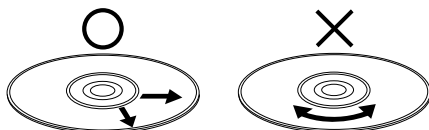

If disc is brought from a cold to a warm environment, moisture may form on the disc

Wipe away moisture with a soft, dry, lint-free cloth before using disc. (See above.)

Improper disc storage

- Discs could be damaged if stored or left in areas:
- exposed to direct sunlight.
 - that are humid or dusty.
 - near heat (i.e. heater, radiator, etc.).

Location of Controls

Remote Control Buttons (Light Tower™ Illuminated Remote Control)

OPEN/CLOSE

Opens or closes the disc tray.

POWER

Turns the unit on or off.

FM/TV

Sets to TV mode.
Receives FM radio signal.

MUTE

Mutes the sound instantly.

CHANNEL UP/DOWN

Selects a channel.

SURROUND

Creates a deeper, 3-D sound effect.

NUMBER Keys

Selects a channel directly.

ANGLE

Selects the desired angle
in DVD mode.

AUDIO

Selects the desired audio mode.

TITLE

Selects the desired title by number
on some DVDs.

SELECT

Controls navigation around
on-screen menu.

ACTION

Displays Main Menu.

SET

Sets a selected menu.

SKIP I

Skips back one chapter or track.
Goes to previous menu screen.

PAUSE

Pauses picture in Play mode and
frame advance picture in Still mode.

PLAY

Begins playback.

DVD

Sets to DVD mode.

LIGHT

See below.

DSS/CABLE

Sets the remote to control some
basic DDS or Cable box functions.

TIMER

Sets ON TIMER or SLEEP TIMER.

VOLUME UP/DOWN

Adjusts volume.

RAPID TUNE

Displays the last channel
you were watching.

ADD/DELETE/CLEAR

Adds or deletes a channel.
Cancels an item on the screen.

SUB TITLE

Selects a different subtitle language.

DISPLAY/ENTER

Displays the TV status and clock.
In DVD mode, displays disc and
unit information.
In DSS or CABLE mode, it may be
necessary after channel selection.

MENU

Displays DVD menu.

RETURN

Returns to Menu screen.

SKIP ►►►

Skips one chapter or track.
Goes to next menu screen.

ZOOM

Enlarges specific portions of picture.

STOP

Stops playback.

SLOW/SEARCH

Slow motion picture in Still mode.
Forward/Reverse rapid scene
search in Play mode.

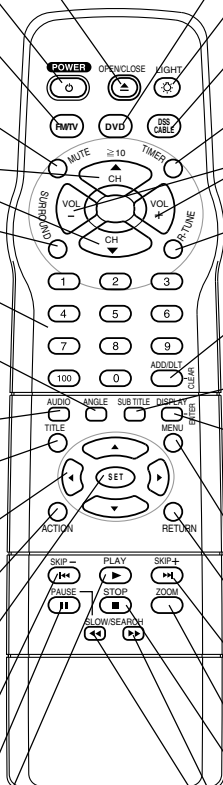

Note

- When **LIGHT** is pressed, (FM/TV, DVD, DSS/CABLE, CH UP/DOWN, VOL+/-) buttons will light for 5 seconds for easy location. If no button is pressed in 5 seconds the light goes out to conserve the battery.

Front View of the Unit and Indicators

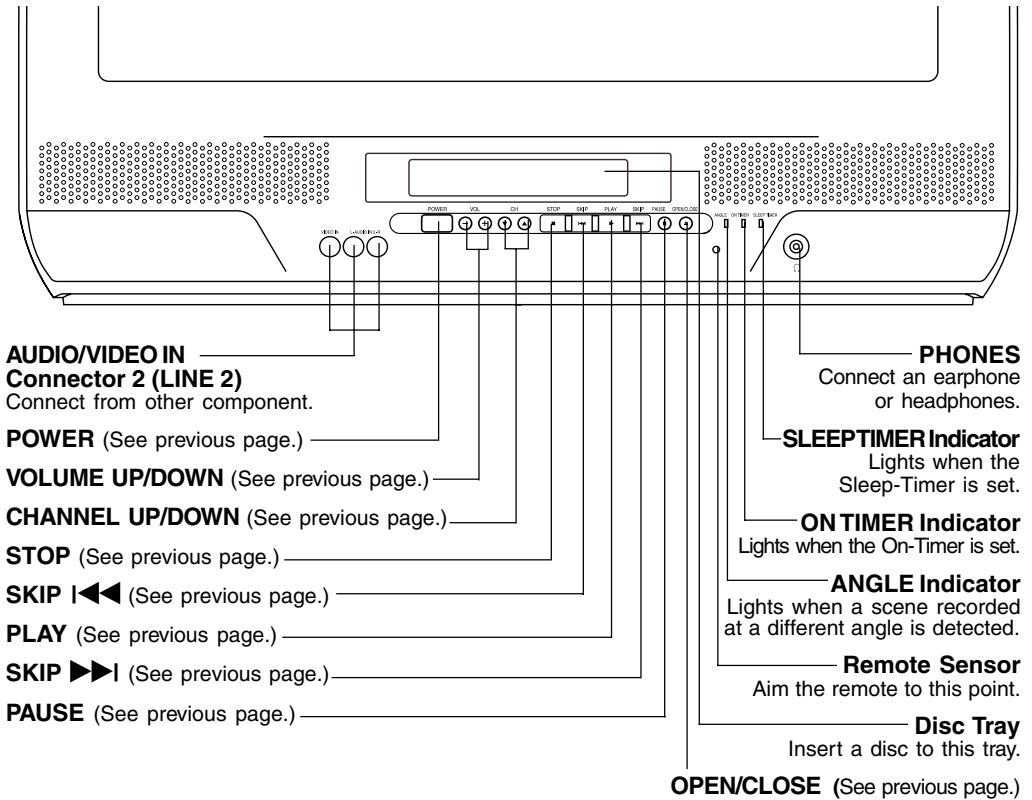

Rear View of the unit

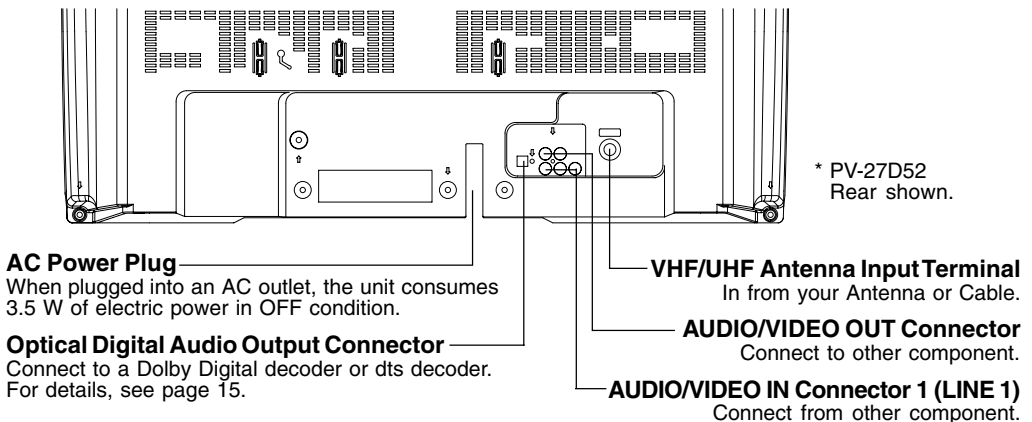

Initial Setup (Ready to Play)

Please make all cable or antenna connections before powering on.

Connecting

For ANT./Cable
Connect the cable from Antenna/Cable to the VHF/UHF terminal on the unit.

For DSS/Cable Box
Connect the OUT jack on your cable box to the VHF/UHF terminal on the unit with a RF cable.

WARNING:
Overtightening "Nut type" RF coaxial cables may damage jacks. Finger tighten only.

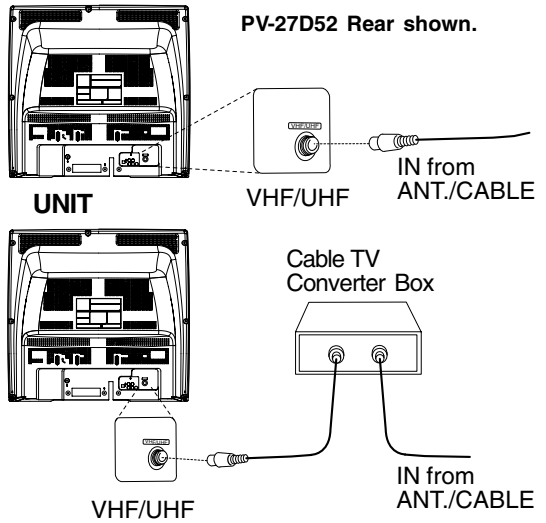

Initial Setup (Ready to Play)

- 1 Plug the unit power cord into an AC wall outlet.
- 2 Press POWER* on the remote or unit. The unit comes on and auto channel and clock set starts.

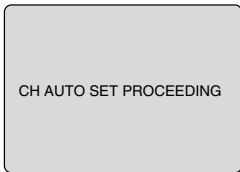

- If you use a cable box, turn it on and set it to the Public Broadcasting Service (PBS) channel in your time zone. If you use a DSS receiver, it must be turned off.

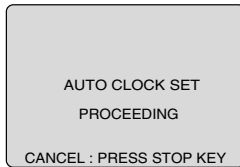

- 3 Settings are made automatically. When setup is done, this screen appears.

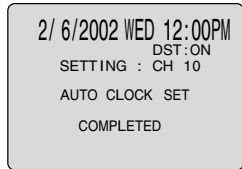

If AUTO CLOCK SET IS INCOMPLETE screen appears, set the clock using MANUAL CLOCK SET procedure on next page.

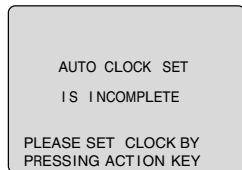

*Important: If a remote control button does not work when pressed, press the FM/TV button on the remote and try the button again.

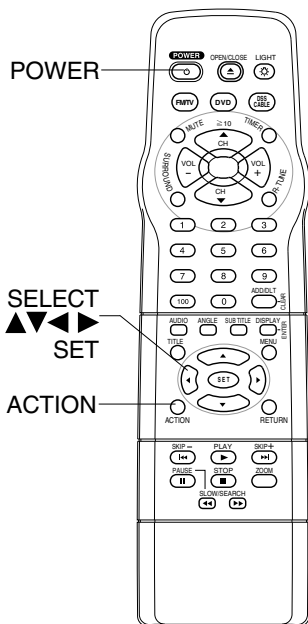

Manual Clock Set

If AUTO CLOCK SET was incomplete, manually set the clock as follows.

1 Press **ACTION** on the Remote to display SET CLOCK Menu screen.

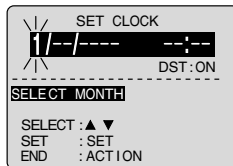

2 Press **▲▼** to select the month and press **SET** to set. In the same manner, select and set the date, year, time, and DST.



3 Press **ACTION** twice to start CLOCK and exit.

DST (Daylight Saving Time)

Unit auto adjusts clock for DST (Daylight Saving Time.)

- **Spring (First Sunday in April)**
DST : ON ->Sets clock ahead one hour.
 - **Autumn (Last Sunday in October)**
DST : ON ->Turns clock back one hour.
- If your area does not observe Daylight Saving Time, select DST:OFF.

Note to CABLE System Installer

This reminder is provided to call the CABLE (Cable TV) System Installers attention to Article 820-40 of the NEC that provides guidelines for proper grounding and, in particular, specifies that the cable ground shall be connected to the grounding system of the building, as close to the point of cable entry as practical.

Reset all unit Memory Functions

When moving unit to a new location, or if a mistake was made in the Initial Setup section.

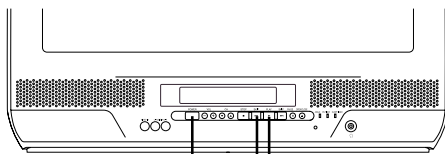

- 1** Turn the unit Power on.
- 2** Press and hold both **PLAY** and **||◀◀** on the unit for more than 5 seconds.
 - The power will shut off.
- 3** Perform "Initial Setup" on page 10.

Reset Language, Channels, Clock,

1

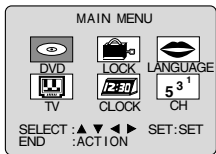

Press **ACTION***
to display MAIN MENU.

2 Language

- 1) Press ▲▼◀▶ to select language icon.

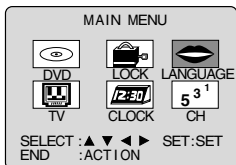

- 2) Press SET repeatedly.

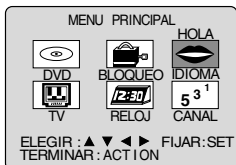

For Spanish

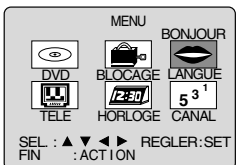

For French

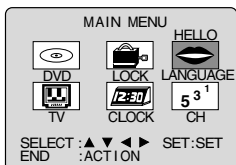

For English

- 3) Press ACTION to exit.

Channels

- 1) Press ▲▼◀▶ to select "CH."

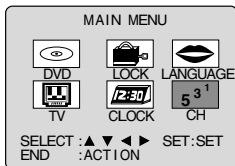

- 2) Press SET.

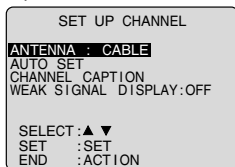

- 3) Press ▲▼ to select "ANTENNA," then press SET to set your antenna system ("TV" or "CABLE").

- 4) Press ▲▼ to select "AUTO SET," then press SET.

- After Channel Auto Set is finished, Clock Auto Set will be performed. (If clock is set manually, Clock Auto Set will not be performed.)

Clock

- 1) Press ▲▼◀▶ to select "CLOCK."

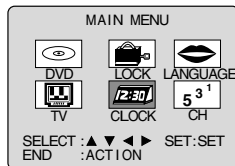

- 2) Press SET.

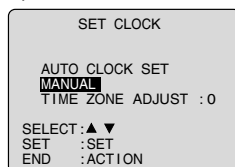

("TIME ZONE ADJUST" appears only when auto clock is set.)

- 3) Press ▲▼ to select "MANUAL," then press SET. (For Auto Clock Set, select "AUTO CLOCK SET," and press SET.)

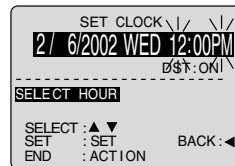

<Example >

- 4) Press ▲▼ and press SET to select and set the month, date, year, time, and DST (Daylight Saving Time).

To Make Corrections, repeatedly press ◀▶ to move to error, then correct.

- 5) Press ACTION twice to start the clock and exit this mode.

Time Zone Adjust

***Important:**

If a remote control button does not work when pressed, press the FM/TV button on the remote and try the button again.

Time Zone Adjust

(Only when Auto Clock is set.)

- 1) Press **▲▼◀▶** to select "CLOCK."

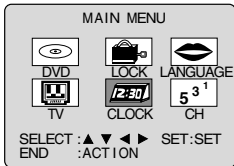

- 2) Press **SET**.

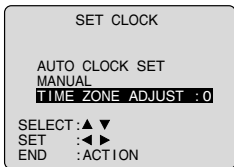

- 3) Press **▲▼** to select "TIME_ZONE_ADJUST" and press **◀** or **▶** to subtract or add hour(s) as necessary.

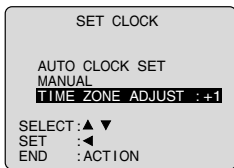

- 4) Press **ACTION** twice to exit.

- "TIME_ZONE_ADJUST" returns to "0" if clock is set manually.

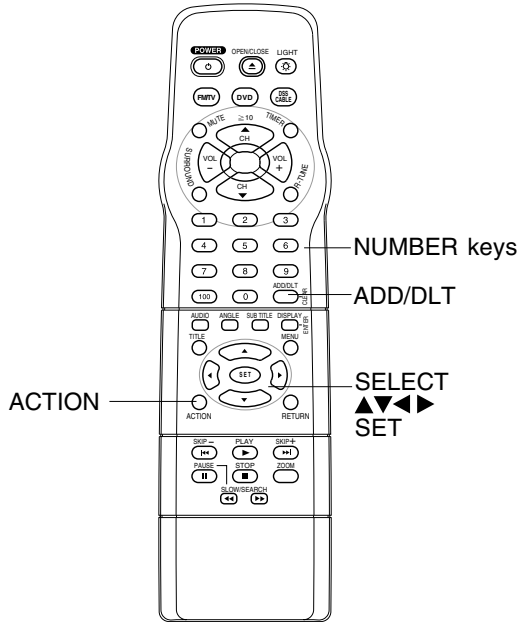

Add or Delete a Channel

To add channel:
Select channel with
number keys and
press **ADD/DLT**.

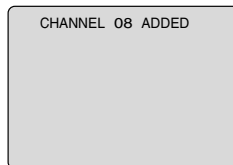

To delete channel:
Select channel with
CH ▲▼ or **number keys**
and press **ADD/DLT**.

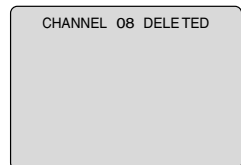

Audio Connections

Unit → Amplifier → Speaker

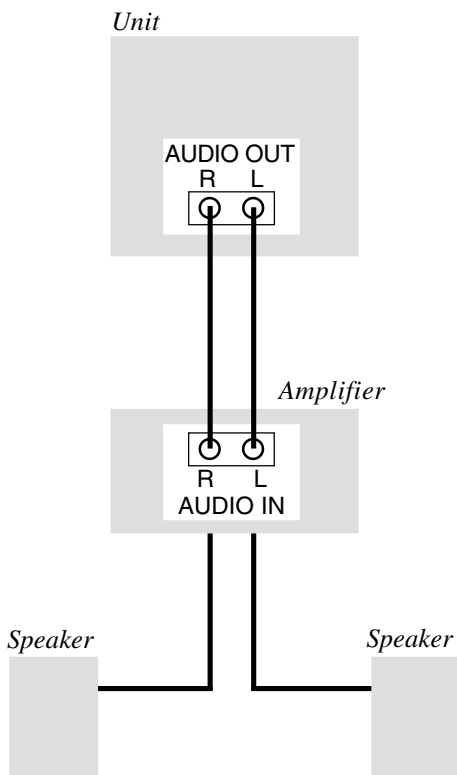

✓ Ready Checklist

- Turn down the volume, then turn this unit, as well as other equipment to be connected, off before proceeding with connection.
- Do not block ventilation holes of any of the equipment and arrange them so that air can circulate freely.
- Read through the instructions before connecting other equipment.
- Ensure that you observe the color coding when connecting audio and video cables.

Enjoying digital audio output from the digital audio output connector

Notes on audio output from the optical digital audio output connector

Disc	Sound recording format	Optical digital audio output from connector
DVD	Dolby Digital	Dolby Digital bitstream (1-5.1 ch) or OFF (no output)* ¹
	Linear PCM (48/96 kHz 16/20/24 bit)	Linear PCM (2ch) (48 kHz sampling/16 bit only)* ² or no output* ¹
	dts	Bitstream or no output* ¹
Video CD	MPEG 1	PCM (44.1 kHz sampling)
CD	Linear PCM	Linear PCM (44.1 kHz sampling)
MP3	MP3	Linear PCM (It depends on the MP3 file)

*1 The type of audio output from the connector can be selected by the Settings for DVD Operation. (See page 47.)

*2 Sound having 96 kHz sampling is converted into 48 kHz sampling when it is output from the unit's optical digital audio output connector.

For your reference:

- Dolby Digital is a digital sound compression technique developed by the Dolby Laboratories Licensing Corporation. Supporting 5.1-channel surround sound, as well as stereo (2-channel) sound, this technique enables a large quantity of sound data to be efficiently recorded on a disc.
- Linear PCM is a signal recording format used in CDs. While CDs are recorded in 44.1 kHz/16 bit, DVDs are recorded in 48 kHz/16 bit up to 96 kHz/24 bit.
- If you have a Dolby Pro Logic Surround decoder, you will obtain the full benefit of Pro Logic from the same DVD movies that provide full 5.1 channel Dolby Digital soundtracks, as well as from titles with the Dolby Surround mark. For information on Panasonic or Technics Dolby Pro Logic Surround Sound Decoders please contact your local dealer.

Manufactured under license from Dolby Laboratories. "Dolby", "Pro Logic" and the double-D symbol are trademarks of Dolby Laboratories. Confidential Unpublished Works. © 1992-1997 Dolby Laboratories, Inc. All rights reserved.

■ Unit → Dolby Digital Decoder → Amplifier → Speaker
or

Unit → dts (digital theater systems) Decoder → Amplifier → Speaker

When DVDs recorded in Dolby Digital or dts are played, Dolby Digital bitstream or dts bitstream is output from the unit Optical digital audio output connector. When the unit is connected to a Dolby Digital decoder or dts decoder, you can enjoy theater-quality audio in your home. [An optical digital audio cable (optional) is required when an optional Dolby Digital decoder or dts decoder is used.]

Notes on connecting an Optical digital audio cable (optional)

- Firmly connect the cable to the connector.

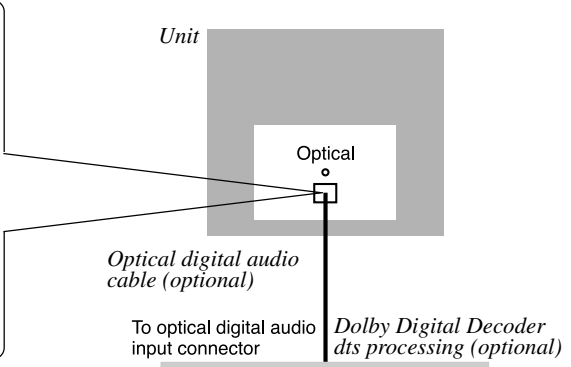
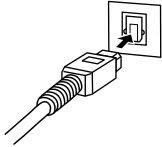

IMPORTANT NOTE:
Caution for optical digital audio output connector:

- When connecting an amplifier (with an Optical digital input connector) which does not contain the Dolby Digital or dts decoder, be sure to select "OFF" at "Dolby Digital" and "OFF" at "dts" of the Settings for DVD Operation "AUDIO OUTPUT" (see page 47). Otherwise, any attempt to play DVDs may cause such a high level of noise that it may be harmful to your ears and damage your speakers.
- When a dts decoder is connected, please select "Bitstream" at "dts" of the Settings for DVD Operation "AUDIO OUTPUT". If "OFF" is selected, there will be no sound. (See page 47).
- Video CDs and CDs can be played as normal.

Note:

- Some dts decoders which do not support DVD-dts Interface may not work properly with the unit.

Basic DVD Operation

✓ Ready Checklist

- All connections are made.
- Your unit is plugged in.
- If unit is connected to an audio amplifier, turn the stereo system's power on.

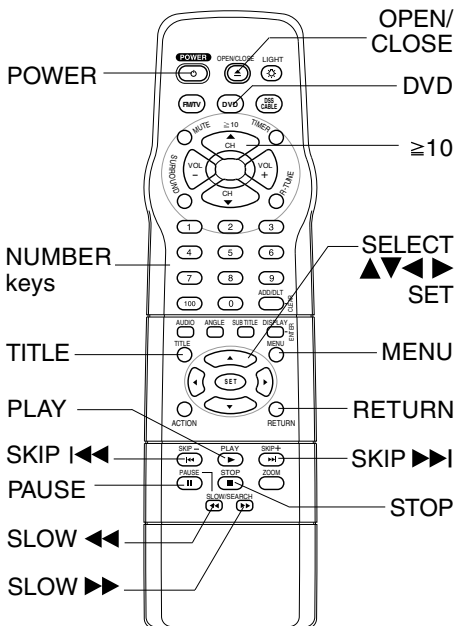

1 Press POWER* on the remote or unit.

2 Insert a disc.

- If a disc is already inserted, go to step 3. (Depending on the disc, playback may start automatically.)

- 1) Press OPEN/CLOSE.
- 2) Place disc into disc tray.

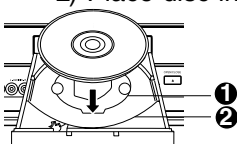

- Hold disc by its edges only (page 7) with printed side up and use guides to place into tray. Use ① 3" (8 cm) or ② 5" (12 cm) disc.

3 Press PLAY to start play.

Disc tray closes automatically.

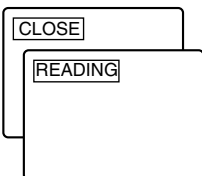

- You may also close the tray by pressing OPEN/CLOSE.
- Data reading time differs with each disc.

<Example>

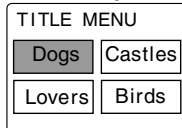

If an interactive DVD*1 or a Video CD with playback control*2 is used and a TITLE MENU appears, go to step 5.

4

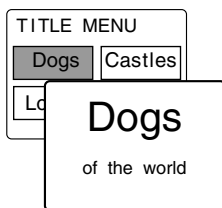

Press ▲▼◀▶ or number key(s) (see below) to select title and press SET to play. Using number key(s) starts play automatically.

<Example>

<Example> 1 digit number 1...1
 2 digit number 12...≥10>1>2
 3 digit number 123...100>1>2>3

Press SKIP ▶▶ or ◀◀ to go to next or previous menu screen.

- SKIP function not available with all discs.
- Please refer to disc jacket for operation information.

To return to MENU (play stops)
 Press TITLE, MENU, or RETURN. (DVD)
 Press RETURN. (Video CD)

5 Press STOP to stop play.

6 Press OPEN/CLOSE to eject the disc.

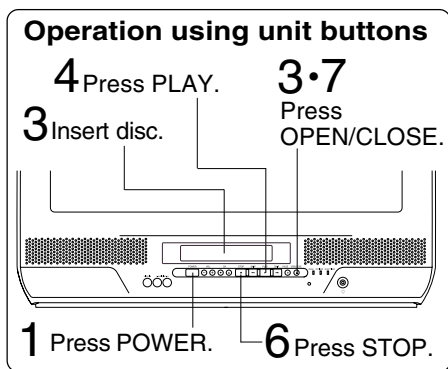

*1 Interactive DVD...

May include multiple camera angles, stories, etc.

*2 Video CD with playback control...

Particular scenes or information can be interactively selected from a menu that appears on the screen.

*Important: If a remote control button does not work when pressed, press the DVD button on the remote and try the button again.

■ Forward/Reverse rapid scene search

→ Press **SLOW** ►► or **SLOW** ◀◀ during play.

→ Press **PLAY** to release.

- Starting forward/reverse search during play started from menu on Video CDs may recall menu.
- Search speed, slow at first, increases with each additional press of the button up to 5 levels.

■ Forward/Reverse Chapter/Track Skip

→ Press **SKIP** ►►| or |◀◀ during play.

Each press skips a chapter (DVD) or track (Video CD/CD).

Pressing |◀◀ **SKIP** once midway through a chapter/track returns to start of that chapter/track. Each additional press skips back one chapter/track.

- Pressing **SKIP** ►►| or |◀◀ during play started from menu on Video CDs may recall menu.

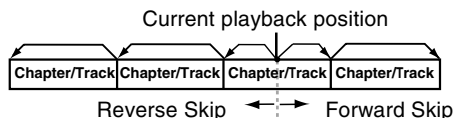

■ Still (Pause) Picture

→ Press **PAUSE** during play.

→ Press **PLAY** to release.

- **DVD/Video CD** : The unit will enter Still picture mode.
- **CD** : The unit will enter Pause mode.

■ Frame by Frame picture (DVD/Video CD)

→ Press **PAUSE** in Still mode.

→ Press **PLAY** to release.

- Each press advances picture one frame.
- Hold down for consecutive frame advance.
- Whether pictures are advanced by "FRAME" or "FIELD" is selected automatically (see page 48).

■ Slow Motion picture (DVD/Video CD)

→ Press **SLOW** ►► or **SLOW** ◀◀ in Still mode.

→ Press **PLAY** to release.

- Slow motion speed, slow at first, is increased with each additional press of the button up to 5 levels.
- Reverse slow motion is not available for video CDs.

- When Ⓞ appears on the screen while a button is being operated, it means that the corresponding operation is prohibited by the unit or the disc.

RESUME function

The unit memorizes the point where **STOP** is pressed (► flashes on screen).

Press **PLAY** to resume play from this point.

Pressing **STOP** again or opening the tray cancels **RESUME**, however, **RESUME** is not canceled when power is turned off and on.

- **RESUME** works only with discs for which elapsed play time is displayed during play.

Auto-Power Off function

Power turns off after unit has been in Stop mode (DVD) for about 5 minutes.

Enjoy Video CDs featuring playback control without using menus (Video CDs only)

1. Do steps 1-4 (previous page).
When menu appears, press **STOP**.
2. Press number key(s) to select desired track (play begins).
 - Check disc for track numbers.
 - Press "1" to start at beginning of disc.

To Resume Menu use, Press **STOP**, and press **PLAY**, then the menu appears. Now, go to step 5 (previous page).

Notes

- Please read the disc jacket for operation information.
- If a single sided disc is placed in upside down, "PLEASE CHECK THE DISC, AND FOR STAINS OR SCRATCHES ON DISC" is displayed.
- Remove disc and press unit **POWER** off when not in use.
- Disc continues to rotate with menu displayed even after play is done. Press **STOP** to clear menu display when finished with menu.

TV Operation

▶**Important:** If a remote control button does not work when pressed, press the FM/TV button on the remote and try the button again.

1 Press **POWER*** on the remote or unit.

✓ Ready Checklist

- All connections are made.
- Your unit is plugged in.

2 Use **CH ▲▼** or **number keys** to select a channel.

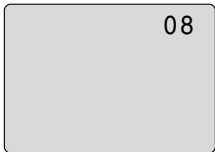

3 Press **VOL +** or **VOL -** to adjust volume.

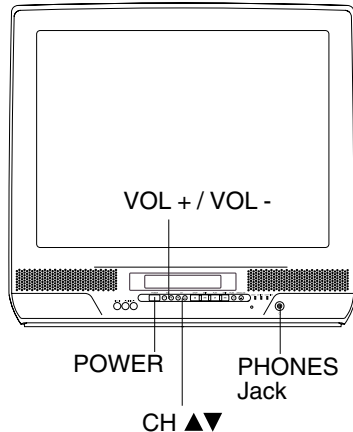

■ Using the 100 key

When selecting **CABLE** channels 100 to 125 with the number keys, first press the 100 key, and then enter the remaining two digits.

■ Rapid Tune

Press **R-TUNE** to display the last channel you were watching.

■ Audio Mute

Press **MUTE** to instantly mute the sound. Press again to restore the previous sound level.

■ Phones

Connect an earphone (not supplied) or headphones (not supplied) to the Phones Jack.

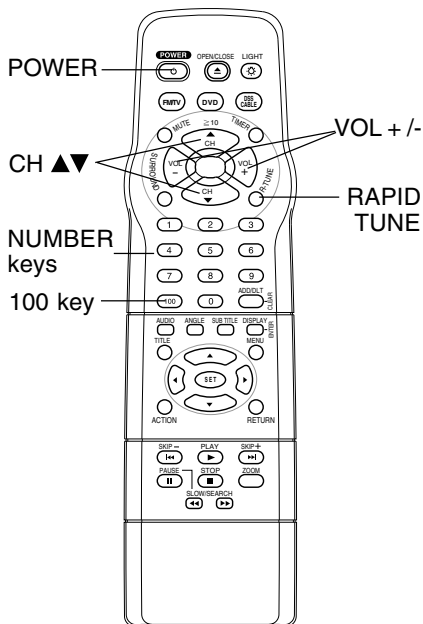

MTS Broadcast/TV Stereo System

Equipped with **dbx**[®] -TV Noise Reduction for true MTS reproduction. **dbx**[®] -TV Noise Reduction is required for good stereo separation and audio fidelity. **dbx**[®] is a registered trademark, and is licensed by **dbx**[®] Technology Licensing.

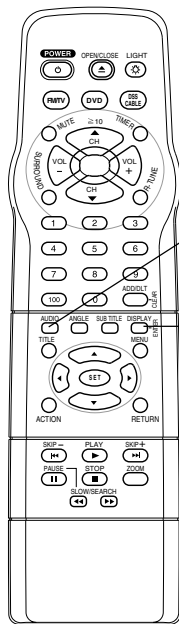

AUDIO

DISPLAY

Receivable Broadcast Types

The following are possible audio broadcast types and on-screen displays. The signal being received is indicated with an “Ⓢ” mark while the selected audio mode is indicated with an arrow. To change the audio mode for these broadcasts, see the “Select Audio Mode for TV Viewing” section (below.)

Press **DISPLAY** to display the broadcast signal being received.

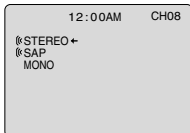

MTS Stereo and SAP broadcast

Multi-channel Television Sound Stereo (main language) and Secondary Audio Program (sub language) broadcasts are being received simultaneously. Select the STEREO or SAP audio mode.

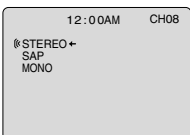

MTS Stereo broadcast

Multi-channel Television Sound Stereo broadcast. Select STEREO audio mode.
 • If stereo broadcast is weak and the display flickers, select MONO audio mode for possible improvement.

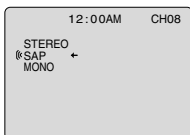

SAP broadcast

Secondary Audio Program (sub language). Select SAP audio mode for the sub language.

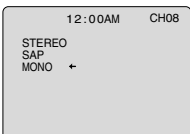

MONO broadcast

Normal monaural sound broadcast.

TV Operation

Audio Mode for TV Viewing

Press **AUDIO** to select the desired audio mode as described above.

(Arrow shows selection.)

- Each press of AUDIO will change the audio mode as shown below.
- “SAP” is selected with first press of AUDIO.

< Example >

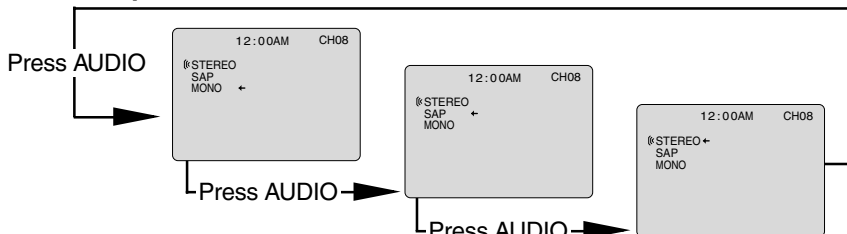

Closed Caption System

Closed Caption is ...

This multi-use system not only allows the hearing impaired to enjoy selected programs, but also makes useful information from TV stations available to everyone.

Closed Caption Mode Feature

1 Press **ACTION*** to display MAIN MENU.

2

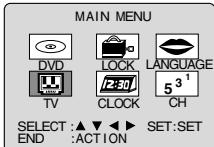

1) Press **▲▼◀▶** to select "TV."
2) Press **SET** to display SET UP TV screen.

3

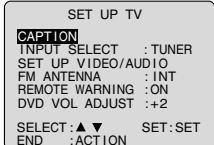

1) Press **▲▼** to select "CAPTION".
2) Press **SET** to display CAPTION screen.

4

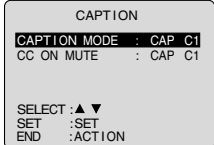

1) Press **▲▼** to select CAPTION MODE.
2) Press **SET** repeatedly to select mode. (See right.)



5 Press **ACTION** three times to return to the normal screen.

Closed Caption Mode Selections

Caption Mode: CAP C1 or C2

A narration of selected TV programs is displayed.

Check TV program listings for CC (Closed Caption) broadcasts.

Caption Mode: TEXT C1 or C2

Most of the screen will be blocked out. When the TV station broadcasts information, such as program listings, it will appear in this space.

Caption Mode: OFF

Closed Caption /Text narration will not be displayed.

NOTE :

The closed caption or text signal may be broadcast over C1, C2, or both. Also, text contents can vary so you may wish to try different settings.

*Important: If a remote control button does not work when pressed, press the FM/TV button on the remote and try the button again.

Caption On Mute Feature

Closed Caption narration, if available, is displayed when MUTE button is pressed for silence.

1 Press **ACTION** to display MAIN MENU.

2

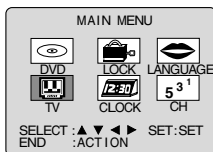

- 1) Press **▲▼◀▶** to select "TV."
- 2) Press **SET** to display SET UP TV screen.

3

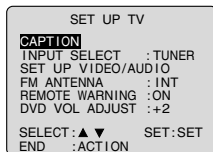

- 1) Press **▲▼** to select "CAPTION".
- 2) Press **SET** to display CAPTION screen.

4

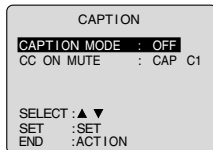

- 1) Press **▲▼** to select CAPTION MODE.
- 2) Press **SET** repeatedly to select "OFF."

5

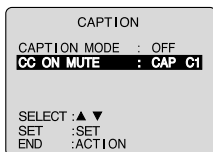

- 1) Press **▲▼** to select CC ON MUTE.
 - 2) Press **SET** repeatedly to select desired mode.
- Each press of **SET** will change the display as shown left.
 - The caption may be broadcast over CAP C1 or C2.

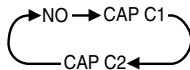

6 Press **ACTION** three times to return to the normal screen.

7 Press **MUTE** to mute the sound and display closed captioning.
• To cancel, press MUTE again.

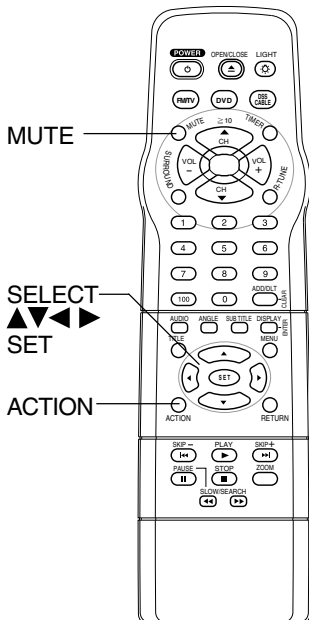

Note

- When a disc supporting closed caption is used, the subtitle and the closed caption may overlap. In this case, turn the subtitle or caption on mute mode off. (See page 36.)

TV Timer Features

ON-TIMER with Alarm

This unit can be set to automatically power on in one of 3 modes (TV, FM radio, or DVD/Video CD/CD.) You can also combine the On-Timer with a one minute alarm that gradually increases in volume.

1 Press TIMER* to display SET TIMER screen.

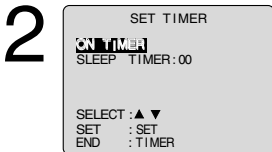

1) Press **▲▼** to select "ON TIMER."
2) Press **SET** to display ON TIMER screen.

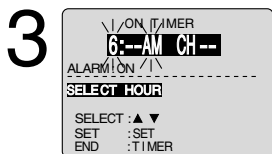

• ON-TIMER mode selection order

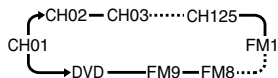

1) Press **▲▼** to select desired settings.
2) Press **SET** to set the ON-TIMER TIME or ON-TIMER mode.

- Make sure a disc is inserted if DVD (DVD/Video CD/CD) mode is selected.
- See "FM Radio" on pages 24 and 25 for instructions on how to preset FM stations.

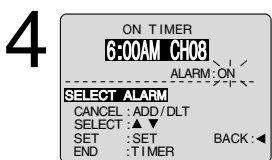

Press **▲▼** to select ALARM "ON" or "OFF."

When "ON" is selected, an alarm will gradually increase in volume for one minute or until canceled by pressing any button (including VOL + -).

To Make Corrections, use **▲▼** and **◀▶** to move back and correct.

5 Press TIMER to set ON TIMER.
• "ON TIMER SET" is displayed.
• ON TIMER Indicator lights up on the unit.

To Cancel ON-TIMER, Repeat steps 1 and 2. Then, press **ADD/ DLT** to clear the time in step 3. Now, press **TIMER** to end. "ON TIMER END" briefly appears on-screen.

Ready Checklist

- The clock is set to correct time.

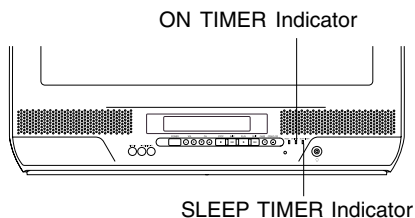

Sleep Timer

This unit can be set for auto power off.

1 Press TIMER to display SET TIMER screen.



1) Press **▲▼** to select SLEEP TIMER.
2) Press **SET** repeatedly to select the desired time.

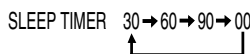

To cancel, press **SET** repeatedly until 00 appears.

3 Press TIMER to return to the normal screen.
• Pressing **DISPLAY** with sleep timer set displays remaining time.
• SLEEP TIMER Indicator lights up on the unit.

Note

- If no button on the remote or unit (including a button used to turn off the alarm) is pressed within 60 minutes after unit turns itself on, it will turn itself back off.

On-Screen Display (OSD)

***Important:**

If a remote control button does not work when pressed, press the FM/TV button on the remote and try the button again.

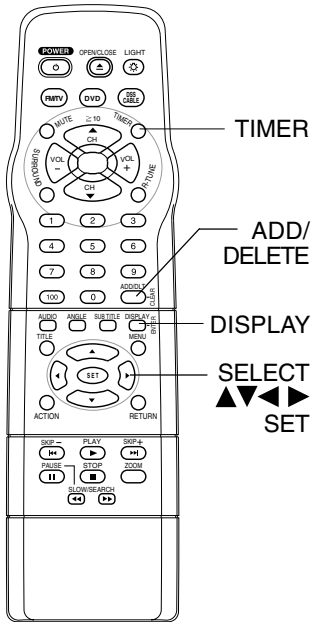

TV Status & Clock Display

Press **DISPLAY** to display or remove the overlay.

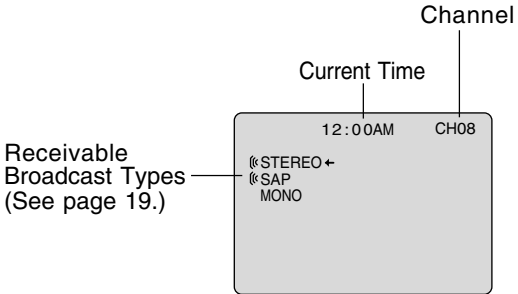

Blue Screen Display

Whenever the selected channel has no broadcast signal with the Weak Signal Display Feature set to "OFF" (see page 28), the screen will turn solid blue.

Channel Display

When you change channels, the channel number will be displayed.

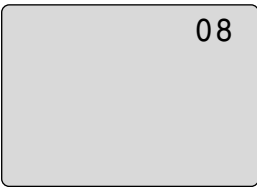

TV Operation

FM Radio

FM Radio is ...

This unit has an FM radio with built-in antenna, 9 station preset, and a band range of 87.5 ~ 108.1 MHz. You can even set the On-Timer (page 22) to wake up to your favorite radio station.

FM Radio Setup

1 Press **FM/TV** on the remote to display FM radio mode.

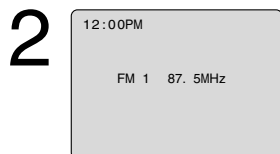

Press a number key* (1~9) to select the FM preset number.

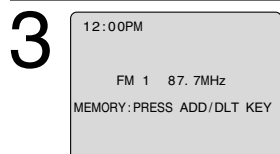

1) Press **CH ▲▼** to select the desired radio station. (Each press changes frequency by 200 KHz.)

2) Press **ADD/DLT** to set the radio station.

Hold down **CH ▲** or **▼** for a few seconds, then release to quickly scan for FM stations in your area.

• To cancel, press **CH ▲** or **▼** while in search mode.

To Make Corrections, select station with a number key, then do step **3** again.

To exit FM mode, press FM/TV or DVD on the remote.

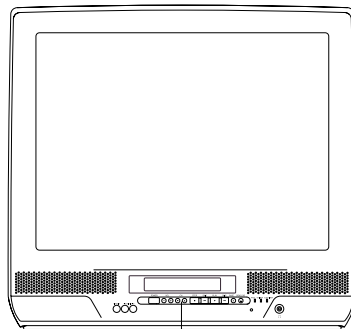

CH ▲▼

FM Antenna Setup

Make sure FM tuning is done correctly (see FM Radio Setup).

1 Press **ACTION** to display MAIN MENU.

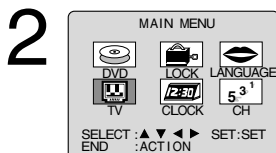

1) Press **▲▼◀▶** to select "TV."
2) Press **SET** to display SET UP TV screen.

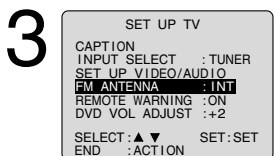

1) Press **▲▼** to select FM ANTENNA.
2) Press **SET** to select "INT (INTERNAL)" or "EXT (EXTERNAL)" to determine which one sounds best.

- For cable TV users
→ "INT"
- For antenna users
→ "EXT"

4 Press **ACTION** twice to end setup.

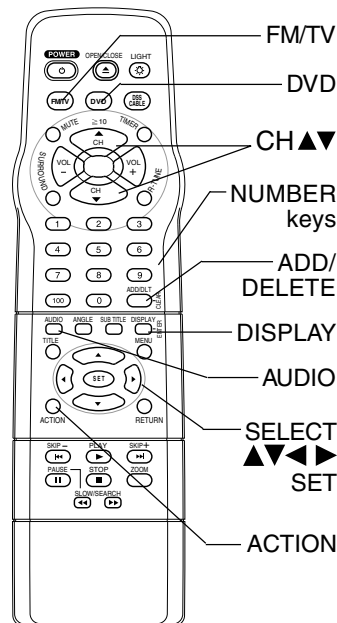

Audio Mode for FM Radio

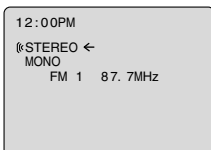

Press **AUDIO** repeatedly to select "STEREO" or "MONO" in FM Radio mode.

Notes

- You may get better reception by repositioning the unit.
- You cannot select FM Radio mode while a blue back screen (ACTION, MENU) is displayed.
- Once stations are set, the selected station and current time are displayed when FM Radio mode is entered. To remove time, press DISPLAY.

Using FM Radio

1 Press **FM/TV** on the remote to display FM radio mode.

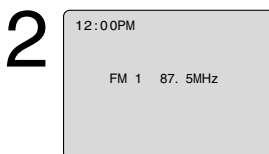

Press a number key (1~9) to select a preset FM number (see FM Radio Setup on page 24).

To exit FM mode, press **FM/TV** or **DVD** on the remote.

Cable Box Universal Remote Control Feature

Universal Remote Control is...

The Remote Control may be set up to control some basic DSS or Cable box functions.

The Universal Remote Control Setup

1 Find your DSS box or Cable box Brand Code Number from one of the charts on the next page.

2 Setup remote.
Hold down DSS CABLE and press number keys to enter code.

- If code number is 100 or greater, e.g., press 1 - 0 - 2 for 102.

3 Confirm code entry.
Press POWER to turn selected unit ON or OFF.

- See below for controllable functions in each mode.

Notes

- Please repeat the Universal Remote Control Setup after replacing remote control batteries.
- The remote control will not operate all DSS receivers or Cable Boxes made by the manufacturers listed. If you get no results, your particular brand cannot be controlled.

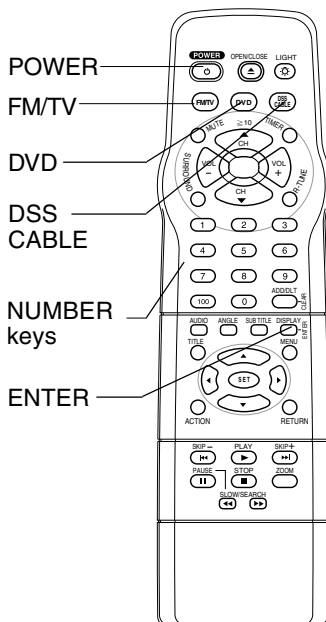

Using the Universal Remote Control (Available Buttons / Functions)

Once the remote control has been properly set up, you can select FM/TV, DVD, DSS or CABLE mode depending on which functions you wish to control.

Press FM/TV, DVD or DSS CABLE on the remote control to select the desired mode. (See below for buttons available in each mode.)

Set to FM/TV, DVD:

All TV, FM, and DVD functions.

Set to DSS CABLE:

- CABLE/DSS function, e.g. POWER, ENTER, NUMBER keys (except 100 key), CH UP/DOWN.

DSS Brand Code Numbers

Toshiba	90	Optimus	94, 95
Hitachi/ Hughes	91, 99	Panasonic	96
Primestar	92	ProScan	97
Drake	93	RCA	97
Magnavox	94, 95	SONY	98, 105
Uniden	94, 95		

Cable Box Brand Code Numbers

Archer	44, 06, 01, 120, 05, 63, 126	Oak Sigma	46, 11, 129, 101
Cableview	29, 09, 01, 63, 120, 44, 42, 30, 52, 04, 124, 126	Panasonic	17, 16, 08, 87, 109
Citizen	44, 52, 30, 63, 42, 04, 124, 126	Philips	23, 24, 20, 13, 07, 50, 128, 129
Curtis	08, 09, 25, 61, 53, 87	Pioneer	06, 05, 12
Century	44, 51, 75, 59, 126	Pulsar	04, 42, 63, 44, 30, 52, 124, 126
Cabletenna	29, 09, 01, 63, 120, 44, 126	Quest	06, 05, 12
Cable Cinema	29, 09, 01, 63, 120, 44, 126	Radio Shack	44, 51, 75, 59, 126
Diamond	29, 09, 01, 63, 120, 44, 126	RCA	17, 16, 08, 87, 109
Eagle	62, 40, 22, 13, 58, 20, 26, 107	Realistic	44, 51, 75, 59, 126
Eastern	28, 29, 130	Recoton	44, 51, 75, 59, 126
Explorer	08, 09, 25, 61, 53, 87	Regal	41, 14, 15, 28, 102, 104, 103, 130
Gemini	30, 04, 124	Regency	28, 29, 130
General Electric	01, 57, 120	Rembrandt	44, 42, 63, 29, 01, 32, 39, 120, 126
General Instruments	01, 84, 83, 34, 03, 02, 04, 55, 65, 66, 67, 68, 120, 106, 121, 122, 115, 117, 118, 124	Samsung	42, 06, 32, 05, 40
Gerrard	44, 51, 75, 59	Scientific Atlanta	08, 09, 25, 61, 53, 87
GC Electronics	44, 42, 63, 29, 30, 52, 04, 124, 126	Sheritech	27
Hamlin	41, 14, 15, 28, 102, 104, 103, 130	Signal	26, 112
Hitachi	31	SL Marx	42, 06, 32, 40, 43, 44, 52, 63, 126
Jerrold	01, 84, 83, 34, 03, 02, 04, 55, 65, 66, 67, 68, 120, 106, 121, 122, 115, 117, 118, 124	Sprucer	17, 16, 08, 87, 109
Jasco	30, 04, 124	Standard Components	32, 39, 42, 44, 126
Macom	31	Stargate	04, 42, 32, 40, 63, 44, 30, 52, 06, 124, 126
Magnavox	26, 112	Sylvania	19, 18
Matsushita	17, 16, 08, 87, 109	Teknika	74, 35
Movietime	32, 39, 42, 44, 126, 38, 40	Telecaption	77, 127
Maestro	74, 35	Televue	40, 19, 38, 32, 42, 06
NEC	40, 19, 38, 32	Texscan	19, 18
NSC	40, 19, 38, 32	Tocom	34, 33, 01, 42, 66, 120
Novavision	08, 09, 25, 61, 53, 87	Toshiba	36
Next Level	01, 84, 83, 34, 03, 02, 04, 55, 65, 66, 67, 68, 120, 106, 121, 122	Unika	44, 42, 63, 29, 01, 126, 120
Oak	46, 11, 129, 101	Universal	52, 43, 44, 63, 42, 126
		Viewstar	62, 40, 22, 13, 58, 20, 26, 107
		Viewday	07, 23, 50, 129
		Vidtek	64
		Zenith	07, 23, 50, 129

Notes

- In DSS or CABLE mode, it may be necessary to press ENTER after pressing number keys for channel selection.
- In DSS or CABLE mode, POWER, CH Up/Down, Number Keys, ACTION, TIMER, DISPLAY/ENTER, SEARCH, SKIP+/-, R-TUNE, SELECT, SET, ZOOM, ANGLE, AUDIO, TITLE, SUB TITLE, MENU, or ADD/HLT/CLEAR are not available. Press FM/TV, DVD to use these functions.
- Depending on your DSS receiver or Cable box brand, some of the functions listed may not be remote controllable.
- Some DSS receiver or Cable box brands require you to turn on the power manually.
- Due to changes in infra-red commands used by manufacturers, some brands have several codes. If your unit does not respond to the first code, please try the next one.

Special Features

Remote Warning Feature

When Universal Remote Control (page 26) is used, and this feature is set to "ON," a warning appears whenever an invalid key is pressed in DSS or Cable mode.

1 Press **ACTION*** to display MAIN MENU.

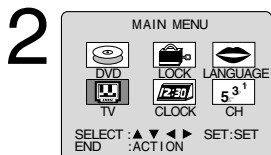

1) Press **$\blacktriangle\blacktriangledown\blacktriangleleft\blacktriangleright$** to select "TV."
2) Press **SET** to display SET UP TV screen.

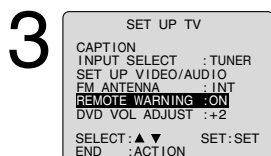

1) Press **$\blacktriangle\blacktriangledown$** to select REMOTE WARNING.
2) Press **SET** to set "ON" or "OFF."

- "REMOTE WARNING : OFF"
→ Remote warning will not appear even if invalid key is pressed.

4 Press **ACTION** twice to return to normal screen.

Selecting Input Mode

Method 1:

Press **CH $\blacktriangle\blacktriangledown$** . The display will change as follows.

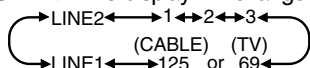

Method 2:

- Press **ACTION** for MAIN MENU.
- Press **$\blacktriangle\blacktriangledown\blacktriangleleft\blacktriangleright$** to select "TV," then press **SET** for SET UP TV screen.
- Press **$\blacktriangle\blacktriangledown$** to select "INPUT SELECT," and then press **SET** to select "TUNER," "LINE1," or "LINE2."
- Press **ACTION** twice to exit this mode.

Auto Operation Functions

Auto Shut Off

- No broadcast signal in TV mode (Only when Weak Signal Display is set to OFF.), DVD stops for 5 minutes
→ Power turns off
- This feature is canceled if any button is pressed during above conditions.

Weak Signal Display Feature

When "ON" is selected, the picture is displayed even when a broadcast signal is weak or non-existent.

1 Press **ACTION** to display MAIN MENU.

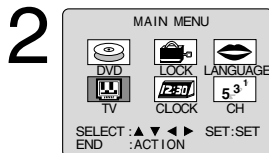

1) Press **$\blacktriangle\blacktriangledown\blacktriangleleft\blacktriangleright$** to select "CH."
2) Press **SET** to display SET UP CHANNEL screen.

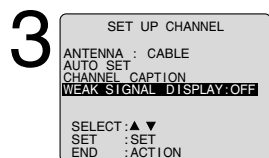

1) Press **$\blacktriangle\blacktriangledown$** to select WEAK SIGNAL DISPLAY.
2) Press **SET** to set "ON" or "OFF."

Notes

- "ON" = Picture is displayed regardless of signal condition, and may not always be clearly visible.
- "OFF" = Screen turns solid blue when signal is absent or weak.
- If unit is connected to equipment which has blue back feature, selecting "ON" will have no effect on the other equipment.

4 Press **ACTION** twice to return to the normal screen.

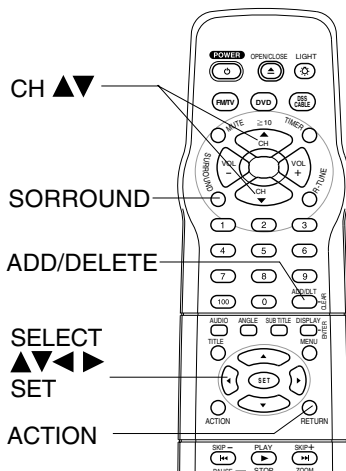

*Important: If a remote control button does not work when pressed, press the FM/TV button on the remote and try the button again.

Channel Caption

Channel Caption is ...

Station names, e.g. ABC, CNN, etc. are set so they will appear when a channel is selected. Choose 24 preset names.

You need a list of stations and the channel numbers you receive them on.

1 Press ACTION to display MAIN MENU.

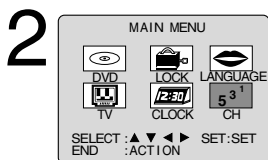

- 1) Press ▲▼◀▶ to select "CH."
- 2) Press SET to display SET UP CHANNEL screen.

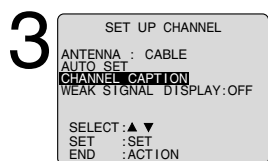

- 1) Press ▲▼ to select CHANNEL CAPTION.
- 2) Press SET to display screen.

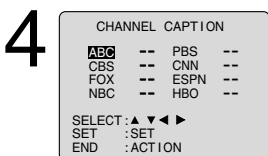

- 1) Press ▲▼ to select a station.
 - 2) Press SET (or ▶) to move cursor to the right.
 - 3) Press ▲▼ to select channel number.
 - 4) Press SET (or ◀▶) to set preset captions.
- Repeat step 4 until the Caption List is complete.

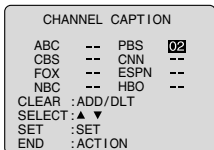

To Make Corrections

Press ▲▼, then SET (or ▶)

to select channel number.

Press ▲▼ to change, or ADD/DLT to delete.

5 Press ACTION three times to end setup.

DVD Volume Adjust

Audio recorded on a DVD or Video CD often incorporates a dynamic range of sound. This means that, when compared to a music CD, etc., the average volume is generally lower and the peaks may be higher. This unit can be set so that the volume is increased automatically.

1 Press ACTION to display MAIN MENU.

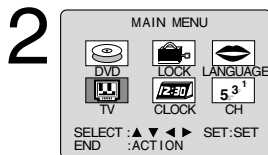

- 1) Press ▲▼◀▶ to select "TV."
- 2) Press SET to display SET UP TV screen.

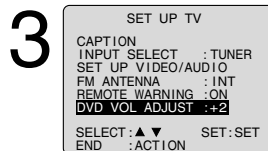

- 1) Press ▲▼ to select DVD VOL ADJUST.
- 2) Press SET to set the level (0, +1, or +2).

4 Press ACTION twice to return to normal screen.

Surround Sound System

You can hear a deeper, 3-D sound effect using just the unit's two front speakers.

Set Surround sound.

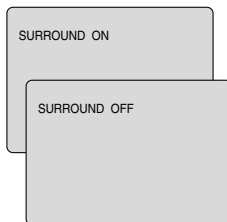

Press SURROUND.
• "SURROUND ON" is displayed.

To Cancel,
press SURROUND.

Notes

- Surround sound effect is not available for normal (mono) broadcasts.
- The surround effect (TV mode only) is not output to Audio Output L/R Connector.

V-Chip Control Feature

V-Chip Control Feature is...

This unit has a built-in V-Chip Control which allows you to block unwanted TV usage based on US MOVIES and US TV PROGRAMS Ratings.

Process of V-Chip Control Feature

Enter Code → **Setup** → **Blocking**

Enter Secret Code

A 4-digit code must be entered to view a blocked program or change rating settings.

1 Press ACTION*
to display MAIN MENU.

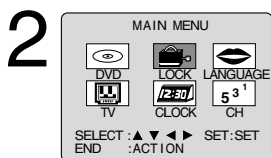

- 1) Press ▲▼◀▶ to select "LOCK."
- 2) Press SET to display LOCK screen.

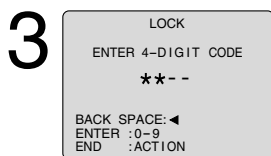

- 1) Press number keys to enter your secret code.
- 2) Enter same code again for confirmation.

To Make Corrections
Press ◀ repeatedly to move the cursor.
Press number keys to make the correction.

- Step 2) not necessary when changing rating or secret code.
- Take care that you are not observed entering the secret code.

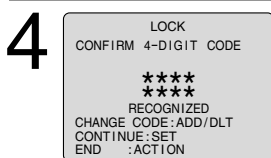

Press SET to display US Ratings menu (see pages 31, 32).
Or
Press ACTION twice to exit.

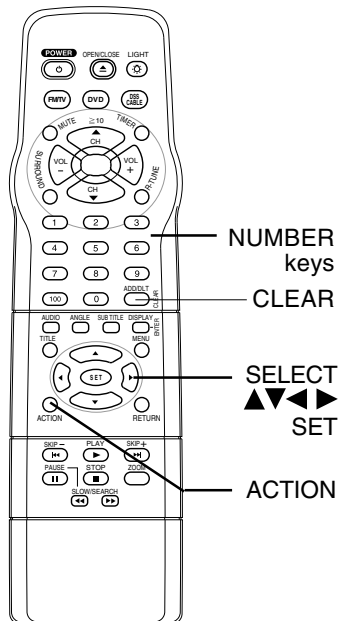

Changing your secret code

- You will need your current code.

Do steps 1 ~ 3. In step 4, press CLEAR to clear current code.
Repeat steps 3 and 4 to enter new code.

Notes

- DO NOT forget your secret code.
- Once ratings are set, restricted programs cannot be accessed unless the secret code is entered.

*Important: If a remote control button does not work when pressed, press the FM/TV button on the remote and try the button again.

If LOCK menu is not displayed, perform “Enter Secret Code” steps on page 30.

Process of V-Chip Control Feature



US MOVIES Ratings

1

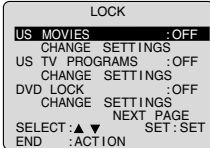

1) Press **▲▼** to select US MOVIES.

2) Press **SET** to set “ON” or “OFF.”

- “ON” → V-Chip Control is activated.
- “OFF” → V-Chip Control is deactivated.

Note

- “NEXT PAGE” displays CANADIAN V-Chip setting menu. Not necessary except when viewing Canadian discs or broadcasts.

2

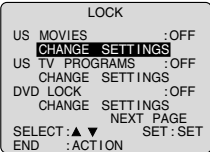

1) Press **▲▼** to select CHANGE SETTINGS.

2) Press **SET** to display screen.

3

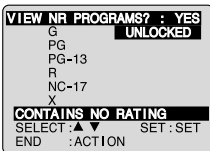

1) Press **▲▼** to select VIEW NR PROGRAMS?.

2) Press **SET** to set “YES” or “NO.”

NR (Not Rated) PROGRAMS

Some movies, such as old movies or foreign movies usually have no ratings.

4

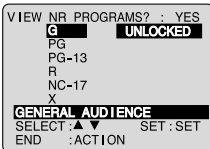

1) Press **▲▼** to select and **SET** to set ratings to be blocked. (See ratings chart on this page.)

5

Press **ACTION** to redisplay LOCK menu and continue with US TV PROGRAMS Ratings Setup (page 32). Or, press **ACTION** four times to exit.

US MOVIES RATINGS

G	GENERAL AUDIENCE: All ages admitted.
PG	PARENTAL GUIDANCE: Some material may not be suitable for children.
PG-13	PARENTS CAUTIONED: Some material may be inappropriate for children under 13.
R	RESTRICTED: Children under 17 must be accompanied by a parent or adult.
NC-17	OVER AGE 17 ONLY: No one 17 and under admitted.
X	ADULTS ONLY:

V-Chip Control Feature (continued)

If LOCK menu is not displayed, do "Enter Secret Code" steps on page 30.

Process of V-Chip Control Feature



US TV PROGRAMS Ratings

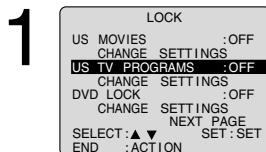

- 1) Press ▲▼* to select US TV PROGRAMS.
- 2) Press SET to set "ON" or "OFF."

- "ON" → V-Chip Control is activated.
- "OFF" → V-Chip Control is deactivated.

Note

- "NEXT PAGE" displays CANADIAN V-Chip setting menu. Not necessary except when viewing Canadian discs or broadcasts.

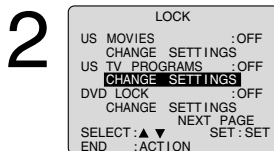

- 1) Press ▲▼ to select CHANGE SETTINGS.
- 2) Press SET to display screen.

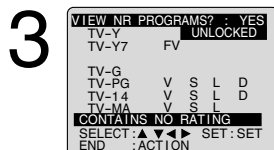

- 1) Press ▲▼ to select VIEW NR PROGRAMS?.
- 2) Press SET to set "YES" or "NO."

NR (Not Rated) PROGRAMS

Some TV shows, such as news, sports, weather, bulletins, emergency information usually have no ratings.

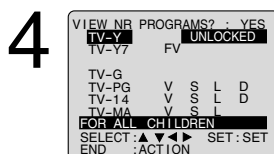

- 1) Press ▲▼ to select and SET to set ratings to be blocked.
(See ratings charts on this page.)

Note

- You may select from standard TV ratings (chart 1), or customize to a specific content rating (chart 2).
- Ratings highlighted in Green will be blocked. Ratings in white letters will not be blocked.

- 5 Press ACTION four times to exit this mode.

US TV PROGRAMS RATINGS: Chart 1

TV-Y	FOR ALL CHILDREN: Content specifically geared to young viewers ages 2-6.
TV-Y7	FOR AGE 7 AND OLDER: May contain mild physical or comedic violence which may frighten children under 7.
TV-G	GENERAL AUDIENCE: Contains little or no violence, strong language, or sexual dialogue or situations.
TV-PG	PARENTAL GUIDANCE: May contain infrequent coarse language, limited violence, some suggestive sexual dialogue and situations.
TV-14	PARENTS CAUTIONED: May contain sophisticated themes, sexual situations, strong language, and more intense violence.
TV-MA	MATURE AUDIENCE: May contain mature themes, profane language, graphic violence, and sexual situations.

US TV PROGRAMS RATINGS: Chart 2

FV	Fantasy Violence
V	Violence
S	Sexual Situations
L	Adult Language
D	Sexually Suggestive Dialogue

*Important: If a remote control button does not work when pressed, press the FM/TV button on the remote and try the button again.

Process of V-Chip Control Feature

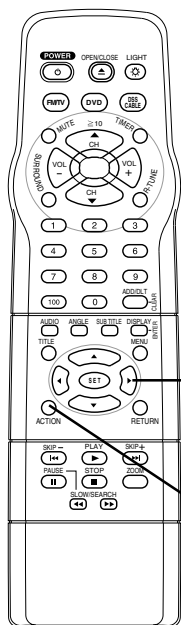

SELECT
▲▼◀▶

ACTION

Blocking Message

<When V-Chip Control is activated>

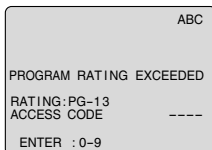

- If a program or movie exceeds the ratings you have set, a message will appear on a black background and sound is muted.

To View a Blocked Program/Movie

[Temporarily Deactivate V-Chip Control]

Enter your secret code (ACCESS CODE) in the Blocking Message screen.

- V-Chip Control is reactivated when power is turned off or power failure occurs.

[Deactivate V-Chip Control]

Enter your secret code (steps 1-4 page 30). Then, set US MOVIES and/or US TV

PROGRAMS to "OFF" using ▲▼ and SET.

(Ratings set on pages 31, 32 is retained and will be in effect when V-Chip Control is activated again.)

Video / Audio Menu

•**Important:** If a remote control button does not work when pressed, press the FM/TV button on the remote and try the button again.

This feature allows easy setting of picture and sound suitable for each program source.

Video Menu

1 Press **ACTION*** to display MAIN MENU.

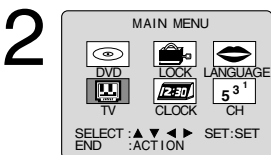

- 1) Press **▲▼◀▶** to select "TV."
- 2) Press **SET** to display SET UP TV screen.

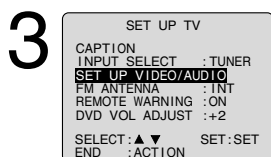

- 1) Press **▲▼** to select "SET UP VIDEO/AUDIO."
- 2) Press **SET** to display.

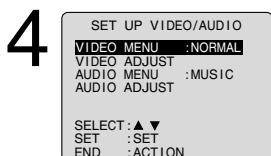

- 1) Press **▲▼** to select "VIDEO MENU."
- 2) Press **SET** repeatedly to select desired mode. (See below.)

5 Press **ACTION** three times to end setup.

[Video Menu]

- **NORMAL**
Factory setting.
- **MOVIE**
Picture is adjusted for a movie-like feel.
- **NIGHT**
Color and picture intensity are adjusted to be easier on the eyes for night viewing.

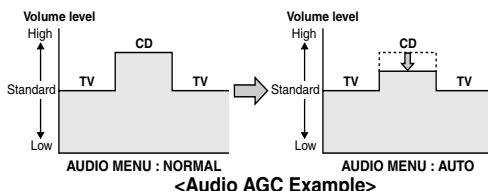

Audio Menu

a Do steps 1 - 3 left.

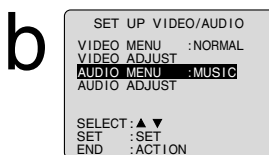

- 1) Press **▲▼** to select "AUDIO MENU."
- 2) Press **SET** to select desired mode. (See below.)

C Press **ACTION** three times to end setup.

[Audio Menu]

- **NORMAL**
- **AUTO**
[Audio AGC (Auto Gain Control)]
The sound level is automatically adjusted to suit the program source (see below left).
- **MOVIE**
Sound suited to movies.
- **MUSIC**
Sound suited to music. (Factory setting)
- **SPEECH**
Sound suited to dialogue.

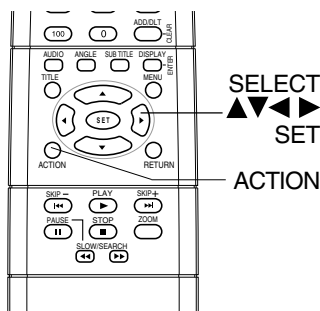

Notes

- The effects of this feature on the signal is not output to the Audio/Video Output Connector.
- When AUDIO MENU mode is "AUTO," the AUDIO ADJUST setting will be "STANDARD."
- AUDIO MENU settings remain in memory.
- VIDEO MENU settings do not remain in memory.

Video / Audio Adjustment

Video Adjustment

1 Press **ACTION** to display MAIN MENU.

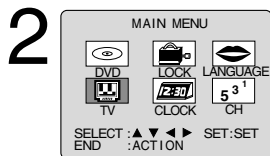

- 1) Press **▲▼◀▶** to select "TV."
- 2) Press **SET** to display SET UP TV screen.

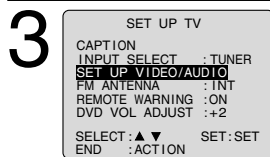

- 1) Press **▲▼** to select "SET UP VIDEO/AUDIO."
- 2) Press **SET** to display.

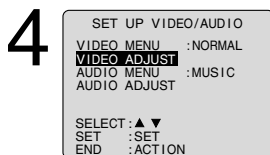

- 1) Press **▲▼** to select "VIDEO ADJUST."
- 2) Press **SET** to display.

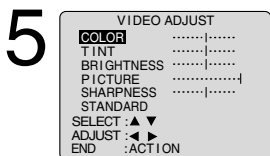

- 1) Press **▲▼** to select an item. (See below.)
- 2) Press **◀▶** to adjust.

To Reset VIDEO Controls.
Press **▲▼** and **SET** to select and set "STANDARD." All controls return to their factory settings.

6 Press **ACTION** four times to end setup.

[VIDEO Adjustment]

- **COLOR Control**
Adjust color intensity.
- **TINT Control**
Adjust for natural flesh tones.
- **BRIGHTNESS Control**
Adjust picture brightness.
- **PICTURE Control**
Adjust picture intensity by adjusting both contrast and color level in the proper balance.
- **SHARPNESS Control**
Adjust picture sharpness.

Audio Adjustment

a Press **ACTION** to display MAIN MENU.

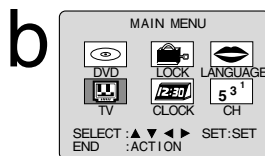

- 1) Press **▲▼◀▶** to select "TV."
- 2) Press **SET** to display SET UP TV screen.

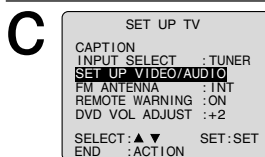

- 1) Press **▲▼** to select "SET UP VIDEO/AUDIO."
- 2) Press **SET** to display.

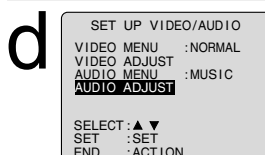

- 1) Press **▲▼** to select "AUDIO ADJUST."
- 2) Press **SET** to display.

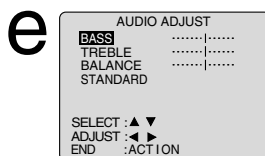

- 1) Press **▲▼** to select an item. (See below.)
- 2) Press **◀▶** to adjust.

To Reset AUDIO Controls.
Press **▲▼** and **SET** to select and set "STANDARD." All controls return to their factory settings.

f Press **ACTION** four times to end setup.

[AUDIO Adjustment]

- **BASS Control**
To adjust the intensity of low frequency sound.
- **TREBLE Control**
To adjust the intensity of high frequency sound.
- **BALANCE Control**
To adjust the (L/R) unit speaker output level.
- The levels set here do not affect other audio equipment when connected to the Audio Output L/R Connector.

Disc Operation

Subtitle Language (DVD only)

You can select a different subtitle language (if offered) than the one set at the Settings for DVD Operation. (See page 46.)

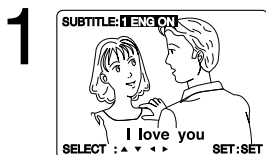

Press SUB TITLE* in Play mode to display the subtitle selection on-screen.

- Display disappears after 5 seconds.
- When no subtitles are offered, “.” will be displayed instead of the language number.



- 1) Press **▲▼** to select desired language.
- 2) Press **▶** (or **◀**) to set.
- 3) Press **▲** (or **▼**) to select “ON” or “OFF.”

Number of subtitle language being played back.

Notes

- When closed captioning is used along with subtitles, they may overlap. If so, turn one function off. (See pages 20 and 21.)
- If after several presses of the button the language does not change, language selection is not offered on the disc.
- Subtitles may not change to the selected language immediately.
- When power is turned on again or disc is removed, subtitles revert to initial setting language. If the initial language is not recorded on the disc, the disc’s priority language will appear.

Audio Soundtrack Language (DVD only)

You can change the audio soundtrack language, selected at the Settings for DVD Operation, to a different language if available. (See page 46.) (This operation works only with discs on which multiple audio soundtrack languages are recorded.)



Press AUDIO in Play mode to display the audio selection on-screen.

- Display disappears after 5 seconds.

Audio attribute 1 type, sampling frequency, bit No. of the disc.



- 1) Press **▲▼** to select desired language.

Number of the audio soundtrack language being played back.



Ready Checklist

- Please read “Basic DVD Operation” on page 16.

[Subtitle language (No.)] [Audio soundtrack language (No.)]

ENG	English
FRA	French
DEU	German
ITA	Italian
ESP	Spanish
NLD	Dutch
SVE	Swedish
NOR	Norwegian
DAN	Danish
POR	Portuguese
RUS	Russian
JPN	Japanese
CHI	Chinese
KOR	Korean
MAL	Malay
VIE	Vietnamese
THA	Thai
*	Other

- Change the No. by **pressing ▲▼**, and **press SET**.

[Audio attribute 1 type, sampling frequency, bit No. of the disc (see page 47)]

LPCM	96KHz or 48KHz	16bit 20bit 24bit	Linear PCM disc
	Dolby Digital dts	1ch - 5.1ch	

Notes

- If, after several presses of the AUDIO button the language does not change, language selection is not offered on the disc.
- When power is turned on again or disc is removed, language reverts to initial setting. If this language is not recorded on the disc, the language recorded will be heard.

*Important: If a remote control button does not work when pressed, press the DVD button on the remote and try the button again.

When  appears on the screen while a button is being pushed, it means that the corresponding operation is prohibited by the unit or the disc.

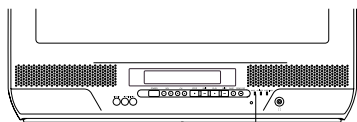

ANGLE Indicator

Notes

- ANGLE Indicator lights up on the unit when a scene recorded at different angles is detected.
- The angle number can be set beforehand so that the angle is switched whenever ANGLE Indicator lights up.

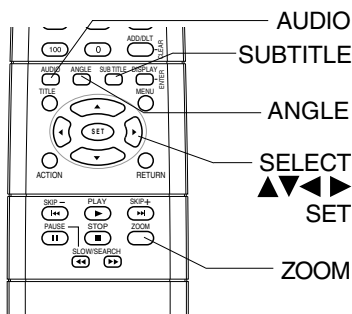

Notes

- Closed captioning will not be displayed while Picture Zoom is used. To see subtitles, set the subtitle feature to ON (see page 36).
- The subtitle cannot be enlarged nor can its position be changed.
- The picture zoom feature does not work with a Video CD.
- During picture zoom, "ZOOM1" or "ZOOM2" is displayed on-screen.
- Zooming, on some discs, may result in poor picture quality, or may not operate at all.

Multiple Angle Viewing (DVD only)

DVDs may contain scenes shot from multiple camera angles allowing the same scene to be viewed at different angles. You can view these angles, if available, using the ANGLE button.

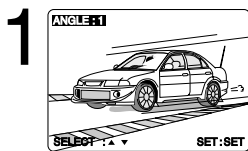

Press ANGLE in Play mode to display the angle selection on-screen.

- Display disappears after 5 seconds.

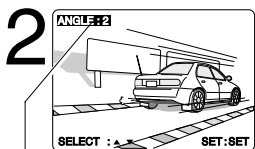

1) Press **▲▼** to select the desired angle.

Number of angle being played back.

Vocal selection for Karaoke discs (DVD/Video CD)

a Press **AUDIO** in Play mode to display the audio screen.



1) Press **▲▼** (or **◀▶**) to select as shown below.
2) Press **▶** (or **◀**) to set. (DVD only)

- DVD Karaoke (1 vocal) VOCAL ON → VOCAL OFF
- DVD Karaoke (2 vocals) VOCAL V1 + V2 → VOCAL V1 → VOCAL V2 → VOCAL OFF
- Video CD LR → L → R

Picture Zoom (DVD only)

You can enlarge specific portions of a picture and select the zoom ratio using the ZOOM button on the remote during DVD playback.

Set Zoom size.

Press ZOOM repeatedly to change display as follows.

- You can enlarge the center portion of the image to one of 2 magnifications.

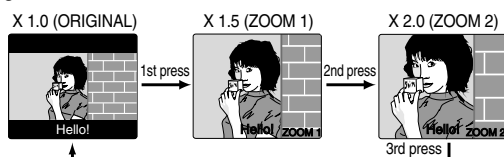

- Use the **▲, ▼, ◀** and **▶** buttons to move the position up, down, left and right.

Disc Operation (continued)

Title menu (DVD only)

Some DVDs have more than one title, e.g. movies. If the disc offers a title menu, you can select the desired title number. (Operation may vary according to the disc.)

1



<Example>

Press **TITLE*** in Play mode to display title screen.

• Pressing **TITLE** again resumes play from the scene when **TITLE** was first pressed.

2

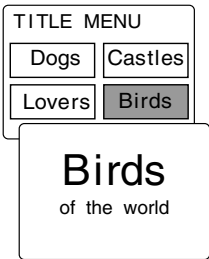

<Example>

1) Press **▲▼◀▶** or **number Key(s)** to select a title.

2) Press **SET** or **PLAY** to start play.

• Step 2) not necessary when using number key(s).

DVD menu (DVD only)

DVDs may offer a special menu. This menu may include guides to unique contents, audio/subtitle languages, etc. Although contents and operation may vary, the following steps show basic steps for using the menu.

a

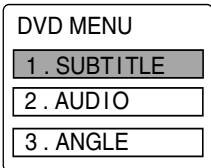

<Example>

Press **MENU** in Play mode to display DVD menu.

• Pressing **MENU** again resumes play from the scene when **MENU** was first pressed.

b

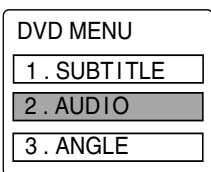

<Example>

1) Press **▲▼◀▶** or **number key(s)** to select an item.

2) Press **SET** or **PLAY** to access.

• Step 2) not necessary when using number key(s).

Repeat step "b" if there is more than one menu.

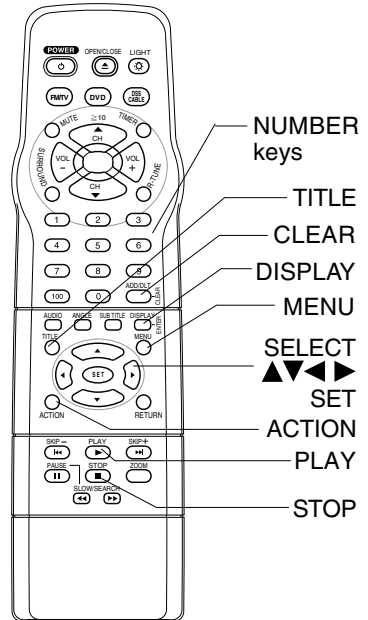

*Important: If a remote control button does not work when pressed, press the FM/TV, DVD button on the remote and try the button again.

Program Play (Video CD/CD)

You can program specific tracks and order of play.

1 Press **ACTION** in Stop mode to display MAIN MENU.

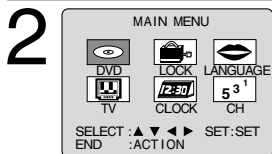

- 1) Press **▲▼◀▶** to select "DVD."
- 2) Press **SET** to display screen.



- 1) Press **▲▼** to select "PLAY MODE."
- 2) Press **SET** to display screen.



- 1) Press **▲▼** to select "PROGRAM PLAY."
- 2) Press **SET** to display screen.

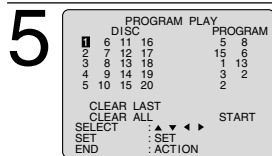

- 1) Press **▲▼◀▶** to select a track number. (Track numbers on disc are displayed.)
- 2) Press **SET** to set.

- Repeat step 5 to select another track.
- The selected track is added on the right side.

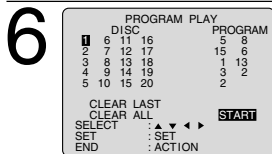

- 1) Press **▲▼◀▶** to select "START."
- 2) Press **SET** to start play of programs in the sequence selected.

- To cancel, press **STOP** during play, then press **CLEAR**.

Notes

- Up to 15 tracks can be programmed.
- "◀" or "▶" (depending on disc) indicates additional PROGRAM PLAY screen. Press **▲▼◀▶** for next or previous screen.
- To clear the last program one by one, Press **▲▼◀▶** to move to "CLEAR LAST" and press **SET**. (Pressing **CLEAR** also clears last program.)
- To clear all programs, Press **▲▼◀▶** to move to "CLEAR ALL" and press **SET**. (Programs are also cleared when the power is turned off or the disc is removed.)

✓ Ready Checklist

- Unit is in TV mode, press FM/TV.
- Video CD or CD is inserted.

Program Repeat Play (Video CD/CD)

a Do steps 1 through 6 on this page.

b Press **DISPLAY** to display Disc Information screen. (Disc Information Screen)

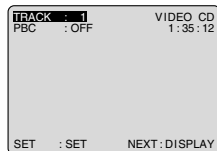

c Press **DISPLAY** again to display Unit Information screen.

d Press **SET** to enter Select mode. ("REPEAT OFF" will flash.) (Unit Information Screen)



e Press **▲▼** to select "DISC REPEAT."

(Unit Information Screen)



f Press **SET** to set mode. ("DISC REPEAT" stops flashing.) To cancel, select "REPEAT OFF" in step **e**, then press **SET**.

Disc Operation (continued)

Random Play (Video CD/CD)

Tracks are played in a random order.

- 1 Press **ACTION*** in Stop mode to display MAIN MENU.

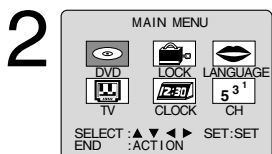

- 1) Press **▲▼◀▶** to select "DVD."
- 2) Press **SET** to display screen.



- 1) Press **▲▼** to select "PLAY MODE."
- 2) Press **SET** to display screen.

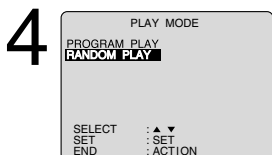

- 1) Press **▲▼** to select "RANDOM PLAY."
 - 2) Press **SET** to begin random play.
- To cancel, press **STOP** during play, then press **CLEAR**.

*Important: If a remote control button does not work when pressed, press the FM/TV button on the remote and try the button again.

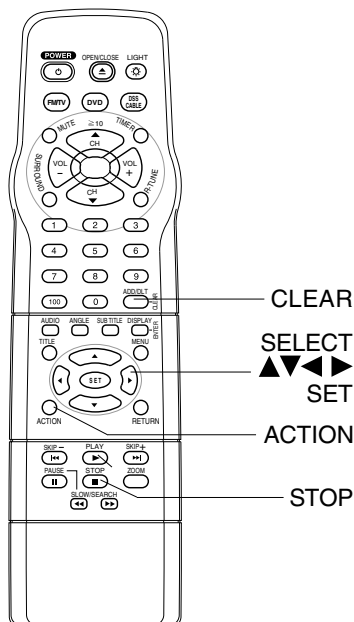

DVD Operation using On-Screen Displays

When DISPLAY is pressed, On-Screen Displays show disc information (title/chapter/track number, elapsed playing time) and unit information (repeat play, Play mode).



Ready Checklist

- Unit is in DVD mode, press DVD.

1 Press DISPLAY in Play or Stop mode to display "On-Screen Display."

- Each press of DISPLAY changes the on-screen display as follows. (Please refer to page 42 or 43.)

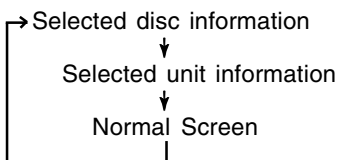

Note

- DISPLAY button does not function while DVD TITLE MENU is displayed.

2 1) Press ▲▼ (or ◀▶) to select an item. 2) Press SET to set.

- 1) Press ▲▼ to select the setting.
- 2) Press SET to set.

<Example of DVD>

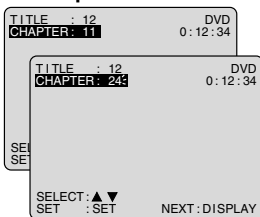

- For some functions the setting will be registered immediately without pressing SET.
- When numbers are displayed (e.g. title number), the NUMBER keys are also available.

To make corrections, press ▲▼ and SET repeatedly to move to error, then correct.

- Pressing ► is effective for elapsing time instead of the above buttons. Press ◀ repeatedly to delete the error, then correct.

<Example of Video CD>

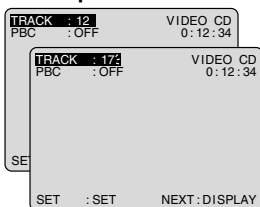

To return to the normal screen, press CLEAR or DISPLAY repeatedly.

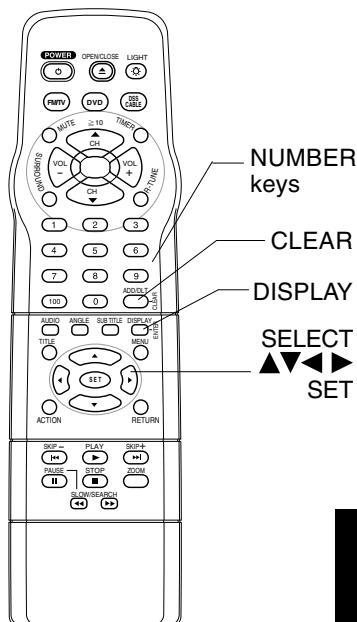

Notes

- When DISPLAY is pressed during playback of a Video CD with Playback control, the NUMBER keys are not available on the displayed screen. In this case, press DISPLAY again to remove the displayed screen.
- When ⊘ appears on the screen while a button is being operated, it means that the corresponding operation is prohibited by the unit or the disc.

DVD Operation using On-Screen Displays (continued)

Detailed Descriptions of Each On-Screen Display

Disc information screen (for DVD)

1. TITLE No.

- Change the No. by **pressing ▲▼*** or the **NUMBER keys**, and **press SET**.

2. Chapter No.

- Change the No. by **pressing ▲▼** or the **NUMBER keys**, and **press SET**.

3. Disc currently being played

4. Elapsed playing time

The screen may be changed by selecting the elapsed time.

- Change the elapsed time by **pressing NUMBER keys**, and **press SET**.

(e.g.) 01 : 23 : 45 0 → 1 → 2 → 3 → 4 → 5

- This function does not work with some discs.

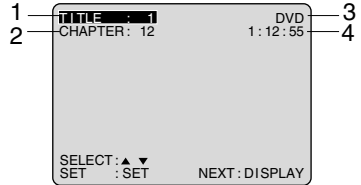

Disc information screen (for Video CD/ CD)

A. Track No.

- Change the No. by **pressing ▲▼** or the **NUMBER keys**, and **press SET**.

B. Playback control ON/OFF

[Video CD with playback control only]

ON	Video CD menu play is displayed.
OFF	Video CD menu play is cleared.

C. Disc currently being played

Video CD	CD
----------	----

D. Elapsed playing time

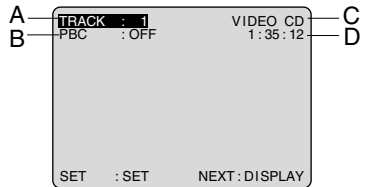

Notes

- Track No. and elapsed playing time are not displayed during play started from menu of Video CDs with playback control.
- When  appears on the screen while a button is being operated, it means that the corresponding operation is prohibited by the unit or the disc.

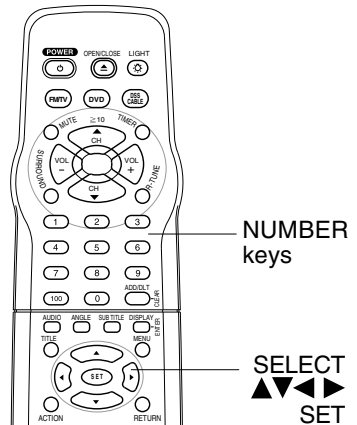

*Important: If a remote control button does not work when pressed, press the DVD button on the remote and try the button again.

Detailed Descriptions of Each On-Screen Display

Unit information screen

- Change the desired mode during play by **pressing ▲▼**, and **press SET**.

a. Repeat Play

DVD	CHAPTER REPEAT	TITLE REPEAT	REPEAT OFF
Video CD/CD	TRACK REPEAT	DISC REPEAT	REPEAT OFF

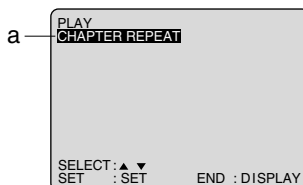

b. Play mode [Video CD/ CD only] (See page 39 or 40.)

PROGRAM PLAY	program play
RANDOM PLAY	random play
----	normal play



For your reference

- CHAPTER/TITLE REPEAT PLAY (DVD)

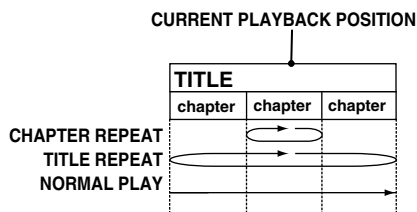

- TRACK/DISC REPEAT PLAY (Video CD/CD)

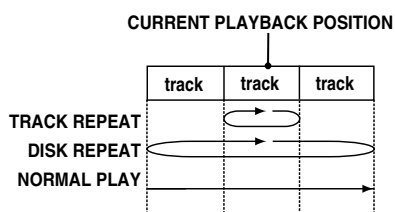

MP3 Playback Operation

MP3 Playback

You can use this unit to play MP3 format audio recorded for personal use with a computer etc. onto a CD-R or CD-RW. Play may not be possible in some cases due to the condition of the recording.

- 1 Press **POWER*** on the remote or unit.
- 2 Press **OPEN/CLOSE**, and then place a MP3 disc into the disc tray. Press **OPEN/CLOSE** to close.
- 3 MP3 MENU is displayed and playback is started automatically. (The MP3 CD directory is displayed.)

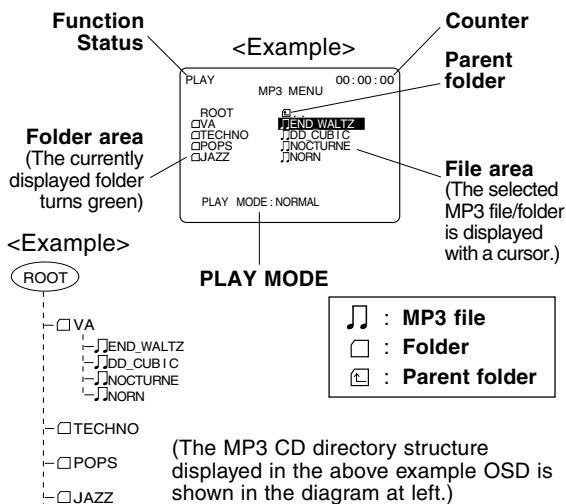

- **Forward/Reverse Search**
Press **FF/SLOW+** or **REW/SLOW-** during play. Press **PLAY** to release.
 - Search speed, slow at first, increases with each additional press of the button up to 4 levels.
- **Forward/Reverse Track Skip**
Press **SKIP ►►** or **◄◄ SKIP** during play. Each press skips a track.
 - If pressed within first 3 seconds of playback, skips to the previous track. If over 3 seconds, returns to first track. (**◄◄ SKIP** only.)
 - Only the **SKIP ►►** or **◄◄ SKIP** button can be used for track skip selection during playback. Put unit in Stop mode before performing folder/file selection (see above right.)

- 4 Press **STOP** to stop playing.

- 5 Press **OPEN/CLOSE** to eject the disc. The MP3 MENU is closed automatically.

- **MP3 playback** (During STOP mode)
 - 1) Press **▲▼** to select an MP3 file (🎵).
 - 2) Press **SET** or **PLAY** to start playback.
- **Select folder** (During STOP mode)
 - 1) Press **▲▼** to select a folder (□).
 - 2) Press **SET** to display files/folders contained in the folder.
- **Select parent folder** (During STOP mode)
 - 1) Press **▲▼** to select a folder (◻).
 - 2) Press **SET** to make changes to the previous directory display.

Note

- Folder area operation cannot be done. Only file area operation is possible.

- **Select PLAY MODE** (During STOP mode)
 - 1) Press **◄►** to move cursor to PLAY MODE.
 - 2) Press **▲▼** to select the desired PLAY MODE (see below).

[PLAY MODE]

NORMAL:

All MP3 files are selected and played back one time only.

SINGLE REPEAT:

The selected MP3 file is played back repeatedly.

FOLDER REPEAT:

The MP3 files contained in the selected folder are played back repeatedly. However, folders below the selected folder are not played back.

DISC REPEAT:

All MP3 files are played back repeatedly.

DVD Lock Feature

*Important: If a remote control button does not work when pressed, press the FM/TV, DVD button on the remote and try the button again.

You can prevent playback of DVDs with a specific rating level which may be unsuitable for children.

- Some DVDs are encoded with a rating level. If the disc rating is higher (stricter) than the one you preset, playback will be prohibited.

Caution

Discs not encoded with a rating level will play even if the jacket states it is for mature audiences. For these discs, the DVD Lock Ratings will not work.

DVD Lock Ratings (DVD only)

Perform DVD Lock setting in TV mode.
Enter your secret code to display LOCK menu.
(Perform "Enter Secret Code" steps on page 30.)

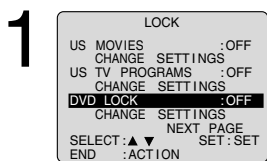

- 1) Press ▲▼ to select "DVD LOCK."
- 2) Press SET to set "ON" or "OFF."

- "ON" → DVD Lock is activated.
- "OFF" → DVD Lock is deactivated.

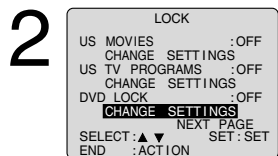

- 1) Press ▲▼ to select "CHANGE SETTINGS."
- 2) Press SET to display screen.

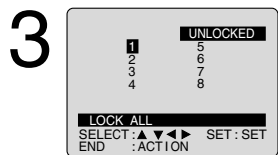

- 1) Press ▲▼◀▶ to select rating level.
- 2) Press SET to select "LOCKED" or "UNLOCKED."

LEVEL 1 : LOCK ALL:

Playback of all DVDs, CDs and Video CDs is prohibited. (Use to prohibit play of mature theme DVDs not encoded with a rating level.)

LEVEL 2 : DVDs expressly for children can be played back.

LEVEL 3 to 7 :

DVDs for general audiences/children can be played back. (DVDs with mature content are prohibited.)

LEVEL 8 : NO LIMIT: (Factory preset)

All DVDs can be played back.

- Ratings which are highlighted in Green will be blocked; those not highlighted (white letters) will not be blocked.

4 Press ACTION three times to end setup.

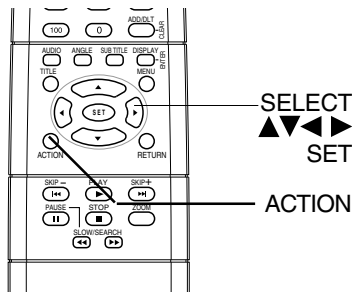

<When DVD Lock is activated>

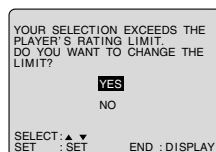

After DVD Lock is set and a blocked DVD is played, this message will appear. The message may differ depending on the disc.

To continue viewing a blocked program for now,

Press ▲▼ to select "YES" and SET. Then, enter your 4-digit secret code. When "NO" is selected, blocked programs cannot be viewed.

To change DVD LOCK settings

After entering your secret code in step 3 on page 30, select "OFF" to deactivate DVD Lock or change the rating level.

Settings for DVD Operation

- 1** Press **ACTION*** in Stop mode to display **MAIN MENU**.

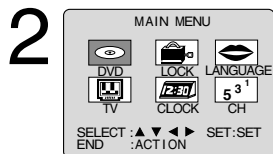

- 1) Press **▲▼◀▶** to select "DVD."
- 2) Press **SET** to display screen.



- 1) Press **▲▼** to select an item.
- 2) Press **SET** to set.

DISC LANGUAGES (See below.)

Any languages offered on the disc can be set. If a language not offered is set, the original disc language will be selected.

AUDIO OUTPUT (See page 47.)

You can set the audio output that comes from the digital audio output terminal.

STILL MODE (See page 48.)

To select "FIELD" or "FRAME" to prevent jitter or to make small text or fine patterns clearly visible in a still picture. When "AUTO" is set, "FIELD" or "FRAME" is selected automatically.

TV MODE (See page 48.)

To select whether the video material for a wide-screen will be played back in Pan & Scan style or in Letterbox style.

DISC LANGUAGES (DVD only)

To select and set the language of the audio soundtrack, subtitles, or title/DVD menus for all discs to be played.



- 1) Press **▲▼** to select "DISC LANGUAGES."
- 2) Press **SET** to display screen.



- 1) Press **▲▼** to select an item.
- 2) Press **SET** repeatedly for desired language. (Please refer right.)

- 6** Press **ACTION** to redisplay DVD menu and go to step 3 to setup another item. Or, press **ACTION** three times to exit.

46

Once initial settings are done, they remain in memory (even after the power is off) until changed. This means the unit will always operate under the same conditions (especially DVDs) each time.

Ready Checklist

- Unit is in TV mode, press FM/TV.

"AUDIO" selections

To select the audio soundtrack language. (factory preset: English)

English/Spanish/French/Japanese

Original: Original disc language

OTHER **:** Other language selection*1

"SUBTITLE" selections

To select the subtitle language.

(Factory preset: AUTO)

AUTO: Same language selected for "AUDIO"

- If language set for "AUDIO" is used in playback, subtitles will not appear.
- If another language is used during playback, the subtitles will appear in the language selected at "AUDIO" setup.

English/Spanish/French/Japanese

OTHER **:** Other language selection*1

"MENU" selections

(factory preset: English)

To select the language used in title menus or DVD menus.

English/Spanish/French/Japanese

OTHER **:** Other language selection*1

To enter **OTHER ****** code number, Press number keys (Please refer to language codes on page 49).

To make corrections, press **◀** repeatedly to delete language code number, and correct.

*1 If the selected language is not offered, the original disc language is selected.

*Important: If a remote control button does not work when pressed, press the FM/TV, DVD button on the remote and try the button again.

AUDIO OUTPUT

Select the digital output to be output from the optical digital audio output connector of the unit.

1 Do steps 1 and 2 on page 46.



- 1) Press ▲▼ to select "AUDIO OUTPUT."
- 2) Press SET to display screen.

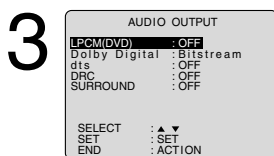

- 1) Press ▲▼ to select an item.
- 2) Press SET repeatedly for output. (See below.)

■ "LPCM (DVD)" selections

OFF: Linear PCM of less than 48 kHz/16 bit is output. When playing DVDs recorded in linear PCM of over 48 kHz/20 bit or 96 kHz, no digital audio is output. (Factory preset)

PCM: When playing DVDs recorded in linear PCM of 48 kHz/20 bit/24 bit or 96 kHz, digital audio converted to 48 kHz/16 bit is output. (Digital output of PCM audio is restricted to 48 kHz/16 bit or below for copyright protection.)

■ "Dolby Digital" selections

Bitstream: Dolby Digital bitstream (1ch-5.1ch) is output. (Factory preset)

OFF: No output.

■ "dts" selections

Bitstream: dts bitstream is output. (Factory preset)

OFF: No output.

■ "DRC (Dynamic Range Compression)" selections

OFF: Normal audio range is selected. (Factory preset)

ON: For dynamic sound even at low volume, this is useful for late-night listening. [Dolby Digital DVDs only].

■ "SURROUND" selections

Surround Sound creates the effect of sound coming from non-existent rear speakers even when only connected to a 2-channel stereo system.

OFF: No Surround Sound effect. (Factory preset)

ON: Surround Sound effect.

4 Press ACTION to redisplay DVD menu and go to step 2 to setup another item. Or, press ACTION three times to exit.

Type of amplifier to be connected	Recommended setting		
	LPCM (DVD)	Dolby Digital	dts
No amplifier is connected	OFF	OFF	OFF
AV amplifier (with digital audio input connector) without Dolby Digital/dts decoder	PCM*1	OFF*2	OFF*2
AV amplifier including Dolby Digital decoder	PCM*1	Bitstream	OFF
AV amplifier including Dolby Digital/dts decoder	PCM*1	Bitstream	Bitstream*3

- Make settings according to amplifier connected to optical audio output as shown in above table.
- When a dts decoder is not connected, to enjoy dts DVD, please select audio output other than dts on the dts DVD menu screen. Otherwise, there will be no sound from the unit speakers.

*1 Audio output from unit is converted to 48 kHz/16 bit in addition to audio from digital audio output.

To enjoy high quality sound at 48 kHz/20 bit /24 bit or 96 kHz, connect the amplifier or decoder directly to the audio output connectors, not to the digital audio output connector. [Select "OFF" at the "LPCM (DVD)"].

*2 When connecting an amplifier (with an optical digital input connector) which does not contain the Dolby Digital or dts decoder, be sure to select "OFF". If "Bitstream" is selected, starting DVD play may cause such a high level of noise as to be harmful to your ears and damage the speakers.

*3 When a dts decoder is connected, please select "Bitstream" in "dts". If "OFF" is selected, there will be no sound.

Notes

- Turn off other surround effects when using this surround effect.
- For optimum effect, the distance between the unit and the listener should be about 3 or 4 times the distance between the right and left front speakers.

Settings for DVD Operation (continued)

STILL MODE

Set to reduce jitter in a displayed still picture or a motion picture.

1 Do steps 1 and 2 on page 46.



1) Press ▲▼* to select "STILL MODE."

2) Press SET repeatedly for mode. (See below)

AUTO: "FIELD" (Field still) or "FRAME" (Frame still) is automatically selected during the still mode. (Factory preset)

FIELD: "FIELD" (Field still) is always selected. This setting will reduce jitter when compared with "AUTO" on some discs.

FRAME: "FRAME" (Frame still) is always selected. Some texts and fine patterns will be seen clearly when compared with "AUTO" on some discs.

3 Press ACTION twice to exit this mode.

Selecting TV MODE

Set the screen display style for widescreen video material playback.

a Do steps 1 and 2 on page 46.

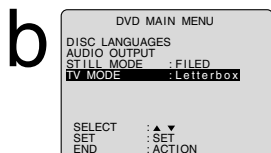

1) Press ▲▼ to select "TV MODE."

2) Press SET repeatedly for mode. (See below.)

Pan & Scan : Widescreen video data is played in Pan & Scan style (left and right of screen is trimmed.)

- Video data not formatted in Pan & Scan will play in letterbox style.

Letterbox : Widescreen video data is played in Letterbox style (top and bottom of screen has black margin).

C Press ACTION twice to exit this mode.

*Important:

If a remote control button does not work when pressed, press the DVD button on the remote and try the button again.

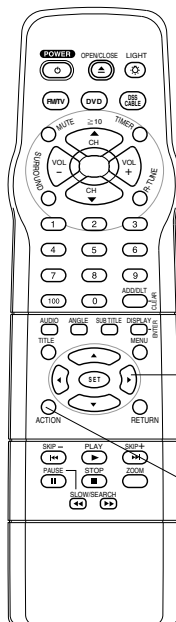

Example

- Pan & Scan (Factory preset)

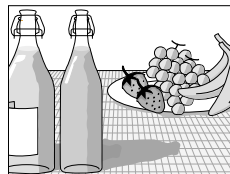

- Letterbox

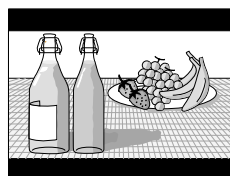

Language Code List

Enter the appropriate code number for the initial settings “AUDIO”, “SUBTITLE” and/or “MENUS” (see page 46).

Code	Language	Code	Language	Code	Language	Code	Language
6565	Afar	7079	Faroese	7678	Lingala	8375	Slovak
6566	Abkhazian	7082	French	7679	Laothian	8376	Slovenian
6570	Afrikaans	7089	Frisian	7684	Lithuanian	8377	Samoan
6577	Ameharic	7165	Irish	7686	Latvian, Lettish	8378	Shona
6582	Arabic	7168	Scots Gaelic	7771	Malagasy	8379	Somali
6583	Assamese	7176	Galician	7773	Maori	8381	Albanian
6588	Aymara	7178	Guarani	7775	Macedonian	8382	Serbian
6590	Azerbaijani	7185	Gujarati	7776	Malayalam	8385	Sundanese
6665	Bashkir	7265	Hausa	7778	Mongolian	8386	Swedish
6669	Byelorussian	7273	Hindi	7779	Moldavian	8387	Swahili
6671	Bulgarian	7282	Croatian	7782	Marathi	8465	Tamil
6672	Bihari	7285	Hungarian	7783	Malay	8469	Telugu
6678	Bengali; Bangla	7289	Armenian	7784	Maltese	8471	Tajik
6679	Tibetan	7365	Interlingua	7789	Burmese	8472	Thai
6682	Breton	7378	Indonesian	7865	Nauru	8473	Tigrinya
6765	Catalan	7383	Icelandic	7869	Nepali	8475	Turkmen
6779	Corsican	7384	Italian	7876	Dutch	8476	Tagalog
6783	Czech	7387	Hebrew	7879	Norwegian	8479	Tonga
6789	Welsh	7465	Japanese	7982	Oriya	8482	Turkish
6865	Danish	7473	Yiddish	8065	Panjabi	8484	Tatar
6869	German	7487	Javanese	8076	Polish	8487	Twi
6890	Bhutani	7565	Georgian	8083	Pashto, Pushto	8575	Ukrainian
6976	Greek	7575	Kazakh	8084	Portuguese	8582	Urdu
6978	English	7576	Greenlandic	8185	Quechua	8590	Uzbek
6979	Esperanto	7577	Cambodian	8277	Rhaeto-Romance	8673	Vietnamese
6983	Spanish	7578	Kannada	8279	Romanian	8679	Volapük
6984	Estonian	7579	Korean	8285	Russian	8779	Wolof
6985	Basque	7583	Kashmiri	8365	Sanskrit	8872	Xhosa
7065	Persian	7585	Kurdish	8368	Sindhi	8979	Yoruba
7073	Finnish	7589	Kirghiz	8372	Serbo-Croatian	9072	Chinese
7074	Fiji	7665	Latin	8373	Singhalese	9085	Zulu

Before Requesting Service

Check the following points once again if you are having trouble with your unit.

Power	Correction
No power...	<ul style="list-style-type: none">• Completely insert Power Plug into an AC outlet.• Set POWER button to ON.
Power turns itself off...	<ul style="list-style-type: none">• Auto power-off (shutoff) occurs after about 5 min. in DVD mode with no operation, or if there is no broadcast signal in TV mode. Turn the power back on. (P. 17, 28)
Monitor	Correction
No picture or sound...	<ul style="list-style-type: none">• Make sure your antenna system (TV or CABLE), is correctly set. (P. 10)• Completely insert Power Plug into an AC outlet.• Set POWER button to ON.
Poor picture with normal sound...	<ul style="list-style-type: none">• Adjust BRIGHTNESS, SHARPNESS, and PICTURE controls in the SET UP Video Adjustment. (P. 35)
Poor sound with normal picture...	<ul style="list-style-type: none">• Adjust VOLUME control. (P. 18)
Poor TV reception...	<ul style="list-style-type: none">• Adjust SHARPNESS and PICTURE controls in the SET UP Video Adjustment. (P. 35)
No color or poor color...	<ul style="list-style-type: none">• Adjust TINT and COLOR controls in the SET UP Video Adjustment. (P. 35)
Ghost (multiple) images...	<ul style="list-style-type: none">• Install a directional antenna.
TV programs cannot be watched...	<ul style="list-style-type: none">• Make sure the selected channel is in unit's memory. (P. 12)
Remote Control	Correction
Unit cannot be controlled...	<ul style="list-style-type: none">• Aim Remote directly at the remote sensor on the unit. (P. 9)• Avoid any object blocking signal path.• Inspect the remote batteries. (P. 4)• Exposing unit remote sensor to direct fluorescent or outdoor light may cause signal interference.
ACTION, SELECT, SET, POWER, etc. buttons cannot be selected...	<ul style="list-style-type: none">• Press FM/TV for TV mode. (P. 26)• Press DVD for DVD mode. (P. 26)• Press FM/TV for FM mode. (P. 26)• Check remote batteries.

If you cannot resolve the problem, please call the Customer Call Center for product assistance at 1-800-211-PANA (7262.)

To locate an authorized servicenter, please call toll free 1-800-211-PANA (7262.) or send e-mail to : consumerproducts@panasonic.com

DVD/Video CD/CD	Correction
Play fails to start even when PLAY is pressed...	<ul style="list-style-type: none"> • This unit cannot play discs other than DVDs, Video CDs and CDs. • The disc may be dirty and require cleaning.
Play starts but then stops immediately...	<ul style="list-style-type: none"> • Be sure disc is installed with label side up.
Picture is distorted during rapid advance or rapid reverse...	<ul style="list-style-type: none"> • The picture will be somewhat distorted at times: this is normal.
No Forward/Reverse search play...	<ul style="list-style-type: none"> • Some discs may have sections which prohibit Forward/Reverse search. (P. 17)
Play does not start even when title is selected...	<ul style="list-style-type: none"> • Confirm the "DVD LOCK" setting. (P. 45)
Audio soundtrack and/or subtitle language is not the one selected at the initial settings...	<ul style="list-style-type: none"> • If the audio soundtrack and/or subtitle language selected at DVD initial settings does not exist on the disc, it will not be accessible.
No subtitles...	<ul style="list-style-type: none"> • Subtitles appear only when available on disc. • Select "ON" at the "Changing subtitle language" section (P. 36) to display subtitles.
Alternative audio soundtrack (or subtitle) language cannot be selected...	<ul style="list-style-type: none"> • Alternative language cannot be selected with discs which do not contain more than one language. • For some discs, alternative language cannot be selected with the AUDIO or SUB TITLE button. Try selecting it from the DVD menu if available.
Angle cannot be changed...	<ul style="list-style-type: none"> • This function is dependent on software availability. Even if disc has multiple angles, they may be recorded for specific scenes only (ANGLE Indicator on unit lights up). (P. 37)
Miscellaneous	Correction
The disc cannot be removed...	<ul style="list-style-type: none"> • First, unplug unit. Then, prepare a rigid wire (e.g. an extended paper clip, etc.) and, applying moderate force, insert it straight into the hole at the base of the tray. The tray will eject a little. Now, pull the tray all the way out and remove the disc. (P. 6)

Warning and Instruction Displays

These displays will alert you of a missed operation or provide further instructions.

OSD	Caution	Page
PLEASE SET CLOCK BEFORE TIMER SETTING	<ul style="list-style-type: none"> • If you attempt to set the On-Timer and the Clock is not set... 	12
PLEASE CHECK THE DISC, AND FOR STAINS OR SCRATCHES ON DISC	<ul style="list-style-type: none"> • If you press PLAY, or the unit reads data from a stained or scratched disc in DVD mode. Also, if the type of disc is other than DVD, Video CD or CD... 	7

Limited Warranty

PANASONIC CONSUMER ELECTRONICS COMPANY,
DIVISION OF MATSUSHITA ELECTRIC
CORPORATION OF AMERICA
One Panasonic Way Secaucus, New Jersey 07094

PANASONIC SALES COMPANY, DIVISION OF MATSUSHITA
ELECTRIC OF PUERTO RICO, INC.,
AVE. 65 de Infantería, Km. 9.5 San Gabriel Industrial Park,
Carolina, Puerto Rico 00985

Panasonic/Quasar Video Products Limited Warranty

Limited Warranty Coverage

If your product does not work properly because of a defect in materials or workmanship, Panasonic Consumer Electronics Company or Panasonic Sales Company (collectively referred to as "the warrantor") will, for the length of the period indicated on the chart below, which starts with the date of original purchase ("warranty period"), at its option either (a) repair your product with new or refurbished parts, or (b) replace it with a new or a refurbished product. The decision to repair or replace will be made by the warrantor.

Product	Parts	Labor	Service	Contact Number
Camcorder	One (1) Year (except CCD Image Sensor) CCD Image Sensor - 6 (Six) Months	Ninety (90) Days Ninety (90) Days	Carry-In or Mail-In	1-800-211-PANA(7262)
DVD/VCR Deck, AV Mixer	One (1) Year	Ninety (90) Days	Carry-In or Mail-In	1-800-211-PANA(7262)
TV/VCR, TV/DVD, TV/DVD/VCR Combination	One (1) Year (except CRT) CRT - Two (2) Years	Ninety (90) Days Ninety (90) Days	Carry-In: 21" CRT and Smaller In-Home or Carry-In: 22" CRT and Larger	1-800-211-PANA(7262)
TV/HDR Combination	One (1) Year (except CRT) CRT - Two (2) Years	Ninety (90) Days Ninety (90) Days	In-Home or Carry-In	1-888-843-9788
Rechargeable Batteries (in exchange for defective item)	Ten (10) Days	Not Applicable	Carry-In or Mail-In	1-800-211-PANA(7262)
Tape (in exchange for defective item)	Five (5) Days	Not Applicable	Carry-In or Mail-In	1-800-211-PANA(7262)
Memory Cards (in exchange for defective item)	Ninety (90) Days	Not Applicable	Carry-In or Mail-In	1-800-211-PANA(7262)

During the "Labor" warranty period there will be no charge for labor. During the "Parts" warranty period, there will be no charge for parts. You must carry-in or mail-in your product or arrange for in-home service, as applicable, during the warranty period.

If non-rechargeable batteries are included, they are not warranted. This warranty only applies to products purchased and serviced in the United States or Puerto Rico. This warranty is extended only to the original purchaser of a new product which was not sold "as is". A purchase receipt or other proof of the original purchase date is required for warranty service.

Carry-In, Mail-in or In-Home Service

For Carry-In, Mail-In or In-Home Service (as applicable) in the United States call toll free contact number listed above or visit Panasonic Web Site: <http://www.panasonic.com>

For assistance in Puerto Rico call Panasonic Sales Company (787)-750-4300 or fax (787)-768-2910.

In-Home service, if applicable, requires clear, complete and easy access to the product by the authorized servicer and does not include removal or re-installation of an installed product. It is possible that certain in-home repairs will not be completed in-home, but will require that the product, or parts of the product, be removed for shop diagnosis and/or repair and then returned.

Limited Warranty Limits And Exclusions

This warranty ONLY COVERS failures due to defects in materials or workmanship, and DOES NOT COVER normal wear and tear or cosmetic damage, nor does it cover markings or retained images on the picture tube resulting from viewing fixed images (including, among other things, letterbox pictures on standard 4:3 screen TV's, or non-expanded standard 4:3 pictures on wide screen TV's, or onscreen data in a stationary and fixed location). The warranty ALSO DOES NOT COVER damages which occurred in shipment, or failures which are caused by products not supplied by the warrantor, or failures which result from accidents, misuse, abuse, neglect, mishandling, misapplication, alteration, faulty installation, set-up adjustments, misadjustment of consumer controls, improper maintenance, power line surge, lightning damage, modification, or commercial use (such as in a hotel, office, restaurant, or other business), rental use of the product, service by anyone other than a Factory Servicenter or other Authorized Servicer, or damage that is attributable to acts of God.

THERE ARE NO EXPRESS WARRANTIES EXCEPT AS LISTED UNDER "LIMITED WARRANTY COVERAGE". THE WARRANTOR IS NOT LIABLE FOR INCIDENTAL OR CONSEQUENTIAL DAMAGES RESULTING FROM THE USE OF THIS PRODUCT, OR ARISING OUT OF ANY BREACH OF THIS WARRANTY. (As examples, this excludes damages for lost time, cost of having someone remove or re-install an installed unit if applicable, or travel to and from the servicer, loss of media or images, data or other memory or recorded content. The items listed are not exclusive, but are for illustration only.) **ALL EXPRESS AND IMPLIED WARRANTIES, INCLUDING THE WARRANTY OF MERCHANTABILITY, ARE LIMITED TO THE PERIOD OF THE LIMITED WARRANTY.**

Some states do not allow the exclusion or limitation of incidental or consequential damages, or limitations on how long an implied warranty lasts, so the exclusions may not apply to you.

This warranty gives you specific legal rights and you may also have other rights which vary from state to state. If a problem with this product develops during or after the warranty period, you may contact your dealer or Servicenter. If the problem is not handled to your satisfaction, then write to the warrantor's Consumer Affairs Department at the addresses listed for the warrantor.

PARTS AND SERVICE (INCLUDING COST OF AN IN-HOME SERVICE CALL, WHERE APPLICABLE) WHICH ARE NOT COVERED BY THIS LIMITED WARRANTY ARE YOUR RESPONSIBILITY.

Customer Services Directory

*For Product Information, Operating Assistance, Literature Request, Dealer Locations, and all Customer Service inquiries please contact:
1-800-211-PANA (7262), Monday-Friday 9 am-9 pm; Saturday-Sunday 9 am-7 pm, EST.
or send e-mail : consumerproducts@panasonic.com*

*Web Site: <http://www.panasonic.com>
You can purchase parts, accessories or locate your nearest servicenter by visiting our Web Site.*

Accessory Purchases:

1-800-332-5368 (Customer Orders Only)
Panasonic Services Company 20421 84th Avenue South, Kent, WA 98032
(Monday-Friday 6 am-5 pm; Saturday 6 am-10:30 am, PST)
(Visa, MasterCard, Discover Card, American Express, Check)

Service in Puerto Rico

*Matsushita Electric of Puerto Rico, Inc. Panasonic Sales Company/ Factory Servicenter:
Ave. 65 de Infantería, Km. 9.5, San Gabriel Industrial Park, Carolina, Puerto Rico 00985
Phone (787)750-4300 Fax (787)768-2910*

Spanish Quick Use Guide/Guía para rápida consulta

Conecte por favor todas las conexiones del cable o de la antena antes de turing potencia.

Conectando

Para Ant./Cable

Conecte Ant./Cable a la entrada de antena de la TV (VHF/UHF).

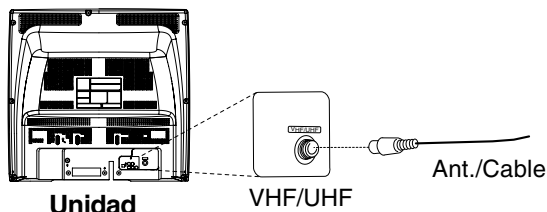

Para Sistema Digital de Satelite (DSS)/Convertidor de cable

Conecte la salida del convertidor de cable la "VHF/UHF" con el RF cable.

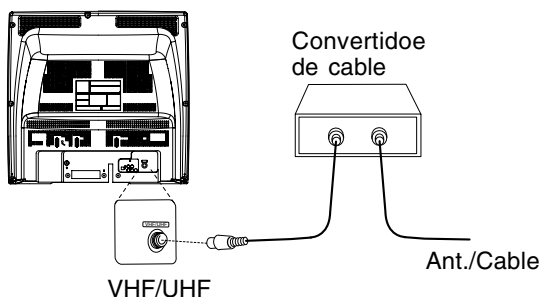

Realizando Configuración Inicial

1 Tape el cable electrico de la unidad en el enchufe de pared de la CA.

2 POWER de la prensa en el telecontrol o la unidad.

La unidad se adelanta y comienzo auto del canal y del reloj.

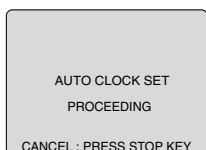
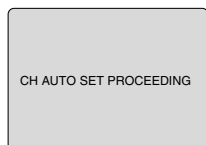

Si usa convertidor de cable, enciendala y seleccione el Servicio Publico de Canales de Television (PBS) en su horario de uso o tiempo de su zona. Si utiliza receptor DSS este debe de estar apagado.

3 Selecciones se realizaran automaticamente cuando la configuracion termine, la pantalla siguiente aparecera.

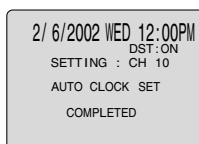

Si "AUTO CLOCK SET IS INCOMPLETE" aparece en pantalla, coloque el tiempo usando el procedimiento manual (MANUAL CLOCK SET). Vea el "Ajuste Manual del Reloj" en la proxima pagina.

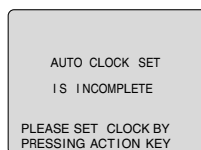

Ajuste Manual del Reloj

Si el ajuste automático del reloj no se ha completado, ajuste el reloj manualmente de la siguiente manera.

1 Presione la tecla ACTION en el control remoto para visualizar la pantalla del menú RELOJ.

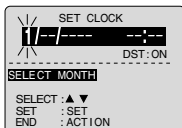

2 Presione ▲▼ para seleccionar el mes y SET para ajustar. De la misma forma, seleccione y ajuste la fecha, año, hora y DST (Hora de Verano).



3 Presione dos veces la tecla ACTION para poner el RELOJ en marcha y salir.

Ajustar de nuevo el reloj

1 Presione ACTION para exhiba el menú.

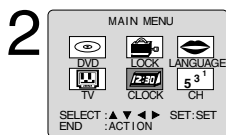

Presione ▲▼◀▶ para seleccionar "RELOJ".
Presione SET.

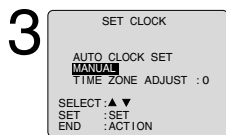

Presione ▲▼ para seleccionar "MANUAL" y luego presione SET.

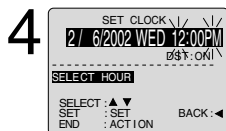

Presione ▲▼ y SET para seleccionar y ajustar la hora y la fecha.

5 Presione ACTION dos veces para que el reloj comience a funcionar y salir desde este modo.

Operaciones básicas del DVD

1 Presione POWER en el control remoto o el aparato.

2 Introducir un disco.

1) Presione OPEN/CLOSE.

2) Ponga un disco en la bandeja de disco.

- Sujete el disco sin tocar ninguna de sus superficies, póngalo con el lado donde esté impreso el título hacia arriba, alinéelo con las guías y póngalo en su posición apropiada.

❶ Disco de 3" (8 cm) ❷ Disco de 5" (12 cm)

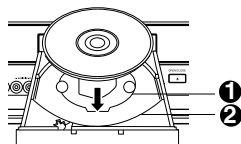

3 Iniciar la reproducción

Presione PLAY.

La bandeja del disco se cierra automáticamente.

- Si está usando un DVD interactivo (Interactive DVD) o un Vídeo CD con control de reproducción (playback control) y aparece un menú de títulos (TITLE MENU) en la pantalla, siga al paso 5.

4 Elija el artículo deseado.

1) Presione ▲▼◀▶ o las teclas numéricas.

2) Presione SET para la reproducción.

Si usa las teclas numéricas, la reproducción comienza automáticamente.

5 Parar la reproducción.

Presione STOP.

6 Expulsar el disco.

Presione OPEN/CLOSE.

■ Para buscar una escena particular

Búsqueda hacia adelante

Presione SLOW ▶▶ en el modo de reproducción.

Búsqueda hacia atrás

Presione SLOW ◀◀ en el modo de reproducción.

(Para liberar, presione PLAY)

■ Para saltar un capítulo o una pista

Salto hacia adelante

Presione SKIP ▶▶I en el modo de reproducción.

Un capítulo (DVD) o una pista (Vídeo CD/CD) se salta cada vez que se oprime la tecla.

Salto hacia atrás

Presione I◀◀ SKIP en el modo de reproducción.

■ Para ver una imagen fija

Presione PAUSE durante la reproducción.

(Para liberar, presione PLAY)

■ Para ver imágenes cuadro a cuadro (DVD/Vídeo CD)

Presione PAUSE en el modo de imagen fija. La imagen avanza un cuadro cada vez que presiona la tecla.

(Para volver a la reproducción normal, presione PLAY.)

■ Para ver en cámara lenta (DVD/Vídeo CD)

Presione SLOW ▶▶ o SLOW ◀◀ en el modo de imagen fija.

(Para liberar, presione PLAY)

Cambio del idioma de subtítulos [DVD solamente]

El idioma de los subtítulos seleccionado al hacer las fijaciones iniciales se puede cambiar por otro idioma diferente, si éste se encuentra disponible.



Presione SUBTITLE durante la reproducción.

- Cuando no haya subtítulos grabados, “-” se visualizará en lugar del número de idioma.



Seleccionar el idioma deseado.

- 1) Presione ▲▼ para seleccionar idioma.
- 2) Presione ► (o ◀) para ajustar.
- 3) Presione ▲ (o ▼) para seleccionar “ACTIVO” o “INACTIVO.”

Selección de vocal para los discos de Karaoke [DVD/Video CD]

1 Visualizar la pantalla AUDIO.

Presione AUDIO durante la reproducción.

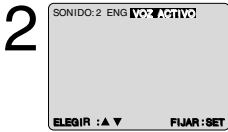

Seleccionar el ajuste deseado.

- 1) Presione ▲▼ (o ◀►) para seleccionar.
- 2) Presione ► (o ◀) para ajustar. (DVD solamente)

- DVD Karaoke (1 vocal) VOCAL ON→VOCAL OFF
- DVD Karaoke (2 vocales) VOCAL V1+V2→VOCAL→V1VOCAL V2→VOCAL OFF
- Video CD LR→L→R

Cambio del idioma de la pista de sonido [DVD solamente]

El idioma de la pista de sonido seleccionado al hacer las fijaciones iniciales se puede cambiar por otro idioma diferente, si éste se encuentra disponible.



Visualizar la pantalla AUDIO.

Presione AUDIO durante la reproducción.



Seleccionar el idioma deseado.

Presione ▲▼ para seleccionar idioma.

Utilización de un menú de DVD [DVD solamente]

Algunos discos DVD tienen estructuras únicas de menús llamadas menús DVD. Por ejemplo, los DVDs programados con un contenido complejo proporcionan menús guía, y los grabados con varios idiomas proporcionan menús para audio e idiomas de subtítulos. Aunque los contenidos de los menús DVD y la operación cambian de disco a disco, a continuación se explica la operación básica cuando se utiliza esta característica.

1 Presione MENU durante la reproducción.

El menú de DVD introducido en el disco se visualiza ahora.

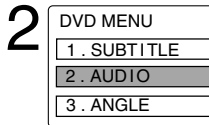

Seleccionar el ítem deseado.

- 1) Presione ▲▼ ◀► o las teclas numéricas para seleccionar.
- 2) Presione SET o PLAY.

Utilización de un menú de títulos [DVD solamente]

Algunos discos con películas, por ejemplo, vienen con dos o más títulos. Si el disco tiene un menú de títulos grabados, el botón TITLE podrá utilizarse para seleccionar el título de la película.

1 Presione TITLE durante la reproducción.

Ahora se visualiza una lista de los títulos del disco.

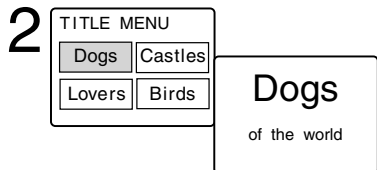

Seleccionar el título deseado.

- 1) Presione ▲▼ ◀► o las teclas numéricas seleccionar.
- 2) Presione SET o PLAY.

Visión desde otro ángulo [DVD solamente]

Algunos discos DVD tienen escenas que han sido filmadas simultáneamente desde un número de ángulos diferentes. Con estos discos, la misma escena podrá verse desde cada uno de estos ángulos diferentes utilizando el botón ANGLE.

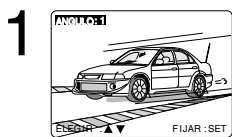

Visualizar la pantalla de ángulo.
Presione ANGLE durante la reproducción.

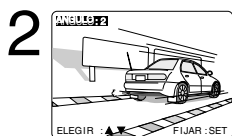

Seleccionar el ángulo deseado.
Presione ▲▼ para seleccionar.

Ampliación de la imagen [DVD solamente]

Durante la reproducción de un DVD, puede ampliar partes específicas de una imagen y seleccionar la relación de zoom usando el botón ZOOM del control remoto.

Seleccione el tamaño de la imagen.
Presione ZOOM repetidamente para cambiar el tamaño de la imagen como se indica a continuación:

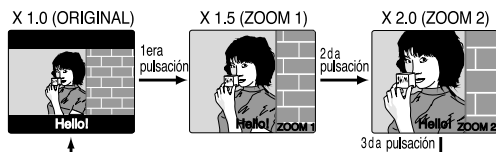

- Use los botones ▲ y ▼ para desplazar la posición hacia arriba o hacia abajo.
- Use los botones ◀ y ▶ para desplazar la posición hacia la izquierda o hacia la derecha.

Funcionamiento del DVD utilizando visualizaciones en pantalla

Cuando se presiona DISPLAY, la visualización en pantalla muestra la información del disco (título / capítulo / número de lista, tiempo transcurrido de reproducción, audio / idioma del subtítulo, y ángulo) e información (repetir la reproducción, modo reproducción, Karaoke vocal encendido / apagado, etc.).

1 Visualizar Visualizaciones en pantalla.

Presione DISPLAY en el modo reproducción o parada.

- Cada vez que se presione DISPLAY, la visualización en pantalla cambia como se muestra a continuación.

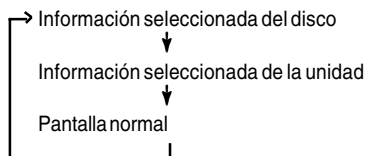

2 Selección del ítem deseado

- 1) Presione ▲▼ (o ◀▶) para seleccionar.
- 2) Presione SET para ajustar

3 <Ejemplo de DVD>



Selección del ajuste deseado

- 1) Presione ▲▼ para seleccionar.
- 2) Presione SET para ajustar.

<Ejemplo de Vídeo CD>



Para volver a la pantalla normal,
Presione repetidamente CLEAR o DISPLAY.

Reproducción programada [Vídeo CD/CD]

Puede usted programar pistas específicas y el orden de reproducción.

- Vídeo CD o CD es insertado en el modo DVD.

1 Visualizar MAIN MENU.

Presione ACTION en el modo parada.

2

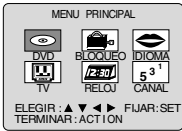

Visualizar la pantalla DVD.

- 1) Presione ▲▼◀▶ para seleccionar "DVD."
- 2) Presione SET para visualizar.

3

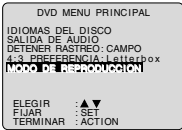

Seleccionar "MODO DE REPRODUCCION."

- 1) Presione ▲▼ para seleccionar.
- 2) Presione SET para visualizar.

4



Seleccionar "REPRODUCCION DE PROGRAMAS."

- 1) Presione ▲▼ para seleccionar.
- 2) Presione SET para visualizar.

5

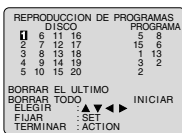

Seleccionar el número de la pista deseada. (Se visualizan los números de la pista del disco).

- 1) Presione ▲▼◀▶ para seleccionar.
- 2) Presione SET para seleccionar.

- Repita el paso 5 para seleccionar otra pista.
- La pista seleccionada se añade a la parte derecha.

6



Comenzar "REPRODUCCION DE PROGRAMAS."

- 1) Presione ▲▼◀▶ para seleccionar "INICIAR."
- 2) Presione SET.

- La reproducción comienza en la secuencia programada.
- Para cancelar, pulsar STOP durante la reproducción y luego presione CLEAR.

Reproducción arbitraria [Vídeo CD/CD]

Las pistas se reproducen de forma arbitraria.

1 Repita los pasos 1-3 de la página anterior.

2

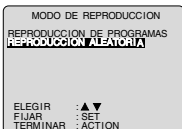

Seleccionar "REPRODUCCION ALEATORIA."

- 1) Presione ▲▼ para seleccionar.
- 2) Presione SET.

- Comienza la reproducción arbitraria.
- Para cancelar, presione STOP durante la reproducción y luego presione CLEAR.

Fijaciones iniciales

1 Visualizar MAIN MENU.

Presione ACTION en el modo de parada.

2 Visualizar la pantalla DVD.

1) Presione ▲▼◀▶ para seleccionar.

2) Presione SET.

3 Seleccionar el artículo deseado.

1) Presione ▲▼ para seleccionar.

2) Presione SET.

IDIOMAS DEL DISCO

Todos los idiomas ofrecidos en el disco pueden ser ajustados. Si el idioma ajustado no es ofrecido en el disco, se seleccionará el idioma original del disco.

SALIDA DE AUDIO

Puede usted ajustar la salida audio procedente del terminal de salida audio digital.

DETENER RASTREO

Para seleccionar "CAMPO" o "CUADRO" para prevenir inestabilidad o para permitir ver textos pequeños o patrones finos claramente en el modo de imagen fija.

4 : 3 PREFERENCIA

Para seleccionar si el material del vídeo para pantalla ancha será vuelto a reproducir en el estilo Pan&Scan o en el estilo Letterbox en la pantalla.

4 Seleccionar el artículo deseado.

1) Presione ▲▼ para seleccionar.

2) Presione SET.

5 Volver a visualizar el menú de DVD para continuar el ajuste.

Presione ACTION y pase al paso 3 para ajustar otro ajuste o, para salir, presione ACTION tres veces.

Selección de IDIOMAS DEL DISCO [DVD solamente]

Seleccione "AUDIO"

Inglés / Español / Francés / Japón: (Fijación de fábrica : inglés)

Original : Se seleccionará el idioma original de cada disco.

OTRO ** :** Se puede seleccionar el otro idioma.

Seleccione "SUBTITULO"

AUTO : Se seleccionará el mismo que fue seleccionado en la preparación de "AUDIO". (Fijación de fábrica)

- Si el idioma seleccionado en la preparación de "AUDIO" se utiliza durante la reproducción, los subtítulos no aparecerán.
- Si se utiliza otro idioma durante la reproducción, los subtítulos aparecerán en el idioma seleccionado en la preparación de "AUDIO"

Inglés / Español / Francés / Japón

OTRO ** :** Se puede seleccionar el otro idioma.

Seleccione "MENU"

Inglés / Español / Francés : (Fijación de fábrica : inglés)

OTRO ** :** Se puede seleccionar el otro idioma.

Selección de SALIDA DE AUDIO

Seleccione "LPCM(DVD)"

INACTIVO : Por el conector de salida de audio digital solamente sale PCM lineal de 48 kHz/16 bits. Durante la reproducción del DVD grabado en el PCM lineal de 48 kHz/20 bits o 96 kHz, no sale audio digital. (Fijación de fábrica)

PCM : Durante la reproducción del DVD grabado en el PCM lineal de 48 kHz/20 bits/24 bits o 96 kHz, sale audio digital convertido a 48 kHz/16 bits. (La salida digital de audio PCM está restringida a 48 kHz/16bits o menos para proteger los derechos de autor.)

Seleccione "Dolby Digital"

Bitstream : Sale un flujo de bits Dolby digital (2ch-5.1ch). (Fijación de fábrica)

INACTIVO : No hay salida de audio.

Seleccione "dts"

Bitstream : Sale un flujo de bits dts. (Fijación de fábrica)

INACTIVO : No hay salida de audio.

Seleccione "DRC (Dynamic Range Compression)"

INACTIVO : Se selecciona el margen de audio normal. (Fijación de fábrica)

ACTIVO : Seleccione este ajuste para disfrutar de un sonido dinámico incluso a bajo volumen. Esto es muy útil para escuchar durante la noche. [Esta función sólo se activa con DVDs Dolby Digital.]

Seleccione "SURROUND"

El sonido envolvente crea el efecto de sonido que procede de altavoces que parecen estar en la parte de atrás aún cuando solo se ha conectado a un sistema estéreo de 2 canales.

INACTIVO : No efecto de sonido envolvente. (Fijación de fábrica)

ACTIVO : Efecto de sonido envolvente.

Selección de DETENER RASTREO

AUTO : Durante el modo de imagen fija se seleccionarán automáticamente "Campo fijo" o "Cuadro fijo" (Fijación de fábrica)

CAMPO : Seleccione este ajuste cuando ocurra "distorsión" en las imágenes, incluso cuando se haya seleccionado "AUTO".

CUADRO : "Cuadro fijo" es siempre seleccionado. Seleccionar este ajuste cuando no se puedan ver claramente texto pequeño o patrones finos incluso cuando esté seleccionado "AUTO".

Selección de 4 : 3 PREFERENCIA

Pan&Scan : Datos de la pantalla ancha de vídeo son reproducidos en el estilo Pan & Scan (la parte derecha e izquierda de la pantalla son recortadas). (Fijación de fábrica)

- Datos de vídeo no formateados en Pan & Scan serán reproducidos en el estilo letterbox.

Letterbox : Datos de la pantalla ancha de vídeo son reproducidos en el estilo Letterbox (la parte de arriba y abajo de la pantalla tienen un margen negro).

Index

TV

- A** Accessories 4
 - AC Power Plug 9
 - ACTION button 8, 12
 - ADD / DLT button 8, 13
 - Audio Adjustment 35
 - Audio Auto Gain Control (AGC) 34
 - AUDIO button 8, 19, 25
 - Audio Connections 14, 15
 - Audio Features 34, 35
 - Audio Menu 34
 - Audio Mode for TV Viewing 19
 - Audio Mute 18
 - Audio / Video Input connector (LINE) 9
 - Audio Output Connector (L/R) 9
 - Auto Operation Functions 28
- B** Batteries 4
 - Before Requesting Service 50, 51
 - Before Using 4
 - Blocking Message 33
 - Blue Screen Display 23
 - Broadcast Types 19
- C** Cable Box Brand Code Number 27
 - Cable Box Universal Remote Control Feature 26
 - Caption On Mute 21
 - Channel 10, 12, 13, 23
 - Channel Caption 29
 - CHANNEL UP / DOWN button 8, 18
 - Clock 12
 - Closed Caption 20, 21
 - Code Numbers, DSS / Cable Box Brand 27
 - Connections 10
 - Connections, Audio 14, 15
 - Connections, DSS / Cable Box 10
 - Connections, Ant./Cable 10
 - Customer Services Directory 53
- D** DISPLAY / ENTER button 8, 23, 26
 - DSS Brand Code Number 27
 - DSS CABLE button 8, 26
 - DSS / Cable Box Connections 10
 - DST (Daylight Saving Time) 11
- F** FM Radio 24, 25
 - FM/TV button 8, 24 ~ 26
 - Front Panel Indicators 9
 - Function Display 23
- I** Important Safeguards and Precautions 2
 - Information (Unit, Disc) 6, 7
 - Initial Setup 10
 - Indicators on the Front Panel 9
 - Input Mode 28
- L** Language 10, 12
 - LIGHT button 8
 - Location of Controls 8, 9
- M** MTS Broadcast / TV Stereo System 19
 - MUTE button 8, 18
- N** NUMBER keys 8, 18
- O** 100 Key 18
 - On-Screen Displays (OSD) 23
 - ON-TIMER Indicator 9, 22
 - ON-TIMER with Alarm 22
 - Outdoor Antenna Connections 10
- P** Phones 18
 - POWER button 8, 10
- R** Rapid Tune 18
 - R-TUNE button 8, 18
 - Remote Control Buttons 8
 - Remote Sensor 9
 - Remote Warning Feature 28
 - Reset Language, Channels, Clock 12
 - Reset unit 11
- S** Safety Precautions 3
 - Secret Code 30
 - SELECT / SET button 8, 12
 - Sleep Timer 22
 - SLEEP TIMER Indicator 9, 22
 - Spanish Quick Use Guide 54 ~ 61
 - Specifications 6
 - SURROUND button 8, 29
 - Surround Sound 29
- T** Table of Contents 5
 - Time Zone Adjust 13
 - TV Operation 18
 - TV Status & Clock Display 23
 - TV Timer Features 22
- U** Unit, Front/Rear view 9
 - Universal Remote Control 26
 - US MOVIES Ratings 31
 - US TV PROGRAMS Ratings 32
- V** Video Adjustment 35
 - Video / Audio Menu 34
 - Video / Audio Adjust 35
 - Video Menu 34
 - V-Chip Control Feature 30 ~ 33
 - VHF / UHF Antenna Input Terminal 9
 - VOLUME UP / DOWN button 8, 18
- W** Warning and Instruction Displays 51
 - Warranty 52, 53
 - Weak Signal Display Feature 28

DVD

- A** ANGLE button 8, 37
- ANGLE Indicator 9, 37
- Auto-Power Off function 17
- AUDIO button 8, 36
- AUDIO OUTPUT 47
- Audio soundtrack language (DVD) 36
- B** Basic DVD Operation 16
- C** CLEAR button 8, 39 ~ 41
- D** Definition of terms 7
- Disc Audio Attribute 1 Type, Sampling
Frequency, Bit No. 36
- Disc format 7
- Disc handling 7
- Disc Information Screen 42
- DISC LANGUAGES (DVD) 46
- Disc Operation 36 ~ 40
- Disc Tray 7, 9, 16
- DISPLAY 41 ~ 43
- DISPLAY button 8, 41
- DVD button 8, 16
- DVD Lock Feature (DVD) 45
- DVD Lock Ratings (DVD) 45
- DVD menu (DVD) 38
- DVD Operation using On-Screen 41 ~ 43
- DVD Volume Adjust 29
- F** FF button 8, 16
- Foward / Reverse Chapter / Track skip 17
- Foward / Reverse rapid scene search 17
- Frame by Frame picture (DVD/Video CD) .. 17
- K** Karaoke (DVD/Video CD) 37
- L** Language Code List 49
- M** MENU button 8, 38
- MP3 Playback Operation 44
- Multiple angle viewing (DVD) 37
- O** OPEN / CLOSE button 8, 16
- Optical digital audio output connector 9, 15
- P** PAUSE button 8, 17
- Picture Zoom (DVD) 37
- Play 16
- Playback control (Video CDs) 17
- PLAY button 8, 16
- Program Play (Video CD/CD) 39
- Program Repeat Play (Video CD/CD) 39
- R** Random Play (Video CD/CD) 40
- Region number 3
- Repeat Play 43
- RESUME function 17
- RETURN button 8, 16
- REW button 8, 16
- S** Settings for DVD Operation 46 ~ 48
- SKIP ►► / ◀◀ button 8, 16, 17
- Slow Motion (DVD/Video CD) 17
- SLOW ►► / ◀◀ button 8, 17
- STILL MODE 48
- Still (Pause) Picture 17
- Subtitle language (DVD) 36
- T** TV MODE 48
- Title menu (DVD) 38
- U** Unit information screen (Unit) 43
- Z** ZOOM button 8, 37

LSQT0592A

Panasonic Consumer Electronics Company,
Division of Matsushita Electric Corporation of America
One Panasonic Way Secaucus, New Jersey 07094

Panasonic Sales Company ("PSC"),
Division of Matsushita Electric of Puerto Rico, Inc.
Ave. 65 de Infantería, Km. 9.5
San Gabriel Industrial Park, Carolina, Puerto Rico 00985



Printed in U.S.A
LSQT0592A
M0302-0