

# Digital Video Camera Recorder

## Operating Instructions

Before operating the unit, please read this manual thoroughly, and retain it for future reference.

## Owner's Record

The model and serial numbers are located on the bottom. Record the serial number in the space provided below. Refer to these numbers whenever you call upon your Sony dealer regarding this product.

Model No. **DCR-IP** \_\_\_\_\_ Model No. **AC**-\_\_\_\_\_

Serial No. \_\_\_\_\_ Serial No. \_\_\_\_\_

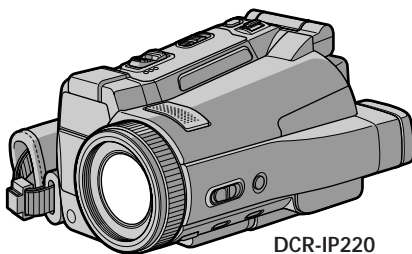

DCR-IP220

*DCR-IP210/IP220*

Digital  
**Handycam IP**  
Network  
**Handycam IP**



MEMORY STICK™



**MPEGMOVIEAD**

## Welcome!

Congratulations on your purchase of this Sony Handycam. With your Handycam, you can capture life's precious moments with superior picture and sound quality. Your Handycam is loaded with advanced features, but at the same time it is very easy to use. You will soon be producing home video that you can enjoy for years to come.

### WARNING

To prevent fire or shock hazard, do not expose the unit to rain or moisture.

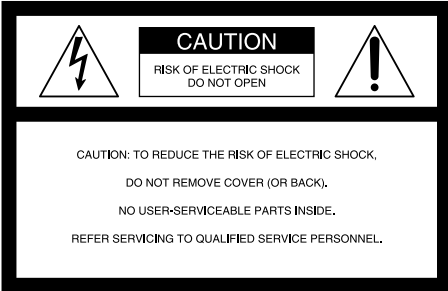

This symbol is intended to alert the user to the presence of uninsulated "dangerous voltage" within the product's enclosure that may be of sufficient magnitude to constitute a risk of electric shock to persons.



This symbol is intended to alert the user to the presence of important operating and maintenance (servicing) instructions in the literature accompanying the appliance.

### CAUTION

The use of optical instruments with this product will increase eye hazard. As the laser beam used in this Handycam is harmful to eyes, do not attempt to disassemble the cabinet.

Refer servicing to qualified personnel only.

### For customers in the U.S.A. and CANADA

#### CAUTION

TO PREVENT ELECTRIC SHOCK, MATCH WIDE BLADE OF PLUG TO WIDE SLOT, FULLY INSERT.

#### RECYCLING LITHIUM-ION BATTERIES

Lithium-Ion batteries are recyclable.

You can help preserve our environment by returning your used rechargeable batteries to the collection and recycling location nearest you.



For more information regarding recycling of rechargeable batteries, call toll free 1-800-822-8837, or visit <http://www.rbrbc.org/>.

**Caution:** Do not handle damaged or leaking Lithium-Ion batteries.

#### "Memory Stick"

This device complies with Part 15 of the FCC Rules. Operation is subject to the following two conditions: (1) This device may not cause harmful interference, and (2) this device must accept any interference received, including interference that may cause undesired operation.

This Class B digital apparatus complies with Canadian ICES-003.

#### DCR-IP220 only

Countries and areas where you can use network functions are restricted.

For details, refer to the separate Network Operating Instructions.

## For customers in the U.S.A.

If you have any questions about this product, you may call:  
Sony Customer Information Center 1-800-222-SONY (7669)  
The number below is for the FCC related matters only.

### Regulatory Information

#### Declaration of Conformity

Trade Name: SONY  
Model No.: DCR-IP220  
Responsible Party: Sony Electronics Inc.  
Address: 680 Kinderkamack  
Road, Oradell,  
NJ07649 U.S.A.  
Telephone No.: 201-930-6972

This device complies with Part 15 of the FCC Rules. Operation is subject to the following two conditions: (1) This device may not cause harmful interference, and (2) this device must accept any interference received, including interference that may cause undesired operation.

### CAUTION

You are cautioned that any changes or modifications not expressly approved in this manual could void your authority to operate this equipment.

### DCR-IP220 only

#### IMPORTANT NOTE

To comply with FCC RF exposure compliance requirements, the following antenna installation and device operating configurations must be satisfied: the antenna has been installed by the manufacturer and no changes can be made.

This device and its antenna (s) must not be co-located or operating in conjunctions with any other antenna or transmitter.

### Note:

This equipment has been tested and found to comply with the limits for a Class B digital device, pursuant to Part 15 of the FCC Rules. These limits are designed to provide reasonable protection against harmful interference in a residential installation. This equipment generates, uses, and can radiate radio frequency energy and, if not installed and used in accordance with the instructions, may cause harmful interference to radio communications. However, there is no guarantee that interference will not occur in a particular installation. If this equipment does cause harmful interference to radio or television reception, which can be determined by turning the equipment off and on, the user is encouraged to try to correct the interference by one or more of the following measures:

- Reorient or relocate the receiving antenna.
- Increase the separation between the equipment and receiver.
- Connect the equipment into an outlet on a circuit different from that to which the receiver is connected.
- Consult the dealer or an experienced radio/TV technician for help.

The supplied interface cable must be used with the equipment in order to comply with the limits for a digital device pursuant to Subpart B of Part 15 of FCC Rules.

## For customers in CANADA

### DCR-IP220 only

The term "IC:" before the radio certification number only signifies that Industry Canada technical specifications were met.

# Main Features

## Recording moving pictures or still images, and playing them back

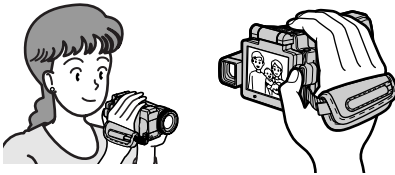

- Recording moving pictures on tapes (p. 29)
- Playing back tapes (p. 42)
- Recording still images on a “Memory Stick” (p. 47, 111)
- Recording moving pictures on a “Memory Stick” (p. 130)
- Viewing still images recorded on a “Memory Stick” (p. 136)
- Viewing moving pictures recorded on a “Memory Stick” (p. 139)

- Viewing moving pictures recorded on tapes using the i.LINK cable (p. 153)

(The i.LINK of your camcorder adopts the  format only. It does not adopt the **DV** or the MPEG2 format of **DVHS**.)

- Viewing images recorded on a “Memory Stick” using the USB cable (p. 169, 174)
- Viewing moving pictures recorded on tapes using the USB cable (p. 164)
- Capturing images on your computer from your camcorder using the USB cable (p. 166)

## Capturing images on your computer

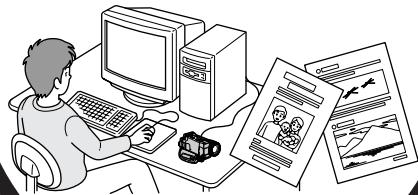

### Accessing the Internet via a Bluetooth wireless device (optional) (DCR-IP220 only)

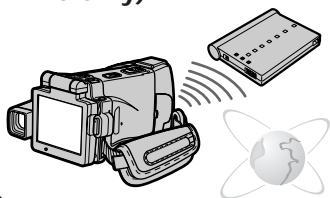

Accessing the Internet, sending/receiving your e-mail. For details, refer to the Network Function Operating Instructions supplied with your camcorder. (DCR-IP220 only) (p. 175)

### Other uses

Functions to adjust exposure in the recording mode

- BACK LIGHT (p. 37)
- NightShot/Super NightShot/Color Slow Shutter (p. 37)
- Recording with the flash (p. 49, 116)
- White balance (p. 52)
- PROGRAM AE (p. 62)
- Adjusting the exposure manually (p. 65)
- Flexible Spot Meter (p. 66)
- HOLOGRAM AF (p. 117)
- NightFraming (p. 119)

Functions to give images more impact

- Digital zoom (p. 33) The default setting is set to OFF. (To zoom greater than 10 $\times$ , select the digital zoom power in D ZOOM in the menu settings.)
- Fader (p. 56)
- Picture effect (p. 58)
- Digital effect (p. 59)
- Title (p. 88, 94)
- MEMORY MIX (p. 125)

Functions to give a natural appearance to your recordings

- PROGRAM AE (p. 62)
  - Sports lesson
  - Landscape
- Manual focus (p. 67)
- Expanded focus (p. 67)
- Spot Focus (p. 69)

Functions to use after recording on a tape

- END SEARCH (p. 41)
- DATA CODE (p. 43)
- Tape PB ZOOM (p. 72)
- MULTI-PICTURE SEARCH (p. 74)
- TITLE SEARCH (p. 78)

# Table of contents

---

<b>Main Features</b> .....	4
----------------------------	---

---

## Introduction

<b>- Basic operations</b> .....	8
---------------------------------	---

---

## Quick Start Guide

- Recording on a tape .....	10
- Recording on a "Memory Stick" .....	12

---

## Getting Started

Using this manual .....	14
Checking supplied accessories .....	16
Step 1 Preparing the power supply ....	17
Inserting the battery pack .....	17
Charging the battery pack .....	18
Connecting to a wall outlet .....	21
Step 2 Setting the date and time .....	22
Step 3 Inserting a cassette .....	25
Step 4 Using the touch panel .....	27

---

## Recording - Basics

Recording a picture .....	29
Shooting a backlit subject	
- BACK LIGHT .....	37
Shooting in the dark - NightShot/ Super NightShot/Color Slow Shutter .....	37
Self-timer recording .....	40
Checking the recording	
- END SEARCH .....	41

---

## Playback - Basics

Playing back a tape .....	42
To display the screen indicators	
- Display function .....	43
Viewing the recording on TV .....	46

---

## Advanced Recording Operations

Recording still images on a "Memory Stick" in CAMERA mode .....	47
Adjusting the white balance manually .....	52
Using the wide mode .....	54
Using the fader function .....	56
Using special effects	
- Picture effect .....	58
Using special effects - Digital effect ...	59
Using the PROGRAM AE .....	62

Adjusting the exposure manually .....	65
Using the spot light-metering mode	
- Flexible Spot Meter .....	66
Focusing manually .....	67
Using the spot focus mode	
- Spot Focus .....	69

---

## Advanced Playback Operations

Playing back a tape with picture effects .....	70
Playing back a tape with digital effects .....	71
Enlarging images recorded on tapes	
- Tape PB ZOOM .....	72
Searching for a scene	
- MULTI-PICTURE SEARCH .....	74
Searching the boundaries of recorded tape by title - TITLE SEARCH .....	78
Searching a recording by date	
- DATE SEARCH .....	79

---

## Editing

Dubbing a tape .....	80
Recording video or TV programs .....	83
Superimposing a title .....	88
Making your own titles .....	94
The micro Cassette Memory .....	97

---

## "Memory Stick" Operations

Using a "Memory Stick"	
- Introduction .....	100
Recording still images on a "Memory Stick"	
- Memory photo recording .....	111
Recording an image from a tape as a still image .....	121
Superimposing a still image in a "Memory Stick" on an image	
- MEMORY MIX .....	125
Recording moving pictures on a "Memory Stick"	
- MPEG MOVIE recording .....	130
Recording a picture from a tape as a moving picture .....	133
Viewing a still image	
- Memory photo playback .....	136
Viewing a moving picture	
- MPEG MOVIE playback .....	139
Copying still images recorded on a "Memory Stick" to a tape .....	141

## Table of contents

---

Enlarging still images recorded on a “Memory Stick”	
– Memory PB ZOOM .....	143
Playing back images continuously	
– SLIDE SHOW .....	145
Preventing accidental erasure	
– Image protection .....	146
Deleting images – DELETE .....	147
Writing a print mark	
– PRINT MARK .....	150

---

## Viewing Images Using your Computer

Viewing images on your computer	
– Introduction .....	151
Connecting your camcorder to your computer using the i.LINK cable (For Windows users) .....	153
Connecting your camcorder to your computer using the USB cable (For Windows users) .....	154
Viewing images recorded on a tape on your computer	
– USB Streaming (For Windows users) .....	164
Viewing images recorded on a “Memory Stick” on your computer (For Windows users) .....	169
Connecting your camcorder to your computer using the USB cable (For Macintosh users) .....	172
Viewing images recorded on a “Memory Stick” on your computer (For Macintosh users) .....	174

---

## Using the Network function (DCR-IP220 only)

Accessing the network .....	175
For the details, refer to the Network Function Operating Instructions supplied with your camcorder.	

---

## Customizing Your Camcorder

Changing the menu settings .....	177
----------------------------------	-----

---

## Troubleshooting

Types of trouble and how to correct trouble .....	186
---	-----

Self-diagnosis display .....	192
Warning indicators and messages ....	193

---

## Additional Information

Usable cassettes .....	195
About the “InfoLITHIUM” battery pack .....	196
About i.LINK .....	198
Using your camcorder abroad .....	200
Maintenance information and precautions .....	201
Specifications .....	208

---

## Quick Reference

Identifying the parts and controls ....	210
Index .....	219

# Introduction – Basic operations

This section describes the basic operations to operate your camcorder.

## How to turn on the power and select the mode

To supply power for your camcorder, see “Step 1 Preparing the power supply” on page 17.

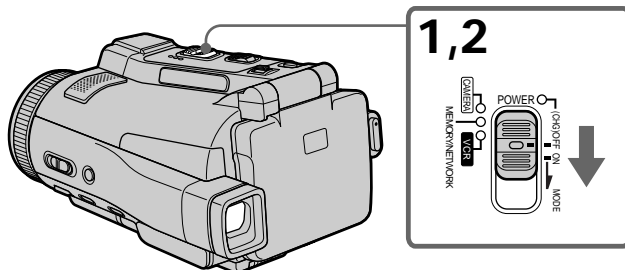

- (1) Slide the POWER switch in the direction of the arrow while pressing the small green button, then release your finger.

Your camcorder is turned on, and then your camcorder turns to the CAMERA mode so that the CAMERA lamp lights up.

- (2) Slide the POWER switch in the direction of the arrow. Each time you slide it down, the mode changes as follows and corresponding mode lamp also lights up.

**CAMERA** Use this mode when you record on a tape.

**MEMORY/NETWORK (DCR-IP220) or MEMORY (DCR-IP210)**

**MEMORY:** Use this mode when you record on a “Memory Stick,” or play back or edit an image in a “Memory Stick.”

**NETWORK (DCR-IP220 only):**

Use this mode when you use the network function. For details, refer to the supplied Network Function Operating Instructions.

**VCR** Use this mode when you play back or edit an image recorded on a tape or “Memory Stick.”



### How to open the LCD panel

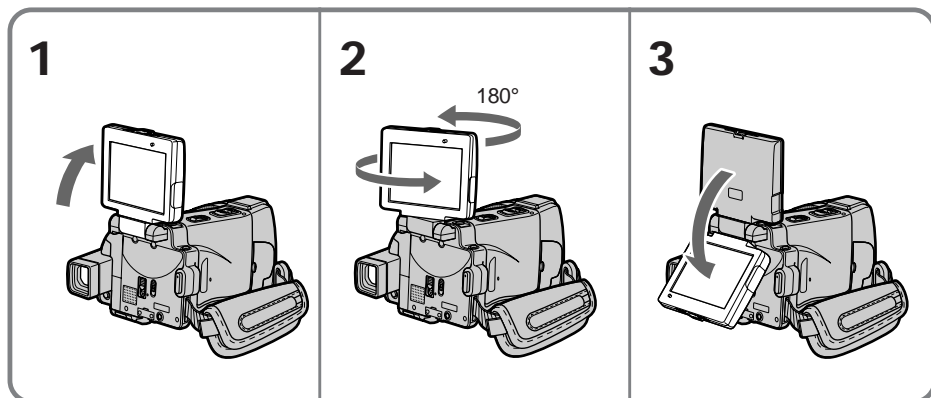

(1) Open the LCD panel in the direction of the arrow.

(2) Turn the LCD panel 180 degrees counter-clockwise.

(3) Close the LCD panel with the LCD screen facing out.

When closing the LCD panel, set it vertically, and swing it into your camcorder body.

#### Notes

- The LCD panel rotates 180 degrees anticlockwise and 90 degrees clockwise.
- When using the LCD panel except in the mirror mode (p. 35), the viewfinder automatically turns off.

#### When you set the LCD screen outdoors in direct sunlight

The LCD screen may be difficult to see. If this happens, we recommend that you use the viewfinder.

#### When you adjust the angle of the LCD panel

Make sure if the LCD panel is opened in the step 2 position.

# Quick Start Guide – Recording on a tape

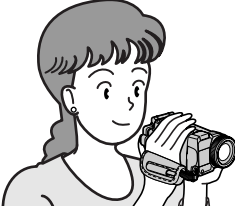

This chapter introduces you to the basic features to record pictures on tapes of your camcorder. See the page in parentheses “( )” for more information.

## 1 Connecting the power cord (p. 21)

Use the battery pack when using your camcorder outdoors (p. 17).

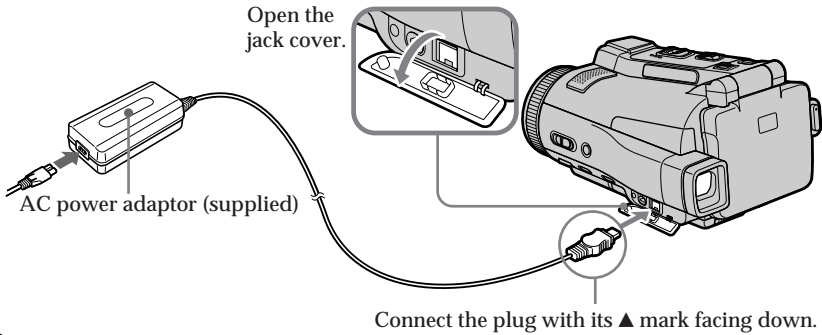

## 2 Inserting a cassette (p. 25)

- 1 Slide OPEN/▲ EJECT  in the direction of the arrow and open the lid.

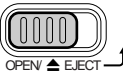

- 2 Push the middle portion of the back of the cassette into the cassette compartment. Insert the cassette in a straight line deeply with the cassette window facing the cassette lid.

- 3 Close the cassette compartment by pushing down the cassette lid halfway. After the cassette compartment goes down completely, close the lid until it clicks.

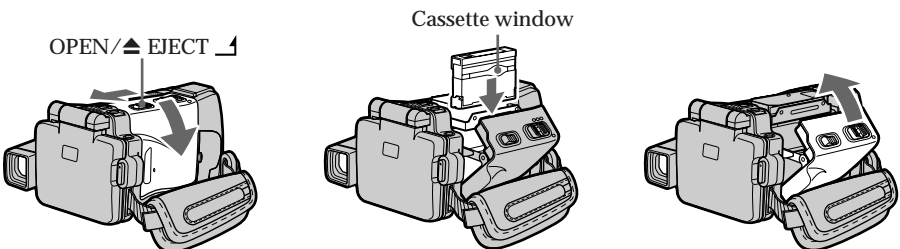

# 3

## Recording a picture (p. 29)

- 2** Set the POWER switch to CAMERA. The CAMERA lamp lights up.



### Viewfinder

When the LCD panel is closed with the LCD screen facing inwards, use the viewfinder.

Adjust the viewfinder lens to your eyesight (p. 32).

- 1** Remove the lens cap.

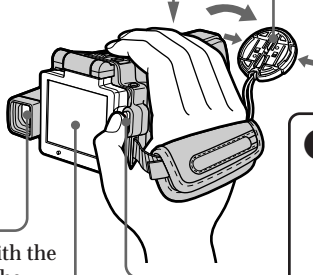

- 4** Press START/STOP. Your camcorder starts recording. To stop recording, press START/STOP again.



- 3** Open the LCD panel. The picture appears on the LCD screen.

When you purchase your camcorder, the clock setting is not set up yet. Set the clock setting before recording (p. 22).

# 4

## Monitoring the playback picture on the LCD screen (p. 42)

- 1** Set the POWER switch to VCR. The VCR lamp lights up.

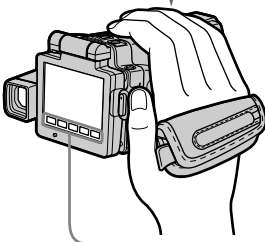
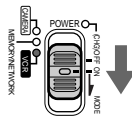

- 2** Press  of the touch panel to rewind the tape.



- 3** Press  of the touch panel to start playback.



### Note

When using the touch panel, press operation buttons lightly with your finger or the supplied stylus (DCR-IP220 only). Do not press the LCD screen with sharp objects other than the stylus supplied (DCR-IP220 only).

### Note

Do not pick up your camcorder by the LCD panel or the jack cover.

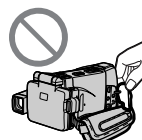
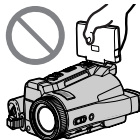

# Quick Start Guide

## - Recording on a "Memory Stick"

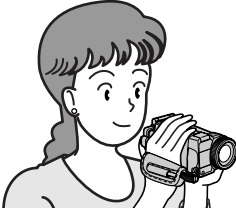

This chapter introduces you to the basic features to record on a "Memory Stick" of your camcorder. See the page in parentheses "( )" for more information.

### 1 Connecting the power cord (p. 21)

Use the battery pack when using your camcorder outdoors (p. 17).

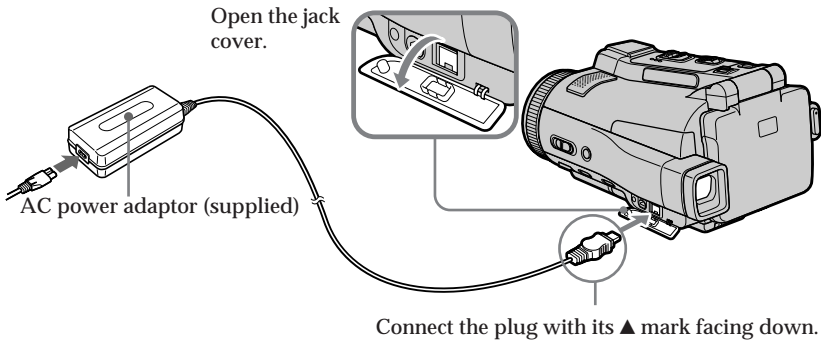

### 2 Inserting a "Memory Stick" (p. 102)

Insert a "Memory Stick" in the "Memory Stick" slot as far as it can go, as illustrated below.

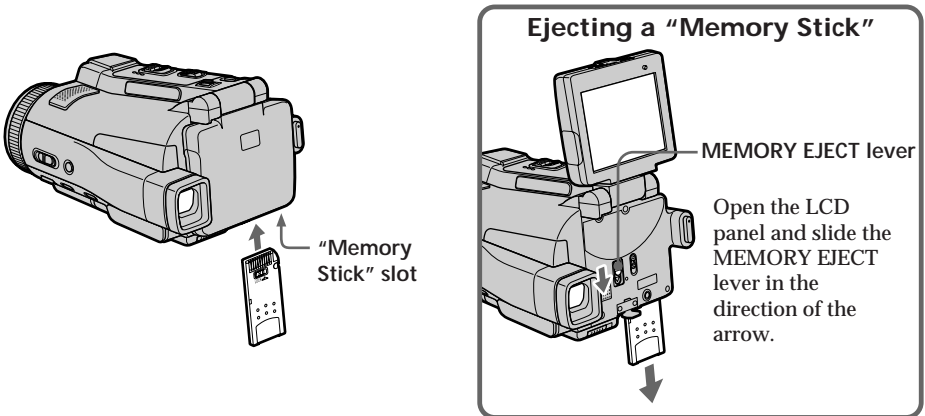

# 3

## Recording a still image on a "Memory Stick" (p. 111)

- 2** Set the POWER switch to MEMORY. The MEMORY lamp lights up.

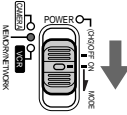

- 1** Remove the lens cap.

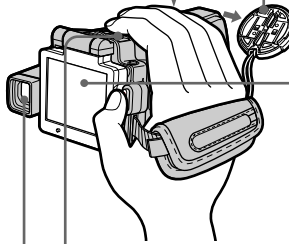

- 3** Open the LCD panel. The picture appears on the LCD screen.

### Viewfinder

When the LCD panel is closed with the LCD screen facing inwards, use the viewfinder. Adjust the viewfinder lens to your eyesight (p. 32).

When you purchase your camcorder, the clock setting is not set up yet. If you want to record the date and time for a picture, set the clock setting before recording (p. 22).

- 4** Press PHOTO lightly.



When the green ● mark stops flashing, then lights up, you can record a still image.

- 5** Press PHOTO deeper.





The image when you pressed PHOTO deeper will be recorded on a "Memory Stick."

# 4

## Monitoring the still image on the LCD screen (p. 136)

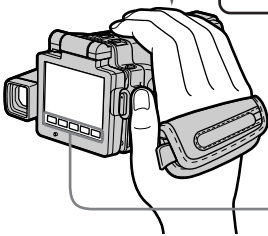
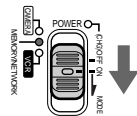
- 1** Set the POWER switch to MEMORY or VCR. The MEMORY or VCR lamp lights up.



- 2** Press PLAY or  PB. The last recorded image is displayed.

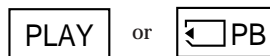

### Note

Do not pick up your camcorder by the LCD panel or the jack cover.

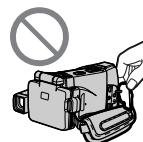
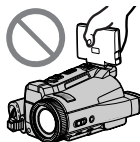

# Using this manual

The instructions in this manual are for the two models listed in the table below. Before you start reading this manual and operating your camcorder, check the model number by looking at the bottom of your camcorder. The DCR-IP220 is the model used for illustration purposes. Otherwise, the model name is indicated in the illustrations. Any differences in operation are clearly indicated in the text, for example, “DCR-IP220 only.”

As you read through this manual, buttons and settings on your camcorder are shown in capital letters.

e.g. Set the POWER switch to CAMERA.

When you carry out an operation, you can hear a beep to indicate that the operation is being carried out.

## Types of differences

DCR-	IP210	IP220
Mark on the POWER switch	MEMORY	MEMORY/NETWORK
Network function	—	●

- Provided
- Not provided

## Note on the MICROMV format

 Your camcorder is based on the MICROMV format. You can only use MICROMV cassettes with your camcorder.

- Records and plays back for about 60 minutes with equal quality when compared to DV (digital video).
- The micro Cassette Memory feature is provided with all MICROMV cassettes. Your camcorder can access any scene easily using the memory (MULTI-PICTURE SEARCH function).
- Adopts the MPEG2 format as a data compression method. This format is the same as the one for DVD (digital versatile disc). Record in 12Mbps bit rate to obtain a higher quality of image.
- Transition between the last scene you recorded and the next scene is the still image. This is not a malfunction.

The  mark is indicated on the MICROMV cassette.

## Note on TV color systems

TV color systems differ depending on the country or area. To view your recordings on a TV, you need an NTSC system-based TV.

## Copyright precautions

Television programs, films, video tapes, and other materials may be copyrighted. Unauthorized recording of such materials may be contrary to the provision of the copyright laws.

## Precautions on camcorder care

### Lens and LCD screen/finder

- The LCD screen and the finder are manufactured using extremely high-precision technology, so over 99.99% of the pixels are operational for effective use. However, there may be some tiny black points and/or bright points (white, red, blue or green in color) that constantly appear on the LCD screen and the finder. These points are normal in the manufacturing process and do not affect the recording in any way.
- Do not let your camcorder get wet. Keep your camcorder away from rain and sea water. Letting your camcorder get wet may cause your camcorder to malfunction. Sometimes this malfunction cannot be repaired [a].
- Never leave your camcorder exposed to temperatures above 60°C (140°F), such as in a car parked in the sun or under direct sunlight [b].
- Be careful when placing the camera near a window or outdoors. Exposing the LCD screen, the finder or the lens to direct sunlight for long periods may cause malfunctions [c].
- Do not directly shoot the sun. Doing so might cause your camcorder to malfunction. Take pictures of the sun in low light conditions such as dusk [d].

[a]

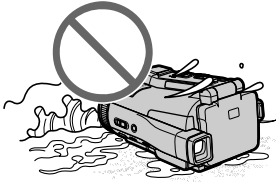

[b]

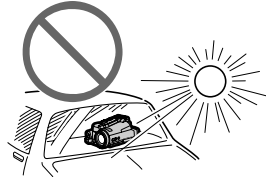

[c]

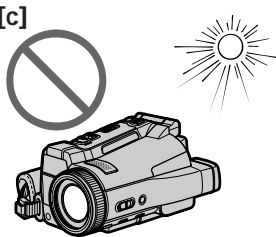

[d]

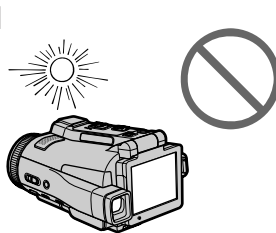

# Checking supplied accessories

Make sure that the following accessories are supplied with your camcorder.

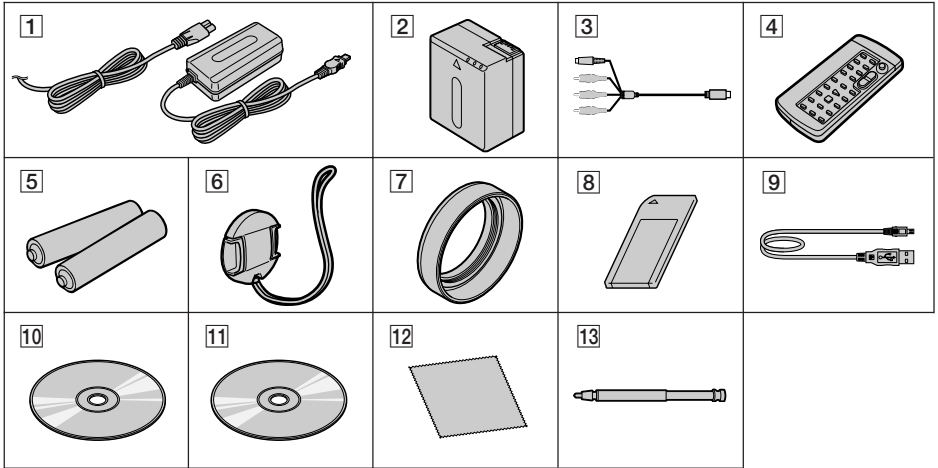

1 AC-L20A AC power adaptor (1), Power cord (1) (p. 18)

2 NP-FF70 battery pack (1) (p. 17, 18)

3 A/V connecting cable (1) (p. 46)

4 Wireless Remote Commander (1) (p. 216)

5 Size AA (R6) batteries for the Remote Commander (2) (p. 217)

6 Lens cap (1) (p. 29)

7 Lens hood (1) (p. 32)

8 "Memory Stick" (1) (p. 100)

9 USB cable (1) (p. 151)

10 CD-ROM (SPVD-008 USB Driver) (1) (p. 154, 172)

11 CD-ROM (Movie Shaker Ver. 3.1 for MICROMV) (1) (p. 153)

12 Cleaning cloth (1) (p. 202)

13 Stylus (1) (DCR-IP220 only) (p. 176)

Contents of the recording cannot be compensated if recording or playback is not made due to a malfunction of the camcorder, storage media, etc.



# Step 1 Preparing the power supply

## Inserting the battery pack

Your camcorder operates only with the NP-FF70 battery pack.

- (1) Slide OPEN  in the direction of the arrow and open the battery compartment lid.
- (2) Insert the battery pack with its terminal side facing your camcorder.
- (3) Close the battery compartment lid.

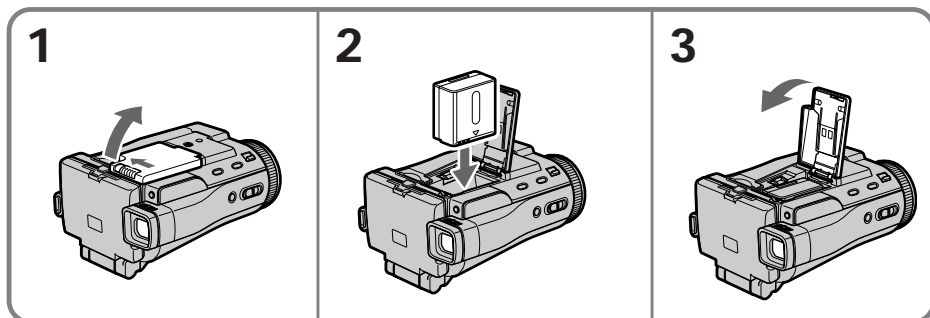

## To take out the battery pack

Open the battery compartment lid and slide the lever to take out the battery pack.

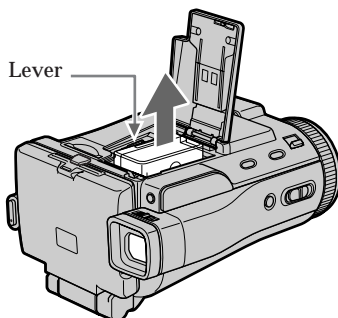

### Note

Your camcorder operates only with the NP-FF70 battery pack. You cannot use the NP-FF50 battery pack.

## Step 1 Preparing the power supply

### Charging the battery pack

Charge the battery pack before using your camcorder.

Your camcorder operates only with the "InfoLITHIUM" battery pack (NP-FF70).

See page 196 for details of the "InfoLITHIUM" battery pack.

- (1) Open the jack cover and connect the supplied AC power adaptor to the DC IN jack on your camcorder with the plug's ▲ mark facing down.
- (2) Connect the power cord to the AC power adaptor.
- (3) Connect the power cord to a wall outlet.
- (4) Set the POWER switch to (CHG) OFF.

The battery CHG lamp lights up when the charge begins. After charging is completed, the battery CHG lamp goes off (full charge).

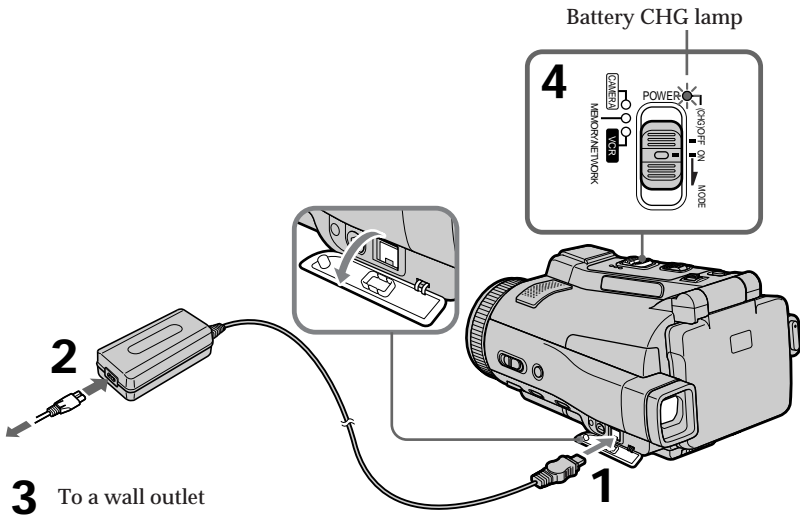

### After charging the battery pack

Disconnect the AC power adaptor from the DC IN jack on your camcorder.

## Step 1 Preparing the power supply

### Note

Prevent metallic objects from coming into contact with the metal parts of the DC plug of the AC power adaptor. This may cause a short-circuit, damaging the AC power adaptor.

While charging the battery pack, the battery CHG lamp flashes in the following cases:

- The battery pack is not inserted correctly.
- Something is wrong with the battery pack.
- The ambient temperature is extremely high or low.

### When you use the AC power adaptor

Place the AC power adaptor near the wall outlet. If any trouble occurs with this unit, disconnect the plug from the wall outlet as soon as possible to cut off the power.

## Charging time

Battery pack	Full charge
NP-FF70 (supplied)	150

Approximate minutes at 25°C (77°F) to charge an empty battery pack

The charging time may increase if the battery's temperature is extremely high or low because of the ambient temperature.

## Recording time

Battery pack	Recording with the viewfinder		Recording with the LCD screen			
			Backlighting on		Backlighting off	
	Continuous	Typical*	Continuous	Typical*	Continuous	Typical*
NP-FF70 (supplied)	130	70	115	60	130	70

Approximate minutes when you use a fully charged battery

\* Approximate recording time when you repeat recording start/stop, zooming and turning the power on/off. The actual battery life may be shorter.

## Playing time

Battery pack	Playing time on LCD screen	Playing time with LCD closed
NP-FF70 (supplied)	140	175

Approximate minutes when you use a fully charged battery

## Step 1 Preparing the power supply

---

### Note

Approximate recording time and playing time at 25°C (77°F). The battery life will be shorter if you use your camcorder in a cold environment.

**If the power goes off although the battery remaining indicator indicates that the battery pack has enough power to operate**

Charge the battery pack fully again so that the indication on the battery remaining indicator is correct.

### Recommended charging temperature

We recommend charging the battery pack in an ambient temperature of between 10°C to 30°C (50°F to 86°F).

### What is “InfoLITHIUM”?

The “InfoLITHIUM” is a lithium ion battery pack which can exchange data such as battery consumption with compatible electronic equipment. This unit is compatible with the “InfoLITHIUM” battery pack (NP-FF70). Your camcorder operates only with the “InfoLITHIUM” battery. “InfoLITHIUM” F series battery packs have the

 mark.

“InfoLITHIUM” is a trademark of Sony Corporation.

## Step 1 Preparing the power supply

### Connecting to a wall outlet

When you use your camcorder for a long time, we recommend that you power it from a wall outlet using the AC power adaptor.

- (1) Open the jack cover and connect the supplied AC power adaptor to the DC IN jack on your camcorder with the plug's ▲ mark facing down.
- (2) Connect the power cord to the AC power adaptor.
- (3) Connect the power cord to a wall outlet.

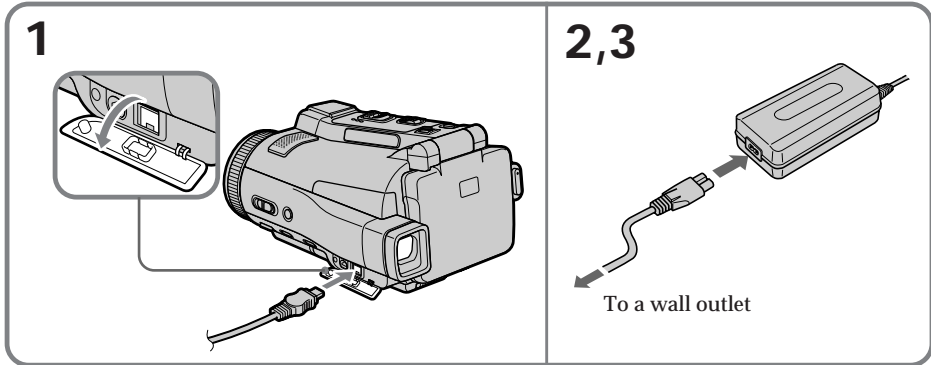

#### PRECAUTION

The set is not disconnected from the AC power source (house current) as long as it is connected to the wall outlet, even if the set itself has been turned off.

#### Notes

- The AC power adaptor can supply power even if the battery pack is inserted in your camcorder.
- The DC IN jack has "source priority." This means that the battery pack cannot supply any power if the power cord is connected to the DC IN jack, even when the power cord is not plugged into a wall outlet.

#### A car battery

You cannot use a car battery with your camcorder.

## Step 2 Setting the date and time

---

Set the date and time when you use your camcorder for the first time. "CLOCK SET" will be displayed each time you set the POWER switch to CAMERA or MEMORY unless you set the date and time settings.

If you do not use your camcorder for **about three months**, the date and time settings may be released (bars may appear) because the built-in rechargeable battery installed in your camcorder will have been discharged (p. 203). In this case, charge the built-in rechargeable battery, then set your area, the daylight saving time (DST), the year, the month, the day, the hour and the minute.

- (1) Set the POWER switch to CAMERA or MEMORY.  
The CAMERA or MEMORY lamp lights up.
- (2) Press FN (Function) to display PAGE1 (p. 27).
- (3) Press MENU to display the menu.
- (4) Press ↓/↑ to select , then press EXEC.
- (5) Press ↓/↑ to select CLOCK SET, then press EXEC.
- (6) Press ↓/↑ to select your area, then press EXEC.
- (7) Press ↓/↑ to select whether your area is in the daylight saving time or not, then press EXEC.
- (8) Press ↓/↑ to select the desired year, then press EXEC.
- (9) Set the month, day and hour with the same procedure as step 8.
- (10) Press ↓/↑ to set the minute, then press EXEC by the time signal. The clock starts to move.

## Step 2 Setting the date and time

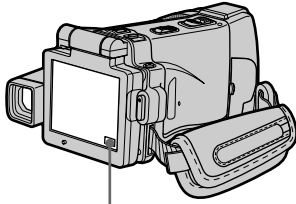

2,3

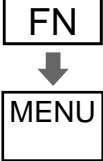

4

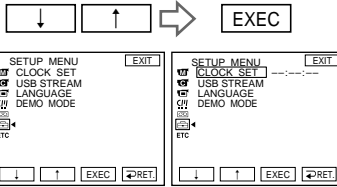

5

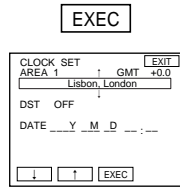

6

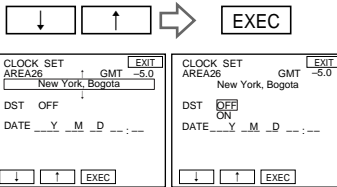

7

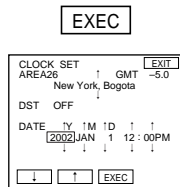

8,9

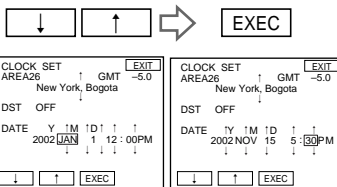

10

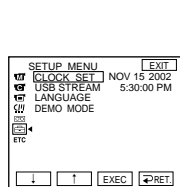

Getting Started

The year changes as follows:



### To return to FN (Function)

Press EXIT.

### When using your camcorder abroad

Set the clock to the local time (p. 24).

### If you use your camcorder in a region where daylight saving time is used

Set DST SET to ON in the menu settings.

### If you do not set the date and time

“----” and “--:--” are recorded on the tape or the “Memory Stick” as the data code.

### Note on the time indicator

The internal clock of your camcorder operates on a 12-hour cycle.

- 12:00 AM stands for midnight.
- 12:00 PM stands for noon.

## Step 2 Setting the date and time

### Simple setting of clock by time difference

You can easily set the clock to the local time by setting a time difference. Select AREA SET and DST SET\* in the menu settings.

See page 185 for more information.

\* Instead of DST, SUMMERTIME is displayed on the screen for some models.

### World time difference

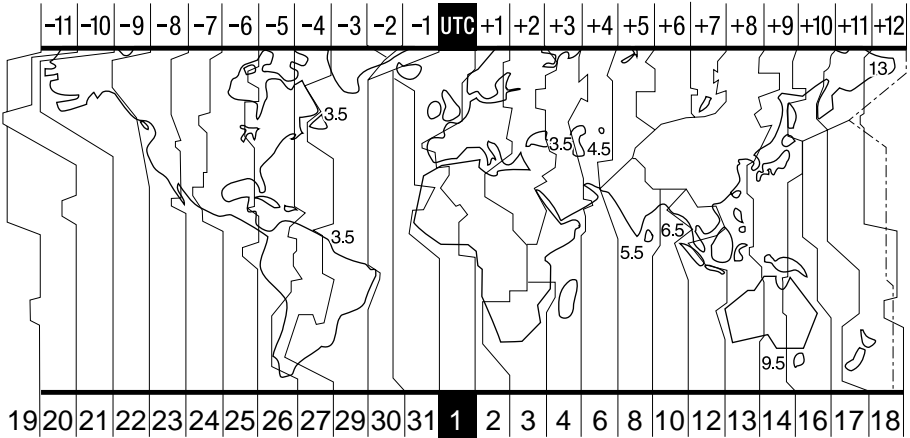

Area code	Time-zone differences	Area setting
1	GMT	Lisbon, London
2	+01:00	Berlin, Paris
3	+02:00	Helsinki, Cairo
4	+03:00	Moscow, Nairobi
5	+03:30	Tehran
6	+04:00	Abu Dhabi, Baku
7	+04:30	Kabul
8	+05:00	Karachi, Islamabad
9	+05:30	Calcutta, New Delhi
10	+06:00	Almaty, Dhaka
11	+06:30	Rangoon
12	+07:00	Bangkok, Jakarta
13	+08:00	HongKong, Singapore
14	+09:00	Seoul, Tokyo
15	+09:30	Adelaide, Darwin
16	+10:00	Melbourne, Sydney

Area code	Time-zone differences	Area setting
17	+11:00	Solomon Is
18	+12:00	Fiji, Wellington
19	-12:00	Eniwetok, Kwajalein
20	-11:00	Midway Is., Samoa
21	-10:00	Hawaii
22	-09:00	Alaska
23	-08:00	LosAngeles, Tijuana
24	-07:00	Denver, Arizona
25	-06:00	Chicago, MexicoCity
26	-05:00	New York, Bogota
27	-04:00	Santiago
28	-03:30	St. John's
29	-03:00	Brasilia, Montevideo
30	-02:00	Fernando de Noronha
31	-01:00	Azores

### To set your local time

Select AREA SET in the menu settings, then press EXEC. Next, select the country or area where you stay in, using the table above, then press EXEC.



## Step 3 Inserting a cassette

- (1) Prepare the power source (p. 17).
- (2) Slide OPEN/▲ EJECT ▾ in the direction of the arrow and open the lid. The cassette compartment automatically lifts up and opens.
- (3) Push the middle portion of the back of the cassette into the cassette compartment.  
Insert the cassette in a straight line deeply with the cassette window facing the cassette lid.
- (4) Close the cassette compartment by pushing down the cassette lid halfway. The cassette compartment automatically goes down.
- (5) After the cassette compartment goes down completely, close the lid.

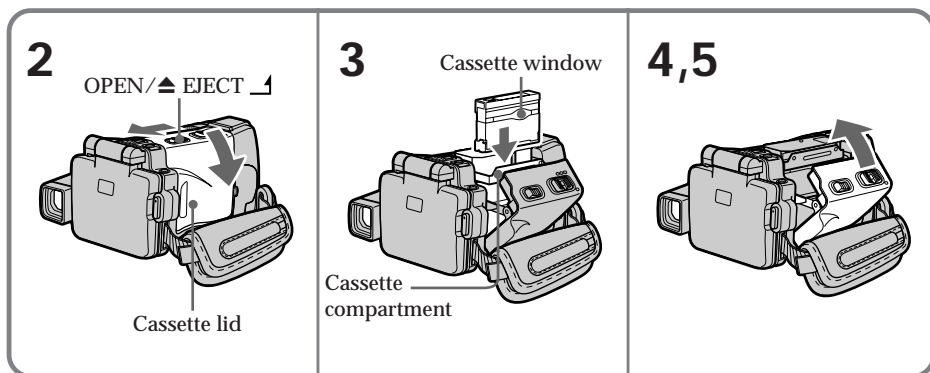

### To eject a cassette

Follow the procedures above, and take out the cassette after the cassette compartment opens completely in step 2.

#### Note

Do not press the cassette compartment down. Doing so may cause a malfunction.

### To prevent accidental erasure

Slide the write-protect tab on the cassette to expose the red mark.

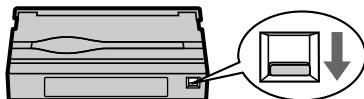

### Step 3 Inserting a cassette

---

#### Note on the label

Labels may cause a malfunction of your camcorder. Therefore, be sure not to:

- Stick on any labels other than the one supplied.
- Stick the label onto any part of the cassette other than the label position [a].

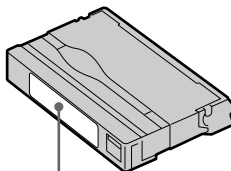

[a]

# Step 4 Using the touch panel

Your camcorder has operation buttons on the LCD screen. Press the LCD screen with your finger or the supplied stylus (DCR-IP220 only) to operate each function. This section describes how to operate the touch panel during recording or playing back images on a tape.

- (1) Prepare the power source (p. 17 to 21).
- (2) Open the LCD panel.
- (3) Set the POWER switch to CAMERA to record or VCR to play back.
- (4) Press FN to display PAGE1. The operation buttons of PAGE1 appear on the LCD screen.
- (5) Press PAGE2 to go to PAGE2. The operation buttons of PAGE2 appear on the LCD screen.
- (6) Press PAGE3 to go to PAGE3. The operation buttons of PAGE3 appear on the LCD screen.
- (7) Press a desired operation item. See relevant pages of this manual for each function.

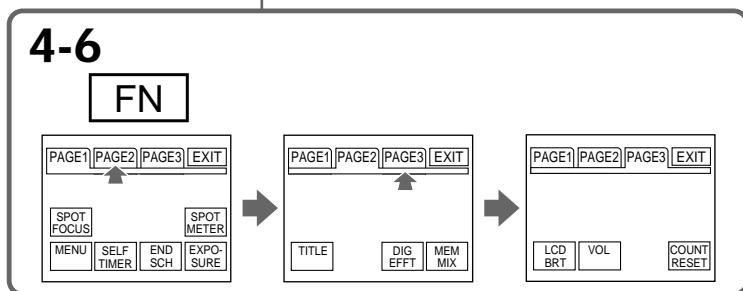
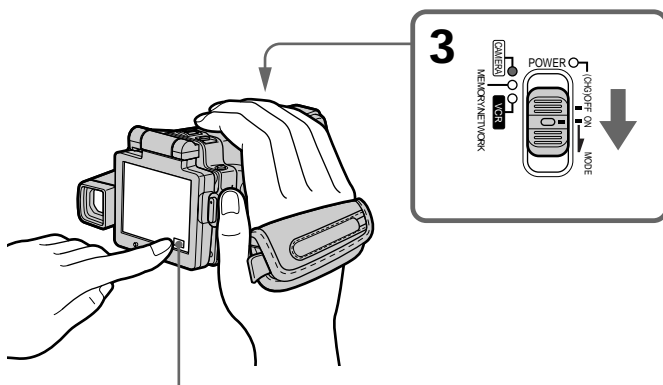

## To return to FN

Press EXIT.

## To execute settings

Press EXEC or ↩ OK. The display returns to PAGE1, 2 or 3.

## To cancel settings

Press ↵ OFF. The display returns to PAGE1, 2 or 3.

## Step 4 Using the touch panel

---

### Notes

- When using the touch panel, press the LCD screen lightly with your finger or the supplied stylus (DCR-IP220 only).
- Do not press the LCD screen with sharp objects other than the supplied stylus (DCR-IP220 only).
- Do not press the LCD screen too hard.
- Do not touch the LCD screen with wet hands.
- If FN is not on the LCD screen, touch the LCD screen lightly to make it appear. You can make the display appear or disappear with DISPLAY/TOUCH PANEL on your camcorder.
- When the operation buttons do not work even if you press them, an adjustment is required (CALIBRATION) (p. 204).
- When the LCD screen gets dirty, use the supplied cleaning cloth.

### When executing each item

The green bar appears above the item.

### If an item is not available

The color of the items changes to gray.

### Press FN to display the following buttons:

In CAMERA mode

PAGE1	SPOT FOCUS, MENU, SELF TIMER, END SCH, EXPOSURE, SPOT METER
PAGE2	TITLE, DIG EFFT, MEM MIX
PAGE3	LCD BRT, VOL, COUNT RESET

In VCR mode

PAGE1	MENU, VOL, TITLE, MULTI SCH
PAGE2	LCD BRT, DIG EFFT, PB ZOOM, END SCH
PAGE3	DATA CODE, COUNT RESET,  REC CTRL

See page 104 when you set the POWER switch to MEMORY.

# Recording a picture

Your camcorder automatically focuses for you.

- (1) Remove the lens cap by pressing both knobs on its sides.
- (2) Prepare the power source and insert a cassette. See “Step 1” to “Step 3” (p. 17 to 26) for more information.
- (3) Set the POWER switch to CAMERA. The CAMERA lamp lights up and your camcorder is set to the recording standby mode.
- (4) Open the LCD panel. The picture disappears from the viewfinder and appears on the LCD screen.
- (5) Press START/STOP. Your camcorder starts recording. The REC indicator appears. The camera recording lamp located on the front of your camcorder lights up. To stop recording, press START/STOP again.

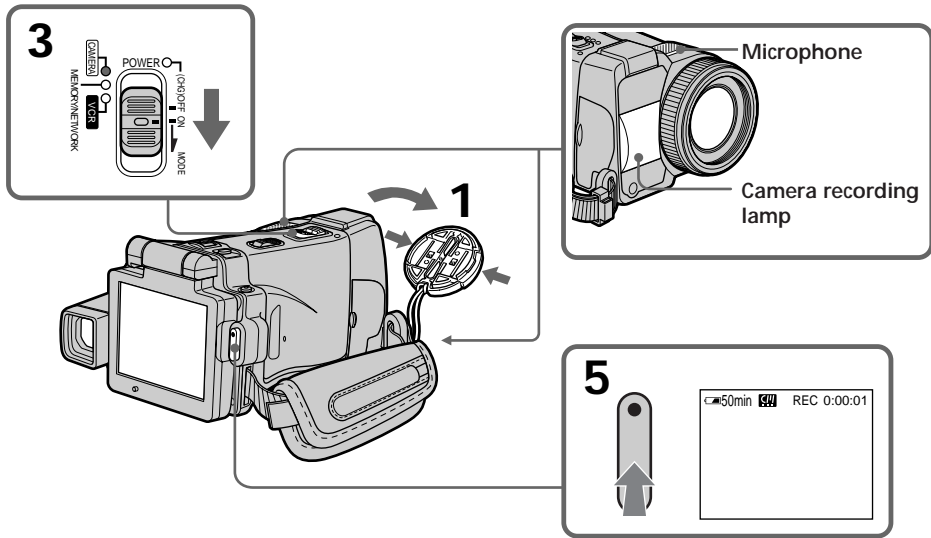

## Recording a picture

---

### After recording

- (1) Set the POWER switch to (CHG) OFF.
- (2) Close the LCD panel with the LCD screen facing inwards.
- (3) Eject the cassette.
- (4) Remove the power source.

---

#### Notes

- Fasten the grip belt firmly.
- Do not touch the built-in microphone during recording.

#### To enable transition

- Transition between the last scene you recorded and the next scene can be performed as long as you do not eject the cassette even if you turn off your camcorder. You can perform the transition with the end search function (p. 41) even after ejecting the cassette.
- When you want to change the battery pack, be sure to set the POWER switch to (CHG) OFF. It does not affect transition.

#### Recording data

The recording data (date/time or various settings when recorded) are not displayed during recording. However, they are recorded automatically onto the tape. To display the recording data, press DATA CODE during playback. You can also use the Remote Commander for this operation (p. 43).

#### If you leave your camcorder in the standby mode for five minutes while the cassette is inserted

Your camcorder automatically turns off. This is to save battery power and to prevent battery and tape wear. To resume the standby mode, set the POWER switch to (CHG) OFF, and to CAMERA during playback again. However, your camcorder does not turn off automatically while the cassette is not inserted.

#### The battery life when you record using the LCD screen

The battery time is slightly shorter than the shooting time using the viewfinder.

### Adjusting the brightness of the LCD screen

- (1) Set the POWER switch to CAMERA or MEMORY, then press FN and go to PAGE3.  
Set the POWER switch to VCR, then press FN and go to PAGE2.
- (2) Press LCD BRT. The screen to adjust the brightness of the LCD screen appears.
- (3) Adjust the brightness of the LCD screen using -/+.
  - : To dim
  - + : To brighten
- (4) Press  $\rightarrow$  OK. The display returns to PAGE2/PAGE3.

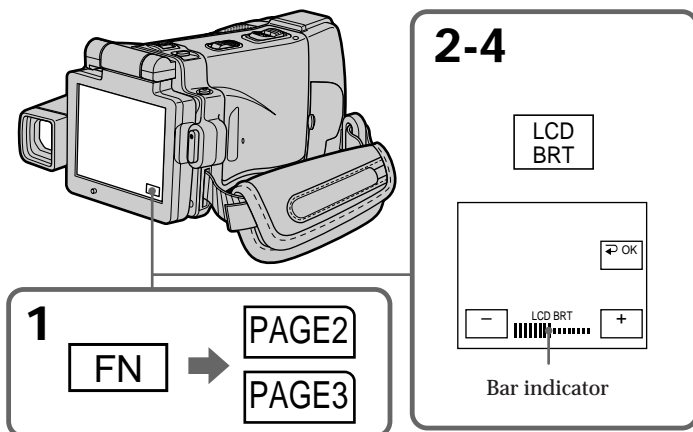

#### To return to FN

Press EXIT after step 4.

#### The color of the LCD screen

You can adjust the color of the LCD screen.  
Select LCD COLOR in the menu settings (p. 180).

Even if you adjust the LCD screen using LCD BRT, LCD COLOR, or the LCD screen backlight

The recorded picture will not be affected.

#### The setting of the LCD BACKLIGHT switch

Normally, set it to ON. When you use your camcorder in bright conditions using the battery pack, set it to OFF. This position saves battery power.

## Recording a picture

---

### Adjusting the viewfinder

If you record pictures with the LCD panel closed, check the picture with the viewfinder. Adjust the viewfinder lens to your eyesight so that the indicators in the viewfinder come into sharp focus.

Adjust with the viewfinder lens adjustment lever.

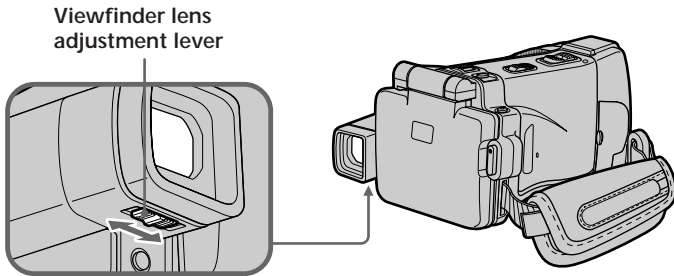

---

### Viewfinder backlight

You can change the brightness of the backlight.

Select VF B.L. in the menu settings when using the battery pack (p. 180).

Even if you adjust the viewfinder backlight

The recorded picture will not be affected.

### Attaching the supplied lens hood

To record fine pictures under strong light, we recommend attaching the lens hood. Also the lens cap can be attached even with the lens hood on.

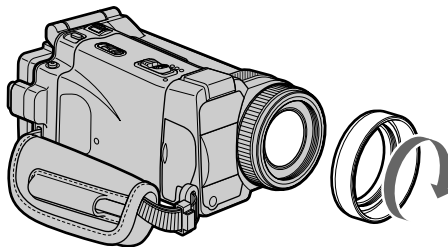

---

### Note

You cannot attach filters or other objects onto the lens hood.

If you forcibly attach these objects onto the lens hood, you will no longer be able to remove filters or other objects from the hood.

**When you use the filter (optional)**

The shadow of the lens hood may appear in the corners of the screen.



### Using the zoom feature – Zoom lever

Move the zoom lever a little for a slower zoom. Move it further for a faster zoom.

“T” side: for telephoto (subject appears closer)

“W” side: for wide-angle (subject appears further away)

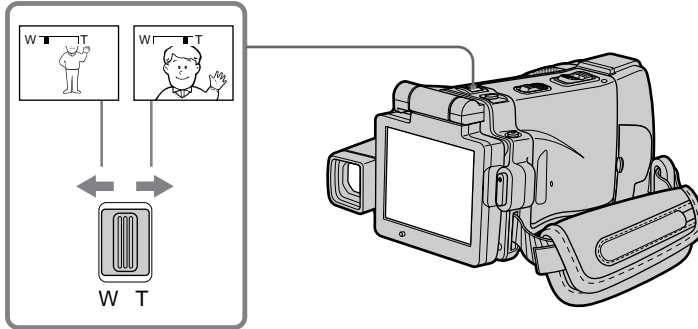

Using the zoom function sparingly results in better-looking recordings.

**To zoom greater than 10×**

Zoom greater than 10× is performed digitally. To activate the digital zoom, select the digital zoom power in D ZOOM in the menu settings (p. 179). The digital zoom is set to OFF as the default setting.

The right side of the bar shows the digital zooming zone.

The digital zooming zone appears when you select the digital zoom power in the menu settings.

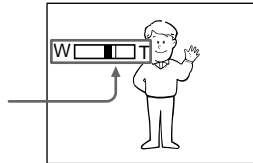

**When you shoot close to a subject**

If you cannot get a sharp focus, move the power zoom lever to the “W” side until the focus is sharp. You can shoot a subject that is at least about 80 cm (about 2 feet 5/8 inch) away from the lens surface in the telephoto position, or about 1 cm (about 1/2 inch) away in the wide-angle position.

**Notes on digital zoom**

- Digital zoom starts to function when zoom exceeds 10×. Up to 20× or 120× zoom is performed digitally.
- The picture quality deteriorates as you move the power zoom lever toward the “T” side.

**When the POWER switch is set to MEMORY**

You cannot use the digital zoom.

## Recording a picture

### Using the zoom feature – Zoom ring

You can use the zoom ring to zoom in and out at the desired speed. You can also use it to fine adjust.

Set FOCUS to ZOOM.

The  indicator appears on the LCD screen.

Turn the zoom ring at the desired speed to zoom in or out.

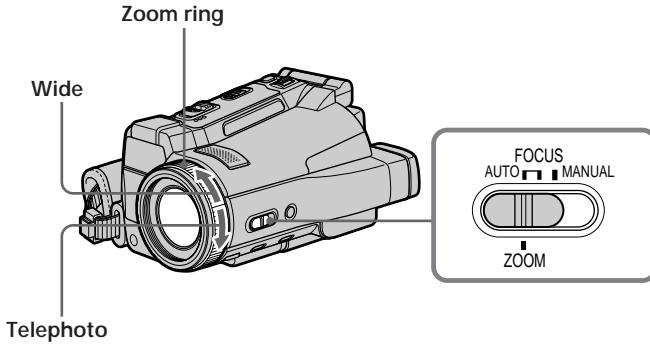

---

#### Notes

- Do not rotate the zoom ring too quickly. Rotating it too quickly will prevent correct focusing.
- Your camcorder changes to the autofocus mode when FOCUS is set to ZOOM.

### Shooting with the mirror mode

This feature allows the camera subject to view him or herself on the LCD screen. The subject uses this feature to check his or her own image on the LCD screen while you look at the subject in the viewfinder.

Set the POWER switch to CAMERA or MEMORY.  
Open the LCD panel, then rotate the LCD panel 180 degrees counter-clockwise.

The ☺ indicator appears in the viewfinder and on the LCD screen.  
■● appears in the standby mode, and ● appears in the recording mode. Some other indicators appear mirror-reversed and others are not displayed.

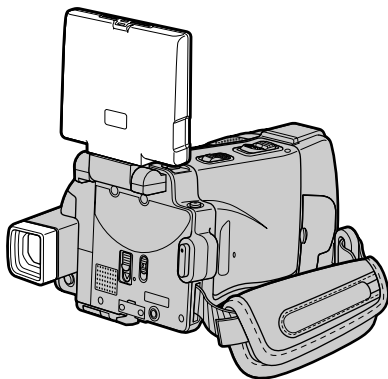

---

#### Note

You can only rotate the LCD panel counter-clockwise.

#### Picture in the mirror mode

The picture on the LCD screen is a mirror-image. However, the picture will be normal when recorded.

#### During recording in the mirror mode

FN appears mirror-reversed in the viewfinder.

#### When you press FN

The ☺ indicator does not appear on the LCD screen.

## Recording a picture

### Indicators displayed in the recording mode

The indicators are not recorded on the tape.

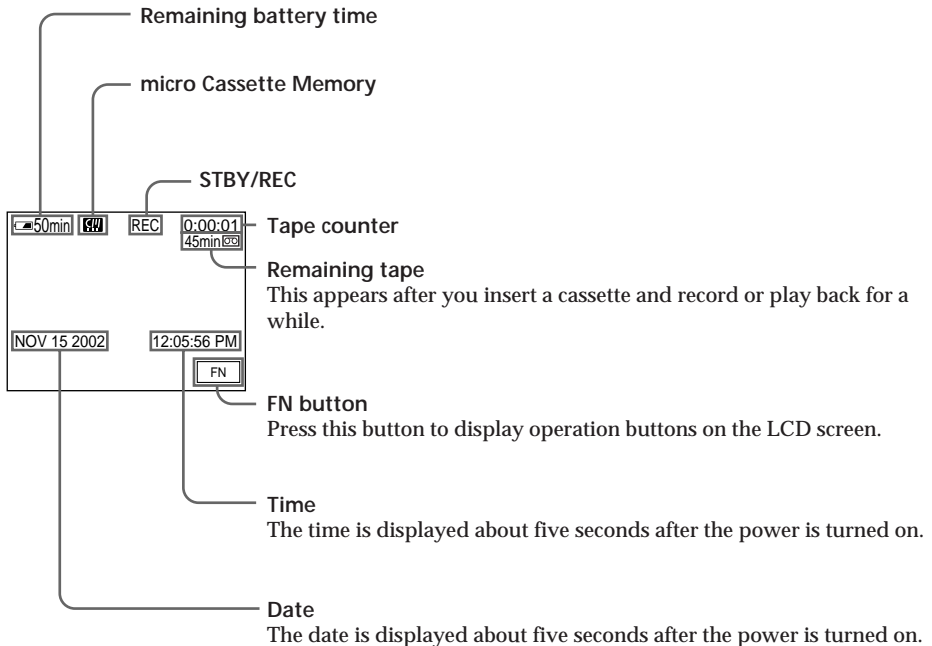

---

#### Remaining battery time indicator during recording

The remaining battery time indicator shows the approximate recording time. The indicator may not be correct, depending on the conditions in which you are recording. When you close the LCD panel and open it again, it takes about one minute for the correct remaining battery time in minutes to be displayed.

#### Tape counter

The tape counter can be reset using COUNT RESET in the PAGE3 screen.

#### Recording data

The recording data (date/time or various settings when recorded) are not displayed during recording. However, they are recorded automatically onto the tape. To display the recording data, press DATA CODE during playback. You can also use the Remote Commander for this operation (p. 43).

### Shooting a backlit subject – BACK LIGHT

When you shoot a subject with the light source behind the subject or a subject with a light background, use the backlight function.

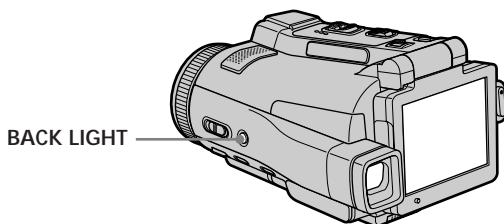

(1) Set the POWER switch to CAMERA or MEMORY.

(2) Press BACK LIGHT.

The  indicator appears on the LCD screen.

To cancel, press BACK LIGHT again.

During back light function

The backlight function will be canceled when you press MANUAL in the EXPOSURE mode (p. 65) or SPOT METER (p. 66).

### Shooting in the dark – NightShot/Super NightShot/Color Slow Shutter

#### Using NightShot

NightShot enables you to shoot a subject in a dark place. For example, you can satisfactorily record the environment of nocturnal animals for observation when you use this function.

(1) Set the POWER switch to CAMERA or MEMORY.

(2) Set NIGHTSHOT/NIGHTFRAMING to NIGHTSHOT.

The  and "NIGHTSHOT" indicators flash on the LCD screen.

To cancel NightShot, set NIGHTSHOT/NIGHTFRAMING to the center position (green ● position).

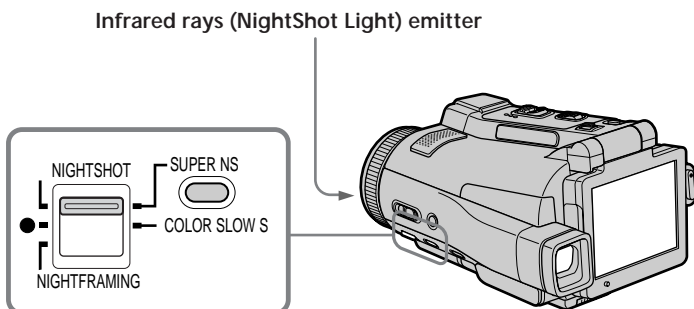



## Recording a picture

---

### Using Super NightShot

Super NightShot makes subjects more than 16 times brighter than those recorded in NightShot.

- (1) Set the POWER switch to CAMERA.
- (2) Set NIGHTSHOT/NIGHTFRAMING to NIGHTSHOT. The  and "NIGHTSHOT" indicators flash on the LCD screen.
- (3) Press SUPER NS.  
The  and "SUPER NIGHTSHOT" indicators flash on the LCD screen.  
To cancel Super NightShot, press SUPER NS again and then set NIGHTSHOT/NIGHTFRAMING to the center position (green ● position).

### Using the NightShot Light

The picture will be clearer with the NightShot Light on. To activate NightShot Light, set N.S. LIGHT in  to ON in the menu settings (The default setting is ON.).

### Using Color Slow Shutter

Color Slow Shutter enables you to record color images in a dark place.

- (1) Set the POWER switch to CAMERA.
- (2) Set NIGHTSHOT/NIGHTFRAMING to the center position (green ● position).
- (3) Press COLOR SLOW S.  
The  and COLOR SLOW SHUTTER indicators flash on the LCD screen.  
To cancel Color Slow Shutter, press COLOR SLOW S again.

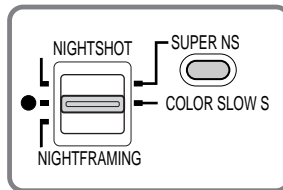

---

#### Notes

- Do not use the NightShot in bright places (ex. outdoors in the daytime). This may cause your camcorder to malfunction.
- While using the NightShot in normal recording, the picture may be recorded in incorrect or unnatural colors.
- If focusing is difficult with the autofocus mode when using the NightShot, focus manually.
- Do not cover the NightShot Light emitter when using the NightShot.
- Detach the lens hood when you shoot with the NightShot Light since the lens hood may block the NightShot Light.

While using **NightShot**, you cannot use the following functions:

- White balance
- PROGRAM AE
- Exposure
- Flexible Spot Meter
- HOLOGRAM AF

While using **Super NightShot**, you cannot use the following functions:

- Recording still images
- Recording with the flash
- White balance
- Fader
- Digital effect
- PROGRAM AE
- Exposure
- Flexible Spot Meter
- Memory overlap of MEMORY MIX

While using **Color Slow Shutter**, you cannot use the following functions:

- Recording still images
- Recording with the flash
- Fader
- Digital effect
- PROGRAM AE
- Exposure
- Flexible Spot Meter
- Memory overlap of MEMORY MIX

While using **Super NightShot** or **Color Slow Shutter**

The shutter speed will be automatically adjusted depending on the brightness of the background. The motion of the moving picture may slow down.

When the **POWER** switch is set to **MEMORY**

You cannot use following functions:

- Super NightShot
- Color Slow Shutter

**NightShot Light**

NightShot Light rays are infrared and so are invisible. The maximum shooting distance using the NightShot Light is about 3 m (10 feet).

**In dark places**

Color Slow Shutter may not work properly.

**About NightFraming**

See page 119.

## Recording a picture

### Self-timer recording

Recording automatically starts in about 10 seconds after you set the self-timer. You can also use the Remote Commander for this operation.

- (1) Set the POWER switch to CAMERA.
- (2) Press FN to display PAGE1 (p. 27).
- (3) Press SELFTIMER.

The  (self-timer) indicator appears on the LCD screen.

- (4) Press EXIT to make PAGE1 disappear.
- (5) Press START/STOP.

The self-timer starts counting down from about 10 with a beep sound. In the last two seconds of the countdown, the beep sound gets faster, then recording starts automatically.

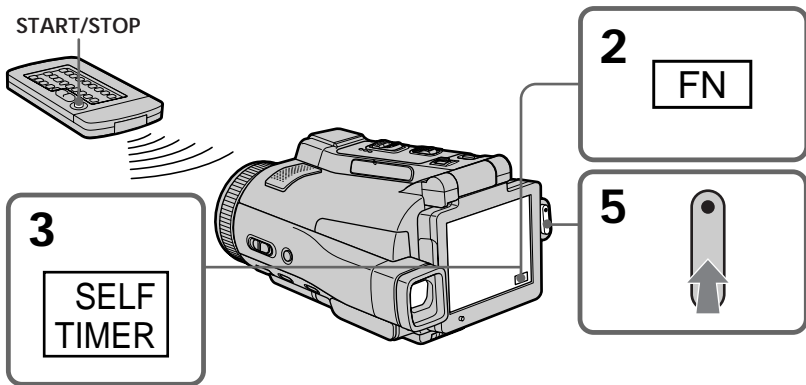

#### To stop the countdown

Press START/STOP.

To restart the countdown, press START/STOP again.

#### To cancel self-timer recording

Press SELFTIMER so that the  (self-timer) indicator disappears from the LCD screen while your camcorder is in the standby mode. You cannot cancel self-timer recording using the Remote Commander.

---

#### Note

The self-timer recording is automatically canceled when:

- Self-timer recording is finished.
- The POWER switch is set to (CHG) OFF or VCR.



# Checking the recording – END SEARCH

You can go to the end of the recorded section after you record. It is convenient when you make the transition between the last recorded scene and the next scene you record smooth.

- (1) Set the POWER switch to CAMERA.
- (2) Press FN to display PAGE1 (p. 27).
- (3) Press END SCH.

The last five seconds of the recorded section are played back and your camcorder returns to the standby mode. You can monitor the sound from the speaker or headphones.

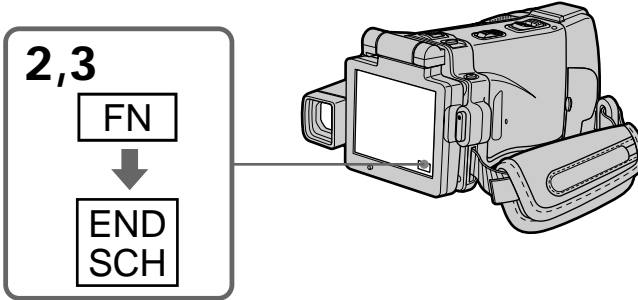

## To return to FN

Press EXIT after step 3.

## To stop searching

Press END SCH again.



---

Even once you eject the cassette

The end search function works.

# Playing back a tape

You can monitor the recorded tape on the LCD screen. If you close the LCD panel, you can monitor the playback picture in the viewfinder. You can also control playback using the Remote Commander.

- (1) Prepare the power source and insert the recorded tape.
- (2) Set the POWER switch to VCR.  
The VCR lamp lights up.
- (3) Open the LCD panel.
- (4) Press  to rewind the tape.
- (5) Press  to start playback.
- (6) Adjust the volume following the steps below.
  - ① Press FN to display PAGE1 (p. 27).
  - ② Press VOL. The screen for the volume adjustment appears.
  - ③ Press -/+ to adjust the volume.
    - : To decrease the volume
    - + : To increase the volume
- (7) Press  OK. The display returns to PAGE1.

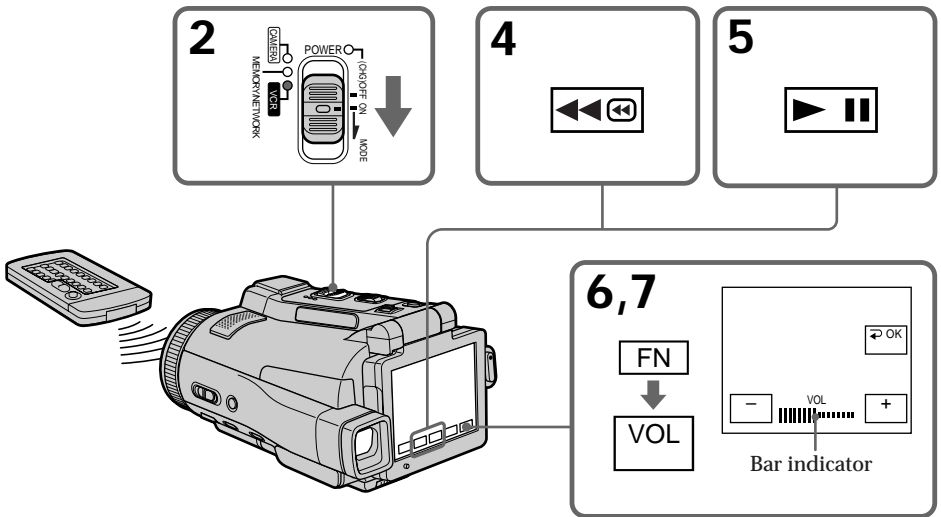

## To return to FN

Press EXIT after step 7.

## To stop playback

Press  on the LCD screen or STOP on the Remote Commander.

---

If you leave the power on for a long time

Your camcorder gets warm. This is not a malfunction.

## To display the screen indicators – Display function

Press DISPLAY/TOUCH PANEL on your camcorder or DISPLAY on the Remote Commander. The indicators disappear on the LCD screen.

To make the indicators appear, press DISPLAY/TOUCH PANEL or DISPLAY again.

### Using the data code function

Your camcorder automatically records not only images on the tape but also the recording data (date/time or various settings when recorded) (**data code**).

Follow the steps below to display the data code using the touch panel or the Remote Commander.

#### Using the touch panel

- (1) In the playback mode, press FN and go to PAGE3.
- (2) Press DATA CODE.

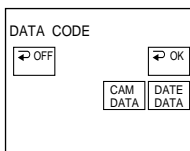

- (3) Select CAM DATA or DATE DATA, then press → OK.
- (4) Press EXIT.

#### Using the Remote Commander

Press DATA CODE on the Remote Commander in the playback mode.

The display changes as follows:

date/time → various settings (SteadyShot off, exposure, white balance, gain, shutter speed, aperture value) → no indicator

#### To not display various settings

Set DATA CODE in **ETC** to DATE in the menu settings (p. 185).

The display changes as follows when you press DATA CODE on the Remote Commander:

date/time ↔ no indicator

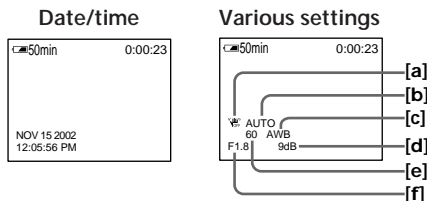

- [a] SteadyShot off
- [b] Exposure mode
- [c] White balance
- [d] Gain
- [e] Shutter speed
- [f] Aperture value

## Playing back a tape

---

### Various settings

Various settings shows your camcorder's recording information at the time of recording. In the recording mode, the various settings will not be displayed.

**When you use the data code function, bars (-- -- --) appear if:**

- A blank portion of the tape is being played back.
- The tape is unreadable due to tape damage or noise.
- The tape was recorded by a camcorder without the date and time set.

### Data code

When you connect your camcorder to a TV, the data code also appears on the TV screen.



### Remaining battery time indicator during playback

The indicator shows the approximate continuous playback time. The indicator may not be correct, depending on the conditions in which you are playing back. When you close the LCD panel and open it again, it takes about one minute for the correct remaining battery time to be displayed.



### Various playback modes

To operate video control buttons, set the POWER switch to VCR.



#### To view a still image (playback pause)

- Press  during playback. To resume playback, press  again.
- Press PAUSE on the Remote Commander during playback. To resume normal playback, press PAUSE again.



#### To fast-forward the tape

- Press  in the stop mode. To resume normal playback, press .
- Press FF on the Remote Commander in the stop mode. To resume normal playback, press PLAY.



#### To rewind the tape

- Press  in the stop mode. To resume normal playback, press .
- Press REW on the Remote Commander in the stop mode. To resume normal playback, press PLAY.



#### To locate a scene monitoring the picture (picture search)

- Keep pressing  or  during playback. To resume normal playback, release the button.
- Keep pressing REW or FF on the Remote Commander during playback. To resume normal playback, release the button.

#### To monitor the high-speed picture while fast-forwarding or rewinding the tape (skip scan)

- Keep pressing  while rewinding or  while advancing the tape. To resume rewinding or advancing, release the button.
- Keep pressing REW on the Remote Commander while rewinding the tape, or keep pressing FF on the Remote Commander while advancing the tape. To resume normal rewinding or advancing, release the button.





#### To view the picture at slow speed (slow playback)

Press SLOW on the Remote Commander during playback. To pause playback, press  or PAUSE on the Remote Commander. To resume normal playback, press  or PLAY on the Remote Commander again.

#### To search the last scene recorded (END SEARCH)

Press END SCH on PAGE2 in the stop mode. The last five seconds of the recorded section are played back then your camcorder stops.

#### Video control buttons on the LCD screen

-  To play back or pause a tape
-  To stop a tape
-  To rewind a tape
-  To fast-forward a tape

#### When the playback pause mode lasts for five minutes

Your camcorder automatically enters the stop mode. To resume playback, press  or PLAY on the Remote Commander.

# Viewing the recording on TV

Connect your camcorder to your TV with the supplied A/V connecting cable to watch the playback pictures on the TV screen. You can operate the playback control buttons in the same way as when you view playback pictures on the LCD screen. When viewing the playback picture on the TV screen, we recommend that you power your camcorder from a wall outlet using the AC power adaptor (p. 21). Refer to the operating instructions of your TV.

Open the jack cover. Connect your camcorder to the TV with the A/V connecting cable. Then, set the TV/VCR selector on the TV to VCR. The supplied A/V connecting cable is equipped with an S video plug and a video plug. Use either the S video plug or the video plug depending on the TV. Do not connect both of the plugs to the TV.

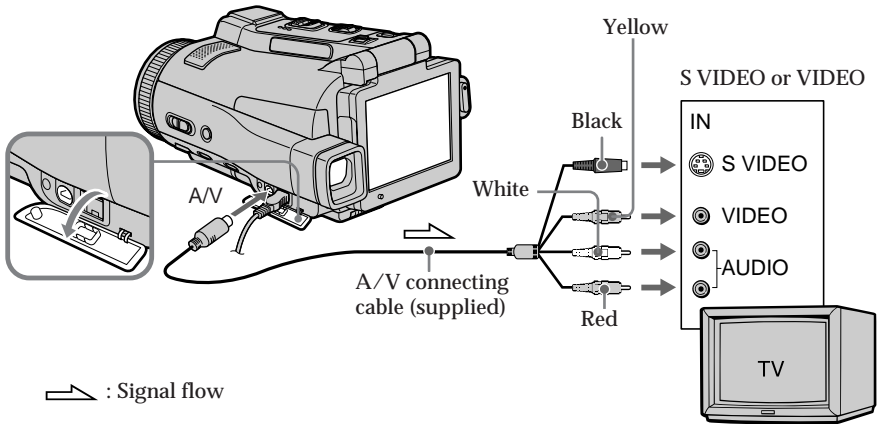

## If your TV is already connected to the VCR

Connect your camcorder to the LINE IN input on the VCR with the A/V connecting cable supplied with your camcorder. Set the input selector on the VCR to LINE.

## If your TV or VCR is a monaural type

Connect the yellow plug of the A/V connecting cable to the video input jack and the white or red plug to the audio input jack on the VCR or the TV. If you connect the white plug, the sound is an L (left) signal. If you connect the red plug, the sound is an R (right) signal.

### If your TV has an S video jack

Connect using the S video plug to faithfully obtain original pictures. With this connection, you do not need to connect the yellow (video) plug of the A/V connecting cable. Connect the S video plug to the S video jack on the TV or VCR. This connection produces higher quality MICROMV format pictures.

### To display the LCD screen indicators on TV

Set DISPLAY in  $\overline{\text{ETC}}$  to V-OUT/LCD in the menu settings (p. 185).

To turn off the LCD screen indicators, press DISPLAY/TOUCH PANEL.

# Recording still images on a “Memory Stick” in CAMERA mode

You can record still images on a “Memory Stick” in the recording standby mode or while recording on tape in CAMERA mode.

## Before operation

Insert a “Memory Stick” into your camcorder.

(1) Set the POWER switch to CAMERA.

(2) In the recording standby mode, keep pressing PHOTO lightly until a still image appears.

The CAPTURE indicator appears. The still image will be displayed. Recording does not start yet. To change the still image, release PHOTO, select a still image again, and then press and hold PHOTO lightly.

(3) Press PHOTO deeper.

Recording is complete when the bar scroll indicator disappears.

The image when you pressed PHOTO deeper will be recorded on the “Memory Stick.”

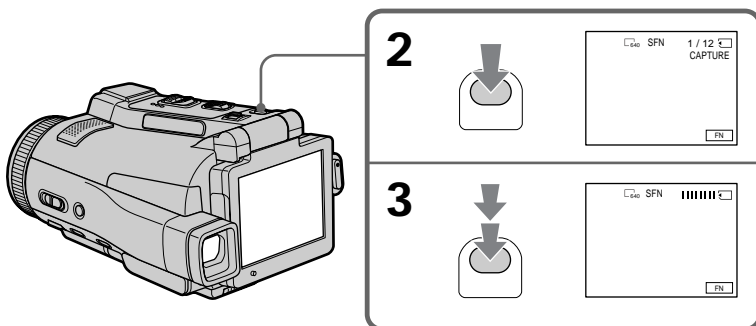

## Notes

- Do not shake or strike your camcorder when you record still images. Mosaic pattern image may appear.
- You cannot record still images on a “Memory Stick” during following operations (📷 indicator flashes on the LCD screen.):
  - Super NightShot
  - Color Slow Shutter
  - END SEARCH
  - Wide mode
  - Fader
  - Picture effect
  - Digital effect
  - MEMORY MIX

## “Memory Stick”

See page 100 for more information.

## Recording still images on a “Memory Stick” in CAMERA mode

---

### Image size of still images

Image size is automatically set to 640 × 480.

When you want to record still images in different sizes, use the Memory Photo recording function (p. 111).

### When the POWER switch is set to CAMERA

You cannot select image quality mode.

The image quality mode you last selected is used. (The default setting is SUPER FINE.) See page 105 for more information.

### To record still images on a “Memory Stick” during tape recording

- You cannot check an image on the LCD screen by pressing PHOTO lightly.
- During and after recording still images on a “Memory Stick,” your camcorder continues recording on tape.

### When you press PHOTO on the Remote Commander to record still images

The image when you press PHOTO will be recorded on the “Memory Stick.”

### To record images with higher quality

We recommend you use the Memory Photo recording function (p. 111).

You cannot record a title.



## Recording still images on a "Memory Stick" in CAMERA mode

### Recording images with the flash

The flash pops up automatically. The default setting is auto (no indicator). To change the flash mode, press **⚡** (flash) repeatedly until the flash mode indicator appears on the LCD screen.

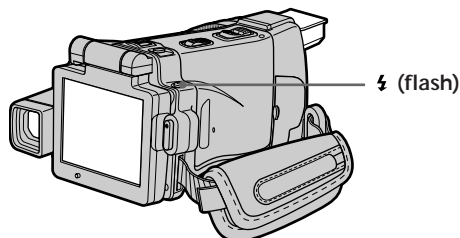

Each press of **⚡** (flash) changes the indicator as follows:

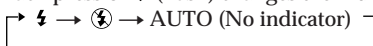

When you set RED EYE R in **🔴** to ON in the menu settings (p. 178), the indicator changes as follows:

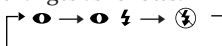

- |                                      |  |
|--------------------------------------|--|
| <b>⚡</b> Forced flash:               | The flash fires regardless of the surrounding brightness.                                    |
| <b>🔴</b> Auto red-eye reduction:     | The flash fires before recording to reduce red-eye.  |
| <b>🔴 ⚡</b> Forced red-eye reduction: | The flash fires before recording to reduce red-eye regardless of the surrounding brightness. |
| <b>🔴 🔴</b> No flash:                 | The flash does not fire.   |

The amount of flash is automatically adjusted to the appropriate brightness. You can also change FLASH LVL to the desired brightness in the menu settings (p. 178). Try recording various images to find the most appropriate setting for FLASH LVL.

#### Notes

- The recommended shooting distance using the built-in flash is 0.3 m to 2.5 m (31/32 feet to 8 1/3 feet).
- Attaching the lens hood (supplied) or a conversion lens (optional) may block the light from the flash or cause lens shadow to appear.
- Auto red-eye reduction (**🔴**) and Forced red-eye reduction (**🔴 ⚡**) may not produce the desired effect depending on individual differences, the distance to the subject, the subject not looking at the pre-recording flash or other conditions.
- The flash effect cannot be obtained easily when you use forced flash in a bright location.
- When recording with the flash, it takes longer to prepare for image capture. This is because your camcorder starts to charge power for firing after the flash pops up.
- The flash charge lamp flashes while the power for firing is being charged. After charging is completed, the flash charge lamp lights up.
- If it is not easy to focus on the subject automatically, for example, when recording in the dark, use the focal distance information (p. 67) for focusing manually.

## Recording still images on a “Memory Stick” in CAMERA mode

---

If you leave your camcorder for five or more minutes after removing the power source

Your camcorder returns to the default setting (auto).

You cannot shoot images with the flash during the following operations:

- Recording on the tape
- Super NightShot
- Color Slow Shutter
- END SEARCH
- Wide mode
- Fader
- Picture effect
- Digital effect
- MEMORY MIX

The flash does not fire even if you select auto (no indicator) and  (auto red-eye reduction) during the following operations:

- NightShot
- Spotlight of PROGRAM AE
- Sunset & moon of PROGRAM AE
- Landscape of PROGRAM AE
- Exposure
- Flexible Spot Meter

## Recording still images on a "Memory Stick" in CAMERA mode

### Self-timer recording

You can record still images with the self-timer. You can also use the Remote Commander for this operation.

#### Before operation

Insert a "Memory Stick" into your camcorder.

- (1) Set the POWER switch to CAMERA.
- (2) Press FN to display PAGE1.
- (3) Press SELFTIMER.  
The  (self-timer) indicator appears on the LCD screen.
- (4) Press EXIT to make PAGE1 disappear.
- (5) Press PHOTO deeper.

The self-timer starts counting down from about 10 with a beep. In the last two seconds of the countdown, the beep gets faster, then the recording starts automatically.

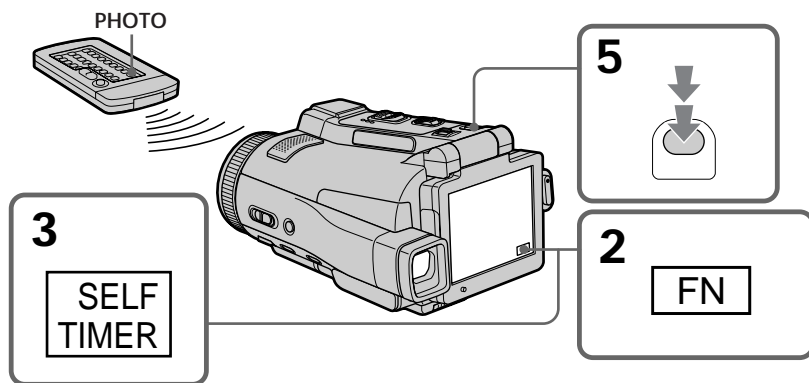

#### To cancel self-timer recording

Press SELFTIMER so that the  (self-timer) indicator disappears from the LCD screen while your camcorder is in the standby mode. You cannot cancel the self-timer recording using the Remote Commander.

#### Note

The self-timer recording is automatically canceled when:

- Self-timer recording is finished.
- The POWER switch is set to (CHG) OFF or VCR.

#### During recording on the tape

You cannot use self-timer recording.

# Adjusting the white balance manually

You can manually adjust and set the white balance. This adjustment makes white subjects look white and allows more natural color balance. Normally white balance is automatically adjusted.

- (1) Set the POWER switch to CAMERA or MEMORY.
- (2) Press FN to display PAGE1.
- (3) Press MENU, then select WHT BAL in  in the menu settings to select a desired white balance mode (p. 178).

**HOLD** : Recording a single-colored subject or background

**OUTDOOR** (☀) :

- Recording a sunset/sunrise, just after sunset, just before sunrise, neon signs, or fireworks
- Under a daylight fluorescent lamp

**INDOOR** (💡) :

- When lighting conditions change quickly
- In too bright places such as photography studios
- Under sodium lamps or mercury lamps

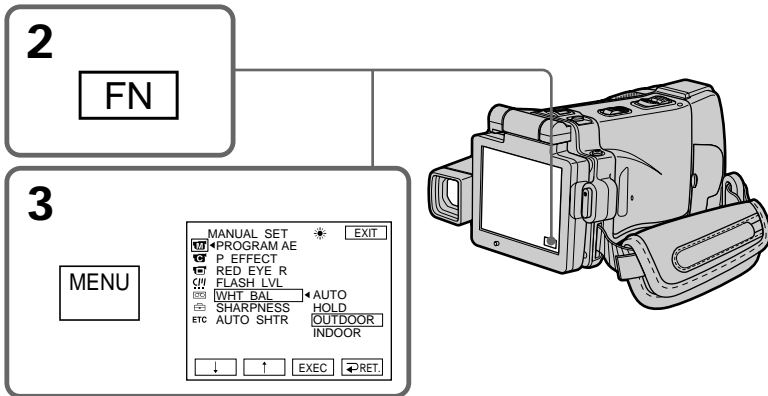

**To return to FN**

Press EXIT.

**To return to the automatic white balance mode**

Set WHT BAL to AUTO in the menu settings.

## Adjusting the white balance manually

---

### If the picture is being taken in a studio lit by TV lighting

We recommend that you record in the INDOOR mode.

### When you record under fluorescent lighting

Select AUTO or HOLD.

Your camcorder may not adjust the white balance correctly in the INDOOR mode.

### In the AUTO mode

Point your camcorder at the white subject for about 10 seconds after setting the POWER switch to CAMERA to get better adjustment when:

- You take out the battery for replacement.
- You bring your camcorder from indoors to outdoors holding the exposure, or vice versa.

### In the HOLD mode

Set the white balance to AUTO and reset to HOLD after a few seconds when:

- You change the PROGRAM AE mode.
- You bring your camcorder from indoors to outdoors, or vice versa.

# Using the wide mode

You can record a 16:9 wide picture to watch on the 16:9 wide-screen TV (16:9WIDE). Black bands appear on the LCD screen during recording in 16:9WIDE mode [a]. The picture during playing back on a normal TV [b] or a wide-screen TV [c] are compressed in the widthwise direction. If you set the screen mode of the wide-screen TV to the full mode, you can watch pictures of normal images [d].

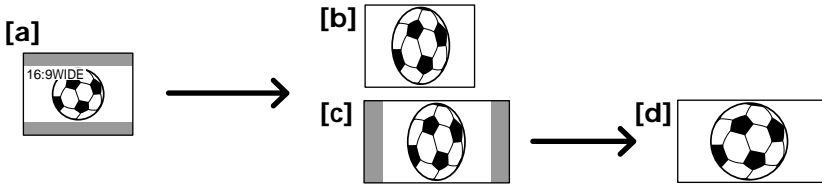

- (1) Set the POWER switch to CAMERA.
- (2) Press FN to display PAGE1.
- (3) Press MENU, then set 16:9WIDE in  to ON in the menu settings (p. 179).

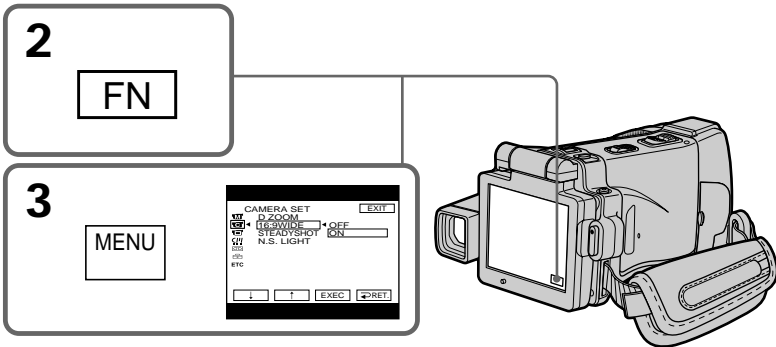

## To return to FN

Press EXIT.

## To cancel the wide mode

Set 16:9WIDE to OFF in the menu settings.

## Using the wide mode

---

In the wide mode, you cannot select the following functions:

- Recording still images
- BOUNCE
- OLD MOVIE

### During recording

You cannot select or cancel the wide mode. When you cancel the wide mode, set your camcorder to the recording standby mode and then set 16:9WIDE to OFF in the menu settings.

### Connection for a TV

Pictures recorded in the 16:9WIDE mode automatically appear on the TV screen at full size when:

- You connect your camcorder to a TV that is compatible with the video ID (ID-1/ID-2) system.
- You connect your camcorder to the S video jack on the TV.

### ID-1 system

The ID-1 system sends aspect ratio (screen horizontal/vertical ratio) information (16:9, 4:3, or letter box) with video signals.

### ID-2 system

The ID-2 system sends a copyright protection signal with ID-1 signals inserted between video signals when you connect your camcorder to other equipment using an A/V connecting cable.

# Using the fader function

You can fade in or out to give your recording a professional appearance.

[a]

STBY

REC

FADER



M. FADER  
(mosaic)



BOUNCE<sup>1) 2)</sup>



[b]

STBY

REC

MONOTONE

When fading in, the picture gradually changes from black-and-white to color.

When fading out, the picture gradually changes from color to black-and-white.

<sup>1)</sup> You can use the BOUNCE function when D ZOOM is set to OFF in the menu settings.

<sup>2)</sup> Fade in only



## Using the fader function

### (1) When fading in [a]

In the recording standby mode, press FADER until the desired fader indicator flashes.

### When fading out [b]

In the recording mode, press FADER until the desired fader indicator flashes. The indicator changes as follows:

→ FADER → M. FADER → BOUNCE → MONOTONE → (no indicator)

The last selected fader is indicated first of all.

### (2) Press START/STOP. The fader indicator stops flashing, then lights up.

After the fade in/out is carried out, the fader indicator goes off and your camcorder automatically returns to the normal mode.

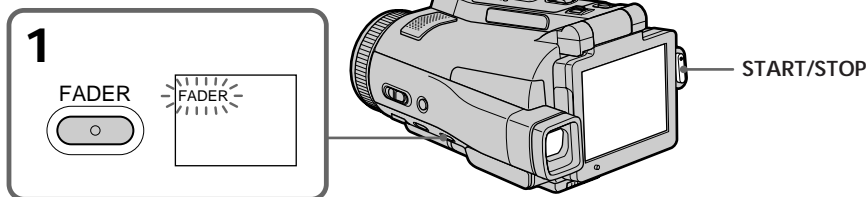

### To cancel the fader function

Before pressing START/STOP, press FADER until the indicator disappears.

#### Note

You cannot use the following functions while using the fader function. Also, you cannot use the fader function while using the following functions:

- Super NightShot
- Color Slow Shutter
- Recording still images
- Digital effect
- Memory overlap of MEMORY MIX

While using the BOUNCE function, you cannot use the following functions:

- Zoom
- Picture effect
- PROGRAM AE
- Exposure
- Flexible Spot Meter
- Focus

#### Note on the BOUNCE function

You cannot select the BOUNCE function in the following mode or functions:

- D ZOOM is activated in the menu settings.
- Wide mode
- Picture effect
- PROGRAM AE

When the POWER switch is set to MEMORY

You cannot use the fader function.

# Using special effects – Picture effect

You can digitally process images to obtain special effects like those in films or on the TV.

- NEG. ART [a]** : The color and brightness of the picture are reversed.  
**SEPIA** : The picture appears in sepia.  
**B&W** : The picture appears in monochrome (black-and-white).  
**SOLARIZE [b]** : The picture looks like an illustration with a strong contrast.  
**PASTEL [c]** : The picture looks like a pale pastel drawing.  
**MOSAIC [d]** : The picture appears mosaic-patterned.

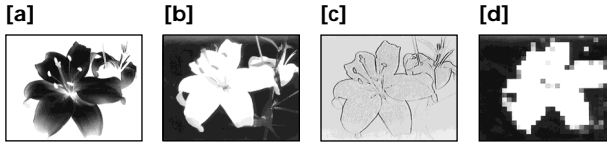

- (1) Set the POWER switch to CAMERA.
- (2) Press FN to display PAGE1.
- (3) Press MENU, then select P EFFECT in  in the menu settings to select a desired picture effect mode (p. 178).

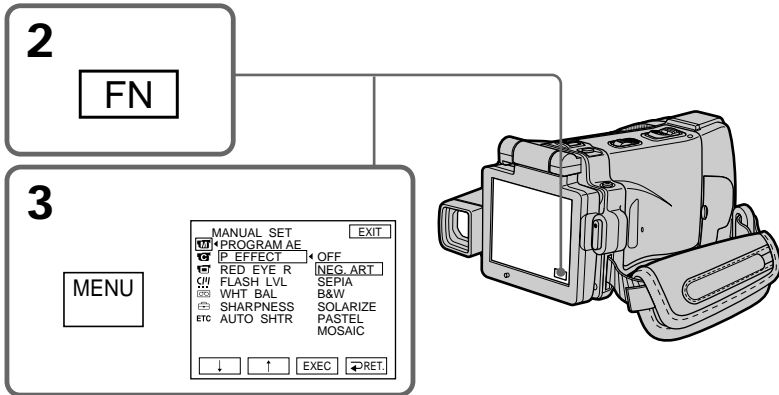

## To return to FN

Press EXIT.

## To turn the picture effect function off

Select OFF in P EFFECT in the menu settings.

While using the picture effect function, you cannot use following functions:

- Recording still images
- BOUNCE
- OLD MOVIE

When you turn the POWER switch to the other position

The picture effect is automatically canceled.

# Using special effects – Digital effect

You can add special effects to recorded pictures using the various digital functions. The sound is recorded normally.

## STILL

You can record a still image so that it is superimposed on a moving picture.

## FLASH (FLASH MOTION)

You can record still images successively at regular intervals.

## LUMI. (LUMINANCE KEY)

You can swap the brighter area in a still image with a moving picture.

## TRAIL

You can record a picture so that an incidental image like a trail is left.

## SLOW SHTR (SLOW SHUTTER)

You can slow down the shutter speed. The slow shutter mode is good for recording dark pictures more brightly.

## OLD MOVIE

You can add an old movie type atmosphere to pictures. Your camcorder automatically sets the wide mode to ON, the picture effect to SEPIA, and the appropriate shutter speed.

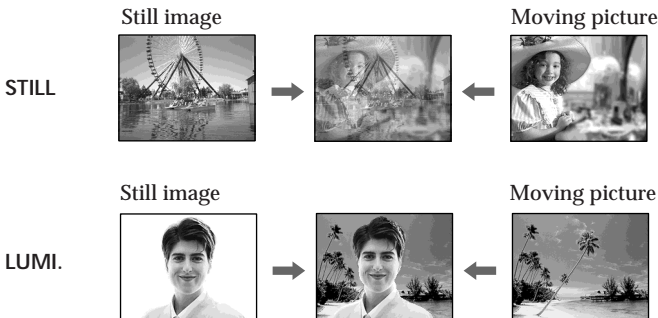

## Using special effects – Digital effect

- (1) Set the POWER switch to CAMERA.
- (2) Press FN and go to PAGE2.
- (3) Press DIG EFFT. The DIG EFFT screen appears.
- (4) Press a desired digital effect mode. In the STILL and LUMI. modes, the still image is stored in memory.
- (5) Press -/+ to adjust the effect.

### Items to adjust

STILL	The rate of the still image you want to superimpose on the moving picture
FLASH	The interval of frame by frame playback
LUMI.	The color scheme of the area in the still image which is to be swapped with a moving picture
TRAIL	The vanishing time of the incidental image
SLOW SHTR	Shutter speed. The larger the shutter speed number, the slower the shutter speed.
OLD MOVIE	No adjustment necessary

- (6) Press ↻ OK. The display returns to PAGE2.

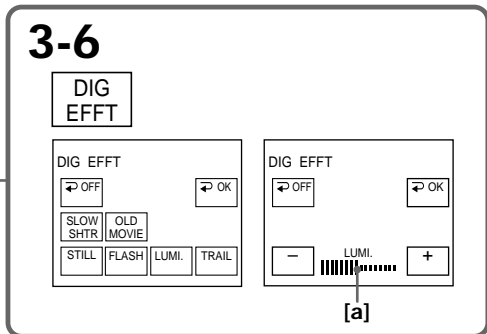
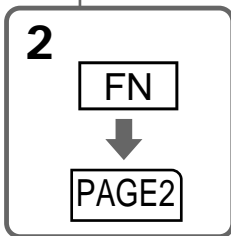
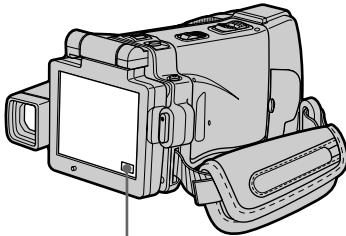

[a] The bar appears when setting following digital effect modes: STILL, FLASH, LUMI., TRAIL.

### To return to FN

Press EXIT after step 6.

### To cancel the digital effect

Press ↻ OFF in step 3. The display returns to PAGE2.

## Using special effects – Digital effect

---

### Notes

- The following functions do not work during digital effect:
  - Super NightShot
  - Color Slow Shutter
  - Recording still images
  - Fader
- The PROGRAM AE function does not work in the slow shutter mode.
- The following functions do not work in the OLD MOVIE mode:
  - Wide mode
  - Picture effect
  - PROGRAM AE

**When you turn the POWER switch to the other position**  
The digital effect will be automatically canceled.

**When recording in the slow shutter mode**  
Auto focus may not be effective. Focus manually using a tripod.

### Shutter speed

Shutter speed number	Shutter speed
SLOW SHTR 1	1/30
SLOW SHTR 2	1/15
SLOW SHTR 3	1/8
SLOW SHTR 4	1/4

# Using the PROGRAM AE

---

You can select PROGRAM AE (Auto Exposure) mode to suit your specific shooting requirements.

## SPOTLIGHT

This mode prevents people's faces, for example, from appearing excessively white when shooting subjects lit by strong light in the theater.

## PORTRAIT (Soft portrait)

This mode brings out the subject while creating a soft background for subjects such as people or flowers.

## SPORTS (Sports lesson)

This mode minimizes shake on fast-moving subjects such as in tennis or golf.

## BEACH&SKI

This mode prevents people's faces from appearing dark in strong light or reflected light, such as at a beach in midsummer or on a ski slope.

## SUNSETMOON (Sunset & moon)

This mode allows you to maintain atmosphere when you are recording sunsets, general night views, fireworks displays and neon signs.

## LANDSCAPE

This mode is for when you are record distant subjects such as mountains. Also it prevents your camcorder from focusing on glass or metal mesh in windows when you are recording a subject behind glass or a screen.



## Using the PROGRAM AE

- (1) Set the POWER switch to CAMERA or MEMORY.
- (2) Press FN to display PAGE1.
- (3) Press MENU, then select PROGRAM AE in  in the menu settings to select a desired mode (p. 178).

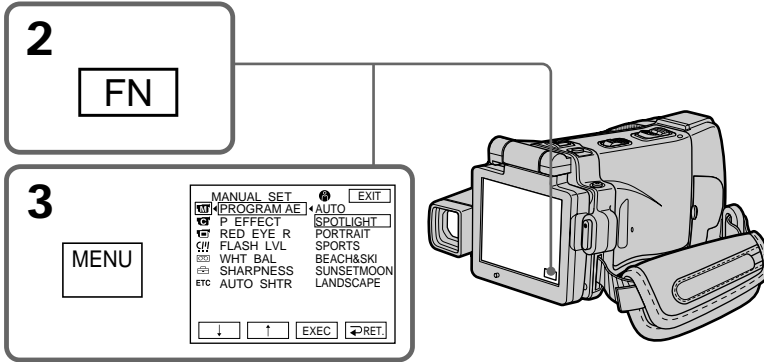

### To return to FN

Press EXIT.

### To turn the PROGRAM AE off

Select AUTO in PROGRAM AE in the menu settings.

### Notes

- Because your camcorder is set to focus only on subjects in the middle to far distance, you cannot take close-ups in the following modes:
  - Spotlight
  - Sports lesson
  - Beach & ski
- Your camcorder is set to focus only on distant subjects in the following modes:
  - Sunset & moon
  - Landscape
- The following functions do not work in PROGRAM AE:
  - Color Slow Shutter
  - BOUNCE
  - Slow shutter
  - OLD MOVIE
- The PROGRAM AE does not work in the following cases (The indicator flashes):
  - NightShot
  - NightFraming
  - To record images on a “Memory Stick” using the MEMORY MIX.
- When you set the POWER switch to MEMORY, sports lesson does not work. (The indicator flashes.)

## Using the PROGRAM AE

---

While WHT BAL is set to AUTO in the menu settings  
The white balance is adjusted even if the PROGRAM AE is selected.

You can adjust the following functions while using the PROGRAM AE:

- Exposure
- Flexible Spot Meter

If you record under a discharge tube such as a fluorescent lamp, sodium lamp or mercury lamp

Flickering or changes in color may occur in the following modes. If this happens, turn the PROGRAM AE off:

- Soft portrait
- Sports lesson



# Adjusting the exposure manually

You can adjust and set the exposure. Normally the exposure is automatically adjusted. Adjust the exposure manually in the following cases:

- To make a fine exposure adjustment
- To shoot a bright subject against a background
- To record dark pictures (e.g. night scenes) faithfully

- (1) Set the POWER switch to CAMERA or MEMORY.
- (2) Press FN to display PAGE1.
- (3) Press EXPOSURE. The EXPOSURE screen appears.
- (4) Press MANUAL.
- (5) Adjust the exposure using -/+.
  - : To dim
  - + : To brighten
- (6) Press  $\rightarrow$  OK. The display returns to PAGE1.

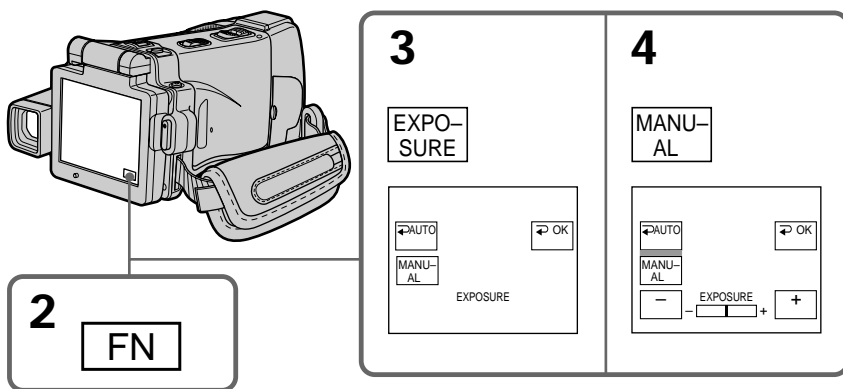

## To return to FN

Press EXIT after step 6.

## To return to the automatic exposure mode

Press  $\rightarrow$  AUTO in step 5. The display returns to PAGE1.

### Note

When you adjust the exposure manually, the following functions do not work:

- Backlight
- Color Slow Shutter

Your camcorder automatically returns to the automatic exposure mode:

- NightShot
- If you change the PROGRAM AE mode
- NightFraming

# Using the spot light-metering mode – Flexible Spot Meter

You can take a picture with the appropriate exposure automatically for just the point you want to focus on and with its exposure fixed. Use the Flexible Spot Meter mode in the following cases:

- The subject is backlit.
- When there is strong contrast between the subject and background such as with a subject that is on stage and lighted by a spotlight.

- (1) Set the POWER switch to CAMERA or MEMORY.
- (2) Press FN to display PAGE1.
- (3) Press SPOT METER. The SPOT METER screen appears.
- (4) Press the desired area in the frame on the LCD screen.  
The SPOT METER indicator flashes on the LCD screen. The exposure of the point you selected is adjusted.
- (5) Press  $\rightarrow$  OK. The display returns to PAGE1.

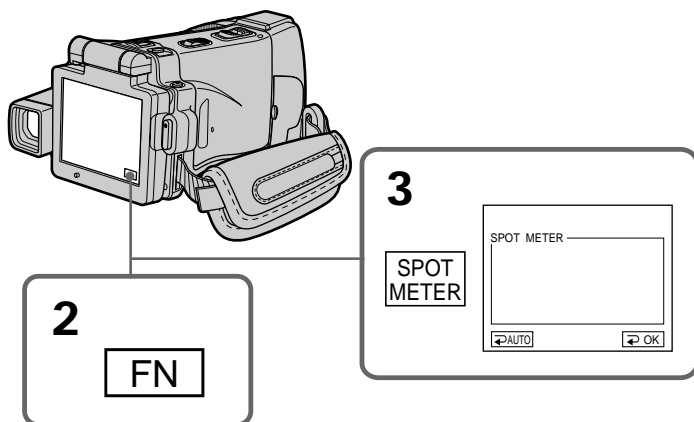

## To return to FN

Press EXIT after step 5.

## To return to the automatic exposure mode

Press  $\rightarrow$  AUTO in step 3. The display returns to PAGE1.

---

### Note

The following functions do not work during the Flexible Spot Meter:

- Backlight
- Color Slow Shutter

Your camcorder automatically returns from the Flexible Spot Meter to the automatic exposure:

- NightShot
- If you change the PROGRAM AE mode
- NightFraming

# Focusing manually

You can gain better results by manually adjusting the focus in the following cases. Normally, focus is automatically adjusted.

In MEMORY mode you can adjust the focus manually with the image enlarged to twice the size.

- The autofocus mode is not effective when shooting:
  - Subjects through glass coated with water droplets
  - Horizontal stripes
  - Subjects with little contrast with backgrounds such as walls or the sky
- When you want to change the focus from a subject in the foreground to a subject in the background
- Shooting a stationary subject when using a tripod

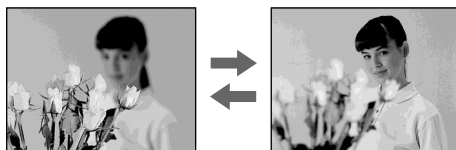

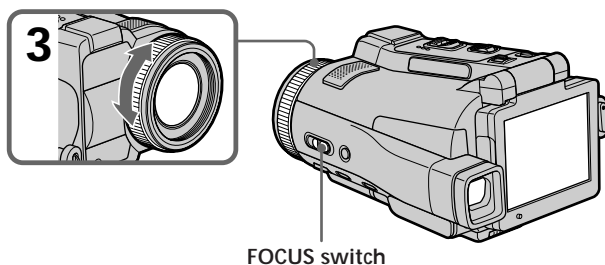

- (1) Set the POWER switch to CAMERA or MEMORY.
- (2) Set FOCUS to MANUAL. The  indicator appears.
- (3) Turn the focus ring to sharpen focus.



## To return to the autofocus mode

Set FOCUS to AUTO.

## About expanded focus

If you set EXPANDED F in  to ON in the menu settings (p. 179) in MEMORY mode, the  indicator appears and the image is enlarged to twice the size. The focal distance information is also displayed. Adjustment is completed, the image returns to its original size.

## Focusing manually

---



### To focus precisely

It is easier to focus on the subject if you adjust the zoom to shoot at the “W” (wide-angle) position after focusing at the “T” (telephoto) position.

### When you shoot close to the subject

Focus at the end of the “W” (wide-angle) position.

 changes as follows:

-  when recording a distant subject
-  when the subject is too close to focus on

Focal distance information is displayed for about three seconds on the LCD screen in the following cases:

- When switching the focus adjustment mode from autofocus to manual
- When turning the focus ring

### Focal distance information

- This information aids focusing if it is not easy to focus on the subject, for example, when recording in the dark. Use this information as a rough guide to get a sharp focus.
- You cannot get correct information if you have attached a conversion lens (optional) to your camcorder.

# Using the spot focus mode – Spot Focus

You can take a picture with the appropriate focus automatically for just the point you want to focus on and with its focus fixed.

- (1) Set the POWER switch to CAMERA or MEMORY.
- (2) Set FOCUS to MANUAL.
- (3) Press FN to display PAGE1.
- (4) Press SPOT FOCUS. The SPOT FOCUS screen appears.
- (5) Press the desired area in the frame on the LCD screen.  
The SPOT FOCUS indicator flashes on the LCD screen. When the point you selected is correctly focused, the SPOT FOCUS indicator stops flashing.
- (6) Press  $\rightarrow$  OK to return to PAGE1.

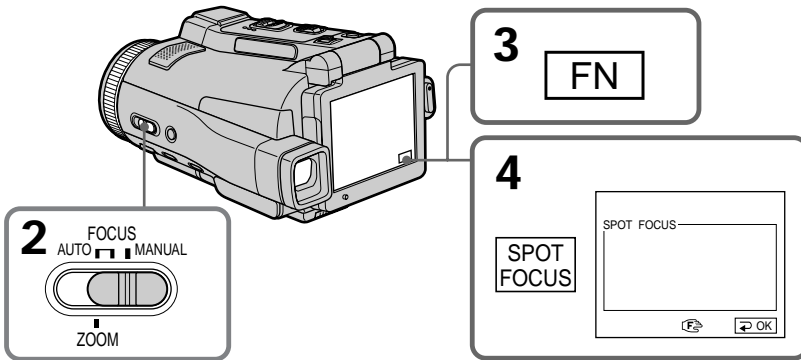

## To return to FN

Press EXIT after step 6.

## To return to the autofocus mode

Set FOCUS to AUTO.

### Note

When adjusting Spot Focus, the following modes do not work:

- Backlight
- Fader

### Focal distance information

It is not displayed on the screen.

# Playing back a tape with picture effects

During playback, you can process a scene using the picture effect functions: NEG. ART, SEPIA, B&W and SOLARIZE.

- (1) Set the POWER switch to VCR. In the playback or playback pause mode, press FN to display PAGE1.
- (2) Press MENU, then select P EFFECT in  in the menu settings to select a desired picture effect mode (p. 178).  
See page 58 for details of each picture effect function.

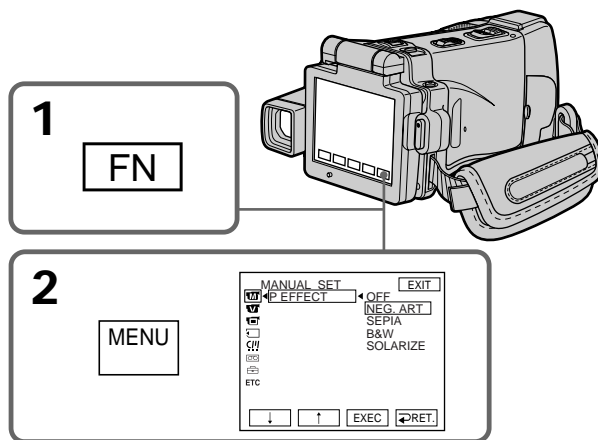

## To return to FN

Press EXIT.

## To cancel the picture effect function

Set P EFFECT to OFF in the menu settings.

### Notes

- You cannot process externally input scenes using the picture effect function.
- You cannot record images on a tape on your camcorder while you are processing the image using the picture effect function. However, you can record images on a “Memory Stick” (p. 121, 133), or on a VCR using your camcorder as a player.

### Pictures processed by the picture effect function

Pictures processed by the picture effect function are not output through the i.LINK (MICROMV Interface).

When you turn the POWER switch to the other position or stop playing back  
The picture effect function is automatically canceled.

# Playing back a tape with digital effects

During playback, you can process a scene using the digital effect functions: STILL, FLASH, LUMI. and TRAIL.

- (1) Set the POWER switch to VCR. In the playback or playback pause mode, press FN and go to PAGE2.
- (2) Press DIG EFFT. The DIG EFFT screen appears.
- (3) Select a desired digital effect mode. In the STILL or LUMI. mode, the picture that you select the mode is stored in memory as a still image.
- (4) Press -/+ to adjust the effect. See page 59 for details.
- (5) Press ↵ OK. The display returns to PAGE2.

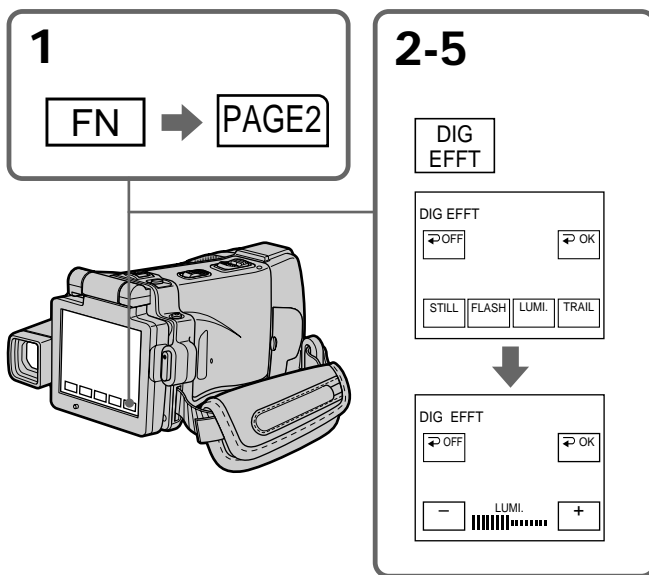

## To return to FN

Press EXIT after step 5.

## To cancel the digital effect function

Press ↵ OFF in step 2. The display returns to PAGE2.

## Notes

- You cannot process externally input scenes using the digital effect function.
- You cannot record images on a tape on your camcorder while you are processing the image using the digital effect function. However, you can record images on a "Memory Stick" (p. 121, 133), or on a VCR using your camcorder as a player.

## Pictures processed by the digital effect function

Pictures processed by the digital effect function are not output through the i.LINK (MICROMV Interface).

When you turn the POWER switch to the other position or stop playing back The digital effect function is automatically canceled.

# Enlarging images recorded on tapes – Tape PB ZOOM

You can enlarge playback moving pictures recorded on tapes. Besides the operation described here, your camcorder can enlarge still images recorded on a “Memory Stick” (p. 143).

- (1) Set the POWER switch to VCR. In the playback or playback pause mode, press FN and go to PAGE2.
- (2) Press PB ZOOM. The PB ZOOM screen appears.
- (3) Press the area you want to enlarge in the frame on the PB ZOOM screen.  
The area you pressed moves to the center of the LCD screen, and the playback image is enlarged to twice the size. If you press the other area again, the area moves to the center of the LCD screen.
- (4) Adjust the zoom ratio by the zoom lever.  
You can enlarge the image from 1.1 times up to five times its size.  
“W” side: Decrease the zoom ratio.  
“T” side: Increase the zoom ratio.

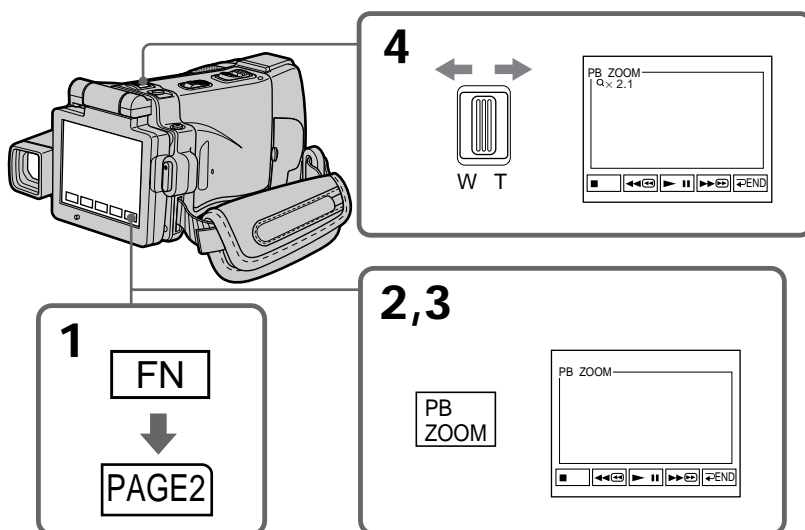

## To cancel the PB ZOOM function

Press ↶ END.



## Enlarging images recorded on tapes – Tape PB ZOOM

---

### Notes

- You cannot process externally input scenes using the PB ZOOM function with your camcorder.
- You cannot record images on a tape on your camcorder while you are processing the image using the tape PB ZOOM function. However, you can record images on a “Memory Stick” (p. 121), or on a VCR using your camcorder as a player.
- You cannot record moving pictures on a “Memory Stick” on your camcorder while you are processing the picture using the tape PB ZOOM function.

The PB ZOOM function is automatically canceled when you operate the following functions:

- Turn the POWER switch to the other position.
- Stop playing back.
- Insert a “Memory Stick.”

### Images in the PB ZOOM

Images in the PB ZOOM mode are not output through the i.LINK (MICROMV Interface) and  $\Psi$  (USB) jack.

### In the PB ZOOM mode

If you press DISPLAY/TOUCH PANEL, the frame on the PB ZOOM screen disappears. You cannot move the part you pressed to the center of the LCD screen.

### Edge of the enlarged image

The edge of the enlarged image cannot be displayed at the center of the LCD screen.

### When FOCUS is set to ZOOM

You can change the zoom ratio using the zoom ring.

# Searching for a scene - MULTI-PICTURE SEARCH

Using the multi-picture search function, you can display thumbnails of all the beginning scenes of moving pictures recorded on the tape onto the index screen. The recording date and title of each image or scene are also indicated. The thumbnails described in this section are the still images of all the beginning scenes of each recorded moving pictures and still images to help you search for the desired scene easily. When you select the thumbnail you want to play back, your camcorder starts searching for the image or scene and plays it back automatically.

You can also control this function using the Remote Commander.

- (1) Set the POWER switch to VCR.
- (2) Press FN to display PAGE1.
- (3) Press MULTI SCH. The MULTI SCH screen appears.
- (4) Press  $\leftarrow/\rightarrow$  to select the direction to scan. Your camcorder starts scanning in the selected direction. When you select  $\rightarrow$ , the thumbnails are displayed from the upper-left window, and when you select  $\leftarrow$ , they are displayed from the lower-right window. When scanning is completed, it stops automatically. The upper-left window turns black and the thumbnails will be displayed on the index screen.

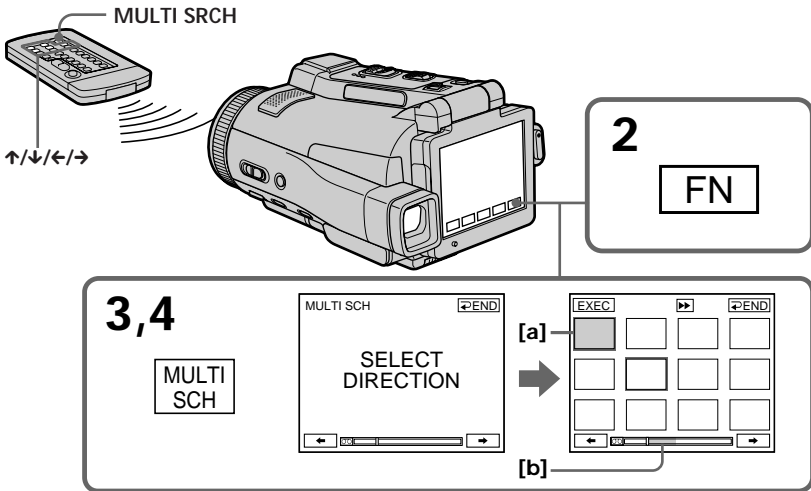

[a] The picture being fast-forwarded or rewound

[b] The blue portion indicates the range of the scan currently being made to display thumbnails

## Searching for a scene – MULTI-PICTURE SEARCH

- (5) Select the thumbnail you want to play back, then press EXEC or press the thumbnail you selected again. Your camcorder starts searching for the image or scene and plays it back automatically. The blue portion of the bar indicates the scanning range and the white portion of the bar indicates the recorded portion.

### When you want to change the thumbnail

Press  $\leftarrow$  RET, and then select the thumbnail you want to play back again, then press EXEC.

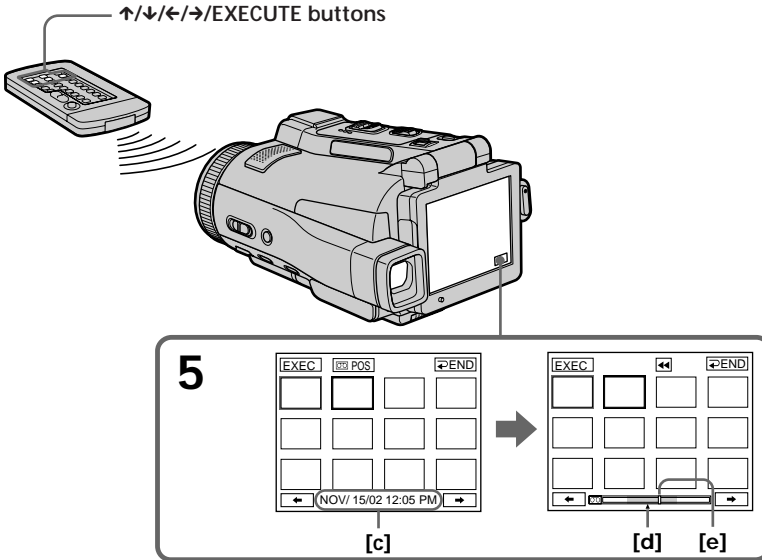

- [c] The title/ date (The title turns to the date indication after five seconds.)  
[d] The actual point you are trying to search for (yellow  $\blacktriangle$  mark)  
[e] The present point on the tape (yellow bar)

## Searching for a scene – MULTI-PICTURE SEARCH

---

### To return to the MULTI SCH screen from playback

Press  $\Rightarrow$  RET, or press EXECUTE on the Remote Commander.

### To stop searching

Press STOP on the Remote Commander.

### To end the multi-picture search function

Press  $\Rightarrow$  END. The display returns to PAGE1, or press MULTI SRCH on the Remote Commander to return to FN.

### To end the multi-picture search function from the playback screen

Press EXIT.

### When controlling your camcorder with the Remote Commander

You can use the MULTI SRCH and  $\uparrow/\downarrow/\leftarrow/\rightarrow$ /EXECUTE buttons.

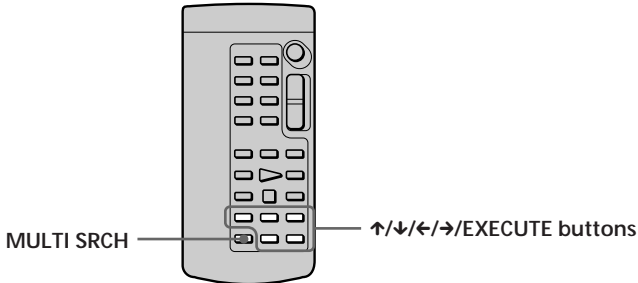

---

#### Notes

- Thumbnails may not be displayed depending on the condition of the tape. This is not a malfunction.
- Noise may appear on the thumbnails. However, this has no effect on the recorded images.

#### If the tape has a blank portion in the beginning of the tape or between recorded portions

The multi-picture search function may not work correctly.

#### The number of thumbnails stored in one cassette

About 400 thumbnails can be stored.

#### The number of thumbnails that can be displayed for in one scanning

A maximum of 11 thumbnails can be displayed for in one scanning.

#### When you press MULTI SRCH on the Remote Commander

The MULTI SCH screen appears.

#### While using the multi-picture search function

The other functions of your camcorder do not work.

## Searching for a scene – MULTI-PICTURE SEARCH

---

The thumbnail images displayed on the MULTI SCH screen

You cannot modify these thumbnail images.

When you use the multi-picture search function, you cannot use the following functions:

- Picture effect
- Digital effect

Some of the 11 thumbnails may not be displayed in the following cases:

- These are fewer than 11 recorded images and scenes on the searched portion of the tape.
- When scanning a tape recorded midway over previous recordings
- When you have erased all the micro Cassette Memory of the tape (p. 99)

To select the thumbnail with the Remote Commander

Press **↑/↓/←/→** on the Remote Commander.

When you press **DATE** or **POS**

You can switch to the title/date display or the tape bar display that shows the present point on the tape.

While your camcorder is searching for the image or scene, the tape bar display appears even if you select Title/Date.

When you select **←** or **→** during scanning

The next 11 thumbnails will be scanned.

Even if the first thumbnail is not displayed before the scanning is completed

You can play back the image or scene.

# Searching the boundaries of recorded tape by title – TITLE SEARCH

You can search for the boundaries of a recorded tape by selecting the title. Use the Remote Commander for this operation.

- (1) Set the POWER switch to VCR.
- (2) Press SEARCH MODE on the Remote Commander repeatedly, until the TITLE SEARCH indicator appears.

The indicator changes as follows:

TITLE SEARCH → DATE SEARCH  
↑ (no indicator) ←

- (3) Press ↑ or ↓ on the Remote Commander to select the title for playback, then press EXECUTE on the Remote Commander.  
Searching the boundaries starts, and playback automatically starts at the scene with the title selected. Even if you do not press EXECUTE, searching the boundaries starts automatically in two seconds after you select the title.

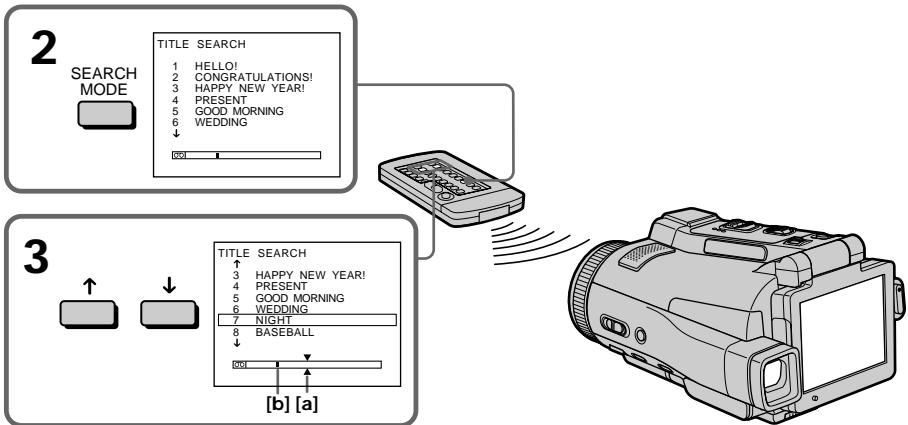

[a] Actual point you are trying to search for

[b] Present point on the tape

## To stop searching

Press STOP on the Remote Commander.

---

If a tape has a blank portion in the beginning of the tape or between recorded sections

The title search function may not work correctly.

To superimpose a title

See page 88.

# Searching a recording by date

## - DATE SEARCH

Your camcorder automatically searches for the point where the recording date changes and starts playback from that point by selecting the recording date (Date search). Use the Remote Commander for this operation. Use this function to check where recording dates change or to edit the tape at each recording date.

### Searching for the date by using cassette memory

- (1) Set the POWER switch to VCR.
- (2) Press SEARCH MODE on the Remote Commander repeatedly, until the DATE SEARCH indicator appears. The indicator changes as follows:

TITLE SEARCH → DATE SEARCH  
↑ (no indicator) ←

- (3) Press ↑ or ↓ on the Remote Commander to select the date for playback, then press EXECUTE on the Remote Commander. Searching the boundaries starts, and playback automatically starts at the scene with the date selected. Even if you do not press EXECUTE, searching the boundaries starts automatically in two seconds after you select the date.

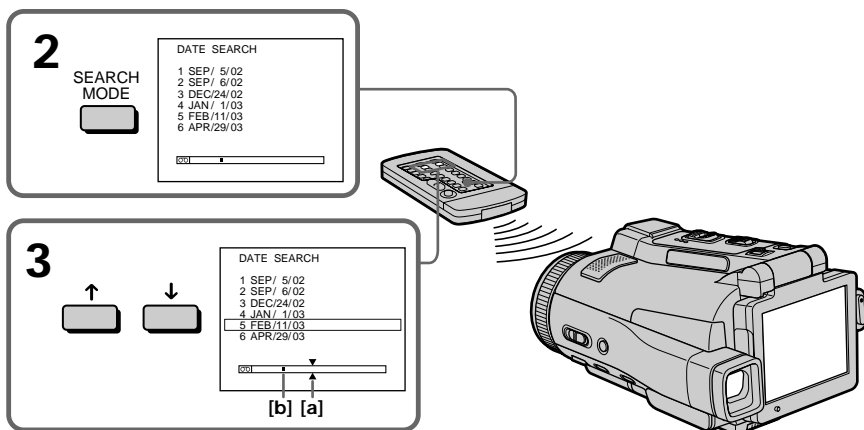

[a] Actual point you are trying to search for  
[b] Present point on the tape

### To stop searching

Press STOP on the Remote Commander.

If a tape has a blank portion in the beginning of the tape or between recorded portions

The date search function may not work correctly.

### micro Cassette Memory

The tape cassette memory can hold 20 recording date data.

# Dubbing a tape

## Using the A/V connecting cable

You can dub or edit on the VCR connected to your camcorder using your camcorder as a player. Connect your camcorder to the VCR using the A/V connecting cable. The supplied A/V connecting cable is equipped with an S video plug and a video plug. Use either the S video plug or the video plug depending on the recorder. Do not connect both of the plugs to the recorder.

### Before operation

- Set DISPLAY in  to LCD in the menu settings. (The default setting is LCD.)
- Press the following buttons to make the indicator disappear so that they will not be superimposed on the edited tape:

On your camcorder:

DISPLAY/TOUCH PANEL

On the Remote Commander:

DISPLAY, DATA CODE, SEARCH MODE, MULTI SRCH

- (1) Insert a blank tape (or a tape you want to record over) into the VCR, and insert the recorded tape into your camcorder.
- (2) Prepare the VCR for recording, then set the input selector to LINE.  
Refer to the operating instructions of the VCR.
- (3) Set the POWER switch to VCR.
- (4) Play back the recorded tape on your camcorder.
- (5) Start recording on the VCR.  
Refer to the operating instructions of your VCR.

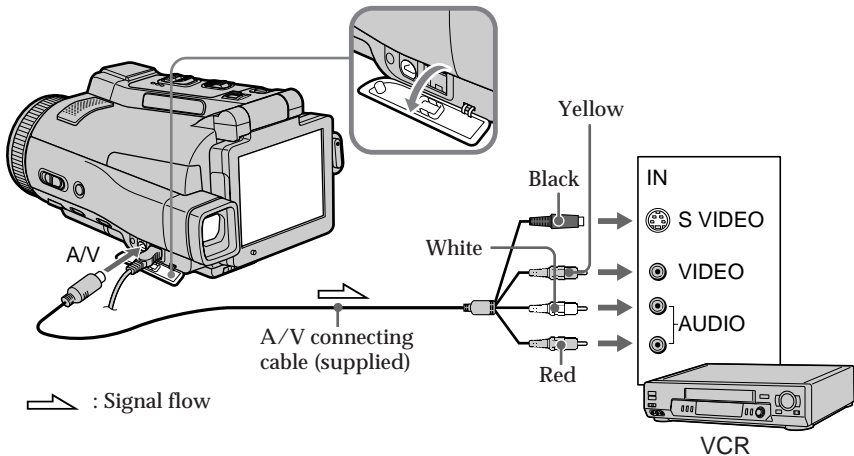

## When you have finished dubbing a tape

Stop recording on the VCR, and stop playback on your camcorder.



## Dubbing a tape

---

You can edit on VCRs that support the following systems

**8** 8 mm, **Hi8** Hi8, **D** Digital8, **VHS** VHS, **S-VHS** S-VHS, **VHS-C** VHS-C, **S-VHS-C** S-VHS-C, **B** Betamax, **ED Beta** ED Betamax, <sup>Mini</sup>**DV** mini DV, **DV** DV or **MICROMV** MICROMV

### If your VCR is a monaural type

Connect the yellow plug of the A/V connecting cable to the video input jack on the VCR and the white or red plug to the audio input jack on the VCR. When the white plug is connected, the left channel audio is output, and when the red plug is connected, the right channel audio is output.

### If your VCR has an S video jack

Connect using the S video plug to faithfully obtain original pictures. With this connection, you do not need to connect the yellow (video) plug of the A/V connecting cable. Connect the S video plug to the S video jack of the VCR. This connection produces higher quality MICROMV format pictures.

## Dubbing a tape

### Using the i.LINK cable

Simply connect the i.LINK cable (optional) to the i.LINK (MICROMV Interface) of your camcorder and to the i.LINK (MICROMV Interface) of the MICROMV product. With digital-to-digital connection, video and audio signals are transmitted in digital form for high-quality editing. (You cannot connect your camcorder to a DV product.) You cannot dub the titles, displayed indicators, the contents of micro Cassette Memory, or letters on the “Memory Stick” index screen.

- (1) Insert a blank tape (or a tape you want to record over) into the VCR, and insert the recorded tape into your camcorder.
- (2) Prepare the VCR for recording.
- (3) Set the POWER switch to VCR.
- (4) Play back the recorded tape on your camcorder.
- (5) Start recording on the VCR. Refer to the operating instructions of the VCR.

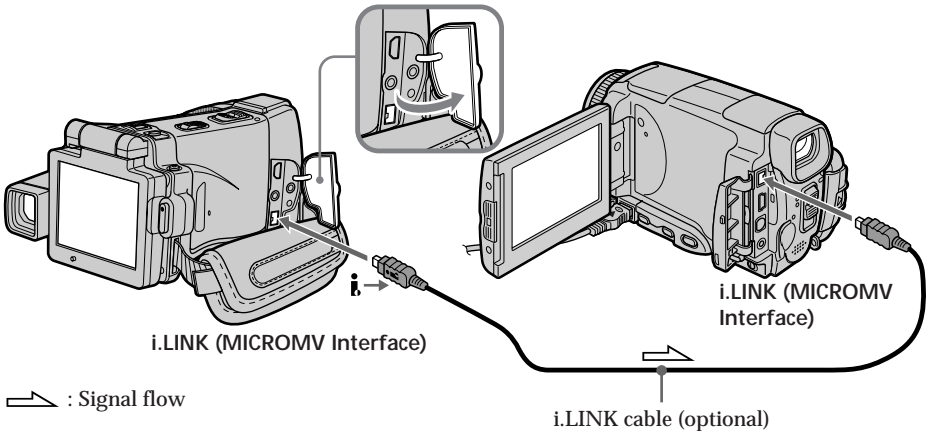

### When you have finished dubbing a tape

Stop recording on the VCR, and stop playback on your camcorder.

You can connect one VCR only using the i.LINK cable

See page 198 for more information about i.LINK.

Pictures processed by the picture effect, the digital effect or PB ZOOM function  
These pictures are not output through the i.LINK (MICROMV Interface).

The following functions do not work during digital editing:

- Picture effect
- Digital effect
- PB ZOOM

### Note on playback pause pictures

When you record a playback pause picture:

- The recorded picture becomes rough when recorded through the i.LINK (MICROMV Interface).
- The picture may jitter when you play back the tape on other video equipment. And there may be a time-lag when you play back the tape on other video equipment.

# Recording video or TV programs

## When using the A/V connecting cable

You can record a tape from another VCR or a TV program from a TV that has video/audio outputs. Use your camcorder as a recorder.

### 1 Switching the video input jack of the A/V connecting cable

The supplied A/V connecting cable is equipped with an S video plug and a video plug. You have to select one of the jacks in the menu settings. The default setting is VIDEO. If the setup is not necessary, go to “2 Making a recording” on page 84.

- (1) Set the POWER switch to VCR.
- (2) Press FN to display PAGE1.
- (3) Press MENU, then select VIDEOINPUT in  in the menu settings, then press EXEC.
- (4) Select VIDEO (When using a video plug) or S VIDEO (When using an S video plug), then press EXEC.

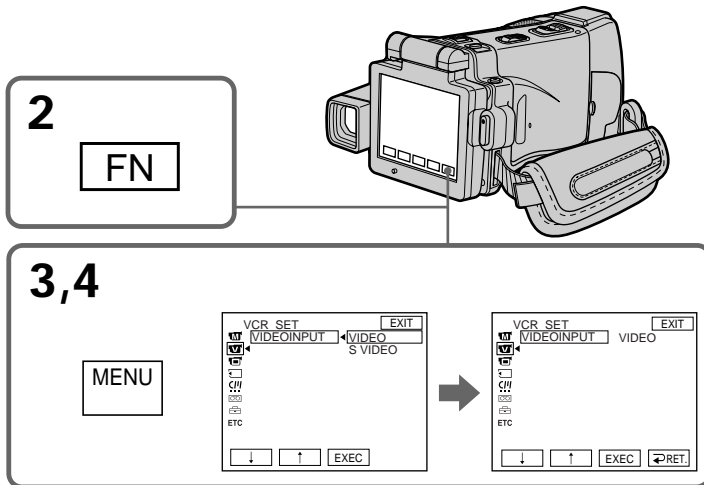

### To return to FN

Press EXIT.

## Recording video or TV programs

### 2 Making a recording

#### Before operation

Set DISPLAY in to LCD in the menu settings. (The default setting is LCD.)

- (1) Insert a blank tape (or a tape you want to record over) into your camcorder. If you are recording a tape from the VCR, insert a recorded tape into the VCR.
- (2) Set the POWER switch to VCR.
- (3) Set your camcorder in the recording pause mode.  
Press FN and go to PAGE3, then press REC CTRL. Next, press REC PAUSE.
- (4) Start playback on VCR if you record a tape from VCR. Select a TV program if you record from TV. The picture from VCR or TV appears on the LCD screen or in the viewfinder.
- (5) Press REC START at the scene where you want to start recording from.

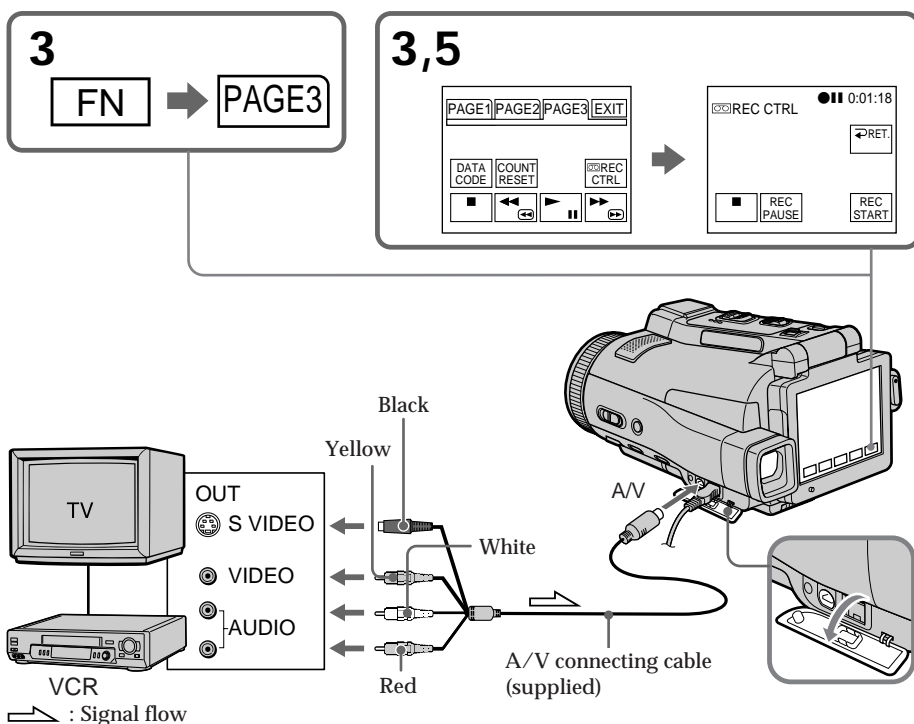

#### When you have finished dubbing a tape

Press on the LCD screen to stop recording on your camcorder and stop playback on VCR or TV.

## Recording video or TV programs

---

### Using the Remote Commander

You don't need to perform step 3.

In step 5, press both ● REC and the right button simultaneously to start recording.

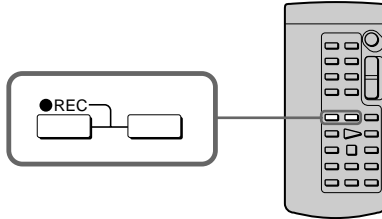

---

#### If your VCR is a monaural type

Connect the yellow plug of the A/V connecting cable to the video output jack and the white or the red plug to the audio output jack on the VCR or the TV. When the white plug is connected, the left channel audio is output, and when the red plug is connected, the right channel audio is output.

#### If your TV or VCR has an S video jack

Connect using the S video plug to faithfully obtain original pictures. With this connection, you do not need to connect the yellow (video) plug of the A/V connecting cable. Connect the S video plug to the S video jack of the VCR. This connection produces higher quality MICROMV format pictures.

## Recording video or TV programs

### When using the i.LINK cable

Simply connect the i.LINK cable (optional) to the i.LINK (MICROMV Interface) of your camcorder and to the i.LINK (MICROMV Interface) of the MICROMV product. With digital-to-digital connection, video and audio signals are transmitted in digital form for high-quality editing. (You cannot connect your camcorder to a DV product.)

- (1) Insert a blank tape (or a tape you want to record over) into your camcorder, and insert the recorded tape into VCR.
- (2) Set the POWER switch to VCR.
- (3) Start playback on VCR. The picture from the VCR appears on the LCD screen of your camcorder.
- (4) Set your camcorder in the recording pause mode.  
Press FN and go to PAGE3, then press  REC CTRL. Next, press REC PAUSE.
- (5) Press REC START at the scene where you want to start recording.

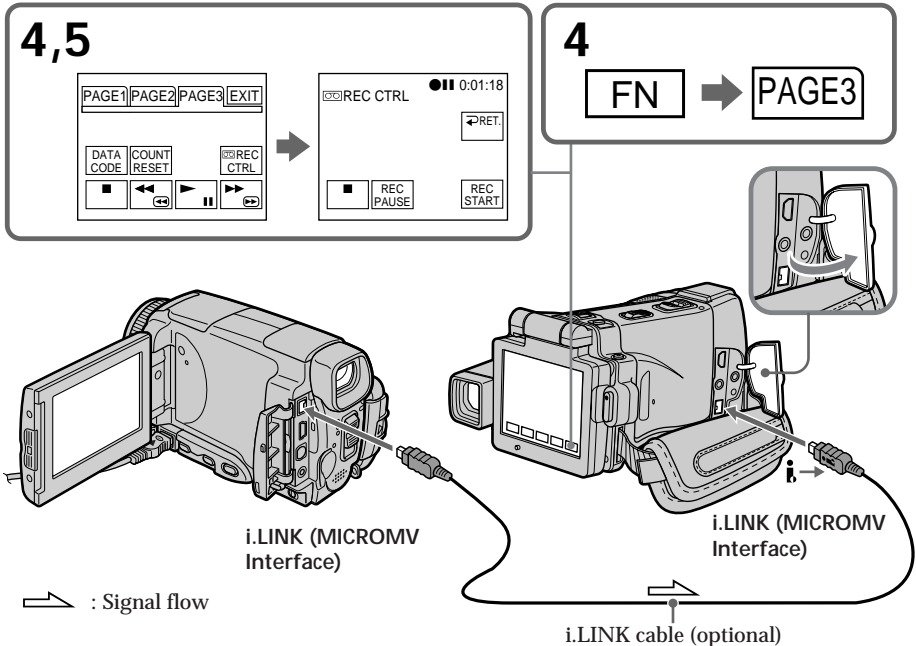

### When you have finished dubbing a tape

Press  on the LCD screen to stop recording on your camcorder and stop playback on VCR or TV.

## Recording video or TV programs

---

### Using the Remote Commandaer

You don't need to perform step 4.

In step 5, press both ● REC and the right button simultaneously to start recording.

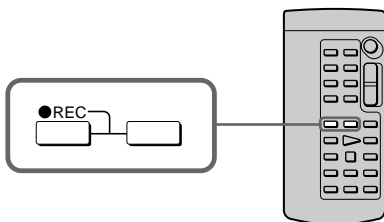

---

#### Notes

- When an incompatible picture (such as one recorded with the DV format) is input, the message “INPUT ERROR” appears.
- You can connect one VCR only using the i.LINK cable.
- First, start playback or turn to the playback pause mode before your camcorder starts recording or turns to the recording pause mode. If no signal is input into your camcorder, the message “NO INPUT” appears and the camcorder cannot start recording.

#### Note on playback pause pictures

When you record a playback pause picture:

- The recorded picture becomes rough when recorded through the i.LINK (MICROMV Interface).
- The picture may jitter when you play back the tape on other video equipment. And there may be a time-lag when you play back the tape on other video equipment.

#### Before recording

Make sure if the MPEG IN indicator appears on the LCD screen. The MPEG IN indicator may appear on both equipment.

# Superimposing a title

---

You can superimpose a title. When you play back the tape, the title is displayed for about five seconds from the point where you superimposed it.



## Superimposing a title on starting a recording

- (1) Set the POWER switch to CAMERA.
- (2) Press FN and go to PAGE2.
- (3) Press TITLE. The TITLE screen appears.
- (4) Select  with ↓/↑. The PRESET TITLE screen appears. Press EXEC.
- (5) Press ↓/↑ to select a desired title, then press EXEC. The title is displayed on the LCD screen.
- (6) If necessary, change the color, size, or position by pressing COLOR, SIZE, POS ↓ or POS ↑.
- (7) Press TITLE OK. The screen to save a title appears on the LCD screen.
- (8) Press SAVE TITLE.  
The TITLE indicator appears. And when you press START/STOP to start recording, TITLE SAVE appears on the LCD screen for about five seconds and the title is set.



## Superimposing a title

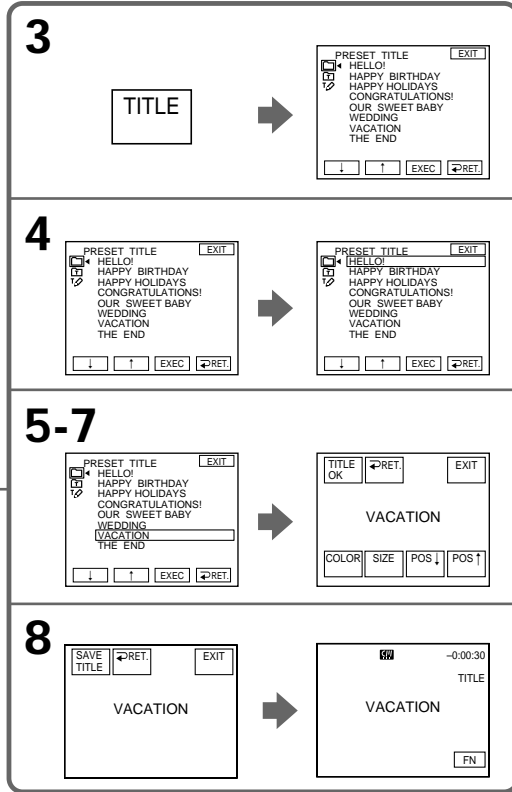
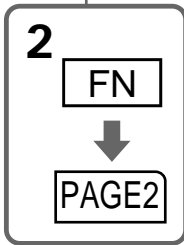
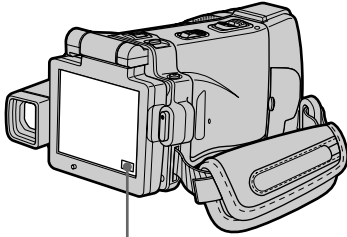

### If you set the write-protect tab to lock

You cannot superimpose or erase the title. Slide the write-protect tab to release the write protection.

### To use the custom title

If you want to use the custom title, select  in step 4.

### If the tape has a blank portion in the beginning of the tape or between recorded portion

The title may not be displayed correctly.

### The titles superimposed with your camcorder

- They are displayed only by the MICROMV format video equipment with index titler function.
- The point you superimposed the title may be detected as an index signal when searching a recording with other video equipment.

## Superimposing a title

---

### To not display title during playback

Set TITLE DSPL to OFF in the menu settings (p. 183).

### Title setting

- The title color changes as follows:

→ WHITE → YELLOW → VIOLET → RED → CYAN → GREEN → BLUE →

- The title size changes as follows:

SMALL ↔ LARGE

You cannot input 13 characters or more in LARGE size.

- If you select the title size "SMALL", you have nine choices for the title position.  
If you select the title size "LARGE", you have eight choices for the title position.

### The number of titles recordable on one cassette

You can record up to 20 titles when each title consists of 12 characters.

### When 20 titles are already superimposed

The message "TITLE FULL" appears. Erase unnecessary titles.

## Superimposing a title

### Superimposing a title on a recorded tape

You can superimpose a title for five seconds from the recording start point.

- (1) Set the POWER switch to VCR.
- (2) Press FN to display PAGE1.
- (3) Press TITLE. The TITLE screen appears.
- (4) Press INPUT TITLE. The INPUT TITLE screen appears.
- (5) Press  $\leftarrow/\rightarrow$  to select the direction to scan. Your camcorder starts scanning in the selected direction. When you select  $\rightarrow$ , the thumbnails are displayed from the upper-left window, and when you select  $\leftarrow$ , they are displayed from the lower-right window. After the scanning is completed, the thumbnails are displayed on the index screen.
- (6) Select the thumbnail on which you want to superimpose a title, then press EXEC or the thumbnail again. The title menu appears.
- (7) Perform step 4 to 7 in “Superimposing a title on starting a recording” on page 88.
- (8) Press SAVE TITLE.  
“TITLE SAVE” appears on the LCD screen for about five seconds and the title is set.

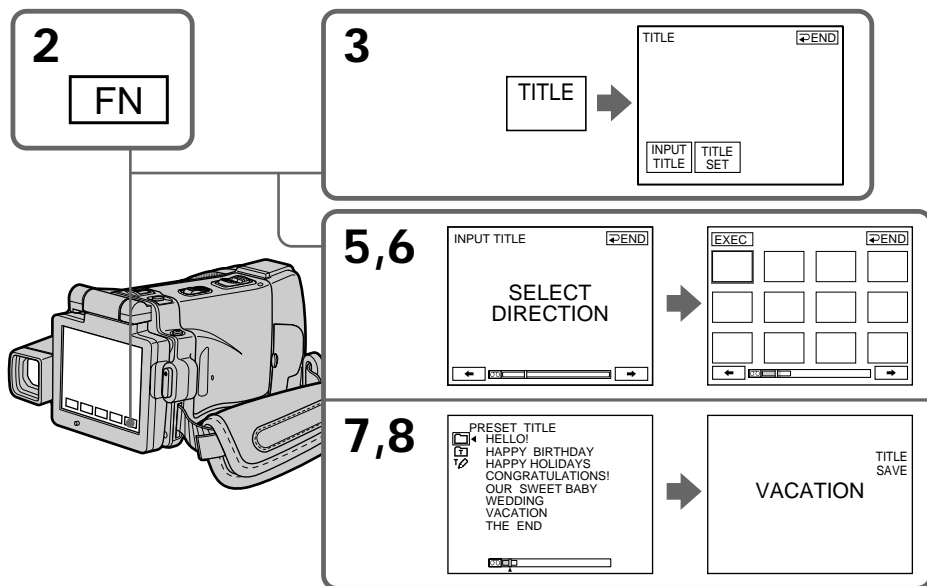

## Superimposing a title

---

### Notes

- Thumbnails may not be displayed depending on the condition of the tape. This is not a malfunction.
- Noise may appear on the thumbnails. However, this has no effect on the recorded images.
- You cannot execute TITLE SAVE until the playback picture is displayed in step 8.

### To use a custom title

If you want to use a custom title, select  in step 7.

### On a blank portion of the tape

You cannot superimpose a title on the tape.

# Superimposing a title

## Erasing a title

- (1) Set the POWER switch to CAMERA or VCR.
- (2) Press FN to display PAGE1.
- (3) Press MENU, then select TITLEERASE in  in the menu setting, then press EXEC (p. 183).
- (4) Press ↓/↑ to select the title you want to erase, then press EXEC.  
“ERASE OK?” appears.
- (5) Make sure the title is the one you want to erase, then press OK.  
The message “ERASING” flashes while erasing. After the erasing is completed, the message “COMPLETE” appears.

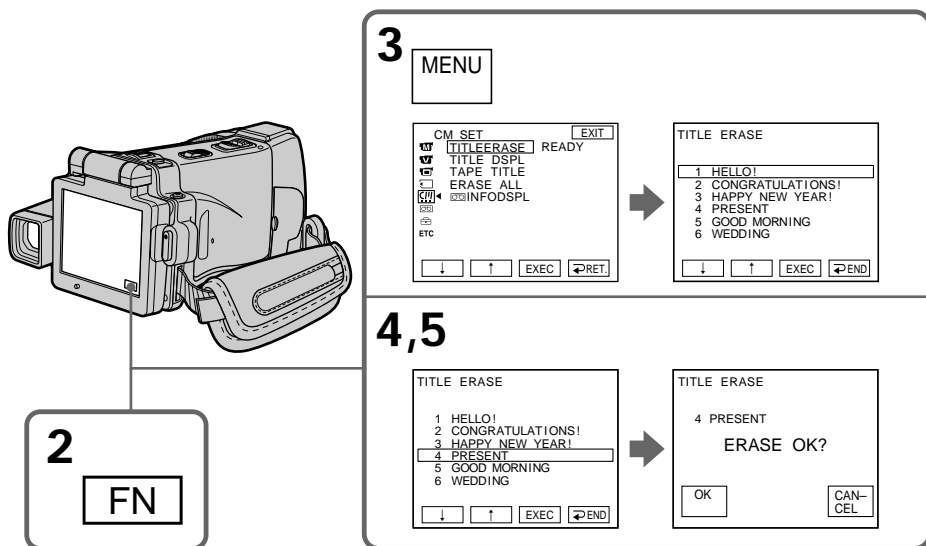

### To return to FN

Press EXIT.

### To cancel erasing

Press CANCEL in step 4.

# Making your own titles

You can make up to two titles and store them in the memory of your camcorder. Each title can have up to 20 characters.

## Making a title in CAMERA mode

- (1) Set the POWER switch to CAMERA.
- (2) Press FN and go to PAGE2.
- (3) Press TITLE.
- (4) Press ↓/↑ to select . The TITLE SET screen appears. Press EXEC.
- (5) Press ↓/↑ to select CUSTOM1 SET or CUSTOM2 SET, then press EXEC.
- (6) Select the desired character. Repeat pressing a key to select the desired character on the key.
- (7) Press → to move the cursor for the next character. Repeat the same procedure as steps 6 and 7 to complete your title.
- (8) Press SET. The title is stored in memory.

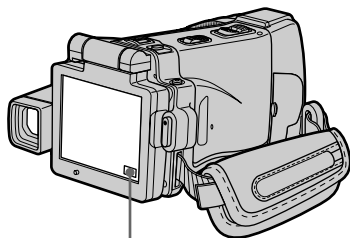

2

FN

PAGE2

3

TITLE



4

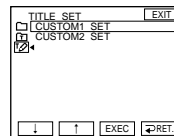
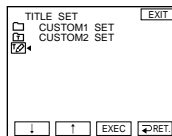

5

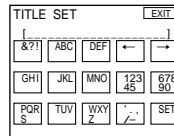
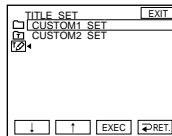

6,7

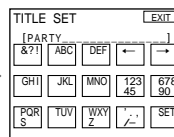
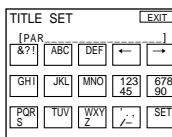

## Making your own titles

---

### To return to FN

Press EXIT.

### To change a title you have stored

In step 5, select CUSTOM1 SET or CUSTOM2 SET depending on which title you want to change, then press EXEC and enter the new title as desired.

### To superimpose your own title on tape

Follow the procedure in “Superimposing a title on starting a recording” on page 88.

---

### If you take five minutes or longer to enter characters in the standby mode while a cassette is in your camcorder

The power automatically goes off. The characters you have entered remain stored in memory. Set the POWER switch to (CHG) OFF and start again from step 1 to complete your title.

We recommend setting the POWER switch to VCR (p. 96) or removing the cassette so that your camcorder does not automatically turn off while you are entering title characters.

### To erase the character

Press ←. The last character is erased.

### To enter a space

Press →.

### To enter the character on the same button in succession

Press → to move the cursor to the next position, and enter the character.

## Making your own titles

### Making a title in VCR mode

- (1) Set the POWER switch to VCR.
- (2) Press FN to display PAGE1.
- (3) Press TITLE. The TITLE screen appears.
- (4) Press TITLE SET. The TITLE SET screen appears.
- (5) Press ↓/↑ to select CUSTOM1 SET or CUSTOM2 SET, then press EXEC.
- (6) Perform steps 6 and 7 in “Making a title in CAMERA mode” on page 94.
- (7) Press SET. The title is stored in memory.

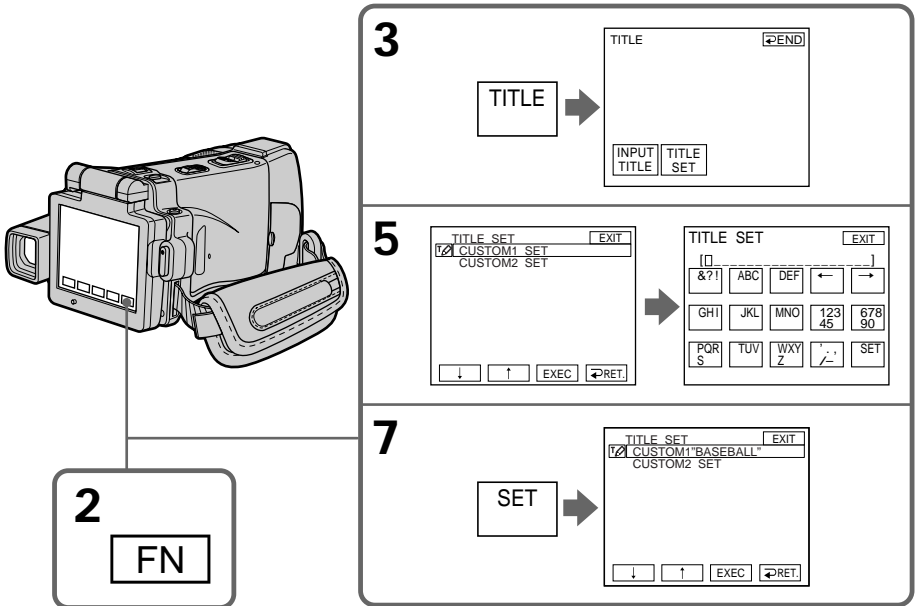

#### To return to FN

Press EXIT.

#### To superimpose your own title on tape

Follow the procedure in “Superimposing a title on starting a recording” on page 88.



# The micro Cassette Memory

The MICROMV cassette automatically records the recording settings and date. When you insert a cassette with the POWER switch set to CAMERA, or when you set the POWER switch to VCR, the cassette information is displayed for about five seconds.

## The cassette information

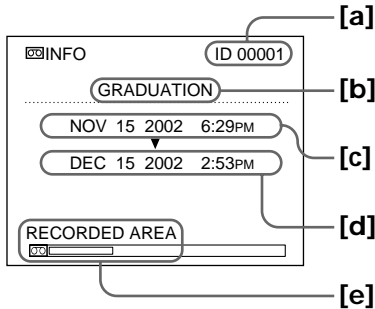

- [a] The unique number of each cassette. Your camcorder automatically assign this number.
- [b] The cassette title set by TAPE TITLE in the menu settings (Cassette label).
- [c] The first-recorded date in this cassette.
- [d] The last-recorded date in this cassette.
- [e] The recorded area is indicated by the white bar.

---

### Recorded areas

A blank portion between recorded area is also indicated as a recorded area.

### To not display the cassette information

Set INFODSPL to OFF in the menu settings.

### When " " is flashing

Eject the cassette and insert it again. If the message is still displayed, the micro Cassette Memory may be corrupted. Replace the cassette with another cassette.

# The micro Cassette Memory

## Labeling a cassette

The label can consist of up to 16 characters and is stored in cassette memory.

- (1) Insert the cassette you want to label.
- (2) Set the POWER switch to CAMERA or VCR.
- (3) Press FN to display PAGE1.
- (4) Press MENU, then select TAPE TITLE in  in the menu settings, then press EXEC (p. 183).

The TAPE TITLE screen appears.

- (5) Select a desired character. Repeat pressing a key to select the desired character on the key.
- (6) Press → to move the cursor for the next character. Repeat the same procedure as steps 5 and 6 to complete the label.
- (7) Press SET. The label is stored in memory.

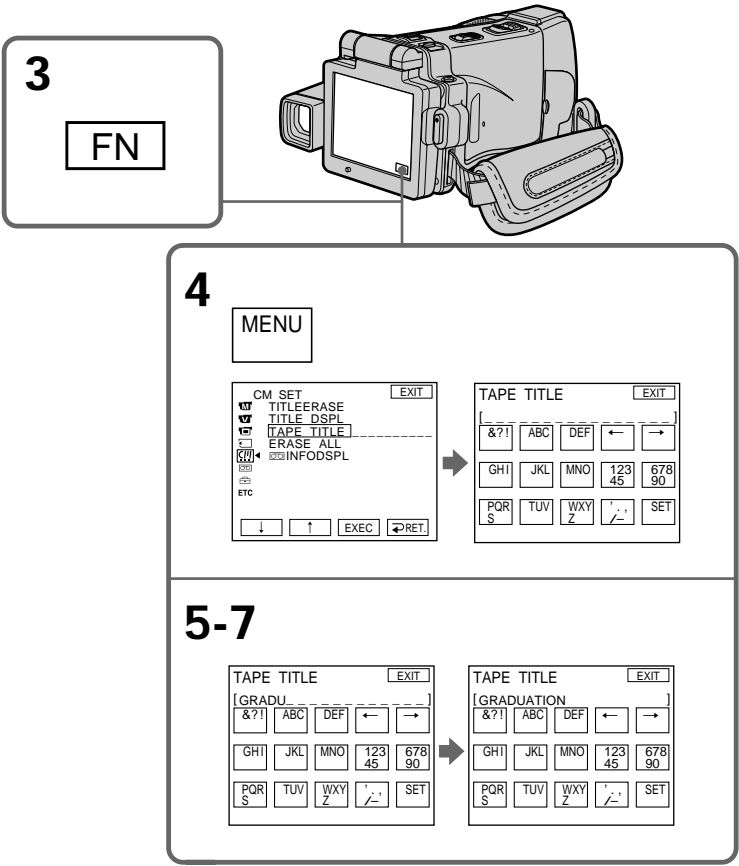

## The micro Cassette Memory

---

### To return to FN

Press EXIT.

### To erase the label you have made

Select ← in step 4. The last character is erased.

### To change the label you have made

Insert the cassette to change the label, and operate in the same way to make a new label.

---

**If you take five minutes or longer to enter characters in the standby mode while a cassette is in your camcorder**

The power automatically goes off. The characters you have entered remain stored in memory. Set the POWER switch to (CHG) OFF once and then to CAMERA again. After that, repeat the procedure from step 3. The power does not go off if you enter characters in VCR mode.

**If you set the write-protect tab of the tape to lock**

You cannot label the tape. Slide the write-protect tab to release the write protection.

### To erase the character

Press ←. The last character is erased.

### To enter a space

Press →.

### To enter the character on the same button in succession

Press → to move the cursor to the next position, and enter the character.

## Erasing all the data in micro Cassette Memory

You can delete all the data in micro Cassette Memory at once.

- (1) Set the POWER switch to CAMERA or VCR.
- (2) Press FN to display PAGE1.
- (3) Press MENU, then select ERASE ALL in  in the menu settings, then press EXEC (p. 183).
- (4) Press ↓/↑ to select OK, then press EXEC. "OK" changes to "EXECUTE."
- (5) Press ↓/↑ to select EXECUTE, then press EXEC. "ERASING" flashes on the LCD screen. Once deleting is completed, "COMPLETE" is displayed.

### To return to FN

Press EXIT.

### To cancel deleting

Select RETURN in step 4 or 5, then press EXEC.

---

#### Note

Once you delete all the data in the micro Cassette Memory, the following operations do not work:

- MULTI-PICTURE SEARCH
- TITLE SEARCH
- DATE SEARCH

#### Note on the ID number

This item cannot be deleted.

# Using a “Memory Stick” – Introduction

You can record and play back still images and moving pictures on a “Memory Stick” supplied with your camcorder. You can easily play back, record or delete images. You can exchange image data with other equipment such as your computer etc., using the USB cable and the “Memory Stick” supplied with your camcorder.

## File format

### Still image (JPEG)

Your camcorder compresses image data in JPEG format (extension .jpg).

### Moving picture (MPEG)

Your camcorder compresses picture data in MPEG format (extension .mpg).

## Typical image data file name

### Still image

100-0001: This file name appears on the LCD screen of your camcorder.

Dsc00001.jpg: This file name appears on the display of your computer.

### Moving picture

MOV10001: This file name appears on the LCD screen of your camcorder.

Mov10001.mpg: This file name appears on the display of your computer.

## Using a “Memory Stick”

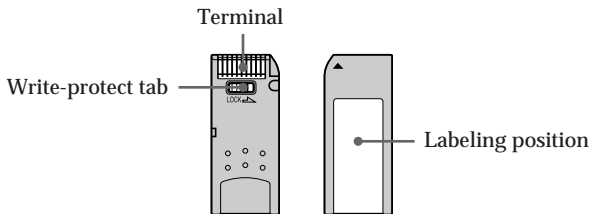

- You cannot record or erase images when the write-protect tab on the “Memory Stick” is set to LOCK.
- The position and shape of the write protect tab may be different depending on the model.
- We recommend backing up important data on the hard disk of your computer.
- Image data may be damaged in the following cases:
  - If you remove the “Memory Stick,” turn the power off or take out the battery for replacement when the access lamp is flashing
  - If you use a “Memory Stick” near magnets or magnetic fields such as those of speakers and televisions
- Prevent metallic objects or your finger from coming into contact with the metal parts of the connecting section.
- Stick its label on the labeling position.
- Do not bend, drop or apply strong shock to a “Memory Stick.”
- Do not disassemble or modify a “Memory Stick.”
- Do not let a “Memory Stick” get wet.
- Do not use or keep a “Memory Stick” in locations that are:
  - Extremely hot such as in a car parked in the sun or under the scorching sun
  - Under direct sunlight
  - Very humid or subject to corrosive gases
- When you carry or store a “Memory Stick,” put it in its case.

## Using a “Memory Stick” – Introduction

---

### “Memory Stick” formatted by a computer

The “Memory Stick” formatted by Windows OS or Macintosh computers do not have a guaranteed compatibility with your camcorder.

### Notes on image data compatibility

- Image data files recorded on a “Memory Stick” by your camcorder conform with the Design Rules for Camera File Systems universal standard established by the JEITA (Japan Electronics and Information Technology Industries Association).  
On your camcorder, you cannot play back still images recorded on other equipment (DCR-TRV890E/TRV900/TRV900E or DSC-D700/D770) that does not conform to this universal standard. (These models are not sold in some areas.)
- If you cannot use the “Memory Stick” that is used with other equipment, format it with your camcorder (p. 182). Note that formatting erases all information on the “Memory Stick.”

- 
- “Memory Stick” and  are trademarks of Sony Corporation.
  - All other product names mentioned herein may be the trademarks or registered trademarks of their respective companies.  
Furthermore, “TM” and “®” are not mentioned in each case in this manual.

## Using a “Memory Stick” – Introduction

### Inserting a “Memory Stick”

Insert a “Memory Stick” in the “Memory Stick” slot as far as it can go, as illustrated below.

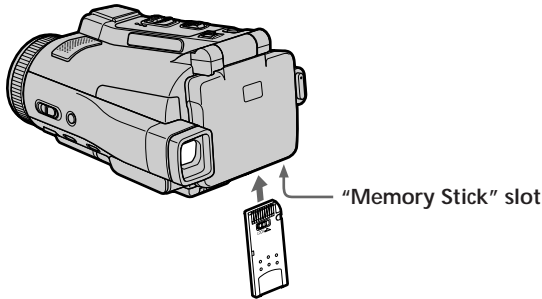

### Ejecting a “Memory Stick”

Open the LCD panel and confirm that the “Memory Stick” access lamp is not lit. Then slide the MEMORY EJECT lever in the direction of the arrow.

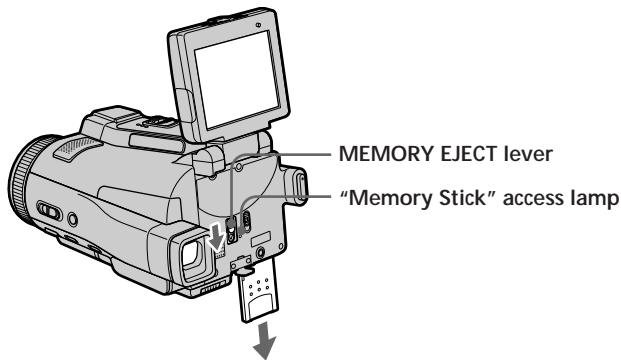

---

#### While the “Memory Stick” access lamp is lit or flashing

Do not shake or strike your camcorder because your camcorder is reading the data from the “Memory Stick” or recording the data on the “Memory Stick.” Do not turn the power off, eject a “Memory Stick” or take out the battery pack. Otherwise, image data breakdown may occur.

#### If “MEMORY STICK ERROR” is displayed

Reinsert a “Memory Stick” a few times. The “Memory Stick” may be damaged if the indicator is still displayed. If this occurs, use another “Memory Stick.”

# Using a “Memory Stick” – Introduction

## Using a touch panel

Operation buttons for most functions using a “Memory Stick” are displayed on the LCD screen. Press the LCD panel directly with your finger or the supplied stylus (DCR-IP220 only) to operate each function.

- (1) Set the POWER switch to MEMORY.
- (2) Open the LCD panel. The operation buttons appear on the LCD screen. You can switch the memory playback/memory camera mode by pressing PLAY/CAM.
- (3) Press FN to display PAGE1. The operation buttons of PAGE1 appear on the LCD screen.
- (4) Press PAGE2 to go to PAGE2. The operation buttons of PAGE2 appear on the LCD screen.
- (5) Press PAGE3 to go to PAGE3. The operation buttons of PAGE3 appear on the LCD screen.
- (6) Press a desired operation item.  
See relevant pages of this manual for each function.

“Memory Stick” Operations

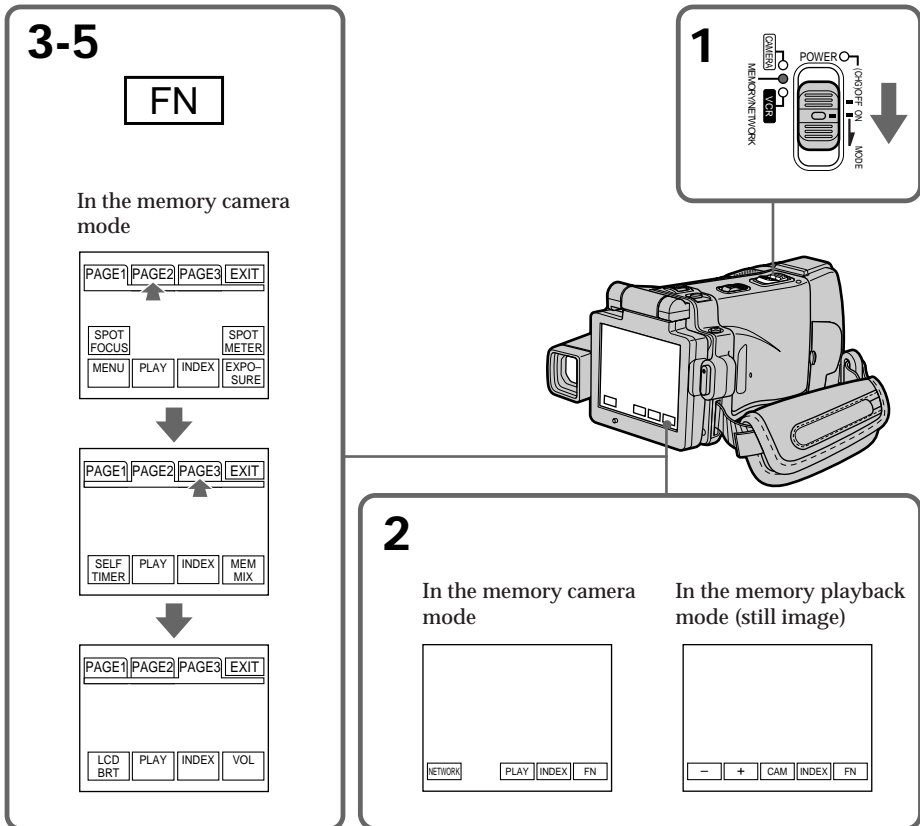

# Using a “Memory Stick” – Introduction

---

## To return to FN

Press EXIT.

## To execute settings

Press EXEC or  OK.

## To cancel settings

Press  OFF or  AUTO. The display returns to PAGE1, 2 or 3.

---

### Notes

- When using the touch panel, press the LCD screen lightly with your finger or the supplied stylus (DCR-IP220 only).
- Do not press the LCD screen with sharp objects other than the stylus supplied (DCR-IP220 only).
- Do not press the LCD screen too hard.
- Do not touch the LCD screen with wet hands.
- If FN is not on the LCD screen, touch the LCD screen lightly to make it appear. You can control the display with DISPLAY/TOUCH PANEL on your camcorder.
- When operation buttons do not work even if you press them, an adjustment is required (CALIBRATION) (p. 204).
- When the LCD screen gets dirty, use the supplied cleaning cloth.

### When executing each item

The green bar appears above the item.

### If the items are not available







The color of the items changes to gray.

### Press FN to display the following buttons:

In the memory camera mode

PAGE1	SPOT FOCUS, MENU, PLAY, INDEX, SPOT METER, EXPOSURE
PAGE2	SELFTIMER, PLAY, INDEX, MEM MIX
PAGE3	LCD BRT, PLAY, INDEX, VOL

In the memory playback mode

PAGE1	MENU, CAM, INDEX, DELETE,  , 
PAGE2	PB ZOOM, CAM, INDEX, DATA CODE,  , 
PAGE3	LCD BRT, CAM, INDEX, VOL,  , 



# Using a "Memory Stick" – Introduction

## Selecting still image quality mode

You can select the image quality mode in still image recording and store the setting in memory. The default setting is SUPER FINE.

- (1) Set the POWER switch to MEMORY or VCR.
- (2) Press FN to display PAGE1.
- (3) Press MENU, then select STILL SET in  in the menu settings, then press EXEC (p. 181).
- (4) Press  $\downarrow/\uparrow$  to select QUALITY, then press EXEC.
- (5) Press  $\downarrow/\uparrow$  to select the desired image quality, then press EXEC.

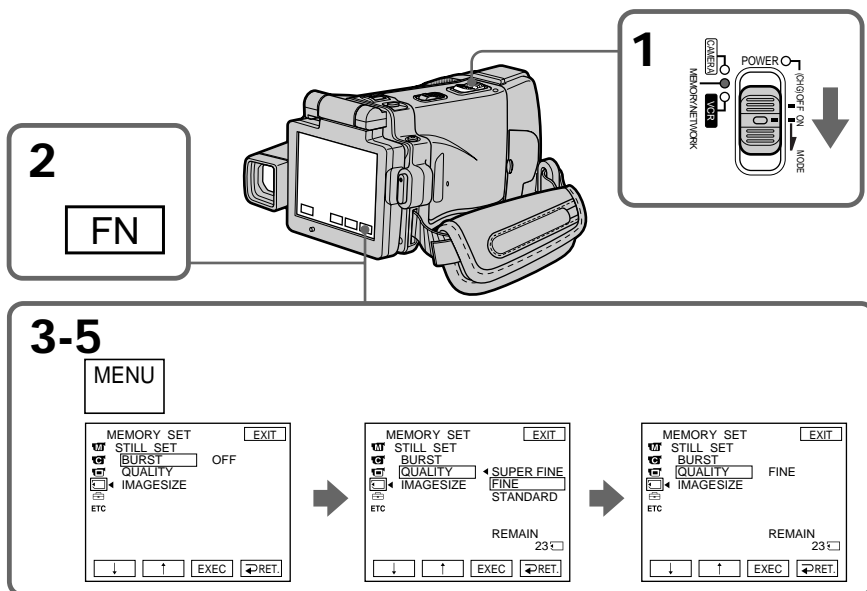

**To return to FN**  
Press EXIT.

## Using a “Memory Stick” – Introduction

---

### Image quality settings

Setting	Meaning
SUPER FINE (SFN)	This is the highest image quality in your camcorder. The number of still images you can record is less than in FINE mode. Super fine images are compressed to about 1/3.
FINE (FINE)	Use this mode when you want to record high quality images. Fine images are compressed to about 1/6.
STANDARD (STD)	This is the standard image quality. Standard images compressed to about 1/10.

#### Note

In some cases, changing the image quality mode may not affect the image quality, depending on the type of images you are shooting.

#### Differences in image quality

Recorded images are compressed in JPEG format before being stored in memory. The memory capacity allocated to each image varies depending on the selected image quality mode and image size. Details are shown in the table below. (You can select 1600 × 1200 or 640 × 480 image size in the menu settings.)

#### 1600 × 1200 image size

Image quality mode	Memory capacity
SUPER FINE	About 1240 KB
FINE	About 620 KB
STANDARD	About 420 KB

#### 640 × 480 image size

Image quality mode	Memory capacity
SUPER FINE	About 190 KB
FINE	About 100 KB
STANDARD	About 60 KB

#### Image quality mode indicator

The image quality mode indicator is not displayed during playback.

#### When you select image quality

The number of images you can shoot in the currently selected image quality appears on the LCD screen.

# Using a "Memory Stick" – Introduction

## Setting the moving picture quality mode



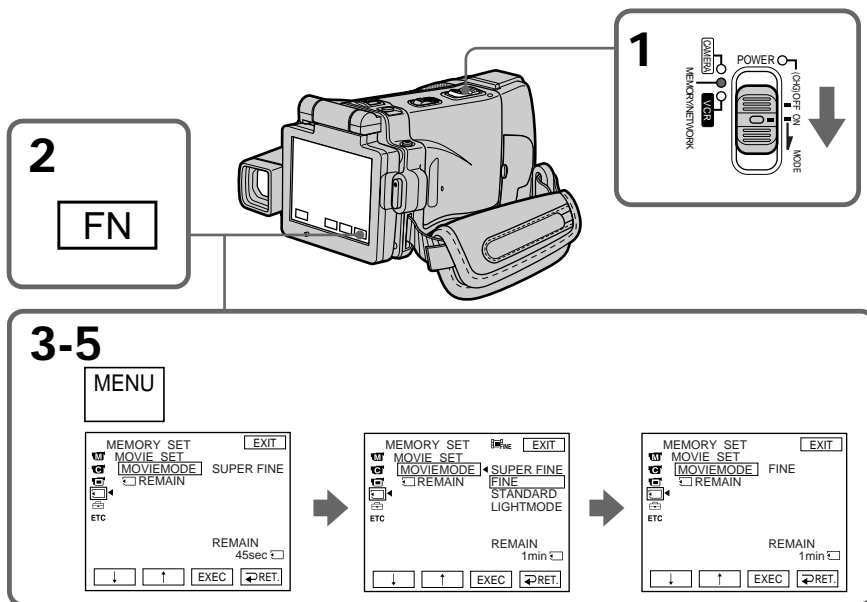

There are SUPER FINE, FINE, STANDARD and LIGHTMODE in the moving picture quality mode. The default setting is SUPER FINE.

- (1) Set the POWER switch to MEMORY or VCR.
- (2) Select FN to display PAGE1.
- (3) Press MENU, then select MOVIE SET in  in the menu settings, then press EXEC (p. 181).
- (4) Press  $\downarrow/\uparrow$  to select MOVIEMODE, then press EXEC.
- (5) Press  $\downarrow/\uparrow$  to select the desired image quality, then press EXEC.



## Using a “Memory Stick” – Introduction

### Image quality settings

Setting	Meaning	Frame rate	Bit rate (image and audio) (Approx.)	Indicator (during recording)
SUPER FINE (SFN)	Records moving pictures at 352 × 240.	30 fps	1200 Kbps	 SFN
FINE (FINE)	Records moving pictures at 352 × 240.	30 fps	750 Kbps	 FINE
STANDARD (STD)	Records moving pictures at 144 × 96.	10 fps	400 Kbps	 STD
LIGHTMODE (LIGHT)	Records moving pictures at 144 × 96.	10 fps	200 Kbps	 LIGHT

**SUPER FINE:** You can record moving pictures at the highest quality. This mode is suitable when you intend to modify the pictures using your computer. SUPER FINE is the default setting of your camcorder.

**FINE:** You can record moving pictures for a longer time than with the SUPER FINE mode, the quality, however, declines slightly.

**STANDARD:** You can record moving pictures for a longer time than with the FINE mode, the image size, however, is smaller.

**LIGHTMODE:** Since the file size is small, this mode is suitable for e-mail transmission. The image quality, however, declines.

#### Frame rate

A moving picture consists of continuous still images. Frame rate indicates the number of images played back in one second. The more the number increases, the more natural the moving picture becomes. You can play back a maximum of 30 still images per second with your camcorder (30 fps/frame per second).

#### Bit rate

The higher the bit rate, the more natural the moving picture becomes.

### Maximum recording time for moving pictures

Image quality mode	Maximum recording time
SUPER FINE	45 s
FINE	1 min 10 s
STANDARD	2 min 20 s
LIGHTMODE	4 min 40 s

# Using a "Memory Stick" – Introduction

## Selecting the size of still image

You can select either of two still image sizes.

1600 × 1200 or 640 × 480. (When the POWER switch is set to CAMERA or VCR, the image size is automatically set to 640 × 480.)

The default setting is 1600 × 1200.

- (1) Set the POWER switch to MEMORY.
- (2) Press FN to display PAGE1.
- (3) Press MENU, then select STILL SET (still image) in  in the menu setting, then press EXEC (p. 181).
- (4) Press ↓/↑ to select IMAGESIZE, then press EXEC.
- (5) Press ↓/↑ to select the desired image size, then press EXEC.

The indicator changes as follows:

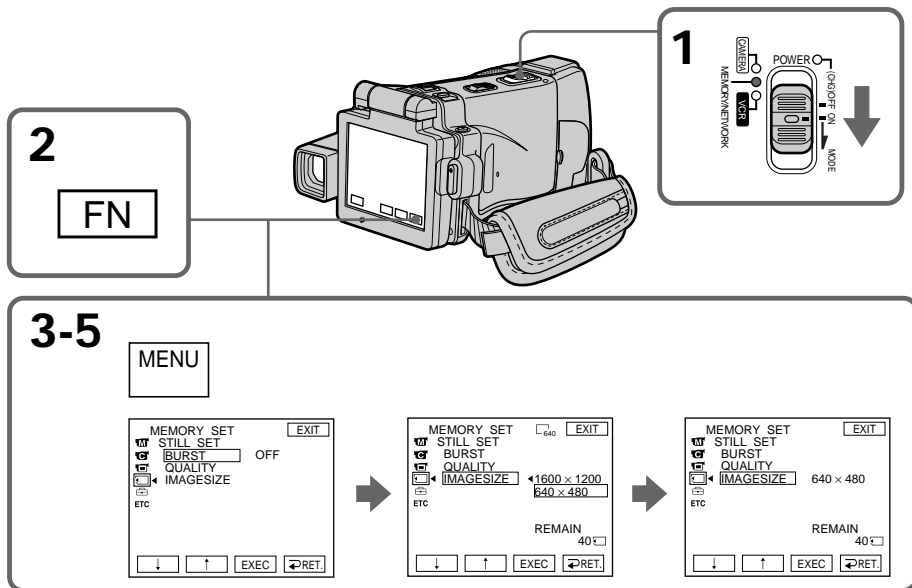



### Note

When still images recorded on your camcorder in 1600 × 1200 size are played back on other equipment that does not support 1600 × 1200 size, the full image may not appear.

## Using a “Memory Stick” – Introduction

### Image size settings

Setting	Meaning	Indicator
1600 × 1200	Records 1600 × 1200 still images.	
640 × 480	Records 640 × 480 still images.	

### Approximate number of still images you can record on a “Memory Stick”

The number of still images you can record varies depending on the complexity of the subject.

Image quality	Image size	Capacity of “Memory Stick”s				
		8MB (supplied)	16MB (optional)	32MB (optional)	64MB (optional)	128MB (optional)
SUPER FINE	1600 × 1200	6 images	12 images	25 images	51 images	100 images
	640 × 480	40 images	80 images	160 images	325 images	650 images
FINE	1600 × 1200	12 images	25 images	50 images	100 images	205 images
	640 × 480	80 images	160 images	325 images	650 images	1310 images
STANDARD	1600 × 1200	18 images	37 images	75 images	150 images	300 images
	640 × 480	120 images	240 images	485 images	980 images	1970 images

The table above shows approximate number of still images you can record on a “Memory Stick” formatted by your camcorder.

### Approximate time of moving pictures you can record on a “Memory Stick”

The time of moving pictures you can record varies depending on the complexity of the subject.

Picture quality	Capacity of “Memory Stick”				
	8MB (supplied)	16MB (optional)	32MB (optional)	64MB (optional)	128MB (optional)
SUPER FINE	45 s	1 min	3 min	6 min	13 min
FINE	1 min	2 min	5 min	10 min	20 min
STANDARD	2 min	5 min	10 min	20 min	41 min
LIGHTMODE	5 min	10 min	20 min	41 min	82 min

The table above shows approximate times of moving pictures you can record on a “Memory Stick” formatted by your camcorder.

# Recording still images on a “Memory Stick” – Memory photo recording

You can record still images on a “Memory Stick.”

## Before operation

Insert a “Memory Stick” into your camcorder.

- (1) Set the POWER switch to MEMORY.
- (2) Keep pressing PHOTO lightly. The green ● mark stops flashing, then lights up. The brightness of the image and the focus are adjusted and fixed while your camcorder is targeted at the middle of the image. Recording does not start yet.
- (3) Press PHOTO deeper. The image displayed on the LCD screen will be recorded on a “Memory Stick.”

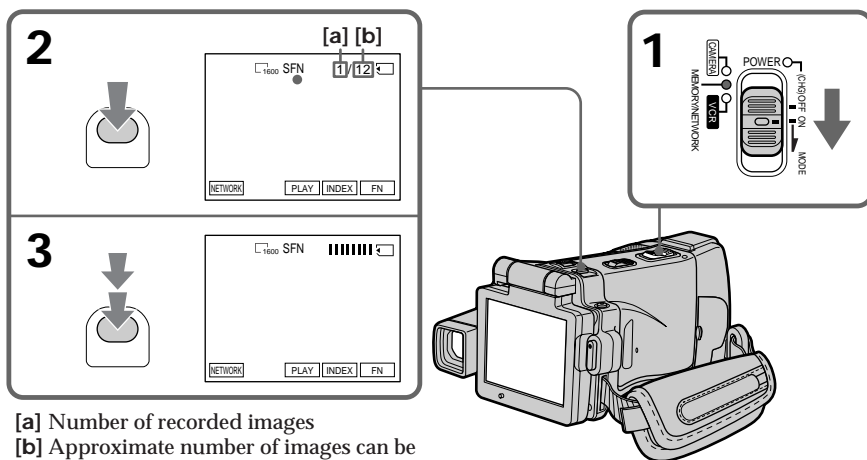

- [a] Number of recorded images  
[b] Approximate number of images can be recorded on the “Memory Stick”

You can record still images on a “Memory Stick” in the recording standby mode or while recording on tape in CAMERA mode

For the details, see page 47.

## Recording still images on a “Memory Stick” – Memory photo recording

---

### When the POWER switch is set to MEMORY

The following functions do not work:

- Digital zoom
- Super NightShot
- Color Slow Shutter
- Wide mode
- Fader
- Picture effect
- Digital effect
- Sports lesson of PROGRAM AE (The indicator flashes.)
- Title
- SteadyShot

### While you are recording a still image

You cannot turn off the power or press PHOTO.

### When you press PHOTO on the Remote Commander

Your camcorder immediately records the image that is on the LCD screen when you press the button.

### When you press PHOTO lightly in step 2

The image momentarily flickers. This is not a malfunction.

### Recording data

The recording data (date/time or various settings when recorded) are not displayed while recording. However, they are recorded automatically onto the “Memory Stick.” To display the recording data, press DATA CODE during playback. You can also use the Remote Commander for this operation (p. 43).

### When the POWER switch is set to MEMORY

The angle of view is slightly larger compared with the angle of view in CAMERA mode.

### The number of still images you can record on a “Memory Stick”

It varies according to the image quality mode and the complexity of the subject.



# Recording still images on a “Memory Stick” - Memory photo recording

## Recording images continuously

You can record still images continuously. Before recording, select one of the four modes described below in the menu settings.

### NORMAL [a]

Your camcorder shoots up to four still images in  $1600 \times 1200$  size or 25 still images in  $640 \times 480$  size at about 0.5 sec intervals. (  )

### HIGH SPEED [a]

Your camcorder shoots up to 32 still images in  $640 \times 480$  size at about 0.07 sec intervals. (  )

### EXP BRKTG (Exposure Bracketing)

Your camcorder automatically shoots three images at about 0.5 sec intervals at different exposures. ( **BRK** )

### MULTI SCR N (Multi Screen) [b]

Your camcorder shoots nine still images at about 0.5 sec intervals and displays the images on a single page divided into nine boxes. Still images are recorded in  $640 \times 480$  size. (  )

[a]



[b]



# Recording still images on a “Memory Stick” – Memory photo recording

---

- (1) Set the POWER switch to MEMORY.
- (2) Press FN to display PAGE1.
- (3) Press MENU, then select STILL SET in  in the menu settings, then press EXEC (p. 181).
- (4) Press ↓/↑ to select BURST, then press EXEC.
- (5) Press ↓/↑ to select the desired settings.
- (6) Press EXIT to make the menu settings disappear.
- (7) Press PHOTO deeper.

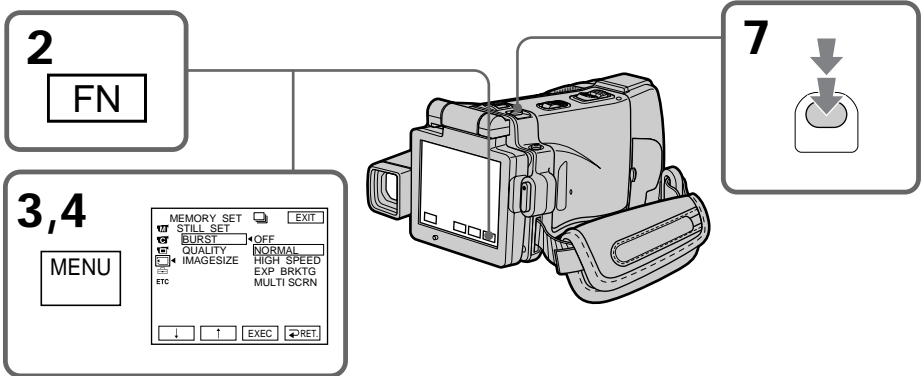

## If the “Memory Stick” becomes full

“ FULL” appears on the LCD screen, and you cannot record still images on this “Memory Stick.”

---

## The number of still images in continuous shooting

The number of still images you can shoot continuously varies depending on the image size and the capacity of the “Memory Stick.”

## During recording still images continuously

The flash does not work.

## When shooting with the self-timer function or the Remote Commander

Your camcorder automatically records up to the maximum recordable number of still images.

## When selecting HIGH SPEED

Flickering or changes in color may occur. Also, your camcorder prevents focusing on near objects.

## If the remaining capacity of the “Memory Stick” is less than three images

EXP BRKTG does not work. When you press PHOTO lightly, “ FULL” appears on the screen.

## Recording still images on a “Memory Stick” - Memory photo recording

---

### The effect of EXP BRKTG

The effect of EXP BRKTG may not be noticeable on the LCD screen.

We recommend viewing images on a TV or computer to realize the effect.

### When selecting NORMAL or HIGH SPEED

Recording continues up to the maximum number of still images during pressing PHOTO deeper. Release PHOTO to stop recording.

# Recording still images on a "Memory Stick" - Memory photo recording

## Recording images with the flash

The flash automatically pops up to strobe. The default setting is auto (no indicator). To change the flash mode, press **⚡** (flash) repeatedly until the flash mode indicator appears on the LCD screen.

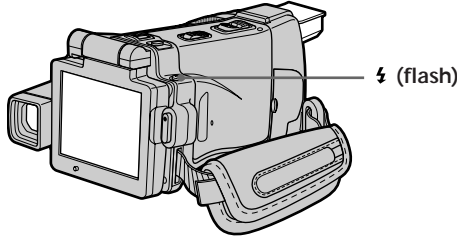

Each press of **⚡** (flash) changes the indicator as follows:



When you set RED EYE R in **☑** to ON in the menu settings (p. 178), the indicator changes as follows:

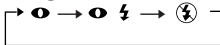

- |   |  |
|---|--|
| <b>⚡</b> Forced flash:                      | The flash fires regardless of the surrounding brightness.                                    |
| <b>●</b> Auto red-eye reduction:            | The flash fires before recording to reduce the red-eye.                                      |
| <b>●</b> <b>⚡</b> Forced red-eye reduction: | The flash fires before recording to reduce red-eye regardless of the surrounding brightness. |
| <b>⊗</b> No flash:                          | The flash does not fire.   |

The amount of flash is automatically adjusted to the appropriate brightness. You can also change FLASH LVL to the desired brightness in the menu settings (p. 178). Try recording various images to find the most appropriate setting for FLASH LVL.

### Notes

- The recommended shooting distance using the built-in flash is 0.3 m to 2.5 m (31/32 feet to 8 1/3 feet).
- Attaching the lens hood (supplied) or a conversion lens (optional) may block the light from the flash or cause lens shadow to appear.
- Auto red-eye reduction (**●**) and Forced red-eye reduction (**●** **⚡**) may not produce the desired effect depending on individual differences, the distance to the subject, the subject not looking at the pre-recording flash or other conditions.
- The flash effect cannot be obtained easily when you use forced flash in a bright location.
- The flash charge lamp flashes while the power for firing is being charged. After charging is completed, the flash charge lamp lights up.
- If it is not easy to focus on a subject automatically, for example, when recording in the dark, use HOLOGRAM AF (p. 117) or the focal distance information (p. 67) for focusing manually.

If you leave your camcorder for five or more minutes after removing the power source

Your camcorder returns to the default setting (auto).

## Recording still images on a “Memory Stick” – Memory photo recording

The flash does not fire even if you select AUTO and Auto red-eye reduction (●) during the following functions:

- NightShot
- Spotlight of PROGRAM AE
- Sunset & moon of PROGRAM AE
- Landscape of PROGRAM AE
- Exposure
- Flexible Spot Meter

During recording images continuously

The flash does not work.

### Shooting with an auxiliary light – HOLOGRAM AF

The HOLOGRAM AF is an auxiliary light source used for focusing on subjects in dark places.

Set HOLOGRAM F in  to AUTO in the menu settings. (The default setting is AUTO.)

When  appears on the LCD screen in a dark place, press PHOTO lightly. Then the auxiliary light will automatically emit until the subject is focused.

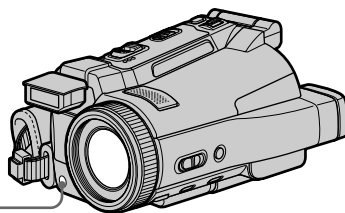

HOLOGRAM AF emitter

#### About HOLOGRAM AF

“HOLOGRAM AF (Auto-Focus),” an application of laser holograms, is a new AF optical system that enables still image shooting in dark places. Having gentler radiation than conventional high-brightness LEDs or lamps, the system satisfies Laser Class 1 (\*) specification and thus maintains higher safety for human eyes.

No safety problems will be caused by directly looking into the HOLOGRAM AF emitter at a close range. However, it is not recommended to do so, because you may experience such effects like several minutes of image residual and dazzling, that you encounter after looking into a flashlight.

\* HOLOGRAM AF satisfies Class 1(time base 30 000 seconds), specified in all of JIS (Japan), IEC(EU), and FDA(US) industry standards.

Complying with these standards identifies the laser product to be safe, under a condition that a human looks at the laser light either directly or even through a lens for 30 000 seconds.

## Recording still images on a “Memory Stick” - Memory photo recording

---

### Notes

- A conversion lens (optional) may obstruct the HOLOGRAM AF light and make focusing difficult.
- If enough light does not reach the subject even if the HOLOGRAM AF emitter is emitted (recommended shooting distance is 2.5 m (8 1/3 feet)), the subject will not be focused.
- Focusing may be hampered if the light emitted from the HOLOGRAM AF is blocked by an obstruction.
- Focus is achieved as long as HOLOGRAM AF light reaches to the subject even if its light is slightly out of the middle position of the subject.
- If HOLOGRAM AF light is dim, it sometimes becomes difficult to focus. If this happens, wipe the HOLOGRAM AF emitter with a soft, dry cloth.

### The HOLOGRAM AF does not emit when:

- The POWER switch is set to CAMERA.
- NightShot
- Flash is set to  (No flash).
- Sunset & moon of PROGRAM AE
- Landscape of PROGRAM AE
- Focusing manually
- Spot Focus
- Continuous photo recording

# Recording still images on a "Memory Stick" - Memory photo recording

## Using NightFraming

The NightFraming enables you to check a subject even at night and then record with natural colors using the flash.

(1) Set the POWER switch to MEMORY.

(2) Set NIGHTSHOT/NIGHTFRAMING to NIGHTFRAMING.

The  and NIGHTFRAMING indicators flash, then  and  indicators light up on the LCD screen.

(3) Press PHOTO lightly.

The auxiliary light (HOLOGRAM AF) (p. 117) emits to adjust the focus automatically.

(4) Press PHOTO deeper.

The flash fires, then recording starts.

To cancel NightFraming, set NIGHTSHOT/NIGHTFRAMING to the center position (green ● position).

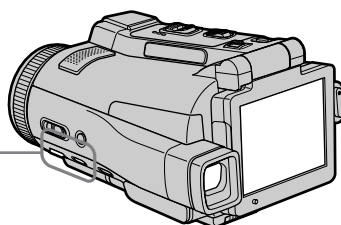
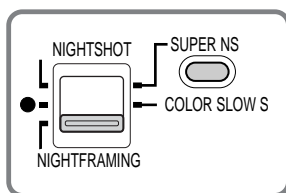

**While using NightFraming, you cannot use the following functions:**

- White balance
- PROGRAM AE
- Exposure
- Flexible Spot Meter
- Spot Focus
- Continuous photo recording

**While using NightFraming:**

- Even if FOCUS is set to MANUAL, focus is automatically adjusted.
- Even if HOLOGRAM F is set to OFF in the menu settings, the auxiliary light emits light.
- Even if you set  No flash, the flash fires.
- You see the subject in incorrect colors, but the recorded picture is in natural colors.

# Recording still images on a “Memory Stick” - Memory photo recording

## Self-timer memory photo recording

You can record images on a “Memory Stick” with the self-timer. You can also use the Remote Commander for this operation.

- (1) Set the POWER switch to MEMORY.
- (2) Press FN and go to PAGE2.
- (3) Press SELFTIMER.

The  (self-timer) indicator appears on the LCD screen.

- (4) Press EXIT to make PAGE2 disappear.
- (5) Press PHOTO deeper.

The self-timer starts counting down from 10 with a beep sound. In the last two seconds of the countdown, the beep sound gets faster, then recording starts automatically.

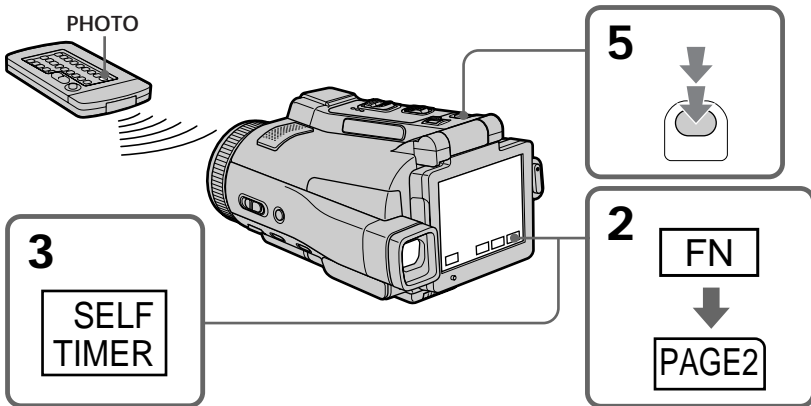

### To cancel self-timer recording

Press SELFTIMER in PAGE2 screen so that the  (self-timer) indicator disappears from the LCD screen. You cannot cancel self-timer recording using the Remote Commander.

#### Note

The self-timer recording mode is automatically canceled when:

- Self-timer recording is finished.
- You turn NIGHTSHOT/NIGHTFRAMING to the other position while the self-timer is counting down.
- The POWER switch is turned to the other position.



# Recording an image from a tape as a still image

Your camcorder can read moving picture data from other equipment recorded on a tape and record it as a still image on a "Memory Stick."

Your camcorder can also take in moving picture data from other equipment through the input connector and record it as a still image on a "Memory Stick."

## Before operation

- Insert a recorded tape into your camcorder.
- Insert a "Memory Stick" into your camcorder.

- (1) Set the POWER switch to VCR.
- (2) Press . The picture recorded on the tape is played back.
- (3) Keep pressing PHOTO lightly until the picture from the tape freezes. CAPTURE appears on the LCD screen. Recording does not start yet.
- (4) Press PHOTO deeper. The image displayed on the LCD screen will be recorded on a "Memory Stick." Recording is complete when the bar scroll indicator disappears.

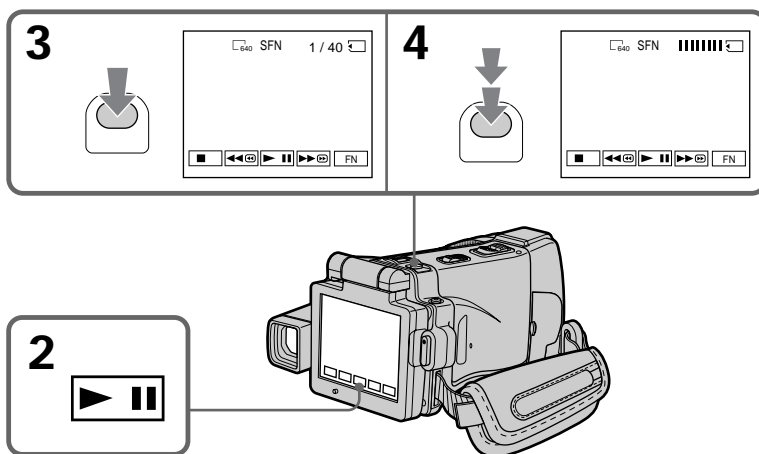

## Recording an image from a tape as a still image

---

### Image size of still images

Image size is automatically set to 640 × 480.

### When the “Memory Stick” access lamp is lit or flashing

Do not shake or strike the unit. As well do not turn the power off, eject a “Memory Stick” or take out the battery pack. Otherwise, the image data breakdown may occur.

### If “” appears on the LCD screen

The inserted “Memory Stick” is incompatible with your camcorder because its format does not conform with your camcorder. Check the format of the “Memory Stick.”

### If you press PHOTO lightly in the playback mode

Your camcorder stops momentarily.

### Sound recorded on a tape

You cannot record audio from a tape.

### Titles which have already been recorded on tapes

You cannot record the titles on the “Memory Stick.” The title does not appear while you are recording a still image with PHOTO.

### Recording date/time

The date/time when it is recorded on a “Memory Stick” is recorded. Various settings are not recorded. Data codes recorded on a tape cannot be recorded on a “Memory Stick”.

### When you press PHOTO on the Remote Commander

Your camcorder immediately records the image that is on the LCD screen when you press the button.

## Recording an image from a tape as a still image

### Recording a still image from other equipment

#### Before operation

Set DISPLAY in **ETC** to LCD in the menu settings. (The default setting is LCD.)

- (1) Set the POWER switch to VCR.
- (2) When using the A/V connecting cable, set VIDEOINPUT to the appropriate position depending on the player. (p. 83)
- (3) Play back the recorded tape on the VCR, or turn the TV on to see the desired program.

The image of the other equipment is displayed on the LCD screen or in the viewfinder.

- (4) At the point where you want to record, follow the steps 3 and 4 on page 121.

#### Using the A/V connecting cable

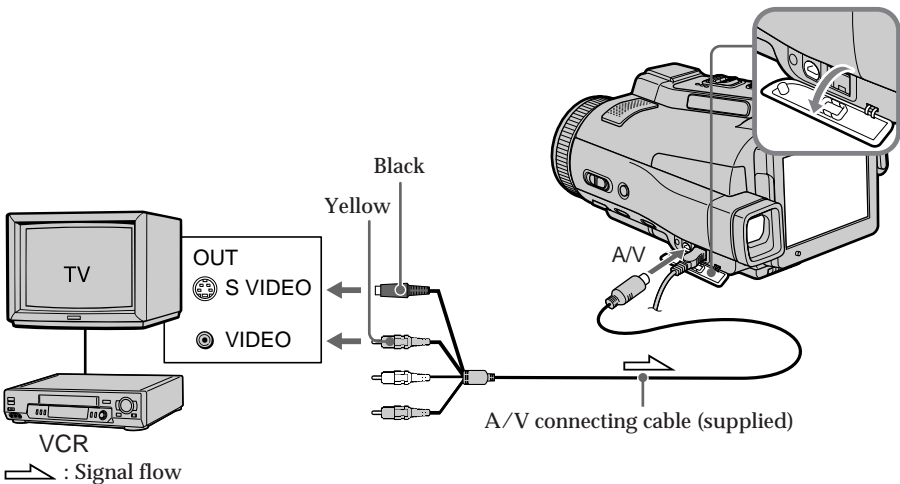

#### If your TV or VCR has an S video jack

Connect using the S video plug to faithfully obtain original pictures. With this connection, you do not need to connect the yellow (video) plug of the A/V connecting cable. Connect the S video plug to the S video jack of the VCR.

## Recording an image from a tape as a still image

---

### Using the i.LINK cable

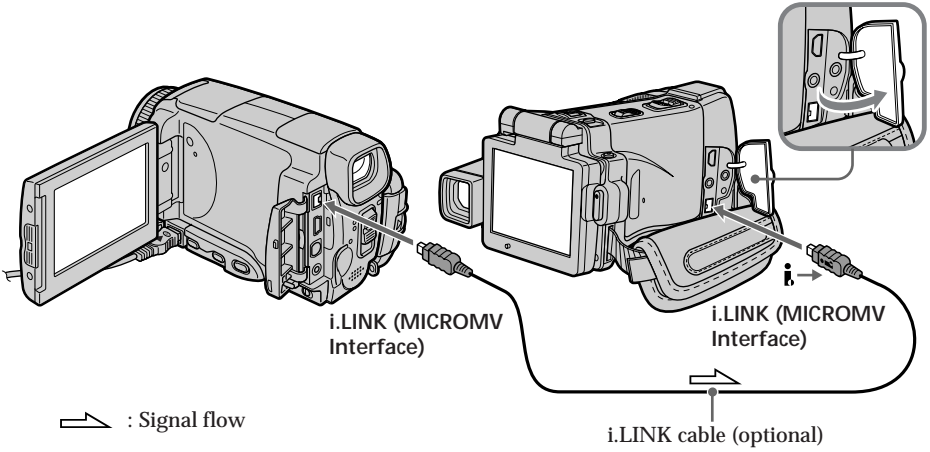

---

#### Note

When recording from a tape in poor recording condition, for example, a tape that is worn out from repeated dubbing, recording is interrupted, or “ REC ERROR” appears and recording cannot be carried out. Record distortion-free images.

# Superimposing a still image in a “Memory Stick” on an image

## – MEMORY MIX

You can superimpose a still image you have recorded on a “Memory Stick” on top of the moving picture you are recording.

You can record the superimposed images on a tape or a “Memory Stick.” (However, you can record only superimposed still images on the “Memory Stick.”)

### M. CHROM (Memory chroma key)

You can swap only the blue area of a still image such as an illustration or a frame with a moving picture.

### M. LUMI (Memory luminance key)

You can swap the brighter area of a still image (such as a handwritten illustration or a title) with a moving picture. To use this function, we recommend recording a title on a “Memory Stick” before a trip or event.

### C. CHROM (Camera chroma key)

You can superimpose a moving picture on top of a still image such as an image which can be used as background. Shoot the subject against a blue background. Only the blue area of the moving picture will be swapped with a still image.

### M. OVERLAP\* (Memory overlap)

You can fade from a still image recorded on a “Memory Stick” into a moving picture being recorded with your camcorder.

#### M. CHROM



Still image



Blue

Moving picture



#### M. LUMI



Still image



Moving picture



#### C. CHROM



Still image

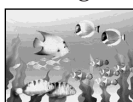

Moving picture



Blue

#### M. OVERLAP\*



Still image



Moving picture



\* The superimposed image using Memory overlap function can be recorded on tapes only.

# Superimposing a still image in a “Memory Stick” on an image - MEMORY MIX

## Recording a superimposed image to a tape

### Before operation

- Insert a tape for recording into your camcorder.
- Insert a “Memory Stick” recorded with still images into your camcorder.

- (1) Set the POWER switch to CAMERA.
- (2) Press FN and go to PAGE2.
- (3) Press MEM MIX. The last image recorded on the “Memory Stick” appears on the right lower part of the LCD screen.
- (4) Press -/+ on the right lower corner of the LCD screen to select the still image which you want to superimpose.
  - : To see the previous image
  - + : To see the next image
- (5) Press a desired mode. The still image is superimposed on the moving picture.
- (6) Press -/+ on the left lower corner of the LCD screen to adjust the effect, then press  $\rightarrow$  OK to return to PAGE2.

- M. CHROM: Blue chroma key (only blue background portion) to extract a still image and superimpose it on a moving picture
- M. LUMI: Brightness level used when extracting a still image and superimposing it on a moving picture
- C. CHROM: Blue chroma key (only blue background portion) to extract a moving picture and superimpose it on a still image
- M. OVERLAP: No adjustment necessary

The fewer bars there are on the LCD screen, the stronger the effect.

- (7) Press EXIT to return to FN.
- (8) Press START/STOP to start recording.

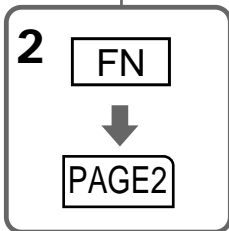
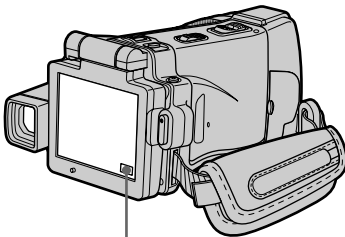

<b>3,4</b>		Still image
<b>5</b>		
<b>6</b>		

## Superimposing a still image in a “Memory Stick” on an image - MEMORY MIX

---

### To change the still image to be superimposed

Press -/+ on the right lower corner before step 6.

### To cancel MEMORY MIX

Press  $\rightarrow$  OFF in step 3. The display returns to PAGE2.

---

#### Notes

- You cannot use the MEMORY MIX function for moving pictures recorded on the “Memory Stick.”
- When the overlapping still image has a large amount of white, the thumbnail image of the picture may not be clear.
- During recording you cannot reselect the mode setting. Press  $\rightarrow$  OFF to return to PAGE2.

### Image data modified on your computer or shot with other equipment

You may not be able to play modified images back with your camcorder.

### When you select M. OVERLAP

You cannot change the still image. Press  $\rightarrow$  OFF to cancel the M. OVERLAP mode, then select the image again.

## Recording a superimposed image to a “Memory Stick” as a still image

### Before operation

Insert a recorded “Memory Stick” into your camcorder.

- (1) Set the POWER switch to MEMORY.
- (2) Press FN and go to PAGE2.
- (3) Press MEM MIX. The image recorded on the “Memory Stick” appears on the right corner of the LCD screen.
- (4) Press -/+ on the right lower corner of the LCD screen to select the still image which you want to superimpose.
  - : To see the previous image
  - + : To see the next image
- (5) Press a desired mode. The still image is superimposed on the moving picture.
- (6) Press -/+ on the left lower corner of the LCD screen to adjust the effect, then press  OK. The display returns to PAGE2.

- M. CHROM: Blue chroma key (blue background) to extract a still image and superimpose it on a moving picture
- M. LUMI: Brightness level used when extracting a still image and superimposing it on a moving picture
- C. CHROM: Blue chroma key (blue background) to extract a moving picture and superimpose it on a still image

The fewer bars there are on the LCD screen, the stronger the effect.

- (7) Press EXIT to return to FN.
- (8) Press PHOTO deeper to start recording.

The image displayed on the LCD screen will be recorded on a “Memory Stick.”  
Recording is complete when the bar scroll indicator disappears.



# Superimposing a still image in a “Memory Stick” on an image - MEMORY MIX

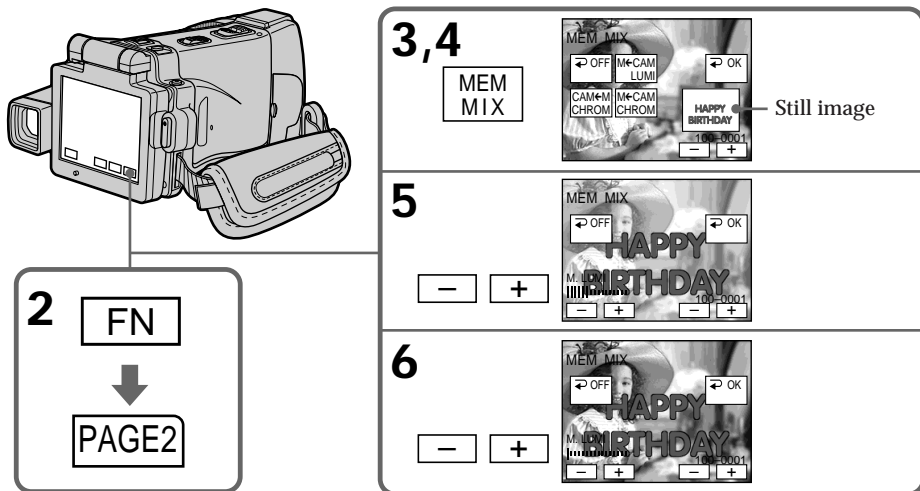

## To change the still image to be superimposed

Press -/+ on the right lower corner before step 6.

## To cancel MEMORY MIX

Press  $\rightarrow$  OFF in step 3. The display returns to PAGE2.

## Notes

- You cannot use MEMORY MIX function for moving pictures recorded on the “Memory Stick.”
- When the overlapping still image has a large amount of white, the thumbnail image of the picture may not be clear.
- During recording you cannot reselect the mode setting. Press  $\rightarrow$  OFF to return to PAGE2.

## Image size of still images

Image size is automatically set to 640 × 480.

## Image data modified with your computers or shot with other equipment

You may not be able to play them back with your camcorder.

## When recording images on a “Memory Stick” using MEMORY MIX

The PROGRAM AE does not work.

## The “Memory Stick” supplied with your camcorder stores 20 images:

- For M. CHROM: 18 images (such as a frame) 100-0001 to 100-0018
- For C. CHROM: two images (such as a background) 100-0019 to 100-0020

## Sample images

Sample images stored in the “Memory Stick” supplied with your camcorder are protected (p. 146).

# Recording moving pictures on a “Memory Stick” – MPEG MOVIE recording

You can record moving pictures with sound on the “Memory Stick.”

## Before operation

Insert a “Memory Stick” into your camcorder.

- (1) Set the POWER switch to MEMORY.
- (2) Press START/STOP. Your camcorder starts recording. The camera recording lamp located on the front of your camcorder lights up.

Quality mode	Maximum recordable time
SUPER FINE	45 s
FINE	1 min 10 s
STANDARD	2 min 20 s
LIGHTMODE	4 min 40 s

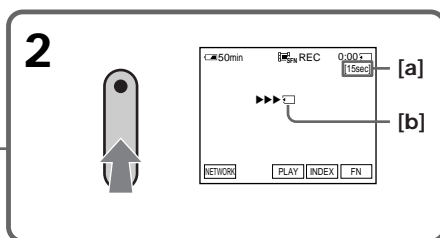
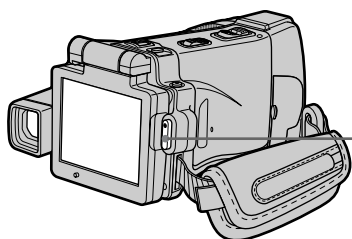

[a] Recording time indicator can be recorded on the “Memory Stick.”

[b] This indicator is displayed for five seconds after pressing START/STOP. This indicator is not recorded.

## To stop recording

Press START/STOP.

## Recording moving pictures on a “Memory Stick” – MPEG MOVIE recording

---

### Note

Sound is recorded in monaural.

### MPEG MOVIE recorded with your camcorder:

- Is MPEG MOVIE AD
- Cannot be played back on a digital still camera or a camcorder that has no MPEG MOVIE AD function.
- Cannot be output from the i.LINK (MICROMV Interface).

### When the POWER switch is set to MEMORY

The following functions do not work:

- Digital zoom
- Super NightShot
- Color Slow Shutter
- Wide mode
- Fader
- Picture effect
- Digital effect
- Sports lesson of PROGRAM AE (The indicator flashes.)
- Title
- SteadyShot

### When using an external flash (optional)

Turn the power of the external flash off when recording moving pictures on a “Memory Stick.”

Otherwise, the charging sound of the flash may be recorded.

### Recording date/time

The date/time are not displayed while recording. However, they are automatically recorded onto the “Memory Stick.” To display the recording date/time, press DATA CODE during playback. Various settings cannot be recorded. You can also use the Remote Commander for this operation (p. 43).

### During recording on a “Memory Stick”

Do not eject the cassette from your camcorder. While ejecting the tape, sound is not recorded on “Memory Stick.”

### When the POWER switch is set to MEMORY

The angle of view is slightly larger compared with the angle of view in CAMERA mode.

# Recording moving pictures on a “Memory Stick” – MPEG MOVIE recording

## Self-timer MPEG MOVIE recording

You can record pictures on the “Memory Stick” with the self-timer. You can also use the Remote Commander for this operation.

- (1) Set the POWER switch to MEMORY.
- (2) Press FN and go to PAGE2.
- (3) Press SELFTIMER.

The  (self-timer) indicator appears on the LCD screen.

- (4) Press EXIT to make PAGE2 disappear.
- (5) Press START/STOP.

Self-timer starts counting down from about 10 with a beep. In the last two seconds of the countdown, the beep gets faster, then recording starts automatically.

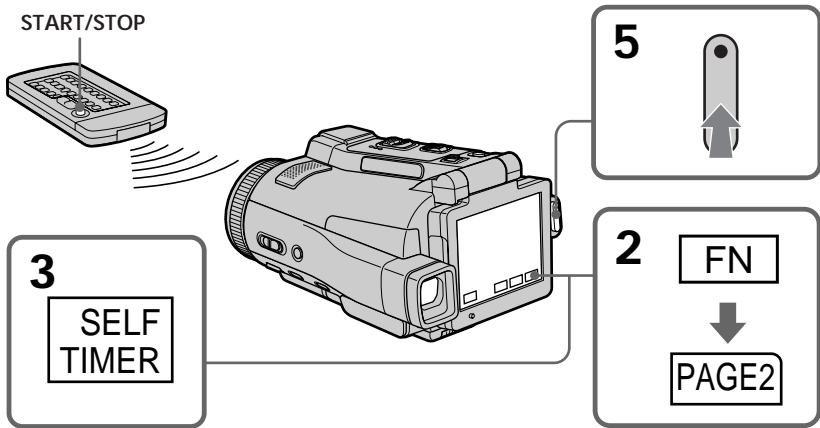

### To stop the countdown

Press START/STOP.

To restart the countdown, press START/STOP again.

### To cancel the self-timer recording

Press SELFTIMER in PAGE2 screen so that the  (self-timer) indicator disappears on the LCD screen. You cannot cancel the self-timer recording using the Remote Commander.

---

#### Note

The self-timer recording mode is automatically canceled when:

- Self-timer recording is finished.
- You turn NIGHTSHOT/NIGHTFRAMING to the other position while the self-timer is counting down.
- The POWER switch is turned to the other position.

# Recording a picture from a tape as a moving picture

Your camcorder can read moving picture data recorded on a tape and record it as a moving picture on a "Memory Stick." Your camcorder can also take in moving picture data through the input connector and record it as a moving picture on a "Memory Stick."

## Before operation

- Insert a recorded tape into your camcorder.
- Insert a "Memory Stick" into your camcorder.

- (1) Set the POWER switch to VCR.
- (2) Press . The picture recorded on the tape is played back.
- (3) Press START/STOP at the scene where you want to start recording from.

Quality mode	Maximum recordable time
SUPER FINE	45 s
FINE	1 min 10 s
STANDARD	2 min 20 s
LIGHTMODE	4 min 40 s

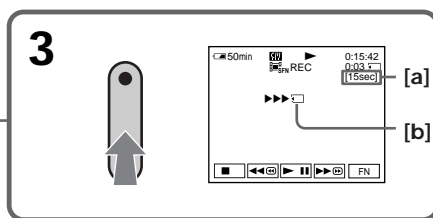
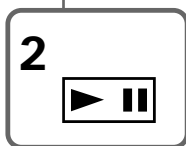
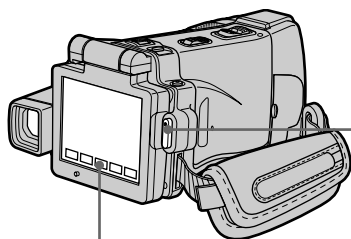

- [a] Recording time indicator can be recorded on the "Memory Stick."
- [b] This indicator is displayed for five seconds after pressing START/STOP. This indicator is not recorded.

## To stop recording

Press START/STOP.

### Note

Sound recorded in stereo is converted to monaural sound when recording from a tape.

### When the "Memory Stick" access lamp is lit or flashing

Do not shake or strike the unit. As well do not turn the power off, eject a "Memory Stick" or take out the battery pack. Otherwise, the image data breakdown may occur.

### Titles which have already been recorded on tapes

You cannot record the titles on the "Memory Stick." The title does not appear while you are recording a moving picture with START/STOP.

### Recording date/time

The date/time when it is recorded on a "Memory Stick" is recorded. Various settings are not recorded. Data codes recorded on a tape cannot be recorded on a "Memory Stick".

## Recording a picture from a tape as a moving picture

### Recording a moving picture from other equipment

#### Before operation

Set DISPLAY in  $\overline{\text{ETC}}$  to LCD in the menu settings. (The default setting is LCD.)

- (1) Set the POWER switch to VCR.
- (2) When using the A/V connecting cable, set VIDEOINPUT to the appropriate position depending on the player. (p. 83)
- (3) Play back the recorded tape on the VCR, or turn the TV on to see the desired program.

The image of the other equipment is displayed on the LCD screen or in the viewfinder.

- (4) Press START/STOP at the scene where you want to start recording from.

#### Using the A/V connecting cable

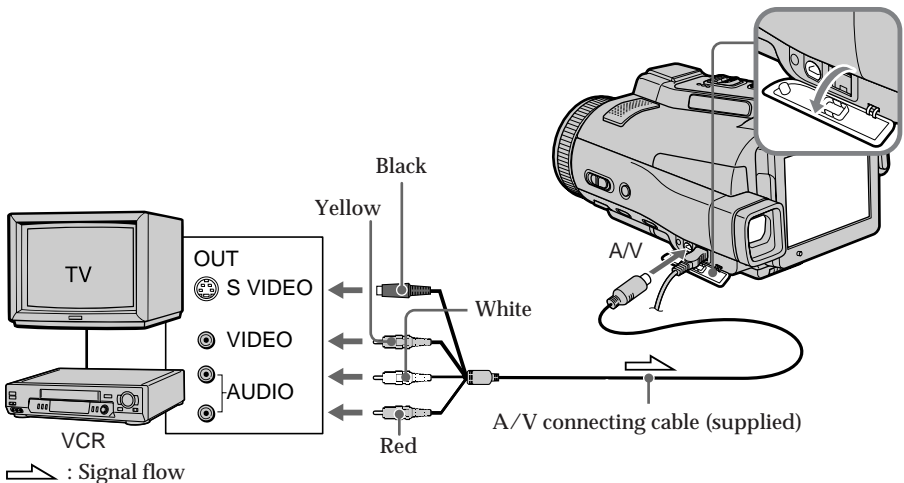

#### If your TV or VCR has an S video jack

Connect using the S video plug to faithfully obtain original pictures. With this connection, you do not need to connect the yellow (video) plug of the A/V connecting cable. Connect the S video plug to the S video jack of the VCR.

## Recording a picture from a tape as a moving picture

### Using the i.LINK cable

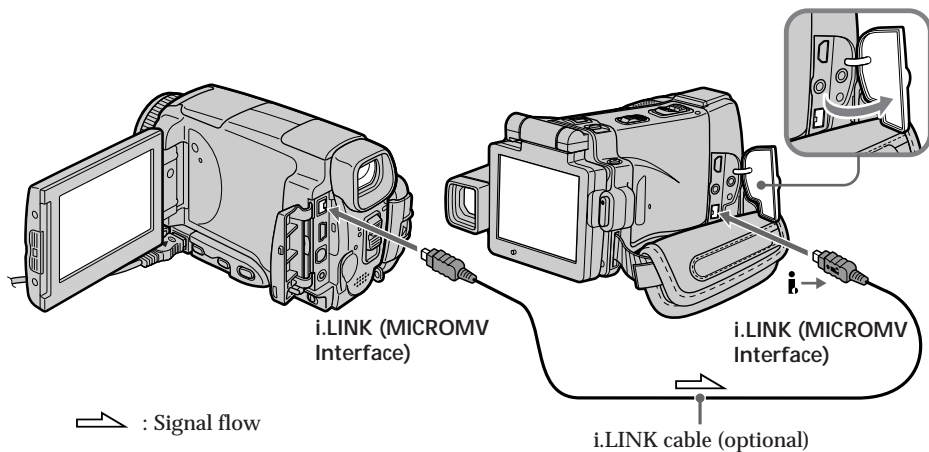

#### Note

When recording from a tape in poor recording condition, for example, a tape that is worn out from repeated dubbing, recording is interrupted, or “ REC ERROR” appears and recording cannot be carried out. Record distortion-free images.

# Viewing a still image – Memory photo playback

You can play back still images recorded on a “Memory Stick.” You can also play back six images including moving pictures on single screen arranged in the same order as a “Memory Stick” by selecting the index screen.

## Before operation

Insert a “Memory Stick” into your camcorder.

- (1) Set the POWER switch to MEMORY or VCR.
- (2) Press PLAY or  PB. The last recorded image is displayed.
- (3) Press -/+ to select the desired still image.
  - : To see the previous image
  - + : To see the next image

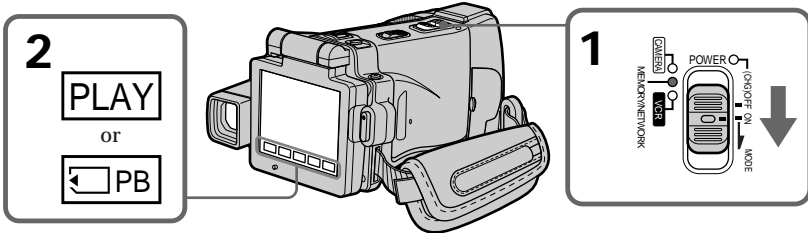

## To stop memory photo playback

Press CAM, VCR on your camcorder or MEMORY PLAY on the Remote Commander.

### Note

You may not be able to play back images with your camcorder:

- When playing back image data modified on your computers
- When playing back image data shot with other equipment

### Playback still images recorded on the “Memory Stick”

Playback images are not output from the i.LINK (MICROMV Interface).

### File name

- The directory number may not be displayed and only the file name may be displayed if the structure of the directory does not conform to the DCF standard.
- “ DIRECTORY ERROR” may appear on the LCD screen if the structure of the directory does not conform to the DCF standard. If this message appears, you can play back images but cannot record them on the “Memory Stick.”
- The file name flashes on the LCD screen if the file is corrupted or the file is unreadable.



## Viewing a still image – Memory photo playback

To play back recorded images on a TV screen

- Connect your camcorder to the TV with the A/V connecting cable supplied with your camcorder before the operation.
- When operating memory photo playback on a TV or on the LCD screen, the image quality may appear to have deteriorated. This is not a malfunction. The image data is as good as ever.
- Turn the audio volume of the TV down before operation, or noise (howling) may be output from the TV speakers.

### Still image

You can select still images also with -/+ on PAGE1, PAGE2 or PAGE3.

## Screen indicators during still image playback

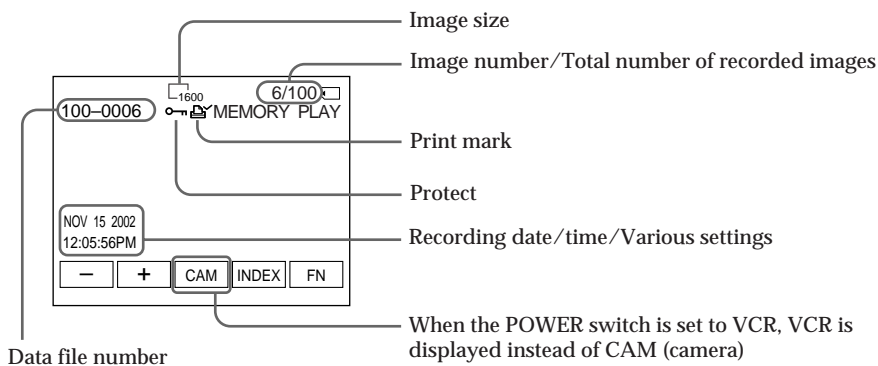

### When no images are recorded on the “Memory Stick”

When you press MEMORY PLAY on the Remote Commander, “ NO FILE” appears.

### Recording data

To display the recording data (date/time or various settings when recorded), press DATA CODE during playback. You can also use the Remote Commander for this operation (p. 43).

### To make LCD screen indicators disappear

Press DISPLAY/TOUCH PANEL.

## Viewing a still image – Memory photo playback

### Playing back six recorded images at a time (index screen)

You can play back six recorded images at a time. This function is especially useful when searching for a particular image.

- (1) Set the POWER switch to MEMORY or VCR.
- (2) In VCR mode, press  PB.  
In MEMORY mode, go to step 3.
- (3) Press INDEX to display the index.

A red ► mark appears above the image that is displayed before changing to the index screen mode.

- To display the previous six images, press ←.
- To display the following six images, press →.

You can also use -/+ on the Remote Commander.

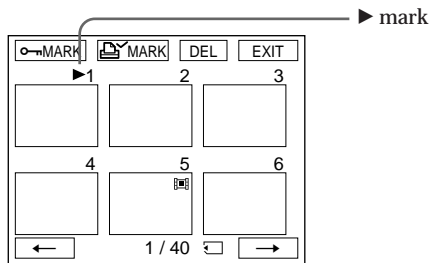

#### To return to FN

Press EXIT.

#### To return to the normal playback screen (single screen)

Press the image you want to display.

---

#### Note

When displaying the index screen, the number appears above each image. This indicates the order in which images are recorded on the “Memory Stick.” These numbers are different from the data file names (p. 100).

**Image data modified with your computer or shot with other equipment**  
These files may not be displayed on the index screen.



# Viewing a moving picture

## - MPEG MOVIE playback

You can play back moving pictures recorded on a "Memory Stick." You can also play back six images including still images in order at a time by selecting the index screen.

### Before operation

Insert a "Memory Stick" into your camcorder.

- (1) Set the POWER switch to MEMORY or VCR.
- (2) Press PLAY or  PB. The last recorded image is displayed.
- (3) Press -/+ to select the desired moving pictures.
  - : To see the previous picture
  - + : To see the next picture
- (4) Press MPEG   to start playback.
- (5) Press VOL- or VOL+ to adjust the volume.

VOL- : To decrease the volume

VOL+ : To increase the volume

When the LCD panel is closed with the LCD screen facing inwards, no sound is heard from your camcorder.

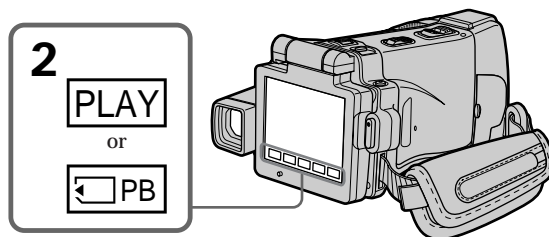

### To pause MPEG MOVIE playback

Press MPEG  . To resume playback, press MPEG   again.

### To change the screen size

Press SCR N SIZE. The screen size changes as follows:

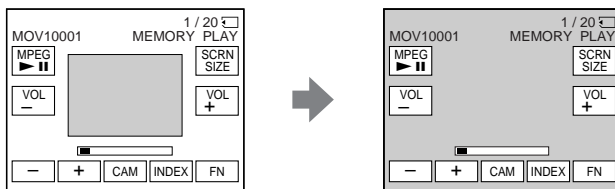

### Notes on the screen size

- The picture may not be displayed at the middle of the LCD screen, depending on the movie.
- Even if you switch the screen size, the picture may not be displayed full-screen size, depending on the movie.

### Note

You may not be able to play back images with your camcorder:

- When playing back image data modified on your computer
- When playing back image data shot with other equipment

## Viewing a moving picture – MPEG MOVIE playback

MPEG MOVIE recorded with your camcorder:

- Is MPEG MOVIE AD
- Cannot be played back on a digital still camera or a camcorder that has no MPEG MOVIE AD function.
- Cannot be output from the i.LINK (MICROMV Interface).

To play back recorded images on a TV screen

- Connect your camcorder to the TV with the A/V connecting cable supplied with your camcorder before operation.
- Turn the audio volume of the TV down before operation, or noise (howling) may be output from the TV speakers.

Moving picture

You can select moving pictures also with -/+ on PAGE1, PAGE2 or PAGE3.

When no images are recorded on the “Memory Stick”

When you press MEMORY PLAY on the Remote Commander, “ NO FILE” appears.

### Screen indicators during moving picture playback

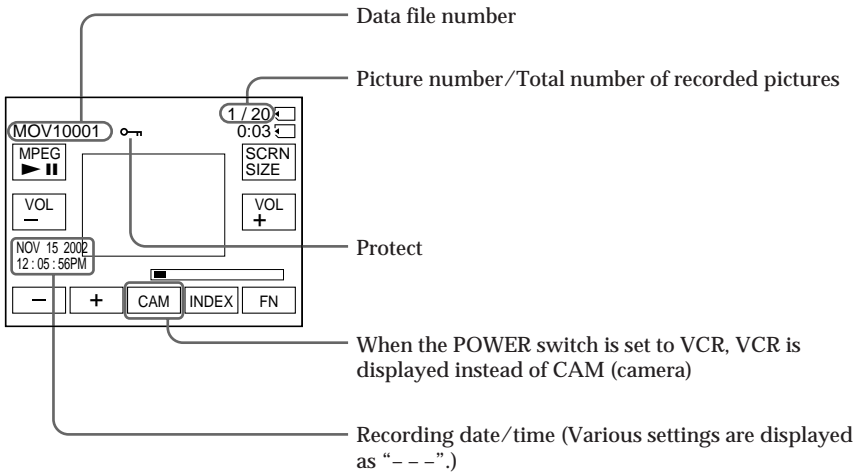

**Recording date/time**

To display the recording date/time, press DATA CODE during playback. You can also use the Remote Commander for this operation (p. 43).

**To make screen indicators disappear**



Press DISPLAY/TOUCH PANEL.

# Copying still images recorded on a “Memory Stick” to a tape

You can copy still images recorded on a “Memory Stick” and record them to a tape. You can also use the Remote Commander for this operation.

## Before operation

- Insert a tape for recording into your camcorder.
- Insert a “Memory Stick” into your camcorder.

- (1) Set the POWER switch to VCR.
- (2) Using the video control buttons, search a point where you want to record the desired images and stop playback.
- (3) Press  PB. The last recorded image is displayed.
- (4) Press -/+ to select the desired image.
  - : To see the previous image
  - + : To see the next image
- (5) Press FN and go to PAGE3.
- (6) Press  REC CTRL, then REC START.  
Copying starts.  
Press REC PAUSE at the scene where you want to stop recording.
- (7) If you have more to copy, repeat steps 4 to 6.

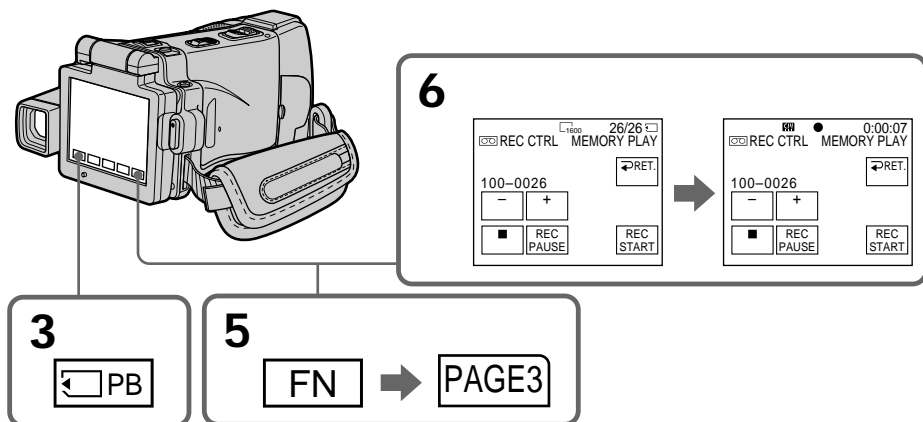

## To stop copying in the middle

Press  on the LCD screen or STOP on the Remote Commander.

## To return to FN

Press  RET. after step 6, then press EXIT.

## Copying still images recorded on a "Memory Stick" to a tape

---

### To start copying using the Remote Commander

After step 4, press both ● REC and the right button simultaneously to start copying.

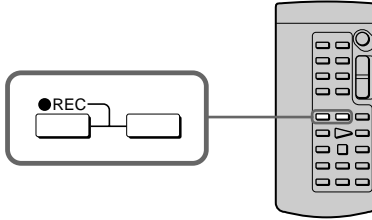

---

### Notes

- You cannot copy MPEG MOVIE files to the tape when "NOT REC" is displayed.
- You cannot copy the index screen to the tape.

### During copying

You cannot operate the following functions:

- MEMORY PLAY
- MEMORY INDEX
- MEMORY DELETE
- MEMORY +/-
- MEMORY MIX

### Image data modified on your computer or shot with other equipment

You may not be able to copy modified images with your camcorder.

# Enlarging still images recorded on a “Memory Stick” – Memory PB ZOOM

You can enlarge still images recorded on a “Memory Stick.” You can select and view a desired part from the enlarged still image. Also, you can copy the desired part of the enlarged still image to a “Memory Stick.”

## Before operation

Insert a “Memory Stick” into your camcorder.

- (1) In the memory playback mode, press FN and go to PAGE2.
- (2) Press PB ZOOM. PB ZOOM screen appears.
- (3) Press the area that you want to enlarge in the frame on the PB ZOOM screen.  
The area you pressed moves to the center of the LCD screen, and the playback image is enlarged at twice the size. If you press the other area, the area moves to the center of the LCD screen.
- (4) Adjust the zoom ratio by the zoom lever.  
You can select the image from 1.1 times up to five times its size.  
“W” side: Decrease the zoom ratio.  
“T” side: Increase the zoom ratio.

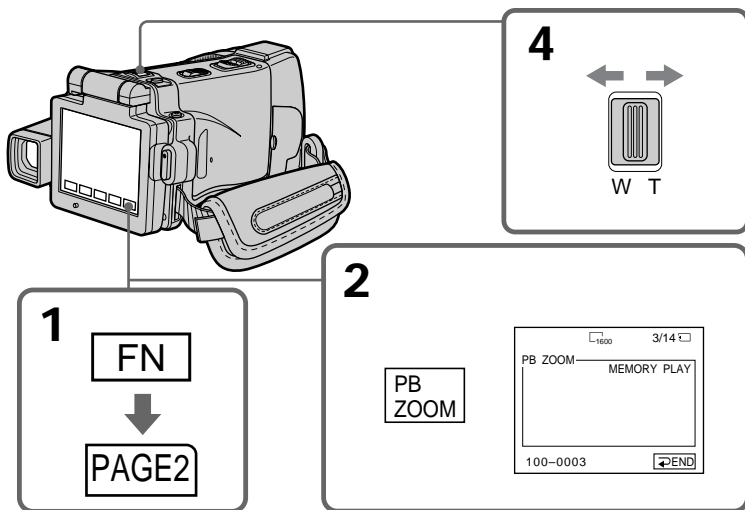

## To cancel the Memory PB ZOOM function

Press  END.

## **Enlarging still images recorded on a “Memory Stick” - Memory PB ZOOM**

---

### **Images in the Memory PB ZOOM mode**

Images are not output through the i.LINK (MICROMV Interface).

### **In the Memory PB ZOOM mode**

If you press DISPLAY/TOUCH PANEL, the frame on the Memory PB ZOOM screen disappears. You cannot move the part you pressed to the center of the LCD screen.

### **Edge of an enlarged image**

The edge of an enlarged image cannot be displayed in the center of the LCD screen.

### **Moving pictures recorded on the “Memory Stick”**

The PB ZOOM function does not work.

### **To record an image processed by PB ZOOM on the “Memory Stick”**

Press PHOTO to record the image processed by PB ZOOM. (Images are recorded at 640 × 480 size.)

### **When FOCUS is set to ZOOM**

You can change the zoom ratio using the zoom ring.



# Playing back images continuously – SLIDE SHOW

Your camcorder can automatically play back images in sequence. This function is especially useful when checking recorded images or during a presentation.

## Before operation

Insert a “Memory Stick” into your camcorder.

- (1) Set the POWER switch to MEMORY.
- (2) Press FN to display PAGE1.
- (3) Press MENU, then select SLIDE SHOW in  in the menu settings (p. 182). And press EXEC.
- (4) Press START. Your camcorder plays back the images recorded on a “Memory Stick” in sequence.

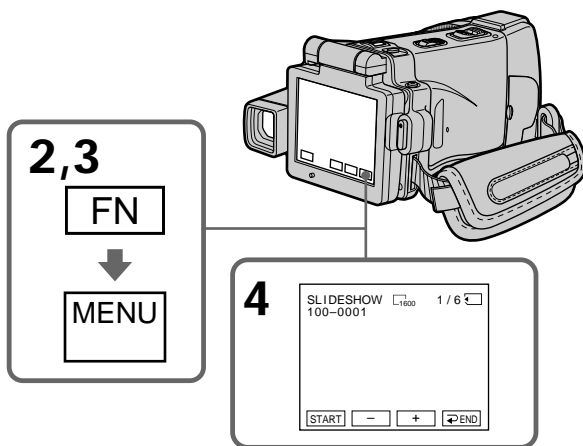

## To stop the slide show

Press  END.

## To pause during a slide show

Press PAUSE.

## To return to FN

Press  END, then press EXIT.

## To start the slide show from a particular image

Select the desired image using   buttons before step 4.

## To view the recorded images on TV

Connect your camcorder to a TV with the A/V connecting cable supplied with your camcorder (p. 46) before operation.

## If you change the “Memory Stick” during operation

The slide show does not operate. If you change the “Memory Stick,” be sure to follow the steps again from the beginning.

## When there are no images on the “Memory Stick”



 NO FILE” appears.

# Preventing accidental erasure – Image protection

To prevent accidental erasure of important images, you can protect selected images.

## Before operation

Insert a “Memory Stick” into your camcorder.

- (1) Set the POWER switch to MEMORY or VCR.
- (2) In VCR mode, press  PB.  
In MEMORY mode, go to step 3.
- (3) Press INDEX to display the index.
- (4) Press  MARK. The screen to protect the image appears.
- (5) Press the image you want to protect. The “” appears above the protected image.

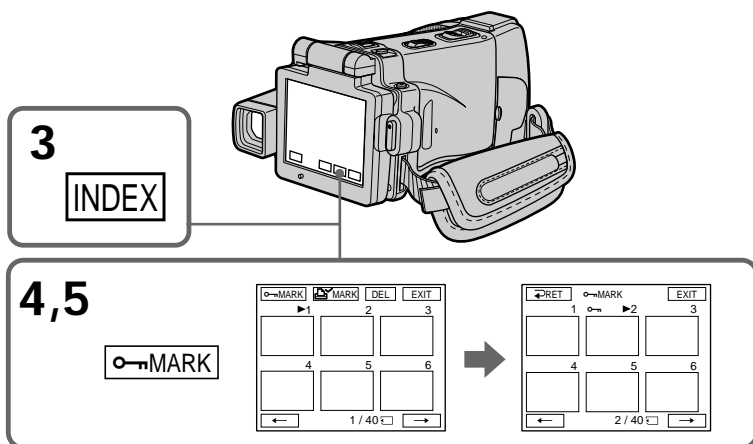

## To return to FN

Press EXIT.

## To cancel image protection

Press the image you want to cancel image protection in step 5 again. The “” disappears.

## Note

Formatting erases all information on the “Memory Stick,” including the protected image data. Check the contents of the “Memory Stick” before formatting.

If the write-protect tab on the “Memory Stick” is set to LOCK  
You cannot carry out image protection.

# Deleting images – DELETE

You can delete images stored in a “Memory Stick.” You can delete all images or selected images.

## Deleting selected images

### Before operation

Insert a “Memory Stick” into your camcorder.

- (1) Set the POWER switch to MEMORY or VCR.
- (2) Press PLAY or  $\square$  PB, then press -/+ to select the image you want to delete.
- (3) Press FN to display PAGE1.
- (4) Press DELETE. “DELETE?” appears on the LCD screen.
- (5) Press OK. The selected image is deleted.

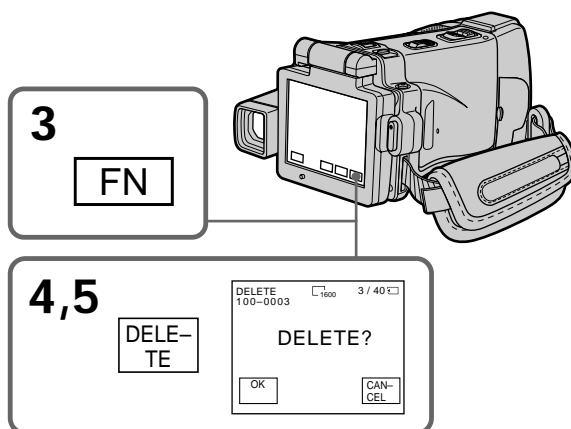

### To return to FN

Press EXIT after step 5.

### To cancel deleting an image

Press CANCEL in step 5.

### Notes

- To delete a protected image, first cancel image protection.
- Once you delete an image, you cannot restore it. Check the images to delete carefully before deleting them.

If the write-protect tab on the “Memory Stick” is set to LOCK  
You cannot delete images.

## Deleting images – DELETE

### Deleting selected images on the index screen

#### Before operation

Insert a “Memory Stick” into your camcorder.

- (1) Set the POWER switch to MEMORY or VCR.
- (2) In VCR mode, press  $\square$  PB.  
In MEMORY mode, go to step 3.
- (3) Press INDEX to display the index.
- (4) Press DEL, then press the image you want to delete. The number of the selected image is highlighted.
- (5) If there is other image you want to delete, press the image.
- (6) After selecting the image to be deleted, press EXEC. “DELETE?” appears on the LCD screen.
- (7) Press OK. The selected images are deleted.

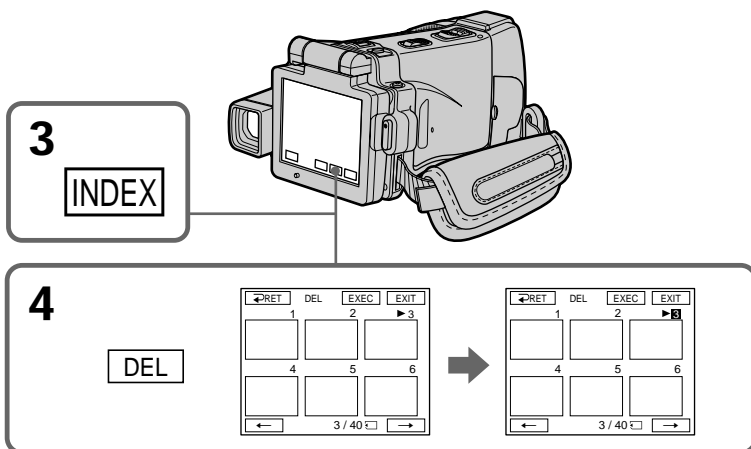

#### To return to FN

Press EXIT after step 7.

#### To cancel deleting an image

Press CANCEL in step 7.

## Deleting images – DELETE

### Deleting all the images

You can delete all the unprotected images in a “Memory Stick.”

#### Before operation

Insert a “Memory Stick” into your camcorder.

- (1) Set the POWER switch to MEMORY.
- (2) Press FN to display PAGE1.
- (3) Press MENU, then select DELETE ALL in  in the menu settings (p. 182).  
And press EXEC.
- (4) Press  $\uparrow/\downarrow$  to select OK, then press EXEC.  
“OK” changes to “EXECUTE”.
- (5) Press EXEC.  
DELETING appears on the LCD screen. When all the unprotected images are deleted, COMPLETE is displayed.

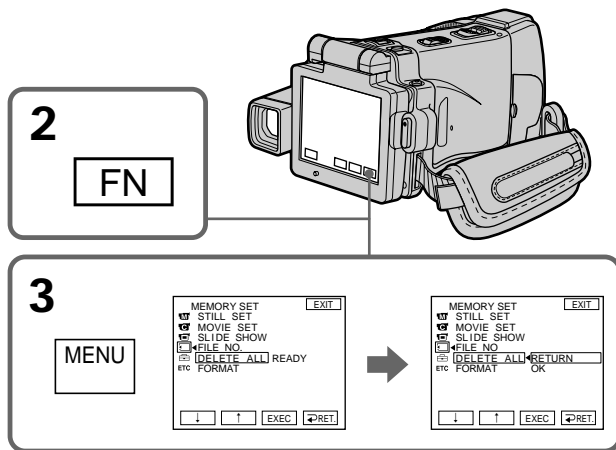

#### To return to FN

Press EXIT.

#### To cancel deleting all the images

Press  $\uparrow/\downarrow$  to select RETURN in step 5, then press EXEC.

#### While “DELETING” appears

Do not turn the POWER switch to the other position or press any buttons.



# Writing a print mark – PRINT MARK

You can specify the recorded still image to print out by putting marks. This function is useful for printing out still images later.

Your camcorder conforms with the DPOF (Digital Print Order Format) standard for specifying the still images to print out.

## Before operation

Insert a “Memory Stick” into your camcorder.

- (1) Set the POWER switch to MEMORY or VCR.
- (2) In VCR mode, press  PB.  
In MEMORY mode, go to step 3.
- (3) Press INDEX to display the index.
- (4) Press  MARK. The screen to write a print mark appears.
- (5) Press the image you want to write a print mark. The  appears on the selected image.

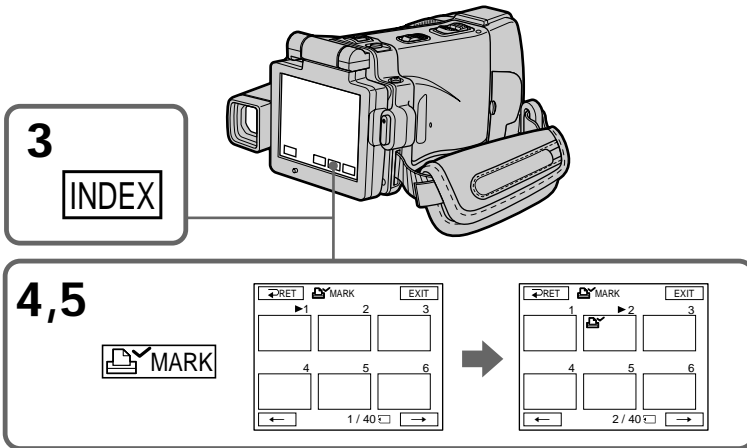

## To return to FN

Press EXIT.

## To cancel writing print marks

Press the image you want to cancel the print mark in step 5 again. The  disappears.

---

If the write-protect tab on the “Memory Stick” is set to LOCK

You cannot write print marks on still images.

## Moving pictures

You cannot write print marks on moving pictures.

# Viewing images on your computer

## – Introduction

There are the following ways of connecting your camcorder to a computer in order to view images saved on a “Memory Stick” or recorded on a tape on your computer.

To view images on a computer which has a Memory Stick slot, first remove the “Memory Stick” from your camcorder and then insert it into the computer’s Memory Stick slot.

	Camcorder Connection jack	Connection cable	Computer environment requirements	Reference pages	
				For Windows users	For Macintosh users
Tape image	USB jack	USB cable (supplied)	USB connector, editing software	154 – 156 158 – 159 164– 168	—
	i.LINK (MICROMV Interface)	i.LINK cable (optional)	i.LINK (IEEE 1394), connector editing software	153	—
“Memory Stick” image	USB jack*	USB cable (supplied)	USB connector, editing software	154 – 157 160 169 – 171	172 – 174

### \* When connecting to a computer without a USB jack

Use an optional floppy disk adaptor for Memory Sticks or a PC card adaptor for Memory Sticks.

When purchasing an accessory, check its catalog beforehand for the recommended operating environment.

When connecting to a computer, complete installation of the i.LINK driver, the USB driver or the application softwares before connecting your camcorder to the computer. If you connect your camcorder to your computer first, you will not be able to install the i.LINK driver or the USB driver correctly.

For details about your computer’s connectors and editing software, contact the computer manufacturer.

### Notes on using your computer

#### **“Memory Stick”**

- “Memory Stick” operations on your camcorder cannot be assured if a “Memory Stick” formatted on your computer is used on your camcorder, or if the “Memory Stick” in your camcorder was formatted from your computer when the USB cable was connected.
- Do not compress the data on the “Memory Stick.” Compressed files cannot be played back on your camcorder.

#### **Software**

- Depending on your application software, the file size may increase when you open a still image file.
- When you load an image modified using retouching software from your computer to your camcorder or when you directly modify the image on your camcorder, the image format will differ so a file error indicator may appear and you may be unable to open the file.

#### **Communications with your computer**

Communications between your camcorder and your computer may not recover after recovering from Suspend, Resume, or Sleep.



# Connecting your camcorder to your computer using the i.LINK cable (For Windows users)

You can view or edit the images recorded on a tape using your computer. You can also record images edited with the computer on the tape.

To view images on your computer, the application software MovieShaker Ver.3.1 for MICROMV (supplied) and i.LINK cable (optional) is required.

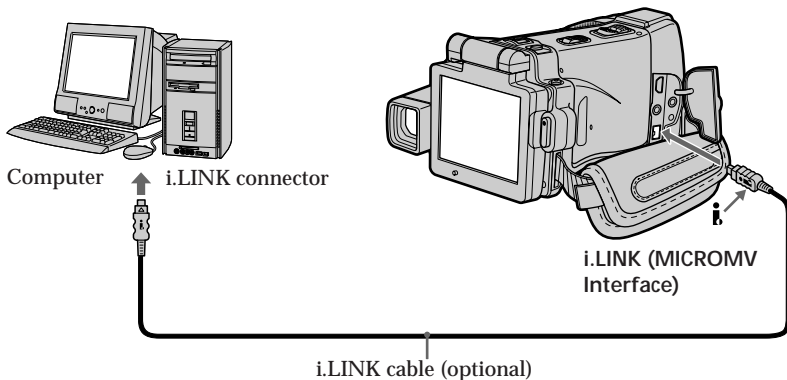

Before installing the i.LINK driver and the application software into your computer, be sure not to connect your camcorder to the computer.

## Note

To view images on your computer, you have to install the i.LINK driver and the application software into your computer. They are included in the supplied application software MovieShaker Ver.3.1 for MICROMV.

For details on installing and on an i.LINK connection, refer to the operating instructions supplied with MovieShaker Ver.3.1 for MICROMV.

## Recommended computer environment

### Recommended Windows environment

- OS: Microsoft Windows Me, Windows 2000 Professional, Windows XP Home Edition, Windows XP Professional.  
Standard installation is required.  
Operation is not assured if the above environment is an upgraded OS.
- CPU: Pentium III 600 MHz or faster (Required)  
(Pentium III 800 MHz or faster (Recommended))
- Main memory: 128 MB or larger (Required)  
(256 MB or larger (Recommended))
- Display: 800 × 600 or larger screen size/1024 × 480 or larger screen size, 16-bit color or higher
- Hard disk: 100 MB hard disk space (for installation), ATA66 or higher speed (required for capturing an image)

The i.LINK terminal (IEEE1394) shall be equipped.

## Note

Operations are not guaranteed for all the recommended computer environments mentioned above.

# Connecting your camcorder to your computer using the USB cable (For Windows users)

Complete installation of the USB driver before connecting your camcorder to your computer. If you connect your camcorder to your computer first, you will not be able to install the USB driver correctly.

## When connecting to a computer via the USB jack

You must install a USB driver onto your computer in order to connect your camcorder to the computer's USB connector. The USB driver can be found on the CD-ROM supplied, along with the application software required for viewing images.

If you connect your camcorder and your computer using the USB cable, you can view pictures live from your camcorder and pictures recorded on a tape on your computer (USB Streaming function).

Furthermore, if you download pictures from your camcorder to your computer, you can process or edit them in image processing software and append them to e-mail.

You can view images recorded on a "Memory Stick" on your computer.

## Recommended computer usage environment when connecting via USB cable and viewing tape images on your computer

### OS:

Microsoft Windows 98SE, Windows Me, Windows 2000 Professional, Windows XP Home Edition or Windows XP Professional

Standard installation is required.

However, operation is not assured if the above environment is an upgraded OS.

You cannot hear sound if your computer is running Windows 98, but you can read still images.

### CPU:

Pentium III 500 MHz or faster (800 MHz or faster recommended)

### Application:

DirectX 8.0a or later

### Sound system:

16 bit stereo sound card and stereo speakers

### Memory:

64 MB or more

### Hard disk:

Available memory required for installation:

at least 200MB

Available hard disc memory recommended:

at least 1GB (depending on the size of the image files edited)

### Display:

4 MB VRAM video card, Minimum 800 × 600 dot High color (16 bit color, 65 000 colors), Direct Draw display driver capability (At 800 × 600 dot or less, 256 colors and less, this product will not operate correctly.)

### Others:

This product is based on DirectX technology, so it is necessary to install DirectX.

The USB connector must be provided as standard.

You cannot use this function in the Macintosh environment.

## Connecting your camcorder to your computer using the USB cable (For Windows users)

---

### Recommended computer usage environment when connecting via USB cable and viewing the “Memory Stick” images on your computer

#### Recommended Windows environment

##### OS:

Microsoft Windows 98, Windows 98SE, Windows Me, Windows 2000 Professional, Windows XP Home Edition or Windows XP Professional

Standard installation is required.

However, operation is not assured if the above environment is an upgraded OS.

##### CPU:

MMX Pentium 200 MHz or faster

The USB connector must be provided as standard.

Windows Media Player must be installed (to play back moving pictures).

---

#### Notes

- Operations are not guaranteed for the Windows environment if you connect two or more USB equipment to a single computer at the same time, or when using a hub.
- Some equipment may not operate depending on the type of USB equipment that is used simultaneously.
- Operations are not guaranteed for all the recommended computer environments mentioned above.
- Windows and Windows Media are registered trademarks of Microsoft Corporation in the United States and/or other countries.
- Pentium is trademark or registered trademark of Intel Corporation.
- All other product names mentioned herein may be the trademarks or registered trademarks of their respective companies. Furthermore, “TM” and “®” are not mentioned in each case in this manual.

# Connecting your camcorder to your computer using the USB cable (For Windows users)

## Installing the USB driver

Start the following operation without connecting the USB cable to your computer.  
Connect the USB cable according to “Making the computer recognize your camcorder”.

If you are using Windows 2000 Professional, log in with permission of administrators.  
If you are using Windows XP, log in with permission of computer administrators.

- (1) Turn on your computer and allow Windows to load.
- (2) Insert the supplied CD-ROM in the CD-ROM drive of your computer. The application software starts up and the title screen appears.
- (3) Move the cursor to “USB Driver” and click. This starts USB driver installation.



- (4) Follow the on-screen messages to install the USB driver.
- (5) Remove the CD-ROM and then restart the computer, in accordance with the instructions on the screen.

### Notes

- If you connect the USB cable before USB driver installation is complete, the USB driver will not be properly registered. Carry out installation again in accordance with the steps on page 161.
- The title screen is not displayed if the screen size of your computer is set to less than 800 × 600 dots and 256 colors or less. See page 153 about the recommended computer environment.

# Connecting your camcorder to your computer using the USB cable (For Windows users)

## Installing Image Transfer

This function enables image data recorded on a “Memory Stick” to be automatically transferred (copied) to your computer.

If you are using Windows 2000 Professional, log in with permission of administrators. If you are using Windows XP, log in with permission of computer administrators.

- (1) Turn on your computer and allow Windows to load.
- (2) Insert the supplied CD-ROM in the CD-ROM drive of your computer. The application software starts up and the title screen appears.
- (3) Move the cursor to “Image Transfer” and click. This starts Image Transfer installation.



- (4) Follow the on-screen messages to install Image Transfer.

### Installing PIXELA ImageMixer

Make sure USB driver installation is complete.

You need to install PIXELA ImageMixer to view images on your computer. Install it from the CD-ROM supplied with your camcorder.



To install and use this software in Windows 2000 Professional, you must be authorized as Power Users or administrators. For Windows XP, you must be authorized as administrators.

- (1) Turn on your computer and allow Windows to load.
- (2) Insert the supplied CD-ROM into the CD-ROM drive of your computer.  
The application software starts up and the title screen appears. If the title screen does not appear, double-click "My Computer" and then "ImageMixer" (CD-ROM Drive). The application software screen appears after a while.
- (3) Move the cursor to "PIXELA ImageMixer" and click.  
The Install Wizard program starts up and the "Select Settings Language" screen appears.
- (4) Select the language for installation.
- (5) Follow the on-screen messages.  
The installation screen disappears when installation is complete.
- (6) If DirectX 8.0a or later is not installed on your computer, continue installation after installing ImageMixer.  
Follow the on-screen messages to install DirectX 8.0a. After installation is complete, restart your computer.

## Connecting your camcorder to your computer using the USB cable (For Windows users)

### Making the computer recognize your camcorder

#### Viewing images recorded on a tape

- (1) Connect the AC power adaptor to your camcorder. Set the POWER switch to VCR.
- (2) Select USB STREAM in  to ON in the menu settings (p. 184).
- (3) With the CD-ROM inserted, connect the  (USB) jack on your camcorder to the USB connector on your computer using the supplied USB cable. Your computer recognizes your camcorder, and the Windows Add Hardware Wizard starts.

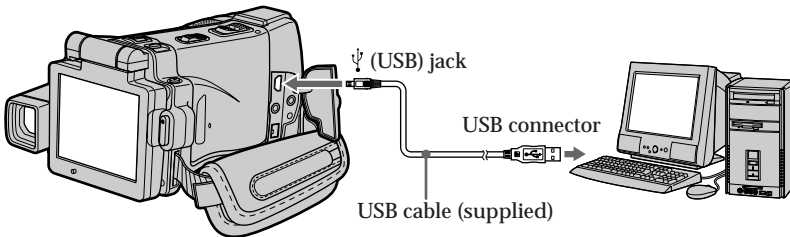

- (4) Follow the on-screen messages so that the Add Hardware Wizard recognizes that the USB drivers have been installed. The Add Hardware Wizard starts three times because three different USB drivers are installed. Be sure to allow the installation to complete without interrupting it.

For Windows 2000 Professional, Windows XP users:

- (5) After the "Files Needed" screen appears. Open "Browse..." → "My Computer" → "ImageMixer" → "Sonyhcb.sys", and click "OK."

## Connecting your camcorder to your computer using the USB cable (For Windows users)

---

### Viewing images recorded on a “Memory Stick”

- (1) Insert a “Memory Stick” into your camcorder.
- (2) Connect the AC power adaptor and set the POWER switch to MEMORY.
- (3) Connect the  $\Psi$  (USB) jack on your camcorder to the USB connector on your computer using the supplied USB cable.

USB MODE appears on the LCD screen of your camcorder. Your computer recognizes your camcorder, and the Add Hardware Wizard starts.

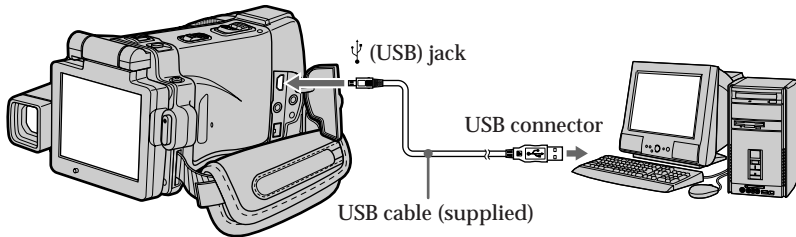

- (4) Follow the on-screen messages so that the Add Hardware Wizard recognizes that the USB drivers have been installed. The Add Hardware Wizard starts two times because two different USB drivers are installed. Be sure to allow the installation to complete without interrupting it.

---

**You cannot install the USB driver if a “Memory Stick” is not in your camcorder**  
Be sure to insert a “Memory Stick” into your camcorder before installing the USB driver.



# Connecting your camcorder to your computer using the USB cable (For Windows users)

## If you cannot install the USB driver

The USB driver has been registered incorrectly as your computer was connected to your camcorder before installation of the USB driver was completed. Perform the following procedure to correctly install the USB driver.

### Viewing images recorded on a tape

#### Step 1: Uninstall the incorrect USB driver

- ① Turn on your computer and allow Windows to load.
- ② Connect the AC power adaptor, and set the POWER switch to VCR.
- ③ Connect the USB connector on your computer to the  $\psi$  (USB) jack on your camcorder using the USB cable supplied with your camcorder.
- ④ Open your computer's "Device Manager".

#### Windows XP:

Select "Start" → "Control Panel" → "System" → "Hardware", and click the "Device Manager" button.

If there is no "System" inside "Pick a category" after clicking "Control Panel", click "Switch to classic view" instead.

#### Windows 2000 Professional:

Select "My Computer" → "Control Panel" → "System" → "Hardware" tab, and click the "Device Manager" button.

#### Windows 98SE/Windows Me:

Select "My Computer" → "Control Panel" → "System", and click "Device Manager".

- ⑤ Select and delete the underlined devices below.

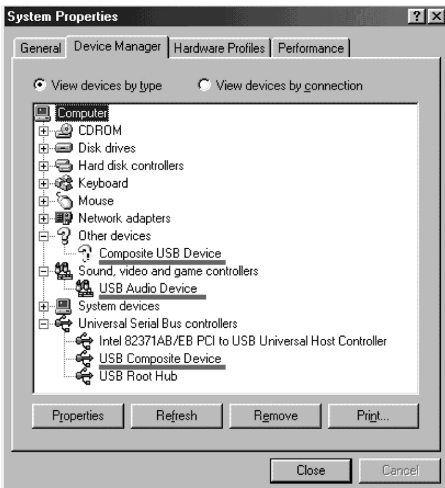

Windows 98SE

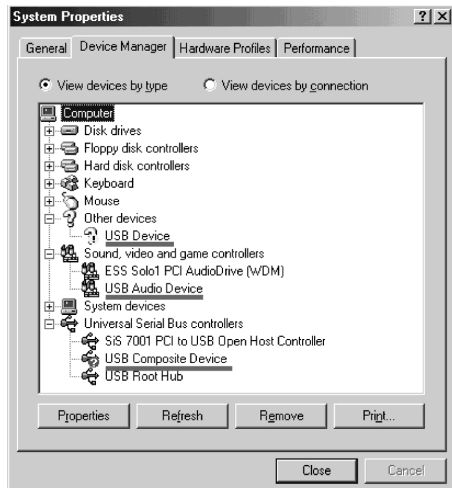

Windows Me

# Connecting your camcorder to your computer using the USB cable (For Windows users)

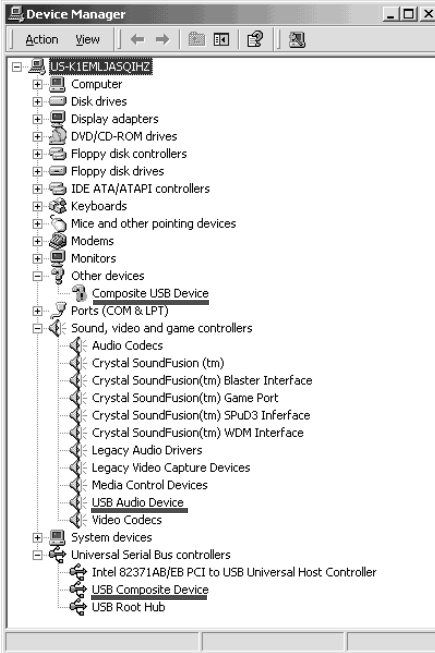

Windows 2000 Professional

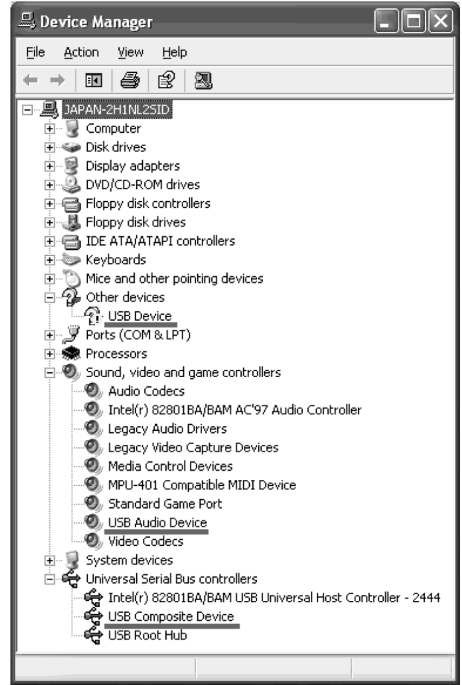

Windows XP

- ⑥ Turn the POWER switch to (CHG) OFF on your camcorder, and then disconnect the USB cable.
- ⑦ Restart your computer.

## Step 2: Install the USB driver on the supplied CD-ROM

Perform the entire procedure described in "Installing the USB driver" on page 156.

### Viewing images recorded on a “Memory Stick”

#### Step1: Uninstall the incorrect USB driver

- ① Turn on your computer and allow Windows to load.
- ② Insert a “Memory Stick” into your camcorder.
- ③ Connect the AC power adaptor, and set the POWER switch to MEMORY.
- ④ Connect the USB connector on your computer to the  $\Psi$  (USB) jack on your camcorder using the USB cable supplied with your camcorder.
- ⑤ Open your computer’s “Device Manager”.

#### Windows 2000 Professional:

Select “My Computer” → “Control Panel” → “System” → “Hardware”, and click the “Device Manager” button.

#### Other OS:

Select “My Computer” → “Control Panel” → “System”, and click “Device Manager”.

- ⑥ Select “Other devices”.  
Select the device prefixed with the “?” mark and delete.  
Ex: (?)Sony Handycam
- ⑦ Turn the POWER switch to (CHG) OFF on your camcorder, and then disconnect the USB cable.
- ⑧ Restart your computer.

#### Step2: Install the USB driver on the supplied CD-ROM

Perform the entire procedure described in “Installing the USB driver” on page 156.



# Viewing images recorded on a tape on your computer

## - USB Streaming (For Windows users)

### Capturing images with “PIXELA ImageMixer Ver.1.0 for Sony”

You need to install the USB driver and PIXELA ImageMixer to view images recorded on a tape on your computer (p. 156, 158).

#### Viewing images recorded on a tape

- (1) Turn on your computer and allow Windows to load.
- (2) Connect the AC power adaptor, and insert a cassette into your camcorder.
- (3) Set the POWER switch to VCR on your camcorder.  
Select USB STREAM in  to ON in the menu settings (p. 184).
- (4) Select “Start” → “Programs” → “PIXELA” → “ImageMixer” → “PIXELA ImageMixer Ver.1.0 for Sony”.  
The “PIXELA ImageMixer Ver.1.0 for Sony” startup screen appears on your computer.  
The title screen appears.
- (5) Click  on the screen.



## Viewing images recorded on a tape on your computer - USB Streaming (For Windows users)

- (6) Click .

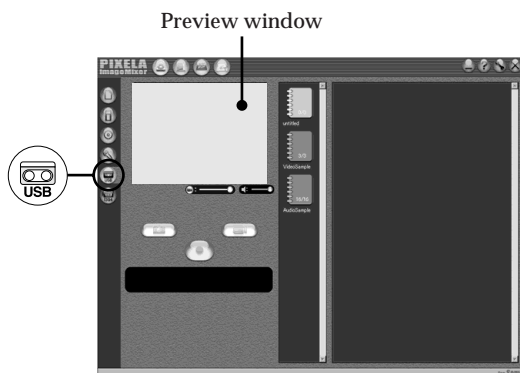

- (7) Connect the  $\Psi$  (USB) jack on your camcorder to the USB connector on your computer using the supplied USB cable.

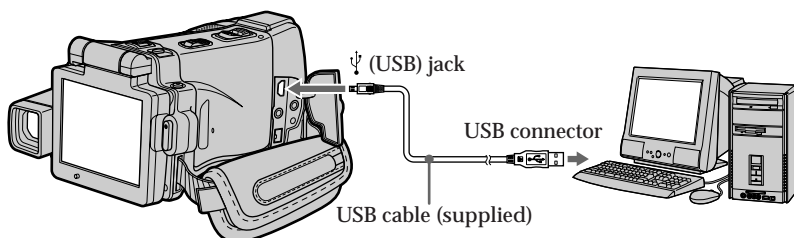

- (8) Press  on the LCD screen to start playback.  
The picture from the tape appears on preview window on your computer.



### Viewing pictures live from your camcorder

- (1) Follow the steps 1, 2 on page 164.
- (2) Set the POWER switch to CAMERA.  
Select USB STREAM in  to ON in the menu settings (p. 184).
- (3) Follow the steps 4 to 7 on pages 164, 165.  
The picture from your camcorder appears on the preview window on your computer.

# Viewing images recorded on a tape on your computer - USB Streaming (For Windows users)

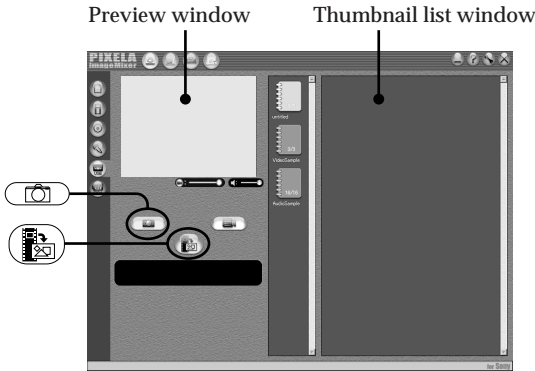



## Capturing still images

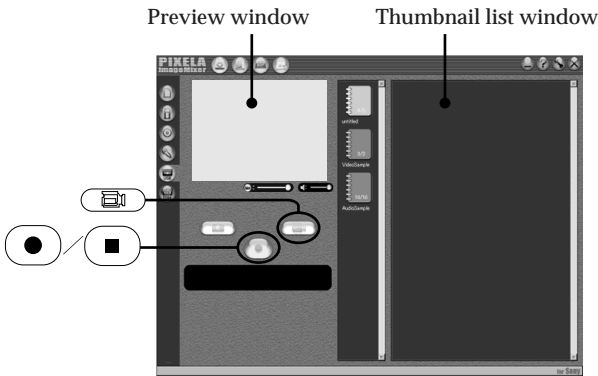

- (1) Click  .
- (2) Looking at the preview window, move the cursor to  and click it at the point you want to capture.  
The still image on the screen is captured.  
Captured images are displayed in the thumbnail list window.

## Capturing moving pictures



- (1) Click  .
- (2) Looking at the preview window, click  at the first scene of the movie you want to capture.  changes to  .
- (3) Looking at the preview window, click  at the last scene you want to capture.  
The moving picture is captured. The captured images appear in the thumbnail list window.

## Viewing images recorded on a tape on your computer - USB Streaming (For Windows users)

---

### Notes

- When you view images on your computer with the USB connection, the following may occur. This is not a malfunction.
  - The image shakes up and down.
  - Some images are not displayed correctly due to noise, etc.
  - Images of different color systems to that of your camcorder are not displayed correctly.
- When your camcorder is in the standby mode with a cassette inserted, it turns off automatically after five minutes.
- We recommend setting DEMO MODE to OFF in the menu settings when your camcorder is in the standby mode, and no cassette is inserted.
- Indicators in your camcorder LCD screen do not appear on images that are captured into your computer.
- If you capture a fast moving picture, the preview window may not move smoothly. You can make the picture move more smoothly by shifting the slider on the bottom of the preview window to the left, although this reduces the picture quality.

### If image data cannot be transferred by the USB connection

The USB driver has been registered incorrectly as your computer was connected to your camcorder before installation of the USB driver was completed. Reinstall the USB driver following the procedure on page 161.

### If any trouble occurs

Close all running applications, then restart your computer.

### Carry out the following operations after quitting the application:

- Disconnect the USB cable.
- Change the POWER switch to the other position or set the POWER switch to (CHG) OFF on your camcorder.

### When operating the following functions, they do not function for the image to be output, or the image cannot be output

- Super NightShot
- Color Slow Shutter
- Digital effect
- PB ZOOM
- MEMORY MIX

## Viewing images recorded on a tape on your computer - USB Streaming (For Windows users)

---

### Seeing the on-line help (operating instructions) of “PIXELA ImageMixer Ver.1.0 for Sony”

A “PIXELA ImageMixer Ver.1.0 for Sony” on-line help site is available where you can find the detailed operating method of “PIXELA ImageMixer Ver.1.0 for Sony”.

- (1) Click  located in the upper-right corner of the screen.  
The ImageMixer’s Manual screen appears.
- (2) You can find the information you need from the list of contents.

#### To close on-line help

Click  at the top right of the screen.

If you have any questions about “PIXELA ImageMixer Ver.1.0 for Sony”  
“ImageMixer Ver.1.0 for Sony” is a trademark of PIXELA corporation. For more information, refer to the operating instructions of the CD-ROM supplied with your camcorder.

### Note on using your computer

#### Communications with your computer

Communications between your camcorder and your computer may not recover after recovering from Suspend, Resume, or Sleep.



# Viewing images recorded on a “Memory Stick” on your computer (For Windows users)

The image data recorded on a “Memory Stick” is automatically transferred (copied) to your computer with Image Transfer. You can view images with PIXELA ImageMixer.

- (1) Turn on your computer and allow Windows to load.
- (2) Insert a “Memory Stick” into your camcorder, and connect the AC power adaptor to you camcorder.
- (3) Set the POWER switch to MEMORY.
- (4) Connect the  $\Psi$  (USB) jack on your camcorder to the USB connector on your computer using the supplied USB cable.
- (5) Image Transfer automatically starts up and the transfer of image data begins.

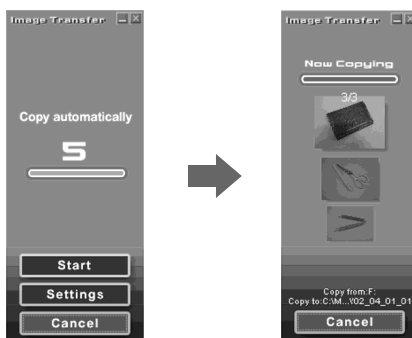

- (6) ImageMixer automatically starts up, enabling you to view the copied image.

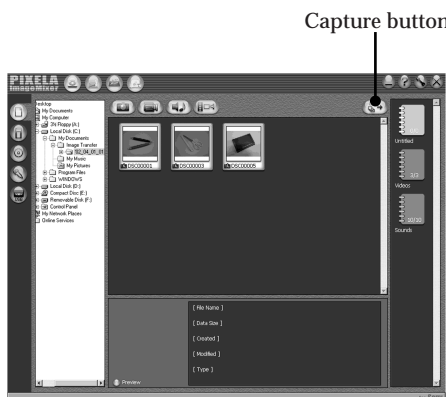

- (7) Select an album and the image, then press the capture button. The image is added in your album, and you can edit the image.

# Viewing images recorded on a “Memory Stick” on your computer (For Windows users)

## Viewing images without Image Transfer

### Before operation

An application such as Windows Media Player must be installed to play back moving pictures in Windows environment.

- (1) Turn on your computer and allow Windows to load.
- (2) Insert a “Memory Stick” into your camcorder, and connect the AC power adaptor to your camcorder.
- (3) Set the POWER switch to MEMORY.
- (4) Connect the  $\Psi$  (USB) jack on your camcorder to the USB connector on your computer using the supplied USB cable.  
USB MODE appears on the LCD screen of your camcorder.

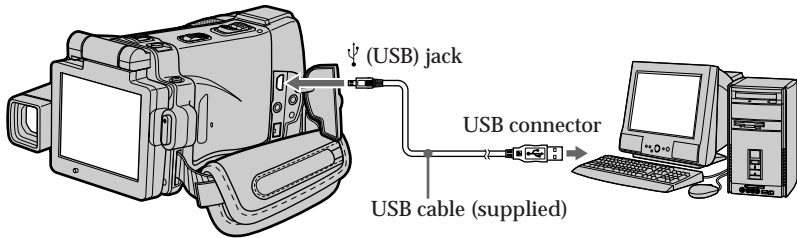

- (5) Open “My Computer” on Windows and double-click the newly recognized drive (Example: “Removable Disk (E:)”).  
The folders inside the “Memory Stick” are displayed.
- (6) Select and double-click the desired image file from the folder.  
For the detailed folder and file name, see “Image file storage destinations and image files.”

Desired file type	Double-click in this order
Still image/Moving picture*	“DCIM” folder → “100MSDCF” folder → Image file

\* Copying a file to the hard disk of your computer before viewing it is recommended. If you play back the file directly from the “Memory Stick,” the image and sound may break off.

# Viewing images recorded on a “Memory Stick” on your computer (For Windows users)

## Image file storage destinations and image files

Image files recorded with your camcorder are grouped in folders by recording mode. The meanings of the file names are as follows. □□□□ stands for any number within the range from 0001 to 9999.

### For Windows Me users (The drive recognizing your camcorder is [E:].)

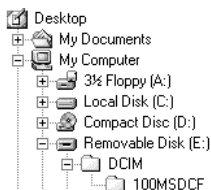

Folder containing still image and moving picture data

Folder	File	Meaning
100MSDCF	DSC0□□□□.JPG	Still image file
	MOV1□□□□.MPG	Moving picture file

## Disconnect the USB cable and remove the “Memory Stick” or set the POWER switch to (CHG) OFF

– For Windows 2000 Professional, Windows Me, Windows XP users

- (1) Move the cursor to the “Unplug or Eject Hardware” icon on the Task Tray and click to cancel the applicable drive.
- (2) After the “Safe to remove” message appears, disconnect the USB cable and remove the “Memory Stick” or set the POWER switch to (CHG) OFF.

# Connecting your camcorder to your computer using the USB cable (For Macintosh users)

---

## When connecting to a computer via the USB jack

You must install a USB driver onto your computer in order to connect your camcorder to the computer's USB connector. The USB driver can be found on the CD-ROM supplied, along with the application software required for viewing images.

## Recommended Macintosh environment

Mac OS 8.5.1/8.6/9.0/9.1/9.2 or Mac OS X (v10.0/v10.1) standard installation is required.

However, note that the update to Mac OS 9.0/9.1 should be used for the following models.

- iMac with the Mac OS 8.6 standard installation and a slot loading type CD-ROM drive
- iBook or Power Mac G4 with the Mac OS 8.6 standard installation

The USB connector must be provided as standard.

QuickTime 3.0 or newer must be installed (to play back moving pictures).

---

### Notes

- Operations are not guaranteed for the Macintosh environment if you connect two or more USB equipment to a single computer at the same time, or when using a hub.
- Some equipment may not operate depending on the type of USB equipment that is used simultaneously.
- Operations are not guaranteed for all the recommended computer environments mentioned above.
- Macintosh and Mac OS, QuickTime are trademarks of Apple Computer Inc.
- All other product names mentioned herein may be the trademarks or registered trademarks of their respective companies. Furthermore, "TM" and "®" are not mentioned in each case in this manual.

# Connecting your camcorder to your computer using the USB cable (For Macintosh users)

## Installing the USB driver

Do not connect the USB cable to your computer before installation of the USB driver is completed.

For Mac OS 8.5.1/8.6/9.0 users

- (1) Turn on your computer and allow the Mac OS to load.
- (2) Insert the supplied CD-ROM in the CD-ROM drive of your computer.  
The application software screen appears.



- (3) Click the “USB Driver” to open the folder containing the six files related to “Driver.”

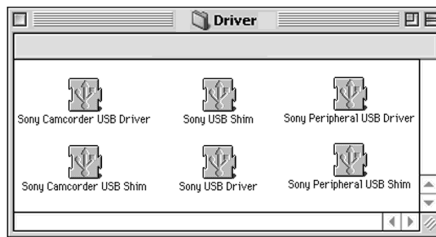

- (4) Select the following two files, and drag and drop them into the System Folder.
  - Sony Camcorder USB Driver
  - Sony Camcorder USB Shim
- (5) When the message appears, click “OK.”  
The USB driver is installed on your computer.
- (6) Remove the CD-ROM from the computer.
- (7) Restart your computer.

For Mac OS 9.1/9.2/Mac OS X (v10.0/v10.1)

The USB driver need not be installed. Your camcorder is automatically recognized as a drive just by connecting your Mac using the USB cable.

# Viewing images recorded on a “Memory Stick” on your computer (For Macintosh users)

## Viewing images

### Before operation

You need to install the USB driver to view the “Memory Stick” images on your computer (p. 156).

QuickTime 3.0 or newer must be installed to play back moving pictures.

- (1) Turn on your computer and allow Mac OS to load.
- (2) Insert a “Memory Stick” into your camcorder, and connect the AC power adaptor to your camcorder.
- (3) Set the POWER switch to MEMORY.
- (4) Connect the  $\Psi$  (USB) jack on your camcorder to the USB connector on your computer using the supplied USB cable.  
USB MODE appears on the LCD screen of your camcorder.
- (5) Double-click the “Memory Stick” icon on the desktop.  
The folders inside the “Memory Stick” are displayed.
- (6) Select and double-click the desired image file from the folder.

Desired file type	Double-click in this order
Still image/Moving picture*	“DCIM” folder → “100MSDCF” folder → Image file

\* Copying a file to the hard disk of your computer before viewing it is recommended. If you play back the file directly from the “Memory Stick,” the image and sound may break off.

## Disconnect the USB cable and remove the “Memory Stick” or set the POWER switch to (CHG) OFF

- (1) Close all running applications.  
Make sure that the “Memory Stick” access lamp of your camcorder is not lit.
- (2) Drag the “Memory Stick” icon into the “Trash”. Alternatively, select the “Memory Stick” icon by clicking on it, and then select “Eject disk” from the “Special” menu at the top left of the screen.
- (3) Disconnect the USB cable and remove the “Memory Stick” or set the POWER switch to (CHG) OFF.

### For Mac OS X (v10.0) users

Shut down your computer, then disconnect the USB cable and remove the “Memory Stick” or set the POWER switch to (CHG) OFF.

# Accessing the network

## – DCR-IP220 only

You can access the Internet using a Bluetooth equipped device that is complied to your camcorder. Once the access is made, you can view a Web page, send/receive your e-mail, etc. This section describes only how to open the Network Menu.

(1) Set the POWER switch to MEMORY/NETWORK.

(2) Press NETWORK.

Network Menu appears.

For the details, refer to the Network Function Operating Instructions supplied with your camcorder.

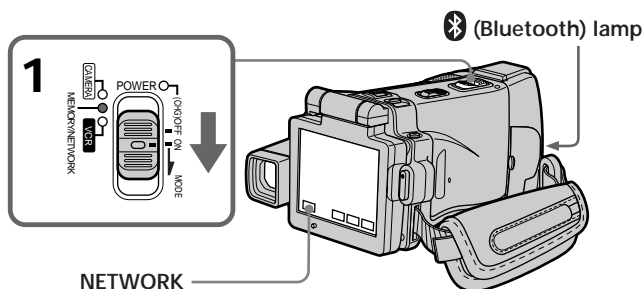

### On trademarks

- The Bluetooth trademarks are owned by their proprietor and used by Sony Corporation under license.
- All other product names mentioned herein may be the trademarks or registered trademarks of their respective companies. Furthermore, “TM” and “®” are not mentioned in each case in this manual.

### About (Bluetooth) lamp

The blue lamp lights up when your camcorder is exchanging data with a device which has Bluetooth function.

### Notes

- Make sure that your camcorder is in the standby mode with the POWER switch set to MEMORY/NETWORK.
- Do not remove the power source while operating the network functions or your NETWORK mode settings may be erased. Also, close NETWORK mode before you turn the POWER switch to (CHG) OFF or change the mode.

## Accessing the network

---

### How to hold your camcorder when operating in NETWORK mode

When operating the network functions, put your camcorder in a stable place and adjust the LCD panel to the best viewing angle.

The operation buttons needed in NETWORK mode are displayed on the LCD screen. Press the buttons with the supplied stylus.

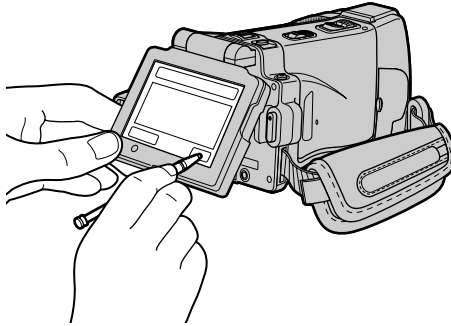

### After using the stylus

Put it back in the holder on the grip belt. Insert it until it clicks as shown below.

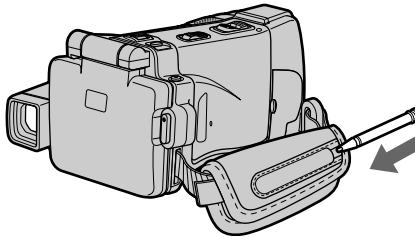

---

### Note

While operating the network functions

- Press the buttons lightly with your finger or the supplied stylus supporting the back of the LCD panel.
- Do not cover the part shown in the illustration or radio waves may be blocked.

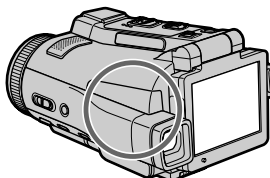



# Changing the menu settings

To change the mode settings in the menu settings, press ↓/↑ to select the menu items. The default settings can be partially changed. First, select the icon, then the menu item and the mode.

- (1) Set the POWER switch to CAMERA, MEMORY/NETWORK (DCR-IP220 only), MEMORY (DCR-IP210 only) or VCR.
- (2) Press FN to display PAGE1.
- (3) Press MENU to display the menu.
- (4) Press ↓/↑ to select a desired icon, then press EXEC.
- (5) Press ↓/↑ to select a desired item, then press EXEC.
- (6) Press ↓/↑ to select a desired setting, then press EXEC.
- (7) Repeat steps from 4 to 6 if you want to change other items. Press ↵ RET. to return to step 4.

For details, see “Selecting the mode setting of each item” (p. 178).

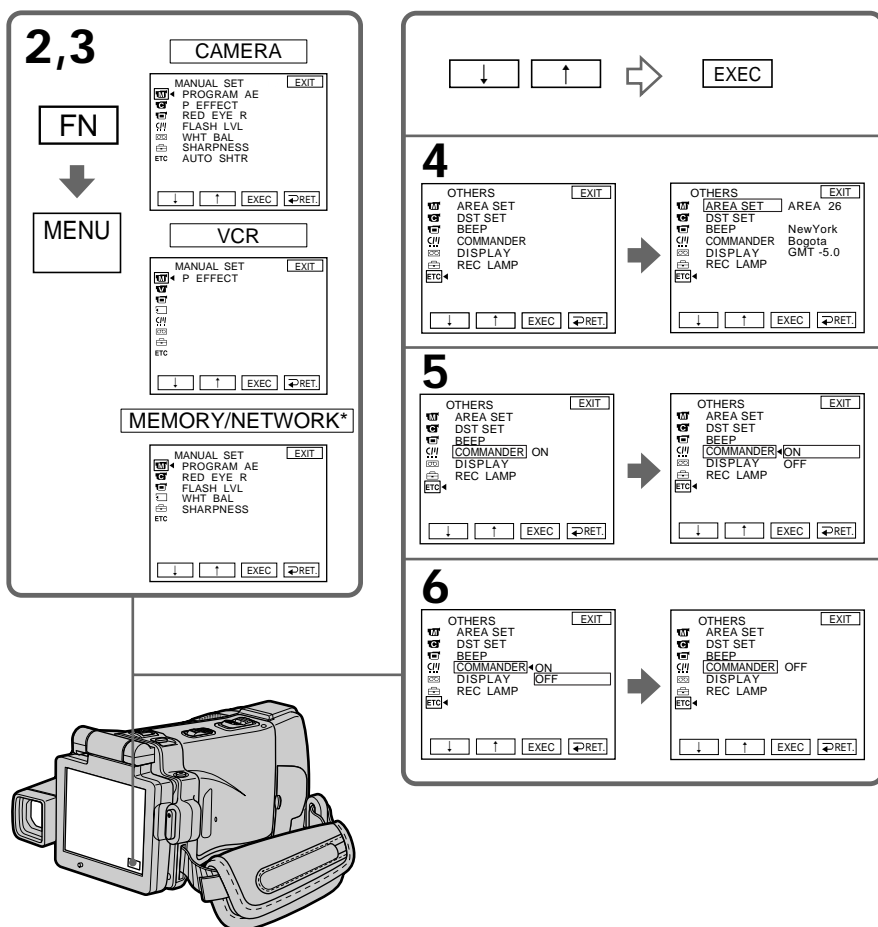









\* Only the DCR-IP220 has NETWORK mode.

## Changing the menu settings

### To return to FN

Press EXIT.

Menu items are displayed as the following icons:

-  MANUAL SET
-  CAMERA SET
-  VCR SET
-  LCD/VF SET
-  MEMORY SET
-  CM SET
-  TAPE SET
-  SETUP MENU
-  OTHERS

### Selecting the mode setting of each item ● is the default setting.

Menu items differ depending on the position of the POWER switch.  
The LCD screen shows only the items you can operate at the moment.

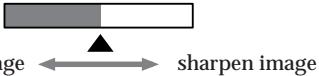
Icon/item	Mode	Meaning	POWER switch
 MANUAL SET			
PROGRAM AE	---	To suit your specific shooting requirement (p. 62)	CAMERA MEMORY
P EFFECT	---	To add special effects like those in films or on the TV to images (p. 58, 70)	CAMERA VCR
RED EYE R	● OFF	Red-eye reduction does not function.	CAMERA MEMORY
	ON	Preliminary flash before recording prevents red-eye.	
FLASH LVL	HIGH	To make the flash level higher than normal.	CAMERA MEMORY
	● NORMAL	To use the normal setting.	
	LOW	To make the flash level lower than normal.	
WHT BAL	---	To adjust the white balance (p. 52)	CAMERA MEMORY
SHARPNESS	---	To adjust the sharpness of the image outline with ↑/↓.	CAMERA MEMORY
			
AUTO SHTR	● ON	To automatically activate the electronic shutter when shooting in bright conditions	CAMERA
	OFF	To not automatically activate the electronic shutter even when shooting in bright conditions	

#### FLASH LVL

You cannot adjust FLASH LVL if the external flash (optional) is not compatible with the flash level.

## Changing the menu settings

Icon/item	Mode	Meaning	POWER switch
 CAMERA SET			
D ZOOM	● OFF	To deactivate the digital zoom. Up to 10× zoom is carried out.	CAMERA
	20×	To activate the digital zoom. More than 10× to 20× zoom is performed digitally (p. 33).	
	120×	To activate the digital zoom. More than 10× to 120× zoom is performed digitally (p. 33).	
EXPANDED F	● OFF	Not to activate the expanded focus	MEMORY
	ON	While focusing manually, the center of the screen is displayed at twice the size.	
16:9WIDE	● OFF	Not to record a 16:9 wide picture	CAMERA
	ON	To record a 16:9 wide picture (p. 54)	
STEADYSHOT	● ON	To compensate for camera-shake	CAMERA
	OFF	To cancel the SteadyShot. Natural pictures are produced when shooting a stationary subject with a tripod.	
HOLOGRAM F	● AUTO	The HOLOGRAM AF emits when focusing on subjects is difficult in dark places (p. 117).	MEMORY
	OFF	The HOLOGRAM AF does not emit.	
N.S. LIGHT	● ON	To use the NightShot Light function (p. 38)	CAMERA MEMORY
	OFF	To cancel the NightShot Light function	

### Notes on the SteadyShot

- The SteadyShot may not correct excessive camera-shake. Even if STEADYSHOT is set to ON.
- Attachment of a conversion lens (optional) may influence the SteadyShot.

### If you cancel the SteadyShot

The SteadyShot off indicator  appears. Your camcorder prevents excessive compensation for camera-shake.

(continued on the following page)

## Changing the menu settings

Icon/item	Mode	Meaning	POWER switch
<b>VCR SET</b>			
VIDEINPUT	<input checked="" type="radio"/> VIDEO	To use the video plug of the A/V connecting cable when recording from a player	VCR
	<input type="radio"/> S VIDEO	To use the S video plug of the A/V connecting cable when recording from a player	
<b>LCD/VF SET</b>			
LCD B.L.	<input checked="" type="radio"/> BRT NORMAL	To set the brightness on the LCD screen normal	CAMERA MEMORY VCR
	<input type="radio"/> BRIGHT	To brighten the LCD screen	
LCD COLOR	---	To adjust the color on the LCD screen with -/+ <div style="text-align: center;">  </div> <p style="text-align: center;">low intensity ← → high intensity</p>	CAMERA MEMORY VCR
VF B.L.	<input checked="" type="radio"/> BRT NORMAL	To set the brightness on the viewfinder screen to normal	CAMERA MEMORY VCR
	<input type="radio"/> BRIGHT	To brighten the viewfinder screen	



### LCD B.L. and VF B.L.

- When you select BRIGHT, battery life is reduced by about 10 percent during recording.
- When you use power supplies other than the battery pack, BRIGHT is automatically selected.

Even if you adjust LCD B.L., LCD COLOR and/or VF B.L.

The recorded picture will not be affected.

## Changing the menu settings

Icon/item	Mode	Meaning	POWER switch
 MEMORY SET			
STILL SET			
BURST	● OFF	Not to record continuously	MEMORY
	NORMAL	To record from four to 25 images continuously (p. 113)	
	HIGH SPEED	To record up to 32 images continuously fast	
	EXP BRKTG	To record three images continuously with different exposure	
	MULTI SCRN	To record nine images continuously	
QUALITY	● SUPER FINE	To record still images in the finest image quality mode (p. 105)	MEMORY VCR
	FINE	To record still images in the fine image quality mode	
	STANDARD	To record still images in the standard image quality mode	
IMAGESIZE	● 1600 × 1200	To record still images at 1600 × 1200 size (p. 109)	MEMORY
	640 × 480	To record still images at 640 × 480 size	
MOVIE SET			
MOVIEMODE	● SUPER FINE	To record moving pictures with super fine image quality (p. 107)	MEMORY VCR
	FINE	To record moving pictures with fine image quality	
	STANDARD	To record moving pictures with standard image quality	
	LIGHTMODE	To record moving pictures to be used as an e-mail attachment	
 REMAIN	● AUTO	To display the remaining capacity of the "Memory Stick" in the following cases: <ul style="list-style-type: none"> <li>• For five seconds after inserting a "Memory Stick" into your camcorder</li> <li>• When the capacity of the "Memory Stick" is less than one minute after the POWER switch is set to MEMORY</li> <li>• For five seconds after completing recording</li> </ul>	MEMORY VCR
	ON	To always display the remaining capacity of the "Memory Stick"	

### If you select QUALITY

The number of images you can shoot in the currently selected image quality appears on the LCD screen.

(continued on the following page)

## Changing the menu settings

Icon/item	Mode	Meaning	POWER switch
 MEMORY SET			
SLIDE SHOW	---	To play back images in a continuous loop (p. 145)	MEMORY
FILE NO.	● SERIES	To assign numbers to file in sequence even if the "Memory Stick" is changed	MEMORY VCR
	RESET	To reset the file numbering each time the "Memory Stick" is changed	
DELETE ALL	---	To delete all the unprotected images (p. 149)	MEMORY
FORMAT	● RETURN	To cancel formatting	MEMORY
	OK	To format an inserted "Memory Stick" Formatting erases all information on the "Memory Stick" 1. Press ↓/↑ to select FORMAT then press EXEC. 2. Press ↓/↑ to select OK, then press EXEC. 3. After "EXECUTE" appears, press EXEC. "FORMATTING" flashes during formatting. "COMPLETE" appears when formatting is finished.	

### Notes on formatting

- The "Memory Stick" supplied with your camcorder has been formatted at factory. Formatting with your camcorder is not required.
- Do not do any of the following while FORMATTING is displayed:
  - Turn the POWER switch to the other position
  - Operate buttons
  - Eject the "Memory Stick"
- You cannot format the "Memory Stick" if the write-protect tab on the "Memory Stick" is set to LOCK.
- Format the "Memory Stick" with your camcorder if "FORMAT ERROR" appears.
- The original sample images recorded on the supplied "Memory Stick" will be erased.
- Formatting erases protected image data on the "Memory Stick."

## Changing the menu settings

Icon/item	Mode	Meaning	POWER switch
<b>CM SET</b>			
TITLEERASE	---	To erase the title you have superimposed (p. 93)	CAMERA VCR
TITLE DSPL	● ON	To display the title you have superimposed	VCR
	OFF	Not to display the title	
TAPE TITLE	---	To label a cassette (p. 98)	CAMERA VCR
ERASE ALL	---	To erase all the data in cassette memory (p. 99)	CAMERA VCR
INFODSPL	● ON	To display the cassette information of the tape This is displayed for five seconds in the following cases (p. 97): • When inserting a cassette in CAMERA mode • When setting the POWER switch to VCR	CAMERA VCR
	OFF	To not display the cassette information of the tape.	
<b>TAPE SET</b>			
REMAIN	● AUTO	To display the remaining tape bar: • For about eight seconds after a cassette is inserted and your camcorder calculates the remaining amount of tape • For about eight seconds after the playback button  is pressed in VCR mode • For about eight seconds after DISPLAY/ TOUCH PANEL is pressed to display the screen indicators	CAMERA VCR
	ON	To always display the remaining tape indicator.	

(continued on the following page)

## Changing the menu settings

Icon/item	Mode	Meaning	POWER switch
 SETUP MENU			
CLOCK SET	---	To set the date or time (p. 22).	CAMERA MEMORY
USB STREAM	● OFF	To deactivate the USB Streaming function.	CAMERA VCR
	ON	To activate the USB Streaming function (p. 164).	
LANGUAGE	● ENGLISH	To display the following information indicators in English: min, STBY, REC, CAPTURE, VOL, END SCH and START	CAMERA MEMORY VCR
	FRANÇAIS	To display the information indicators in French	
	ESPAÑOL	To display the information indicators in Spanish	
	PORTUGUÊS	To display the information indicators in Portuguese	
	中文	To display the information indicators in Chinese	
	한국어	To display the information indicators in Korean	
DEMO MODE	● ON	To make the demonstration appear	CAMERA
	OFF	To cancel the demonstration mode	

### Notes on DEMO MODE

- You cannot select DEMO MODE when a cassette or the “Memory Stick” is inserted in your camcorder.
- When using the NightShot, the “NIGHTSHOT” indicator appears on the LCD screen and you cannot select DEMO MODE in the menu settings.
- If you press the touch panel during the demonstration, the demonstration stops for a while, then it starts again after about 10 minutes.
- DEMO MODE is set to STBY (Standby) at the default setting and the demonstration starts about 10 minutes after you have set the POWER switch to CAMERA without a cassette inserted.

To cancel the demonstration, insert a cassette, set the POWER switch to other than CAMERA, or set DEMO MODE to OFF. To set to STBY (Standby) again, leave DEMO MODE at ON in the menu settings, turn the POWER switch to (CHG) OFF, and return the POWER switch to CAMERA.



## Changing the menu settings

Icon/item	Mode	Meaning	POWER switch
<b>ETC OTHERS</b>			
DATA CODE (On the Remote Commander)	● DATE/CAM	When you press DATA CODE on the Remote Commander, the date, time and various settings are displayed during playback (p. 43).	MEMORY VCR
	DATE	The date and time are displayed during playback.	
AREA SET	---	To set your area temporarily when using your camcorder in a new location (p. 24)	CAMERA MEMORY
DST SET*	● OFF	To be used when your area is not in daylight saving time	CAMERA MEMORY
	ON	To be used when your area is in daylight saving time	
BEEP	● MELODY	To output the melody when you start/stop recording or when an unusual condition occurs on your camcorder	CAMERA MEMORY VCR
	NORMAL	To output the beep instead of the melody	
	OFF	To cancel melody and the beep sound	
COMMANDER	● ON	To activate the Remote Commander supplied with your camcorder	CAMERA MEMORY VCR
	OFF	To deactivate the Remote Commander to avoid remote control misoperation caused by other VCR's remote control	
DISPLAY	● LCD	To show the display on the LCD screen and viewfinder	CAMERA MEMORY VCR
	V-OUT/LCD	To show the display on the TV screen, LCD screen and viewfinder	
REC LAMP	● ON	To light up the camera recording lamp at the front of your camcorder	CAMERA MEMORY
	OFF	To turn the camera recording lamp off so that the subject is not aware of recording	

\* Instead of DST, SUMMERTIME is displayed on the screen for some models.

### Note

If you press DISPLAY/TOUCH PANEL with DISPLAY set to V-OUT/LCD in the menu settings, the picture from a TV or VCR will not appear on the LCD screen even when your camcorder is connected to the output jacks on the TV or VCR.

### When recording a close subject

When REC LAMP is set to ON, the red camera recording lamp on the front of your camcorder may reflect on the subject if it is close. In this case, we recommend you set REC LAMP to OFF.

### In more than five minutes after removing the power source

The PROGRAM AE, FLASH LVL, WHT BAL and COMMANDER items return to their default settings.

Other menu items are held in memory even when the battery is taken out.

# Types of trouble and how to correct trouble

If you run into any problem using your camcorder, use the following table to troubleshoot the problem. If the problem persists, disconnect the power source and contact your Sony dealer. If “C:□□:□□” appears on the LCD screen, the self-diagnosis display function has activated. See page 192.

## In the recording mode

Symptom	Cause and/or Corrective Actions
START/STOP does not operate.	<ul style="list-style-type: none"> <li>• The POWER switch is not set to CAMERA. → Set it to CAMERA (p. 29).</li> <li>• The tape has run out. → Rewind the tape or insert a new one (p. 25, 42).</li> <li>• The write-protect tab is set to expose the red mark. → Use a new cassette or slide the tab (p. 25).</li> <li>• The tape is stuck to the drum (moisture condensation). → Remove the cassette and leave your camcorder for at least one hour to acclimatize (p. 201).</li> </ul>
The power goes off.	<ul style="list-style-type: none"> <li>• When your camcorder is in the recording standby mode for more than five minutes, your camcorder automatically turns off to save battery power and to prevent battery and tape wear. → Set the POWER switch to (CHG) OFF and then to CAMERA.</li> <li>• The battery pack is dead or nearly dead. → Insert a fully charged battery pack (p. 17, 18).</li> </ul>
The image on the viewfinder screen is not clear.	<ul style="list-style-type: none"> <li>• The viewfinder lens is not adjusted correctly. → Adjust the viewfinder lens (p. 32).</li> </ul>
The SteadyShot function does not work.	<ul style="list-style-type: none"> <li>• STEADYSHOT is set to OFF in the menu settings. → Set it to ON in the menu settings (p. 179).</li> </ul>
The autofocus function does not work.	<ul style="list-style-type: none"> <li>• The setting is the manual focus mode. → Set FOCUS to AUTO (p. 67).</li> <li>• Shooting conditions are not suitable for autofocus. → Adjust to focus manually (p. 67).</li> </ul>
The picture does not appear in the viewfinder.	<ul style="list-style-type: none"> <li>• The LCD panel is open. → Close the LCD panel when you record using the viewfinder (p. 9).</li> </ul>
A vertical band appears when you shoot a subject such as lights or a candle flame against a dark background.	<ul style="list-style-type: none"> <li>• The contrast between the subject and background is too high. This is not a malfunction.</li> </ul>
A vertical band appears when you shoot a very bright subject.	<ul style="list-style-type: none"> <li>• This is not a malfunction.</li> </ul>
Some tiny white, red, blue or green spots appear on the LCD screen.	<ul style="list-style-type: none"> <li>• SLOW SHUTTER, Super NightShot or Color Slow Shutter mode is activated. This is not a malfunction.</li> </ul>

## Types of trouble and how to correct trouble

Symptom	Cause and/or Corrective Actions
An unknown picture is displayed on the LCD screen or in the viewfinder.	<ul style="list-style-type: none"> <li>• If 10 minutes elapse after you set the POWER switch to CAMERA without a cassette inserted, your camcorder automatically starts the demonstration.</li> <li>→ Insert a cassette or press the LCD screen. The demonstration stops. You can also cancel DEMO MODE (p. 184) in the menu settings.</li> </ul>
The picture is recorded in incorrect or unnatural colors.	<ul style="list-style-type: none"> <li>• The NightShot is activated.</li> <li>→ Set it off (p. 37).</li> </ul>
Picture appears too bright, and the subject does not appear on the LCD screen.	<ul style="list-style-type: none"> <li>• The NightShot is activated.</li> <li>→ Set it off (p. 37).</li> <li>• The backlight function is active.</li> <li>→ Set it off (p. 37).</li> </ul>
The click of the shutter does not sound.	<ul style="list-style-type: none"> <li>• BEEP is set to OFF in the menu settings.</li> <li>→ Set it to MELODY or NORMAL (p. 185).</li> </ul>
A black band appears when recording a TV screen or computer screen.	<ul style="list-style-type: none"> <li>• Set STEADYSHOT to OFF in the menu settings (p. 179).</li> </ul>



### In the playback mode

Symptom	Cause and/or Corrective Actions
Playback is not possible.	<ul style="list-style-type: none"> <li>• The tape has run out.</li> <li>→ Rewind the tape (p. 42).</li> </ul>
There are horizontal lines on the picture or the playback picture is not clear or does not appear.	<ul style="list-style-type: none"> <li>• The video head may be dirty.</li> <li>→ Clean the head using the cleaning cassette (optional) (p. 202).</li> </ul>
No sound or only a low sound is heard when playing back a tape.	<ul style="list-style-type: none"> <li>• Volume is turned to minimum.</li> <li>→ Turn up the volume (p. 42).</li> </ul>
The multi-picture search or date search function does not work.	<ul style="list-style-type: none"> <li>• The tape has a blank portion in the beginning of the tape or between record portion.</li> </ul>
The title search function does not work.	<ul style="list-style-type: none"> <li>• There is no title in the tape.</li> <li>→ Superimpose the titles (p. 88).</li> <li>• The tape has a blank portion in the beginning of the tape or between recorded portion.</li> </ul>
The title is not displayed.	<ul style="list-style-type: none"> <li>• TITLE DSPL is set to OFF in the menu settings.</li> <li>→ Set it to ON in the menu settings (p. 183).</li> </ul>
The playback picture freezes for about one second.	<ul style="list-style-type: none"> <li>• When playing back a transition of recordings, the playback picture freezes for about one second. This is not a malfunction.</li> </ul>

(continued on the following page)

## Types of trouble and how to correct trouble

### In the recording and playback modes

Symptom	Cause and/or Corrective Actions
The POWER switch does not turn on.	<ul style="list-style-type: none"><li>• The battery pack is not inserted, or is dead or nearly dead. → Insert a charged battery pack (p. 17, 18).</li><li>• The AC power adaptor is not connected to a wall outlet. → Connect the AC power adaptor to a wall outlet (p. 21).</li></ul>
The battery pack is quickly discharged.	<ul style="list-style-type: none"><li>• The temperature of the environment is too low.</li><li>• The battery pack is not fully charged. → Charge the battery pack fully again (p. 18).</li><li>• The battery pack is completely dead, and cannot be recharged. → Replace with a new battery pack (p. 17).</li></ul>
The battery remaining indicator does not indicate the correct time.	<ul style="list-style-type: none"><li>• You have used the battery pack in an extremely hot or cold environment for a long time.</li><li>• The battery pack is completely dead, and cannot be recharged. → Replace with a new battery pack (p. 17).</li><li>• The battery is exhausted. → Use a charged battery pack (p. 17, 18).</li><li>• A deviation has occurred in the remaining time. → Charge the battery pack fully again so that the indication on the battery remaining indicator is correct (p. 18).</li></ul>
The power goes off although the battery remaining indicator indicates that the battery pack has enough power to operate.	<ul style="list-style-type: none"><li>• A deviation has occurred in the remaining battery time. → Charge the battery pack fully again so that the indication on the battery remaining indicator is correct (p. 18).</li></ul>
The cassette cannot be removed from the holder.	<ul style="list-style-type: none"><li>• The power source is disconnected. → Connect it firmly (p. 21).</li><li>• The battery is exhausted. → Use a charged battery pack (p. 17, 18).</li></ul>
The  and  indicators flash and no functions except for cassette ejection work.	<ul style="list-style-type: none"><li>• Moisture condensation has occurred. → Remove the cassette and leave your camcorder for at least one hour to acclimatize (p. 201).</li></ul>
Remaining tape indicator is not displayed.	<ul style="list-style-type: none"><li>• The  REMAIN is set to AUTO in the menu settings. → Set it to ON to always display the remaining tape indicator (p. 183).</li></ul>

## Types of trouble and how to correct trouble

### When operating using the “Memory Stick”

Symptom	Cause and/or Corrective Actions
The “Memory Stick” does not function.	<ul style="list-style-type: none"><li>• The POWER switch is not set to MEMORY. → Set it to MEMORY (p. 111).</li><li>• The “Memory Stick” is not inserted. → Insert a “Memory Stick” (p. 102).</li></ul>
Recording does not function.	<ul style="list-style-type: none"><li>• The “Memory Stick” has already been recorded to its full capacity. → Delete unnecessary images and record again (p. 147).</li><li>• The “Memory Stick” formatted incorrectly is inserted. → Format the “Memory Stick” using your camcorder or use another “Memory Stick” (p. 182).</li><li>• The write-protect tab on the “Memory Stick” is set to LOCK. → Release the lock (p. 100).</li></ul>
The image cannot be deleted.	<ul style="list-style-type: none"><li>• The image is protected. → Cancel image protection (p. 146).</li><li>• The write-protect tab on the “Memory Stick” is set to LOCK. → Release the lock (p. 100).</li></ul>
You cannot format the “Memory Stick.”	<ul style="list-style-type: none"><li>• The write-protect tab on the “Memory Stick” is set to LOCK. → Release the lock (p. 100).</li></ul>
Deleting all the images cannot be carried out.	<ul style="list-style-type: none"><li>• The write-protect tab on the “Memory Stick” is set to LOCK. → Release the lock (p. 100).</li></ul>
You cannot protect the image.	<ul style="list-style-type: none"><li>• The write-protect tab on the “Memory Stick” is set to LOCK. → Release the lock (p. 100).</li><li>• The INDEX screen is not displayed. → Press INDEX to display the index screen then protect the image (p. 146).</li></ul>
You cannot write a print mark on the still image.	<ul style="list-style-type: none"><li>• The write-protect tab on the “Memory Stick” is set to LOCK. → Release the lock (p. 100).</li><li>• The INDEX screen is not displayed. → The print marks cannot be written to the single screen (p. 150).</li><li>• You are trying to write a print mark on a moving picture. → Print marks cannot be written to moving picture (p. 150).</li></ul>
You cannot play back images in actual size.	<ul style="list-style-type: none"><li>• You may not be able to play back images in actual size when you try to play back images recorded by other equipment. This is not a malfunction.</li></ul>
You cannot play back image data.	<ul style="list-style-type: none"><li>• Your camcorder cannot play back some images processed with your computer (The file name flashes on the LCD screen).</li><li>• Your camcorder may not be able to play back the image recorded using other camcorder.</li></ul>

(continued on the following page)

## Types of trouble and how to correct trouble

### Others

Symptom	Cause and/or Corrective Actions
A title is not recorded.	<ul style="list-style-type: none"><li>• 20 titles have been recorded. → Erase unnecessary title (p. 93).</li><li>• The cassette is set to prevent accidental erasure. → Slide the write-protect tab so that red portion is not visible (p. 25).</li><li>• The tape has a blank portion in the recorded portion. → Superimpose the title to the recorded position (p. 91).</li></ul>
A cassette label is not recorded.	<ul style="list-style-type: none"><li>• The tape is set to prevent accidental erasure. → Slide the write-protect tab so that red portion is not visible (p. 25).</li></ul>
The Remote Commander supplied with your camcorder does not work.	<ul style="list-style-type: none"><li>• COMMANDER is set to OFF in the menu settings. → Set it to ON (p. 185).</li><li>• Something is blocking the infrared rays. → Remove the obstacle.</li><li>• The batteries are inserted in the battery holder with the + - polarities incorrectly matching the + - marks. → Insert the batteries with the correct polarity (p. 217).</li><li>• The batteries are dead. → Insert new ones (p. 217).</li></ul>
The picture from a TV or VCR does not appear even when your camcorder is connected to the outputs on the TV or VCR.	<ul style="list-style-type: none"><li>• DISPLAY is set to V-OUT/LCD in the menu settings. → Set it to LCD (p. 185).</li><li>• VIDEOINPUT is not set correctly in the menu settings. → Set it to the appropriate setting (p. 180).</li></ul>
Dubbing cannot be made when using the A/V connecting cable.	<ul style="list-style-type: none"><li>• VIDEOINPUT is not set correctly in the menu settings. → Set it to the appropriate setting.</li></ul>
The melody or beep sounds for five seconds.	<ul style="list-style-type: none"><li>• Moisture condensation has occurred. → Remove the cassette and leave your camcorder for at least one hour to acclimatize (p. 201).</li><li>• Some troubles have occurred in your camcorder. → Remove the cassette and insert it again, then operate your camcorder.</li></ul>
No function works though the power is on.	<ul style="list-style-type: none"><li>• Disconnect the AC power adaptor from a wall outlet or take out the battery, then reconnect it in about one minute. Turn the power on. If the functions still do not work, press RESET using a sharp-pointed object. (If you press RESET, all the settings (DCR-IP220: except the NETWORK mode settings) including the date and time return to the default) (p. 211).</li></ul>

## Types of trouble and how to correct trouble

Symptom	Cause and/or Corrective Actions
While charging the battery pack inserted in your camcorder, the battery CHG lamp does not light up.	<ul style="list-style-type: none"> <li>• Charging is completed.</li> <li>• The battery pack is not properly inserted. → Insert it properly (p. 17).</li> </ul>
You cannot charge the battery pack inserted in your camcorder.	<ul style="list-style-type: none"> <li>• The POWER switch is not set to (CHG) OFF. → Set it to (CHG) OFF.</li> </ul>
While charging the battery pack inserted in your camcorder, the battery CHG lamp flashes.	<ul style="list-style-type: none"> <li>• The battery pack is not properly inserted. → Insert it properly (p. 17).</li> <li>• Something is wrong with the battery pack. → Please contact your Sony dealer or local authorized Sony service facility.</li> </ul>
When you set the POWER switch to VCR or (CHG) OFF, if you move your camcorder, you may hear a clattering sound from inside your camcorder.	<ul style="list-style-type: none"> <li>• This is because some functions use a linear mechanism. This is not a malfunction.</li> </ul>
The buttons do not appear on the touch panel.	<ul style="list-style-type: none"> <li>• DISPLAY/TOUCH PANEL is pressed. → Press the LCD screen lightly. → Press DISPLAY/TOUCH PANEL on your camcorder or DISPLAY on the Remote Commander (p. 43).</li> </ul>
The buttons on the LCD screen do not work.	<ul style="list-style-type: none"> <li>→ Adjust the LCD screen (CALIBRATION) (p. 204).</li> </ul>
The indicators appear mirror-reversed in the viewfinder.	<ul style="list-style-type: none"> <li>• The mirror mode is activated. This is not a malfunction (p. 35).</li> </ul>
The characters on the TV screen are reversed.	<ul style="list-style-type: none"> <li>• It occurs if you set DISPLAY to V-OUT/LCD in the menu settings when using mirror mode. This is not a malfunction.</li> </ul>
Image data cannot be transferred to your computer by the USB connection.	<ul style="list-style-type: none"> <li>• The USB cable was connected before installation of the USB driver was completed. → Uninstall the incorrect USB driver and reinstall the USB driver (p. 161).</li> <li>• USB STREAM is set to OFF in the menu settings. → Set it to ON (p. 184).</li> </ul>
A cassette cannot be removed even if the cassette lid is open.	<ul style="list-style-type: none"> <li>• Moisture condensation has started to condense in your camcorder (p. 201).</li> </ul>

# Self-diagnosis display

Your camcorder has a self-diagnosis display function.

This function displays the current condition of your camcorder as a five-digit code (a combination of a letter and figures) on the LCD screen. If a five-digit code is displayed, check the following code chart. The last two digits (indicated by □□) will differ depending on the state of your camcorder.

## LCD screen or Viewfinder

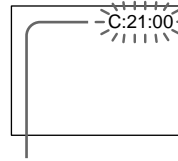

### Self-diagnosis display

- C:□□:□□  
You can service your camcorder yourself.
- E:□□:□□  
Contact your Sony dealer or local authorized Sony facility.

Five-digit display	Cause and/or Corrective Actions
C:04:□□	<ul style="list-style-type: none"> <li>• You are using a battery pack that is not an "InfoLITHIUM" battery pack. → Use an "InfoLITHIUM" battery pack (p. 196).</li> </ul>
C:21:□□	<ul style="list-style-type: none"> <li>• Moisture condensation has occurred. → Remove the cassette and leave your camcorder for at least one hour to acclimatize (p. 201).</li> </ul>
C:22:□□	<ul style="list-style-type: none"> <li>• The video heads are dirty. → Clean the heads using the cleaning cassette (optional) (p. 202).</li> </ul>
C:31:□□ C:32:□□	<ul style="list-style-type: none"> <li>• A malfunction other than the above that you can service has occurred. → Remove the cassette and insert it again, then operate your camcorder. Do not perform this operation if moisture starts to condense (p. 201). → Disconnect the power cord of the AC power adaptor or take out the battery pack. After reconnecting the power source, operate your camcorder.</li> </ul>
E:20:□□ E:61:□□ E:62:□□	<ul style="list-style-type: none"> <li>• A malfunction that you cannot service has occurred. → Contact your Sony dealer or local authorized Sony service facility and inform them of the 5-digit code. (example: E:61:10)</li> </ul>

























If you are unable to rectify the problem even if you try corrective actions a few times, contact your Sony dealer or local authorized Sony service facility.





# Warning indicators and messages

## Warning messages













- CLOCK SET Set the date and time (p. 22).
- FOR “InfoLITHIUM” BATTERY ONLY Use an “InfoLIHIUM” battery pack (p. 196).
-  CLEANING CASSETTE The video heads are dirty (p. 202). (The  indicator and “ CLEANING CASSETTE” message appear one after another on the LCD screen.)
- COPY INHIBIT You tried to record a picture that has a copyright control signal (p. 195).\*
-  FULL The “Memory Stick” is full (p. 114).\*
-  The write-protect tab on the “Memory Stick” is set to LOCK (p. 100).
-  NO FILE No image is recorded on the “Memory Stick” (p. 137).\*
-  NO MEMORY STICK No “Memory Stick” is inserted.\*
-  MEMORY STICK ERROR The “Memory Stick” data is corrupted (p. 102).\*
-  FORMAT ERROR The “Memory Stick” is not recognized (p. 182).\* Check the format.
-   DIRECTORY ERROR There is more than two same directories (p. 136).\*
-  PLAY ERROR The image is distorted and cannot be played back.\*
-  REC ERROR Check the input signal, then record again (p. 124, 135).\*
-   TAPE END The tape has reached the end of the tape.\*
-  NO TAPE Insert a cassette.\*
- DELETING You press PHOTO while deleting data in a “Memory Stick.”\*
- FORMATTING You press PHOTO while formatting a “Memory Stick.”\*
-  NOW CHARGING Charging flash does not work correctly.\*
-   CLEANING END The cleaning is complete. Eject the cleaning cassette (p. 202).
-   CLEANING TAPE END The cleaning tape has run out.
-  TITLE FULL 20 titles have been recorded (p. 90).\*
- INPUT ERROR A picture in an incompatible format (such as one recorded with the DV format) is input (p. 87).\*
-  NOT REC You tried to copy MPEG MOVIE files recorded on a “Memory Stick” to the tape (p. 142).\*
- CHANGE TO “CAM” or “VCR” A cleaning cassette cannot be used in MEMORY mode (p. 202).
-  INCOMPATIBLE MEMORY STICK The “Memory Stick” inserted is not compatible with your camcorder.\*
- READ-ONLY MEMORY STICK A read-only “Memory Stick” is inserted.\*

\* You hear the melody or beep sound.

Refer to the Network Function Operating Instructions supplied with your camcorder about warning messages in NETWORK mode.

# Usable cassettes

## Selecting cassette types

You can use  MICROMV cassette only. You cannot use any other  8 mm,  Hi8,  Digital8,  VHS,  VHS-C,  S-VHS,  S-VHS-C,  Betamax,  ED Beta,  DV, or  mini DV cassettes.

All of the MICROMV cassettes have micro Cassette Memory.

 Micro Cassette Memory, , and  MICROMV are trademarks of Sony Corporation.

## Copyright signal

### When you play back

If the tape you play back on your camcorder contains copyright signals, you cannot copy it with other equipment connected to your camcorder.

### When you record

You cannot record software on your camcorder that contains copyright control signals for copyright protection of software.

COPY INHIBIT appears on the LCD screen or on the TV screen if you try to record such software. Your camcorder does not record copyright control signals on the tape when it records.

## Notes on the MICROMV cassette

### When affixing a label on the MICROMV cassette

Be sure to affix a label only on the location illustrated below [a] so as not to cause malfunction of your camcorder.

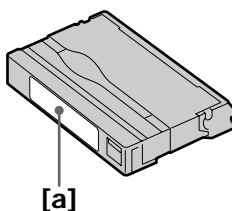

### After using the MICROMV cassette

Rewind the tape to the beginning, put the cassette in its case, and store it in an upright position.

### When the micro Cassette Memory function does not work

Reinsert the cassette.

# About the “InfoLITHIUM” battery pack

---

## What is the “InfoLITHIUM” battery pack?

The “InfoLITHIUM” battery pack is a lithium-ion battery pack that has functions for communicating information related to operating conditions between your camcorder. The “InfoLITHIUM” battery pack calculates the power consumption according to the operating conditions of your camcorder, and displays the remaining battery time in minutes.

## Charging the battery pack

- Be sure to charge the battery pack before you start using your camcorder.
- We recommend charging the battery pack in an ambient temperature of between 10°C to 30°C (50°F to 86°F) until the battery CHG lamp goes off, indicating that the battery pack is fully charged. If you charge the battery outside of this temperature range, you may not be able to efficiently charge the battery pack.
- After charging is completed, either disconnect the cable from the DC IN jack on your camcorder or take out the battery pack.

## Effective use of the battery pack

- Battery pack performance decreases in low-temperature surroundings. So, the time that the battery pack can be used is shorter. We recommend that you put the battery pack in your pocket to warm it up, and insert it in your camcorder immediately before you start taking photos. This enables you to use the battery pack longer.
- Frequently using the LCD panel or frequently operating playback, fast-forward or rewind wears out the battery pack faster.
- Be certain to turn the POWER switch to (CHG) OFF when not taking shots or playing back on your camcorder. The battery pack is also consumed when your camcorder is in the standby mode or playback is paused.
- Have spare battery packs handy for two or three times the expected recording time, and make trial recordings before taking the actual recording.
- Do not expose the battery pack to water. The battery pack is not water resistant.

## Remaining battery time indicator

- If the power goes off although the remaining battery time indicator indicates that the battery pack has enough power to operate, charge the battery pack fully again so that the indication on the remaining battery time indicator is correct. Note, however, that the correct battery indication sometimes will not be restored if it is used in high temperatures for a long time or left in a fully charged state, or the battery pack is frequently used. Regard the remaining battery time indication as the approximate shooting time.
- The  mark indicating little remaining battery time sometimes flashes depending on the operating conditions or ambient temperature and environment even if the remaining battery time is about five to 10 minutes.

## How to store the battery pack

- If the battery pack is not used for a long time, do the following procedure once per year to maintain proper function.
  1. Fully charge the battery.
  2. Discharge on your electronic equipment.
  3. Take out the battery from the equipment and store it in a dry, cool place.
- To use the battery pack up on your camcorder, leave your camcorder in the recording mode until the power goes off without a cassette inserted.

## About the “InfoLITHIUM” battery pack

---

### Battery life

- The battery life is limited. Battery capacity drops little by little as you use it more and more, and as time passes. When the available battery time is shortened considerably, a probable cause is that the battery pack has reached the end of its life. Please buy a new battery pack.
- The battery life varies depending on how it is stored and operating conditions and environment for each battery pack.

# About i.LINK

---

The i.LINK (MICROMV Interface) on this unit is an i.LINK-compliant MICROMV interface. This section describes the i.LINK standard and its features.

## What is i.LINK?

i.LINK is a digital serial interface for handling digital video, digital audio and other data in two directions between equipment having the i.LINK jack, and for controlling other equipment.

i.LINK-compatible equipment can be connected by a single i.LINK cable. Possible applications are operations and data transactions with various digital AV equipment. When two or more i.LINK-compatible equipment are connected to this unit in a daisy chain, operations and data transactions are possible with not only the equipment that this unit is connected to but also with other devices via the directly connected equipment.

Note, however, that the method of operation sometimes varies according to the characteristics and specifications of the equipment to be connected, and that operations and data transactions are sometimes not possible on some connected equipment.

---

### Note

Normally, only one piece of equipment can be connected to this unit by the i.LINK cable. When connecting this unit to i.LINK-compatible equipment having two or more i.LINK (MICROMV Interface), refer to the operating instructions of the equipment to be connected.

## About the name "i.LINK"

i.LINK is a more familiar term for IEEE 1394 data transport bus proposed by Sony, and is a trademark approved by many corporations.

IEEE 1394 is an international standard standardized by the Institute of Electrical and Electronics Engineers.

## i.LINK baud rate

The maximum baud rate of your camcorder is "S400".

i.LINK's maximum baud rate varies according to the equipment. Three maximum baud rates are defined:

S100 (approx. 100Mbps\*)

S200 (approx. 200Mbps)

S400 (approx. 400Mbps)

The baud rate is listed under "Specifications" in the operating instructions of each equipment. It is also indicated near the i.LINK (MICROMV Interface) on some equipment.

The maximum baud rate of equipment, except for this unit, on which it is not indicated is "S100".

When units are connected to equipment having a different maximum baud rate, the baud rate sometimes differs from the indicated baud rate.

### \*What is Mbps?

Mbps stands for megabits per second, or the amount of data that can be sent or received in one second. For example, a baud rate of 100Mbps means that 100 megabits of data can be sent in one second.

## About i.LINK

---

### i.LINK functions on this unit

For details on how to dub when this unit is connected to other video equipment having DV jacks, see page 82, 86.

This unit can also be connected to other i.LINK (MICROMV Interface) compatible equipment made by Sony (e.g. VAIO series personal computer) other than video equipment.

Before connecting this unit to your computer, make sure that application software supported by this unit is already installed on your computer.

For details on precautions when connecting this unit, also refer to the operating instructions for the equipment to be connected.

### Required i.LINK cable

Use the Sony i.LINK 4-pin-to-4-pin cable (during MPEG2 dubbing).

i.LINK and  are trademarks.

# Using your camcorder abroad

## Using your camcorder abroad

Countries and areas where you can use network functions are restricted. For details, refer to the separate Network Function Operating Instructions (DCR-IP220 only).

You can use your camcorder in any country or area with the AC power adaptor supplied with your camcorder within 100 V to 240 V AC, 50/60 Hz.

Use a commercially available AC plug adaptor **[a]**, if necessary, depending on the design of the wall outlet **[b]**.

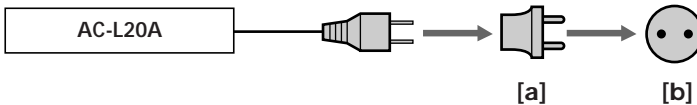

Your camcorder is an NTSC system based camcorder. If you want to view the playback picture on a TV, it must be an NTSC system based TV with VIDEO/AUDIO input jack. The following shows TV color systems used overseas.

### NTSC system

Bahama Islands, Bolivia, Canada, Central America, Chile, Colombia, Ecuador, Guyana, Jamaica, Japan, Korea, Mexico, Peru, Surinam, Taiwan, the Philippines, the U.S.A., Venezuela, etc.

### PAL system

Australia, Austria, Belgium, China, Czech Republic, Denmark, Finland, Germany, Holland, Hong Kong, Hungary, Italy, Kuwait, Malaysia, New Zealand, Norway, Poland, Portugal, Singapore, Slovak Republic, Spain, Sweden, Switzerland, Thailand, United Kingdom, etc.

### PAL-M system

Brazil

### PAL-N system

Argentina, Paraguay, Uruguay



### SECAM system

Bulgaria, France, Guiana, Iran, Iraq, Monaco, Russia, Ukraine, etc.



# Maintenance information and precautions

## Moisture condensation

If your camcorder is brought directly from a cold place to a warm place, moisture may condense inside your camcorder, on the surface of the tape, or on the lens. In this condition, the tape may stick to the head drum and be damaged or your camcorder may not operate correctly. If there is moisture inside your camcorder, the beep sounds and the  indicator flashes. When the  indicator flashes at the same time, the cassette is inserted in your camcorder. If moisture condenses on the lens, the indicator will not appear.

### If moisture condensation occurred

None of the functions except cassette ejection will work. Eject the cassette, turn off your camcorder, and leave it for about one hour with the cassette compartment open. Your camcorder can be used again if the  indicator does not appear when the power is turned on again.

If moisture starts to condense, your camcorder sometimes cannot detect condensation. If this happens, the cassette is sometimes not ejected for 10 seconds after the cassette lid is opened. This is not a malfunction. Do not close the cassette lid until the cassette is ejected.

---

### Note on moisture condensation

Moisture may condense when you bring your camcorder from a cold place into a warm place (or vice versa) or when you use your camcorder in a hot place as follows:

- You bring your camcorder from a ski slope into a place warmed up by a heating device.
- You bring your camcorder from an air-conditioned car or room into a hot place outside.
- You use your camcorder after a squall or a shower.
- You use your camcorder in a high temperature and humid place.



### How to prevent moisture condensation

When you bring your camcorder from a cold place into a warm place, put your camcorder in a plastic bag and tightly seal it. Remove the bag when the air temperature inside the plastic bag has reached the surrounding temperature (after about one hour).

### Maintenance information

#### Cleaning the video head

To ensure normal recording and clear pictures, clean the video head. The video head may be dirty when:

- Mosaic-pattern noise appears on the playback picture.
- Playback pictures do not move.
- Playback pictures do not appear.
- The  indicator and “ CLEANING CASSETTE” message appear one after another or the  indicator flashes on the LCD screen during recording.

If the above problem, [a] or [b] occurs, clean the video heads with the Sony MGRCLD cleaning cassette (optional). Check the picture and if the above problem persists, repeat cleaning.

[a]



[b]





If the video heads get dirtier, the entire screen becomes blue [b].

#### The video head

The video head wears out if you use the camcorder for a long time. When use of the cleaning cassette does not make the picture clear, the video head may have worn out. In such cases, you must replace the video head. For details, contact your Sony dealer or local authorized Sony service facility.

#### Using a cleaning cassette

- (1) Set the POWER switch to CAMERA or VCR.
- (2) Insert the cleaning cassette.
- (3) Press OK on the LCD screen. The message “NOW CLEANING” appears.  
After the cleaning is finished, the message “  CLEANING END” appears.
- (4) Eject the cleaning cassette.

#### To cancel cleaning

Press CANCEL.

---

#### Notes

- When cleaning the video head, do not use any equipment other than the cleaning cassette.
- The cleaning cassette does not work in MEMORY/NETWORK mode.

#### Cleaning the LCD screen

If fingerprints or dust make the LCD screen dirty, we recommend using a cleaning cloth (supplied) to clean the LCD screen. When you use the LCD Cleaning Kit (optional), do not apply the cleaning liquid directly to the LCD screen. Clean the LCD screen with a cleaning paper moistened with the liquid.

## Maintenance information and precautions

### Charging the built-in rechargeable battery

Your camcorder is supplied with a built-in rechargeable battery installed so as to retain the date and time, etc., regardless of the setting of the POWER switch. The built-in rechargeable battery is always charged as long as you are using your camcorder. The battery, however, will get discharged gradually if you do not use your camcorder. It will be completely discharged in **about three months** if you do not use your camcorder at all. Even if the built-in rechargeable battery is not charged, it will not affect your camcorder operation. To retain the date and time, etc., charge the battery if the battery is discharged.

#### Charging the built-in rechargeable battery

- Connect your camcorder to a wall outlet using the AC power adaptor supplied with your camcorder, and leave your camcorder with the POWER switch turned off for more than 24 hours.
- Or insert the fully charged battery pack in your camcorder, and leave your camcorder with the POWER switch turned off for more than 24 hours.

### Removing dust from inside the viewfinder

- (1) Open the LCD panel.
- (2) Remove the screw with a screwdriver (optional).
- (3) Slide the viewfinder about 1.5 mm (1/16 in.) to the left and then pull it to remove the eyecup.

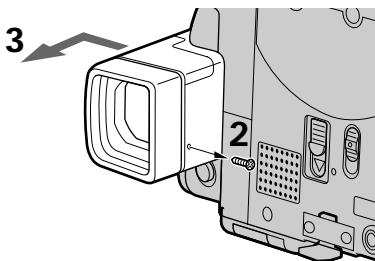

- (4) Remove dust from inside the eyecup and viewfinder with a commercially available blower.
- (5) Reverse the above steps 2 and 3 to attach the eyecup. Then replace the screw.

#### Caution

Do not remove any other screws. You may remove only the screw to remove the eyecup.

#### Notes

- Do not drop or bend the eyecup shaft.
- Be careful when handling the eyecup.

## Maintenance information and precautions

### Adjusting the LCD screen (CALIBRATION)

The buttons on the touch panel may not work correctly. If this happens, follow the procedure below.

- (1) Set the POWER switch to (CHG) OFF.
- (2) Eject the tape from your camcorder, then disconnect any connecting cable from your camcorder.
- (3) Close the LCD panel with the LCD screen facing out.

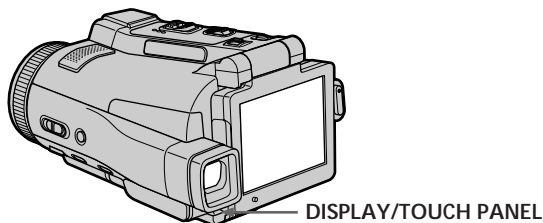

- (4) Set the POWER switch to VCR while pressing DISPLAY/TOUCH PANEL, then keep pressing DISPLAY/TOUCH PANEL for about five seconds.
- (5) Follow the procedure below with your finger or the supplied stylus (DCR-IP220 only).
  - ① Touch ✕ at the upper left corner.
  - ② Touch ✕ at the lower right corner.
  - ③ Touch ✕ in the middle of the LCD screen.

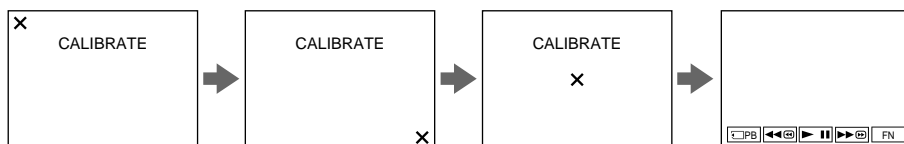

If you do not press the right spot, ✕ always returns to the position at the upper left corner.

#### Note

You can only carry out this operation with the LCD screen in the step 3 position.

### Precautions

#### Camcorder operation

- Operate your camcorder on 7.2 V (battery pack) or 8.4 V (AC power adaptor).
- For DC or AC operation, use the accessories recommended in this operating instructions.
- If any solid object or liquid get inside the casing, unplug your camcorder and have it checked by a Sony dealer before operating it any further.
- Avoid rough handling or mechanical shock. Be particularly careful of the lens.
- Keep the POWER switch set to (CHG) OFF when you are not using your camcorder.
- Do not wrap your camcorder with a towel, for example, and operate it. Doing so might cause heat to build up inside.
- Keep your camcorder away from strong magnetic fields or mechanical vibration.
- Do not touch the LCD screen with a sharp object other than the stylus supplied (DCR-IP220 only).
- If your camcorder is used in a cold place, a residual image may appear on the LCD screen. This is not a malfunction.
- While using your camcorder, the back of the LCD screen may heat up. This is not a malfunction.
- Do not use the network function in a medical institution or in an aircraft (DCR-IP220 only).

#### On handling tapes

- Do not insert anything into the small holes on the rear of the cassette. These holes are used to sense the type and thickness of the tape and if the recording tab is in or out.
- Do not open the tape protect cover or touch the tape.
- Avoid touching or damaging the terminals. To remove dust, clean the terminals with a soft cloth.

#### Camcorder care

- Remove the tape, and periodically turn on the power, operate the CAMERA and VCR sections and play back a tape for about three minutes when your camcorder is not to be used for a long time.
- Clean the lens with a soft brush to remove dust. If there are fingerprints on the lens, remove them with a soft cloth.
- Clean your camcorder body with a dry soft cloth, or a soft cloth lightly moistened with a mild detergent solution. Do not use any type of solvent which may damage the finish.
- Do not let sand get into your camcorder. When you use your camcorder on a sandy beach or in a dusty place, protect it from the sand or dust. Sand or dust may cause your camcorder to malfunction, and sometimes this malfunction cannot be repaired.

### AC power adaptor

- Unplug the unit from a wall outlet when you are not using the unit for a long time.  
To disconnect the power cord, pull it out by the plug. Never pull the power cord itself.
- Do not operate the unit with a damaged cord or if the unit has been dropped or damaged.
- Do not bend the power cord forcibly, or place a heavy object on it. This will damage the cord and may cause fire or electrical shock.
- Prevent metallic objects from coming into contact with the metal parts of the connecting section. If this happens, a short may occur and the unit may be damaged.
- Always keep metal contacts clean.
- Do not disassemble the unit.
- Do not apply mechanical shock or drop the unit.
- While the unit is in use, particularly during charging, keep it away from AM receivers and video equipment. AM receivers and video equipment disturb AM reception and video operation.
- The unit becomes warm during use. This is not a malfunction.
- Do not place the unit in locations that are:
  - Extremely hot or cold
  - Dusty or dirty
  - Very humid
  - Vibrating

### About care and storage of the lens

- Wipe the surface of the lens clean with a soft cloth in the following instance:
  - When there are fingerprints on the lens surface
  - In hot or humid locations
  - When the lens is used in environments such as the seaside
- Store the lens in a well-ventilated location subject to little dirt or dust.

To prevent mold from occurring, periodically perform the above.

We recommend turning on and operating your camcorder about once per month to keep your camcorder in an optimum state for a long time.

### Battery pack

- Use only the specified charger or video equipment with the charging function.
- To prevent an accident from a short circuit, do not allow metal objects to come into contact with the battery terminals.
- Keep the battery pack away from fire.
- Never expose the battery pack to temperatures above 60°C (140°F), such as in a car parked in the sun or under direct sunlight.
- Store the battery pack in a cool, dry place.
- Do not expose the battery pack to any mechanical shock.
- Do not disassemble nor modify the battery pack.
- Attach the battery pack to the video equipment securely.
- Charging while some capacity remains does not affect the original battery capacity.

### Notes on dry batteries

To avoid possible damage from battery leakage or corrosion, observe the following:

- Be sure to insert the batteries with the + – polarities matched to the + – marks.
- Dry batteries are not rechargeable.
- Do not use a combination of new and old batteries.
- Do not use different types of batteries.
- Current flows from batteries when you are not using them for a long time.
- Do not use leaking batteries.

### If batteries are leaking

- Wipe off the liquid in the battery compartment carefully before replacing the batteries.
- If you touch the liquid, wash it off with water.
- If the liquid get into your eyes, wash your eyes with a lot of water and then consult a doctor.

If any problem occurs, unplug your camcorder and contact your nearest Sony dealer.

# Specifications

## Video camera recorder

### System

#### Video recording system

2 rotary heads

Helical scanning system

#### Audio recording system

MPEG1 Audio Layer2

(Fs 48 kHz, stereo)

#### Video signal

NTSC color, EIA standards

#### Usable cassette

MICROMV cassette with the

||||| mark printed

#### Tape speed

Approx. 5.66 mm/s

#### Recording/playback time

(using cassette MGR60)

1 hour

#### Fastforward/rewind time

(using cassette MGR60)

Approx. 1 min. and 30 seconds

#### Viewfinder

Electric viewfinder (color)

#### Image device

5.0 mm (1/3.6 type) CCD

(Charge Coupled Device)

Gross: Approx. 2 110 000 pixels

Effective (still):

Approx. 1 920 000 pixels

Effective (moving):

Approx. 1 080 000 pixels

#### Lens

Carl Zeiss Vario-Sonnar T\*

Combined power zoom lens

Filter diameter 37 mm (1 1/2 in.)

10× (Optical), 120× (Digital)

#### Focal length

4.5 – 45 mm (3/16 – 1 13/16 in.)

When converted to a 35 mm still camera

CAMERA:

52 – 520 mm (2 1/8 – 20 1/2 in.)

MEMORY:

39 – 390 mm (1 9/16 – 15 3/8 in.)

#### Color temperature

AUTO, HOLD, INDOOR (3 200K),

OUTDOOR (5 800K)

#### Minimum illumination

7 lx (lux) (F 1.8)

0 lx (lux) (in the NightShot mode)\*

\* Objects unable to be seen due to the dark can be shot with infrared lighting.

### Input/Output connectors

#### Audio/Video input/output

10-pin connector

Input/output auto switch

Video signal: 1 Vp-p, 75  $\Omega$  (ohms), unbalanced, sync negative

Luminance signal: 1 Vp-p, 75  $\Omega$  (ohms), unbalanced

Chrominance signal: 0.286 Vp-p, 75  $\Omega$  (ohms), unbalanced

Audio signal: 327 mV, (at output impedance more than 47 k $\Omega$  (kilohms))

Input impedance with more than 47 k $\Omega$  (kilohms)

Output impedance with less than 2.2 k $\Omega$  (kilohms)

#### i.LINK (MICROMV Interface)

#### input/output

4-pin connector S400

#### LANC jack

Stereo mini-minijack ( $\varnothing$  2.5 mm)

#### USB jack

mini-B

#### Headphone jack

Stereo minijack ( $\varnothing$  3.5 mm)

### LCD screen

#### Picture

6.2 cm (2.5 type)

#### Total dot number

211 200 (960  $\times$  220)

### Wireless communication (DCR-IP220 only)

#### Communication system

Bluetooth specification Ver.1.1

#### Maximum communication speed<sup>1)2)</sup>

Approx. 723 kbps

#### Maximum output

Bluetooth specification Power Class2

#### Communication distance<sup>2)</sup>

Approx. 10 m (33 feet) (Open space, when using a Sony BTA-NW1/NW1A Modem Adaptor with Bluetooth Function)

#### Compatible Bluetooth profiles<sup>3)</sup>

Generic Access Profile

Dial-up Networking Profile

#### Usable frequency band

2.4 GHz band

(2.400 – 2.483 5 GHz)

<sup>1)</sup> The maximum rate defined by Bluetooth specification Ver.1.1

<sup>2)</sup> Depends on obstacles between the Bluetooth devices, radio wave conditions, etc.

<sup>3)</sup> Defined by Bluetooth specification for intended use between the Bluetooth devices

### General

#### Power requirements

7.2 V (battery pack)

8.4 V (AC power adaptor)

#### Average power consumption

(when using the battery pack)

During camera recording using

LCD: 5.0 W

Viewfinder: 4.4 W

#### Operating temperature

0°C to 40°C (32°F to 104°F)

#### Storage temperature

-20°C to +60°C (-4°F to +140°F)

#### Dimensions (approx.)

98  $\times$  75.5  $\times$  136 mm

(3 7/8  $\times$  3  $\times$  5 3/8 in.) (w/h/d)

#### Mass (approx.)

520 g (1 lb 2 oz)

excluding the battery pack and cassette

630 g (1 lb 6 oz)

including the battery pack,

NP-FF70, cassette MGR60, lens cap and stylus

#### Supplied accessories

See page 16.



## Specifications

---

### AC power adaptor

**Power requirements**

100 – 240 V AC, 50/60 Hz

**Power consumption**

23 W

**Output voltage**

DC OUT: 8.4 V, 1.5 A in the operating mode

**Operating temperature**

0°C to 40°C (32°F to 104°F)

**Storage temperature**

-20°C to +60°C (-4°F to +140°F)

**Dimensions (approx.)**

125 × 39 × 62 mm (5 × 1 9/16 ×

2 1/2 in.) (w/h/d) excluding

projecting parts

**Mass (approx.)**

280 g (9.8 oz)

excluding power cord

### “Memory Stick”

**Memory**

Flash memory

8MB: MSA-8A

**Operating voltage**

2.7 – 3.6 V

**Power consumption**

Approx. 45 mA in the operating mode

Approx. 130 µA in the standby mode

**Dimensions (approx.)**

50 × 2.8 × 21.5 mm

(2 × 1/8 × 7/8 in.) (w/h/d)

**Mass (approx.)**

4 g (0.14 oz)

Design and specifications are subject to change without notice.

### Battery pack

**Maximum output voltage**

DC 8.4 V

**Output voltage**

DC 7.2 V

**Capacity**

9.6 Wh (1 350 mAh)

**Operating temperature**

0°C to 40°C (32°F to 104°F)

**Dimensions (approx.)**

40.8 × 24.1 × 49.1 mm

(1 5/8 × 31/32 × 1 15/16 in.)

(w/h/d)

**Mass (approx.)**

90 g (3.2 oz)

**Type**

Lithium ion

# Identifying the parts and controls

## Camcorder

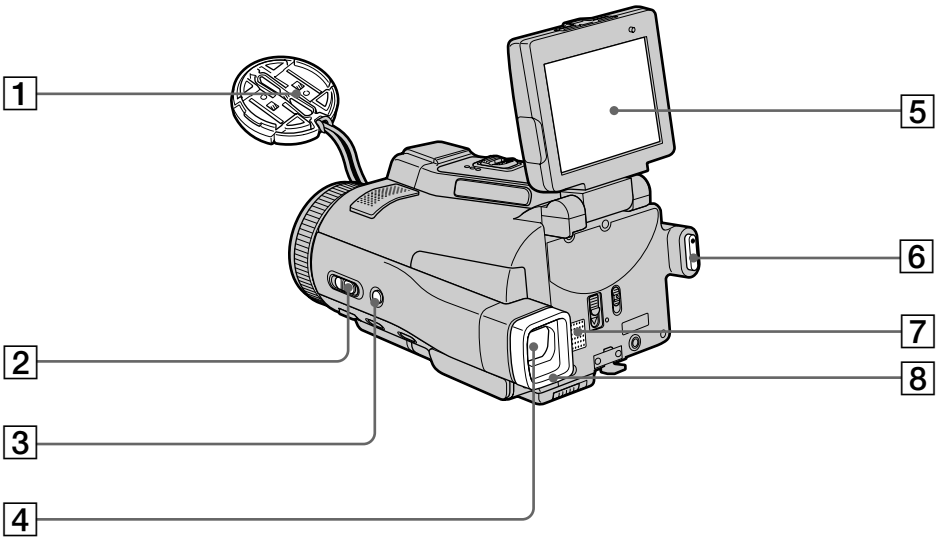

**1** Lens cap (p. 29)

**2** FOCUS/ZOOM switch (p. 34, 67)

**3** BACK LIGHT button (p. 37)

**4** Viewfinder (p. 32)

**5** LCD screen/Touch panel (p. 9, 27, 103)

**6** START/STOP button (p. 29, 130)

**7** Speaker

**8** Eyecup

## Identifying the parts and controls

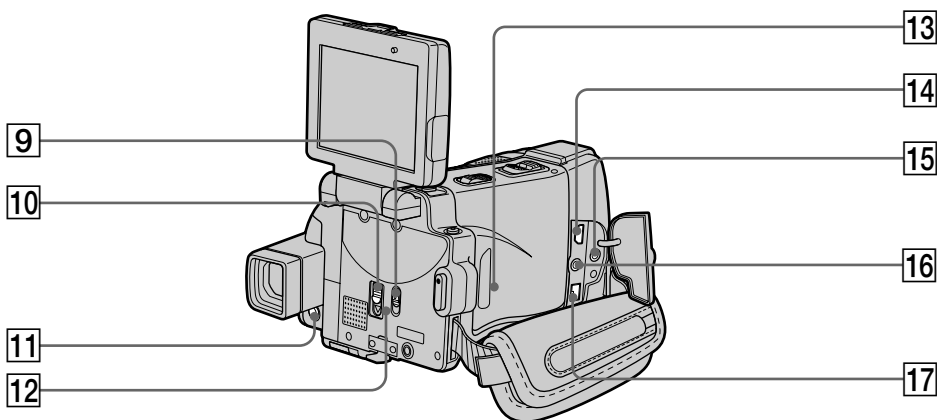

- 9** LCD BACKLIGHT switch (p. 31)
- 10** MEMORY EJECT lever (p. 102)
- 11** DISPLAY/TOUCH PANEL button (p. 43)
- 12** “Memory Stick” access lamp (p. 102)
- 13** RESET button  
If you press RESET, all the settings (DCR-IP220: except the NETWORK mode settings) including the date and time return to the default.
- 14**  $\Psi$  (USB) jack (p. 151)
- 15**  $\bullet$  (LANC) jack (blue)  
LANC stands for Local Application Control Bus System. The  $\bullet$  control jack is used for controlling the tape transport of video equipment and other peripherals connected to the video equipment. This jack has the same function as the jack indicated as CONTROL L or REMOTE.
- 16**  $\odot$  (headphones) jack (green)  
When you use headphones, the speaker on your camcorder is silent.
- 17** i.LINK (MICROMV Interface) (p. 82, 86, 124, 135, 198)  
The i.LINK (MICROMV Interface) is i.LINK compatible.

## Identifying the parts and controls

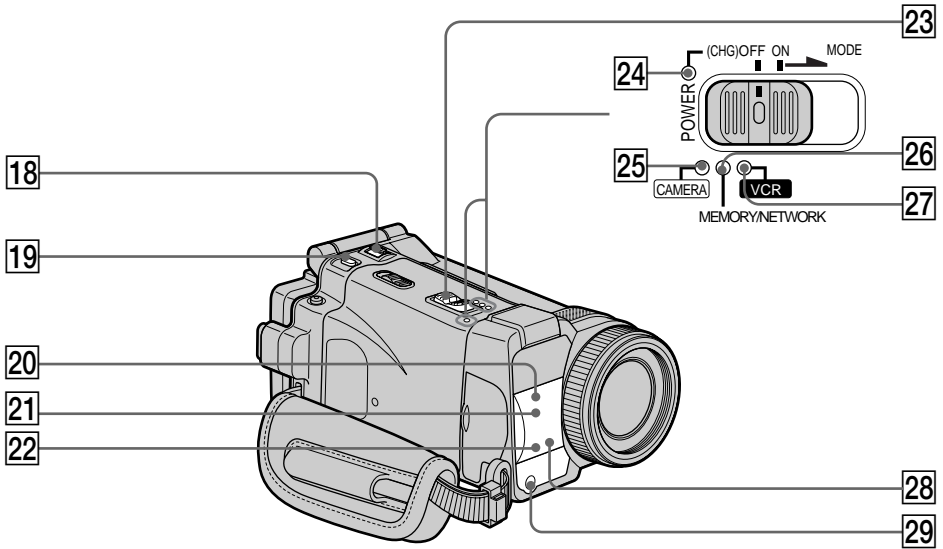

18 ZOOM lever (p. 33)

19 PHOTO button (p. 47, 111)

20 Infrared rays (NightShot Light) emitter (p. 37)

21 Remote sensor

22 Camera recording lamp (p. 29)

23 POWER switch (p. 8)

24 CHG lamp (p. 18)

25 CAMERA lamp (p. 8)

26 MEMORY/NETWORK lamp (DCR-IP220) or MEMORY lamp (DCR-IP210) (p. 8)

27 VCR lamp (p. 8)

28  (Bluetooth) lamp (DCR-IP220 only) (p. 175)

29 HOLOGRAM AF emitter (p. 117)

## Identifying the parts and controls

---

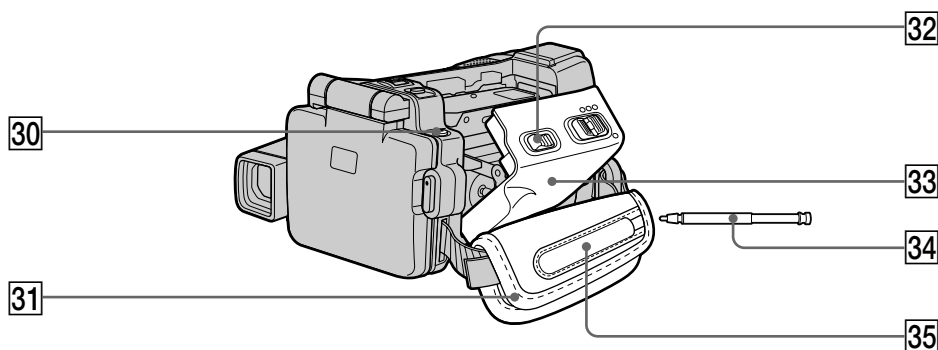

**30**  (flash) button (p. 49, 116)

**31** Grip belt

**32** OPEN/ EJECT  switch (p. 25)

**33** Cassette lid (p. 25)

**34** Stylus (DCR-IP220 only) (p. 176)

**35** Stylus holder (DCR-IP220 only) (p. 176)

---

### Fastening the grip belt

Fasten the grip belt firmly.

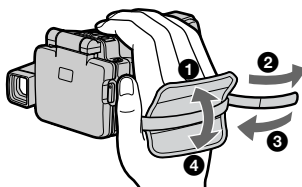

## Identifying the parts and controls

---

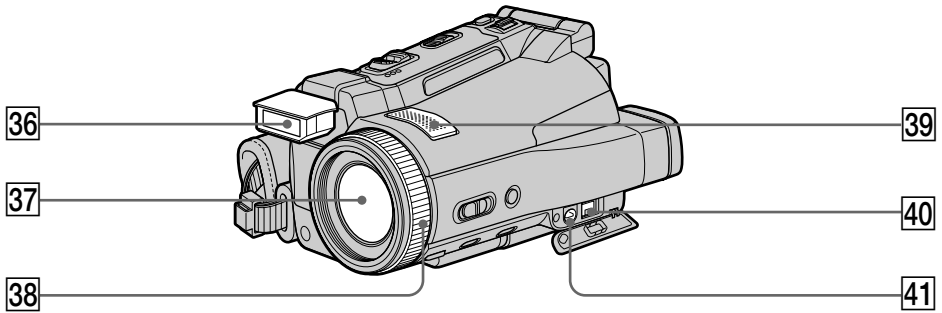

**36** Flash (p. 49, 116)

**37** Lens

**38** Focus ring/Zoom ring (p. 34, 67)

**39** Microphone

**40** DC IN jack

**41** A/V ID-2 jack (p. 46, 80, 84, 123, 134)

### Note on the Carl Zeiss lens

Your camcorder is equipped with a Carl Zeiss lens which can reproduce a fine image.

The lens for your camcorder was developed jointly by Carl Zeiss, in Germany, and Sony Corporation. It adopts the MTF<sup>#</sup> measurement system for video camera and offers a quality as the Carl Zeiss lens.

The lens for your camcorder is also T\*-coated to suppress unwanted reflection and faithfully reproduce colors.

<sup>#</sup> MTF is an abbreviation of Modulation Transfer Function.

The value number indicates the amount of light of a subject penetrating into the lens.

## Identifying the parts and controls

---

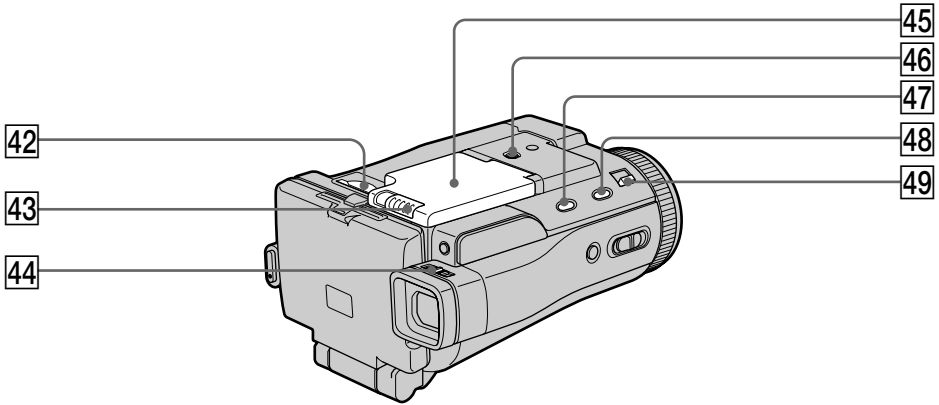

**42** “Memory Stick” slot (p. 102)

**43** OPEN  switch (p. 17)

**44** Viewfinder lens adjustment lever  
(p. 32)

**45** Battery compartment lid

**46** Tripod receptacle  
Make sure that the length of the tripod screw is less than 5.5 mm (7/32 inch). Otherwise, you cannot attach the tripod securely and the screw may damage your camcorder.

**47** FADER button (p. 57)

**48** SUPER NS/COLOR SLOW S button  
(p. 38)

**49** NIGHTSHOT/NIGHTFRAMING switch  
(p. 37, 119)

## Identifying the parts and controls

### Remote Commander

The buttons that have the same name on the Remote Commander as on your camcorder function identically to the buttons on your camcorder.

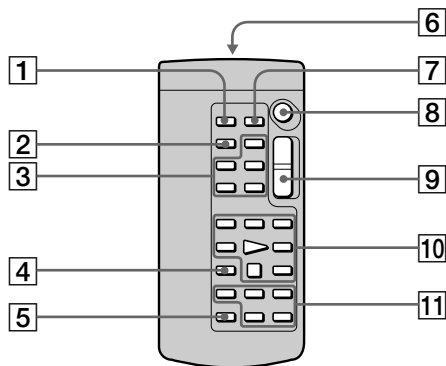

**1** PHOTO button (p. 47, 111)

**2** DISPLAY button (p. 43)

**3** MEMORY control buttons

**4** SEARCH MODE button (p. 78, 79)

**5** MULTI SRCH button (p. 74)

**6** Transmitter

Point toward the remote sensor to control your camcorder after turning on your camcorder.

**7** DATA CODE button (p. 43)

**8** START/STOP button (p. 29, 130)

**9** Power zoom button (p. 33)

**10** Video control buttons (p. 42, 45)

**11** ↑/↓/←/→/EXECUTE buttons



## Identifying the parts and controls

---

### To prepare the Remote Commander

Insert two size AA (R6) batteries by matching the + and - polarities on the batteries to the + - marks inside the battery compartment.

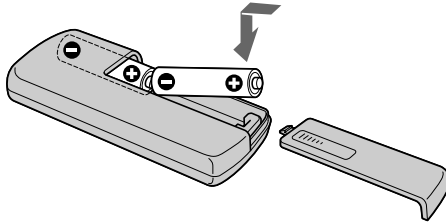

---

### Notes on the Remote Commander

- Point the remote sensor away from strong light sources such as direct sunlight or overhead lighting. Otherwise, the Remote Commander may not function properly.
- Your camcorder works in the commander mode VTR 2. Commander modes 1, 2 and 3 are used to distinguish your camcorder from other Sony VCRs to avoid remote control misoperation. If you use another Sony VCR in the Commander mode VTR 2, we recommend changing the commander mode or covering the sensor of the VCR with black paper.

# Identifying the parts and controls

## Operation indicators

### LCD screen and viewfinder

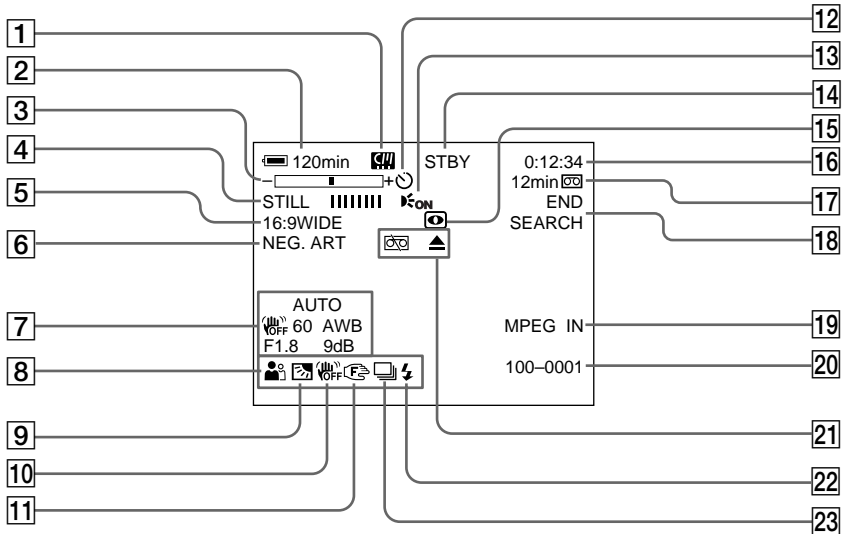

- 1 micro Cassette Memory (p. 36, 195)
- 2 Remaining battery time (p. 36, 44)
- 3 Zoom (p. 33)/Data file name (p. 100)
- 4 Digital effect (p. 59, 71)/MEMORY MIX (p. 125)/FADER (p. 56)
- 5 16:9WIDE (p. 54)
- 6 Picture effect (p. 58, 70)
- 7 Data code (p. 43)/Date (p. 36)
- 8 PROGRAM AE (p. 62)
- 9 BACK LIGHT (p. 37)
- 10 SteadyShot off (p. 179)
- 11 Manual focus (p. 67)/Expanded focus (p. 67)/Zoom ring (p. 34)
- 12 Self-timer (p. 40, 51, 120, 132)
- 13 HOLOGRAM AF (p. 117)
- 14 STBY/REC (p. 29)/Video control mode (p. 45)/Image size (p. 109)/Image quality mode (p. 105)/Picture quality mode (p. 107)
- 15 NIGHTSHOT/SUPER NIGHTSHOT (p. 37)/COLOR SLOW SHUTTER (p. 38)/NIGHTFRAMING (p. 119)
- 16 Tape counter (p. 36)/Self-diagnosis (p. 192)/Memory photo (p. 111)
- 17 Remaining tape (p. 36)/Memory playback (p. 137)
- 18 END SEARCH (p. 41)
- 19 MPEG IN (p. 87)
- 20 Data file name (p. 100)  
This indicator appears when the MEMORY MIX functions work./  
Time (p. 36)
- 21 Warning (p. 193)
- 22 Flash (p. 49, 116)
- 23 Continuous photo recording (p. 113)

# Index

## A, B

AC power adaptor .....	18, 21
Adjusting viewfinder .....	32
Adjusting volume .....	42
Auto red-eye reduction .....	49, 116
AUTO SHTR .....	178
A/V connecting cable .....	46, 80, 84, 123, 134
BACK LIGHT .....	37
Battery pack .....	17
BEEP .....	185
BOUNCE .....	56
B&W .....	58

## C, D

CALIBRATION .....	204
Camera chroma key .....	125
Carl Zeiss lens .....	214
Cassette information .....	97
Cassette memory .....	97
Charging battery .....	18
Charging built-in rechargeable battery .....	203
Cleaning cassette .....	202
Clock set .....	22
COLOR SLOW SHUTTER .....	38
Continuous photo recording .....	113
Data code .....	43
DATE SEARCH .....	79
DEMO MODE .....	184
Digital effect .....	59, 71
DISPLAY .....	185
Dubbing a tape .....	80

## E

END SEARCH .....	41
Expanded focus .....	67
EXP BRKTG .....	113
Exposure .....	65

## F, G, H

Fader .....	56
FADER .....	56
Fade in/out .....	56
Flash .....	49, 116
FLASH MOTION .....	59
Flexible Spot Meter .....	66
FOCUS .....	67
Focusing manually .....	67
FORMAT .....	182
Full charge .....	18
Grip belt .....	213
Heads .....	202
HIGH SPEED .....	113
HOLOGRAM AF .....	117

## I, J, K, L

i.LINK (MICROMV Interface) .....	82, 86, 124, 135, 198
Image protection .....	146
Image quality mode .....	105
Image size .....	109
Index screen .....	138
“InfoLITHIUM” battery .....	20, 196
Infrared rays emitter .....	37
JPEG .....	100
Labeling a cassette .....	98
Ⓛ (LANC) jack .....	211
LUMINANCE KEY .....	59

## M, N

Manual focus .....	67
Memory chroma key .....	125
Memory luminance key .....	125
MEMORY MIX .....	125
Memory overlap .....	125
Memory PB ZOOM .....	143
Memory photo playback .....	136
Memory photo recording .....	111
“Memory Stick” .....	100
Menu settings .....	177
M. FADER .....	56
micro Cassette Memory .....	14, 195
Mirror mode .....	35
Moisture condensation .....	201
MONOTONE .....	56
MOSAIC .....	58
MPEG .....	100
MPEG MOVIE recording .....	130
MULTI-PICTURE SEARCH .....	74
MULTI SCRN .....	113
NEG. ART .....	58
NETWORK .....	175
NIGHTFRAMING .....	119
NIGHTSHOT .....	37
NTSC system .....	200

## O, P, Q

OLD MOVIE .....	59
Operation indicators .....	218
PASTEL .....	58
Picture effect .....	58, 70
Picture quality mode .....	107
Playback pause .....	45
Playing time .....	19
Print mark .....	150
PROGRAM AE .....	62

## R

Recording time .....	19
Remaining battery time indicator .....	36
Remaining tape indicator .....	36
Remote Commander .....	216
Remote sensor .....	212
RESET .....	211

## S

Self-diagnosis display .....	192
Self-timer recording .....	40, 51, 120, 132
SEPIA .....	58
SHARPNESS .....	178
Slide show .....	145
SLOW SHUTTER .....	59
SOLARIZE .....	58
SPOT FOCUS .....	69
STEADYSHOT .....	179
STILL .....	59
Stylus .....	176
SUPER NIGHTSHOT .....	38

## T, U, V

Tape counter .....	36
Tape PB ZOOM .....	72
Telephoto .....	33
Title .....	88, 94
TITLE SEARCH .....	78
Touch panel .....	27, 103
TRAIL .....	59
Transition .....	30
TV color systems .....	200
USB jack .....	151
USB Streaming .....	164

## W, X, Y, Z

Warning indicators .....	193
White balance .....	52
Wide-angle .....	33
Wide mode .....	54
Write-protect tab .....	25, 100
Zoom .....	33
Zoom ring .....	34

<http://www.sony.net/>



Printed on 100% recycled paper using  
VOC (Volatile Organic Compound)-free  
vegetable oil based ink.

Printed in Japan



3 0 7 6 8 9 7 1 1