

Camera Operations Guide

Read this first

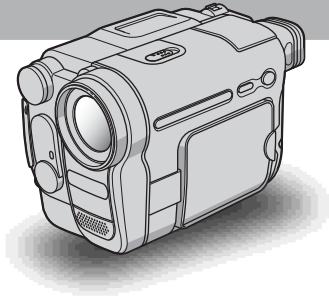

Digital Video Camera Recorder

HANDYCAM

DCR-TRV361/TRV460



InfoLITHIUM™



SERIES





MEMORY STICK

Read this first

Before operating the unit, please read this manual thoroughly, and retain it for future reference.

WARNING

To prevent fire or shock hazard, do not expose the unit to rain or moisture.

	CAUTION RISK OF ELECTRIC SHOCK DO NOT OPEN	
<p>CAUTION: TO REDUCE THE RISK OF ELECTRIC SHOCK, DO NOT REMOVE COVER (OR BACK). NO USER-SERVICEABLE PARTS INSIDE. REFER SERVICING TO QUALIFIED SERVICE PERSONNEL.</p>		

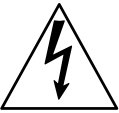

This symbol is intended to alert the user to the presence of uninsulated “dangerous voltage” within the product’s enclosure that may be of sufficient magnitude to constitute a risk of electric shock to persons.



This symbol is intended to alert the user to the presence of important operating and maintenance (servicing) instructions in the literature accompanying the appliance.

Notice

- If static electricity or electromagnetic interference causes data transfer to discontinue midway (fail), restart the application or disconnect and connect the USB cable again.

For customers in the U.S.A. and CANADA

CAUTION

TO PREVENT ELECTRIC SHOCK, MATCH WIDE BLADE OF PLUG TO WIDE SLOT, FULLY INSERT.

RECYCLING LITHIUM-ION BATTERIES

Lithium-Ion batteries are recyclable.

You can help preserve our environment by returning your used rechargeable batteries to the collection and recycling location nearest you. For more information regarding recycling of rechargeable batteries, call toll free 1-800-822-8837, or visit <http://www.rbrbc.org/>



Caution: Do not handle damaged or leaking Lithium-Ion batteries.

For customers in the U.S.A.

If you have any questions about this product, you may call:

Sony Customer Information Center 1-800-222-SONY (7669)

The number below is for FCC related matters only.
Regulatory Information

Declaration of Conformity

Trade Name: SONY

Model No.: DCR-TRV460

Responsible Party: Sony Electronics Inc.

Address: 680 Kinderkamack Road, Oradell, NJ 07649 U.S.A.

Telephone No.: 201-930-6972

This device complies with Part 15 of the FCC Rules.

Operation is subject to the following two conditions:

(1) This device may not cause harmful interference, and (2) this device must accept any interference received, including interference that may cause undesired operation.

Owner's Record

The model and serial numbers are located on the bottom. Record the serial number in the space provided below. Refer to these numbers whenever you call upon your Sony dealer regarding this product.

Model No. DCR-TRV _____

Serial No. _____

Model No. AC- _____

Serial No. _____

CAUTION

You are cautioned that any changes or modifications not expressly approved in this manual could void your authority to operate this equipment.

Note:

This equipment has been tested and found to comply with the limits for a Class B digital device, pursuant to Part 15 of the FCC Rules.

These limits are designed to provide reasonable protection against harmful interference in a residential installation. This equipment generates, uses, and can radiate radio frequency energy and, if not installed and used in accordance with the instructions, may cause harmful interference to radio communications.





However, there is no guarantee that interference will not occur in a particular installation. If this equipment does cause harmful interference to radio or television reception, which can be determined by turning the equipment off and on, the user is encouraged to try to correct the interference by one or more of the following measures:

- Reorient or relocate the receiving antenna.
- Increase the separation between the equipment and receiver.
- Connect the equipment to an outlet on a circuit different from that to which the receiver is connected.
- Consult a Sony dealer or an experienced radio/TV technician for help.

The interface cable supplied must be used with the equipment in order to comply with the limits for a digital device pursuant to Subpart B of Part 15 of FCC Rules.

Notes on use

Note on a cassette tape

You can record on standard 8 mm  and Hi8 , Digital8  video cassettes in Digital8  system only on your camcorder. See page 115 for details.

Notes on recording

- Before starting to record, test the recording function to make sure the picture and sound are recorded without any problems.
- Compensation for the contents of recordings cannot be provided, even if recording or playback is not possible due to a malfunction of the camcorder, storage media, etc.
- TV color systems differ depending on the country/regions. To view your recordings on a TV, you need an NTSC system-based TV.
- Television programs, films, video tapes, and other materials may be copyrighted. Unauthorized recording of such materials may be contrary to the copyright laws.

Notes on the LCD panel, viewfinder, and lens

- The LCD screen and the viewfinder are manufactured using extremely high-precision technology, so over 99.99% of the pixels are operational for effective use. However, there may be some tiny black points and/or bright points (white, red, blue, or green in color) that appear constantly on the LCD screen and the viewfinder.

These points are normal results of the manufacturing process and do not affect the recording in any way.

→continued

- Exposing the LCD screen, the viewfinder, or the lens to direct sunlight for long periods of time may cause malfunctions. Be careful when placing the camera near a window or outdoors.
- Do not aim at the sun. Doing so might cause your camcorder to malfunction. Take pictures of the sun only in low light conditions, such as at dusk.

Note on connecting other device

Before connecting your camcorder to other device such as a VCR or a computer with a USB or i.LINK cable, be sure to insert the connector plug in the proper direction. If you insert the connector plug forcibly in the wrong direction, the terminal may be damaged, or this may cause a malfunction of your camcorder.

Notes on using this manual

- The images of the LCD screen and the viewfinder used on this manual are captured using a digital still camera, and thus may appear different from what you see.
 - Instructions with no specific model names are for all models.
- Instructions with specific model names are for the indicated models only.
- Before you start reading this manual, check the model name of your camcorder.

Notes on using the camcorder

- Hold your camcorder correctly.

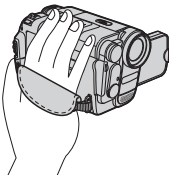

- To ensure a good grip, fasten the grip belt as shown in the following illustration.

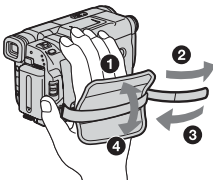

- When you are using the touch panel, place your hand on the back side of the LCD panel to support it. Then, touch the buttons displayed on the screen.

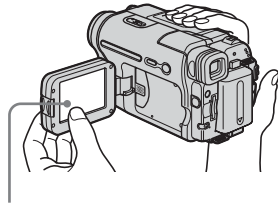

Touch the button on the LCD screen.

- You can change the language to be used for screen display on your camcorder (p. 22)
- Do not hold the camcorder by the following parts.

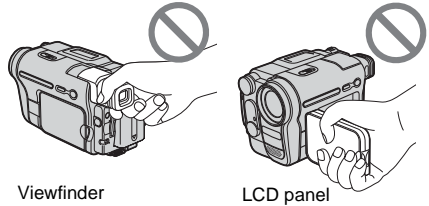

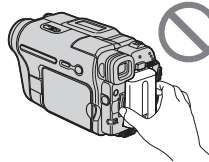

Viewfinder

LCD panel



Battery pack

Table of Contents

 : Features available for tape only.
 : Features available for “Memory Stick” only.

Read this first	2
-----------------------	---



Quick Start Guide

Recording movies	8
Recording still images	10
Recording/Playing back with ease	12



Getting started

Step 1: Checking supplied items	13
Step 2: Charging the battery pack	14
Using an outside power source	17
Step 3: Turning the power on	17
Step 4: Adjusting the LCD panel and viewfinder	18
Adjusting the LCD panel	18
Adjusting the viewfinder	18
Step 5: Setting the date and time	19
Step 6: Inserting the recording media	20
Inserting a cassette tape	20
Inserting a “Memory Stick”	21
Step 7: Setting the screen language	22



Recording

Recording movies	24
Recording for a longer time	26
Using zoom	26
Using the built-in light	27
Recording in mirror mode	28
Using the self-timer	28
Recording still images  – Memory photo recording	29
Selecting image quality	31
Using the self-timer	31
Recording a still image on a “Memory Stick” while recording movies on a tape	32
Recording with ease – Easy Handycam	33
Recording a movie 	33
Recording a still image 	34
Making full use of Easy Handycam operation	34

→ continued







Adjusting the exposure.....	35
Adjusting the exposure for backlit subjects	35
Fixing the exposure for the selected subject – Flexible spot meter	35
Adjusting the exposure manually	36
Recording in dark places – NightShot plus, etc.	37
Adjusting the focus.....	38
Adjusting the focus for an off-center subject – SPOT FOCUS	38
Adjusting the focus manually	39
Recording a picture using various effects	40
Fading in and out of a scene  – FADER	40
Using special effects  – Digital effect	41
Overlaying still images on movies on a tape – MEMORY MIX	42
Searching for the starting point 	44
Searching for the last scene of the most recent recording	
– END SEARCH	44
Searching manually – EDIT SEARCH	45
Reviewing the most recently recorded scenes – Rec review	45

Playback



Viewing movies recorded on a tape 	46
Playing back in various modes	47
Viewing recordings with added effects – Digital effect	48
Viewing recordings on a “Memory Stick” 	49
Playing back in various modes from a “Memory Stick”	50
Playing back with ease – Easy Handycam	51
Making full use of Easy Handycam operation	52
Various playback functions	53
Magnifying pictures – Tape playback zoom/Memory playback zoom	53
Displaying the screen indicators	54
Displaying the date/time and camera settings data – Data code	54
Playing the picture on a TV	56
Locating a scene on a tape for playback 	57
Searching quickly for a desired scene – Zero set memory	57
Searching for a scene by date of recording – Date search	57

Advanced operations

Using the Menu

- Selecting menu items59
- Using the  (CAMERA SET) menu
– PROGRAM AE/16:9 WIDE,
etc.61
- Using the  (MEMORY SET) menu
– QUALITY/IMAGE SIZE/ALL
ERASE/NEW FOLDER, etc.65
- Using the  (PICT. APPLI.) menu
– PICT. EFFECT/SLIDE SHOW/
FRAME REC/INTERVAL REC,
etc.68
- Using the  (EDIT/PLAY) menu
– END SEARCH/TITLE, etc.73
- Using the  (STANDARD SET) menu
– REC MODE/MULTI-SOUND/
AUDIO MIX/USB-CAMERA,
etc.76
- Using the  (TIME/LANGU.) menu
– CLOCK SET/WORLD TIME,
etc.82
- Customizing Personal Menu83
-

Dubbing/Editing

- Connecting to a VCR or TV86
- Dubbing to another tape 87
- Recording pictures from a VCR or
TV88
- Dubbing pictures from a tape to a
“Memory Stick”89
- Dubbing still images from a “Memory
Stick” to a tape90
- Dubbing selected scenes from a tape
– Digital program editing91
- Deleting recorded pictures 98

- Marking recorded images with specific
information  – Image protection/
Print mark99
- Printing recorded images (PictBridge
compliant printer) 101
-

Troubleshooting

- Troubleshooting103
- Warning indicators and messages ...110
-

Additional Information

- Using your camcorder abroad114
- Usable cassette tapes115
- About the “Memory Stick”116
- About the “InfoLITHIUM” battery
pack118
- About i.LINK119
- Maintenance and precautions120
- Specification123
-

Quick Reference

- Identifying parts and controls126
- Index132

Refer also to other operating instructions
supplied with your camcorder:

- Editing images with your computer
→ Computer Applications Guide



Quick Start Guide

Recording movies

1 Attach the charged battery pack to the camcorder.

To charge the battery, see page 14.

① Lift up the viewfinder.

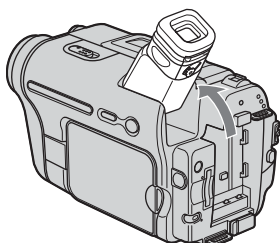

② Slide the battery pack in the direction of the arrow until it clicks.

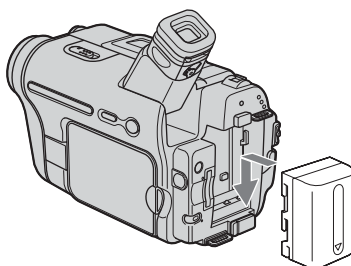

2 Insert a cassette into the camcorder.

① Slide the **OPEN/EJECT** lever in the direction of the arrow to open the lid.

The cassette compartment comes out automatically.

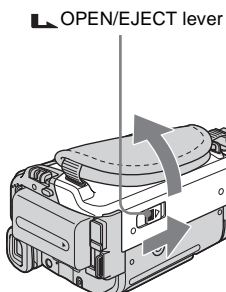

② Insert the cassette with its window-side facing up, then push the center of the back of the cassette.

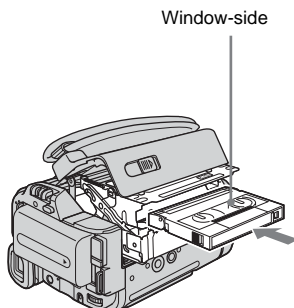

③ Press **PUSH**.

Close the cassette lid after the cassette compartment slides back in by itself.

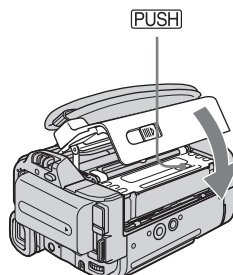

3 Start recording while checking the subject on the LCD screen.

The date and time is not set up in the default setting. To set the date and time, see page 19.

1 Remove the lens cap.

Lens cap is not attached when you purchase your camcorder (p. 126).

2 Press OPEN and open the LCD panel.

3 While pressing the green button, slide the POWER switch down to light up the CAMERA-TAPE lamp.

The power turns on.

4 Press REC START/STOP.

Recording starts. To change to standby mode, press REC START/STOP again.

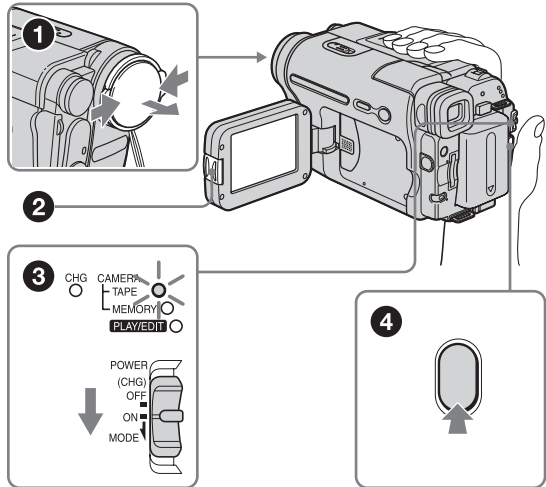

4 View the recorded picture on the LCD screen.

1 Slide the POWER switch repeatedly until the PLAY/EDIT lamp lights up.

2 Touch ◀◀ (rewind).

3 Touch ▶▶ (play) to start the playback.

To stop, press ■■.

To turn off the power, slide the POWER switch up to (CHG) OFF.

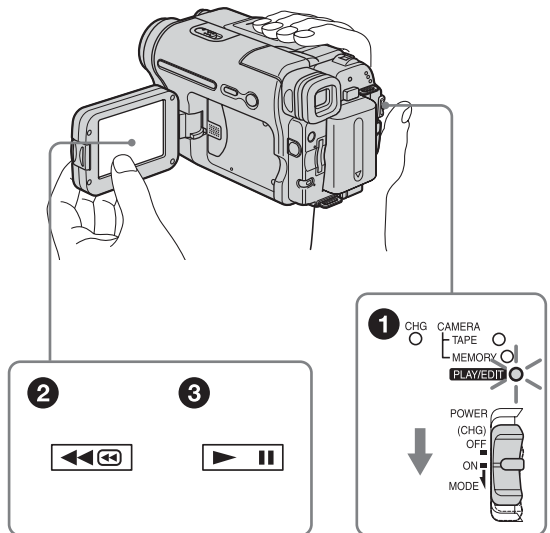

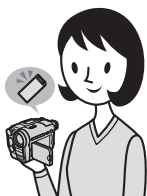

Recording still images

1 Attach the charged battery pack to the camcorder.

To charge the battery, see page 14.

① Lift up the viewfinder.

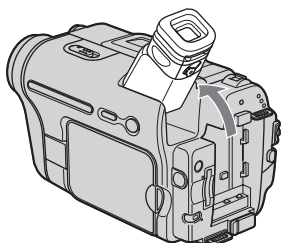

② Slide the battery pack in the direction of the arrow until it clicks.

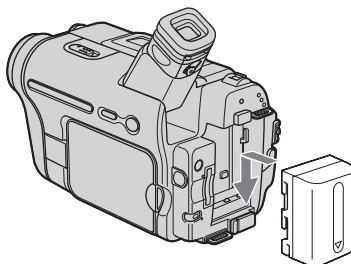

2 Insert a “Memory Stick” into the camcorder.

Insert it so that the ◀ mark is at the bottom left corner. Push in until it clicks.

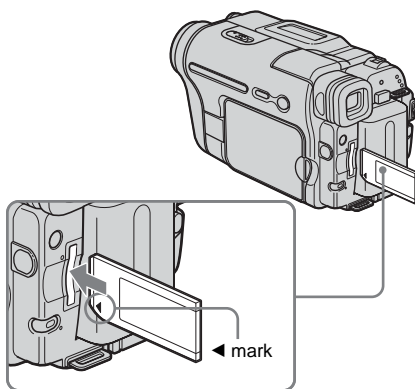

3 Start recording while checking the subject on the LCD screen.

The date and time is not set up in the default setting. To set the date and time, see page 19.

1 Remove the lens cap.

Lens cap is not attached when you purchase your camcorder (p. 126).

2 Press OPEN and open the LCD panel.

3 While pressing the green button, slide the POWER switch repeatedly until the CAMERA-MEMORY lamp lights up.

The power turns on.

4 Press PHOTO lightly.

A short beep sound is heard when the focus is adjusted.

5 Press PHOTO fully.

A shutter sound is heard and the still image is recorded.

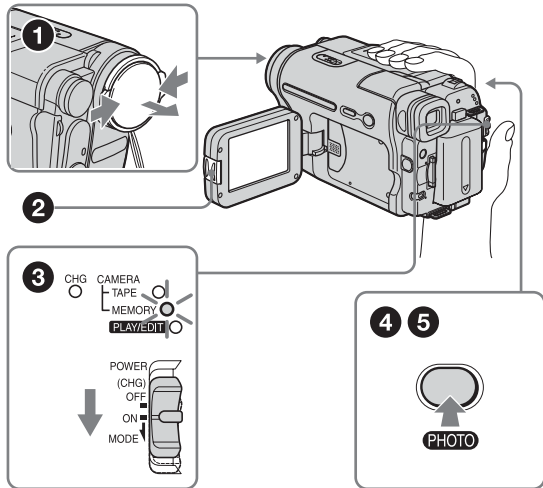

4 View the recorded picture on the LCD screen.

1 Slide the POWER switch repeatedly until the PLAY/EDIT lamp lights up.

2 Touch \square PB.

The most recently recorded image is displayed.

3 Touch \square + (next) or \square - (previous) to view images in sequence.

To turn off the power, slide the POWER switch up to (CHG) OFF.

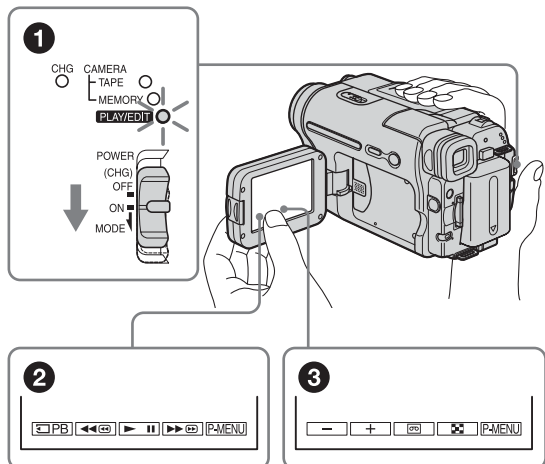



Recording/Playing back with ease

By switching to Easy Handycam operation, recording/playback operation becomes even easier.

Easy Handycam operation allows easy recording/playback for even first time users by providing only the basic functions for recording/playback.

Press EASY when recording/ playing back.

EASY lights up in blue (1) and screen font size increases (2) during Easy Handycam operation.

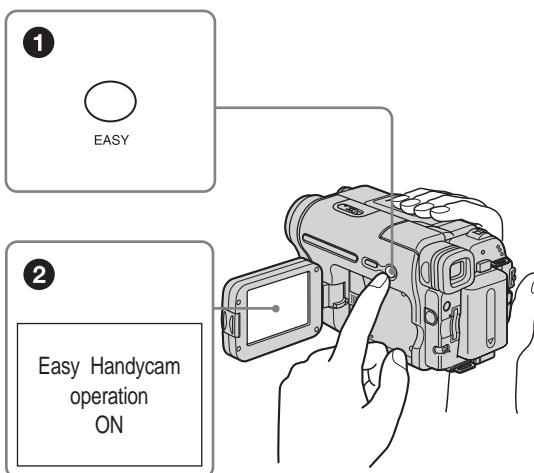

For details, see instructions for each operation.
See page 33 for recording, page 51 for playback.

Step 1: Checking supplied items

Make sure you have following items supplied with your camcorder.

The number in parentheses indicates the number of that item supplied.

“Memory Stick” 8MB (1) (DCR-TRV361)

“Memory Stick” media is only supplied with DCR-TRV361.

There is no “Memory Stick” media supplied with DCR-TRV460.

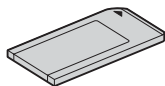

AC Adaptor (1)

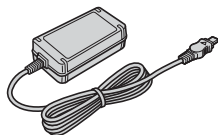

Power cord (1)



Lens cap (1)

See page 126 on how to attach the lens cap.



Shoulder strap (1)

See page 127 on how to attach the shoulder strap.

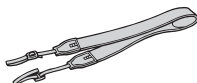

Wireless Remote Commander (1)

A button-type lithium battery is already installed.



A/V connecting cable (1)



USB cable (1)



Rechargeable battery pack NP-FM30 (1)

CD-ROM “SPVD-012 USB Driver” (1)

Cleaning cloth (1)

Camera Operations Guide (This manual) (1)

Computer Applications Guide (1)

Step 2: Charging the battery pack

You can charge the battery by attaching the “InfoLITHIUM” battery pack (M series) to your camcorder.

⚡ Notes

- You cannot use batteries other than the “InfoLITHIUM” battery pack (M series) (p. 118).
- Do not short-circuit the DC plug of the AC Adaptor or battery terminals with any metallic objects. This may cause a malfunction.
- Use a nearby wall outlet when using the AC Adaptor. Disconnect the AC Adaptor from the wall outlet immediately if any malfunction occurs.

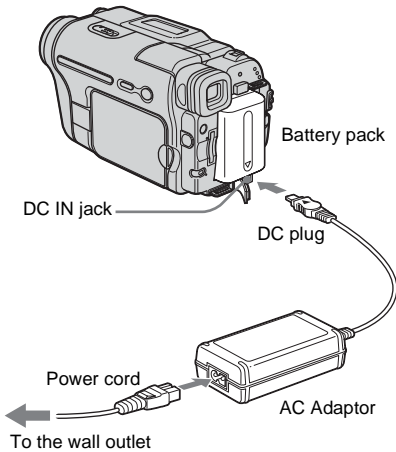

1 Lift up the viewfinder.

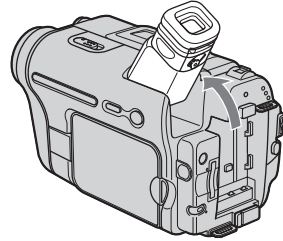

2 Attach the battery pack by sliding it in the direction of the arrow until it clicks.

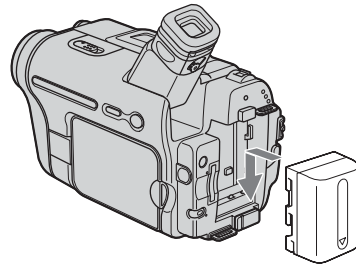

3 With the ▲ mark on the DC plug facing up, connect the AC Adaptor to the DC IN jack on your camcorder.

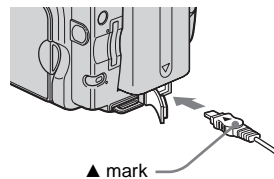

4 Connect the power cord to the AC Adaptor.

5 Connect the power cord to the wall outlet.

6 Slide the POWER switch up to (CHG) OFF.

The CHG (charge) lamp lights up and charging starts.

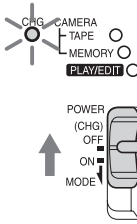

To check the remaining battery – Battery Info

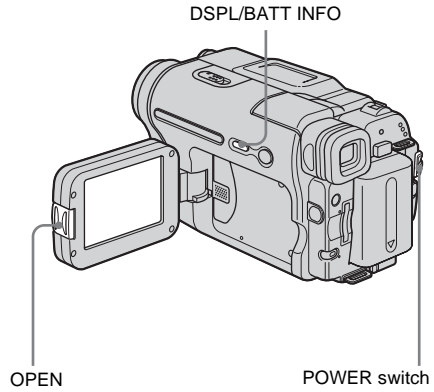

After charging the battery

The CHG (charge) lamp turns off when the battery is fully charged. Disconnect the AC Adaptor from the DC IN jack.

To remove the battery pack

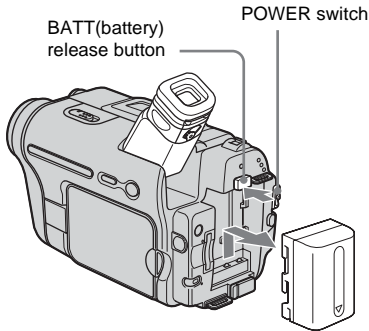

- 1 Set the POWER switch to (CHG) OFF.
- 2 Lift up the viewfinder.
- 3 Slide the battery pack out in the direction of the arrow pressing the BATT (battery) release button down.

Note

- If you do not use the battery pack for a long time, use up the battery pack completely before storing it. See page 119 about storage of the battery pack.

You can check the battery's current charge level and its current remaining recording time both during charging or when the power is turned off.

- 1 Set the POWER switch to (CHG) OFF.
- 2 Press OPEN and open the LCD panel.
- 3 Press DSPL/BATT INFO.

The battery information appears for about 7 seconds.

Keep the button pressed to view it for about 20 seconds.

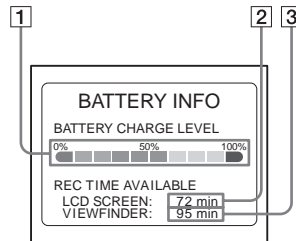

- 1 Battery charge level: Displays approximate remaining amount of power left in the battery pack.
- 2 Approximate possible recording time using the LCD panel.
- 3 Approximate possible recording time using the viewfinder.

→ continued

Charging time

Approximate number of minutes required when you fully charge a fully discharged battery pack at 25°C (77°F). (10 – 30°C (50 – 86°F) recommended.)

Battery pack	
NP-FM30 (supplied)	145
NP-FM50	150
NP-QM71/QM71D	260
NP-QM91/QM91D	360

Recording time when recording with the LCD screen on

Approximate number of minutes available when you use a fully charged battery pack at 25°C (77°F).

Battery pack	Continuous recording time	Typical* recording time
NP-FM30 (supplied)	80	40
NP-FM50	130	60
NP-QM71/QM71D	315	150
NP-QM91/QM91D	475	230

Recording time when recording with the viewfinder

Approximate number of minutes available when you use a fully charged battery pack at 25°C (77°F).

Battery pack	Continuous recording time	Typical* recording time
NP-FM30 (supplied)	105	50
NP-FM50	170	85
NP-QM71/QM71D	415	205
NP-QM91/QM91D	625	310



* Approximate number of minutes when recording while you repeatedly record, start/stop, slide the POWER switch to change the power mode, and zoom. The actual battery life may be shorter.

Playing time

Approximate number of minutes available when you use a fully charged battery pack at 25°C (77°F).

This table shows the playing time for tapes recorded in the Digital8  system.

For DCR-TRV460:

The playing time of tapes recorded on other devices in the Hi8 /standard 8 mm  system is reduced by about 20%.

Battery pack	LCD panel opened	LCD panel closed
NP-FM30 (supplied)	80	120
NP-FM50	135	195
NP-QM71/QM71D	335	465
NP-QM91/QM91D	505	695

Notes

- The power will not be supplied from the battery pack when the AC Adaptor is connected to the DC IN jack of your camcorder, even if its power cord is disconnected from the wall outlet.
- The recording and playback time will be shorter when you use your camcorder in low temperature.
- The CHG (charge) lamp flashes during charging, or the battery information will not be correctly displayed in following conditions.
 - The battery pack is not attached correctly.
 - The battery pack is damaged.
 - The battery pack is fully discharged. (For Battery information only.)

Using an outside power source

You can use the AC Adaptor as the power source when you do not want the battery to run out. While you are using the AC Adaptor, the battery pack will not lose its charge even when it is attached to your camcorder.

PRECAUTION

Even if your camcorder is turned off, AC power (house current) is still supplied to it while connected to the wall outlet via the AC Adaptor.

Connect your camcorder as shown in “Charging the battery pack” (p. 14).

Step 3: Turning the power on

You need to slide the POWER switch repeatedly to select the desired power mode to record or play.

When using this camcorder for the first time, the [CLOCK SET] screen appears (p. 19).

While pressing the green button, slide the POWER switch down.

The power turns on.

To enter the recording or playing mode, slide the switch repeatedly until the respective lamp for the desired power mode lights up.

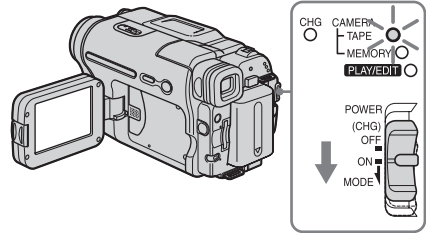

- CAMERA-TAPE mode: To record on a tape.
- CAMERA-MEMORY mode: To record on a “Memory Stick.”
- PLAY/EDIT mode: To play or edit pictures on a tape or “Memory Stick.”

To turn off the power

Slide the POWER switch up to (CHG) OFF.

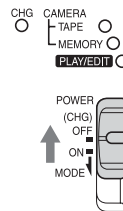

Step 4: Adjusting the LCD panel and viewfinder

Adjusting the LCD panel

You can adjust the angle and brightness of the LCD panel to meet various recording situations.

Even when there are obstructions between you and the subject, you can check the subject on the LCD screen during recording by adjusting the angle of the LCD panel.

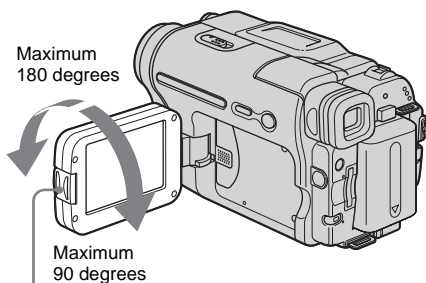



Press OPEN and open the LCD panel.

Open the LCD panel 90 degrees to the camcorder, then rotate it to the desired position.



To adjust the brightness of the LCD screen

1 Touch [P-MENU].



2 Touch [LCD BRIGHT].

If the item is not displayed on the screen, touch  / . If you cannot find it, touch

[MENU],  (STANDARD SET) menu, then touch [LCD SET] (p. 78).

3 Adjust the item with  / , then touch .

Tips

- If you rotate the LCD panel 180 degrees to the lens side, you can close the LCD panel with the LCD screen facing out.
- If you are using the battery pack for power source, you can adjust the brightness by selecting [LCD BL LEVEL] from the [LCD SET] on the  (STANDARD SET) menu (p. 78).
- Even if you adjust the LCD screen backlight, the recorded picture will not be affected.
- You can turn off the operation confirmation beep by setting [BEEP] in the  (STANDARD SET) menu to [OFF] (p. 81).

Adjusting the viewfinder

You can view images using the viewfinder when you close the LCD panel. Use the viewfinder when the battery is running out, or when the screen is hard to see.

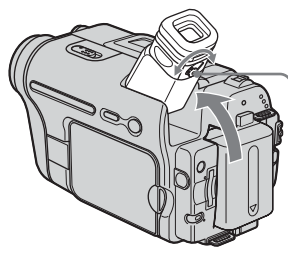

Viewfinder lens adjustment lever

1 Lift up the viewfinder.

2 Adjust the viewfinder lens adjustment lever until the picture is clear.

To use the viewfinder during operation

When you are recording on a tape or a “Memory Stick”, you can adjust the exposure (p. 35) and fader (p. 40) while checking the image on the viewfinder. Have the LCD panel rotated 180 degrees and closed with the screen facing out.

- 1 **Set the power mode to CAMERA-TAPE or CAMERA-MEMORY (p. 17).**
- 2 **Close the LCD panel with the screen facing out.**
[OFF] appears on the screen.
- 3 **Touch [OFF].**
[Set LCD off?] appears on the screen.
- 4 **Touch [YES].**
The LCD screen is turned off.
- 5 **Touch the LCD screen while checking the display in the viewfinder.**
[EXPOSURE], etc. are displayed.
- 6 **Touch the button you want to set.**
 - [EXPOSURE]: Adjust with / and touch [OK].
 - [FADER]: Touch it repeatedly to select a desired effect (only in the CAMERA-TAPE mode).
 - : The LCD screen lights up.
To hide the buttons on the LCD screen, touch [OK].

To use the large-capacity battery pack

When you use the large-capacity battery pack (NP-QM71/QM71D/QM91/QM91D) on your camcorder, extend the viewfinder and pull it up to the optimal angle for viewing.

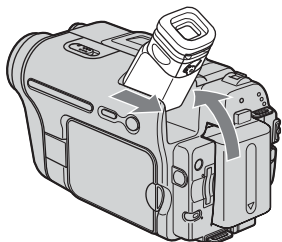

Step 5: Setting the date and time

Set the date and time when using this camcorder for the first time. If you do not set the date and time, the [CLOCK SET] screen appears every time you turn on your camcorder.

Note

- If you do not use your camcorder for about 3 months, the built-in rechargeable button-type battery gets discharged and the date and time settings may be cleared from the memory. In that case, charge the rechargeable button-type battery (p. 123) and then set the date and time again.

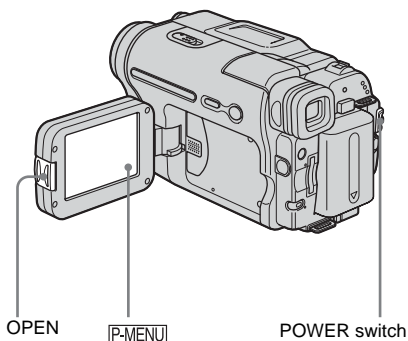

- 1 **Turn on your camcorder (p. 17).**

- 2 **Press OPEN and open the LCD panel.**
Proceed to step 7 when you set the clock for the first time.

- 3 **Touch [P-MENU].**

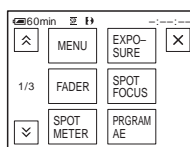

→ continued

4 Touch [MENU].

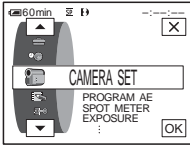

5 Select (TIME/LANGU.) with ▲/▼, then touch [OK].

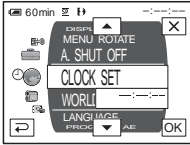

6 Select [CLOCK SET] with ▲/▼, then touch [OK].

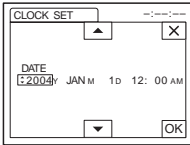

7 Set [Y] (year) with ▲/▼, then touch [OK].

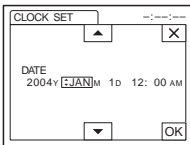

You can set any year up to the year 2079.





8 Set [M] (month), [D] (day), hour and minute in the same way as was done in step 7, then touch [OK].

For midnight, set it to 12:00AM.



For midday, set it to 12:00PM.

Step 6: Inserting the recording media

Inserting a cassette tape

You can record on standard 8 mm , Hi8  and Digital8  cassettes in Digital8  system only. For details on these cassettes (such as write-protection), see page 115.

Notes

- Do not force the cassette into the compartment. This may cause a malfunction of your camcorder.
- The recording time when you use your camcorder is half of the indicated time on Hi8  tape. If you select the LP mode in the menu settings, the recording time is 3/4 of the indicated time on Hi8  tape.

1 Slide the OPEN/EJECT lever in the direction of the arrow and open the lid.

 OPEN/EJECT lever Lid

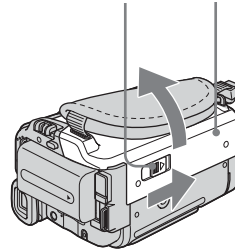

The cassette compartment automatically comes out and opens up.

2 Insert a cassette with its window-side facing up.

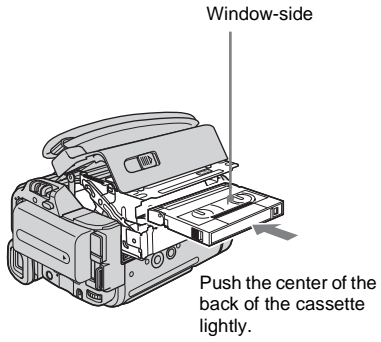

3 Press [PUSH].
The cassette compartment automatically slides back in.

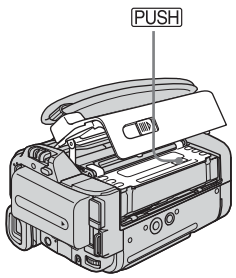

4 Close the lid.

To eject the cassette

- 1 Slide the OPEN/EJECT lever in the direction of the arrow and open the lid.**
The cassette compartment automatically comes out.
- 2 Take out the cassette, then press [PUSH].**
The cassette compartment automatically slides back in.
- 3 Close the lid.**

Inserting a "Memory Stick"

For details on the "Memory Stick" (such as write-protection), see page 116.

Note

- When using the half-sized "Memory Stick," the "Memory Stick Duo," make sure you attach the Memory Stick Duo adaptor. Your camcorder may malfunction when it is inserted without an adaptor (p. 117).

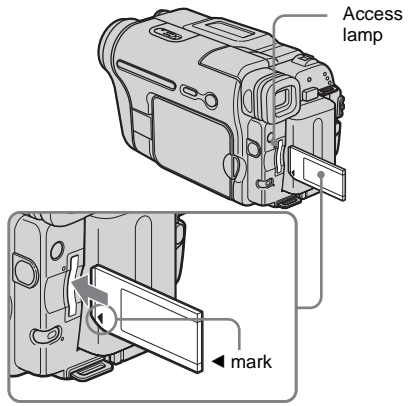

Insert the "Memory Stick" with the mark at the bottom left corner until it clicks.

To eject a "Memory Stick"

Lightly push the "Memory Stick" in once.

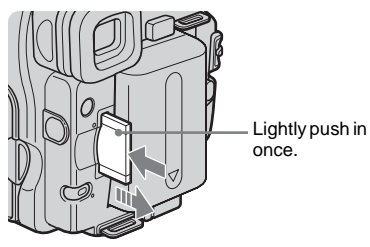

→ continued

Notes

- If you force the “Memory Stick” into the “Memory Stick” slot in the wrong direction, the “Memory Stick” slot may be damaged.
- Do not insert anything other than a “Memory Stick” into the “Memory Stick” slot. Doing so may cause a malfunction of your camcorder.
- When the access lamp is lit or flashing, your camcorder is reading/writing data from/to the “Memory Stick.” Do not shake or knock your camcorder, turn the power off, eject the “Memory Stick,” or remove the battery pack. Otherwise, image data may be damaged.

Step 7: Setting the screen language

You can select the language to be used on the LCD screen.

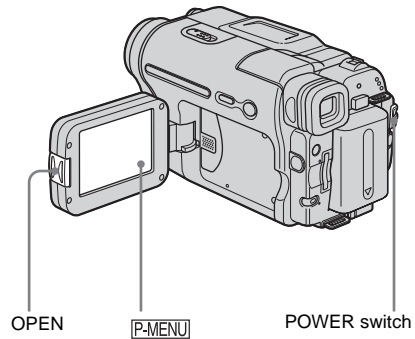

1 Turn your camcorder.

2 Press OPEN to open the LCD panel.

3 Touch [P-MENU].

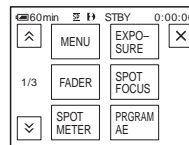

4 Touch [LANGUAGE].

If the item is not displayed on the screen, touch / . If you cannot find it, touch , and select it from the (TIME/LANGU.) menu. (p. 82)

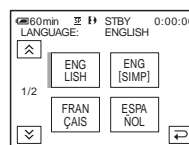

5 Select the desired language with /
, then touch .

 **Tip**

- Your camcorder offers [ENG[SIMP]](simplified English) for when you cannot find your native tongue among the options.

Recording movies

You can record movies on a tape or a “Memory Stick.”

Before recording, follow steps 1 to 7 in “Getting started” (p. 13 - p. 22).

When you are recording on a tape, movies will be recorded along with stereo sound. When you are recording on a “Memory Stick,” the movie will be recorded with monaural sound.

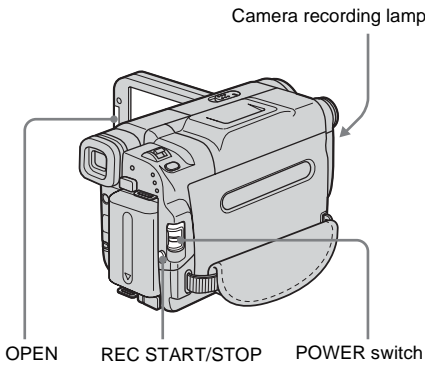

Tip

- Performing Easy Handycam operation, even first time users can record easily. For details, see page 33.

1 Remove the lens cap. Pull the lens cap string down and attach it to the grip belt.

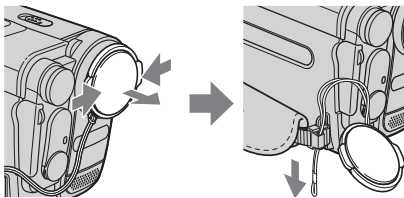

2 Press OPEN and open the LCD panel.

3 Select the recording mode.

To record on a tape

Slide the POWER switch until the CAMERA-TAPE lamp lights up, and your camcorder is set to the standby mode.

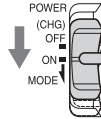

Slide the POWER switch while pressing the green button.

To record on a “Memory Stick” – MPEG MOVIE EX

Slide the POWER switch repeatedly until the CAMERA-MEMORY lamp lights up, and the currently selected recording folder appears on the screen.

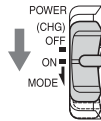

Slide the POWER switch while pressing the green button.

4 Press REC START/STOP.

Recording starts. [REC] appears on the LCD screen and the Camera recording lamp lights up. Press REC START/STOP again to stop recording.

To check the most recently recorded MPEG movie – Review

Touch . Playback starts automatically. Touch again to return to standby. To delete the movie, touch after playback is finished, then [YES]. To cancel deleting, touch [NO].

To turn the power off

Slide the POWER switch up to (CHG) OFF.

Note

- While recording movies on a “Memory Stick,” the only menu items available will be those with short cuts on the Personal Menu. In order to use other menu items, add them to the Personal Menu.

Tip

- If you do not use your camcorder for a long time, remove the cassette and store it.

Indicators displayed during recording on a tape

The indicators will not be recorded on the tape. Date/time and the camera settings data (p. 54) will not be displayed during recording.

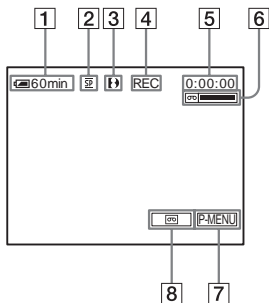

- 1 Remaining battery**
The indicated time may not be correct depending on the environment of use. When you opened or closed the LCD panel, it takes about 1 minute to display the correct remaining battery time.
- 2 Recording mode (SP or LP)**
- 3 Format indicator**
- 4 Recording status ([STBY] (standby) or [REC] (recording))**
- 5 Time code or tape counter (hour: minute: second)**
- 6 Recording capacity of the tape**
Displayed after you run the tape for a while.
- 7 Personal Menu button (p. 59)**
- 8 END SEARCH/EDIT SEARCH/Rec review display switch button (p. 44)**

Indicators displayed during recording on a “Memory Stick”

The indicators will not be recorded on the “Memory Stick.”

Date/time (p. 54) will not be displayed during recording.

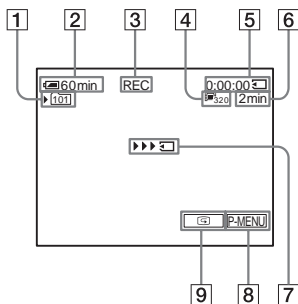

- 1 Recording folder**
- 2 Remaining battery**
The indicated time may not be correct depending on the environment of use. When you opened or closed the LCD panel, it takes about 1 minute to display the correct remaining battery time.
- 3 Recording status ([REC] (recording))**
- 4 Movie size**
- 5 Recorded time (hour: minute: second)**
- 6 Recording capacity of the “Memory Stick”**
- 7 “Memory Stick” recording start indicator (appears for about 5 seconds)**
- 8 Personal Menu button (p. 59)**
- 9 Review button (p. 24)**

Notes

- Before changing the battery pack, slide the POWER switch up to (CHG) OFF.
- In the default setting, when you do not operate the camcorder for more than about 5 minutes, the power will automatically turn off to prevent battery loss ([A.SHUT OFF], p. 81). To restart recording, slide the POWER switch down to select CAMERA-TAPE or CAMERA-MEMORY, and then press REC START/STOP.



→ continued

Tips

- To ensure smooth transition on a tape from the last recorded scene to the next, note the following.
 - Do not remove the cassette. (The picture will be recorded continuously without a break even when you turn the power off).
 - Do not record pictures in SP mode and LP mode on the same tape.
 - Avoid stopping then recording a movie in the LP mode.
- See “To record for a longer time on a “Memory Stick”” (p. 26) for the approximate length of time it is possible to record on a “Memory Stick” of different capacities.
- The recording time, date, and the camera settings data (for tape only) are recorded automatically on the recording media without being displayed on the screen. You can view this information during playback by selecting [DATA CODE] in the menu setting (p. 54).

Recording for a longer time

To record for a longer time on a tape

In the  (STANDARD SET) menu, select [ REC MODE], then [LP] (p. 76).



In the LP mode, you can record 1.5 times longer than you can when recording in the SP mode. A tape recorded in the LP mode should be played back only on this camcorder.

To record for a longer time on a “Memory Stick”

In the  (MEMORY SET) menu, select [MOVIE SET], [ IMAGE SIZE], then [160 × 112] (p. 65).

The length of time you can record on a “Memory Stick” varies depending on the image size and the recording environment. Refer to the following list for approximate length of time you can record movies on a “Memory Stick” formatted on your camcorder.

Image size and time (hour: minute: second)

	[320 × 240]	[160 × 112]
		
8MB*	00:01:20	00:05:20
16MB	00:02:40	00:10:40
32MB	00:05:20	00:21:20
64MB	00:10:40	00:42:40
128MB	00:21:20	01:25:20
256MB (MSX-256)	00:42:40	02:50:40
512MB (MSX-512)	01:25:20	05:41:20
1GB (MSX-1G)	02:50:40	11:22:40

* Supplied with DCR-TRV361 only.

Using zoom

When the CAMERA-TAPE mode is selected, you can choose zoom to magnification levels greater than 20 times, and from that point activate the digital zoom ([DIGITAL ZOOM], p. 63).

Occasional use of the zoom is effective, but use it sparingly for best results.

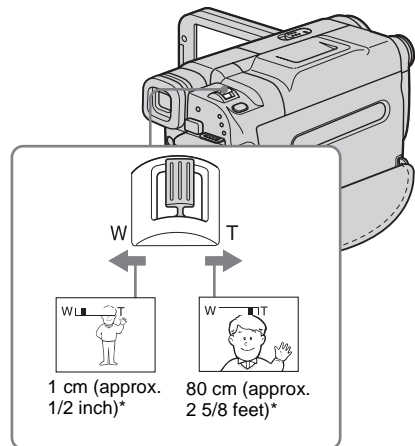

* The minimum distance required between your camcorder and the subject to get a sharp focus in that position of the lever.

Move the power zoom lever slightly for a slower zoom. Move it further for a faster zoom.

To record wider range of view

Move the power zoom lever towards W. The subject appears farther away (Wide angle).

To record closer view

Move the power zoom lever towards T. The subject appears closer (Telephoto).

Using the built-in light

You can use the built-in light to suit your shooting situation. The recommended distance between the subject and camcorder is about 1.5 m (5 feet).

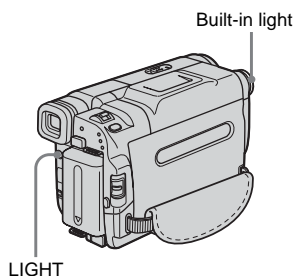

Notes

- The built-in video light emits very bright light, which is perfectly safe in normal use. However, avoid directly aiming the light at a subject's eyes from very close range.
- The battery pack discharges quickly while the built-in light is turned on.
- When you do not use your camcorder, turn the built-in light off and remove the battery pack to avoid turning on the built-in light accidentally.
- When flickering occurs while shooting in the **AE/AF LOCK** mode, press **LIGHT** until **ON** appears.
- The built-in light may turn on/off when you use the [PROGRAM AE] or backlight function while shooting in the **AE/AF LOCK** mode.
- The built-in light is turned off in the following cases:
 - While the END SEARCH function is working.
 - Interval time of Interval recording.
 - When you leave it on for more than 5 minutes with the POWER switch set to CAMERA-MEMORY.
 - When it stays on in the **AE/AF LOCK** mode for more than 5 minutes.
 - When you leave it on for more than 5 minutes with no cassette inserted or after the tape has run out.
- When you use the conversion lens (optional), light from the built-in light is blocked and may not illuminate the subject properly.

Press LIGHT repeatedly to select a setting.

The settings are displayed cyclically in the following order.

No indicator displayed: Always records without using the built-in light.



AE/AF LOCK : Automatically turns on and off according to the ambient brightness.



ON : Always turns on.

To turn off the built-in light

Press **LIGHT** repeatedly until no indicator appears on the screen.

→ *continued*

Recording in mirror mode

You can turn the LCD panel towards the subject so that you and your subject can share the image being recorded. You can also utilize this function when recording yourself, to keep the attention of small children attracted to the camcorder while you record them.

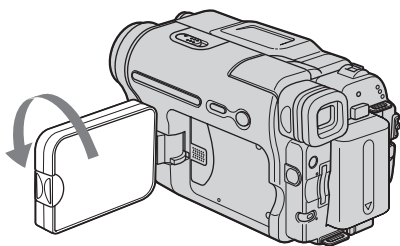

Open the LCD panel 90 degrees to the camcorder, then rotate it 180 degrees towards the subject.

A mirror-image of the subject appears on the LCD screen, but the picture will be normal when recorded.

Using the self-timer

With the self-timer, you can start recording after a delay of about 10 seconds.

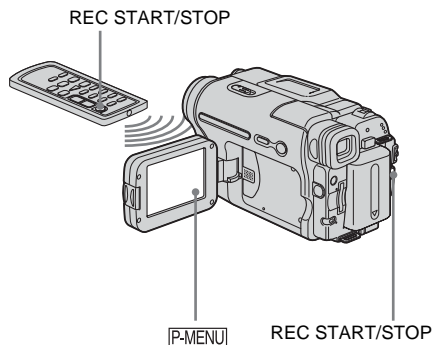

1 Touch **[P-MENU]**.

2 Touch **[SELF-TIMER]**.

If the item is not displayed on the screen, touch **[↑]/[↓]**. If you cannot find it, touch **[MENU]**, and select it from the **[CAMERA SET]** menu.

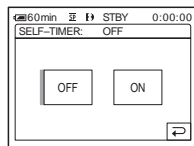

3 Touch **[ON]**, then **[OK]**.

⌚ appears.

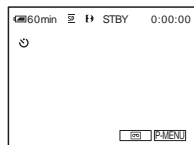

4 Press REC START/STOP.

You will hear a beep sound counting down for about 10 seconds (The count down indication begins from 8).

The recording starts.

To stop recording, press REC START/STOP.

To cancel the count down

Touch [RESET] or press REC START/STOP.

To cancel the self-timer

Follow steps 1 and 2, then select [OFF] in step 3.

Recording still images - Memory photo

recording

You can record still images on a “Memory Stick.” Before recording, follow steps 1 to 7 in “Getting started” (p. 13 - p. 22).

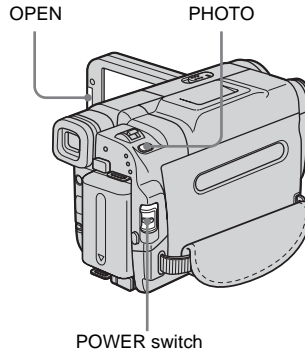

Tip

- Performing Easy Handycam operation, even first time users can record easily. For details, see page 33.

1 Remove the lens cap. Pull the lens cap string down and attach it to the grip belt.

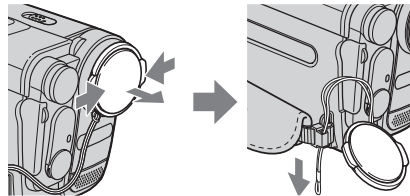

2 Press OPEN and open the LCD panel.

→ *continued*

3 Slide the POWER switch repeatedly until the CAMERA-MEMORY lamp lights up.

The selected recording folder is displayed.

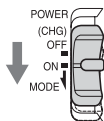

Slide the POWER switch while pressing the green button.

4 Press and hold PHOTO lightly.

You will hear a light beeping sound when the focus and brightness settings are adjusted. Recording does not start at this point.

The indicator stops flashing.

The number of images that can be recorded.*

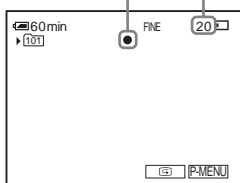



* The number of images that can be recorded varies depending on the image quality setting and the recording environment.

5 Press PHOTO fully.

A shutter sound is heard. When bars of  disappears, the image is recorded on the "Memory Stick."

To check the most recently recorded image – Review

Touch .

Touch  to return to standby.

To delete the image, touch , then [YES].

To cancel deleting, touch [NO].

To turn the power off

Slide the POWER switch up to (CHG) OFF.

To record moving subjects correcting jitter - FIELD/FRAME

Select the  (MEMORY SET) menu, [STILL SET], then .

Your camcorder compensates for camera-shake when recording moving subjects in the [FIELD] mode. Your camcorder records in high quality in the [FRAME] mode (p. 65).

Indicators displayed during recording

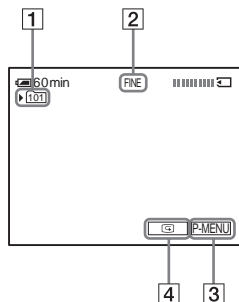

1 Recording folder

2 Quality

FINE ([FINE]) or STD ([STANDARD])

3 Personal Menu button (p. 59)

4 Review button (p. 30)



Notes

- When recording fast-moving subjects in the [FRAME] mode, the recorded image appears blurry.
- When recording in the [FRAME] mode, your camcorder may not correct camera-shake. We recommend that you shoot objects with a tripod.

Tips

- When you press PHOTO on your Remote Commander, the image displayed on the screen at that timing is recorded.
- The recording time, date, and the camera settings data are recorded automatically on the recording media without being displayed on the screen. You can view this information during playback by selecting [DATA CODE] in the menu setting (p. 54).

Selecting image quality

Select the  (MEMORY SET) menu, [STILL SET], then  [QUALITY] (p. 65). The number of pictures you can record on a “Memory Stick” varies depending on the quality of the image and the recording environment.

Refer to the following list for the approximate number of pictures that can be recorded on a “Memory Stick” formatted on your camcorder.

Image quality and number of images

The image size of [FINE] is about 150 kB, that of [STANDARD] is about 60 kB.

	[FINE] FINE	[STANDARD] STD
8MB*	50	120
16MB	96	240
32MB	190	485
64MB	390	980
128MB	780	1970
256MB (MSX-256)	1400	3550
512MB (MSX-512)	2850	7200
1GB (MSX-1G)	5900	14500

* Supplied with DCR-TRV361 only.

Tip

- The still image size is 640 × 480 dots only.

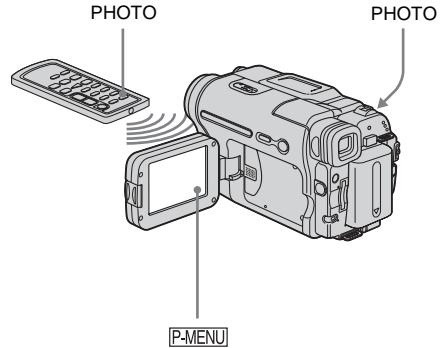

Using the self-timer

With the self-timer, you can record a still image after a delay of about 10 seconds.



1 Touch .

2 Touch [SELF-TIMER].

If the item is not displayed on the screen, touch  / . If you cannot find it, touch [MENU] and select it from the  (CAMERA SET) menu.

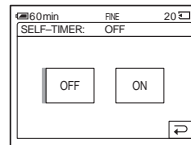

3 Touch [ON], then .

 appears.

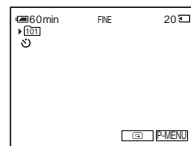

→ continued

4 Press PHOTO.

You will hear a beep sound counting down for about 10 seconds (The count down indication begins from 8).

The image is recorded. When bars of  disappears, the image is recorded on the “Memory Stick.”

To cancel the count down

Touch [RESET].

To cancel the self-timer

Follow steps 1 and 2, then select [OFF] in step 3.

Recording a still image on a “Memory Stick” while recording movies on a tape

You can record still images on a “Memory Stick.” Before recording, follow steps 1 to 7 in “Getting started” (p. 13 - p. 22).

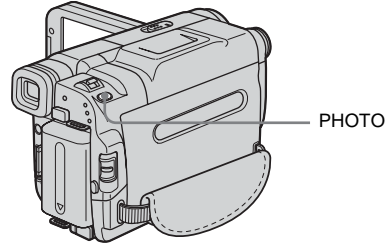

Press PHOTO fully during tape recording.

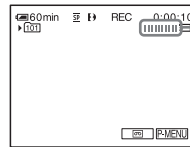

Recording is complete when the scrolling stops.

To record still images in standby mode

Press and hold PHOTO lightly. Check the image and press it fully.

Notes

- You cannot record a still image on a “Memory Stick” during the following operations:
 - [16:9 WIDE] mode
 - Memory overlap
 - MEMORY MIX function
- Titles are not recorded on a “Memory Stick.”

Recording with ease

– Easy Handycam

With this Easy Handycam operation, most of the camera settings are set to automatic mode, only basic functions become available, and screen font size increases for easy viewing. Even first time users can enjoy easy recording. Before recording, follow steps 1 to 7 in “Getting started” (p. 13 - p. 22)

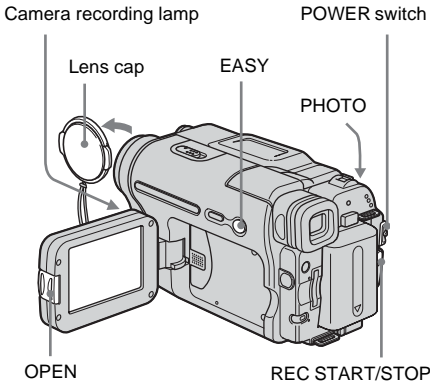

Recording a movie

During Easy Handycam operation, you can record movies on a tape only. To record movies on a “Memory Stick,” see page 24 (MPEG MOVIE EX).

- 1 Remove the lens cap. Pull the lens cap string down and attach it to the grip belt.**
- 2 Press OPEN and open the LCD panel.**

- 3 Slide the POWER switch until the CAMERA-TAPE lamp lights up.**

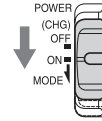

Slide the POWER switch while pressing the green button.

- 4 Press EASY.**

The EASY lights up in blue.

Easy Handycam
operation
ON

- 5 Press REC START/STOP.**

Recording starts. [REC] appears on the LCD screen and the Camera recording lamp lights up. Press REC START/STOP again to stop recording.

To turn the power off

Slide the POWER switch up to the (CHG) OFF position.

To cancel Easy Handycam operation

Press EASY again.

Notes

- You cannot turn Easy Handycam operation on or off during:
 - Recording
 - USB Streaming
- During Easy Handycam operation, BACK LIGHT (p. 35) is not available.
- During Easy Handycam operation, the settings of the functions that are not displayed on the screen return to their defaults. Previously made settings are restored when you cancel Easy Handycam operation.

→ continued

Recording a still image

1 Remove the lens cap. Pull the lens cap string down and attach it to the grip belt.

2 Press OPEN and open the LCD panel.

3 Slide the POWER switch repeatedly until the CAMERA-MEMORY lamp lights up.

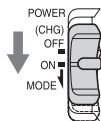



Slide the POWER switch while pressing the green button.

4 Press EASY.

The EASY lights up in blue.

5 Press and hold PHOTO lightly to adjust focus, then press fully.

A shutter sound is heard. When bars of   disappear, the image is recorded on the “Memory Stick.”

To turn the power off

Slide the POWER switch up to the (CHG) OFF position.

To cancel Easy Handycam operation

Press EASY again.

Notes

- You cannot turn Easy Handycam operation on or off during recording.
- During Easy Handycam operation, BACK LIGHT (p. 35) is not available.

- During Easy Handycam operation, the settings of the functions that are not displayed on the screen return to their defaults. Previously made settings are restored when you cancel the Easy Handycam operation.

Making full use of Easy Handycam operation

1 Touch [MENU].

The available menu items are displayed on the screen.



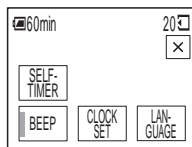

Example: In the CAMERA-MEMORY mode





2 Touch the desired item.

3 Select the desired setting.

For [CLOCK SET]

- 1 Set [Y] (year) with /, then touch .
- 2 Set [M] (month), [D] (day), hour and minutes in the same way as [Y] (year), then touch .



For [LANGUAGE]

Select the desired language with /, then touch .

For [BEEP]

See page 81.

For [SELF-TIMER] (In the CAMERA-MEMORY mode only)

Touch [ON], then . Press PHOTO fully. You will hear a beep sound counting down for about 10 seconds. When the bars of   disappear, the image is recorded on the “Memory Stick.”

Adjusting the exposure

The exposure is adjusted automatically in the default setting.

Adjusting the exposure for backlit subjects

When your subject has its back to the sun or other light, you can adjust the exposure to prevent the subject from becoming shadowed.

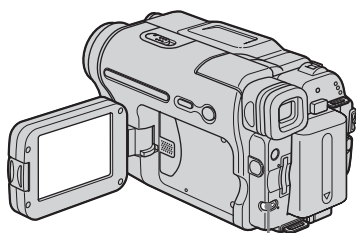

BACK LIGHT

Press BACK LIGHT during recording or in the standby mode.

 appears.

To cancel the back light function, press BACK LIGHT again.

Note



- The back light function is canceled when you set [EXPOSURE] to [MANUAL] (p. 36) or select [SPOT METER] (p. 35).

Fixing the exposure for the selected subject – Flexible spot meter

You can adjust and fix the exposure to the subject, so that it is recorded in suitable brightness even when there is strong contrast between the subject and the background (such as subjects in the limelight on stage).

1 Touch  during recording or in the standby mode.

2 Touch [SPOT METER].

If the item is not displayed on the screen, touch  / . If you cannot find it, touch [MENU], and select it from the  (CAMERA SET) menu.

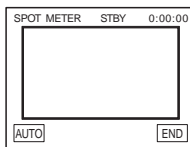

3 Touch the point you want to adjust and fix the exposure on the screen.

[SPOT METER] flashes while the camera is adjusted the exposure for the selected point.

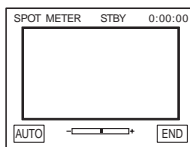

4 Touch [END].

To return the setting to automatic exposure

Follow steps 1 and 2, then select [AUTO] in step 3. Or set [EXPOSURE] to [AUTO] (p. 36).

→ continued

Notes

- You cannot use the Flexible spot meter together with:
 - Color Slow Shutter function
 - NightShot plus function
- If you set [PROGRAM AE], [SPOT METER] is automatically set to [AUTO].

Tip

- If you set [SPOT METER], [EXPOSURE] is automatically set to [MANUAL].

Adjusting the exposure manually

You can fix the brightness of a picture at the best exposure. When recording indoors on a clear day, for instance, you can avoid backlight shadows on people next to the window by manually fixing the exposure to that of the wall side of the room.

1 Touch [P-MENU] during recording or in the standby mode.

2 Touch [EXPOSURE].

If the item is not displayed on the screen, touch \uparrow/\downarrow . If you cannot find it, touch [MENU], and select it from the  (CAMERA SET) menu.

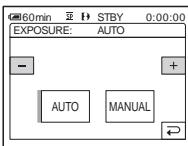

3 Touch [MANUAL].

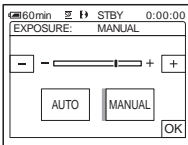

4 Adjust the exposure by touching \ominus (dim)/ \oplus (bright), then touch \square [OK].

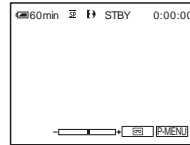

To return the setting to automatic exposure

Follow steps 1 and 2, then select [AUTO] in step 3.

Recording in dark places – NightShot plus, etc.

You can record subjects in dark places (such as when capturing the face of your baby sleeping) with the NightShot plus, Super NightShot plus or Color Slow Shutter function.

The NightShot plus and Super NightShot plus function enable you to record an image brighter and smoother.

The Color Slow Shutter function enables you to record an image more faithful to the original colors.

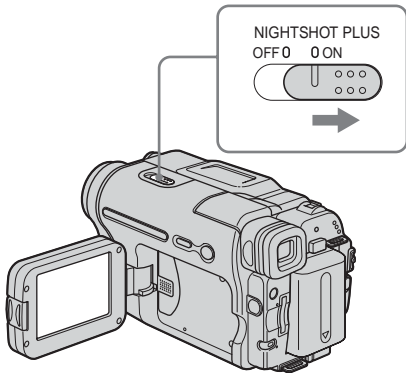

Set the NIGHTSHOT PLUS switch to ON.

and ["NIGHTSHOT PLUS"] appear.

To cancel NightShot plus, set the NIGHTSHOT PLUS switch to OFF.

To record higher sensitivity pictures on the tape – Super NightShot plus

The Super NightShot plus function enables you to use the NightShot plus function more effectively.

The picture will be recorded at a maximum of 16 times the sensitivity of NightShot plus recording.

- 1 Slide the POWER switch to select the CAMERA-TAPE mode.

- 2 Set the NIGHTSHOT PLUS switch to ON.

and ["NIGHTSHOT PLUS"] appear.

- 3 Touch .

- 4 Touch .

If the item is not displayed on the screen, touch /. If you cannot find it, touch , and select it from the (CAMERA SET) menu.

- 5 Touch , then .

appears.

To cancel Super NightShot plus, follow steps 3 and 4, then select [OFF] in step 5. Or, set the NIGHTSHOT PLUS switch to OFF.

To record a clearer picture in color on the tape – Color Slow Shutter

- 1 Slide the POWER switch to select the CAMERA-TAPE mode.

- 2 Make sure the NIGHTSHOT PLUS switch is set to OFF.

- 3 Touch .

- 4 Touch .

If the item is not displayed on the screen, touch /. If you cannot find it, touch , and select it from the (CAMERA SET) menu.

- 5 Touch , then .

appears.

To cancel Color Slow Shutter, follow steps 3 and 4, then select [OFF] in step 5.

Notes

- Do not use the NightShot plus/Super NightShot plus function in bright places. This may cause a malfunction.
- The Color Slow Shutter function may not operate correctly in total darkness. When you are recording in a place with no light at all, use the NightShot plus or Super NightShot plus functions.
- You cannot use the Super NightShot plus/Color Slow Shutter function together with:
 - FADER function
 - Digital effect
 - [PROGRAM AE]
- You cannot use the Color Slow Shutter function together with:
 - Manual exposure
 - Flexible spot meter

→ continued

- When using the Super NightShot plus or Color Slow Shutter function, the shutter speed of your camcorder changes depending on the brightness. The motion of the picture may slow down at this time.
- Adjust the focus manually when it is hard to focus automatically.
- Do not cover the infrared port with your fingers or other objects. Remove the conversion lens (optional) if it is attached.
- Depending on the shooting conditions or circumstances, colors may not be reproduced properly.

Tip

- If you record subjects in complete darkness, setting [NS LIGHT] to [ON] on the menu is recommended. The maximum shooting distance using the NightShot Light is about 3 m (10 feet). (The default setting is [ON])
If you record subjects in dark places (such as night scene or in moonlight), set [NS LIGHT] to [OFF] on the menu. You can make image color deeper (p. 62).

Adjusting the focus



The focus is adjusted automatically in the default setting.

Adjusting the focus for an off-center subject – SPOT FOCUS

You can select and adjust the focal point to aim it at a subject not located in the center of the screen.

1 Touch [P-MENU] during recording or in the standby mode.

2 Touch [SPOT FOCUS].

If the item is not displayed on the screen, touch  / . If you cannot find it, touch [MENU], and select it from the  (CAMERA SET) menu.

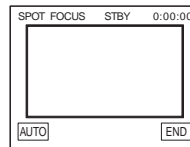

3 Touch the subject for which you want to adjust the focus on the screen.

[SPOT FOCUS] flashes while the camera is adjusting the focus.  appears.

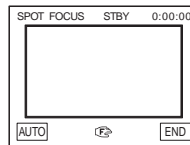

4 Touch [END].

To adjust the focus automatically

Follow steps 1 and 2, then touch [AUTO] in step 3. Or set [FOCUS] to [AUTO] (p. 39).

Note

- You cannot use the SPOT FOCUS function together with [PROGRAM AE].

Tip

- If you set [SPOT FOCUS], [FOCUS] is automatically set to [MANUAL].

Adjusting the focus manually

You can adjust the focus manually according to the recording conditions.

Use this function in the following cases.

- To record a subject behind a window covered with raindrops.
- To record horizontal stripes.
- To record a subject with little contrast between the subject and its background.
- When you want to focus on a subject in the background.

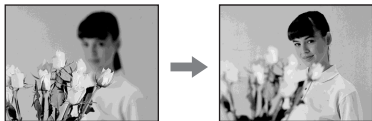

- To record a stationary subject using a tripod.

1 Touch [P-MENU] during recording or in the standby mode.

2 Touch [FOCUS].

If the item is not displayed on the screen, touch / . If you cannot find it, touch [MENU], and select it from the (CAMERA SET) menu.

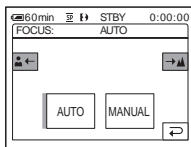

3 Touch [MANUAL].

appears.

4 Touch or to sharpen focus.

: To focus on close subjects.

: To focus on distant subjects.

changes to when the focus cannot be adjusted any further. changes to when the focus cannot be adjusted any closer.

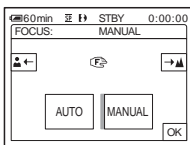

Tips for focusing manually

- It is easier to focus on the subject when you use the zoom function. Move the power zoom lever towards T (telephoto) to adjust the focus, and then, towards W (wide angle) to adjust the zoom for recording.
- When you want to record a close-up image of a subject, move the power zoom lever towards W (wide angle) to fully magnify the image, then adjust the focus.

5 Touch [OK].

To adjust the focus automatically

Follow steps 1 and 2, then touch [AUTO] in step 3.

Recording a picture using various effects

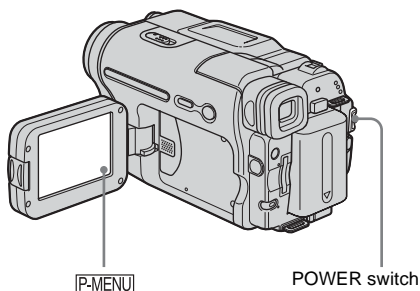

Fading in and out of a scene - FADER

You can add the following effects to currently recording pictures.



[BLACK FADER]



[WHITE FADER]



[MOSAIC FADER]



[MONOTONE]

When fading in, the picture gradually changes from black-and-white to color.

When fading out, the picture gradually changes from color to black-and-white.

[OVERLAP] (fade in only)

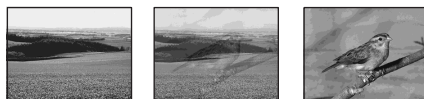

[WIPE] (fade in only)

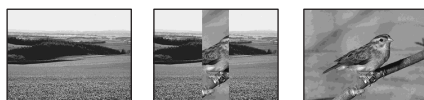

[DOT FADER] (fade in only)



1 Slide the **POWER** switch to select the **CAMERA-TAPE** mode.

2 Touch **[P-MENU]** in the standby mode (to fade in) or during recording (to fade out).

3 Touch **[FADER]**.

If the item is not displayed on the screen, touch / . If you cannot find it, touch **[MENU]**, and select it from the (PICT. APPLI.) menu.

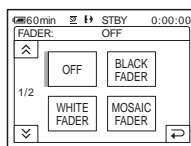

4 Touch the desired effect, then touch

[OK].

When you touch [OVERLAP], [WIPE] and [DOT FADER], the image on the tape in your camcorder is stored as a still image. (While storing the image, the screen turns to blue.)

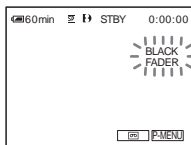

5 Press REC START/STOP.

The fader indicator stops flashing and disappears when the fade is complete.

To cancel the operation

Follow steps 2 and 3, then touch [OFF] in step 4.

Notes

- For DCR-TRV460:
The OVERLAP, WIPE and DOT FADER functions do not work with tapes recorded on other devices in the Hi8 Hi8i/standard 8 mm system.
- The title does not fade in or fade out. Erase it before operating the FADER function if it is not needed.
- You cannot use the FADER function together with:
 - Super NightShot plus function
 - Color Slow Shutter function
 - Digital effect
 - [INTERVAL REC] (Interval recording)
 - [FRAME REC] (Frame recording)
 - Self-timer

Fading in from still image on the “Memory Stick” – Memory overlap

You can fade in from the still image on the “Memory Stick” to the movie currently being recorded on the tape.

Still image



- 1 Check that you have a “Memory Stick” with the still image to be superimposed and a tape in your camcorder.

- 2 Slide the POWER switch to select the CAMERA-TAPE mode.

- 3 Touch [P-MENU].

- 4 Touch [MENU].

- 5 Select [PICT. APPLI.] (PICT. APPLI.), then touch [OVERLAP] by touching [▲]/[▼] and touch [OK].

The recorded image appears on the thumbnail screen.

- 6 Touch [–] (previous) / [+] (next) to select the still image to be superimposed.

- 7 Touch [ON], then [OK].

- 8 Touch [X].

- 9 Press REC START/STOP to start recording.

[M. OVRLAP] stops flashing, and disappears when fading is finished.

Using special effects [Digital effect]

You can add digital effects to the recordings.

[STILL]

You can record a movie while superimposing it on a previously recorded still image.



[FLASH] (flash motion)

You can record a movie with a serial-still-image effect (strobe effect).

[LUMI. KEY] (luminance key)

You can replace a brighter area in a previously recorded still image, such as the background of a person or a title written on white paper, with a movie.



→ continued

[TRAIL]

You can record a picture so that an incidental image like a trail is left.

[SLOW SHUTTR] (slow shutter)

You can slow down the shutter speed. This mode is suitable for shooting a subject more clearly in a dark place.

[OLD MOVIE]

You can add an old movie-type atmosphere to pictures. Your camcorder automatically records pictures in the letterbox mode for all screen size, sepia in color, and at a slower shutter speed.

1 Slide the **POWER** switch to select the **CAMERA-TAPE** mode.

2 Touch **[P-MENU]**.

3 Touch **[D.EFFECT]**.

If the item is not displayed on the screen, touch \uparrow/\downarrow . If you cannot find it, touch **[MENU]**, and select it from the [PICT.] (**APPLI.**) menu.

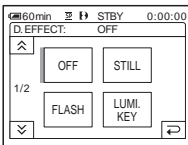

4 Touch the desired effect, then adjust the effect by touching $-$ (decrease) / $+$ (increase) and touch **[OK]**.

Adjustment screen example:

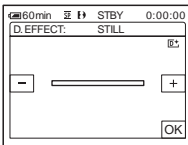

When you touch **[STILL]** or **[LUMI. KEY]**, the image displayed on the screen at that time is saved as a still image.

Effect	Items to adjust
[STILL]	The degree of transparency of the still image you want to superimpose on a movie.
[FLASH]	The interval of frame-by-frame playback.
[LUMI. KEY]	The color scheme of the area in the still image which is to be swapped with a movie.
[TRAIL]	The fade time of the incidental image.
[SLOW SHUTTR]*	Shutter speed (1 is 1/30, 2 is 1/15, 3 is 1/8, 4 is 1/4).
[OLD MOVIE]	No adjustment necessary.

* It is hard to adjust the focus automatically when you choose this effect. Adjust the focus manually using a tripod to steady the camcorder.

5 Touch **[OK]**.
 [D]* appears.

To cancel Digital effect

Follow steps 2 and 3, then select **[OFF]** in step 4.

Notes

- You cannot use Digital effect together with:
 - Super NightShot plus function
 - Color Slow Shutter function
 - FADER function
 - Memory overlap
 - MEMORY MIX function
- You cannot use **[SLOW SHUTTR]/[OLD MOVIE]** together with **[PROGRAM AE]** (except **[AUTO]**).
- You cannot use **[OLD MOVIE]** together with:
 - **[16:9 WIDE]** mode
 - Picture effect (**[PICT. EFFECT]**)

Tip

- You can create a picture with color and brightness reversed or a picture that looks like a pastel drawing while recording on a tape. For details, refer to the Picture effect (**[PICT. EFFECT]**, p. 68).

Overlaying still images on movies on a tape – MEMORY MIX

You can superimpose a still image you have recorded on a “Memory Stick” over the movie you are currently recording on a tape. You can then record the superimposed pictures on a tape or a “Memory Stick.” (You cannot superimpose a still image on a tape which you have already finished recording.)

[M←CAM LUMI.] (Memory Luminance key)

You can swap the brighter (white) area of a still image into a movie. To use this function, have a still image of an illustration or title handwritten on white paper recorded on a “Memory Stick” beforehand.



[CAM←M CHROMA] (Camera Chroma key)

You can superimpose a movie on top of a still image, such as an image which can be used as background. Shoot the movie with the subject against a blue background. Only the blue area of the movie will be swapped with the still image.

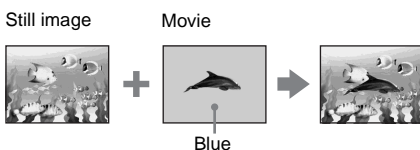

[M←CAM CHROMA] (Memory Chroma key)

You can have the movie swap into the blue area of a still image such as an illustration or into a frame with a blue area enclosed by the frame.

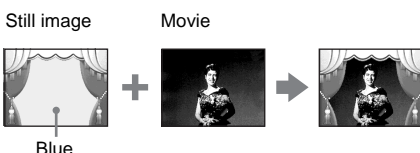

- 1 Check that you have a “Memory Stick” with the still image to be superimposed and a tape (only if you are recording on tape) in your camcorder.

- 2 Slide the **POWER** switch repeatedly to select the **CAMERA-TAPE** mode (when you are recording on a tape) or the **CAMERA-MEMORY** mode (when you are recording on a “Memory Stick”).

- 3 Touch [P-MENU].

- 4 Touch [MEMORY MIX].

If the item is not displayed on the screen, touch \uparrow / \downarrow . If you cannot find it, touch [MENU], and select it from the PICT. APPLI. menu.

The still image stored in the “Memory Stick” will be displayed on the thumbnail screen.

Thumbnail screen

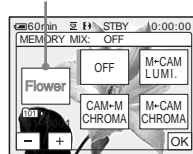

- 5 Touch $-$ / $+$ to select the still image to overlap.

- 6 Touch the desired effect.

The still image is superimposed on the movie which is currently displayed on the LCD screen.

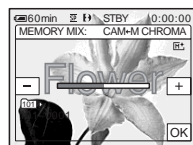

→ continued

-
- 7 Touch (decrease)/ (increase) to adjust the following.

For [M←CAM LUMI.]

The color scheme of the bright area in the still image which is to be swapped into a movie. When you want to record only the still image stored on the “Memory Stick” to a tape, touch on the screen in [M←CAM LUMI.] until the bar indicator is extended fully to the right side.

For [CAM←M CHROMA]

The color scheme of the blue area in the movie.

For [M←CAM CHROMA]

The color scheme of the blue area in the still image which is to be swapped into a movie.

-
- 8 Touch twice.

appears.

-
- 9 Start recording.

When you are recording on a tape

Press REC START/STOP.

When you are recording on a “Memory Stick”

Press PHOTO fully.

To cancel MEMORY MIX

Follow steps 1 to 4, then touch [OFF] in step 5.

Notes

- When the overlapping still image has a large amount of white, the image in the thumbnail screen may not be clear.
- When you use the MEMORY MIX function in the mirror mode (p. 28), the picture on the LCD screen appears normally, without being mirror-reversed.
- You may not be able to play back pictures modified on your computer or recorded with other camcorders on your camcorder.

Tip

- The supplied SPVD-012 USB Driver CD-ROM contains sample images for use in MEMORY MIX operations. Refer to the supplied “Computer Applications Guide” for details.

Searching for the starting point

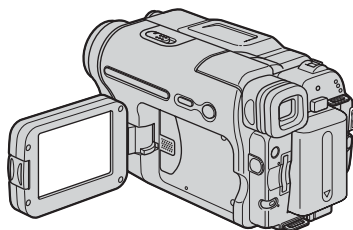

POWER switch

Searching for the last scene of the most recent recording – END SEARCH

This function is handy when you have played back the tape, for example, but want to start recording right after the most recently recorded scene. The END SEARCH function will not work once you eject the cassette after you have recorded on the tape.

-
- 1 Slide the POWER switch repeatedly to select the CAMERA-TAPE mode.

-
- 2 Touch

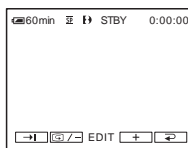

-
- 3 Touch .

The last scene of the most recent recording is played back for about 5 seconds, and the camcorder enters the standby mode at the point where the last recording has finished.

To cancel the operation

Touch [CANCEL].

Notes

- The END SEARCH function will not work correctly when there is a blank section between recorded sections on the tape.
- For DCR-TRV460:
The END SEARCH function does not work for the tapes recorded on other devices in the Hi8 Hi8 / standard 8 mm 8 system.

Tip

- You can do this operation also by selecting [END SEARCH] in the menu setting. When PLAY/EDIT mode is selected, you can do this operation by selecting [END SEARCH] short-cut on [P.MENU]. (p. 59)



Searching manually – EDIT SEARCH

You can search for the start point while viewing the pictures on the screen. The sound is not played back during the search.

- Slide the POWER switch to select the CAMERA-TAPE mode.

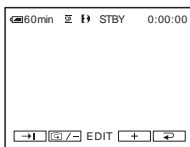
- Touch .



- Keep touching  (to go backward) /  (to go forward) and release it at the point where you want the recording to start.

Note

- For DCR-TRV460:
The EDIT SEARCH function does not work for the tapes recorded on other devices in the Hi8 Hi8 / standard 8 mm 8 system.

Reviewing the most recently recorded scenes – Rec review

You can view a few seconds of the scene recorded just before you stopped the tape.

- Slide the POWER switch repeatedly to select the CAMERA-TAPE mode.

- Touch .

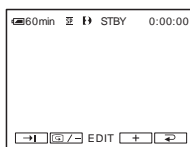

- Touch  once.

The last few seconds of the most recently recorded scene are played back. Then, your camcorder is set to the standby mode.

Note

- For DCR-TRV460:
The Rec review function does not work for the tapes recorded on other devices in the Hi8 Hi8 / standard 8 mm 8 system.

Viewing movies recorded on a tape

Make sure you have a recorded cassette inserted into your camcorder. Some of the operations are possible using the Remote Commander or using the touch panel. When you want to play back recordings on your TV, see page 56.

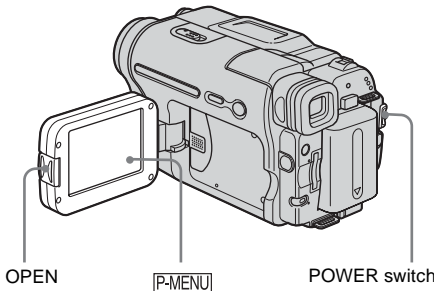

Tip

- Performing Easy Handycam operation, even first time users can play back easily. For details, see page 51.

1 Press OPEN and open the LCD panel.

2 Slide the POWER switch repeatedly to select the PLAY/EDIT mode.

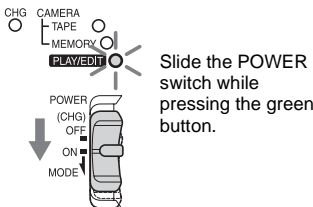





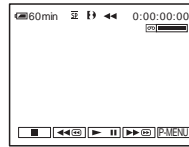

Slide the POWER switch while pressing the green button.

3 Touch (rewind) to go to the point you want to view.



4 Touch (play) to start playback.

To adjust the volume

- Touch .
- Touch **[VOLUME]**. If the item is not displayed on the screen, touch  / . If you cannot find it, touch **[MENU]**, and select it from the  (STANDARD SET) menu.
- Adjust the volume by touching  (decrease) /  (increase), then touch .



To stop playback

Touch  (stop).

To pause

Touch  (pause) during playback. Touch it again to restart the playback. Playback stops automatically when the pause mode continues for more than certain period.

To fast forward or rewind

Touch  (fast forward) or  (rewind) in stop mode.

To review movies on the viewfinder

Close the LCD panel.

Indicators displayed during tape playback

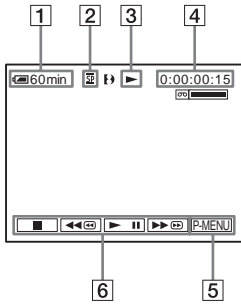

- 1 Remaining battery
- 2 Recording mode (SP or LP)
- 3 Tape transport indicator
- 4 Time code (hour: minute: second: frame) or tape counter (hour: minute: second)
- 5 Personal Menu button (p. 59)

6 Video operation buttons

When a “Memory Stick” has been inserted, (stop) changes to (“Memory Stick” playback) when you stop playback.

Tip

- For DCR-TRV460:
When you play back tapes recorded on other devices in the Hi8 /standard 8 mm system, the tape counter appears on the screen.

Playing back in various modes

To fast forward or rewind during playback – Picture search

Keep on touching (fast forward) or (rewind) during playback.

To resume normal playback, release the button.

To view the picture while fast forwarding or rewinding – Skip scan

Keep on touching (fast forward) or (rewind) while fast forwarding or rewinding the tape.

To resume fast forwarding or rewinding, release the button.

To play back in various modes

You will not hear the recorded sound. Also, you may see mosaic-like images of the previously played picture remaining on the screen when playing back in the Digital8 system.

For DCR-TRV460:

Noise may appear when your camcorder plays back tapes recorded on other devices in the Hi8 /standard 8 mm system.

1 During playback or playback pause, touch .

2 Touch .

If the item is not displayed on the screen, touch /. If you cannot find it, touch , and select it from the (EDIT/PLAY) menu.

3 Select a playback mode.

To return to the normal playback mode, touch (play/pause) twice (once from frame playback).

To	Touch
change the playback direction*	(frame) during playback.
play back slowly**	(slow) during playback. To reverse direction 1 Touch (frame). 2 (slow).
play back 2 times faster (double speed)	(double speed) during playback. To reverse direction 1 Touch (frame). 2 (double speed).
play back frame by frame	(frame) during playback pause. To reverse direction, touch (frame) again during frame playback.

* Horizontal lines may appear at the top, bottom, or in the center of the screen. This is not a malfunction.

** Pictures output from the DV Interface cannot be played back smoothly in slow mode.

4 Touch , then .

→ continued

Viewing recordings with added effects – Digital effect

You can apply [STILL], [FLASH], [LUMI. KEY], and [TRAIL] effects when viewing recorded pictures. For details on each effect, see page 41.

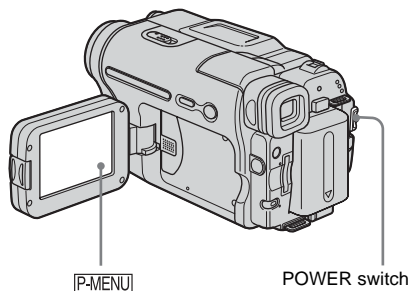

To cancel Digital effect

Follow steps 2 to 4, then select [OFF] in step 5.

⚠ Notes

- You cannot add effects to externally input pictures. Also, you cannot output pictures edited with digital effects via the DV Interface.
- For DCR-TRV460:
The Digital effect function does not work with tapes recorded on other devices in the Hi8 Hi8/standard 8 mm system.

💡 Tip

- You cannot record the pictures edited using special effects on the tape in your camcorder, but you can copy them to a “Memory Stick” (p. 89) or another tape (p. 87).

1 Slide the **POWER** switch repeatedly to select the **PLAY/EDIT** mode.

2 Touch **[P-MENU]** while the picture you want to add the effect to is displayed.

3 Touch **[MENU]**.

4 Select **[PICT. APPL.]**, then **[D. EFFECT]** by touching **[▲]**/**[▼]** and **[OK]**.

5 Select an effect, then adjust the effect by touching **[–]** (decrease)/**[+]** (increase).

6 Touch **[OK]** twice, then **[X]**.
[D*] appears.

Viewing recordings on a “Memory Stick”



You can view pictures one at a time on the screen. When you have a lot of pictures, you can list them to search through them easily. Make sure you have a recorded “Memory Stick” inserted into your camcorder. When you want to play back a recorded picture on your TV, see page 56.

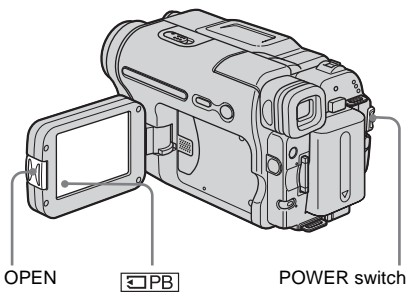

Tip

- Performing Easy Handycam operation, even first time users can play back easily. For details, see page 51.

1 Press OPEN and open the LCD panel.

2 Slide the POWER switch repeatedly to select the PLAY/EDIT mode.

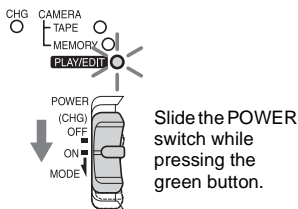

3 Touch [PB].

The most recently recorded picture appears on the screen.

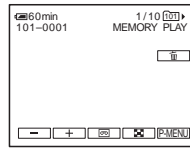

4 Touch [] (previous) / [] (next) to select a picture.

Screen example (movies):

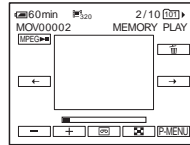

When you view a movie, touch [MPEG▶] when the selected movie appears on the screen.

To adjust the volume of movies

1 Touch [P-MENU].

2 Touch [VOLUME].

If the item is not displayed on the screen, touch [▲] / [▼]. If you cannot find it, touch [MENU], and select it from the [STANDARD SET] menu.

3 Adjust the volume by touching [] (decrease) / [] (increase), then touch [OK].

To stop or pause movies

Touch [MPEG▶]. Touch it again to restart the playback.

To delete pictures

See “Deleting recorded pictures” (p. 98).

Note

- While playing back movies on a “Memory Stick,” the only menu items available will be those with short cuts on the Personal Menu. In order to use other menu items, add them to the Personal Menu.

→ continued

Indicators displayed during “Memory Stick” playback

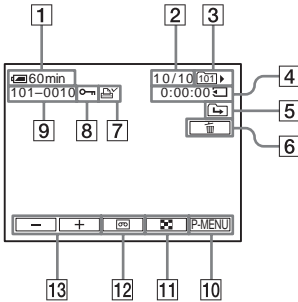

- 1 Remaining battery
- 2 Picture number/Total number of recorded pictures in the current playback folder
- 3 Playback folder
- 4 Playing time (movies only)
- 5 Previous/next folder icon

The following indicators appear when the first or last picture of the current folder is displayed and when there are multiple folders on the same “Memory Stick.”

← : Touch to move to the previous folder.

→ : Touch to move to the next folder.

⏪ : Touch / to move to either the previous or the next folder.

- 6 Image delete button
- 7 Print mark (still images only) (p. 99)
- 8 Image protection mark (p. 99)
- 9 Data file name
- 10 Personal Menu button
- 11 Index screen display button
- 12 Tape playback select button
- 13 Picture select button

Note

- Folders that you have created on a computer, renamed folders, and modified pictures may not appear on the screen.

Tip

- Once you record a picture in a folder, the same folder will be set as the default folder for playback. You can select a playback folder in the menu (p. 67).

Playing back in various modes from a “Memory Stick”

Using the screen in step 4 in “Viewing recordings on a “Memory Stick”” (p. 49), the following operations are available.

To search for a scene in a movie

You can divide a movie into a maximum of 60 scenes in order to start playback from a particular scene. The number of scenes you can divide the movie into depends on the length of the movie.

- 1 Touch (previous)/ (next) to select a scene from which to start the playback.

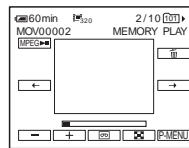

- 2 Touch .

To display 6 pictures at a time, including movies – Index Screen

Touch .

Previous
6 pictures

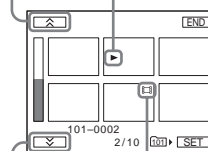





Next
6 pictures

- * The picture displayed before switching to the index screen.

To return to the single display mode, touch the picture that you want to display.

To view pictures in other folders in the index screen

- 1 Touch .
- 2 Touch .
- 3 Touch [PB FOLDER].
- 4 Select a folder with /, then touch .

Playing back with ease – Easy Handycam

Easy Handycam operation allows easy playback for even first time users by providing only the basic functions for playback. Also screen font size increases for easy viewing. Make sure you have a recorded cassette or a recorded “Memory Stick” inserted into your camcorder.

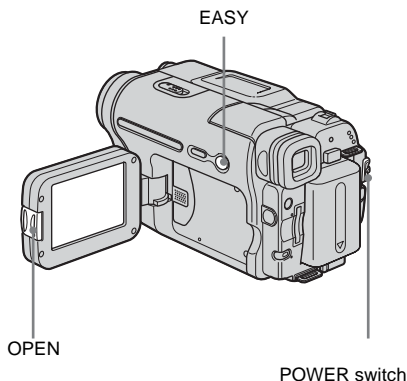

- 1 Press **OPEN** and open the LCD panel.
- 2 Slide the **POWER** switch repeatedly until the **PLAY/EDIT** lamp lights up.

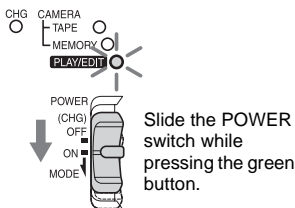

- 3 Press **EASY**.
EASY lights up in blue.

→ *continued*

4 Play back a picture.

When playing back on a tape

The following buttons can be operated.

(play/pause)/ (fast forward)/
 (stop)/ (rewind)

You can operate these operations and SLOW on the Remote Commander.

When playing back on a “Memory Stick”

Touch [PB].

The following buttons can be operated.

/ / /

You can control playback with the Remote Commander.

2 Set [M] (month), [D] (day), hour and minutes in the same way as [Y] (year), then touch [OK].

For [LANGUAGE]

Select the desired language with / , then touch [OK].

For [BEEP]

See page 81.

For [VOLUME]

Adjust the volume by touching (decrease)/ (increase), then touch [OK].

For [DATA CODE]

You can display the date/time during playback.

Touch [DATE/TIME], then touch [OK].

For [ALL ERASE]

You can delete all the images on the “Memory Stick.”

Touch [YES].

To cancel Easy Handycam operation

Press EASY again.

Note

- You cannot turn Easy Handycam operation on or off during communication with another device via USB cable.

Making full use of Easy Handycam operation

1 Touch [MENU].

The available menu items are displayed on the screen.

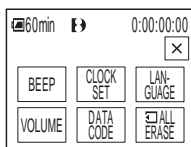

2 Touch the desired item.

3 Select the desired setting.

For [CLOCK SET]

1 Set [Y] (year) with / , then touch [OK].

Tip

- During Easy Handycam operation, you can also do the following:
 - “Playing the picture on a TV” (p. 56)
 - “Dubbing to another tape” (p. 87)

Various playback functions

You can magnify a small subject in a recording and display it on the screen. You can also display the recorded date and the name of the folder in which the picture is recorded.

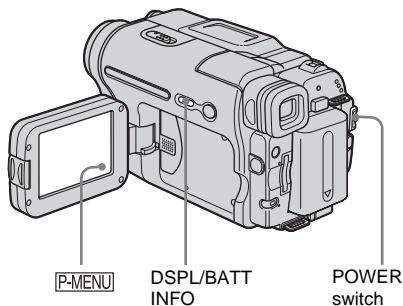

Magnifying pictures – Tape playback zoom/Memory playback zoom

You can magnify movies recorded on a tape or still images stored on a “Memory Stick.”

- 1 Slide the **POWER** switch repeatedly to select the **PLAY/EDIT** mode.
- 2 Touch **[P-MENU]**.
- 3 Touch **[MENU]**.

- 4 Select **[PICT. APPLI.]**, then **[PB ZOOM]** by touching **[▲/▼]** and **[OK]**.

Tape playback zoom screen

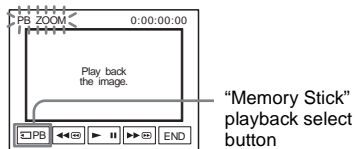

Memory playback zoom screen

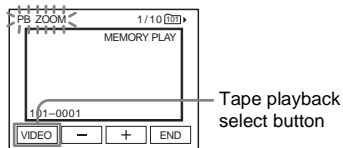

- 5 Play back the still picture or movie, and touch the screen at the point you want to magnify within the displayed frame.

The picture is magnified approximately twice the original size and centered at the point you touched on the screen. When you touch another place, the point you touched becomes the center.

- 6 Adjust the zoom ratio using the power zoom lever.

You can select the zoom ratio from approximately 1.1 to 5 times the original size. Touch **W** to decrease, or **T** to increase the ratio.

To cancel the operation

Touch **[END]**.

Note

- You cannot magnify externally input pictures. Also, you cannot output the magnified pictures recorded on a tape in the Digital8 system or on a “Memory Stick” via the DV Interface.

💡 Tip

- If you press DSPL/BATT INFO during the playback zoom operation, the frame will disappear.

Displaying the screen indicators

You can choose to display the time code, tape counter, and other information on the screen.

Press DSPL/BATT INFO.

The indicators appear/disappear as you press the button.

💡 Tip

- You can display the screen indicators during playback on a TV. Select the  (STANDARD SET) menu, [DISPLAY], then [V-OUT/PANEL] (p. 81).



Displaying the date/time and camera settings data – Data code

During playback, you can view the date/time data and the camera settings data ([CAMERA DATA]) that are automatically recorded while recording pictures on a tape or a “Memory Stick.”

1 Slide the POWER switch repeatedly to select the PLAY/EDIT mode.

2 Touch [P-MENU] during playback or playback pause.

3 Touch [DATA CODE].

If the item is not displayed on the screen, touch  / . If you cannot find it, touch [MENU], and select it from the  (STANDARD SET) menu.

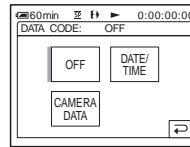

4 Select [CAMERA DATA] or [DATE/TIME] then touch [OK].

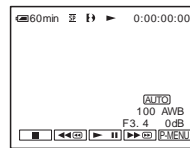

To hide the date/time or the camera settings data

Follow steps 2 and 3, and select [OFF] in step 4.

Camera settings data display

In the date/time data display, the date and time is displayed in the same area.

If you record the picture without setting the clock, [--- --:---] and [--:--:---] will appear.

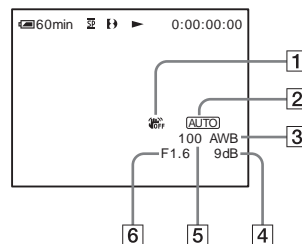

1 SteadyShot off*

2 Exposure*

3 White balance*

4 Gain*

5 Shutter speed

6 Aperture value

* Appears only during tape playback

🔊 Notes

- Camera setting data do not appear when movies on a “Memory Stick” are played back.
- For DCR-TRV460:
The data code function does not work with tapes recorded on other devices in the Hi8 **Hi8**/standard 8 mm **8** system.

💡 Tip

- Exposure adjustment value (0EV) appears when a “Memory Stick” is played back.

Playing the picture on a TV

Connect your camcorder to a TV using the supplied A/V connecting cable as shown in the following illustration. Connect the supplied AC Adaptor to the wall outlet for the power supply (p. 14). Refer also to the instruction manuals supplied with the devices to be connected. To copy to another tape, see page 87.

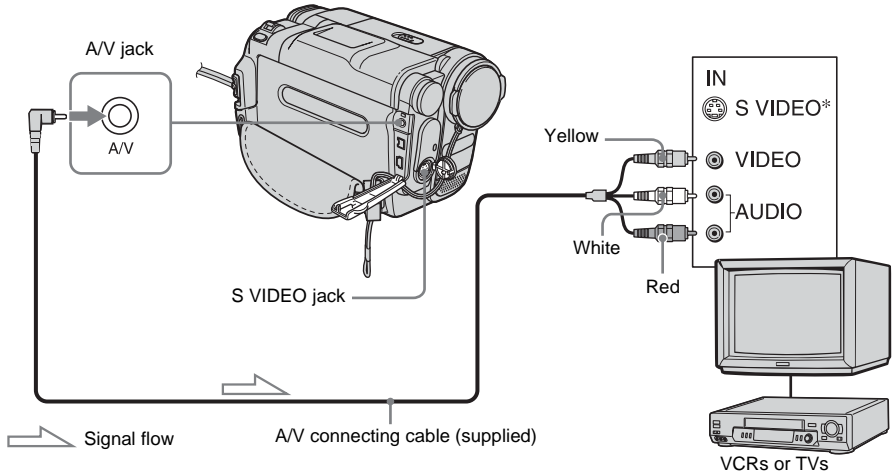

* Pictures can be reproduced more faithfully by using an S video cable (optional). When there is an S video jack on the device to be connected, connect the S video plug to that jack instead of using the yellow video plug. The audio will not be output when you connect with the S video plug alone.

When your TV is connected to a VCR

Connect your camcorder to the LINE IN input on the VCR using the A/V connecting cable. Set the input selector on the VCR to LINE.

When your TV is monaural (When your TV has only one audio input jack)

Connect the yellow plug of the A/V connecting cable to the video input jack and connect the white (left channel) or the red (right channel) plug to the audio input jack of your TV or VCR. When you want to play the sound in monaural mode, use a connecting cable (optional) for that purpose.

Locating a scene on a tape for playback

Searching quickly for a desired scene – Zero set memory

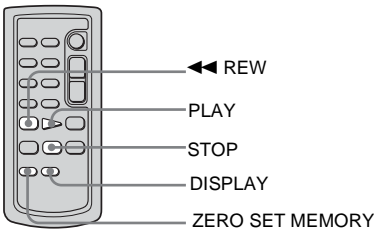

- 1 **During playback, press ZERO SET MEMORY on the Remote Commander at the point you want to locate later on.**

The tape counter is reset to “0:00:00” and **→0←** appears on the screen.

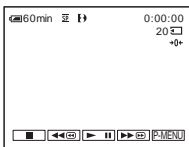

If the tape counter is not displayed, press DISPLAY on the Remote Commander.

- 2 **Press  (stop) when you want to stop playback.**

- 3 **Press  REW.**

The tape stops automatically when the tape counter reaches “0:00:00.”



- 4 **Press PLAY.**

The playback starts from the point designated “0:00:00” on the tape counter.

To cancel the operation

Press ZERO SET MEMORY on the Remote Commander again.

Notes

- There may be a discrepancy of several seconds between the time code and the tape counter.
- Zero set memory will not function correctly if there is a blank section between recorded sections on the tape.
- For DCR-TRV460:
The zero set memory function does not work with tapes recorded on other devices in the Hi8  / standard 8 mm  system.

Searching for a scene by date of recording – Date search

You can locate the point where the recording date changes.

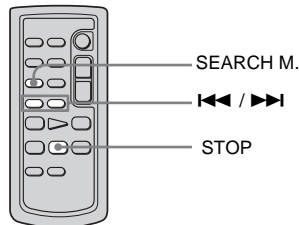

- 1 **Slide the POWER switch repeatedly to select the PLAY/EDIT mode.**

- 2 **Press SEARCH M. on the Remote Commander repeatedly to select [DATE SEARCH].**

→ continued

3 Press ◀◀ (previous)/▶▶ (next) on the Remote Commander to select a recording date.



Playback starts automatically from the point where the date changes.

Each time you press the button, the previous or the next date will be searched for and displayed.

To cancel the operation

Press STOP on the Remote Commander.

Notes

- If one day's recording is less than 2 minutes, your camcorder may not accurately find the point where the recording date changes.
- The Date search will not function correctly when there is a blank section between recorded sections on the tape.
- For DCR-TRV460:
The date search function does not work with tapes recorded on other devices in the Hi8 /standard 8 mm  system.





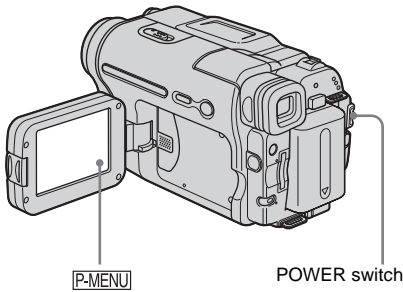

►Advanced operations

Using the Menu

Selecting menu items

You can change various settings or make detailed adjustments using the menu items displayed on the screen.



-  CAMERA SET (p. 61)
-  MEMORY SET (p. 65)
-  PICT. APPLI. (p. 68)
-  EDIT/PLAY (p. 73)
-  STANDARD SET (p. 76)
-  TIME/LANGU. (p. 82)

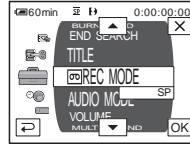

1 Turn on the power (p. 17).

2 Touch [P-MENU].

The Personal Menu appears. Item that are used often are displayed as short-cuts.

Example: PLAY/EDIT mode's Personal Menu

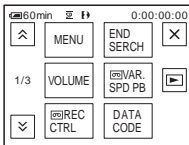

3 Touch [MENU] to display the menu index screen.

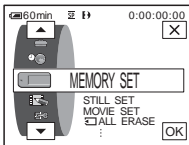

4 Select the icon of the desired menu with ▲/▼, then touch [OK].

5 Select the desired item with ▲/▼, then touch [OK].



You can also touch the item directly to select it.

You can scroll and see all items. The available items vary depending on the power mode of your camcorder.

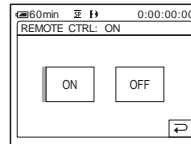
Unavailable items will be grayed out.



6 Select the desired setting.

 changes to . If you decide not to change the setting, touch  to return to the previous screen.

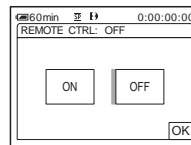



→continued

7 Touch , then  to hide the menu screen.



You can also touch  (return) to go back a screen each time you touch the button.

To use the short-cuts of the Personal Menu

The available items vary depending on the power mode of your camcorder. Unavailable items will be grayed out. You can customize the short-cuts (p. 83).

- 1 Touch .**
- 2 Touch the desired item.**
- 3 Select the desired setting, then touch .**

Tips

- When the PLAY/EDIT mode is selected, touch  on the screen displayed after step 2 (p. 59) to display the video operation screen. Touch  to return to the previous screen.
- It is convenient if the items you often use appear as short-cuts on the Personal Menu. To customize the Personal Menu, see page 83.

Using the (CAMERA SET) menu

– PROGRAM AE/16:9 WIDE, etc.

You can select items listed below on the CAMERA SET menu. To select items, see “Selecting menu items” (p. 59).





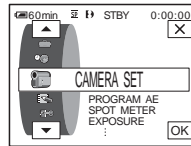







The default settings are marked with ▷. The indicators in parentheses appear when the

setting is selected. The settings you can adjust vary depending on the power mode of your camcorder. The screen shows the items you can currently operate. Unavailable items will be grayed out.



PROGRAM AE

You can record pictures easily in a situation that requires various techniques by selecting the following settings.

▷ AUTO	Select this when not using PROGRAM AE.	
SPOTLIGHT* (spotlight) ()	Select to prevent people's faces from appearing excessively white when subjects are lit by strong light, such as in a theater or at a wedding.	
PORTRAIT (soft portrait) ()	Select to bring out the subject such as people or flowers while creating a soft background.	
SPORTS* (sports lesson) ()	Select to minimize shake when shooting fast-moving subjects such as in tennis or golf.	
BEACH&SKI* (beach & ski) ()	Select to prevent people's faces from appearing dark in strong light or reflected light, such as at a beach in midsummer or on a ski slope.	
SUNSET&MOON** (sunset & moon) ()	Select to maintain the atmosphere of situations such as sunsets, general night views, fireworks, and neon signs.	
LANDSCAPE** (landscape) ()	Select when shooting distant subjects such as mountains. This setting also prevents your camcorder from focusing on glass or metal mesh in windows that comes in between the camcorder and the subject.	

* Your camcorder is adjusted to focus only on subjects in the middle to far distance.

→ continued

**Your camcorder is adjusted to focus only on distant subjects.

SPOT METER

See page 35 for details.

EXPOSURE

See page 36 for details.

AUTO SHUTTER

▷ON	Select to automatically activate the electronic shutter to adjust the shutter speed when recording in bright conditions.
OFF	Select when recording without using the electronic shutter.

SPOT FOCUS

See page 38 for details.

FOCUS

See page 39 for details.

SUPER NSPLUS

See page 37 for details.

NS LIGHT

When using the NightShot plus function to record, you can record clearer pictures by using the NightShot Light to emit infrared rays (invisible).

▷ON	Select to use the NightShot Light (p. 37).
OFF	Select to disable the NightShot Light (p. 37).

COLOR SLOW S

See page 37 for details.

SELF-TIMER

See page 28, 31 for details.

DIGITAL ZOOM

You can select the maximum zoom level in case you want to zoom to a level greater than 20 times while recording on a tape. Note that the image quality decreases when you are using the digital zoom. This function is useful when recording enlarged pictures of a distant subject, such as a bird.



The right side of the bar shows the digital zooming zone.
The zooming zone appears when you select the zooming level.

▷OFF	Select to deactivate the digital zoom. Up to 20 times zoom is performed optically.
40 ×	Select to activate the digital zoom. 20 times through 40 times zoom is performed digitally.
990 ×	Select to activate the digital zoom. 20 times through 990 times zoom is performed digitally.

16:9 WIDE

You can record a 16:9 wide picture on the tape to watch on a 16:9 wide-screen TV ([16:9 WIDE] mode).

With this function [ON], your camcorder offers even wider angles when you move the power zoom lever to the “W” side than recording in [OFF].

When you connect your camcorder to a TV compatible with the ID-1/ID-2 system and play the tape, the TV switches to full mode automatically.

Refer also to the manuals supplied with your TV.

When viewed on the LCD screen



When viewed on a 16:9 wide screen TV*



When viewed on a standard TV**



→ continued

- * Picture appears in full screen when the wide-screen TV switches to full mode.
- **Played in 4:3 mode. When you play a picture in the wide mode, it appears as you have seen on the LCD screen.

▷OFF	Standard setting (to record pictures to play back on a 4:3 TV). The recorded picture will not be wide.
ON ()	Select to record a picture to be played back on a 16:9 wide TV. The recorded picture will be played in full mode when you connect to your TV compatible with ID-1/ID-2 systems.

Tips

- The SteadyShot does not work. If you set [16:9 WIDE] to [ON] in the menu settings when the SteadyShot is working,  flashes and the SteadyShot does not function.
- The ID-1 system sends aspect ratio information (16:9, 4:3, or letter box) by inserting signals between video signals.
- The ID-2 system sends a copyright protection signal with the ID-1 signals inserted between video signals in an analog connection.

STEADYSHOT

You can select this function to compensate for camera-shake.

▷ON	Standard setting (enable the SteadyShot function).
OFF ()	Select to deactivate the SteadyShot function. Select to shoot a stationary subject with a tripod, or when using a conversion lens (optional). Natural pictures are produced.

Using the (MEMORY SET) menu

– QUALITY/IMAGE SIZE/ALL ERASE/NEW FOLDER, etc.

You can select items listed below on the MEMORY SET menu. To select items, see “Selecting menu items” (p. 59). The default settings are marked with ▷. The

indicators in parentheses appear when the setting is selected. The settings you can adjust vary depending on the power mode of your camcorder. The screen shows the items you can currently operate. Unavailable items will be grayed out.

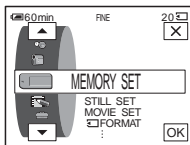

STILL SET

QUALITY

- ▷ FINE (FINE) Select to record still images with the fine image quality (compressed to about 1/4).

- STANDARD (STD) Select to record still images with the standard image quality (compressed to about 1/10).

FLD/FRAME

- ▷ FIELD To record moving subjects correcting jitter (p. 30).

- FRAME () To record stationary subjects in high quality.

MOVIE SET

IMAGE SIZE

- ▷ 320 × 240 () Select to record movies for playing on a large screen, or to record clearer pictures.

- 160 × 112 () Select to record for longer time.

REMAINING

- ▷ AUTO Select to display the remaining capacity of the “Memory Stick” in the following cases:
 - After inserting a “Memory Stick” with the POWER switch in the CAMERA-MEMORY mode (for about 5 seconds).
 - When the remaining capacity of the “Memory Stick” is less than 2 minutes after the CAMERA-MEMORY mode is selected.
 - At the starting or ending point of the movie (for approximately 5 seconds).

→ continued

ON	Select to always display the remaining capacity of the “Memory Stick.”
----	--

ALL ERASE

You can delete all the pictures on a “Memory Stick” that are not write-protected. To delete pictures one by one, see page 98.

1 Select [ALL FILES] or [CURRNT FOLDER].

ALL FILES	Select to delete all the images on the “Memory Stick.”
-----------	--

CURRNT FOLDER	Select to delete all the images in the selected playback folder.
---------------	--

2 Touch [YES] twice.

To cancel deletion of all pictures, select [NO].

3 Touch .

Notes

- The folder will not be deleted even when you delete all the pictures in the folder.
- Do not move the POWER switch or press any buttons while  Erasing all data... is displayed on the screen.

FORMAT

The supplied* or newly purchased “Memory Stick” has been formatted at the factory, and does not require formatting.

For details on the “Memory Stick,” see page 116.

* Memory Stick media is only supplied with DCR-TRV361.

1 Touch [YES] twice.

To cancel formatting, select [NO].

2 Touch .

Notes

- Do not do any of the following while  Formatting... is displayed:
 - Move the POWER switch to select other power modes.
 - Operate any buttons.
 - Eject the “Memory Stick.”
- Formatting erases everything on the “Memory Stick” including protected image data and newly created folders.

FILE NO.

▷SERIES	Select to assign file numbers in sequence even if the “Memory Stick” is replaced with another one. The file number is reset when a new folder is created or the recording folder is replaced with another.
RESET	Select to reset the file number to 0001 each time the “Memory Stick” is changed.

NEW FOLDER

You can create a new folder (102MSDCF to 999MSDCF) on a “Memory Stick.” When a folder is full (a maximum of 9999 images are stored) a new folder is automatically created.

1 Touch [YES].

A newly created folder will be numbered in sequence after the last folder number.



To cancel creation, select [NO].

2 Touch [X].



Notes

- You cannot delete the created folders using your camcorder. You will have to format the “Memory Stick” (p. 66), or delete them using your computer.
- The number of pictures that can be recorded on a “Memory Stick” decreases as the number of folders increases on the “Memory Stick.”

REC FOLDER

As the default setting, pictures are saved in the 101MSDCF folder. You can select a folder to save your pictures. Create new folders from the [NEW FOLDER] menu, then select the folder to be used for recording with / and touch . When you have a lot of pictures, you can search for the desired picture easily when you sort them in folders.

PB FOLDER

Select the playback folder with /, then touch .

Using the (PICT. APPLI.) menu – PICT.

EFFECT/SLIDE SHOW/FRAME REC/INTERVAL REC, etc.

You can select items listed below on the PICT. APPLI. menu. To select items, see “Selecting menu items” (p. 59). The default settings are marked with ▷. The

indicators in parentheses appear when the setting is selected. The settings you can adjust vary depending on the power mode of your camcorder. The screen shows the items you can currently operate. Unavailable items will be grayed out.

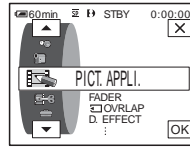

FADER

See page 40 for details.

OVERLAP



See page 41 for details.

D. EFFECT

See page 41, 48 for details.

PICT. EFFECT

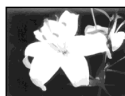
You can add special effects (such as films) to a picture before or after recording on a tape.  appears when the effect is selected.

▷OFF	Select when not using the Picture effect setting.	
NEG.ART	Select to record/play the picture with the color and brightness of the picture reversed.	
SEPIA	Select to record/play the picture appearing in sepia.	
B&W	Select to record/play the picture appearing in monochrome (black-and-white).	
SOLARIZE	Select to record/play the picture looking like an illustration with strong contrast.	
PASTEL	Select to record the picture looking like a pale pastel drawing. (This effect is not available during playback.)	

MOSAIC

Select to record picture appearing mosaic-patterned. (This effect is not available during playback.)



Notes

- You cannot add effects to externally input pictures. Also, you cannot output pictures edited with Picture effects via the DV Interface.
- For DCR-TRV460:
Picture effects do not work with tapes recorded on other devices in the Hi8 standard 8 mm system.

Tip

- You can copy pictures edited using picture effects to a “Memory Stick” (p. 89) or to another tape (p. 87).

MEMORY MIX

See page 43 for details.

PB ZOOM

See page 53 for details.

SLIDE SHOW

You can play back the images stored in a “Memory Stick” (or a selected playback folder) in sequence (slide show).

- 1 Touch [SET].
- 2 Touch [PB FOLDER].
- 3 Select [ALL FILES] or [CURRNT FOLDER], then touch [OK].

▷ ALL FILES (all) Select to execute a slide show by playing back all the images on the “Memory Stick.”

CURRNT FOLDER (F) Select to execute a slide show by playing back all the images in the current playback folder.

- 4 Touch [REPEAT].
- 5 Touch [ON] or [OFF], then [OK].

▷ ON (↺) Select to repeat the slide show.

OFF Select to execute the slide show only once.

- 6 Touch [END].
- 7 Touch [START].

Your camcorder plays back the images recorded on the “Memory Stick” in sequence.

To cancel the slide show, touch [END]. To pause, touch [PAUSE].

→ continued

💡 Tips

- You can select the first picture for the slide show by touching [−]/[+] before touching [START].
- If movies are played in the slide show, you can adjust the volume by touching [K]− (decrease)/[K] + (increase).

FRAME REC

You can record pictures with a stop-motion animated effect by alternately frame recording and then moving the subject a little. Operate your camcorder using the Remote Commander to prevent camera shake.

▷OFF	Select to record in the standard recording mode.
ON (🎞)	Select to record pictures using the FRAME REC function. 1 Select [ON], then touch [OK]. 2 Touch [X]. 3 Press REC START/STOP. A picture (approximately 6 frames) is recorded, and your camcorder enters the standby mode. 4 Move the subject and repeat step 3.

🔊 Notes

- When you use frame recording continuously, the remaining tape time will not be indicated correctly.
- The last scene will be longer than other scenes.

INTERVAL REC

You can achieve excellent recordings of flowers blooming, etc., with this function. Connect your camcorder to the wall outlet using the supplied AC Adaptor during the operation.

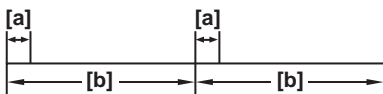

a: [REC TIME]

b: [INTERVAL]

- 1 Touch [SET].**
- 2 Touch [INTERVAL].**
- 3 Select a desired interval time, then touch [OK].**
You can select from 30 seconds, 1, 5 or 10 minutes for the interval.
- 4 Touch [REC TIME].**
- 5 Select a desired recording time, then touch [OK].**
You can select from 0.5, 1, 1.5 or 2 seconds for the recording time.
- 6 Touch [END].**
- 7 Touch [ON], then [OK].**

▷OFF	To deactivate interval recording.
ON (📷)	To record moving pictures on a tape in the selected interval.

8 Touch [X].

📷 flashes on the screen.

9 Press REC START/STOP.

📷 stops flashing and the Interval recording starts.

To cancel interval recording, select [OFF] in step 7.

🔊 Notes

- You cannot use the Interval recording with Memory overlap.
- There may be a discrepancy in recording time of up to ± 6 frames from the selected time.

💡 Tips

- If you adjust the focus manually, you may be able to record clear pictures even if the light changes (p. 39).
- You can silence the beeps during recording (p. 81).

INT. REC-STL

This function is useful to observe the movement of clouds or the changes of daylight. Your camcorder will shoot a still image at a selected interval and record it on a “Memory Stick.”

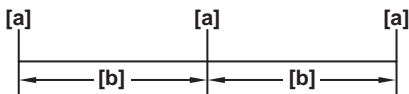

a: Shooting time

b: Interval

- 1 Touch **[SET]**.
- 2 Select a desired interval time (1, 5 or 10 minutes), then touch **[OK]**.
- 3 Touch **[ON]**, then touch **[OK]**.

▷OFF To deactivate interval recording.

ON (📷) To record still images on a “Memory Stick” in the selected interval.

- 4 Touch **[X]**.
📷 flashes.
- 5 Press **PHOTO** fully.
📷 stops flashing and the Interval photo recording starts.
To cancel interval photo recording, select **[OFF]** in step 3.

DEMO MODE

When you remove a cassette and “Memory Stick” from your camcorder, and select the CAMERA-TAPE mode, you can view the demonstration in about 10 minutes.

▷ON Select to see an overview of the functions available such as when you are using this camcorder for the first time.

OFF Select when you do not intend to use the DEMO MODE.

🔔 Note

- You cannot view the demonstration only when the NIGHTSHOT PLUS switch is set to ON.

💡 Tips

- The demonstration will be suspended in situations such as those described below.
 - When you touch the screen during the demonstration. (The demonstration starts again in about 10 minutes.)
 - When a cassette or “Memory Stick” is inserted.
 - When a mode other than CAMERA-TAPE is selected.
- If [A.SHUT OFF] is set to [5 min] when the camcorder is used on the battery pack, the power will be turned off after approximately 5 minutes (p. 81).

PRINT

See page 101 for details.

Using the (EDIT/PLAY) menu – END SEARCH/TITLE, etc.

You can select items listed below on the EDIT/PLAY menu. To select items, see “Selecting menu items” (p. 59).

The settings you can adjust vary depending on

the power mode of your camcorder. The screen shows the items you can currently operate. Unavailable items will be grayed out.

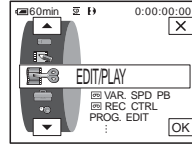

VAR. SPD PB

See page 47 for details.

REC CTRL

For recording on a tape.
See page 88, 90 for details.

PROG. EDIT

OTHER DEVICE	Select to make programs and dubbing the selected scenes to a tape on a VCR (p. 91).
MEMORY STICK	Select to make programs and dubbing the selected scenes to a “Memory Stick” (p. 95).

REC CTRL

For recording on a “Memory Stick.”
See page 88, 89 for details.

BURN DVD

When your camcorder is connected to a Sony VAIO series personal computer, you can easily burn the picture recorded on the tape on a DVD (Direct Access to “Click to DVD”) using this command. See the supplied “Computer Applications Guide” for details.

BURN VCD

When your camcorder is connected to a personal computer, you can easily burn the picture recorded on the tape on a CD-R (Direct Access to Video CD Burn) using this command. See the supplied “Computer Applications Guide” for details.

→ *continued*

END SEARCH

EXEC	Select to activate the END SEARCH function. The most recently recorded picture is played back for about 5 seconds and then stops automatically.
CANCEL	Select to stop the END SEARCH function.

TITLE

You can insert a title when recording. You can select one of the 8 preset titles and the 2 custom titles. You can also select the color, size and position of titles.



- 1 Select a desired title from the displayed titles (2 original titles that you have created before and the preset titles that have been stored in your camcorder). You can create original titles (up to 2 types of title of within 20 characters each) in the following procedure.

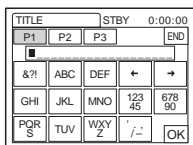





- 1 Select [CUSTOM 1 " "] or [CUSTOM 2 " "], then touch .
- 2 Select a desired character. Touch the button repeatedly to select the desired character on the button.



To erase a character: Touch .

To insert a space: Touch .

To select the type of letter to enter the title: Select ,  or .

- 3 Touch  to move  to select the next character, and enter the character in the same manner.
- 4 When you have finished entering characters, touch .
- 2 Touch .
- 3 Touch  (color),  (position), [SIZE] as necessary to select a desired color, position, or size.

Color

white → yellow → violet → red → cyan → green → blue

Position

You can select from 8 to 9 choices.

Size

small ↔ large

(You can only select small size when you are entering more than 13 characters.)

- 4 Touch .
- The title is displayed on the screen and the title is set.

To record the title

Press REC START/STOP during recording standby.

To erase the title display

Touch .

Notes

- When you are using your camcorder on the battery pack and do not operate it for 5 minutes, the power automatically goes off as the default setting. If you may take 5 minutes or longer to enter characters, set [A.SHUT OFF] on the  (STANDARD SET) menu to [NEVER] (p. 81). The power will not be turned off. Even though the power goes off, the characters you have entered remain stored in memory. Turn the power back on, then start again from step 1 to continue superimposing the title.
- When you superimpose a title while you are recording, the beep does not sound.

Tip

- To change a created title, select the title in step 1, then touch . Then, reselect the characters again.

Using the (STANDARD SET)

menu – REC MODE/MULTI-SOUND/AUDIO MIX/USB-CAMERA, etc.

You can select the items listed below on the STANDARD SET menu. To select these items, see “Selecting menu items” (p. 59). The default settings are marked with ▷. The

indicators in parentheses appear when the setting is selected. The settings you can adjust vary depending on the power mode of your camcorder. The screen shows the items you can currently operate. Unavailable items will be grayed out.

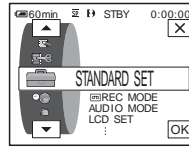

REC MODE

▷ SP (<u>SP</u>)	Select to record in the SP (Standard Play) mode on a cassette.
LP (<u>LP</u>)	Select to increase the recording time to 1.5 times the SP mode (Long Play). The use of Sony cassette is recommended to get the most out of your camcorder.





Notes

- If you record in the LP mode, a mosaic-like noise may appear or sound may be interrupted when you play back the tape on other camcorders or VCRs.
- When you mix recordings in the SP mode and in the LP mode on one tape, the playback picture may be distorted or the time code may not be written properly between the scenes.

AUDIO MODE

▷ 12BIT	Select to record in the 12-bit mode (2 stereo sounds).
16BIT (<u>16b</u>)	Select to record in the 16-bit mode (1 stereo sound with high quality).

Note

- For DCR-TRV460:
You cannot select AUDIO MODE when you dub tapes recorded in the Digital8  system to another VCR. However, you can select AUDIO MODE when you dub tapes recorded on other devices in the Hi8 /standard 8 mm  system to another VCR, via the  DV Interface.



VOLUME







See page 46, 49 for details.

MULTI-SOUND

You can select how to play back audio recorded on a tape in stereo mode. Select the desired mode when you play back a Digital8  system tape which is dubbed from a dual sound track tape recorded in the DV system.

For DCR-TRV460:

Select the desired mode when you play back a Hi8 /standard 8 mm  system tape recorded on other devices in a dual sound track of the AFM HiFi stereo system.

▷STEREO	Select to play back a stereo tape with stereo sound or dual sound track tape with main and sub sound.
1	Digital8  system: Select to play back a stereo tape with the left channel sound or a dual sound track tape with main sound. For DCR-TRV460: Hi8  /standard 8 mm  system: Select to play back a stereo tape with monaural sound or a dual sound track tape with main sound.
2	Digital8  system: Select to play back a stereo tape with the right channel sound or a dual sound track tape with sub sound. For DCR-TRV460: Hi8  /standard 8 mm  system: Select to play back a stereo tape with unnatural sound or a dual sound track tape with sub sound.

Notes



- You can playback a dual sound track cassette on your camcorder. However, you cannot record a dual sound track on your camcorder.
- The setting returns to [STEREO] when you disconnect the power source from your camcorder for more than 5 minutes.

TBC

For DCR-TRV460:

▷ON	Select to correct jitter (horizontal picture shake during playback).
OFF	Select to not compensate picture distortion when playing back a tape on which you have dubbed repeatedly or recorded TV game signals.

Note



- The TBC function works only with tapes recorded on other devices in the Hi8 /standard 8 mm  system.

DNR

For DCR-TRV460:

▷ON	Select to eliminate color noise in the picture.
OFF	Select to minimize picture artifacts in a picture containing lots of movement.

Note

- The DNR function works only with tapes recorded on other devices in the Hi8 /standard 8 mm  system.

→ continued

AUDIO MIX

You can adjust the audio balance between the main sound (ST1) and the sub sound (ST2) on the tape.

🔌 Notes

- You cannot adjust sound recorded in 16 bit audio mode.
- Only the originally recorded sound will be heard when you disconnect the power source from your camcorder for more than 5 minutes.
- For DCR-TRV460:
You cannot adjust the balance for tapes recorded on other devices in the Hi8 **Hi8**/standard 8 mm **8** system.

LCD SET

The recorded picture will not be affected by this setting.

LCD BRIGHT

See page 18 for details.

LCD BL LEVEL

You can adjust the brightness of the LCD screen's backlight.

▷NORMAL	Standard brightness.
BRIGHT	Select to brighten the LCD screen.

🔌 Notes

- When you connect your camcorder to outside power sources, [BRIGHT] is automatically selected for the setting.
- When you select [BRIGHT], battery life is reduced by about 10 percent during recording.

LCD COLOR

Touch / to adjust the color on the LCD screen.



A/V → DV OUT

You can connect a digital device and an analog device to your camcorder and convert the signal transmitted from the connected devices to the appropriate signal on your camcorder.

▷OFF	Select when not using the Digital convert function.
ON (A/V→DV)	To output analog images and sound in digital format using your camcorder. The analog signal input to the A/V jack of your camcorder will be converted and output from the DV Interface of your camcorder. For details, refer to the “Computer Applications Guide.”

PB MODE

For DCR-TRV460:

▷AUTO	Select to automatically detect the system (Hi8 Hi8/standard 8 mm 8 or Digital8 8) that was used to recorded on the tape, and play back the tape. During switching of systems, the screen turns blue, and the following displays appear on the screen. A hissing noise also sometimes can be heard. 8 → Hi8/8 : During switching from Digital8 8 to Hi8 Hi8/standard 8 mm 8 . Hi8/8 → 8 : During switching from Hi8 Hi8/standard 8 mm 8 to Digital8 8 .
Hi8/8	Select to play back a tape that was recorded on other devices in the Hi8 Hi8/standard 8 mm 8 system when your camcorder does not automatically detect the recording system.

Note

- The setting returns to [AUTO] when you disconnect the power source from your camcorder or slide the power switch.

USB-CAMERA

You can connect a USB cable (supplied) to your camcorder, and view the picture displayed on the screen of your camcorder on your computer (USB Streaming).
For details, refer to the “Computer Applications Guide.”

▷OFF	Select to deactivate the USB Streaming function.
USB STREAM	Select to activate the USB Streaming function.

USB-PLY/EDT

You can connect a USB cable (supplied) to your camcorder, and view the picture on the tape or “Memory Stick” in your camcorder on your computer. For details, refer to the “Computer Applications Guide.”

▷STD-USB	Select to view the picture on the “Memory Stick.”
PictBridge	Select to connect the PictBridge compliant printer (p. 101).
USB STREAM	Select to view the picture on the tape.

DATA CODE

▷OFF	Select not to display date, time and the camera settings data during playback.
DATE/TIME	Select to display the date and time during playback (p. 54).
CAMERA DATA	Select to display the camera settings data during playback (p. 54).

REMAINING

▷AUTO	Select to display the remaining tape indicator for about 8 seconds: <ul style="list-style-type: none">• After you select the CAMERA-TAPE mode with the cassette inserted, and your camcorder calculates the remaining amount of tape.• When you touch  (play/pause).
ON	Select to always display the remaining tape indicator.

REMOTE CTRL

▷ON	Select when using the Remote Commander supplied with your camcorder.
OFF	Select to deactivate the Remote Commander to prevent your camcorder from responding to a command sent by another VCR remote control unit.

Note

- The setting returns to [ON] when you have the power source disconnected from your camcorder for more than 5 minutes.

REC LED

▷ON	Select to turn on the camera recording lamp on the front of your camcorder during recording.
-----	--

OFF	Select this setting in the following recording situations. The camera recording lamp will not light up during recording. <ul style="list-style-type: none"> • When you do not want the subject to be nervous about being recorded. • When you are recording close to the subject. • When the subject reflects the recording lamp.
-----	--

BEEP

▷MELODY	Select to sound a melody when you start/stop recording, operate the touch panel, or when an unusual condition occurs on your camcorder.
NORMAL	Select to sound a beep instead of the melody.
OFF	Select to cancel the melody, the beep sound, the shutter sound or touch panel operation confirmation beep.



DISPLAY



▷LCD PANEL	Select to show the displays such as the time code on the LCD screen and in the viewfinder.
V-OUT/PANEL	Select to show the displays such as the time code on the TV screen, LCD screen, and in the viewfinder.

Note

- You cannot input a signal to your camcorder if you press DSPL/BATT INFO while [V-OUT/PANEL] is selected.

MENU ROTATE

You can select the scrolling direction (up or down) of the menu items on the LCD screen when you touch  or .

▷NORMAL	Select to scroll the menu items downwards by touching  .
OPPOSITE	Select to scroll the menu items upwards by touching  .

A.SHUT OFF

▷5 min	Select to activate the Auto shut off. When approximately 5 minutes have elapsed while you do not operate your camcorder, the camcorder is automatically turned off to prevent the battery from becoming consumed.
NEVER	Select to deactivate the Auto shut off.

Note

- When you connect your camcorder to the wall outlet, [A.SHUT OFF] is automatically set to [NEVER].

Using the (TIME/ LANGU.) menu – CLOCK SET/ WORLD TIME, etc.

You can select items listed below on the TIME/
LANGU. menu. To select items, see “Selecting
menu items” (p. 59).

The settings you can adjust vary depending

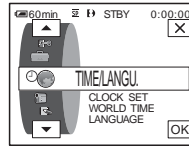

on the power mode of your camcorder. The
screen shows the items you can currently
operate. Unavailable items will be grayed out.



CLOCK SET

You can set the date and time (p. 19).

WORLD TIME

You can adjust the time difference when using your camcorder abroad. Set the
time difference by touching /, the clock will be adjusted in accordance
with the time difference. If you set the time difference to 0, the clock returns to
the originally set time.

LANGUAGE

You can select or change the language used for the on-screen display (p. 22). You
can select from English, Simplified English, Canadian-French, Latin American
Spanish, Brazilian-Portuguese, Traditional-Chinese, or Korean.

Customizing Personal Menu

You can add frequently used menu items to Personal Menu, or sort them in the order you like (customizing). You can customize the Personal Menu for each power mode of your camcorder.

Adding a menu – Add

You can add frequently used menu items to Personal Menu for easier and faster access.

Note

- You can add up to 28 menu items each for the CAMERA-TAPE, CAMERA-MEMORY, and PLAY/EDIT modes. If you want to add more, you must delete a less important menu item before adding a new menu item (p. 84).

1 Touch [P-MENU].

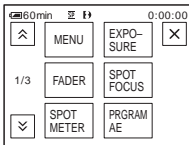

2 Touch [P-MENU SET UP].

If the desired menu is not displayed on the screen, touch \uparrow / \downarrow until the menu is displayed.

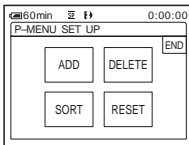

3 Touch [ADD].

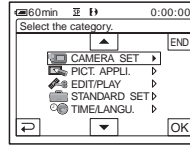

4 Touch \uparrow / \downarrow to select a menu category, then touch [OK].

The available items vary depending on the power mode of the camcorder. Only the available items are displayed.

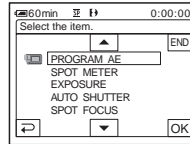

5 Touch \uparrow / \downarrow to select a menu item, then touch [OK].

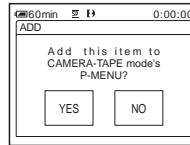

6 Touch [YES].

The menu is added to the end of the list.

7 Touch [X].

→ continued

Deleting menu – Delete

1 Touch [P-MENU].

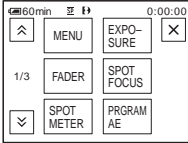

2 Touch [P-MENU SET UP].

If the desired menu is not displayed on the screen, touch / until the menu is displayed.

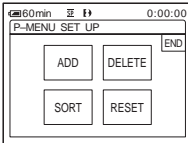

3 Touch [DELETE].

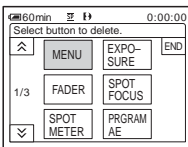

4 Touch the menu that you want to delete.

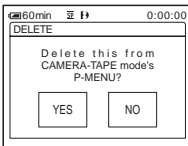

5 Touch [YES].

The selected menu is deleted from Personal Menu.

6 Touch .

Note

- You cannot delete [MENU] and [P-MENU SET UP].

Arranging the order of menus displayed on Personal Menu – Sort

You can sort the menus added to Personal Menu in the desired order.

1 Touch [P-MENU].

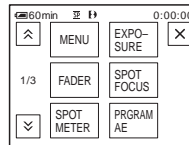

2 Touch [P-MENU SET UP].

If the menu is not displayed on the screen, touch / until the desired menu is displayed.

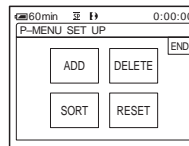

3 Touch [SORT].

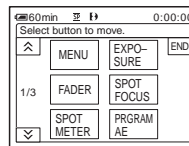

- 4 Touch the menu item you want to move.

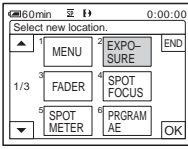

- 5 Touch \uparrow / \downarrow to move the menu item to the desired place.

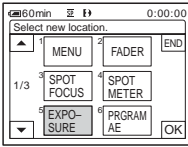

- 6 Touch \square OK.

To sort more items, repeat steps 4 to 6.

- 7 Touch \square END.

- 8 Touch \square X.

Note

- You cannot move [P-MENU SET UP].

Initializing the settings – Reset

You can initialize Personal Menu to the default settings after adding or deleting menus.

- 1 Touch \square P-MENU.

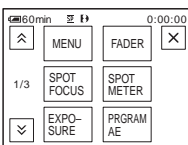

- 2 Touch \square [P-MENU SET UP].

If the desired menu is not displayed on the screen, touch \uparrow / \downarrow until the menu is displayed.

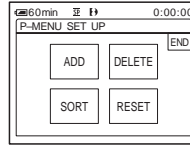

- 3 Touch \square [RESET].

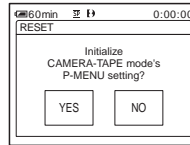

- 4 Touch \square [YES].

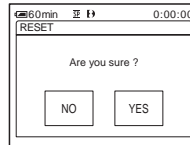

- 5 Touch \square [YES].

The Personal Menu settings return to the default settings.

To cancel initialization, touch [NO].

- 6 Touch \square X.

Connecting to a VCR or TV

You can record the picture from a VCR or TV to a tape or a “Memory Stick” inserted into your camcorder (p. 88). You can also create a copy of the picture recorded on your camcorder on other recording device (p. 87). Connect your camcorder to a TV or VCR as shown in the following illustration.

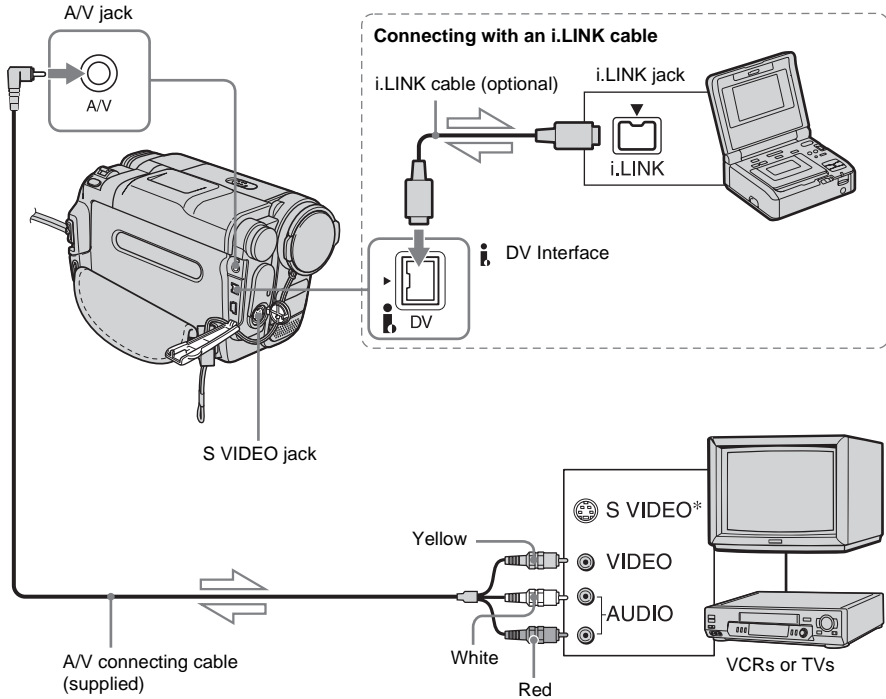

➤ Signal flow

* Pictures can be reproduced more faithfully by using an S video cable (optional). When there is an S video jack on the device to be connected, connect the S video plug to that jack instead of using the yellow video plug. The audio will not be output when you connect with the S video plug alone.

Notes

- Use the A/V connecting cable to connect your camcorder to other devices. Before connecting, make sure the [DISPLAY] setting in the (STANDARD SET) menu is set to [LCD PANEL] (the default setting) (p. 81).
- When you are connecting your camcorder to monaural device, connect the yellow plug of the A/V connecting cable to the video jack, and the red (right channel) or the white (left channel) plug to the audio jack on the VCR or the TV.

To use an i.LINK cable for connection

Use an i.LINK cable (optional) to connect your camcorder to other device via the DV Interface. The video and sound signals are transmitted digitally, producing high quality pictures. Note that you cannot record the picture and sound separately. For details, see page 119.

Dubbing to another tape

You can copy and edit the picture played back on your camcorder to other recording devices (such as VCRs).

- When connected using the i.LINK cable, the recorded picture becomes rough when a picture is paused on your camcorder while recording to a VCR.
- For DCR-TRV460:
When you dub the tape recorded on other devices in the Hi8 **Hi8**/standard 8 mm **8** system via the **i** DV Interface, the picture may fluctuate. This is not a malfunction. Digital signals are output as image signals from the **i** DV Interface during playback.

1 Connect your VCR to your camcorder as a recording device (p. 86).

2 Prepare your VCR for recording.

- Insert a cassette for recording.
- If your VCR has an input selector, set it to the input mode.

3 Prepare your camcorder for playback.

- Insert the recorded cassette.
- Slide the POWER switch to select the PLAY/EDIT mode.

4 Start the playback on your camcorder, and record it on the VCR.

Refer to the operating instructions supplied with your VCR for details.

5 When the dubbing is finished, stop your camcorder and the VCR.

Notes

- When your camcorder is connected to the VCR via the **i** DV Interface, you cannot record the title, indicators and words entered on the index screen of the “Memory Stick.”
- When dubbing using the A/V connecting cable, press DSPL/BATT INFO to hide indicators such as time code (p. 54). Otherwise, they will be recorded on the tape.
- To record the date/time and camera settings data, have them displayed on screen (p. 54).
- Pictures edited with Picture effect ([PICT. EFFECT] p. 68), Digital effect (p. 41, 48), or Playback zoom (p. 53) cannot be output via the **i** DV Interface.

Recording pictures from a VCR or TV

You can record and edit pictures or TV programs from a VCR or TV on a tape or a “Memory Stick” inserted in your camcorder. You can also record a scene as a still image on a “Memory Stick.”

Insert a cassette or a “Memory Stick” for recording in your camcorder.

Recording movies





-
- 1 **Connect your TV or VCR to your camcorder (p. 86).**

 - 2 **If you are recording from a VCR, insert a cassette.**





 - 3 **Slide the POWER switch to select the PLAY/EDIT mode.**

 - 4 **Operate your camcorder to record movies.**

When recording on a tape

- 1 Touch .
- 2 Touch [ REC CTRL] with an  icon.
If the item is not displayed on the screen, touch . If you cannot find it, touch [MENU], and select it from the  (EDIT/PLAY) menu (p. 73).
- 3 Touch [REC PAUSE].

When recording on a “Memory Stick”

- 1 Touch .
- 2 Touch [MENU].
- 3 Select the  (EDIT/PLAY) menu, then [ REC CTRL] with an  icon.



-
- 5 **Start playing the cassette on your VCR, or select a TV program.**
The picture played on the connected device appears on the LCD screen of your camcorder.

-
- 6 **Touch [REC START] at the point you want to start recording.**

-
- 7 **Stop recording.**
When recording on a tape
Touch  (stop) or [REC PAUSE].
When recording on a “Memory Stick”
Touch [REC STOP].

-
- 8 **Touch , then .**
-

Tips

- The **DV IN** indicator appears when you connect your camcorder and other devices via an i.LINK cable. (This indicator may also appear on your TV.)
- When recording movies on a “Memory Stick,” you can skip step 4 and press REC START/STOP in step 6.
- For DCR-TRV460:
To enable smooth transition, we recommend that you do not mix pictures recorded in the Hi8 /standard 8 mm  system on other devices with the Digital8  system on a tape.

Recording still images

- 1 Perform steps 1 to 3 in “Recording movies” (p. 88).
- 2 **Play the video, or receive the TV program you want to record.**
The pictures on the VCR or TV appear on the screen of your camcorder.
- 3 **Press PHOTO lightly at the scene you want to record. Check the image and press it fully.**
The image is not recorded unless you press PHOTO fully. Release it if you do not want to record the scene, and select other scene as described above.

Dubbing pictures from a tape to a “Memory Stick”

You can record movies (with sound recorded in monaural) or still images on a “Memory Stick.”

Make sure you have a recorded tape in the Digital8  system and a “Memory Stick” inserted into your camcorder.



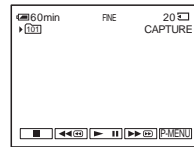

- 1 **Slide the POWER switch to select the PLAY/EDIT mode.**
- 2 **Search and record the scene you want to record.**

When recording a still image

- 1 Touch  (play) to playback the tape.
- 2 Press PHOTO lightly at the scene you want to record. Check the image and press it fully.



When recording a movie

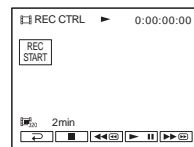

- 1 Touch [P-MENU].
- 2 Touch [MENU].
- 3 Select the  (EDIT/PLAY) menu, then  [REC CTRL] with an  icon.
- 4 Touch  (play) to playback the tape.



- 5 Touch [REC START] at the point you want to start recording.
- 6 Touch [REC STOP] at the point you want to stop recording.
- 7 Touch  (stop) to stop tape playback.

→ *continued*

Notes

- The Data code and titles recorded on the tape cannot be recorded on the “Memory Stick.” The time and date the picture is recorded on the “Memory Stick” will be recorded.
- The sound is recorded in 32kHz monaural.
- While recording images from a tape as still images, they are recorded in the [FRAME] mode automatically, even if you select [FIELD] in the menu settings (p. 65).
- For DCR-TRV460:
If you record pictures recorded in different recording systems (Digital8 , and Hi8 /standard 8 mm  on other devices), transitional scenes between recording systems may be incorrectly recorded on the “Memory Stick.”



Tips

- You can also record a movie by pressing REC START/STOP during tape playback.
- For the recording time of movies, see page 26.



Dubbing still images from a “Memory Stick” to a tape

You can record still images on a tape. Make sure you have the “Memory Stick” with the images and a tape inserted into your camcorder.

1 Slide the **POWER** switch to select the **PLAY/EDIT** mode.



2 Search for the point where you want to start dubbing by touching  (rewind) or  (fast forward), then touch  (stop).

3 Touch .

4 Touch / to select the image you want to dub.

5 Touch .

6 Touch [ **REC CTRL**] with an  icon.



If the item is not displayed on the screen, touch /. If you cannot find it, touch [MENU], and select it from the  (EDIT/PLAY) menu.

7 Touch [**REC PAUSE**].

8 Touch [**REC START**].

The selected image is dubbed to the tape.

9 Touch  (stop) or [**REC PAUSE**] when you want to stop recording.

To dub other still images, select images by touching /, then repeat steps 7 to 9.

Notes

- You cannot dub the index screen.
- You may not be able to dub images modified on your computer or recorded with other camcorders on your camcorder.
- You cannot dub MPEG movies on the tape.

Dubbing selected scenes from a tape

– Digital program editing

You can select up to 20 scenes (programs) and record them in the desired order to other recording device such as VCRs or to a “Memory Stick” inserted in your camcorder. When you are recording on a “Memory Stick,” skip steps 1 and 2 and start from “Recording the selected scenes as programs” (p. 95).

Note

- For DCR-TRV460:
The Digital program editing does not work with tapes recorded on other devices in the Hi8 **Hi8** / standard 8 mm **8** system.

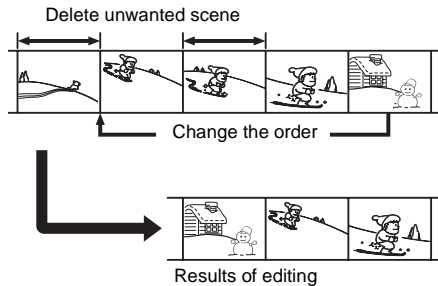

Step 1 : Preparing your camcorder and VCR for operation

Follow the steps below when you are performing a digital program edit for the first time to a tape in a VCR. You can skip this setting if you have set up the VCR by the following procedure before.

Note

- You cannot perform the Digital program editing on a VCR that does not support [IR SETUP] codes.

→ continued

1 Connect your VCR to the camcorder as a recording device (p. 86).

You can use either the A/V connecting cable or the i.LINK cable to make the connection. The dubbing procedure is easier with the i.LINK connection.

2 Prepare your VCR.

- Insert a cassette for recording.
- Set the input selector to input mode if your VCR has one.

3 Prepare your camcorder (playing device).

- Insert a cassette for editing.
- Slide the POWER switch to select the PLAY/EDIT mode.

4 Touch [P-MENU].

5 Touch [MENU].

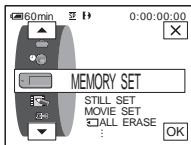

6 Touch [UP]/[DOWN] to select [EDIT/PLAY], then touch [OK].

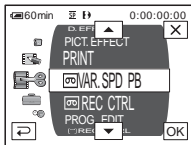

7 Touch [UP]/[DOWN] to select [PROG. EDIT], then touch [OK].

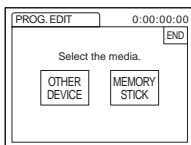

8 Touch [OTHER DEVICE].

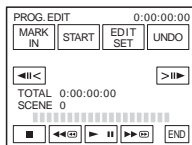

9 Touch [EDIT SET].

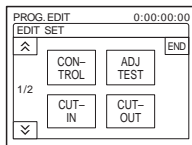

10 Touch [CONTROL].

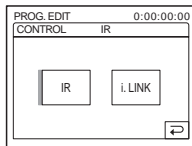

11 Select [IR] or [i.LINK].

When connecting with an A/V connecting cable

Touch [IR], then [OK]. Follow the procedure described in “To set the [IR SETUP] code” (p. 93).

When connecting with an i.LINK cable

Touch [i.LINK], then [OK]. Go on to “Step 2 : Adjusting the synchronization of the VCR” (p. 94).

To set the [IR SETUP] code

When you connect with an A/V connecting cable, you need to check the [IR SETUP] code signal to see if your VCR can be operated by your camcorder (infrared ray emitter).

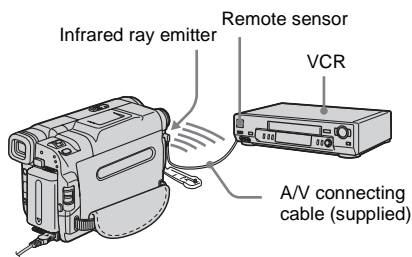

- 1 Touch ∇ , then [IR SETUP].**
- 2 Select the [IR SETUP] code of your VCR with $-$ / $+$, then touch [OK].**
For the [IR SETUP] code of your VCR, refer to "[IR SETUP] code list" (p. 93). When there is more than one code listed for the manufacturer of your VCR, try each code and find the most appropriate one.
- 3 Touch [PAUSEMODE].**
- 4 Select the mode to cancel recording pause on your VCR, then touch [OK].**
Refer to the operating instructions supplied with your VCR for details on operation.
- 5 Point the infrared ray emitter of your camcorder towards the remote sensor on your VCR, from about 30 cm (12 in.) away, with no obstructions.**
- 6 Insert a cassette into your VCR, and set the VCR to recording pause.**
- 7 Touch [IR TEST].**
- 8 Touch [EXEC].**
The recording starts on your VCR when the setting is correct. [Completed.] appears when the [IR SETUP] code test is finished. Go on to "Step 2 : Adjusting the synchronization of the VCR" (p. 94). When recording fails to start, select another [IR SETUP] code and try again.

[IR SETUP] code list

The following [IR SETUP] codes are recorded on your camcorder by default. (It is set at "3" as the default setting.)

Manufacturing company	[IR SETUP] code
Sony	1, 2, 3, 4, 5, 6
Admiral (M. Wards)	89
Aiwa	47, 54, 80
Akai	49, 51
Audio Dynamic	21, 35
Bell&Howell (M. Wards)	36
Borksonic	21, 70, 82
Canon	77, 78
Citizen	47
Craig	47, 73
Curtis Mathis	8, 77, 80
Daewoo	26, 40, 77
DBX	21, 33, 35
Dimensia	8
Emerson	26, 48, 59, 70, 80, 81, 82
Fisher	36, 37, 44, 45
Funai	80
General Electric	8, 32*, 77, 94*, 101
Godstar/LG	47
GO VIDEO	71
Hitachi	8, 42, 78
HQ	40
Instant Replay	77, 78
JC Penny	8, 21, 33, 35, 36, 42, 77
JVC	12, 13, 14, 21, 33, 35
Kenwood	21, 33, 35, 47
LXI (Sears)	36, 37, 42, 44, 45, 47, 49, 80
Magnavox	17, 77, 78, 83
Marantz	21, 33, 35
Marta	47
Memorex	37, 77
Minolta	8, 42
Mitsubishi/MGA	22, 23, 24, 28, 29

→ continued

Manufacturing company	[IR SETUP] code
Multitech	23, 32, 80
NEC	21, 33, 35
Olympic	77, 78
Optimus	22
Orion	60
Panasonic	16, 17, 77, 78
Pentax	8, 42
Philco	26, 70, 77, 78
Philips	47, 77, 78, 83
Pioneer	78
Quasar	6, 16, 17, 77, 78
RCA/PROSCAN	7, 8, 16, 40, 41, 42, 77, 78, 78*, 83, 101
Realistic	22, 36, 37, 77, 80, 88
Sansui	21
Singer	73
Samsung	24, 24*, 32, 32*, 41, 94, 94*
Sanyo	26, 36, 37, 47
Scott	22, 23, 24, 28, 32, 37, 40, 41
Sharp	88, 89
Shintom	73
Signature 2000	80, 89
Sylvania	77, 78, 80, 83
Symphonic	80
Tashiro	47
Tatung	21, 33, 35
Teac	21, 33, 35, 80
Technics	77, 78
Toshiba	7, 40, 49
Wards	37, 47, 88, 89, 95
Yamaha	21, 33, 35, 36
Zenith	95

* TV/VCR component

Step 2 : Adjusting the synchronization of the VCR

Follow the steps below when you are performing digital program edit for the first time to a tape in a VCR. You can skip this setting if you have set up your VCR before using the following procedure.

You can adjust the synchronization of your camcorder and the VCR to avoid not recording the starting scene.

1 Remove the cassette from your camcorder. Prepare a pen and paper to take notes.

2 Set the VCR to recording pause mode.

Skip this step if you have selected [i.LINK] in step 11 on p. 92.

Note

- Run the tape for about 10 seconds before pausing. The starting scenes may not get recorded when you start recording from the beginning of the tape.

3 Touch , then [ADJ TEST].

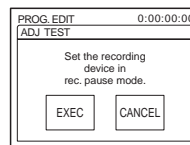

4 Touch [EXEC].

A picture (about 50 seconds long) with 5 [IN] and [OUT] indicators each for adjusting synchronization is recorded.

[Completed.] appears when the recording is finished.

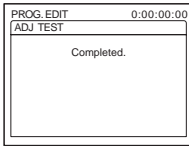

5 Rewind the tape on your VCR, then play back in slow mode.

5 opening numbers for each [IN] and closing numbers for each [OUT] appear.

6 Take a note of the opening number value of each [CUT-IN] and the closing number value of each [CUT-OUT], then calculate the average number value for each [CUT-IN] and [CUT-OUT].

7 Touch [CUT-IN].

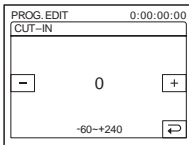

8 Touch $\boxed{-}$ / $\boxed{+}$ to select the average number value for [CUT-IN], then touch \boxed{OK} .

The calculated start position for recording is set.

9 Touch [CUT-OUT].

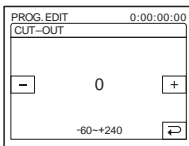

10 Touch $\boxed{-}$ / $\boxed{+}$ to select the average number value for [CUT-OUT], then touch \boxed{OK} .

The calculated stop position for recording is set.

11 Touch [END] twice.

Recording the selected scenes as programs

When you are performing a digital program edit for the first time to a tape in a VCR, go through the procedures described in Steps 1 and 2 (p. 91 to p. 94) beforehand.

Note

- You cannot dub the title or display indicators. However, you can dub the title which has already been recorded on a tape.

1 Prepare a cassette or a “Memory Stick.”

Insert a tape to be played back into the camcorder.

When you are recording on a tape, insert a cassette for recording into your VCR.

When you are recording on a “Memory Stick,” insert a “Memory Stick” into your camcorder.

2 Touch $\boxed{P-MENU}$.

3 Touch \boxed{MENU} .

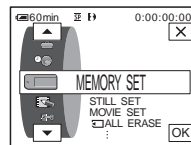

→ continued

- 4 Touch / to select (EDIT/PLAY), then touch .

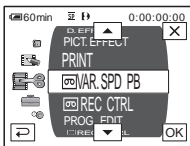

- 5 Touch / to select [PROG. EDIT], then touch .

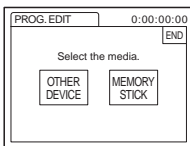

- 6 Touch the desired item.

When you are recording on a tape in the VCR

Touch [OTHER DEVICE].

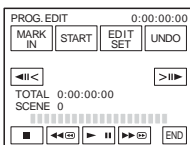

When you are recording on a "Memory Stick"

- 1 Touch [MEMORY STICK].

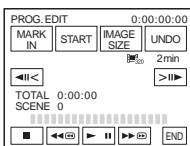

- 2 Touch [IMAGE SIZE] repeatedly to select the desired image size.

- 7 Search for the beginning of the first scene that you want to dub on your camcorder, then pause playback.

You can adjust the position with / .

- 8 Touch [MARK IN].

The starting point of the first program is set, and the upper part of the program mark changes to light blue.

[IMAGE SIZE] appears when recording on a "Memory Stick."

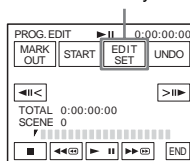

- 9 Search for the end of the first scene that you want to record on your camcorder, then pause playback.

You can adjust the position with / .

- 10 Touch [MARK OUT].

The ending point of the first program is set, and the lower part of the program mark changes to light blue.

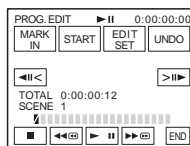

- 11 Repeat steps 7 to 10 and create programs.

- 12 Set your VCR to recording pause.

Skip this step if your camcorder is connected via an i.LINK cable or recording on a "Memory Stick."

13 Touch [START].

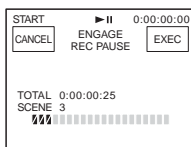

Notes

- You cannot set the starting point or ending point on a blank section of the tape. If there is a blank section in the picture set as a program, the total time may not appear correctly.
- When you cannot operate the device correctly using an i.LINK cable connection, select [IR] in step 11 on p. 92, and set the [IR SETUP] code.

14 Touch [EXEC].

A search for the beginning of the first program starts, then the recording starts. [SEARCH] appears during the search and [EDITING] appears during editing.

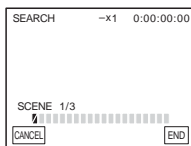

When a program is recorded, the program mark changes from orange to light blue. When all programs have been recorded, the program editing operation stops automatically. To cancel recording, touch [CANCEL].

To end Digital program editing

Touch [END].

To save a program without using it to record

Touch [CANCEL] in step 13.

The program is stored in memory until the cassette is ejected.

To erase programs

- 1 Follow steps 1 to 6 in “Recording the selected scenes as programs” (p. 95), then touch [UNDO].**
- 2 Touch [DEL 1MARK] to delete the last set program. Or, touch [ALL ERASE] to delete all the programs.**
- 3 Touch [EXEC].**
The programs are deleted.
To cancel this operation, touch [CANCEL].



Deleting recorded pictures

You can delete all or selected pictures stored on a “Memory Stick.”

-
- 1 Slide the **POWER** switch repeatedly to select the **PLAY/EDIT** mode.

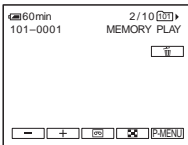
-
- 2 Touch .



-
- 3 Touch  /  to select a picture you want to delete.

-
- 4 Touch .

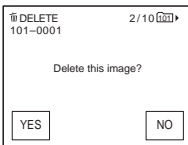

-
- 5 Touch **[YES]**.









The selected picture is deleted.
To cancel deletion, touch **[NO]**.

To delete all pictures at once

Select the  (MEMORY SET) menu, then touch  ALL ERASE] (p. 66).

To delete pictures on the index screen

You can easily search for the picture to be deleted by displaying 6 pictures at once.

- 1 Slide the **POWER** switch to select the **PLAY/EDIT** mode.
- 2 Touch .
- 3 Touch .
- 4 Touch .
- 5 Touch  **DELETE**.
- 6 Touch the picture you want to delete.  appears on the image to be deleted. To display the next or the previous 6 pictures, touch  / .
- 7 Touch .
- 8 Touch **[YES]**.
The selected pictures are deleted.
To cancel deletion, touch **[NO]**.

Notes

- Pictures cannot be deleted when the write-protect tab of the “Memory Stick” is set to the write-protect position (p. 116), or when the selected picture is protected (p. 99).
- The pictures cannot be restored once they are deleted. Make sure you check the pictures before deleting them.

Marking recorded images with specific information

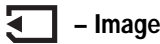

- Image

protection/Print mark

Make sure the write-protect tab on the "Memory Stick" is not set to the write-protect position.

Preventing accidental erasure - Image protection

You can select and mark images to prevent accidental erasure.

1 Slide the POWER switch to select the PLAY/EDIT mode.

2 Touch [PB].

3 Touch .

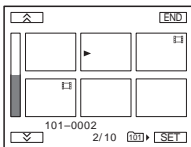

4 Touch [SET].

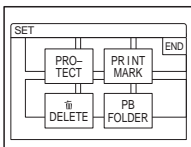

5 Touch [PROTECT].

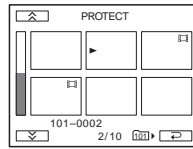

6 Touch the image that you want to protect.

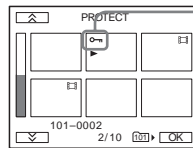

appears on the selected image.

7 Touch [OK].

8 Touch [END].

To cancel image protection

Follow steps 1 to 5, then touch the image to cancel image protection.

disappears from the image.

Selecting still images for printing - Print mark

You can mark images that you want to print out while viewing them on your camcorder. (You cannot specify the number of printouts.)

The DPOF (Digital Print Order Format) standard is used to select images for printing on your camcorder.

1 Slide the POWER switch to select the PLAY/EDIT mode.

2 Touch [PB].

→ continued

3 Touch .

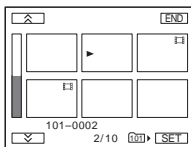

Note

- Do not mark images on your camcorder if the “Memory Stick” already has some images with the Print mark put on other devices. This may change the information of the images with the Print mark put on the other device.

4 Touch [SET].

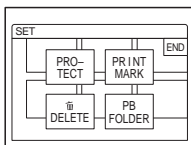

5 Touch [PRINT MARK].

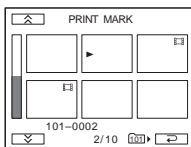

6 Touch the image that you want to print out later.

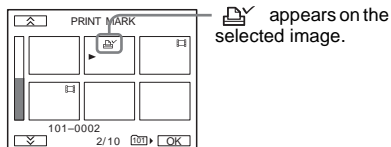

7 Touch [OK].

8 Touch [END].

To cancel the Print mark

Follow steps 1 to 5, then touch the image to cancel the Print mark.

 disappears from the image.

Printing recorded images (PictBridge compliant printer)

You can easily print still images recorded on your camcorder by using a PictBridge compliant printer, even if you do not have a computer. Just set the connection in the menu setting screen of your camcorder, then connect your camcorder and printer using the USB cable.

PictBridge

Tip

- PictBridge is an industry standard established by the Camera & Imaging Products Association (CIPA). You can print still images without using a computer by connecting a printer directly to a digital video camera or digital still camera, regardless of model manufacturer.

Insert the “Memory Stick” on which still images are stored into your camcorder, set the paper in the printer, and turn on the power.

Connecting your camcorder to the printer

Note

- Connect the supplied AC Adaptor to the wall outlet for the power supply.

1 Slide the **POWER** switch repeatedly to select the **PLAY/EDIT** mode.

2 Select **[P-MENU]**.

3 Touch **[MENU]**.

4 Select  (**STANDARD SET**), then **[USB-PLY/EDT]** by touching / and **[OK]**.

5 Select **[PictBridge]**, then touch **[OK]**.

6 Touch .

7 **Connect the USB jack (p. 128) of your camcorder to a printer using the supplied USB cable.**

The location of the USB jack of the printer differs depending on the model. Refer to the operating instructions supplied with your printer for details on operation.

8 Select  (**PICT. APPLI**), then **[PRINT]** by touching / and **[OK]**.

When connection between your camcorder and printer is complete,  appears on the screen.

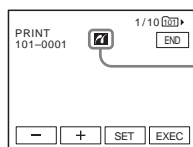



PictBridge indication

One of the images stored on the “Memory Stick” will be displayed.

Notes

- We cannot guarantee the operation of models that are not PictBridge compatible.
- You cannot connect your camcorder to the printer if **[USB-PLY/EDT]** in the menu settings is not set to **[PictBridge]**. Follow the instructions shown on the screen.

Printing

1 Select the image to be printed by touching  (previous image)/ (next image).

2 Touch **[SET]**, then **[COPIES]**.

→ continued

3 Select the number of copies to be printed by touching /, then touch .

You can set a maximum of 20 copies of one image to be printed.

4 Touch [END].

To print the date on the image

1 Touch [SET], then [DATE/TIME].

2 Select [DATE] or [DAY&TIME] and .

The default setting is [OFF].

5 Touch [EXEC].

A confirmation screen appears.

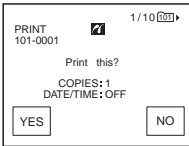

6 Touch [YES].

When printing is finished, [Printing...] disappears and the image selection screen appears again.

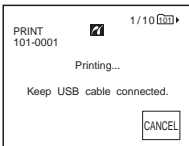

To print another image

Repeat steps 1 to 6.

To stop printing

Touch [CANCEL] while printing.

To finish printing

Touch [END] and disconnect the USB cable from your camcorder and printer.

⚠ Notes

- Do not attempt the following operations when is on the screen. The operations may not be performed properly.
 - Slide the POWER switch to select other power modes.
 - Disconnecting the USB cable from your camcorder or printer.
 - Removing the “Memory Stick” from your camcorder.
- If the printer stops working, disconnect the USB cable and restart the operation from the beginning.
- Some printer models may not support the date printing function. Refer to the operating instructions of your printer for details.
- We cannot guarantee the printing of images recorded with a device other than your camcorder.

Troubleshooting

If you run into any problem using your camcorder, use the following table to troubleshoot the problem. If the problem

persists, remove the power source and contact your Sony dealer.

If “C:□□:□□” is displayed on the LCD screen or the viewfinder, the self-diagnosis display function is activated. See page 110 for details.

Overall operations

Symptom	Cause and/or Corrective Actions
The power does not turn on.	<ul style="list-style-type: none"> • The battery pack is discharged, running low, or not attached to the camcorder. → Attach a charged battery pack to the camcorder. (p. 14) → Use the AC Adaptor to connect to the wall outlet. (p. 17)
The camcorder does not operate even when the power is set to on.	→ Disconnect the AC Adaptor from a wall outlet or remove the battery pack, then reconnect it after about 1 minute. If the functions still do not work, press the RESET button using a sharp-pointed object. (If you press the RESET button, all settings including the clock setting (except the Personal Menu items) are reset.)
The supplied Remote Commander does not function.	<ul style="list-style-type: none"> → Set [REMOTE CTRL] on the  (STANDARD SET) menu to [ON]. (p. 80) → Insert a battery into the battery holder with the + – polarities correctly matching the + – marks. If this still does not solve the problem, insert a new battery since the battery is dead. (p. 129) → Remove any obstructions between the Remote Commander and the remote sensor.



→ continued

Batteries/Power sources

Symptom	Cause and/or Corrective Actions
The CHG (charge) lamp does not light while the battery pack is being charged.	<ul style="list-style-type: none"> → Attach the battery pack to the camcorder correctly. If the lamp still does not light up, then it indicates that no power is supplied from the wall outlet. • The battery charge is completed. (p. 14)
The CHG (charge) lamp flashes while the battery pack is being charged.	<ul style="list-style-type: none"> → Attach the battery pack to the camcorder correctly. If the problem persists, disconnect the AC Adaptor from the wall outlet and contact your Sony dealer. The battery pack may be damaged. (p. 14)
The battery pack is quickly discharged.	<ul style="list-style-type: none"> • The temperature of the environment is too low, or the battery pack has not been charged enough. This is not a malfunction. → Fully charge the battery again. If the problem persists, replace the battery pack with a new one. It may be damaged. (p. 14, 118)
The remaining battery time indicator does not indicate the correct time.	<ul style="list-style-type: none"> • The temperature of the environment is too high or too low, or the battery pack has not been charged enough. This is not a malfunction. → Fully charge the battery again. If the problem persists, replace the battery pack with a new one. It may be damaged. (p. 14, 118)
The power turns off frequently although the remaining battery indicator indicates that the battery pack has enough power to operate.	<ul style="list-style-type: none"> • A problem has occurred in the remaining battery time indicator, or the battery pack has not been charged enough. → Fully charge the battery again to correct the indication. (p. 14)
The power abruptly turns off.	<ul style="list-style-type: none"> • [A.SHUT OFF] in the  (STANDARD SET) menu is set to [5 min]. (p. 81) → When approximately 5 minutes have elapsed while you do not operate your camcorder, the camcorder is automatically turned off. Slide the POWER switch down to turn the power on again. (p. 17) Or use the AC Adaptor.
A problem occurs when the camcorder is connected to the AC Adaptor.	<ul style="list-style-type: none"> → Turn off the power, and disconnect the AC Adaptor from the wall outlet. Then, connect it again.

Cassette tapes

Symptom	Cause and/or Corrective Actions
Cassette cannot be ejected from the compartment.	<ul style="list-style-type: none"> → Make sure the power source (battery pack or AC Adaptor) is connected correctly. (p. 14) → Remove the battery pack from the camcorder, then attach it again. (p. 14) → Attach a charged battery pack to the camcorder. (p. 14)
Cassette is not ejected even when the cassette lid is open.	<ul style="list-style-type: none"> • Moisture condensation is starting in your camcorder. (p. 121)

Symptom	Cause and/or Corrective Actions
The remaining tape indicator is not displayed.	→ Set [ REMAINING] to [ON] on the  (STANDARD SET) menu to always display the remaining tape indicator. (p. 80)







LCD screen/viewfinder

Symptom	Cause and/or Corrective Actions
An unknown language appears on the screen.	→ See page 22.
An unknown picture appears on the screen.	<ul style="list-style-type: none"> The camcorder is in [DEMO MODE]. (The [DEMO MODE] is automatically displayed when you leave the camcorder for 10 minutes after selecting CAMERA-TAPE without inserting a cassette and “Memory Stick.”) Touch on the LCD screen or insert a cassette or “Memory Stick” to cancel [DEMO MODE]. You can also set [DEMO MODE] to [OFF] on the menu. (p. 72)
An unknown indicator appears on the screen.	→ Refer to the indicator list. (p. 131)
The letters on the screen are larger than usual, or the menu settings ( (CAMERA SET) etc.) are not displayed.	→ Press the EASY button to cancel Easy Handycam operation (p. 33, 51).
The buttons do not appear on the touch panel.	<ul style="list-style-type: none"> → Touch the LCD panel lightly. → Press DSPL/BATT INFO (or DISPLAY on the Remote Commander). (p. 54)
The buttons on the touch panel do not work correctly or do not work at all.	→ Adjust the screen ([CALIBRATION]). (p. 122)
The picture in the viewfinder is not clear.	→ Use the viewfinder lens adjustment lever to adjust the lens. (p. 18)
The picture in the viewfinder has disappeared.	→ Close the LCD panel. The picture is not displayed in the viewfinder when the LCD panel is open. (p. 18)

→ continued

Recording











If you are using a “Memory Stick” for recording, refer also to the “Memory Stick” section. (p. 108)

Symptom	Cause and/or Corrective Actions
The tape does not start when you press REC START/STOP.	<ul style="list-style-type: none"> →Slide the POWER switch to turn on the CAMERA-TAPE lamp. (p. 17) →The tape has reached the end. Rewind it, or insert a new cassette. →Set the write-protect tab to REC or insert a new cassette. (p. 115) →The tape is stuck to the drum due to moisture condensation. Remove the cassette and leave your camcorder for at least 1 hour, then re-insert the cassette. (p. 121)
The power abruptly turns off.	<ul style="list-style-type: none"> • [A.SHUT OFF] in the  (STANDARD SET) menu is set to [5 min]. (p. 81) <ul style="list-style-type: none"> →When approximately 5 minutes have elapsed while you do not operate your camcorder, the camcorder is automatically turned off. Slide the POWER switch down to turn the power on again. (p. 17) Or use the AC Adaptor. →Charge the battery pack. (p. 14)
The SteadyShot does not function.	<ul style="list-style-type: none"> →Set [STEADYSHOT] to [ON] in the  (CAMERA SET) menu. (p. 64) →Set [16:9 WIDE] to [OFF] in the  (CAMERA SET) menu. (p. 63)
The auto focus does not function.	<ul style="list-style-type: none"> →Set [FOCUS] to [AUTO] in the  (CAMERA SET) menu to enable auto focus. (p. 39) →The recording conditions are not suitable for auto focus. Adjust the focus manually. (p. 39)
A vertical band appears when recording candlelight or electric light in the dark.	<ul style="list-style-type: none"> • This occurs when the contrast between the subject and the background is too high. This is not a malfunction.
A vertical band appears when recording a bright subject.	<ul style="list-style-type: none"> • This phenomenon is called the smear effect. This is not a malfunction.
Tiny spots in white, red, blue, or green appear on the screen.	<ul style="list-style-type: none"> • The spots appear when you are recording in [SLOW SHUTTR], Super NightShot plus, or Color Slow Shutter. This is not a malfunction. (p. 37, 41)
The color of the picture is not correctly displayed.	<ul style="list-style-type: none"> →Deactivate the NightShot plus function. (p. 37)
Picture appears too bright on the screen, and the subject does not appear on the screen.	<ul style="list-style-type: none"> →Deactivate the NightShot plus function in bright places. (p. 37) →Cancel the back light function. (p. 35)
The shutter sound is not heard.	<ul style="list-style-type: none"> →Set [BEEP] to [MELODY] or [NORMAL] on the  (STANDARD SET) menu. (p. 81)
Black bands appear when you record a TV screen or computer screen.	<ul style="list-style-type: none"> →Set [STEADYSHOT] to [OFF] on the  (CAMERA SET) menu. (p. 64)
Flickering or changes in color occurs.	<ul style="list-style-type: none"> →This occurs when recording pictures under a fluorescent lamp, sodium lamp, or mercury lamp in the soft portrait or sports lesson mode. Cancel [PROGRAM AE] in this case. (p. 61)
END SEARCH does not work.	<ul style="list-style-type: none"> • The cassette was ejected after recording. • The cassette is new and has nothing recorded.

Symptom	Cause and/or Corrective Actions
END SEARCH does not work correctly.	<ul style="list-style-type: none"> • There is a blank section in the beginning or middle of the tape. This is not a malfunction.
The built-in light does not function.	<ul style="list-style-type: none"> → Press LIGHT repeatedly to select  ON. → If the problem persists, contact your Sony dealer or local authorized Sony service facility.

Playback

If you are playing back the pictures stored on a “Memory Stick,” refer also to the “Memory Stick” section. (p. 108)



Symptom	Cause and/or Corrective Actions
Cannot play back.	<ul style="list-style-type: none"> → If the tape has reached the end, rewind the tape. (p. 46)
Horizontal lines appear on the picture. The displayed pictures are not clear or do not appear.	<ul style="list-style-type: none"> → Clean the head using the cleaning cassette (optional). (p. 121)
No sound or only a low sound is heard.	<ul style="list-style-type: none"> → Set [MULTI-SOUND] to [STEREO] in the  (STANDARD SET) menu. (p. 76) → Turn up the volume. (p. 46) → On the  (STANDARD SET) menu, adjust [AUDIO MIX] from the [ST2] (sub sound) side until the sound is heard appropriately. (p. 78) → When you are using an S VIDEO plug, make sure the red and white plugs of the A/V connecting cable are connected as well. (p. 56)
The sound breaks off.	<ul style="list-style-type: none"> → Clean the head using the cleaning cassette (optional). (p. 121)
Cannot perform the Date search with the recording date displayed on the screen.	<ul style="list-style-type: none"> • There is a blank section in the beginning or middle of the tape. This is not a malfunction.
The picture is not played back correctly.	<ul style="list-style-type: none"> → For DCR-TRV460: Set [PB MODE] to [  / ] in the  (STANDARD SET) menu for the tape recorded on other devices in Hi8  / standard 8 mm  system. (p. 79) → For DCR-TRV460: Set [PB MODE] to [AUTO] in the  (STANDARD SET) menu for the tape recorded in Digital8  system. (p. 79)
“---” is displayed on the screen.	<ul style="list-style-type: none"> • The tape you are playing was recorded without setting the date and time. • A blank section on the tape is being played. • The data code on a tape with a scratch or noise cannot be read.
END SEARCH does not work.	<ul style="list-style-type: none"> • The cassette was ejected after recording. • The cassette is new and has nothing recorded.
END SEARCH does not work correctly.	<ul style="list-style-type: none"> • There is a blank section in the beginning or middle of the tape. This is not a malfunction.

→ continued

“Memory Stick”

Symptom	Cause and/or Corrective Actions
Cannot operate functions using the “Memory Stick.”	<ul style="list-style-type: none"> →Set the POWER switch to the CAMERA-MEMORY or PLAY/EDIT mode. (p. 17) → Insert a “Memory Stick” into your camcorder. (p. 21) • The “Memory Stick” was formatted on a personal computer. <ul style="list-style-type: none"> →Format it on your camcorder (Note that all recorded data will be deleted). (p. 66)
Cannot record on the “Memory Stick.”	<ul style="list-style-type: none"> →Release the lock on the write-protect tab of the “Memory Stick.” (p. 116) →The capacity is full. Delete unnecessary pictures recorded on the “Memory Stick.” (p. 98) →Format the “Memory Stick” on your camcorder or insert another “Memory Stick.” (p. 66) • The “100MSDCF” folder is selected. You cannot record pictures to the “100MSDCF” folder. This folder is used for playback only.
The pictures are not played back in the actual size.	<ul style="list-style-type: none"> • Pictures recorded on other devices may not appear in the actual size. This is not a malfunction.
Image data cannot be played back.	<ul style="list-style-type: none"> • Image data cannot be played back when you modify files or folders, or edit the data on a computer. (The file name flashes in that case.) This is not a malfunction. (p. 117) • Pictures recorded on other devices may not be played back. This is not a malfunction.
Pictures cannot be deleted.	<ul style="list-style-type: none"> →Release the lock on the write-protect tab of the “Memory Stick.” (p. 116) →Cancel image protection on the picture. (p. 99) • The maximum number of pictures that you can delete at one time is 100. Delete them in groups of less than 100 pictures each.
Cannot format the “Memory Stick.”	<ul style="list-style-type: none"> →Release the lock on the write-protect tab of the “Memory Stick.” (p. 116)
Cannot delete all pictures at once.	<ul style="list-style-type: none"> →Release the lock on the write-protect tab of the “Memory Stick.” (p. 116) →Cancel image protection on the picture. (p. 99)
Image protection cannot be applied.	<ul style="list-style-type: none"> →Release the lock on the write-protect tab of the “Memory Stick.” (p. 116) →Perform the operation again on the index screen. (p. 99)
Cannot mark pictures for print.	<ul style="list-style-type: none"> →Release the lock on the write-protect tab of the “Memory Stick.” (p. 116) →Perform the operation again on the index screen. (p. 99) • The maximum number of pictures you can mark for print is 999. • Movies cannot be marked for print.
The data file name is not indicated correctly.	<ul style="list-style-type: none"> • Only the file name is displayed if the directory structure does not conform to the universal standard. • The file is damaged. • The file format is not supported on your camcorder. (p. 116)
The data file name flashes.	<ul style="list-style-type: none"> • The file is damaged. • The file format is not supported on your camcorder. (p. 116)

Dubbing/Editing







Symptom	Cause and/or Corrective Actions
Pictures from connected devices are not displayed on the LCD screen or the viewfinder.	→Set [DISPLAY] to [LCD PANEL] in the  (STANDARD SET) menu. (p. 81)
Still pictures cannot be dubbed from a tape to a "Memory Stick."	<ul style="list-style-type: none"> You cannot record or a distorted picture may be recorded if the tape has been used repeatedly for recording.
Movies cannot be dubbed from a tape to a "Memory Stick."	<ul style="list-style-type: none"> You cannot record or a distorted picture may be recorded in the following: <ul style="list-style-type: none"> The tape has a blank section. The tape has been used repeatedly for recording. Input signal has been interrupted or cut.
Digital program editing on the tape does not function.	<ul style="list-style-type: none"> →Set the input selector on the VCR correctly, then check the connection between your camcorder and the VCR. (p. 86) →When your camcorder is connected to a DV device that is not a Sony product via an i.LINK cable, select [IR] in step11 of "Step 1: Preparing your camcorder and VCR for operation" (p. 91). →Adjust the synchronization of the VCR. (p. 94) →Enter a correct [IR SETUP] code. (p. 93) →Select the mode used to cancel recording pause again. (p. 93) →Set your camcorder and the VCR more than 30 cm (12 in.) apart. (p. 93) →Set [PB MODE] to [AUTO] in the  (STANDARD SET) menu. (p. 79) The program may not be set to a blank section on the tape.
The VCR is not responding properly during Digital program editing when it is connected via an i.LINK cable.	<ul style="list-style-type: none"> While connecting via an i.LINK cable, select [IR] in step 11 of "Step 1: Preparing your camcorder and VCR for operation" (p. 91).
Digital program editing on the "Memory Stick" does not function correctly.	<ul style="list-style-type: none"> The program may not be set to a blank section on the tape. You cannot record or a distorted picture may be recorded if the tape has been used repeatedly for recording.

Warning indicators and messages

Self-diagnosis display/Warning indicators

If indicators appear on the screen or in the viewfinder, check the following. See the page in parentheses for details.

Indication	Cause and/or Corrective Actions
C:□□:□□/E:□□:□□ (Self-diagnosis display)	<p>Some symptoms can be fixed by yourself. If the problem persists even after you tried a couple of times, contact your Sony dealer or local authorized Sony service facility.</p> <p>C:04:□□</p> <p>→ A battery pack that is not an "InfoLITHIUM" battery pack is being used. Use an "InfoLITHIUM" battery pack. (p. 118)</p> <p>C:21:□□</p> <p>→ Moisture condensation has occurred. Remove the cassette and leave your camcorder for at least 1 hour, then re-insert the cassette. (p. 121)</p> <p>C:22:□□</p> <p>→ Clean the head using a cleaning cassette (optional). (p. 121)</p> <p>C:31:□□ / C:32:□□</p> <p>→ Symptoms that are not described above have occurred. Remove and insert the cassette, then operate your camcorder again. Do not perform this procedure if moisture starts to condense. (p. 121)</p> <p>→ Remove the power source. Reconnect it again and operate your camcorder again.</p> <p>→ Change the tape.</p> <p>→ Press the RESET button and operate your camcorder again (p. 126).</p> <p>E:61:□□ / E:62:□□</p> <p>→ Contact your Sony dealer or local authorized Sony service facility. Inform them of the 5-digit code, which starts from "E."</p>
101-0001 (Warning indicator pertaining to files)	<ul style="list-style-type: none"> • The file is damaged. • The file is unreadable. • You are trying to carry out the MEMORY MIX function on a movie (p. 43).
⏻ (Battery level warning)	<ul style="list-style-type: none"> • The battery pack is nearly used up. • Depending on the operating, environmental, or battery conditions, the ⏻ indicator may flash, even if there are approximately 5 to 10 minutes remaining.
☑ (Moisture condensation warning)*	<p>→ Eject the cassette, set the POWER switch to (CHG) OFF, and leave it for about 1 hour with the cassette lid open (p. 121).</p>
⏻ (Warning indicator pertaining to the "Memory Stick")	<ul style="list-style-type: none"> • No "Memory Stick" is inserted.











Indication	Cause and/or Corrective Actions
 (Warning indicator pertaining to “Memory Stick” formatting)*	<ul style="list-style-type: none"> • The “Memory Stick” data is damaged. • The “Memory Stick” is not formatted correctly (p. 66).
 (Warning indicator pertaining to incompatible “Memory Stick”)*	<ul style="list-style-type: none"> • An incompatible “Memory Stick” is inserted.
 (Warning indicator pertaining to the tape)	<p>Slow flashing:</p> <ul style="list-style-type: none"> • There is less than 5 minutes remaining on the tape. • No cassette is inserted.* • The write-protect tab on the cassette is set to lock (p. 115).* <p>Fast flashing:</p> <ul style="list-style-type: none"> • The tape has run out.*
 (Eject cassette warning)*	<p>Slow flashing:</p> <ul style="list-style-type: none"> • The write-protect tab on the cassette is set to lock (p. 115). <p>Fast flashing:</p> <ul style="list-style-type: none"> • Moisture condensation has occurred (p. 121). • The self-diagnosis display code is displayed (p. 110).
 (Warning indicator pertaining to image deletion)*	<ul style="list-style-type: none"> • The image is protected (p. 99).
  (Warning indicator pertaining to the write-protect of the “Memory Stick”)*	<ul style="list-style-type: none"> • The write-protect tab on the “Memory Stick” is set to lock. (p. 116)



* You hear a melody or beep sound when the warning indicators appear on the screen.

→ continued

Warning messages

If messages appear on the screen, check the following. See the page in parentheses for details.

Subjects	Indications	Corrective Actions/References
Battery	Use the "InfoLITHIUM" battery pack.	→See page 118.
	Battery level is low.	→Charge the battery (p. 14).
	Old battery. Use a new one.	→See page 118.
	▲ Re-attach the power source.	–
Moisture condensation	 ▲ Moisture condensation. Eject the cassette.	→See page 121.
	 Moisture condensation. Turn off for 1H.	→See page 121.
Cassette/tape	 Insert a cassette.	→See page 20.
	▲ Reinsert the cassette.	→The cassette might be damaged, etc.
	 ▲ The tape is locked - check the tab.	→See page 115.
	 The tape has reached the end.	–
"Memory Stick"	 Insert a Memory Stick.	→See page 21.
	 Reinsert the Memory Stick.	→Reinsert the "Memory Stick" a few times. →Format the "Memory Stick." (p. 66) • The "Memory Stick" might be damaged. Try with another "Memory Stick."
	Do not eject the Memory Stick during writing.	–
	This is a read-only Memory Stick.	–
	 Incompatible type of Memory Stick.	→See page 116.
	 This Memory Stick is not formatted correctly.	→Check the format, then format the "Memory Stick" as necessary (p. 66).
	Cannot record. The Memory Stick is full.	→Delete unnecessary images (p. 98).
	  The Memory Stick is locked - check the tab.	→See page 116.
	Cannot playback. Reinsert the Memory Stick.	–
	Cannot record. Reinsert the Memory Stick.	–
	No file.	• No file is recorded or there is no readable file on the "Memory Stick."
	NO FILE AVAILABLE.	• There is no file in the selected folder.
	USB streaming... This function is not available.	• You tried to play back or record on a "Memory Stick" during USB Streaming.

Subjects	Indications	Corrective Actions/References
“Memory Stick”	Memory Stick folders are full.	<ul style="list-style-type: none"> You cannot create folders exceeding 999MSDCF. You cannot delete the created folders using your camcorder. You will have to format the “Memory Stick” (p. 66), or delete them using your computer.
	Cannot record still images on Memory Stick.	–
	Cannot record Memory Stick movie on a tape.	–
PictBridge compliant printer	Check the connected device.	→Switch off the printer and switch it on again, then disconnect the USB cable and reconnect it.
	Connect the camcorder to a PictBridge compatible printer.	→Switch off the printer and switch it on again, then disconnect the USB cable and reconnect it.
	Check the printer.	→Check the printer.
	Error-Cancel the task.	→Check the printer.
	Cannot print. Check the printer.	→Switch off the printer and switch it on again, then disconnect the USB cable and reconnect it.
Others	Cannot record due to copyright protection.	–
	Cannot record 44.1 kHz audio on a Memory Stick.	–
	Already added to CAMERA-TAPE mode’s P-MENU.	–
	Already added to CAMERA-MEMORY mode’s P-MENU.	–
	Already added to PLAY/EDIT mode’s P-MENU.	–
	 Dirty video head. Use a cleaning cassette.	→See page 121.
	Cannot start Easy Handycam	–
	Cannot cancel Easy Handycam	–
	Cannot start Easy Handycam with USB connected	–
	Cannot cancel Easy Handycam with USB connected	–
	Invalid button with Easy Handycam operation	–
	USB is invalid in this mode during Easy Handycam	<ul style="list-style-type: none"> You can select [STD-USB] in PLAY/EDIT mode during Easy Handycam operation, but you cannot select [PictBridge] or [USB STREAM]. (The message disappears when you touch .)

Using your camcorder abroad

Power supply

You can use your camcorder in any country/regions using the AC Adaptor supplied with your camcorder within AC 100 V to 240 V, 50/60 Hz.

Use a commercially available AC plug adaptor [a], if necessary, depending on the design of the wall outlet [b].



On TV color systems

Your camcorder is an NTSC system-based camcorder. If you want to view the playback picture on a TV, it must be an NTSC system-based TV (see following list) with the AUDIO/VIDEO input jack.

System	Used in
NTSC	Bahama Islands, Bolivia, Canada, Central America, Chile, Colombia, Ecuador, Guyana, Jamaica, Japan, Korea, Mexico, Peru, Surinam, Taiwan, the Philippines, the U.S.A., Venezuela, etc.
PAL	Australia, Austria, Belgium, China, Czech Republic, Denmark, Finland, Germany, Holland, Hong Kong, Hungary, Italy, Kuwait, Malaysia, New Zealand, Norway, Poland, Portugal, Singapore, Slovak Republic, Spain, Sweden, Switzerland, Thailand, United Kingdom, etc.
PAL - M	Brazil
PAL - N	Argentina, Paraguay, Uruguay
SECAM	Bulgaria, France, Guiana, Iran, Iraq, Monaco, Russia, Ukraine, etc.

Simple setting of clock by time difference

You can easily set the clock to the local time by setting a time difference when using your camcorder abroad. Select [WORLD TIME] in the  (TIME/LANGU.) menu, then set the time difference (p. 82).

Usable cassette tapes

You can use standard 8 mm **8** and Hi8 **Hi8**, Digital8 **D** video cassettes on your camcorder.

Digital8 **D** system

This video system has been developed to enable digital recording to Hi8 **Hi8**/Digital8 **D** video cassette.

The recording time when you use your Digital8 **D** system camcorder on Hi8 **Hi8**/standard 8 mm **8** tape is half of the recording time when using the conventional Hi8 **Hi8**/standard 8 mm **8** system camcorder. (120 minutes of recording time becomes 60 minutes in the SP mode.)

Hi8 **Hi8** system

This Hi8 **Hi8** system is an extension of the standard 8 mm **8** system, and was developed to produce higher quality pictures.

You cannot play back a tape recorded in the Hi8 **Hi8** system correctly on video recorders/players other than a Hi8 video recorder/player.

To prevent a blank section from being made on the tape

Touch **→I** to go to the end of the recorded section before you begin the next recording in the following cases:

- You have ejected the cassette during recording.
- You have played back the tape.
- You have used EDIT SEARCH.

If there is a blank section or discontinuous signals on your tape, re-record from the beginning to the end of the tape as described above.

Copyright signal

When you play back

If the cassette you play back on your camcorder contains copyright signals, you cannot copy it to a tape in another video camera connected to your camcorder.

When you record

You cannot record software on your camcorder that contains copyright control signals for copyright protection of software.

[Cannot record due to copyright protection.] appears on the LCD screen, or on the TV screen if you try to record such software.

Your camcorder does not record copyright control signals on the tape when it records.

Notes on use

To prevent accidental erasure

Slide the write-protect tab on the cassette to set to SAVE.

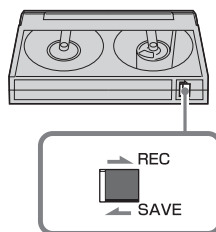

REC: The cassette can be recorded.

SAVE: The cassette cannot be recorded (write-protected).

When labeling the cassette

Be sure to place the label only on the locations as shown in the following illustration so as not to cause malfunction of your camcorder.

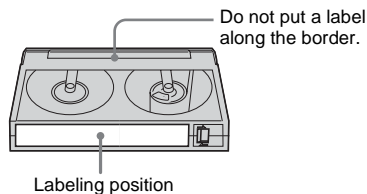

After using the cassette

Rewind the tape to the beginning to avoid distortion of the picture or the sound. The cassette should then be put in its case, and stored in an upright position.

- **8**, **Hi8** and **D** are trademarks.

About the “Memory Stick”

The “Memory Stick” is a new light and small recording media which, despite its size, can store more data than a floppy disk.

You can use following types of “Memory Stick” on your camcorder. However, appearance on the list does not guarantee the operation of all types of “Memory Stick” on your camcorder.

Types of “Memory Stick”	Recording/ Playback
“Memory Stick”	○
“Memory Stick Duo” ^{*1}	○
“MagicGate Memory Stick”	○ ^{*2}
“MagicGate Memory Stick Duo” ^{*1}	○ ^{*2}
“Memory Stick PRO”	○ ^{*2}
“Memory Stick PRO Duo” ^{*1}	○ ^{*2}

*1 Attach the Memory Stick Duo adaptor before inserting it into the camcorder.

*2 “MagicGate” is a copyright protection technology that records and transfers the contents in an encrypted format. Note that data that uses “MagicGate” technology cannot be recorded or played on your camcorder.

- Still image format: Your camcorder compresses and records image data in the JPEG (Joint Photographic Experts Group) format. The file extension is “.JPG.”
- Movie format: Your camcorder compresses and records picture data in the MPEG (Moving Picture Experts Group) format. The file extension is “.MPG.”
- File names of still images:
 - 101-0001: This file name appears on the screen of your camcorder.
 - DSC00001.JPG: This file name appears on the display of a computer.
- File names of movies:
 - MOV00001: This file name appears on the screen of your camcorder.
 - MOV00001.MPG: This file name appears on the display of a computer.

- On a “Memory Stick” formatted on a computer: A “Memory Stick” formatted by the Windows OS or using Macintosh computers does not have guaranteed compatibility with your camcorder.
- Data read/write speed may vary depending on the combination of the “Memory Stick” and “Memory Stick” compliant product you use.

To prevent accidental erasure of images

Slide the write-protect tab on the “Memory Stick” to the write-protect position. The position and shape of the write-protect tab may be different depending on the model.

Back of the “Memory Stick”

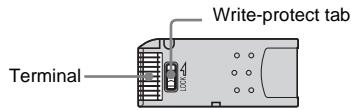

Notes on use

Image data may be damaged in the following cases. Compensation for damaged image data will not be made.

- If you eject the “Memory Stick,” turn the power off on your camcorder, or remove the battery pack for replacement while your camcorder is reading or writing image files on the “Memory Stick” (while the access lamp is lit or flashing).
- If you use the “Memory Stick” near magnets or magnetic fields.

It is recommended you take a back-up of important data on the hard disk of a computer.

On handling

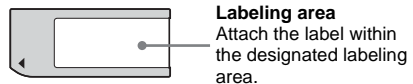

Keep the following notes in mind when handling a “Memory Stick.”

- When you carry or store a “Memory Stick,” put it in its case.
- Do not touch, or allow metallic objects to come into contact with the terminal.

- Do not bend, drop or apply strong force to the “Memory Stick.”
- Do not disassemble or modify the “Memory Stick.”
- Do not let the “Memory Stick” get wet.
- Do not insert any objects other than a compliant “Memory Stick” into the “Memory Stick” slot. It may cause a malfunction.

On location for use

Do not use or keep the “Memory Stick” in the following locations.

- Places subject to extremely high temperature, such as a car parked outside in the summer.
- Places under direct sunlight.
- Places with extremely high humidity or subject to corrosive gases.

Note on using the “Memory Stick Duo”

You can use a “Memory Stick Duo” in your camcorder after inserting it into the Memory Stick Duo adaptor.

You may damage the “Memory Stick Duo” or the “Memory Stick” slot on your camcorder in the following situations.

- When you insert a “Memory Stick Duo” that is not inserted into a Memory Stick Duo adaptor into the “Memory Stick” slot on your camcorder.
- When you insert the “Memory Stick Duo” in the wrong direction.

If you insert a “Memory Stick Duo” without a Memory Stick Duo adaptor by mistake, hold the camcorder so the “Memory Stick” slot is facing down, then hold the lid aside using a toothpick or similar object to let the “Memory Stick Duo” slide out.

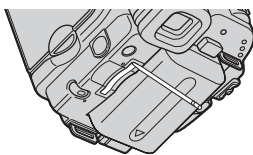

Notes on using the “Memory Stick PRO”

- The maximum memory capacity of a “Memory Stick” that can be used on your camcorder is 1 GB (512 MB for a “Memory Stick PRO Duo”).

- This unit does not support high speed data transfer.

Notes on image data compatibility

- Image data files recorded on a “Memory Stick” by your camcorder conform to the Design Rule for Camera File Systems universal standard established by the JEITA (Japan Electronics and Information Technology Industries Association).
- On your camcorder, you cannot play back still images recorded on other device (DCR-TRV890E/TRV900/TRV900E or DSC-D700/D770) that does not conform to the universal standard. (These models are not sold in some regions.)
- If you cannot use a “Memory Stick” that has been used with other device, format it with your camcorder (p. 66). Note that formatting erases all information on the “Memory Stick.”
- You may not be able to play back images with your camcorder:
 - When playing back image data modified on your computer.
 - When playing back image data recorded with other device.

-
- “Memory Stick,”  and “MagicGate Memory Stick” are trademarks of Sony Corporation.
 - “Memory Stick Duo” and “MEMORY STICK DUO” are trademarks of Sony Corporation.
 - “Memory Stick PRO” and “MEMORY STICK PRO” are trademarks of Sony Corporation.
 - “MagicGate” and “MAGICGATE” are trademarks of Sony Corporation.
 - All other product names mentioned herein may be the trademarks or registered trademarks of their respective companies. Furthermore, “™” and “®” are not mentioned in each case in this manual.

About the “InfoLITHIUM” battery pack

This unit is compatible with the “InfoLITHIUM” battery pack (M series). Your camcorder operates only with the “InfoLITHIUM” battery pack. “InfoLITHIUM” M series battery packs have the  mark.

What is the “InfoLITHIUM” battery pack?

The “InfoLITHIUM” battery pack is a lithium-ion battery pack that has functions for communicating information related to operating conditions between your camcorder and an optional AC Adaptor/charger.

The “InfoLITHIUM” battery pack calculates the power consumption according to the operating conditions of your camcorder, and displays the remaining battery time in minutes. With an AC Adaptor/charger (optional), the remaining battery time and charging time appear.

To charge the battery pack

- Be sure to charge the battery pack before you start using your camcorder.
- We recommend charging the battery pack in an ambient temperature of between 10°C to 30°C (50°F to 86°F) until the CHG (charge) lamp turns off. If you charge the battery pack outside of this temperature range, you may not be able to charge it efficiently.
- After charging is complete, either disconnect the cable from the DC IN jack on your camcorder or remove the battery pack.

To use the battery pack effectively

- Battery pack performance decreases when the surrounding temperature is 10°C (50°F) or below, and the length of time you can use the battery pack becomes shorter. In that case, do one of the following to use the battery pack for a longer time.

- Put the battery pack in a pocket to warm it up, and insert it in your camcorder right before you start taking shots.
- Use a large capacity battery pack: NP-FM50/QM71/QM71D/QM91/QM91D (optional).
- Frequent use of the LCD screen or a frequent playback, fast forward or rewind operation wears out the battery pack faster. We recommend using a large capacity battery pack: NP-FM50/QM71/QM71D/QM91/QM91D (optional).
- Be sure to set the POWER switch to (CHG) OFF when not recording or playing back on your camcorder. The battery pack is also consumed when your camcorder is in recording standby or playback pause.
- Have spare battery packs ready for two or three times the expected recording time, and make trial recordings before making the actual recording.
- Do not expose the battery pack to water. The battery pack is not water resistant.

About remaining battery time indicator

- When the power goes off even though the remaining battery time indicator indicates that the battery pack has enough power to operate, charge the battery pack fully again. The indication on the remaining battery time will be indicated correctly. Note, however, that the battery indication will not be restored if it is used in high temperatures for a long time, or if left in a fully charged state, or when the battery pack is frequently used. Use the remaining battery time indication as a guide to the approximate shooting time.
- The  mark that indicates low battery flashes even if there are still 5 to 10 minutes of battery time remaining, depending on the operating conditions or ambient temperature and environment.

About storage of the battery pack

- If the battery pack is not used for a long time, fully charge the battery pack and use it on your camcorder once a year to maintain the proper function.

To store the battery pack, remove it from your camcorder and put it in a dry, cool place.

- To discharge the battery pack on your camcorder completely, set [A. SHUT OFF] to [NEVER] on the  (STANDARD SET) menu and leave your camcorder in tape recording standby until the power goes off (p. 81).

About battery life

- The battery life is limited. Battery capacity drops little by little as you use it more and more, and as time passes. When the available battery time is shortened considerably, a probable cause is that the battery pack has reached the end of its life. Please buy a new battery pack.
- The battery life varies depending on how it is stored and the operating conditions and environment for each battery pack.

“InfoLITHIUM” is a trademark of Sony Corporation.

About i.LINK

The DV Interface on this unit is an i.LINK-compliant DV Interface. This section describes the i.LINK standard and its features.

What is i.LINK?

i.LINK is a digital serial interface for transferring digital video, digital audio, and other data to other i.LINK-compatible device. You can also control other device using the i.LINK.

i.LINK-compatible device can be connected using an i.LINK cable. Possible applications are operations and data transactions with various digital AV devices.

When two or more i.LINK-compatible device are connected to this unit in a daisy chain, operations and data transactions are possible with not only the device that this unit is connected to but also with other devices via the directly connected device.

Note, however, that the method of operation sometimes varies according to the characteristics and specifications of the device to be connected. Also, operations and data transactions may not be possible on some connected device.

Note

- Normally, only one device can be connected to this unit with the i.LINK cable. When connecting this unit to i.LINK-compatible device having two or more DV Interfaces, refer to the operating instructions of the device to be connected.

Tips

- i.LINK is a more familiar term for the IEEE 1394 data transport bus proposed by Sony, and is a trademark approved by many corporations.
- IEEE 1394 is an international standard standardized by the Institute of Electrical and Electronics Engineers.

→ continued

About i.LINK Baud rate

i.LINK's maximum baud rate varies according to the device. There are three types.

S100 (approx. 100Mbps*)

S200 (approx. 200Mbps)

S400 (approx. 400Mbps)

The baud rate is listed under "Specifications" in the operating instructions of each piece of device. It is also indicated near the i.LINK interface on some device.

The maximum baud rate for device that does not have any indication (such as this unit) is "S100."

The baud rate may differ from the indicated value when the unit is connected to device with a different maximum baud rate.

* What is Mbps?

Mbps stands for "megabits per second," or the amount of data that can be sent or received in one second. For example, a baud rate of 100Mbps means that 100 megabits of data can be sent in one second.

To use i.LINK functions on this unit

For details on how to dub when this unit is connected to other video device having a DV Interface, see page 86, 87.

This unit can also be connected to other i.LINK (DV Interface) compatible device made by Sony (e.g. a VAIO series personal computer) as well as to video device.

Before connecting this unit to your computer, make sure that application software supported by this unit is already installed on your computer.

Some i.LINK compatible video device such as Digital Televisions, DVD recorders/players, and MICROMV recorders/players are not compatible with DV device. Before connecting to other device, be sure to confirm whether the device is compatible with DV device or not.

For details on precautions and compatible application software, refer also to the operating instructions for the device to be connected.

About the required i.LINK cable

Use the Sony i.LINK 4-pin-to-4-pin cable (during DV dubbing).

i.LINK and  are trademarks of Sony Corporation.

Maintenance and precautions

On use and care



- Do not use or store the camcorder and accessories in the following locations.
 - Anywhere extremely hot or cold. Never leave them exposed to temperatures above 60°C (140°F), such as under direct sunlight, near heaters or in a car parked in the sun. They may malfunction or become deformed.
 - Near strong magnetic fields or mechanical vibration. The camcorder may malfunction.
 - Near strong radio waves or radiation. The camcorder may not be able to record properly.
 - Near AM receivers and video equipment. Noise may occur.
 - Sandy beach or anywhere dusty. If sand or dust gets in your camcorder, it may malfunction. Sometimes this malfunction cannot be repaired.
 - Near windows or outdoors, where the LCD screen, the viewfinder, or the lens may be exposed to direct sunlight. This damages the inside of the viewfinder or the LCD screen.
 - Anywhere very humid.
- Operate your camcorder on DC 7.2 V (battery pack) or DC 8.4 V (AC Adaptor).
- For DC or AC operation, use the accessories recommended in these operating instructions.
- Do not let your camcorder get wet, for example, from rain or sea water. If your camcorder gets wet, it may malfunction. Sometimes this malfunction cannot be repaired.
- If any solid object or liquid get inside the casing, unplug your camcorder and have it checked by a Sony dealer before operating it any further.
- Avoid rough handling disassembling, modifying or mechanical shock. Be particularly careful of the lens.
- Keep the POWER switch setting to (CHG) OFF when you are not using your camcorder.

- Do not wrap your camcorder with a towel, for example, and operate it. Doing so might cause heat to build up inside.
- When disconnecting the power cord, pull by the plug and not the cord.
- Do not damage the power cord such as by placing anything heavy on it.
- Keep metal contacts clean.
- Keep the Remote Commander and button-type battery out of children's reach. If the battery is accidentally swallowed, consult a doctor immediately.
- If the battery electrolytic liquid has leaked
 - consult your local authorized Sony service facility.
 - wash off any liquid that may have contacted your skin.
 - if any liquid gets in your eyes, wash with plenty of water and consult a doctor.



When not using your camcorder for a long time

Occasionally turn it on and let it run such as by playing back tapes for about 3 minutes. Otherwise, unplug it from the wall outlet.

Moisture condensation

If your camcorder is brought directly from a cold place to a warm place, moisture may condense inside your camcorder, on the surface of the tape, or on the lens. In this state, the tape may stick to the head drum and be damaged or your camcorder may not operate correctly. If there is moisture inside your camcorder, [ ▲ Moisture condensation. Eject the cassette] or [ Moisture condensation. Turn off for 1H.] appears. The indicator will not appear when the moisture condenses on the lens.

If moisture condensation has occurred

None of the functions except cassette ejection will work. Eject the cassette, turn off your camcorder, and leave it for about one hour with the cassette lid open. Your camcorder can be used again if the  or  does not appear when the power is turned on again.

If moisture starts to condense, your camcorder sometimes cannot detect condensation. If this happens, the cassette is sometimes not ejected for 10 seconds after the cassette lid is opened.

This is not a malfunction. Do not close the cassette lid until the cassette is ejected.

Note on moisture condensation

Moisture may condense when you bring your camcorder from a cold place into a warm place (or vice versa) or when you use your camcorder in a humid place as shown below.

- When you bring your camcorder from a ski slope into a place warmed up by a heating device.
- When you bring your camcorder from an air-conditioned car or room into a hot place outside.
- When you use your camcorder after a squall or a shower.
- When you use your camcorder in a hot and humid place.

How to prevent moisture condensation

When you bring your camcorder from a cold place into a warm place, put your camcorder in a plastic bag and seal it tightly. Remove the bag when the air temperature inside the plastic bag has reached the surrounding temperature (after about one hour).

Video head

- When the video head becomes dirty, you cannot record pictures normally, or distorted picture or sound is played back.
- The video head suffers from wear after long use. If you cannot obtain a clear image even after using a cleaning cassette, it might be because the video head is worn. Please contact your Sony dealer or local authorized Sony service facility to have the video head replaced.
- If the following problem occurs, clean the video heads for 10 seconds with the Sony V8-25CLD cleaning cassette (optional). When you play back in the Digital8  system
 - Mosaic-pattern noise appears on the playback picture or the screen is displayed in blue.



- Playback pictures do not move.

→ continued

- Playback pictures do not appear or the sound breaks off.
- [⊗  Dirty video head. Use a cleaning cassette.] appears on the screen during recording.

For DCR-TRV460:

When you play back in the Hi8 **Hi8**/standard 8 mm **8** system

- [⊗  Dirty video head. Use a cleaning cassette.] appears on the screen during recording.
- Playback pictures contain noise.
- Playback pictures are hardly visible.
- Playback pictures do not appear.

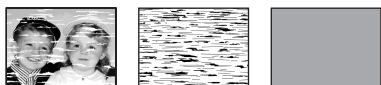

LCD screen

- Do not add excessive pressure on the LCD screen, as it may cause damage.
- If your camcorder is used in a cold place, a residual image may appear on the LCD screen. This is not a malfunction.
- While using your camcorder, the back of the LCD screen may heat up. This is not a malfunction.

To clean the LCD screen

- If fingerprints or dust make the LCD screen dirty, it is recommended you use the cleaning cloth (supplied) to clean it. When you use the LCD Cleaning Kit (optional), do not apply the cleaning liquid directly to the LCD screen. Use cleaning paper moistened with the liquid.

On adjustment of the LCD screen (CALIBRATION)

The buttons on the touch panel may not work correctly. If this happens, follow the procedure below. It is recommended you connect your camcorder to the wall outlet using the supplied AC Adaptor during the operation.

- 1 Slide the POWER switch up to (CHG) OFF.**
- 2 Eject the cassette and “Memory Stick” from your camcorder, then disconnect any connecting cables except the AC Adaptor from your camcorder.**

- 3 Slide the POWER switch repeatedly to select the PLAY/EDIT mode while pressing DSPL/BATT INFO on your camcorder, then press and hold DSPL/BATT INFO for about 5 seconds.**
- 4 Touch the “×” displayed on the screen with an object such as the corner of a “Memory Stick.”**
The position of the “×” changes.

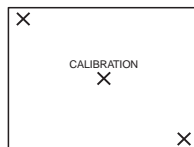

If you did not press the right spot, start from step 4 again.

Note

- You cannot calibrate the LCD screen if you have rotated the LCD panel and set it with the LCD screen facing out.

On handling the casing

- If the casing is soiled, clean the camcorder body with a soft cloth lightly moistened with water, and then wipe the casing with a dry soft cloth.
- Avoid the following to avoid damage to the finish.
 - Using chemicals such as thinner, benzine, alcohol, chemical cloths, repellent and insecticide.
 - Handling with above substances on your hands.
 - Leaving the casing in contact with rubber or vinyl objects for a long period of time.

About care and storage of the lens

- Wipe the surface of the lens clean with a soft cloth in the following instances:
 - When there are fingerprints on the lens surface.
 - In hot or humid locations
 - When the lens is exposed to salty air such as at the seaside.
- Store in a well-ventilated location subject to little dirt or dust.
- To prevent molds periodically clean the lens as described above.

It is recommended you operate your camcorder about once a month to keep it in an optimum state for a long time.

To charge the pre-installed button-type battery

Your camcorder has a pre-installed button-type battery to retain the date, time, and other settings even when the POWER switch is set to (CHG) OFF. The pre-installed button-type battery is always charged while you are using your camcorder but it will get discharged gradually if you do not use your camcorder. The button-type battery will be fully discharged in about **3 months** if you do not use your camcorder at all. However, even if the pre-installed button-type battery is not charged, the camcorder operation will not be affected as long as you are not recording the date.

Procedures

Connect your camcorder to a wall outlet using the supplied AC Adaptor, and leave it with the POWER switch set to (CHG) OFF for more than 24 hours.

Specification

Video camera recorder

System

Video recording system

2 rotary heads, Helical scanning system

Still image recording system

Exif Ver. 2.2*¹

*¹“Exif” is a file format for still images, established by the JEITA (Japan Electronics and Information Technology Industries Association). Files in this format can have additional information such as your camcorder’s setting information at the time of recording.

Audio recording system

Rotary heads, PCM system

Quantization: 12 bits (Fs 32 kHz, stereo 1, stereo 2), 16 bits (Fs 48 kHz, stereo)

Video signal

NTSC color, EIA standards

Usable cassette

8 mm video format cassette

Tape speed

SP: Approx. 28.67 mm/s

LP: Approx. 19.11 mm/s

Recording/playback time (using 120 min. Hi8/Digital8 video cassette)

SP: 60 min

LP: 90 min

Fast forward/rewind time (using 120 min. Hi8/Digital8 video cassette)

Approx. 5 min

Viewfinder

Electric viewfinder (monochrome)

Image device

3.0 mm (1/6 type) CCD (Charge Coupled Device)

Gross: Approx. 460 000 pixels

Effective (still): Approx. 290 000 pixels

Effective (movie): Approx. 290 000 pixels

Lens

Combined power zoom lens

Filter diameter: 37 mm (1 7/16 in.)

20 × (Optical), 990 × (Digital)

F = 1.6 ~ 2.4

→ continued

Focal length

2.5 - 50 mm (1/8 - 2 in.)

When converted to a 35 mm still camera

In CAMERA-TAPE:

42 - 840 mm (1 11/16 - 33 1/8 in.)

In CAMERA-MEMORY:

42 - 840 mm (1 11/16 - 33 1/8 in.)

Color temperature

Auto

Minimum illumination

4 lx (lux) (F 1.6)

0 lx (lux) (during the NightShot plus function)*²

*² Objects unable to be seen due to the dark can be shot with infrared lighting.

Input/Output connectors

S video input/output

Luminance signal: 1 Vp-p, 75 Ω (ohms), unbalanced

Chrominance signal: 0.286 Vp-p, 75 Ω (ohms), unbalanced
4-pin mini DIN

Audio/Video input/output

AV MINIJACK

Video signal: 1 Vp-p, 75 Ω (ohms), unbalanced, sync negative

Audio signal: 327 mV (at output impedance more than 47 kΩ (kilohms)), Input impedance more than 47 kΩ (kilohms), Output impedance with less than 2.2 kΩ (kilohms)
Stereo minijack (φ 3.5mm)

DV input/output

4-pin connector

USB jack

mini-B

LCD screen

Picture

6.2 cm (2.5 type)

Total dot number

123 200 (560 × 220)

General

Power requirements

DC 7.2 V (battery pack)

DC 8.4 V (AC Adaptor)

Average power consumption (when using the battery pack)

During camera recording using the viewfinder
2.9 W

During camera recording using the LCD
3.8 W

Operating temperature

0°C to 40°C (32°F to 104°F)

Storage temperature

-20°C to +60°C (-4°F to +140°F)

Dimensions (approx.)

85 × 98 × 151 mm (3 3/8 × 3 7/8 × 6 in.)
(w/h/d)

Mass (Approx.)

800 g (1 lb 12 oz) main unit only

940 g (2 lb 1 oz) including the NP-FM30 rechargeable battery pack, Hi8/Digital8 cassette, lens cap, and shoulder strap.

Supplied accessories

See page 13.

AC Adaptor AC-L15A/L15B

Power requirements

AC 100 - 240 V, 50/60 Hz

Current consumption

0.35 - 0.18 A

Power consumption

18 W

Output voltage

DC 8.4 V, 1.5 A

Operating temperature

0°C to 40°C (32°F to 104°F)

Storage temperature

-20°C to +60°C (-4°F to +140°F)

Dimensions (approx.)

56 × 31 × 100 mm (2 1/4 × 1 1/4 × 4 in.) (w/h/d) excluding the projecting parts

Mass (approx.)

190 g (6.7 oz) excluding the power cord

Rechargeable battery pack (NP-FM30)

Maximum output voltage

DC 8.4 V

Output voltage

DC 7.2 V

Capacity

5.0 Wh (700 mAh)

Dimensions (approx.)

38.2 × 20.5 × 55.6 mm

(1 9/16 × 13/16 × 2 1/4 in.) (w/h/d)

Mass (approx.)

65 g (2.3 oz)

Operating temperature

0°C to 40°C (32°F to 104°F)

Type

Lithium ion

Types of differences

Model		
DCR-	TRV361	TRV460
Available recording system	Digital8	Digital8
Available playback system	Digital8	Hi8/8/Digital8

Design and specifications are subject to change without notice.

Identifying parts and controls

Camcorder

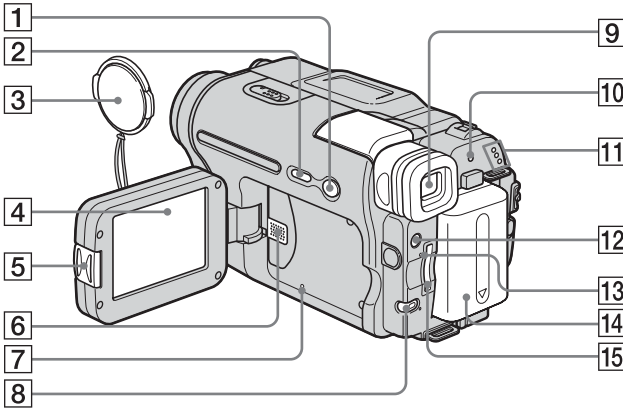

- 1** EASY button (p. 12, 33, 51)
- 2** DSPL/BATT INFO button (p. 15)
- 3** Lens cap (p. 24, 29)
- 4** LCD/Touch panel screen (p. 3, 18)
- 5** OPEN button (p. 18)
- 6** Speaker
- 7** RESET button
If you press RESET, all the settings including the date and time, except the Personal Menu items, return to the default.
- 8** BACK LIGHT button (p. 35)
The BACK LIGHT button is not available during Easy Handycam operation.
(● mark)
- 9** Viewfinder (p. 3, 18)
- 10** CHG (charge) lamp (p. 14)

- 11** CAMERA-TAPE, CAMERA-MEMORY, PLAY/EDIT mode lamps (p. 17)
- 12** LIGHT button (p. 27)
- 13** Access lamp (p. 21, 116)
- 14** Battery pack (p. 14)
- 15** “Memory Stick” slot (p. 21)

To attach the lens cap

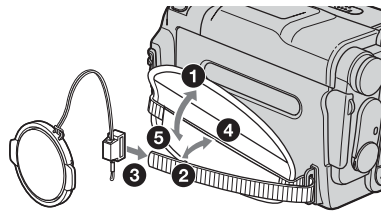

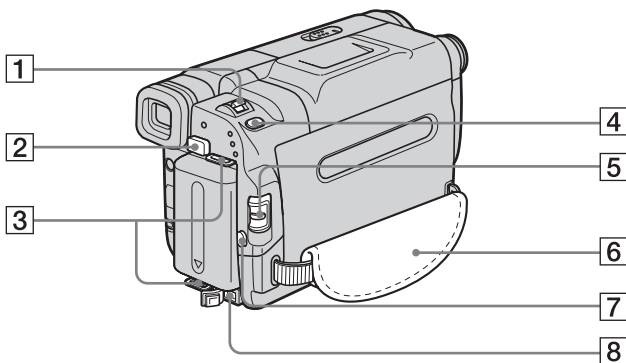

- 1 Power zoom lever (p. 26)
- 2 BATT (battery) release button (p. 15)
- 3 Hooks for shoulder strap
- 4 PHOTO button (p. 29)
- 5 POWER switch (p. 17)
- 6 Grip belt (p. 4)
- 7 REC START/STOP button (p. 24)
- 8 DC IN jack (p. 14)

To attach the shoulder strap

Attach the shoulder strap supplied with your camcorder to the hooks for the shoulder strap.



→ *continued*

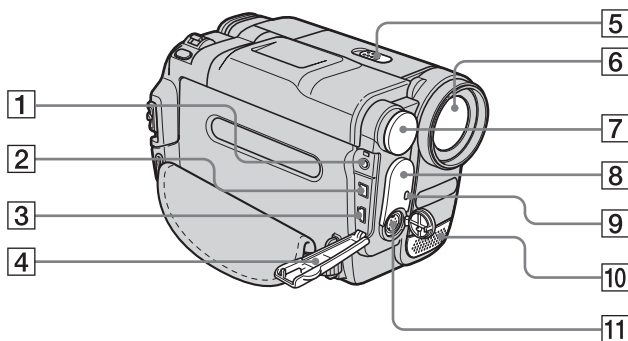

- 1** A/V (audio/video) jack (p. 56, 86)
- 2** DV Interface (p. 86, 119)
- 3** USB (USB) jack
- 4** Jack cover
- 5** NIGHTSHOT PLUS switch (p. 37)
- 6** Lens

- 7** Built-in light (p. 27)
- 8** Remote sensor/Infrared ray emitter (p. 93)
- 9** Camera recording lamp (p. 24)
- 10** Microphone
- 11** S VIDEO jack (p. 56, 86)

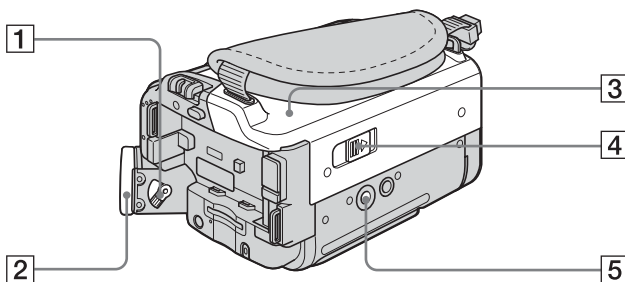

- 1** Viewfinder lens adjustment lever (p. 18)
- 2** Eyecup
- 3** Cassette compartment (p. 20)
- 4** OPEN/EJECT lever (p. 20)
- 5** Tripod receptacle

Make sure that the length of the tripod screw is less than 5.5 mm (7/32 inch). Otherwise, you cannot attach the tripod securely, and the screw may damage your camcorder.

Remote Commander

Remove the insulation sheet before using the Remote Commander.

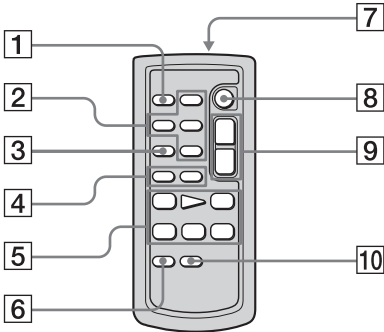

- 1 **PHOTO button** (p. 29)
- 2 **Memory control buttons** (Index*, -/+, Memory playback) (p. 49)
- 3 **SEARCH M. button*** (p. 57)
- 4 **◀◀/▶▶ buttons*** (p. 57)
- 5 **Video control buttons** (Rewind, Playback, Fast-forward, Pause, Stop, Slow) (p. 47)
- 6 **ZERO SET MEMORY button*** (p. 57)
- 7 **Transmitter**
After turning on your camcorder, point towards the remote sensor to control your camcorder.
- 8 **REC START/STOP button** (p. 28)
- 9 **Power zoom button** (p. 26)
- 10 **DISPLAY button** (p. 57)

* These buttons are not available during Easy Handycam operation.

To remove the insulation sheet

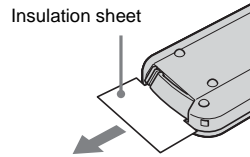

To change the button-type battery

- 1 While pressing on the tab, inset your fingernail into the slit to pull out the battery case.

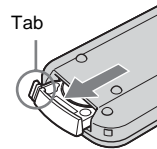

- 2 Remove the button-type lithium battery.

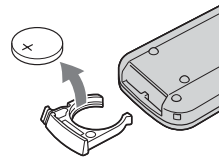

- 3 Place a new button-type lithium battery with the + side facing up.

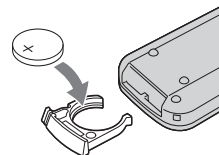

- 4 Insert the battery case back into the Remote Commander until it clicks.

→ continued

WARNING

Battery may explode if mistreated. Do not recharge, disassemble or dispose of in fire.

CAUTION

Danger of explosion if battery is incorrectly replaced.

Replace only with the same or equivalent type recommended by the manufacturer.

Discard used batteries according to the manufacturer's instructions.

Notes on the Remote Commander

- A button-type lithium battery (CR2025) is used in the Remote Commander. Do not use batteries other than CR2025.
- Point the remote sensor away from strong light sources such as direct sunlight or overhead lighting. Otherwise, the Remote Commander may not function properly.
- The Remote Commander may not function properly when the remote sensor is obstructed with a conversion lens (optional).
- When you are operating with the Remote Commander supplied with your camcorder, your VCR may also operate. In that case, select a commander mode other than VTR 2 for your VCR, or cover the sensor of your VCR with black paper.

Indicators for the LCD screen and viewfinder

Following indicators will appear on the LCD screen and viewfinder to indicate the state of your camcorder. Indicators vary depending on your camcorder model.

Example: Indicators in the CAMERA-TAPE mode

Time code (p. 25)/Tape counter (p. 25)/
Self-diagnosis (p. 110)/Picture number (p. 50)

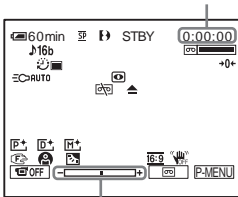

Exposure adjustment scale

Indicators	Meanings
60min	Remaining battery (p. 25)
SP LP	Recording mode (p. 26)
STBY REC	Recording standby/ recording mode
STD FINE	Image quality (p. 31)
	Image size (p. 26)
	Recording folder/playback folder (p. 67)
	Format indicator (p. 25)
	Audio mode (p. 76)
	Remaining tape (p. 25)
	Self-timer recording (p. 28, 31)
	Interval recording (p. 70)
	Interval still image recording (p. 72)
	Built-in light (p. 27)
	Frame recording (p. 70)

Indicators	Meanings
	Outputting analog images and sound in digital format (p. 79)
DV IN	DV input (p. 88)
	Zero set memory (p. 57)
	NightShot plus (p. 37)
	Super NightShot plus (p. 37)
	Color Slow Shutter (p. 37)
	Warning (p. 110)
	Picture effect (p. 68)
	Digital effect (p. 41, 48)
	MEMORY MIX (p. 43)
	Manual focus (p. 39)
	PROGRAM AE (p. 61)
	Back light (p. 35)
	16:9 WIDE (p. 63)
	SteadyShot off (p. 64)
	Protect (p. 99)
	Print mark (p. 99)
	Slide show (p. 69)
	Image delete (p. 98)
	PictBridge connecting (p. 101)

Index

Numeric

16:9 WIDE mode 63

A

A/V connecting

 cable 56, 86

AC Adaptor 14

Adjusting the viewfinder... 18

AUDIO MIX 78

AUDIO MODE 76

Auto shut off function

 (A.SHUT OFF) 81

AUTO SHUTTER 62

B

BACK LIGHT (camera).... 35

Battery

 Battery Info 15

 Battery pack 14

 Remaining battery

 time 25, 118

BEEP 18, 81

BLACK FADER 40

Built-in light 27

BURN DVD 73

BURN VCD 73

Button-type battery

 Camcorder 123

 Remote

 Commander 129

C

CALIBRATION 122

Camera Chroma key

 (CAM←M CHROMA)

 43

Camera settings data

 display 54

Cassette 20, 115

Charging the battery

 pack 14

Clock set

 (CLOCK SET) 19, 82

Color Slow Shutter

 (COLOR SLW S) 37

Customizing Personal

 Menu 83

D

Data code

 (DATA CODE) 54, 80

Date search 57

Date/time 54

Delete

 Deleting pictures 98

DEMO MODE 72

Digital convert function

 (A/V →DV OUT) 79

Digital effect

 (D.EFFECT) 41, 48

Digital program editing

 (PROG.EDIT) 91

DIGITAL ZOOM 63

Digital8 system 115

Direct Access to

 “Click to DVD”

 See BURN DVD

Direct Access to

 Video CD Burn

 See BURN VCD

Display

 DISPLAY 81

 Display indicators 131

DNR 77

DOT FADER 40

Dual sound track tape 76

Dubbing (REC CTRL) 88

E

Easy Handycam 33, 51

EDIT SEARCH 45

END SEARCH 44, 74

Erase

 ALL ERASE

 (still image) 66

Exposure 35

F

FADER 40

FILE NO. 66

Fine (FINE)

 See Image quality

 (QUALITY)

Flash motion (FLASH) 41

Flexible spot meter

 (SPOT METER) 35

Focus 62

Folder

 See NEW FOLDER

 See PB FOLDER

 See REC FOLDER

FORMAT 66, 116

Frame playback 47

Frame recording

 (FRAME REC) 70

Full charge 14

G

Grip belt 4

H

Hi8/standard 8 mm

 system 115

I

i.LINK 119

i.LINK cable 86, 92

ID-1/ID-2 system 63

Image protection 99

Image quality

 (QUALITY) 31, 65

Index screen 50

“InfoLITHIUM” battery

 pack 118

Infrared ray emitter 93

Interval photo recording

 (INT. REC-STL) 72

Interval recording

 (INTERVAL REC) 70

J

JPEG 116

L

Language

 (LANGUAGE) 22, 82

LCD back light

 (LCD BL LEVEL) 78

LCD brightness

 (LCD BRIGHT) 18

LCD COLOR 78

LCD screen 4

LCD SET 78

LP (Long Play) See Recording mode (REC MODE)	Operation confirmation beep See BEEP	Self-timer recording (SELF-TIMER) 28, 31
Luminance key (LUMI. KEY).....41	OVERLAP..... 40	Shoulder strap 127
M	P	Skip scan 47
Main sound	PAL 114	SLIDE SHOW 69
See MULTI-SOUND	PB FOLDER..... 67	Slow shutter (SLOW SHUTTR) 41
Manual focus.....39	Personal Menu (P-MENU) 59	Smooth transition See END SEARCH
Memory Chroma key (M←CAM CHROMA)43	PictBridge..... 101	SP (Standard Play) See Recording mode (REC MODE)
Memory Luminance key (M←CAM LUMI.)43	Picture effect (PICT. EFFECT)..... 68	SPOT FOCUS 38
MEMORY MIX.....42	Picture search 47	Standard (STANDARD) See Image quality (QUALITY)
Memory Overlap (OVERLAP).....41	Playback (VAR. SPD PB) Double speed 47	STEADYSHOT 64
Memory photo.....29, 49	Frame 47	Stereo/monaural 76
“Memory Stick”	Reverse 47	STILL..... 41
General information ..116	Slow 47	Still image format 116
Inserting.....21	Playback zoom (PB ZOOM)..... 53	STILL SET.....65
Number of pictures.....31	Playing time..... 16	Sub sound See MULTI-SOUND
Menu	Power mode..... 17	Super NightShot plus 37
CAMERA SET.....61	PRINT See PictBridge	
EDIT/PLAY73	Print mark 99	T
MEMORY SET.....65	PROGRAM AE..... 61	Tape counter..... 25
MENU ROTATE81	Program edit (PROG. EDIT)..... 73	TBC..... 77
PICT. APPLI68	R	Telephoto See Zoom
Selecting items59	REC FOLDER..... 67	Time code..... 25
STANDARD SET76	Rec review 45	TITLE 74
TIME/LANGU82	Recording capacity Display 25	TRAIL..... 41
Mirror mode28	REMAINING 65, 80	TV color systems 114
Moisture condensation121	Recording lamp (REC LED) 80	U
MONOTONE.....40	Recording mode (REC MODE) 25, 76	USB jack 128
MOSAIC FADER40	Recording time 16, 26	USB Streaming 79
MOVIE SET65	Remote Commander..... 129	USB-CAMERA 79
MPEG116	REMOTE CTRL..... 80	USB-PLY/EDT 79
MULTI-SOUND.....76	Remote sensor 128	Using abroad 114
N	RESET 126	V
NEW FOLDER.....67	Review..... 24, 30	Video head 121
NightShot Light (NS LIGHT)38, 62	S	Viewfinder 18
NightShot plus37	S video 56, 86	Volume (VOLUME)... 46, 49
NTSC 114	Self-diagnosis display 110	W
O		Warning indicators..... 110
OLD MOVIE41		Warning messages 110

WHITE FADER 40
Wide angle
 See Zoom
WIPE 40
WORLD TIME 82
Write-protect tab 115, 116

Z

Zero set memory 57
Zoom 26

<http://www.sony.net/>



Printed on 100% recycled paper using
VOC (Volatile Organic Compound)-free
vegetable oil based ink.

Printed in Japan



3087921120