

Digital Video Camera Recorder

Operating Instructions

Before operating the unit, please read this manual thoroughly, and retain it for future reference.

Owner's Record

The model and serial numbers are located on the bottom. Record the serial number in the space provided below. Refer to these numbers whenever you call upon your Sony dealer regarding this product.

Model No. **DCR-TRV** _____ Model No. **AC-** _____

Serial No. _____ Serial No. _____

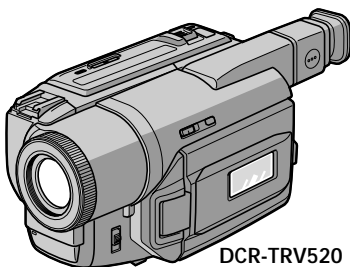

Digital Handycam



MEMORY STICK™



Digital 8

DCR-TRV520/TRV525

Welcome!

Congratulations on your purchase of this Sony Digital Handycam camcorder. With your Digital Handycam, you can capture life's precious moments with superior picture and sound quality. Your Digital Handycam is loaded with advanced features, but at the same time it is very easy to use. You will soon be producing home video that you can enjoy for years to come.

WARNING

To prevent fire or shock hazard, do not expose the unit to rain or moisture.

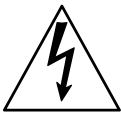
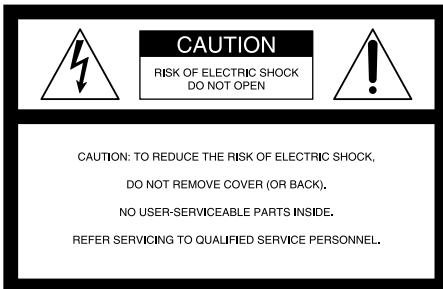

This symbol is intended to alert the user to the presence of uninsulated "dangerous voltage" within the product's enclosure that may be of sufficient magnitude to constitute a risk of electric shock to persons.



This symbol is intended to alert the user to the presence of important operating and maintenance (servicing) instructions in the literature accompanying the appliance.

Never expose the battery pack to temperatures above 140°F (60°C) such as in a car parked in the sun or under direct sunlight.

DISPOSAL OF LITHIUM ION BATTERY. LITHIUM ION BATTERY. DISPOSE OF PROPERLY.

You can return your unwanted lithium ion batteries to your nearest Sony Service Center or Factory Service Center.

Note: In some areas the disposal of lithium ion batteries in household or business trash may be prohibited.

For the Sony Service Center nearest you call 1-800-222-SONY (United States only)

For the Sony Factory Service Center nearest you call 416-499-SONY (Canada only)

Caution: Do not handle damaged or leaking lithium ion battery.

For customers in the U.S.A.

If you have any questions about this product, you may call :
Sony Customer Information Center 1-800-222-SONY (7669) or write to :
Sony Customer Information Center 1 Sony Drive,
Mail Drop #T1-11, Park Ridge, NJ 07656

CAUTION

You are cautioned that any changes or modifications not expressly approved in this manual could void your authority to operate this equipment.

Declaration of Conformity

Trade Name: SONY
Model No.: DCR-TRV520
Responsible Party: Sony Electronics Inc.
Address: 1 Sony Drive, Park Ridge,
NJ, 07656 USA
Telephone No.: 201-930-6972

This device complies with Part15 of the FCC Rules. Operation is subject to the following two conditions.: (1) This device may not cause harmful interference, and (2) this device must accept any interference received, including interference that may cause undesired operation.

Declaration of Conformity

Trade Name: SONY
Model No.: DCR-TRV525
Responsible Party: Sony Electronics Inc.
Address: 1 Sony Drive, Park Ridge,
NJ, 07656 USA
Telephone No.: 201-930-6972

This device complies with Part15 of the FCC Rules. Operation is subject to the following two conditions.: (1) This device may not cause harmful interference, and (2) this device must accept any interference received, including interference that may cause undesired operation.

Note:

This equipment has been tested and found to comply with the limits for a Class B digital device, pursuant to Part 15 of the FCC Rules. These limits are designed to provide reasonable protection against harmful interference in a residential installation. This equipment generates, uses, and can radiate radio frequency energy and, if not installed and used in accordance with the instructions, may cause harmful interference to radio communications. However, there is no guarantee that interference will not occur in a particular installation. If this equipment does cause harmful interference to radio or television reception, which can be determined by turning the equipment off and on, the user is encouraged to try to correct the interference by one or more of the following measures:

- Reorient or relocate the receiving antenna.
- Increase the separation between the equipment and receiver.
- Connect the equipment into an outlet on a circuit different from that to which the receiver is connected.
- Consult the dealer or an experienced radio/TV technician for help.

For customers in CANADA**CAUTION**

TO PREVENT ELECTRIC SHOCK, MATCH WIDE BLADE OF PLUG TO WIDE SLOT, FULLY INSERT.

“Memory Stick”**For customers in CANADA**

This Class B digital apparatus complies with Canadian ICES-003.

For customers in the U.S.A

This device complies with Part 15 of the FCC Rules. Operation is subject to the following two conditions.: (1) This device may not cause harmful interference, and (2) this device must accept any interference received, including interference that may cause undesired operation.

Table of contents

Checking supplied accessories	5
-------------------------------------	---

Quick Start Guide	6
--------------------------------	---

Getting started

Using this manual	8
Step 1 Preparing the power supply	10
Installing the battery pack	10
Charging the battery pack	11
Connecting to a wall outlet	14
Step 2 Inserting a cassette	15

Recording – Basics

Recording a picture	16
Shooting backlit subjects	
– BACK LIGHT	20
Shooting in the dark	
– NightShot/Super NightShot	20
Self-timer recording	22
Checking the recording – END SEARCH /	
EDITSEARCH / Rec Review	23

Playback – Basics

Playing back a tape	24
Viewing the recording on TV	27

Advanced Recording Operations

Recording a still image on a tape	
– Tape Photo recording	29
Using the wide mode	32
Using the fader function	33
Using special effects – Picture effect	36
Using special effects – Digital effect	37
Using the PROGRAM AE function	40
Adjusting the exposure manually	42
Focusing manually	43
Superimposing a title	44
Making your own titles	46
Inserting a scene	48

Advanced Playback Operations

Playing back a tape with picture effects	49
Playing back a tape with digital effects	50
Enlarging recorded images – PB ZOOM	51
Quickly locating a scene using the zero set	
memory function	52
Searching a recording by date	
– Date search	53
Searching for a photo	
– Photo search/Photo scan	55

Editing

Dubbing a tape	57
Using with analog video unit and PC	
– Signal convert function	59
Recording video or TV programs	60
Inserting a scene from a VCR	
– Insert Editing	62

Customizing Your Camcorder

Changing the menu settings	64
Resetting the date and time	71

“Memory Stick” operations

Using “Memory Stick” –introduction	72
Recording still images on “Memory Stick”	
– Memory Photo recording	77
Superimposing a still image in the	
“Memory Stick” on a moving image	
– MEMORY MIX	82
Recording an image from a tape as a still	
image	85
Copying still images from a tape	
– Photo save	87
Viewing a still image	
– Memory Photo playback	89
Copying the image recorded on	
“Memory Stick” to tapes	92
Enlarging still images recorded on “Memory	
Stick”’s – Memory PB ZOOM	94
Playing back images in a continuous loop	
– SLIDE SHOW	95
Preventing accidental erasure	
– Image protection	97
Deleting images	98
Writing a print mark – PRINT MARK	101

Additional Information

Digital8  system, recording and playback	
.....	102
About i.LINK	104
Changing the lithium battery in your	
camcorder	106
Troubleshooting	108
Self-diagnosis display	113
Warning indicators and messages	114
Using your camcorder abroad	116
Maintenance information and precautions	
.....	117
Specifications	122

Quick Reference

Identifying the parts and controls	123
Quick Function Guide	130
Index	131

• Microsoft® and Windows® are either registered trademarks or trademarks of Microsoft Corporation in the United States and/or other countries.

• Macintosh and Mac OS are trademarks of Apple Computer, Inc.

• All other product names mentioned herein may be the trademarks or registered trademarks of their respective companies.

Furthermore, “™” and “®” are not mentioned in each case in this manual.

Checking supplied accessories

Make sure that the following accessories are supplied with your camcorder.

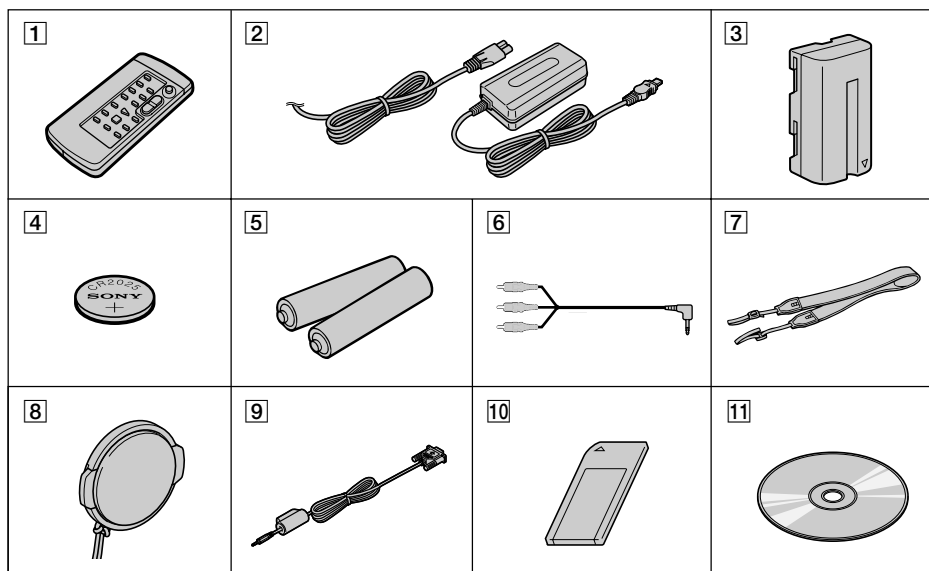

- 1** Wireless Remote Commander (1) (p. 128)
- 2** AC-L10A/L10B/L10C AC power adaptor (1), Power cord (1) (p. 11)
- 3** NP-F330 battery pack (1) (p. 10, 11)
- 4** CR2025 lithium battery (1) (p. 106)
The lithium battery is already installed in your camcorder.
- 5** Size AA (R6) battery for Remote Commander (2) (p. 128)

- 6** A/V connecting cable (1) (p. 27)
- 7** Shoulder strap (1) (p. 125)
- 8** Lens cap (1) (p. 16)
- 9** PC serial cable (1) (p. 91)
- 10** "Memory Stick" (1) (p. 72)
- 11** Application software: PictureGear 4.1 Lite (CD-ROM) (1) (p. 91)

Contents of the recording cannot be compensated if recording or playback is not made due to a malfunction of the camcorder, video tape, etc.

Quick Start Guide



This chapter introduces you to the basic features of your camcorder. See the page in parentheses “()” for more information.

1 Connecting the power cord (p. 14)

Use the battery pack when using your camcorder outdoors (p. 10).

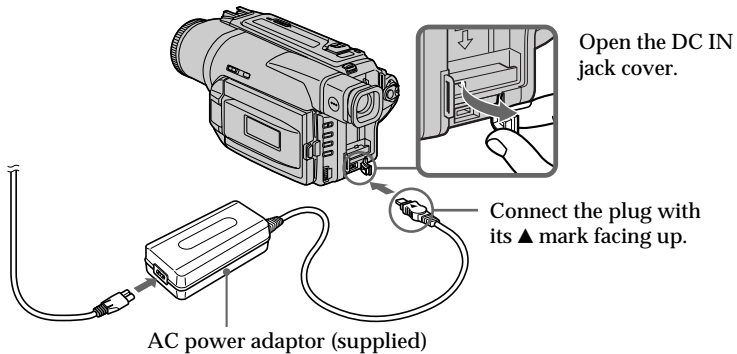

2 Inserting a cassette (p. 15)

- 1 Open the lid of the cassette compartment, and press EJECT. The compartment opens automatically.



- 2 Insert a cassette into the cassette compartment with its window facing out and the write-protect tab on the cassette up.

- 3 Close the cassette compartment by pressing the (PUSH) mark on the cassette compartment. The cassette compartment automatically goes down. Close the lid of the cassette compartment.

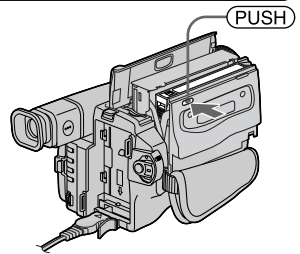
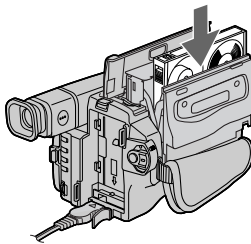
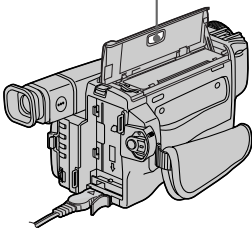

3 Recording a picture (p. 16)

- 1 Remove the lens cap.

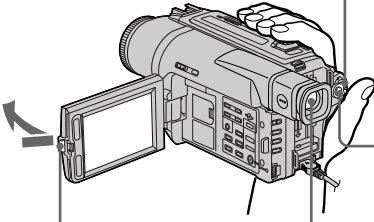

- 3 Open the LCD panel while pressing OPEN. The picture appears on the LCD screen.

Viewfinder

When the LCD panel is closed, use the viewfinder placing your eye against its eyecup. The picture in the viewfinder is black and white (DCR-TRV520 only).

- 2 Set the POWER switch to CAMERA while pressing the small green button.

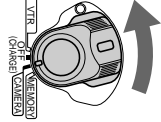

- 4 Press the red button. Your camcorder starts recording. To stop recording, press the red button again.



4 Monitoring the playback picture on the LCD screen (p. 24)

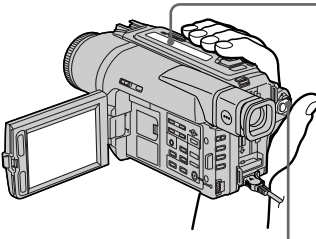

- 1 Set the POWER switch to VTR while pressing the small green button.

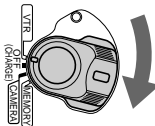

- 2 Press ◀◀ to rewind the tape.



- 3 Press ▶ to start playback.



Note

Do not pick up your camcorder by holding the viewfinder, the LCD panel, or the battery pack.

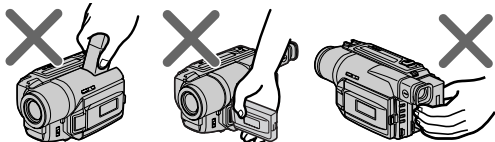

Using this manual

The instructions in this manual are for the two models listed in the table below. Before you start reading this manual and operating your camcorder, check the model number by looking at the bottom of your camcorder. The DCR-TRV520 is the model used for illustration purposes. Otherwise, the model name is indicated in the illustrations. Any differences in operation are clearly indicated in the text, for example, “DCR-TRV520 only.”

As you read through this manual, buttons and settings on your camcorder are shown in capital letters.











e.g. Set the POWER switch to CAMERA.

When you carry out an operation, you can hear a beep sound to indicate that the operation is being carried out.

Type of difference

DCR-	TRV520	TRV525
viewfinder	B/W	Color

Before using your camcorder

With your digital camcorder, you can use Hi8 /Digital8  video cassettes. Your camcorder records and plays back pictures in the Digital8  system. Also, your camcorder plays back tapes recorded in the Hi8 /standard 8  (analog) system. You, however, cannot use the functions in “Advanced Playback Operations” on page 49 to 56 for playback in the Hi8 /standard 8  system. To enable smooth transition, we recommend that you do not mix pictures recorded in the Hi8 /standard 8  with the Digital8  system on a tape.

Note on TV color systems

TV color systems differ from country to country. To view your recordings on a TV, you need an NTSC system-based TV.

Copyright precautions

Television programs, films, video tapes, and other materials may be copyrighted. Unauthorized recording of such materials may be contrary to the provision of the copyright laws.

Precautions on camcorder care

- The LCD screen and the viewfinder are manufactured using high-precision technology. However, there may be some tiny black points and/or bright points (red, blue, green or white) that constantly appear on the LCD screen and in the viewfinder. These points occur normally in the manufacturing process and do not affect the recorded picture in any way. Effective ratio of pixels and/or screen are 99.99% or more.
- Do not let your camcorder get wet. Keep your camcorder away from rain and sea water. Letting your camcorder get wet may cause your camcorder to malfunction. Sometimes this malfunction cannot be repaired [a].
- Never leave your camcorder exposed to temperatures above 140°F (60°C), such as in a car parked in the sun or under direct sunlight [b].
- Do not place your camcorder so as to point the viewfinder, the LCD screen or lens toward the sun. The inside of the viewfinder, LCD screen or lens may be damaged [c].

[a]

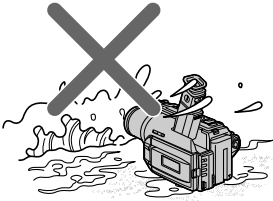

[b]

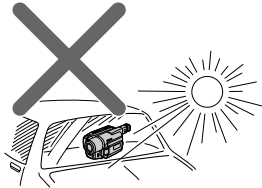

[c]

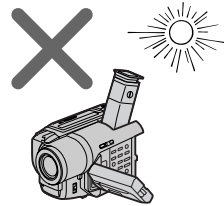

Step 1 Preparing the power supply

Installing the battery pack

Install the battery pack to use your camcorder outdoors.

Slide the battery pack down until it clicks.

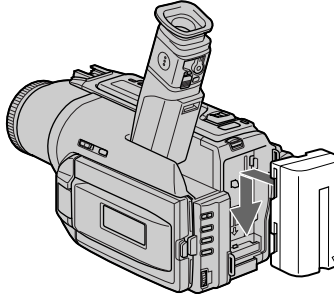

To remove the battery pack

Slide the battery pack out in the direction of the arrow while pressing ↓ BATT RELEASE down.

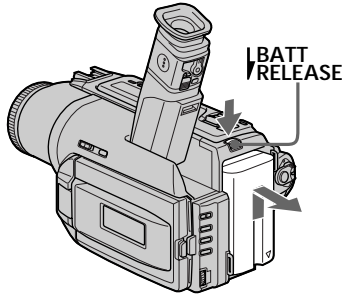

After installing the battery pack

Do not carry your camcorder by holding the battery pack. If you do so, the battery pack may slide off your camcorder unintentionally, damaging your camcorder.

Step 1 Preparing the power supply

Charging the battery pack

Use the battery pack after charging it for your camcorder.

Your camcorder operates only with the "InfoLITHIUM" battery pack (L series).

- (1) Open the DC IN jack cover and connect the AC power adaptor supplied with your camcorder to the DC IN jack with the plug's ▲ mark facing up.
- (2) Connect the power cord to the AC power adaptor.
- (3) Connect the power cord to a wall outlet.
- (4) Set the POWER switch to OFF (CHARGE). Charging begins. The remaining battery time is indicated in minutes on the display window.

When the remaining battery indicator changes to , normal charge is completed. To fully charge the battery (full charge), leave the battery pack attached for about 1 hour after normal charge is completed until FULL appears in the display window. Fully charging the battery allows you to use the battery longer than usual.

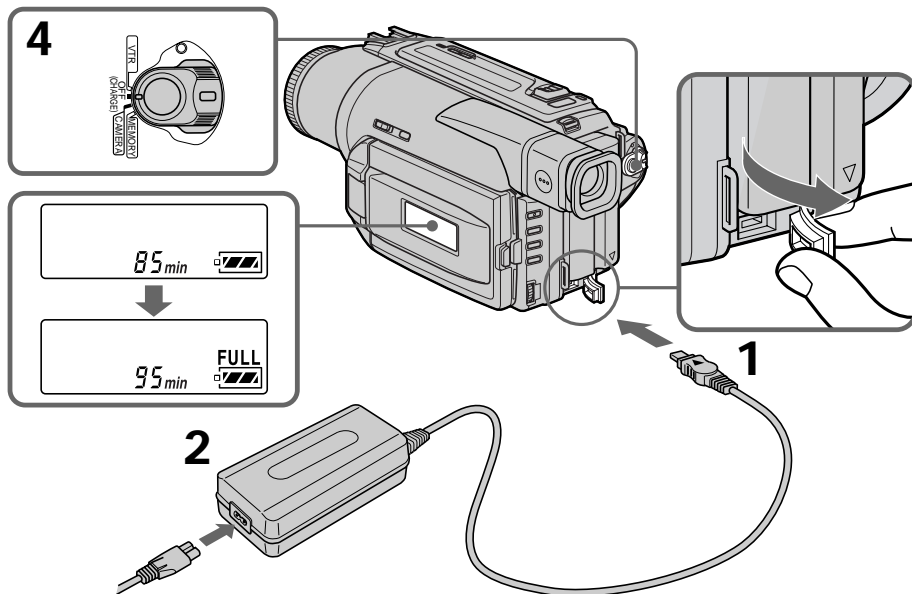

After charging the battery pack

Disconnect the AC power adaptor from the DC IN jack on your camcorder.

Notes

- Prevent metallic objects from coming into contact with the metal parts of the DC plug of the AC power adaptor. This may cause a short-circuit, damaging the AC power adaptor.
- Keep the battery pack dry.
- When the battery pack is not to be used for a long time, charge the battery pack once fully, and then use it until it fully discharges again. Keep the battery pack in a cool place.

When the battery pack is charged fully

The LCD backlight of the display window is turned off.

Remaining battery time indicator

The remaining battery time indicator in the display window roughly indicates the recording time with the viewfinder.

Battery pack

The supplied battery pack is charged a little.

Step 1 Preparing the power supply

Until your camcorder calculates the actual remaining battery time “---- min” appears in the display window.

While charging the battery pack, no indicator appears or the indicator flashes in the display window in the following cases:

- The battery pack is not installed correctly.
- The AC power adaptor is disconnected.
- Something is wrong with the battery pack.

Charging time

Battery pack	Full charge (Normal charge)
NP-F330 (supplied)	150 (90)
NP-F530/F550	210 (150)
NP-F730/F730H/F750	300 (240)
NP-F930/F950	390 (330)
NP-F960	420 (360)

Approximate number of minutes to charge an empty battery pack

Recording time

DCR-TRV520

Battery pack	Recording with the viewfinder		Recording with the LCD screen	
	Continuous*	Typical**	Continuous*	Typical**
NP-F330 (supplied)	95 (85)	55 (50)	75 (65)	40 (35)
NP-F530	160 (145)	90 (80)	120 (105)	70 (60)
NP-F550	195 (175)	110 (100)	145 (130)	80 (75)
NP-F730	325 (290)	185 (165)	265 (240)	150 (135)
NP-F730H/F750	395 (355)	225 (200)	305 (270)	175 (155)
NP-F930	515 (465)	295 (265)	415 (375)	235 (215)
NP-F950	610 (550)	345 (315)	475 (430)	270 (245)
NP-F960	720 (645)	410 (365)	565 (505)	320 (285)

DCR-TRV525

Battery pack	Recording with the viewfinder		Recording with the LCD screen	
	Continuous*	Typical**	Continuous*	Typical**
NP-F330 (supplied)	105 (95)	60 (55)	75 (65)	40 (35)
NP-F530	175 (160)	100 (90)	120 (105)	70 (60)
NP-F550	210 (190)	120 (110)	145 (130)	80 (75)
NP-F730	365 (325)	210 (185)	265 (240)	150 (135)
NP-F730H/F750	440 (395)	250 (225)	305 (270)	175 (155)
NP-F930	575 (520)	325 (295)	415 (375)	235 (215)
NP-F950	675 (610)	385 (345)	475 (430)	270 (245)
NP-F960	790 (710)	450 (405)	565 (505)	320 (285)

Approximate number of minutes when you use a fully charged battery

Numbers in parentheses “()” indicate the time using a normally charged battery.

* Approximate continuous recording time at 77°F (25°C). The battery life will be shorter if you use your camcorder in a cold environment.

** Approximate number of minutes when recording while you repeat recording start/stop, zooming and turning the power on/off. The actual battery life may be shorter.

Step 1 Preparing the power supply

Playing time

DCR-TRV520

Battery pack	Playing time on LCD screen	Playing time with LCD closed
NP-F330 (supplied)	70 (65)	95 (85)
NP-F530	115 (105)	155 (140)
NP-F550	145 (130)	190 (170)
NP-F730	260 (235)	315 (285)
NP-F730H/F750	295 (265)	385 (345)
NP-F930	405 (370)	495 (450)
NP-F950	465 (420)	590 (530)
NP-F960	550 (495)	700 (630)

DCR-TRV525

Battery pack	Playing time on LCD screen	Playing time with LCD closed
NP-F330 (supplied)	70 (65)	100 (90)
NP-F530	115 (105)	170 (155)
NP-F550	145 (130)	205 (185)
NP-F730	260 (235)	350 (310)
NP-F730H/F750	295 (265)	425 (380)
NP-F930	405 (370)	555 (500)
NP-F950	465 (420)	650 (590)
NP-F960	550 (495)	765 (685)

Approximate number of minutes when you use a fully charged battery

Numbers in parentheses “ () ” indicate the time using a normally charged battery. The battery life will be shorter if you use your camcorder in a cold environment.

The remaining battery time indicator

The indicator may not be correct, depending on the conditions in which you are recording. When you close the LCD panel and open it again, it takes about 1 minute for the correct remaining battery time to be displayed.

If the power may go off although the battery remaining indicator indicates that the battery pack has enough power to operate

Charge the battery pack fully again so that the indication on the battery remaining indicator is correct.

What is “InfoLITHIUM”?

The “InfoLITHIUM” is a lithium ion battery pack which can exchange data such as battery consumption with compatible electronic equipment. This unit is compatible with the “InfoLITHIUM” battery pack (L series). Your camcorder operates only with the “InfoLITHIUM” battery. “InfoLITHIUM” battery packs have the  InfoLITHIUM mark. “InfoLITHIUM” is a trademark of Sony Corporation.

Step 1 Preparing the power supply

Connecting to a wall outlet

When you use your camcorder for a long time, we recommend that you power it from a wall outlet using the AC power adaptor.

- (1) Open the DC IN jack cover, and connect the AC power adaptor to the DC IN jack on your camcorder with the plug's ▲ mark facing up.
- (2) Connect the power cord to the AC power adaptor.
- (3) Connect the power cord to a wall outlet.

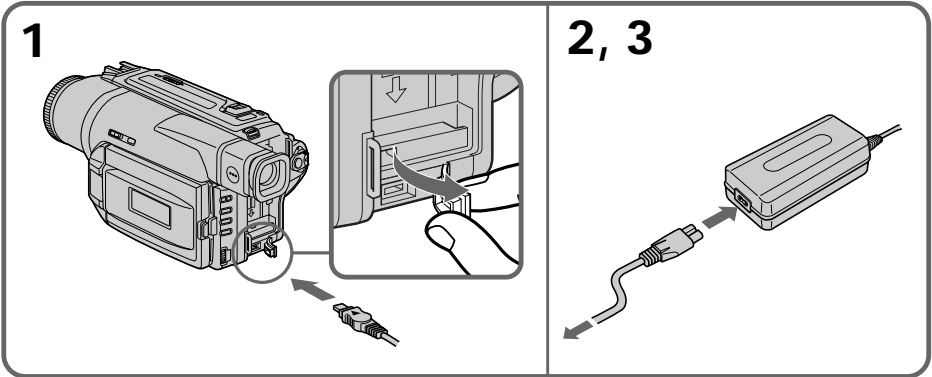

PRECAUTION

The set is not disconnected from the AC power source (house current) as long as it is connected to the wall outlet, even if the set itself has been turned off.

Notes

- The AC power adaptor can supply power even if the battery pack is attached to your camcorder.
- The DC IN jack has “source priority”. This means that the battery pack cannot supply any power if the power cord is connected to the DC IN jack, even when the power cord is not plugged into a wall outlet.

Using a car battery

Use Sony DC Adaptor/Charger (not supplied).

Step 2 Inserting a cassette

We recommend using Hi8 **Hi8**/Digital8 **D8** video cassettes.

- (1) Prepare the power supply (p. 10).
- (2) Open the lid of the cassette compartment, and press EJECT. The cassette compartment opens automatically.
- (3) Insert a cassette with its window facing out and the write-protect tab on the cassette up.
- (4) Close the cassette compartment by pressing the **(PUSH)** mark on the cassette compartment. The cassette compartment automatically goes down.
- (5) Close the lid of the cassette compartment.

Getting started

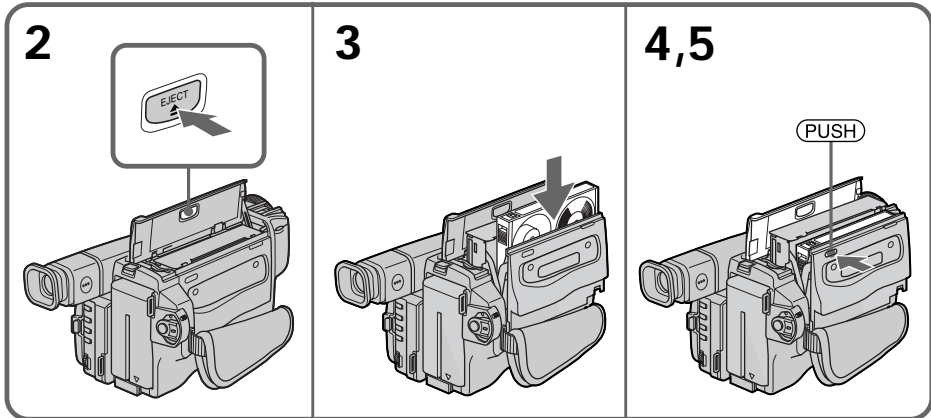

To eject a cassette

Follow the procedure above, and eject the cassette in step 3.

Notes

- Do not press the cassette compartment down. Doing so may cause malfunction.
- Your camcorder records pictures in the Digital8 **D8** system.
- The recording time when you use your camcorder is half of indicated time on Hi8 **Hi8** tape. If you select the LP mode in the menu settings, 3/4 of indicated time on Hi8 **Hi8** tape.
- If you use standard 8 **D8** tape, be sure to play back the tape on this camcorder. Mosaic pattern noise may appear when you play back standard 8 **D8** tape on other camcorders (including other DCR-TRV520/TRV525).
- The cassette compartment may not be closed when you press any part of the lid other than the **(PUSH)** mark.
- Do not pick up your camcorder by holding the lid of the cassette compartment.

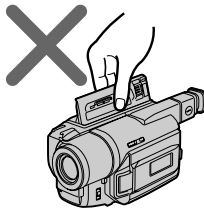

To prevent accidental erasure

Slide the write-protect tab on the cassette to expose the red mark.

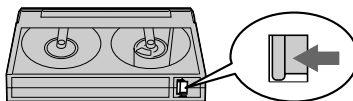

Recording a picture

Your camcorder automatically focuses for you.

- (1) Remove the lens cap by pressing both knobs on its sides and attach the lens cap to the grip strap.
- (2) Install the power source and insert a cassette. See “Step 1” and “Step 2” for more information (p. 10 to 15).
- (3) Set the POWER switch to CAMERA while pressing the small green button. Your camcorder is set to the standby mode.
- (4) Open the LCD panel while pressing OPEN. The viewfinder automatically turns off.
- (5) Press START/STOP. Your camcorder starts recording. The REC indicator appears. The camera recording lamp located on the front of your camcorder lights up. To stop recording, press START/STOP again. The recording lamp lights up in the viewfinder when you record with the viewfinder (DCR-TRV520 only).

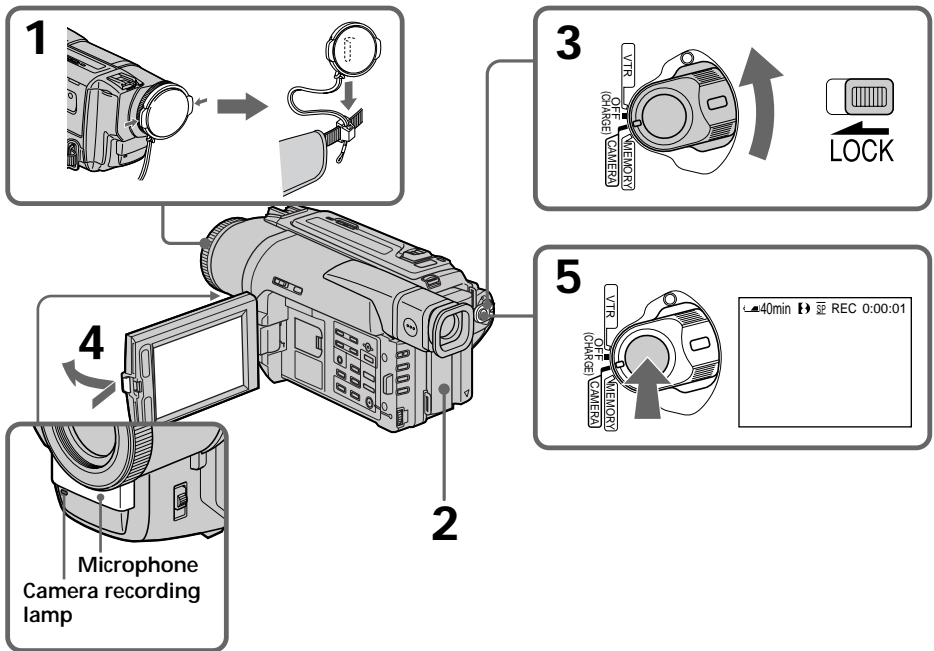

Notes

- Fasten the grip strap firmly.
- Do not touch the built-in microphone during recording.

Note on Recording mode

Your camcorder records and plays back in the SP (standard play) mode and in the LP (long play) mode. Select SP or LP in the menu settings (p 64). In the LP mode, you can record 1.5 times as long as in the SP mode. When you record a tape in the LP mode on your camcorder, we recommend that you play back the tape on your camcorder.

Recording a picture

Note on LOCK

When you slide LOCK to the left, the POWER switch can no longer be set to MEMORY accidentally. The LOCK is released as a default setting.

To enable smooth transition

You can make the transition between the last scene you recorded and the next scene smooth as long as you do not eject the cassette if you turn off your camcorder. When you change the battery pack, set the POWER switch to OFF (CHARGE).

If you leave your camcorder in the standby mode for 3 minutes

Your camcorder automatically turns off. This is to save battery power and to prevent battery and tape wear. To resume the standby mode, set the POWER switch to OFF (CHARGE) once, then turn it to CAMERA again.

Adjusting the LCD screen

To adjust the brightness of the LCD screen, press either of the two buttons on LCD BRIGHT.

The LCD panel moves about 90 degrees to the viewfinder side and about 180 degrees to the lens side.

If you turn the LCD panel over so that it faces the other way, the ☺ indicator appears on the LCD screen and in the viewfinder (Mirror mode).

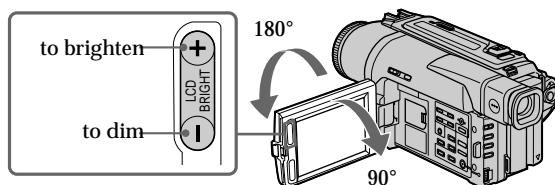

When closing the LCD panel, set it vertically until it clicks, and swing it into the camcorder body.

Note

When using the LCD screen except in the mirror mode, the viewfinder automatically turns off.

When you use the LCD screen outdoors in direct sunlight

The LCD screen may be difficult to see. If this happens, we recommend that you use the viewfinder.

Picture in the mirror mode

The picture on the LCD is a mirror-image. However, the picture will be normal when recorded.

During recording in the mirror mode

You cannot operate the ZERO SET MEMORY on the Remote Commander.

Indicators in the mirror mode

The STBY indicator appears as **II●** and REC as **●**. Some of other indicators appear mirror-reversed and others are not displayed.

Recording a picture

After recording

- (1) Set the POWER switch to OFF (CHARGE).
- (2) Close the LCD panel.
- (3) Eject the cassette.

Using the zoom feature

Move the power zoom lever a little for a slower zoom. Move it further for a faster zoom. Using the zoom function sparingly results in better-looking recordings.

“T” side: for telephoto (subject appears closer)

“W” side: for wide-angle (subject appears farther away)

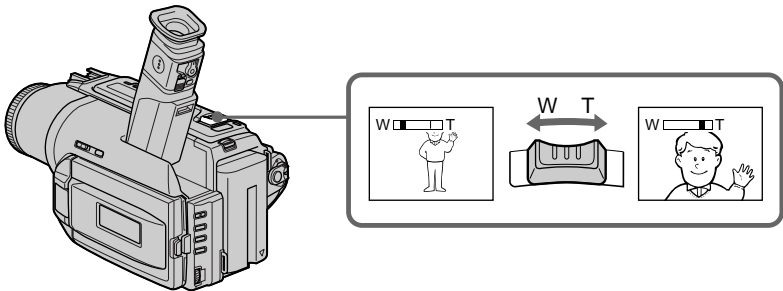

Zoom greater than 25× is performed digitally. To activate digital zoom power in D ZOOM in the menu settings. (p. 64)

The picture quality deteriorates as the picture is processed digitally.

The right side of the bar shows the digital zooming zone.
The digital zooming zone appears when you select the digital zoom power in D ZOOM in the menu settings.

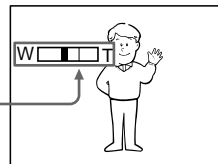

Notes on digital zoom

- Digital zoom starts to function when zoom exceeds 25×.
- The picture quality deteriorates as you go toward the “T” side.

When you shoot close to a subject

If you cannot get a sharp focus, move the power zoom lever to the “W” side until the focus is sharp. You can shoot a subject that is at least about 2 feet 5/8 inch (about 80 cm) away from the lens surface in the telephoto position, or about 1/2 inch (about 1 cm) away in the wide-angle position.

To record pictures with the viewfinder – adjusting the viewfinder

If you record pictures with the LCD panel closed, check the picture with the viewfinder. Adjust the viewfinder lens to your eyesight so that the indicators in the viewfinder come into sharp focus.

Lift up the viewfinder and move the viewfinder lens adjustment lever.

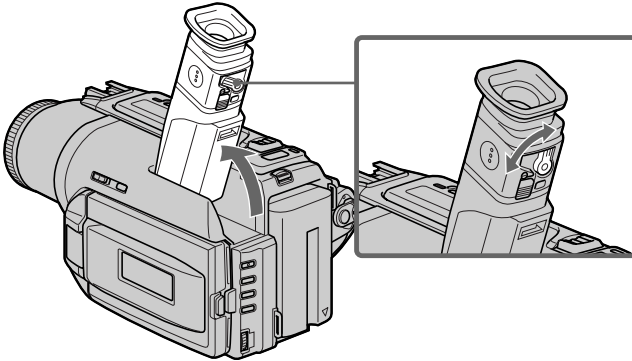

Indicators displayed in the recording mode

The indicators are not recorded on tape.

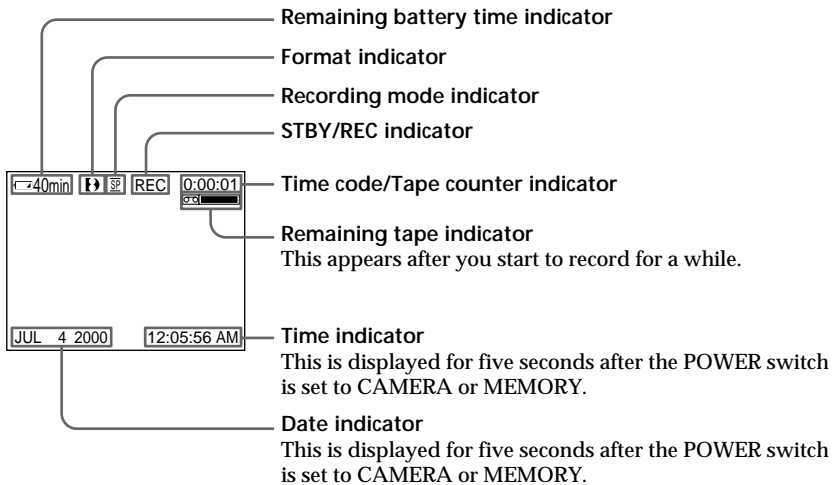

Timecode (for tapes recorded in the Digital8 system only)

The time code indicates the recording or playback time, “0:00:00” (hours:minutes:seconds) in CAMERA mode and “0:00:00:00” (hours:minutes:seconds:frames) in VTR mode. You cannot rewrite only the time code.

When you play back tapes recorded in the Hi8/standard 8 system, the tape counter appears.

You cannot reset the time code or the tape counter.

Recording a picture

Shooting backlit subjects – BACK LIGHT

When you shoot a subject with the light source behind the subject or a subject with a light background, use the backlight function.

Press BACK LIGHT in CAMERA or MEMORY mode.

The  indicator appears on the LCD screen or in the viewfinder.

To cancel, press BACK LIGHT again.

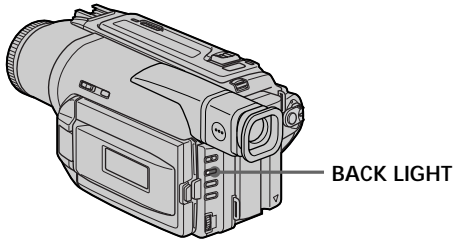

If you press EXPOSURE when shooting backlit subjects

The backlight function will be canceled.

Shooting in the dark – NightShot/Super NightShot

The NightShot function enables you to shoot a subject in a dark place. For example, you can satisfactorily record the environment of nocturnal animals for observation when you use this function.

While your camcorder is in CAMERA or MEMORY mode, slide NIGHTSHOT to ON.

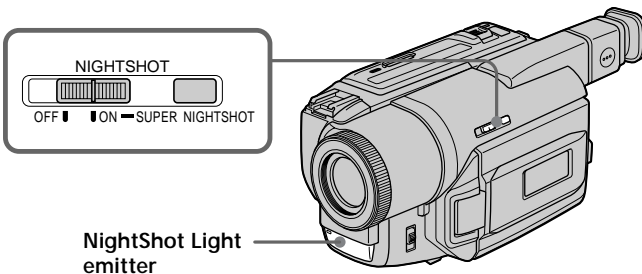

 and "NIGHTSHOT" indicators flash on the LCD screen or in the viewfinder.

To cancel the NightShot function, slide NIGHTSHOT to OFF.



Using SUPER NIGHTSHOT

The Super NightShot mode makes subjects up to 16 times brighter than those recorded in the NightShot mode.

- (1) Slide NIGHTSHOT to ON in CAMERA mode.  and “NIGHTSHOT” indicators flash on the LCD screen or in the viewfinder.
- (2) Press SUPER NIGHTSHOT.  and “SUPER NIGHTSHOT” indicators flash on the LCD screen or in the viewfinder.
To cancel the Super NightShot mode, press SUPER NIGHTSHOT again.

Using the NightShot Light

The picture will be clearer with the NightShot Light on. To enable NightShot Light, set N.S.LIGHT to ON in the menu settings (p. 64).

Notes

- Do not use the NightShot function in bright places (ex. outdoors in the daytime). This may cause your camcorder to malfunction.
- When you keep NIGHTSHOT set to ON in normal recording, the picture may be recorded in incorrect or unnatural colors.
- If focusing is difficult with the autofocus mode when using the NightShot function, focus manually.

While using the NightShot function, you cannot use the following functions:

- Exposure
- PROGRAM AE

While using the Super NightShot function, you cannot use the following functions:

- Fader
- Digital effect
- Exposure
- PROGRAM AE

Shutter speed in the Super NightShot mode

The shutter speed will be automatically changed depending on the brightness of the background. The motion of the picture will be slow.



NightShotLight

NightShot Light rays are infrared and so are invisible. The maximum shooting distance using the NightShot Light is about 10 feet (3 m).

Recording a picture

Self-timer recording

Recording with the self-timer starts in 10 seconds automatically. This mode is useful when you want to record yourself. You can also use the Remote Commander for this operation.

(1) Press  (self-timer) in the standby mode. The  (self-timer) indicator appears on the LCD screen or in the viewfinder.

(2) Press START/STOP.

Self-timer starts counting down from 10 with a beep sound. In the last two seconds of the countdown, the beep sound gets faster, then recording starts automatically.

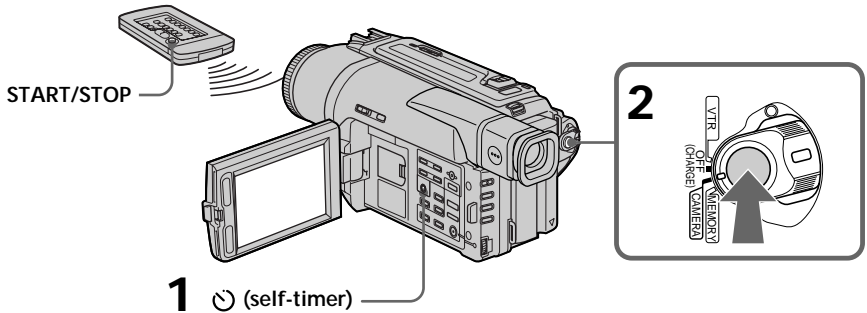

To stop the self-timer recording



Press START/STOP.

Use the Remote Commander for convenience.

To record still images using the self-timer

Press PHOTO in step 2. (P. 30)

To cancel self-timer recording

Press  (self-timer) so that the  indicator disappears from the LCD or viewfinder screen while your camcorder is in the standby mode.

Note

The self-timer recording mode is automatically cancelled when:

- Self-timer recording is finished.
- The POWER switch is set to OFF (CHARGE) or VTR.

Checking the recording

- END SEARCH / EDITSEARCH / Rec Review

You can use these buttons to check the recorded picture or shoot so that the transition between the last recorded scene and the next scene you record is smooth.

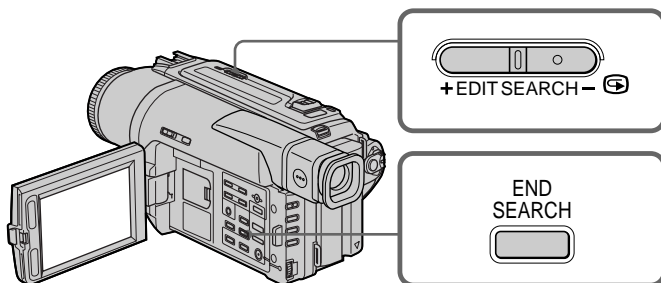

END SEARCH

You can go to the end of the recorded section after you record.

Press END SEARCH in the standby mode.

The last 5 seconds of the recorded section are played back and returns to the standby mode. You can monitor the sound from the speaker or headphones.

EDITSEARCH

You can search for the next recording start point.

Hold down the +/- (⊖) side of EDITSEARCH in the standby mode. The recorded section is played back.

+ : to go forward

- : to go backward

Release EDITSEARCH to stop playback. If you press START/STOP, re-recording begins from the point you released EDITSEARCH. You cannot monitor the sound.

Rec Review

You can check the section which you have stopped most recently.

Press the - (⊖) side of EDITSEARCH momentarily in the standby mode.

The section you have stopped most recently will be played back for a few seconds, and then your camcorder will return to the standby mode. You can monitor the sound from the speaker or headphones.

Notes

- END SEARCH, EDITSEARCH and Rec Review work only for tapes recorded in the Digital8  system.
- If you start recording after using the end search function, occasionally, the transition between the last scene you recorded and the next scene may not be smooth.
- Once you eject the cassette after you have recorded on the tape, the end search function does not work.

If a tape has a black portion in the recorded portions
The end search function may not work correctly.

Playing back a tape

You can monitor the playback picture on the LCD screen. If you close the LCD panel, you can monitor the playback picture in the viewfinder. You can control playback using the Remote Commander supplied with your camcorder.

- (1) Install the power source and insert the recorded tape.
- (2) Set the POWER switch to VTR while pressing the small green button. The video control buttons light up.
- (3) Open the LCD panel while pressing OPEN.
- (4) Press ◀◀ to rewind the tape.
- (5) Press ▶ to start playback.
- (6) To adjust the volume, press either of the two buttons on VOLUME. The speaker on your camcorder is silent when the LCD panel is closed.

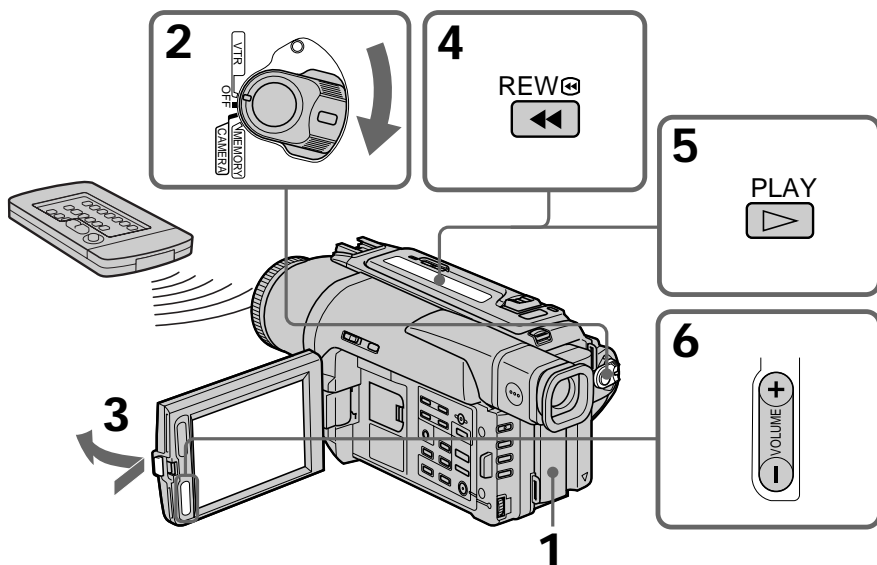

To stop playback

Press ■.

When monitoring on the LCD screen

You can turn the LCD panel over and move it back to the camcorder body with the LCD screen facing out.

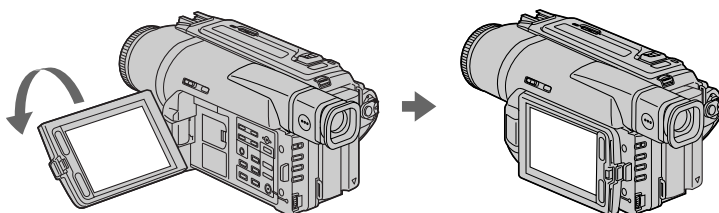

Playing back a tape

To display the screen indicators – Display function

Press DISPLAY on your camcorder or the Remote Commander supplied with your camcorder.

The indicators appear on the LCD screen.

To make the indicators disappear, press DISPLAY again.

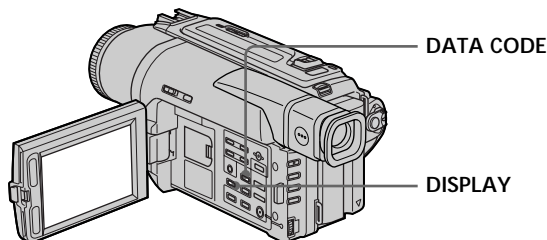

Using the data code function

Your camcorder automatically records not only images on the tape but also the recording data (date/time or various settings when recorded) (**Data code**).

Press DATA CODE on your camcorder or the Remote Commander in the playback mode.

The display changes as follows:

date/time → various settings (SteadyShot, exposure AUTO/MANUAL, white balance, gain, shutter speed, aperture value) → no indicator

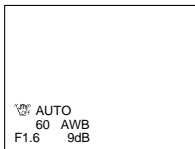
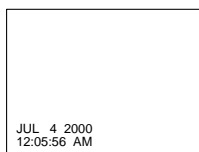

Not to display recording date

Set DATA CODE to DATE in the menu settings (p. 64).

The display changes as follows:

date/time → no indicator

Notes on the data code function

- The data code function works only for tapes recorded in the Digital8  system.
- Various settings of the recording data are not recorded when recording images on "Memory Stick."

Recording data

Recording data is your camcorder's information when you have recorded. In the recording mode, the recording data will not be displayed.

When you use data code function, bars (--- -- ---- and ---:--:--) appear if:

- A blank section of the tape is being played back.
- The tape is unreadable due to tape damage or noise.
- The tape was recorded by a camcorder without the date and time set.

Data code

When you connect your camcorder to the TV, the data code appears on the TV screen.

Various playback modes

To operate video control buttons, set the POWER switch to VTR.

To view a still image (playback pause)

Press **II** during playback. To resume playback, press **II** or **▶**.

To advance the tape

Press **▶▶** in the stop mode. To resume normal playback, press **▶**.

To rewind the tape

Press **◀◀** in the stop mode. To resume normal playback, press **▶**.

To change the playback direction

Press **<** on the Remote Commander during playback to reverse the playback direction. To resume normal playback, press **▶**.

To locate a scene monitoring the picture (picture search)

Keep pressing **◀◀** or **▶▶** during playback. To resume normal playback, release the button.

To monitor the high-speed picture while advancing or rewinding the tape (skip scan)

Keep pressing **◀◀** while rewinding or **▶▶** while advancing the tape. To resume rewinding or advancing, release the button.

To view the picture at slow speed (slow playback)

Press **▶** on the Remote Commander during playback. For slow playback in the reverse direction, press **<**, then press **▶** on the Remote Commander. To resume normal playback, press **▶**.

To view the picture at double speed

Press **×2** on the Remote Commander during playback. For double speed playback in the reverse direction, press **<**, then press **×2** on the Remote Commander. To resume normal playback, press **▶**.

To view the picture frame-by-frame

Press **II▶** on the Remote Commander in the playback pause mode. For frame-by-frame playback in the reverse direction, press **◀II**. To resume normal playback, press **▶**.

To search the last scene recorded (END SEARCH)

Press **END SEARCH** in the stop mode. The last 5 seconds of the recorded section plays back and stops.

In the various playback modes

- Noise may appear when your camcorder plays back tapes recorded in the Hi8/standard 8 system.
- Sound is muted.
- The previous recording may appear as a mosaic image when playing back in the Digital8 **▶** system.

Notes on the playback pause mode

- When the playback pause mode lasts for 3 minutes, your camcorder automatically enters the stop mode. To resume playback, press **▶**.
- The previous recording may appear.

Slow playback for tapes recorded in the Digital8 **▶ system**

The slow playback can be performed smoothly on your camcorder; however, this function does not work for an output signal from the **▶** DV IN/OUT jack.

When you play back a tape in reverse

Horizontal noise may appear at the center or top and bottom of the screen. This is not a malfunction.

Viewing the recording on TV

Connect your camcorder to your TV or VCR with the A/V connecting cable supplied with your camcorder to watch the playback picture on the TV screen. You can operate the playback control buttons in the same way as when you monitor playback pictures on the LCD screen. When monitoring the playback picture on the TV screen, we recommend that you power your camcorder from a wall outlet using the AC power adaptor (p. 14). Refer to the operating instructions of your TV or VCR.

Open the jack cover. Connect your camcorder to the TV using the A/V connecting cable. Then, set the TV/VCR selector on the TV to VCR.

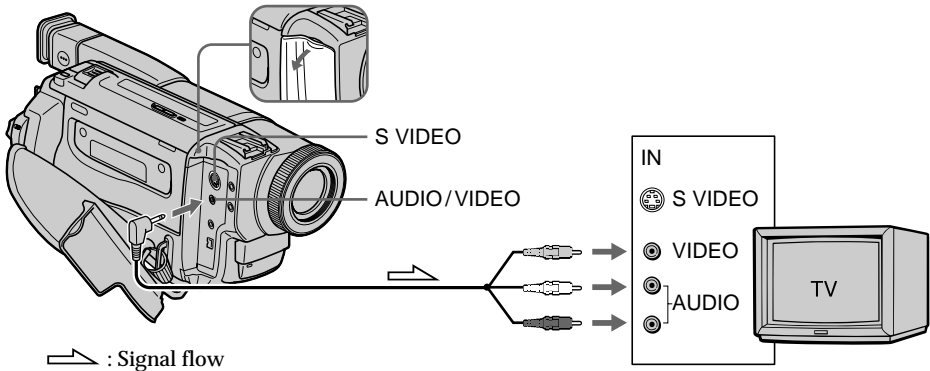

If your TV is already connected to a VCR

Connect your camcorder to the LINE IN input on the VCR by using the A/V connecting cable supplied with your camcorder. Set the input selector on the VCR to LINE.

If your TV or VCR is a monaural type

Connect the yellow plug of the A/V connecting cable to the video input jack and the white or the red plug to the audio input jack on the VCR or the TV. If you connect the white plug, the sound is L (left) signal. If you connect the red plug, the sound is R (right) signal.

If your TV or VCR has an S video jack

Connect using an S video cable (not supplied) to obtain high-quality pictures.

With this connection, you do not need to connect the yellow (video) plug of the A/V connecting cable.

Connect an S video cable (not supplied) to the S video jacks on both your camcorder and the TV or the VCR.

Viewing the recording on TV

Using the AV cordless IR receiver

Once you connect the AV cordless IR receiver (not supplied) to your TV or VCR, you can easily view the picture on your TV. For details, refer to the operating instructions of the AV cordless IR receiver.

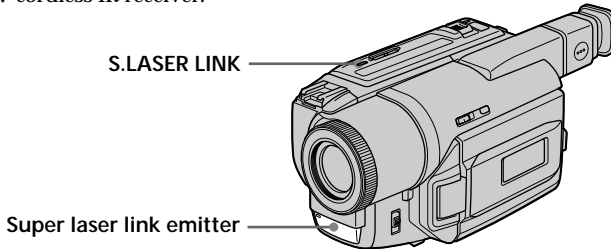

Before operation

Attach the power supply such as the AC power adaptor to your camcorder, and insert the recorded tape.

- (1) After connecting your TV and AV cordless IR receiver, set the POWER switch on the AV cordless IR receiver to ON.
- (2) Turn the TV on and set the TV/VCR selector on the TV to VCR.
- (3) Set the POWER switch on your camcorder to VTR
- (4) Press S.LASER LINK. The lamp of S.LASER LINK lights up.
- (5) Press ► on your camcorder to start playback.
- (6) Point the super laser link emitter at the AV cordless IR receiver. Adjust the position of your camcorder and the AV cordless IR receiver to obtain clear playback pictures.

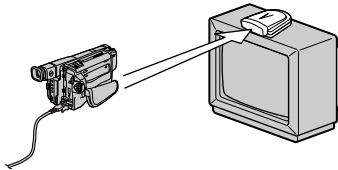

To cancel the super laser link function

Press S.LASER LINK. The lamp on the S.LASER LINK button goes out.

If you use a Sony TV

- You can turn on the TV automatically when you press S.LASER LINK on your camcorder. To do so, do as follow in advance:
 - Turn the TV's main switch on.
 - Set AUTO TV ON to ON in the menu settings.
 - Point the super laser link emitter of your camcorder at the TV's remote sensor.
- You can switch the video input of the TV automatically to the one which the AV cordless IR receiver is connected. To do so, set AUTO TV ON to ON and TV INPUT to the same video input (1, 2, 3) in the menu settings. With some models, however, the picture and sound may be disconnected momentarily when the video input is switched.
- The above feature may not work on some TV models.

If you turn the power off

Super laser link function turns off automatically.

When super laser link is activated (the S.LASER LINK button is lit)

Your camcorder consumes power. Press S.LASER LINK to turn off the super laser link function when it is not needed.

Recording a still image on a tape

- Tape Photo recording

You can record a still image like a photograph. This mode is useful when you want to record an image such as a photograph or when you print a picture using a video printer (not supplied).

You can record about 510 images in the SP mode and about 765 images in the LP mode on a tape which can record for 60 minutes in the SP mode.

Besides the operation described here, your camcorder can record still images on "Memory Stick"s (p. 72).

(1) In the standby mode, keep pressing PHOTO lightly until a still image appears. The CAPTURE indicator appears. Recording does not start yet.

To change the still image, release PHOTO, select a still image again, and then press and hold PHOTO lightly.

(2) Press PHOTO deeper.

The still image on the LCD screen or in the viewfinder is recorded for about seven seconds. The sound during those seven seconds is also recorded.

The still image is displayed on the LCD screen or in the viewfinder until recording is completed.

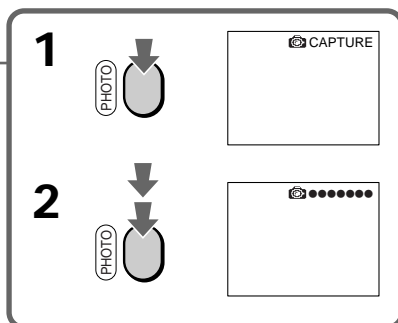
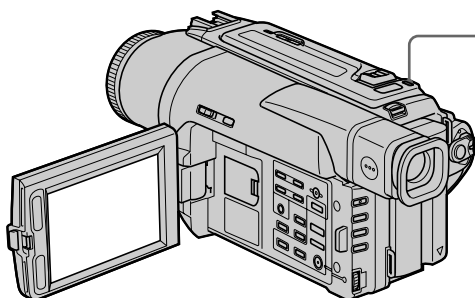

Notes

- During the tape photo recording, you cannot change the mode or setting.
- The PHOTO button does not work:
 - while the digital effect function is set or in use.
 - while the fader function is in use.
- When recording a still image, do not shake your camcorder. Mosaic-pattern noise may appear on the image.

To use tape photo recording function using the Remote Commander

Press PHOTO in the Remote Commander. Your camcorder records an image on the LCD screen or in the viewfinder immediately.



When you use the tape photo recording function during normal CAMERA recording

You cannot check an image on the LCD screen or in the viewfinder by pressing PHOTO lightly. Press PHOTO deeper. The still image is then recorded for about seven seconds, and your camcorder returns to the standby mode. During the seven seconds to record, you cannot shoot another still image.

Recording a still image on a tape – Tape Photo recording

Self-timer tape photo recording

You can record still images on tapes with the self-timer. This mode is useful when you want to record yourself. You can also use the Remote Commander for this operation.



(1) In the standby mode, press  (self-timer). The  (self-timer) indicator appears on the LCD screen or in the viewfinder.

(2) Press PHOTO firmly.

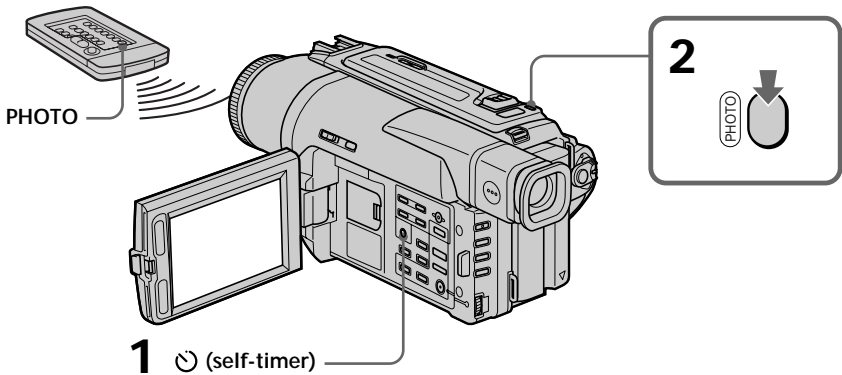
Self-timer starts counting down from 10 with a beep sound. In the last two seconds of the countdown, the beep sound gets faster, then recording starts automatically.



To cancel self-timer recording

Press  (self-timer) so that the  indicator disappears from the LCD or viewfinder screen while your camcorder is in the standby mode. You cannot cancel self-timer recording with the Remote Commander.

Note

The self-timer recording mode is automatically cancelled when:

- Self-timer recording is finished.
- The POWER switch is set to OFF (CHARGE) or VTR.

Recording a still image on a tape – Tape Photo recording

Printing the still image

You can print a still image by using the video printer (not supplied). Connect the video printer using the A/V connecting cable supplied with your camcorder. Connect the A/V connecting cable to the AUDIO/VIDEO jack and connect the yellow plug of the cable to the video input of the video printer. Refer to the operating instructions of the video printer as well.

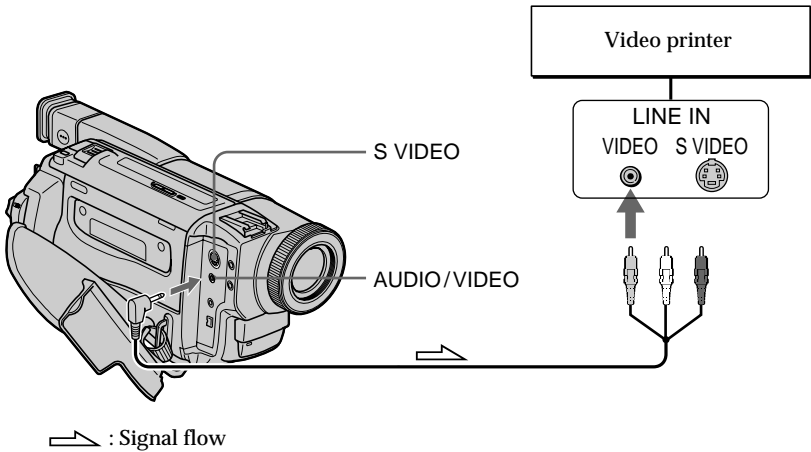

If the video printer is equipped with S video input

Use the S video connecting cable (not supplied). Connect it to the S VIDEO jack and the S video input of the video printer.

Using the wide mode

You can record a 16:9 wide picture to watch on the 16:9 wide-screen TV (16:9 WIDE). Black bands appear on the LCD screen or in the viewfinder (DCR-TRV525) during recording in 16:9 WIDE mode [a]. The picture during playing back in the viewfinder (DCR-TRV520), on a normal TV [b] or a wide-screen TV [c] are compressed in the widthwise direction. If you set the screen mode of the wide-screen TV to the full mode, you can watch pictures of normal images [d].

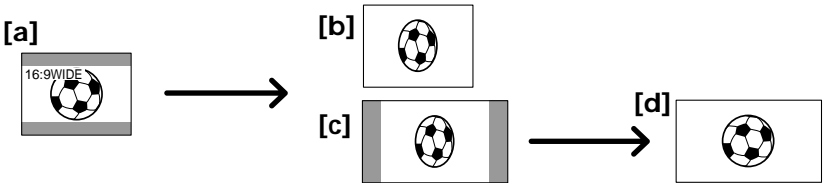

In the standby mode, set 16:9WIDE to ON in the menu settings (p. 64).

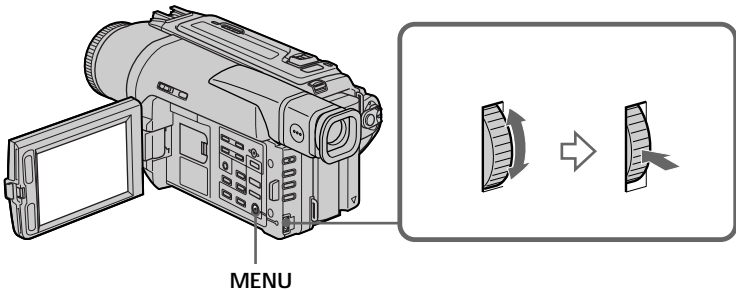

To cancel the wide mode

Set 16:9WIDE to OFF in the menu settings.

In the wide mode, you cannot select the following functions:

- Old movie
- Bounce

During recording

You cannot select or cancel the wide mode. When you cancel the wide mode, set your camcorder to the standby mode and then set 16:9WIDE to OFF in the menu setting.

Connection for a TV

Pictures recorded in the 16:9WIDE mode automatically appear on the TV screen at full size when:

- you connect your camcorder to a TV that is compatible with the video ID (ID-1/ID-2) system.
- you connect your camcorder to the S video jack on the TV.

ID-2 system

The ID-2 system sends a copyright protection signal with ID-1 signals inserted between video signals when you connect your camcorder to other equipment by an A/V connecting cable.

If the wide mode is set to ON

The SteadyShot function does not work. If you set 16:9WIDE to ON in the menu settings when the SteadyShot function is working, the  flashes and the SteadyShot function does not function.

Using the fader function

You can fade the picture in or out to give your recording a professional appearance.

[a] STBY REC

FADER



M.FADER
(mosaic)



BOUNCE^{1) 2)}

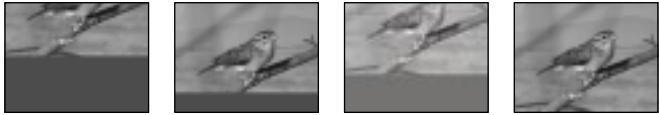

OVERLAP²⁾

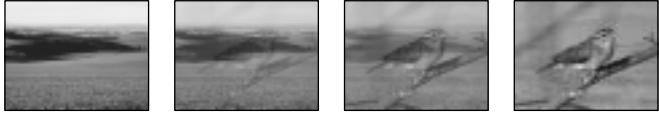

WIPE²⁾



DOT²⁾
(random dot)

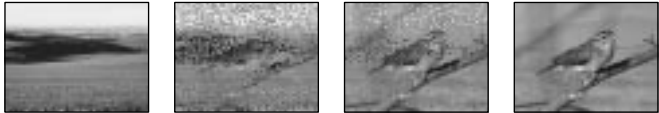

[b] STBY REC

MONOTONE

When fading in, the picture gradually changes from black-and-white to color.
When fading out the picture gradually changes from color to black-and-white.

¹⁾ You can use this function when D ZOOM is set to OFF in the menu setting.

²⁾ Fade in only

Using the fader function

(1) When fading in [a]

In the standby mode, press FADER until the desired fader indicator flashes.

When fading out [b]

In the recording mode, press FADER until the desired fader indicator flashes.

The indicator changes as follows:

FADER → M.FADER → BOUNCE → MONOTONE → OVERLAP → WIPE → DOT

The last selected fader mode is indicated first of all.

(2) Press START/STOP. The fader indicator stops flashing.

After the fade in/out is carried out, your camcorder automatically returns to the normal mode.

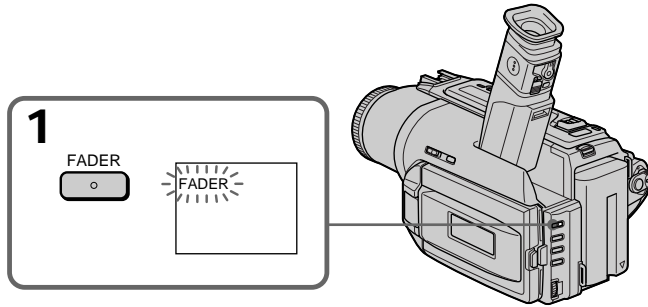

To cancel the fader function

Before pressing START/STOP, press FADER until the indicator disappears.

Notes

- The overlap, wipe and dot functions work only for tapes recorded in the Digital8  system.
- You cannot use the following functions while using the fader function. Also, you cannot use the fader function while using the following functions:
 - Digital effect
 - Low lux mode of PROGRAM AE (Overlap, wipe, or dot function only)
 - Super NightShot
 - Tape photo recording

Before operating the overlap, wipe, or dot function

Your camcorder stores the image on the tape. As the image is being stored, the indicator flashes quickly, and the image you are shooting disappears from the LCD or viewfinder screen. Depending on the tape condition, the image may not be recorded clearly.

While using the bounce function, you cannot use the following functions:

- Focus
- Zoom
- Picture effect

Note on the bounce function

The BOUNCE indicator does not appear in the following mode or functions:

- D ZOOM is activated in the menu settings
- Wide mode
- Picture effect
- PROGRAM AE

Using special effects – Picture effect

You can digitally process images to obtain special effects like those in films or on the TV.

NEG. ART [a] : The color and brightness of the image is reversed.

SEPIA : The image is sepia.

B&W : The image is monochrome (black-and-white).

SOLARIZE [b] : The light intensity is clearer, and the picture looks like an illustration.

SLIM [c] : The image expands vertically.

STRETCH [d] : The image expands horizontally.

PASTEL [e] : The contrast of the image is emphasized, and the image looks like an animated cartoon.

MOSAIC [f] : The image is mosaic.

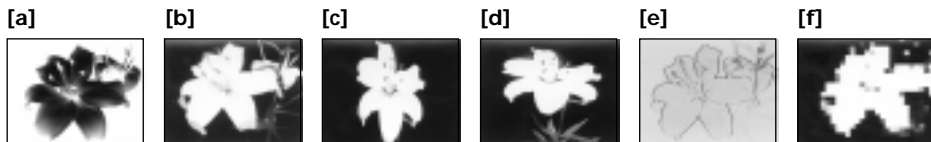

(1) Press PICTURE EFFECT in CAMERA mode.

The picture effect indicator appears.

(2) Turn the SEL/PUSH EXEC dial to select the desired picture effect mode.

The indicator changes as follows:

NEG.ART ↔ SEPIA ↔ B&W ↔ SOLARIZE ↔ SLIM ↔ STRETCH ↔

PASTEL ↔ MOSAIC

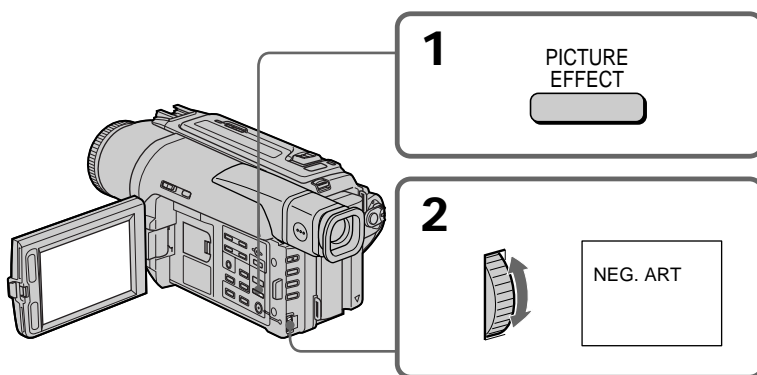

To turn the picture effect function off

Press PICTURE EFFECT.

While using the picture effect function

You cannot select OLD MOVIE with DIGITAL EFFECT.

When you turn the power off

The picture effect is automatically canceled.

Using special effects – Digital effect

You can add special effects to recorded image using the various digital functions. The sound is recorded normally.

STILL

You can record a still image so that it is superimposed on a moving image.

FLASH (FLASH MOTION)

You can record still images successively at constant intervals.

LUMI. (LUMINANCEKEY)

You can swap a brighter area in a still image with a moving image.

TRAIL

You can record the image so that an incidental image like a trail is left.

SLOW SHTR (SLOW SHUTTER)

You can slow down the shutter speed. The slow shutter mode is good for recording dark images more brightly. However, the image may be less clear.

OLD MOVIE

You can add an old movie type atmosphere to images. Your camcorder automatically sets the wide mode to ON, picture effect to SEPIA, and the appropriate shutter speed.

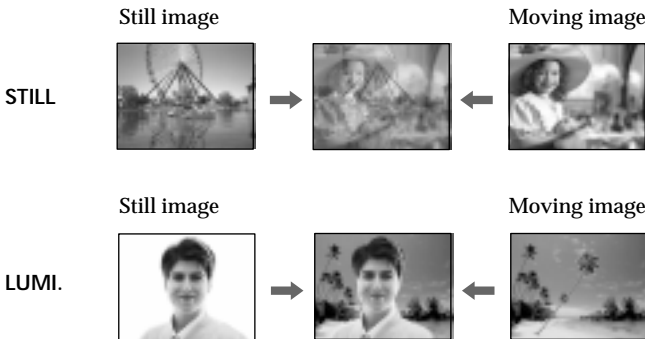

Using special effects – Digital effect

- (1) Press DIGITAL EFFECT in CAMERA mode. The digital effect indicator appears.
- (2) Turn the SEL/PUSH EXEC dial to select the desired digital effect mode. The indicator changes as follows:
STILL ↔ FLASH ↔ LUMI. ↔ TRAIL ↔ SLOW SHTR ↔ OLD MOVIE
- (3) Press the SEL/PUSH EXEC dial. The indicator lights up and the bars appear. In the STILL and LUMI. modes, the still image is stored in memory.
- (4) Turn the SEL/PUSH EXEC dial to adjust the effect as follows:

STILL – The rate of the still image you want to superimpose on the moving image

FLASH – The interval of flash motion

LUMI. – The color scheme of the area in the still image which is to be swapped with a moving image

TRAIL – The vanishing time of the incidental image

SLOW SHTR – Shutter speed. The larger the shutter speed number, the slower the shutter speed.

OLD MOVIE – No adjustment necessary

The more bars there are on screen, the stronger the digital effect. The bars appear in the following modes: STILL, FLASH, LUMI. and TRAIL.

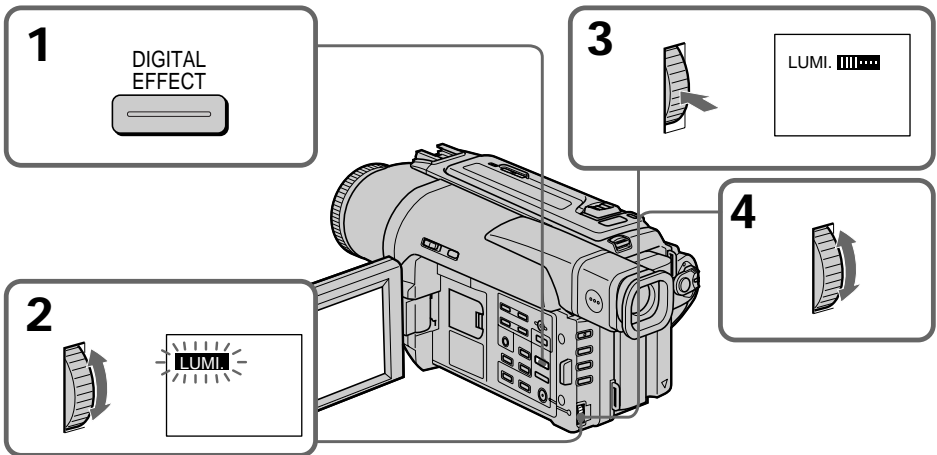

To cancel the digital effect

Press DIGITAL EFFECT.

Using special effects – Digital Effect

Notes

- The following functions do not work during digital effect:
 - Fader
 - Low lux mode of PROGRAM AE
 - Tape photo recording
 - Super NightShot
- The following functions do not work in the slow shutter mode:
 - Exposure
 - PROGRAM AE
- The following functions do not work in the old movie mode:
 - Exposure
 - Wide mode
 - Picture effect
 - PROGRAM AE

When you turn the power off

The digital effect is automatically canceled.

When recording in the slow shutter mode

Auto focus may not be effective. Focus manually using a tripod.

Shutter speed

Shutter speed number	Shutter speed
SLOW SHTR 1	1/30
SLOW SHTR 2	1/15
SLOW SHTR 3	1/8
SLOW SHTR 4	1/4

Using the PROGRAM AE function

You can select PROGRAM AE (Auto Exposure) mode to suit your specific shooting requirements.

Spotlight mode

This mode prevents people's faces, for example, from appearing excessively white when shooting subjects lit by strong light in the theater.

Soft portrait mode

This mode brings out the subject while creating a soft background for subjects such as people or flowers.

Sports lesson mode

This mode minimizes shake on fast-moving subjects such as in tennis or golf.

Beach & ski mode

This mode prevents people's faces from appearing dark in strong light or reflected light, such as at a beach in midsummer or on a ski slope.

Sunset & moon mode

This mode allows you to maintain atmosphere when you are recording sunsets, general night views, fireworks displays and neon signs.

Landscape mode

This mode is for when you are recording distant subjects such as mountains and prevents your camcorder from focusing on glass or metal mesh in windows when you are recording a subject behind glass or a screen.

Low lux mode

This mode makes subjects brighter in insufficient light.



Adjusting the exposure manually

You can manually adjust and set the exposure.

Adjust the exposure manually in the following cases:

- The subject is backlit
- Bright subject and dark background
- To record dark pictures (e.g. night scenes) faithfully

(1) Press EXPOSURE in CAMERA or MEMORY mode.

The exposure indicator appears on the LCD screen or in the viewfinder.

(2) Turn the SEL/PUSH EXEC dial to adjust the brightness.

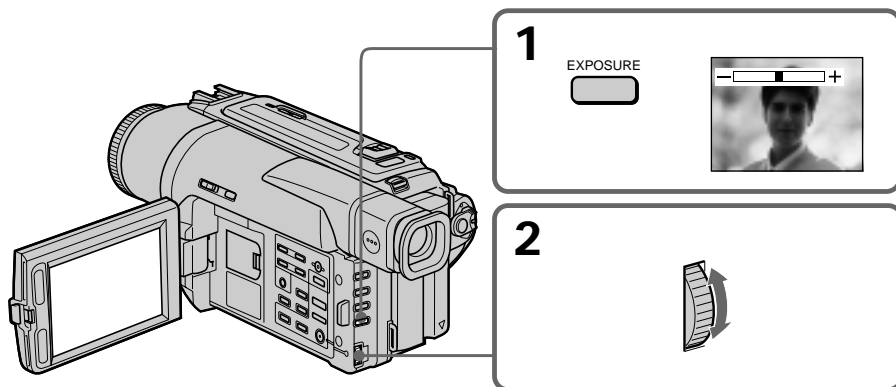

To return to the automatic exposure mode

Press EXPOSURE.

Notes

- When you adjust the exposure manually, the following function and modes do not work in CAMERA mode:
 - Backlight
 - Old movie
 - Slow shutter
- When you adjust the exposure manually, the backlight function does not work in MEMORY mode.

Your camcorder automatically returns to the automatic mode:

- if you change the PROGRAM AE mode
- if you slide NIGHTSHOT to ON

Focusing manually

You can gain better results by manually adjusting the focus in the following cases:

- The autofocus mode is not effective when shooting:
 - subjects through glass coated with water droplets.
 - horizontal stripes.
 - subjects with little contrast with backgrounds such as walls and sky.
- When you want to change the focus from a subject in the foreground to a subject in the background.
- Shooting a stationary subject when using a tripod.

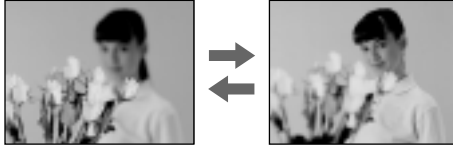

- (1) Set FOCUS to MANUAL in CAMERA or MEMORY mode. The  indicator appears on the LCD screen or in the viewfinder.
- (2) Turn the focus ring to sharpen focus.

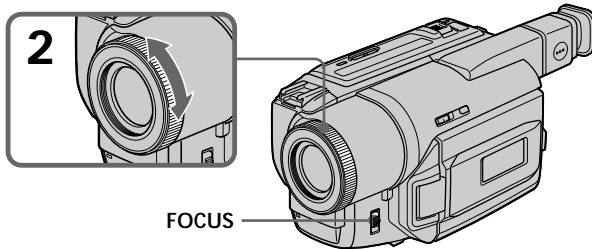

To return to the autofocus mode

Set FOCUS to AUTO.

To record distant subjects

When you press FOCUS down to INFINITY. The lens focuses on infinity and  indicator appears. When you release FOCUS, your camcorder returns to the manual focus mode. Use this mode when your camcorder focuses on near objects even though you are trying to shoot a distant object.



To focus precisely

Adjust the zoom by first focusing at the “T” (telephoto) position and then shooting at the “W” (wide-angle) position. This makes focusing easier.

When you shoot close to the subject

Focus at the end of the “W” (wide-angle) position.

 changes to the following indicators:

-  when recording a distant subject.
-  when the subject is too close to focus on.

Superimposing a title

You can select one of eight preset titles and two custom titles (p. 46). You can also select the language, color, size and position of titles.



- (1) Press TITLE to display the title menu in the standby mode.
- (2) Turn the SEL/PUSH EXEC dial to select , then press the dial.
- (3) Turn the SEL/PUSH EXEC dial to select the desired title, then press the dial. The titles are displayed in the language you selected.
- (4) Change the color, size, or position, if necessary.
 - ① Turn the SEL/PUSH EXEC dial to select the color, size, or position, then press the dial. The item appears.
 - ② Turn the SEL/PUSH EXEC dial to select the desired item, then press the dial.
 - ③ Repeat steps ① and ② until the title is laid out as desired.
- (5) Press the SEL/PUSH EXEC dial again to complete the setting.
- (6) Press START/STOP to start recording.
- (7) When you want to stop recording the title, press TITLE.

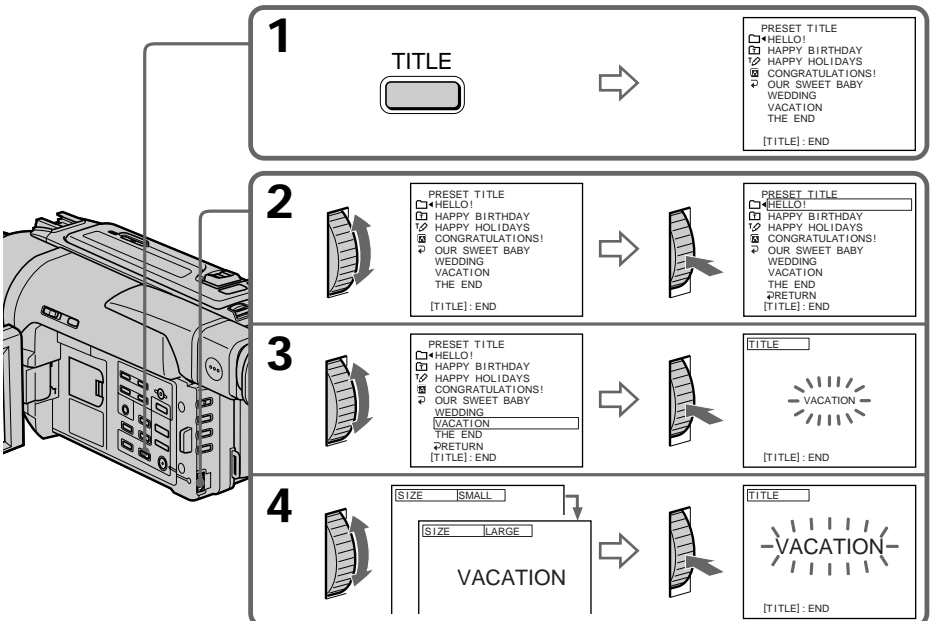

Superimposing a title

To superimpose the title while you are recording

Press TITLE while you are recording, and carry out steps 2 to 5. When you press the SEL/PUSH EXEC dial at step 5, the title is recorded.

To select the language of a preset title

If you want to change the language, select  before step 2. Then select the desired language and return to step 2.

If you display the menu while superimposing a title

The title is not recorded while the menu is displayed.

To use the custom title

If you want to use the custom title, select  in step 2.

If you have not made any custom title, “- - - - -” appears on the display.

Title setting

• The title color changes as follows :

WHITE ↔ YELLOW ↔ VIOLET ↔ RED ↔ CYAN ↔ GREEN ↔ BLUE

• The title size changes as follows :

SMALL ↔ LARGE

You cannot input more than 12 characters in LARGE size.

• The title position changes as follows :

1 ↔ 2 ↔ 3 ↔ 4 ↔ 5 ↔ 6 ↔ 7 ↔ 8 ↔ 9

The larger the position number, the lower the title is positioned.

When you select the title size LARGE, you cannot choose position 9.

When you are selecting and setting the title

You cannot record the title displayed on the screen.

When you superimpose a title while you are recording

The beep does not sound.

While you are playing back

You can superimpose a title. However, the title is not recorded on tape.

You can record a title when you dub a tape connecting your camcorder to the VCR with the A/V connecting cable. If you use the i. LINK cable instead of the A/V connecting cable, you cannot record the title.

Making your own titles

You can make up to two titles and store them in your camcorder. Each title can have up to 20 characters.

- (1) Press TITLE in the standby or VTR mode.
- (2) Turn the SEL/PUSH EXEC dial to select \varnothing , then press the dial.
- (3) Turn the SEL/PUSH EXEC dial to select the first line (CUSTOM1) or second line (CUSTOM2), then press the dial.
- (4) Turn the SEL/PUSH EXEC dial to select the column of the desired character, then press the dial.
- (5) Turn the SEL/PUSH EXEC dial to select the desired character, then press the dial.
- (6) Repeat steps 4 and 5 until you have selected all characters and completed the title.
- (7) To finish making your own titles, turn the SEL/PUSH EXEC dial to select [SET], then press the dial. The title is stored in memory.
- (8) Press TITLE to make the title menu disappear.

1

TITLE



PRESET TITLE

- HELLO!
- HAPPY BIRTHDAY
- HAPPY HOLIDAYS
- CONGRATULATIONS!
- OUR SWEET BABY
- WEDDING
- VACATION
- THE END

[TITLE]: END

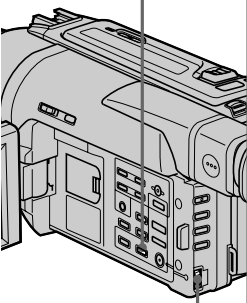

2





TITLE SET

CUSTOM1 "-----"

CUSTOM2 "-----"

[TITLE]: END







TITLE SET

RETURN

[TITLE]: END



3



TITLE SET

RETURN

[TITLE]: END





TITLE SET P1

ABCDE 12345 \$FWNE

FGHIJ 67890 \varnothing io"

KL MNO AE IOU [+]

PRST AE IOU [+P]

UVWXY AE O E E [SET]

Z & ? ! A O N G B

.. / - A IO U A

[TITLE]: END



4



TITLE SET P1

ABCDE 12345 \$FWNE

FGHIJ 67890 \varnothing io"

KL MNO AE IOU [+]

PRST AE IOU [+P]

UVWXY AE O E E [SET]

Z & ? ! A O N G B

.. / - A IO U A

[TITLE]: END





TITLE SET P1

ABCDE 12345 \$FWNE

FGHIJ 67890 \varnothing io"

KL MNO AE IOU [+]

PRST AE IOU [+P]

UVWXY AE O E E [SET]

Z & ? ! A O N G B

.. / - A IO U A

[TITLE]: END



Making your own titles

To change a title you have stored

In step 3, select CUSTOM1 or CUSTOM2, depending on which title you want to change, then press the SEL/PUSH EXEC dial. Turn the SEL/PUSH EXEC dial to select [←], then press the dial to delete the title. The last character is erased. Enter the new title as desired.

If you take 3 minutes or longer to enter characters in the standby mode while a cassette is in your camcorder

The power automatically goes off. The characters you have entered remain stored in memory. Set the POWER switch to OFF (CHARGE) once, and turn it to CAMERA again, then proceed from step 1.

We recommend setting the POWER switch to VTR or removing the cassette so that your camcorder does not automatically turn off while you are entering title characters.

If you select [→P2]

The menu for selecting alphabet and Russian characters appear. Select [→P1] to return to the previous screen.

To erase a character

Select [←]. The last character is erased.

To enter a space

Select [Z& ?!], then select the blank part.

Inserting a scene

You can insert a scene in the middle of a recorded tape by setting the start and end points. The previously recorded frames between these start and end points will be erased. Use the Remote Commander for this operation.

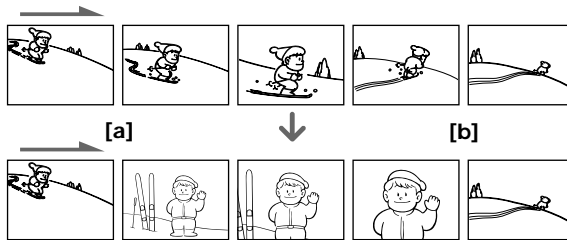

- (1) While your camcorder is in the standby mode, keep pressing EDITSEARCH, and release the button at the insert end point [b].
- (2) Press ZERO SET MEMORY. The ZERO SET MEMORY indicator flashes and the counter resets to zero.
- (3) Keep pressing the - ⊖ side of EDITSEARCH and release the button at the insert start point [a].
- (4) Press START/STOP to start recording. The scene is inserted. Recording stops automatically near the counter zero point. Your camcorder returns to the standby mode.

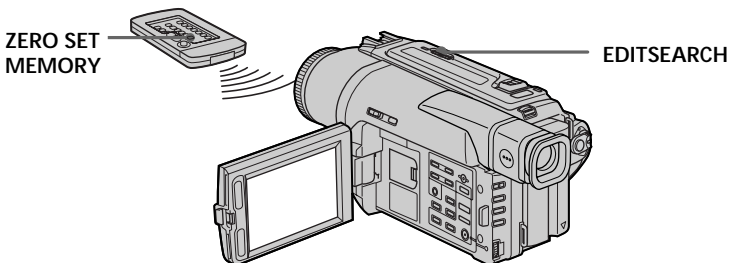

Notes

- The zero set memory function works only for tapes recorded in the Digital8  system.
- The picture and the sound may be distorted at the end of the inserted section when it is played back.

If a tape has a blank portion in the recorded portions
The zero set memory function may not work correctly.

Playing back a tape with picture effects

During playback, you can process a scene using the picture effect functions: NEG.ART, SEPIA, B&W and SOLARIZE.

During playback, press PICTURE EFFECT and turn the SEL/PUSH EXEC dial until the desired picture effect indicator (NEG.ART, SEPIA, B&W or SOLARIZE) appears. For details of each picture effect function, see page 36.

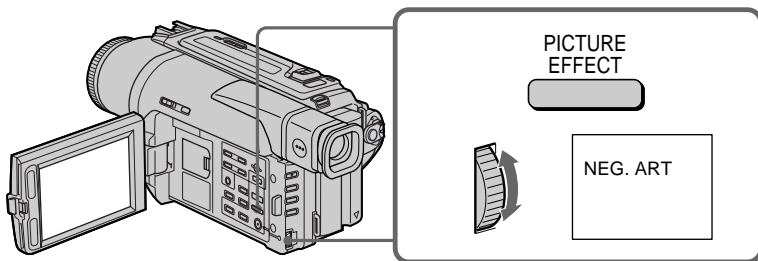

To cancel the picture effect function

Press PICTURE EFFECT.

Notes

- The picture effect function works only for tapes recorded in the Digital8  system.
- You cannot process externally input scenes using the picture effect function.
- You cannot record pictures that you have processed using the picture effect function with this camcorder. To record pictures that you have processed using the picture effect function, record the pictures on the VCR using your camcorder as a player.

Pictures processed by the picture effect function

Pictures processed by the picture effect function are not output through the  DV IN/OUT jack.

When you set the POWER switch to OFF (CHARGE) or stop playing back
The picture effect function is automatically canceled.

Playing back a tape with digital effects

During playback, you can process a scene using the digital effect functions: STILL, FLASH, LUMI. and TRAIL.

- (1) During playback, press DIGITAL EFFECT and turn the SEL/PUSH EXEC dial until the desired digital effect indicator (STILL, FLASH, LUMI. or TRAIL) flashes.
- (2) Press the SEL/PUSH EXEC dial.
The digital effect indicator lights up and the bars appear. In the STILL or LUMI. mode, the image where you press the SEL/PUSH EXEC dial is stored in memory as a still image.
- (3) Turn the SEL/PUSH EXEC dial to adjust the effect.
For details of each digital effect function, see page 37.

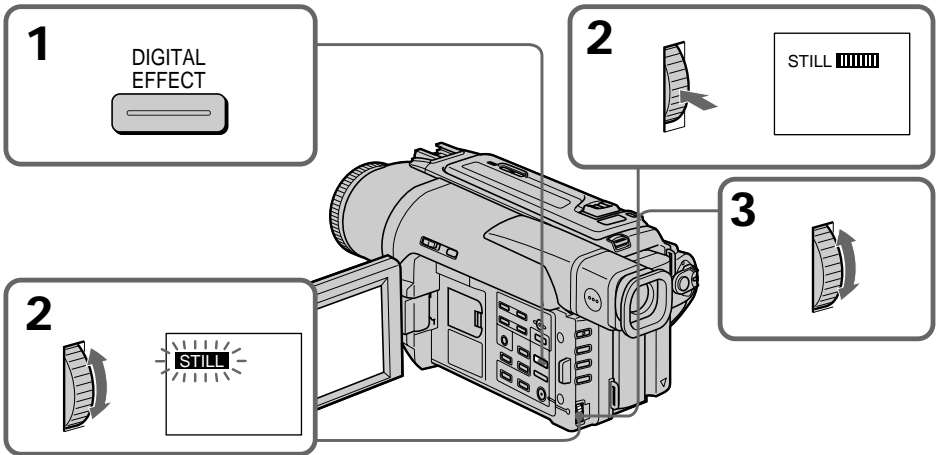

To cancel the digital effect function

Press DIGITAL EFFECT.

Notes

- The digital effect function works only for tapes recorded in the Digital8  system.
- You cannot process externally input scenes using the digital effect function.
- You cannot record images that you have processed using the digital effect function with this camcorder. To record images that you have processed using the digital effect function, record the images on the VCR using your camcorder as a player.

Pictures processed by the digital effect function

Pictures processed by the digital effect function are not output through the  DV IN/OUT jack.

When you set the POWER switch to OFF (CHARGE) or stop playing back
The digital effect function is automatically canceled.

Enlarging recorded images – PB ZOOM

You can enlarge moving and still images recorded on tapes.

Besides the operation described here, your camcorder can enlarge still images recorded on "Memory Stick"s.

(1) Press PB ZOOM on your camcorder while you are playing back. The image is enlarged, and $\uparrow\downarrow$ appears on the LCD screen or in the viewfinder.

(2) Turn SEL/PUSH EXEC dial to move the enlarged image, then press the dial.

\uparrow : The image moves downwards.

\downarrow : The image moves upwards.

$\leftarrow \rightarrow$ becomes available.

(3) Turn SEL/PUSH EXEC dial to move the enlarged image, then press the dial.

\leftarrow : The image moves rightward (Turn the dial downwards.)

\rightarrow : The image moves leftward (Turn the dial upwards.)

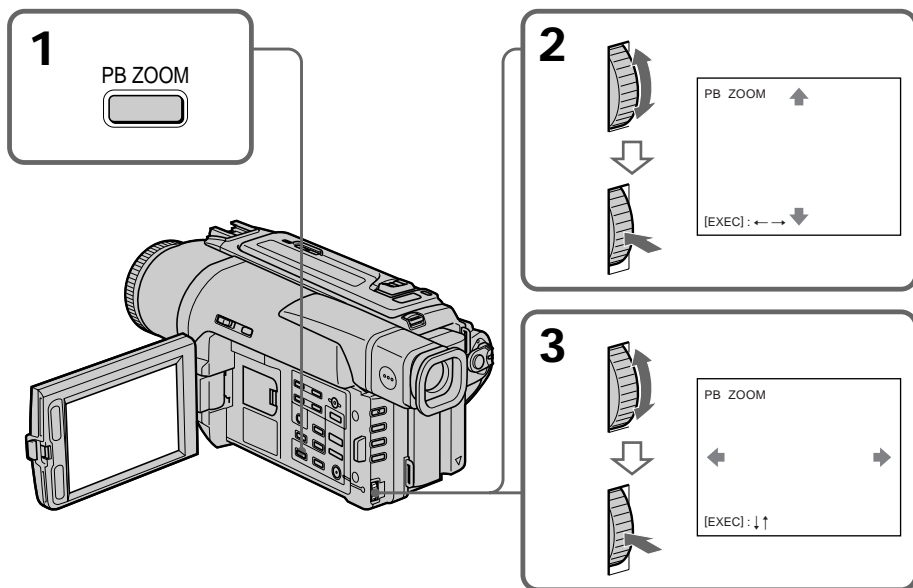

To cancel PB ZOOM function

Press PB ZOOM.

Notes

- PB ZOOM works only for tapes recorded in the Digital8 \mathcal{D} system.
- You cannot process externally input scenes using PB ZOOM function.
- You cannot record pictures that you have processed using PB ZOOM function with this camcorder. To record pictures that you have processed using PB ZOOM function, record the pictures on the VCR using your camcorder as a player.

Pictures processed by PB ZOOM function

Pictures processed by PB ZOOM function are not output through the \mathcal{D} DV IN/OUT jack.

When you set the POWER switch to OFF (CHARGE) or stop playing back PB ZOOM function is automatically canceled.

Quickly locating a scene using the zero set memory function

Your camcorder goes forward or backward to automatically stop at a desired scene having a counter value of "0:00:00".

Use the Remote Commander for this operation.

Use this function, for example, to view a desired scene later on during playback.

- (1) In the playback mode, press DISPLAY.
- (2) Press ZERO SET MEMORY at the point you want to locate later. The counter shows "0:00:00" and the ZERO SET MEMORY indicator flashes.
- (3) Press ■ when you want to stop playback.
- (4) Press ◀◀ to rewind the tape to the counter's zero point. The tape stops automatically when the counter reaches approximately zero. The ZERO SET MEMORY indicator disappears and the time code appears.
- (5) Press ▶▶. Playback starts from the counter's zero point.

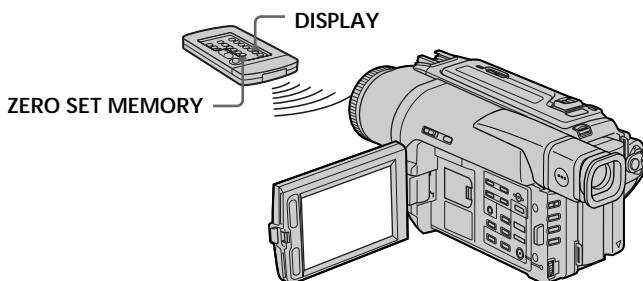

Notes

- The zero set memory function works only for tapes recorded in the Digital8 **D8** system.
- When you press ZERO SET MEMORY before rewinding the tape, the zero set memory function is canceled.
- There may be a discrepancy of several seconds from the time code.

If a tape has a blank portion in the recorded portions

The zero set memory function may not work correctly.

ZERO SET MEMORY functions also in the standby mode

When you insert a scene in the middle of a recorded tape, press ZERO SET MEMORY at the point you want to end the insertion. Rewind the tape to the insert start point, and start recording. Recording stops automatically at the tape counter zero point. Your camcorder returns to the standby mode.

Searching a recording by date

- Date search

You can automatically search for the point where the recording date changes and start playback from that point (**Date search**). Use the Remote Commander for this operation. Use this function to check where recording dates change or to edit the tape at each recording date.

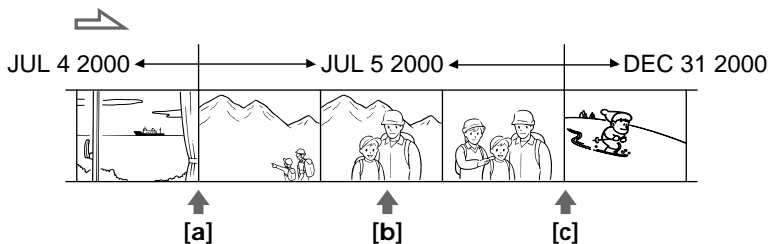

- (1) Set the POWER switch to VTR.
- (2) Press SEARCH MODE on the Remote Commander repeatedly, until the date search indicator appears.
The indicator changes as follows:
DATE SEARCH → PHOTO SEARCH → PHOTO SCAN
- (3) When the current position is [b], press ◀◀ to search towards [a] or press ▶▶ to search towards [c]. Your camcorder automatically starts playback at the point where the date changes.
Each time you press ◀◀ or ▶▶, the camcorder searches for the previous or next date.

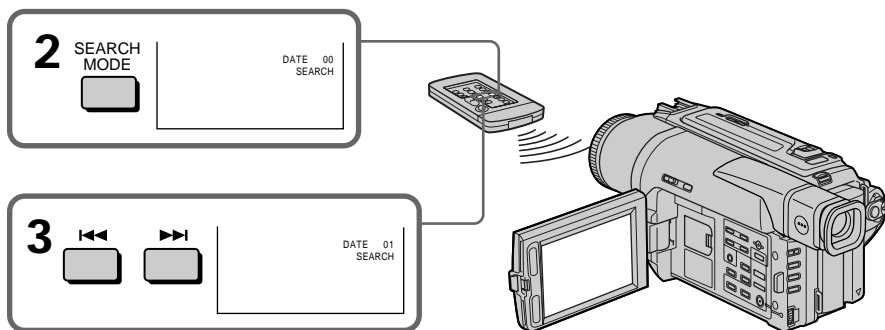

To stop searching

Press ■.

Searching a recording by date – Date search

Notes

- The date search works only for tapes recorded in the Digital8  system.
- If one day's recording is less than two minutes, your camcorder may not accurately find the point where the recording date changes.

If a tape has a blank portion in the recorded portions

The date search function may not work correctly.

Searching for a photo

- Photo search/Photo scan

You can search for the recorded still image recorded on tape (**photo search**). You can also search for still images one after another and display each image for five seconds automatically (**photo scan**). Use the Remote Commander for these operations.

Searching for a photo

- (1) Set the POWER switch to VTR.
- (2) Press SEARCH MODE on the Remote Commander repeatedly, until the photo search indicator appears.
The indicator changes as follows:
DATE SEARCH → PHOTO SEARCH → PHOTO SCAN
- (3) Press ◀◀ or ▶▶ to select the photo for playback. Each time you press ◀◀ or ▶▶, the camcorder searches for the previous or next photo. Your camcorder automatically starts playback from the photo.

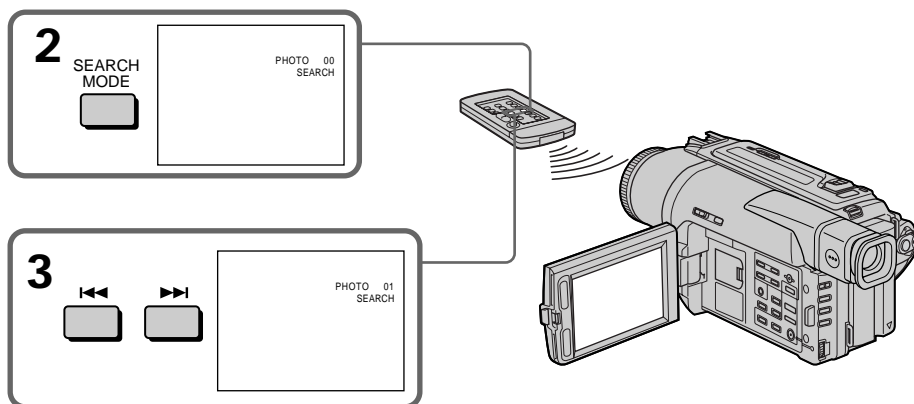

To stop searching

Press ■.

Searching for a photo – Photo search/Photo scan

Scanning photo

- (1) Set the POWER switch to VTR.
- (2) Press SEARCH MODE on the Remote Commander repeatedly, until the photo scan indicator appears.
The indicator changes as follows:
DATE SEARCH → PHOTO SEARCH → PHOTO SCAN
- (3) Press **◀◀** or **▶▶**.
Each photo is played back for about 5 seconds automatically.

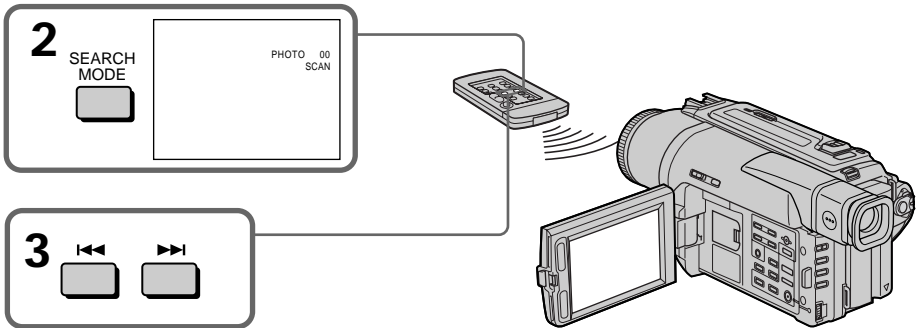

To stop scanning

Press **■**.

Note

The photo search and photo scan work only for tapes recorded in the Digital8 **Ⓛ** system.

If a tape has a blank portion in the recorded portions

The photo search and photo scan functions may not work correctly.

Dubbing a tape

Using the A/V connecting cable

Connect your camcorder to the VCR using the A/V connecting cable supplied with your camcorder.

- (1) Insert a blank tape (or a tape you want to record over) into the VCR, and insert the recorded tape into your camcorder.
- (2) Set the input selector on the VCR to LINE. Refer to the operating instructions of your VCR for more information.
- (3) Set the POWER switch to VTR.
- (4) Play back the recorded tape on your camcorder.
- (5) Start recording on the VCR.

Refer to the operating instructions of your VCR for more information.

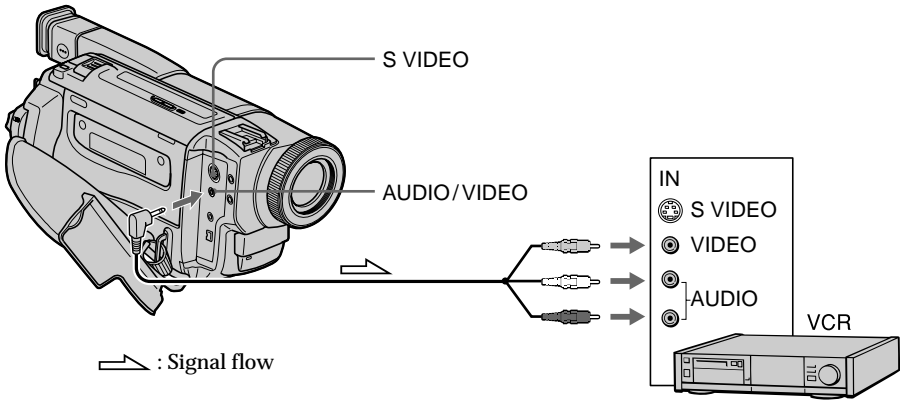

When you have finished dubbing a tape

Press **■** on both your camcorder and the VCR.

If you have displayed the screen indicators on the TV

Make the indicators disappear by pressing SEARCH MODE on the Remote Commander, DISPLAY or DATA CODE so that they will not be superimposed on the edited tape.

You can edit on VCRs that support the following systems:

8 8 mm, **Hi8** Hi8, **VHS** VHS, **S-VHS** S-VHS, **VHS-C** VHS-C, **S-VHS-C** S-VHS-C, **B** Betamax, **ED Beta** ED Betamax, ^{Mini}**DV** mini DV, **DV** DV or **D** Digital8

If your VCR is a monaural type

Connect the yellow plug of the A/V connecting cable to the video input jack and the white or the red plug to the audio input jack on the VCR or the TV. When the white plug is connected, the left channel audio is output, and the red plug is connected, the right channel audio is output.

If your VCR has an S video jack

Connect using an S video cable (not supplied) to obtain high-quality pictures.

With this connection, you do not need to connect the yellow (video) plug of the A/V connecting cable.

Connect an S video cable (not supplied) to the S video jacks of both your camcorder and the VCR.

Dubbing a tape

Using the i.LINK cable (DV connecting cable)

Simply connect the i.LINK cable (DV connecting cable) (not supplied) to the DV IN/OUT and to DV IN/OUT of the DV products. With digital-to-digital connection, video and audio signals are transmitted in digital form for high-quality editing. You cannot dub the screen indicators.

- (1) Insert a blank tape (or a tape you want to record over) into the VCR, and insert the recorded tape into your camcorder.
- (2) Set the input selector on the VCR to DV IN if it is available. Refer to the operating instructions of your VCR for more information.
- (3) Set the POWER switch to VTR.
- (4) Play back the recorded tape on your camcorder.
- (5) Start recording on the VCR.

Refer to the operating instructions of your VCR for more information.

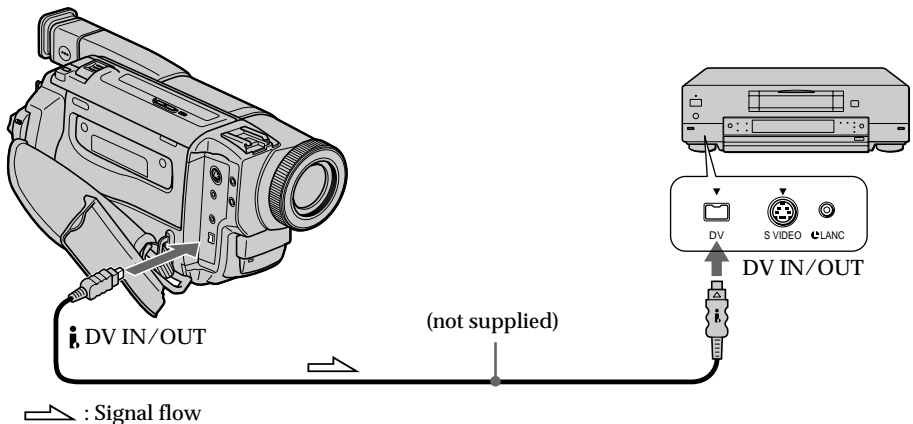

When you have finished dubbing a tape

Press **■** on both your camcorder and the VCR.

Note on tapes that are not recorded in the Digital8 **Ⓛ** system

The picture may fluctuate. This is not a malfunction.

During playback of tapes recorded in the Hi8/standard 8 system

Digital signals are output as the image signals from the DV IN/OUT jack.

You can connect one VCR only using the i.LINK cable (DV connecting cable).

See page 104 for more information about i.LINK.

During digital editing

You cannot use PICTURE EFFECT or DIGITAL EFFECT button function.

If you record playback pause picture via the DV IN/OUT jack

The recorded picture becomes rough. Also, when you play back the recorded pictures on other video equipment, the picture may jitter.

Using with analog video unit and PC - Signal convert function

You can capture images and sound from an analog video unit connected to a PC which has the i.LINK (DV) jack to your camcorder.

Analog video signals → Digital video signals

- (1) Set the POWER switch to VTR.
- (2) Set A/V → DV OUT to ON in the menu settings. (P. 64)
- (3) Start playback on the analog video unit.
- (4) Start capturing procedures on your PC.

The operation procedures depend on your PC and the software which you use. For details on how to capture images, refer to the instruction manual of PC and software.

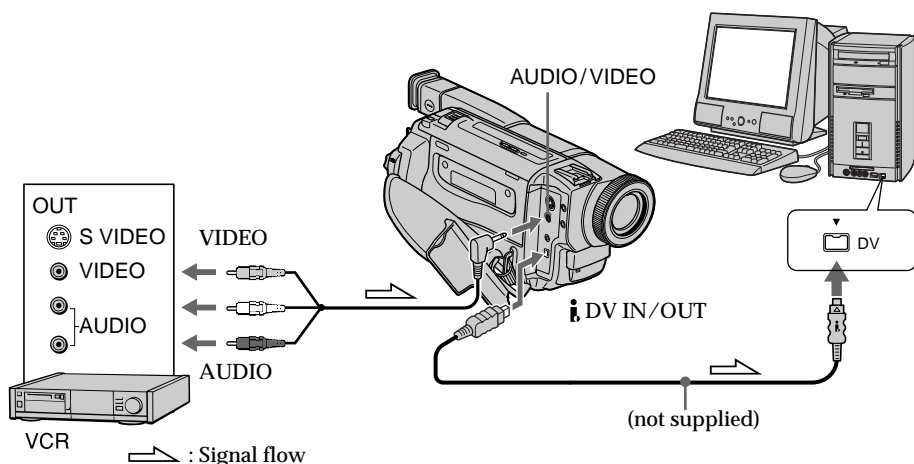

After capturing images and sound

Stop capturing procedures on your PC, and stop the playback on the analog video unit.

Notes

- You need to install software which can exchange video signals.
- Depending on the condition of the analog video signals, the PC may not be able to output the images correctly when you convert analog video signals into digital video signals via your camcorder. Depending on the analog video unit, the image may contain noise or incorrect colors.
- You cannot record or capture the video output via your camcorder when the video includes copyright protection signals such as ID - 2 system.

Recording video or TV programs

Using the A/V connecting cable

You can record a tape from another VCR or a TV program from a TV that has video/audio outputs. Use your camcorder as a recorder.

- (1) Insert a blank tape (or a tape you want to record over) into your camcorder. If you are recording a tape from the VCR, insert a recorded tape into the VCR.
- (2) Set the POWER switch to VTR.
- (3) Set DISPLAY to LCD in the menu settings (p. 64).
- (4) Press ● REC and the button on its right simultaneously on your camcorder, then immediately press || on your camcorder.
- (5) Press ► on the VCR to start playback if you are recording a tape from VCR. Select a TV program if you are recording from TV. The picture from a TV or VCR appears on the LCD screen or in the viewfinder.
- (6) Press || on your camcorder at the scene where you want to start recording from.

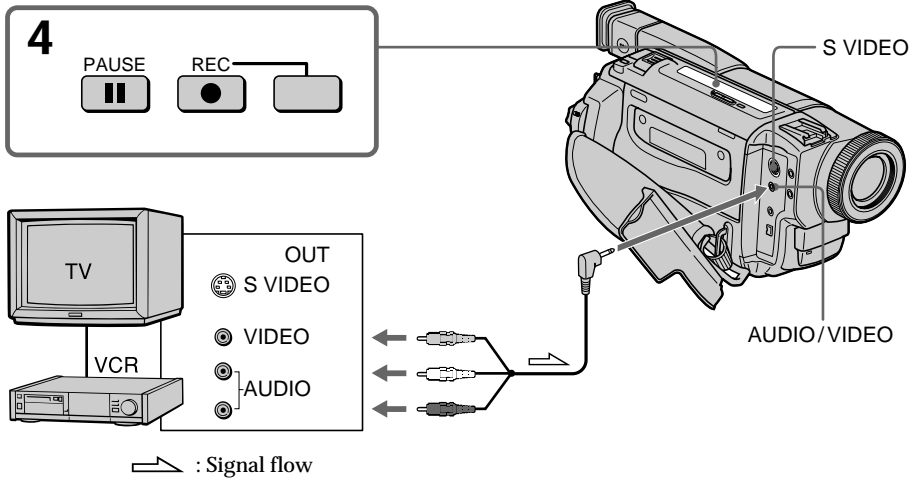

When you have finished dubbing a tape

Press ■ on both your camcorder and the VCR.

Notes

- To enable smooth transition, we recommend that you do not mix pictures recorded in the Hi8/standard 8 with the Digital8  system on a tape.
- If you fast-forward or slow-playback on the other equipment, the image being recorded may fluctuate. When recording from other equipment, be sure to play back the original tape at normal speed.

If your VCR is a monaural type

Connect the yellow plug of the A/V connecting cable to the video output jack and the white or the red plug to the audio output jack on the VCR or the TV. When the white plug is connected, the left channel audio is output, and the red plug is connected, the right channel audio is output.

If your TV or VCR has an S video jack

Connect using an S video cable (not supplied) to obtain high-quality pictures. With this connection, you do not need to connect the yellow (video) plug of the A/V connecting cable.

Connect an S video cable (not supplied) to the S video jacks of both your camcorder and the TV or VCR.

Recording video or TV programs

Using the i.LINK cable (DV connecting cable)

Simply connect the i.LINK cable (DV connecting cable) (not supplied) to **i** DV IN/OUT and to DV IN/OUT of the DV products. With digital-to-digital connection, video and audio signals are transmitted in digital form for high-quality editing.

- (1) Insert a blank tape (or a tape you want to record over) into your camcorder, and insert the recorded tape into the VCR.
- (2) Set the POWER switch to VTR.
- (3) Set DISPLAY to LCD in the menu settings (p. 64).
- (4) Press ● REC and the button on its right simultaneously on your camcorder, then immediately press || on your camcorder.
- (5) Press ► on the VCR to start playback.
The picture from a TV or VCR appears on the LCD screen or in the viewfinder.
- (6) Press || on your camcorder at the scene where you want to start recording from.

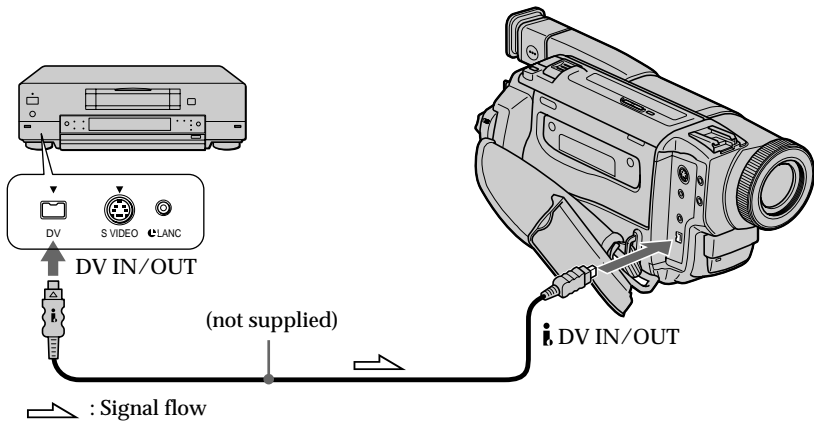

When you have finished dubbing a tape

Press ■ on both your camcorder and the VCR.

You can connect one VCR only using the i.LINK cable (DV connecting cable).

During digital editing

The color of the display may be uneven. However this does not affect the dubbed picture.

If you record playback pause picture with the **i** DV IN/OUT jack

The recorded picture becomes rough. And when you play back the picture using your camcorder, the picture may jitter.

Before recording

Make sure if the DV IN indicator appears on the LCD screen or in the viewfinder by pressing DISPLAY. The DV IN indicator may appear on both equipment.

Inserting a scene from a VCR

- Insert Editing

You can insert a new scene from a VCR onto your originally recorded tape by specifying the insert start and end points.

Use the Remote Commander for this operation.

Connections are the same as in "Recording video or TV programs" on page 60, 61.

Insert a cassette containing the desired scene to insert into the VCR.

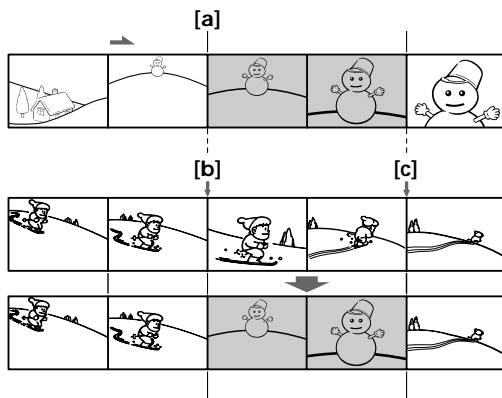

Inserting a scene from a VCR – Insert Editing

- (1) Set the POWER switch to VTR.
- (2) On the VCR, locate just before the insert start point [a], then press **II** to set the VCR to the playback pause mode.
- (3) On your camcorder, locate the insert end point [c] by pressing **◀** or **▶**. Then press **II** to set it to the playback pause mode.
- (4) Press ZERO SET MEMORY on the Remote Commander. The ZERO SET MEMORY indicator flashes and the end point of the insert is stored in memory.
- (5) On your camcorder, locate the insert start point [b] by pressing **◀**, then press
 - REC and the button on its right simultaneously to set your camcorder to the recording pause mode.
- (6) First press **II** on the VCR, and after a few seconds press **II** on your camcorder to start inserting the new scene.

Inserting automatically stops near the zero point on the counter. Your camcorder automatically stops. The end point [c] of the insert stored in memory is canceled.

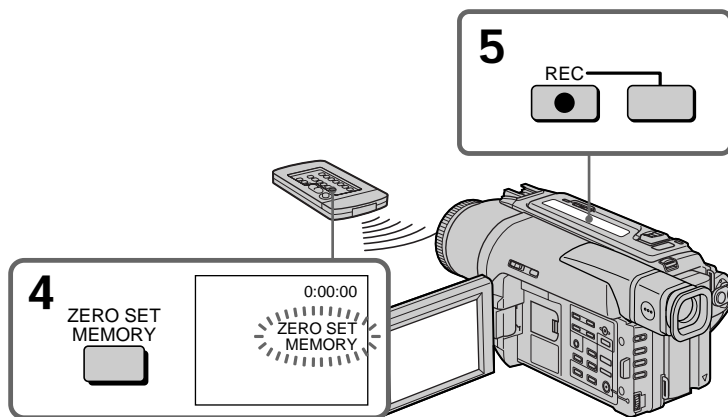

To change the insert end point

Press ZERO SET MEMORY again after step 5 to erase the ZERO SET MEMORY indicator and begin from step 3.

Notes

- The zero set memory function works only for tapes recorded in the Digital8 **8** system.
- The picture and sound recorded on the section between the insert start and end points will be erased when you insert the new scene.

When the inserted picture is played back

The picture may be distorted at the end of the inserted section. This is not a malfunction.

To insert a scene without setting the insert end point

Skip step 3 and 4. Press **■** when you want to stop inserting.

Changing the menu settings

To change the mode settings in the menu settings, select the menu items with the SEL/PUSH EXEC dial. The default settings can be partially changed. First, select the icon, then the menu item and then the mode.

- (1) In CAMERA, VTR or MEMORY mode, press MENU.
- (2) Turn the SEL/PUSH EXEC dial to select the desired icon, then press the dial to set.
- (3) Turn the SEL/PUSH EXEC dial to select the desired item, then press the dial to set.
- (4) Turn the SEL/PUSH EXEC dial to select the desired mode, and press the dial to set.
- (5) If you want to change other items, select ↻ RETURN and press the dial, then repeat steps from 2 to 4.

For details, see “Selecting the mode setting of each item” (p. 65).

1

CAMERA

MANUAL SET
 ◀ AUTO SHTR
 ◀ BEEP
 ◀ COMMANDER
 ◀ DISPLAY
 ◀ REC LAMP
 ◀ INDICATOR
 ↻ ETC
 ↻

[MENU]: END

VTR

VTR SET
 ◀ HI-FI SOUND
 ◀ TBC
 ◀ DNR
 ◀ AUDIO MIX
 ◀ PS MODE
 ◀ A/V → DV OUT
 ↻ ETC
 ↻

[MENU]: END

MEMORY

CAMERA SET
 ◀ D ZOOM
 ◀ STEADYSHOT
 ◀ N. S. LIGHT
 ↻ ETC
 ↻

[MENU]: END

2

↓

MANUAL SET

◀ AUTO SHTR

OTHERS

◀ WORLD TIME

◀ BEEP

◀ COMMANDER

◀ DISPLAY

◀ REC LAMP

◀ INDICATOR

↻ ETC
 ↻

3

↓

OTHERS

◀ WORLD TIME 0 HR

◀ BEEP

OTHERS

◀ WORLD TIME

◀ BEEP

◀ COMMANDER ON

◀ DISPLAY

◀ REC LAMP

◀ INDICATOR

↻ RETURN

↻ ETC
 ↻

MANUAL SET

◀ WORLD TIME

◀ BEEP

◀ COMMANDER ON

◀ DISPLAY OFF

◀ REC LAMP

◀ INDICATOR

↻ ETC
 ↻

4

↓

MANUAL SET

◀ WORLD TIME

◀ BEEP

◀ COMMANDER ON

◀ DISPLAY OFF

◀ REC LAMP

◀ INDICATOR

↻ RETURN

↻ ETC
 ↻

OTHERS

◀ WORLD TIME

◀ BEEP

◀ COMMANDER OFF

◀ DISPLAY

◀ REC LAMP

◀ INDICATOR









↻ RETURN

↻ ETC
 ↻

To make the menu display disappear
 Press MENU.



Changing the menu settings

Menu items are displayed as the following icons:

-  MANUAL SET
-  CAMERA SET
-  VTR SET
-  LCD/VF SET (DCR-TRV525)
- LCD SET (DCR-TRV520)
-  MEMORY SET
-  TAPE SET
-  SETUP MENU
-  OTHERS

Selecting the mode setting of each item ● is the default setting.

Menu items differ according to the position of the POWER switch.
The LCD screen and the viewfinder shows only the items you can operate at the moment.

Icon/item	Mode	Meaning	POWER switch
 AUTO SHTR	● ON	To automatically activate the electronic shutter when shooting in bright conditions	CAMERA
	OFF	To not automatically activate the electronic shutter even when shooting in bright conditions	
 D ZOOM	● OFF	To deactivate digital zoom. Up to 25× zoom is carried out.	CAMERA MEMORY
	50×	To activate digital zoom. More than 25× to 50× zoom is performed digitally. (p. 18)	
	450×	To activate digital zoom. More than 25× to 450× zoom is performed digitally. (p. 18)	
16:9WIDE	● OFF	—	CAMERA
	ON	To record a 16:9 wide picture (p. 32)	
STEADYSHOT	● ON	To compensate for camera-shake	CAMERA MEMORY
	OFF	To cancel the SteadyShot function. Natural pictures are produced when shooting a stationary object with a tripod.	
N.S. LIGHT	● ON	To use the NightShot Light function (p. 20)	CAMERA MEMORY
	OFF	To cancel the NightShot Light function	



Notes on the SteadyShot function

- The SteadyShot function will not correct excessive camera-shake.
- Attachment of a conversion lens (not supplied) may influence the SteadyShot function.

If you cancel the SteadyShot function

The SteadyShot off indicator  appears. Your camcorder prevents excessive compensation for camera-shake.

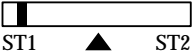
Changing the menu settings

Icon/item	Mode	Meaning	POWER switch
 HIFI SOUND	● STEREO	To play back a stereo tape or dual sound track tape with main and sub sound	VTR
	1	To play back a stereo tape with the left sound or a dual sound track tape with main sound	
	2	To play back a stereo tape with the right sound or a dual sound track tape with sub sound	
TBC*	● ON	To correct jitter	VTR
	OFF	To not correct jitter. Set TBC to OFF when playing back a tape on which you have dubbed over and recorded the signal of a TV game or similar machine.	
TBC stands for "Time Base Corrector".			
DNR*	● ON	To reduce picture noise	VTR
	OFF	To reduce a conspicuous afterimage when the picture has a lot of movement	
DNR stands for "Digital Noise Reduction".			
AUDIO MIX	—	To adjust the balance between the stereo 1 and stereo 2	VTR
			
PB MODE	● AUTO	To automatically select the system (Hi8/standard 8 or Digital8 ) that was used to record on the tape, and play back the tape	VTR
	Hi8/8	To play back a tape that was recorded in the Hi8/standard 8 system when your camcorder does not automatically distinguish the recording system	
A/V → DV OUT	● OFF	To convert digital video signals into analog video signals via your camcorder.	VTR
	ON	To convert analog video signals into digital video signals via your camcorder "A/V → DV" appears on the LCD screen or in the viewfinder. (P. 59)	

* When you play back tapes recorded in the Hi8/standard 8 system only.

Notes on AUDIO MIX

- When playing back a tape recorded in the 16-bit mode, you cannot adjust the balance.
- You can adjust the balance only for tapes recorded in the Digital8  system.

Note on PB MODE

The mode will return to the default setting when:

- you remove the battery pack or power source.
- you turn the POWER switch.

Changing the menu settings

Icon/item	Mode	Meaning	POWER switch
LCD B. L.	● BRT NORMAL	To set the brightness on the LCD screen normal	VTR CAMERA MEMORY
	BRIGHT	To brighten the LCD screen	
LCD COLOR	—	To adjust the color on the LCD screen, turning the SEL/PUSH EXEC dial to adjust the following bar 	VTR CAMERA MEMORY
		to lighten ← ▲ → to darken	
VF B.L.*	● BRT NORMAL	To set the brightness in the viewfinder normal	VTR CAMERA MEMORY
	BRIGHT	To brighten viewfinder	
CONTINUOUS	● OFF	Not to record continuously	MEMORY
	MULTI SCRΝ	To record 9 images continuously (p. 78)	
QUALITY	● FINE	To record still images in the fine image quality mode, using the “Memory Stick”	VTR MEMORY
	STANDARD	To record still images in the standard image quality mode, using the “Memory Stick”	
FLD./FRAME	● FIELD	To record moving subjects	MEMORY
	FRAME	To record stopping subjects in high quality	
PRINT MARK	● OFF	To cancel print marks on still images	VTR MEMORY
	ON	To write a print mark on the recorded still images you want to print out later	
PROTECT	● OFF	Not to protect still images	VTR MEMORY
	ON	To protect selected still images against accidental erasure (p. 97)	
SLIDE SHOW		To play back images in a continuous loop (p. 95)	MEMORY
DELETE ALL		To delete all the images (p. 99)	VTR MEMORY
FORMAT	● RETURN	To cancel formatting.	VTR MEMORY
	FORMAT	To format an inserted “Memory Stick.” 1. Select FORMAT with the SEL/PUSH EXEC dial, then press the dial. 2. Turn the SEL/PUSH EXEC dial to select FORMAT, then press the dial. 3. After EXECUTE appears, press the SEL/PUSH EXEC dial. FORMATTING appears during formatting. COMPLETE appears when formatting is finished.	
PHOTO SAVE		To duplicate still images (p. 87)	VTR

* DCR-TRV525 only

Notes on LCD B.L. and VF B.L.

- When you select BRIGHT, battery life is reduced by about 10 percent during recording.
- When you use power sources other than the battery pack, BRIGHT is automatically selected.

Notes on formatting



- Supplied or optional “Memory Stick”s have been formatted at factory. Formatting with this camcorder is not required.
- Do not turn the POWER switch or press any button while the display shows FORMATTING.
- You cannot format the “Memory Stick” if the write-protect tab on the “Memory Stick” is set to LOCK.
- Format again if the message  appears.

Formatting erases all information on the “Memory Stick”



Check the contents of the “Memory Stick” before formatting.

- Formatting erases sample images on the “Memory Stick.”
- Formatting erases the protected image data on the “Memory Stick.”

Changing the menu settings

Icon/item	Mode	Meaning	POWER switch
 REC MODE	● SP	To record in the SP (Standard Play) mode	VTR
	LP	To increase the recording time to 1.5 times the SP mode	CAMERA
AUDIO MODE	● 12BIT	To record or play back in the 12-bit mode (two stereo sounds)	VTR* CAMERA
	16BIT	To record or play back in the 16-bit mode (the one stereo sound with high quality)	
 REMAIN	● AUTO	To display the remaining tape bar: <ul style="list-style-type: none"> • for about 8 seconds after your camcorder is turned on and calculates the remaining amount of tape • for about 8 seconds after a cassette is inserted and your camcorder calculates the remaining amount of tape • for about 8 seconds after ► is pressed in VTR mode • for about 8 seconds after DISPLAY is pressed to display the screen indicators • for the period of tape rewinding, forwarding or picture search in the VTR mode 	VTR CAMERA
	ON	To always display the remaining tape bar	
DATA CODE	● DATE/CAM	To display date, time and recording data during playback	VTR
	DATE	To display date and time during playback	

Note on REC MODE

When you record on the standard 8  tape, your camcorder records in the SP mode even you select the LP mode in the menu settings. In this case, the indicator "8mm TAPE → SP REC, Hi8 TAPE → LP/SP REC" appears on the LCD screen or in the viewfinder. Use the Hi8  tapes for the LP mode.

Notes on the LP mode

- When you record a tape in the LP mode on your camcorder, we recommend playing the tape on your camcorder. When you play back the tape on other camcorders or VCRs, noise may occur in images or sound.
- When you record in the SP and LP modes on one tape or you record some scenes in the LP mode, the playback image may be distorted or the time code may not be written properly between scenes.

Note on AUDIO MODE

When playing back a tape recorded in the 16-bit mode, you cannot adjust the balance in AUDIO MIX.

*To dub a tape to another VCR

You cannot select AUDIO MODE for tapes recorded in the Digital8  system. You, however, can select AUDIO MODE when you dub tapes recorded in the Hi8/standard 8 system to another VCR using the i.LINK cable.

Changing the menu settings

Icon/item	Mode	Meaning	POWER switch
 CLOCK SET	—	To reset the date or time (p. 71)	CAMERA MEMORY
AUTO TV ON	● OFF	—	VTR CAMERA MEMORY
	ON	To automatically turn on the Sony TV when using the super laser link function	
TV INPUT	● VIDEO1 VIDEO2 VIDEO3	To switch the video input on a Sony TV when using the super laser link function (p. 28)	VTR CAMERA MEMORY
	OFF	—	
LTR SIZE	● NORMAL	To display selected menu items in normal size	VTR CAMERA MEMORY
	2×	To display selected menu items at twice the normal size	
DEMO MODE	● ON	To make the demonstration appear	CAMERA
	OFF	To cancel the demonstration mode	

Notes on DEMO MODE

- You cannot select DEMO MODE when a cassette is inserted in your camcorder.
- DEMO MODE is set to STBY (Standby) at the factory and the demonstration starts about 10 minutes after you have set the POWER switch to CAMERA without a cassette inserted.
To cancel the demonstration, insert a cassette, set the POWER switch to other than CAMERA, or set DEMO MODE to OFF.
- When NIGHTSHOT is set to ON, the “NIGHTSHOT” indicator appears on the LCD screen or in the viewfinder and you cannot select DEMO MODE in the menu settings.

Changing the menu settings

Icon/item	Mode	Meaning	POWER switch
 WORLD TIME	—	To set the clock to the local time. Turn the SEL/PUSH EXEC dial to set a time difference. The clock changes by the time difference you set here. If you set the time difference to 0, the clock returns to the originally set time.	CAMERA MEMORY
BEEP	● MELODY	To output the melody when you start/stop recording or when an unusual condition occurs on your camcorder	VTR CAMERA MEMORY
	NORMAL	To output the beep instead of the melody	
	OFF	To cancel all sound including shutter sound	
COMMANDER	● ON	To activate the Remote Commander supplied with your camcorder	VTR CAMERA MEMORY
	OFF	To deactivate the Remote Commander to avoid remote control misoperation caused by other VCR's remote control	
DISPLAY	● LCD	To show the display on the LCD screen and in the viewfinder	VTR CAMERA MEMORY
	V-OUT/LCD	To show the display on the TV screen, LCD screen and in the viewfinder	
REC LAMP	● ON	To light up the camera recording lamp at the front of your camcorder	CAMERA MEMORY
	OFF	To turn the camera recording lamp off so that the subject is not aware of the recording	
INDICATOR	● BL OFF	To turn off the backlight on display window	VTR CAMERA MEMORY
	BL ON	To turn on the backlight	

Note

If you press DISPLAY with DISPLAY set to V-OUT/LCD in the menu settings, the picture from a TV or VCR will not appear on the LCD screen even when your camcorder is connected to outputs on the TV or VCR. (Except when your camcorder is connected with the i. LINK cable)

In more than 5 minutes after removing the power source

The AUDIO MIX, COMMANDER and HiFi SOUND items are returned to their default settings.

The other menu items are held in memory even when the battery is removed, as long as the lithium battery is installed.

Notes on INDICATOR

- When you select BL ON, battery life is reduced by about 10 percent during recording.
- When you use power sources other than the battery pack, BL ON is automatically selected.

Resetting the date and time

The default clock setting is set to East Coast Standard Time.

The date and time are held in memory by the lithium battery. If you replace the lithium battery with the battery pack or other power source connected, you need not reset the date and time.

You must reset the date and time when the lithium battery becomes dead with no power source installed.

First, set the year, then the month, the day, the hour and then the minute.

- (1) While the camcorder is in the standby mode, press MENU to display the menu settings.
- (2) Turn the SEL/PUSH EXEC dial to select , then press the dial.
- (3) Turn the SEL/PUSH EXEC dial to select CLOCK SET, then press the dial.
- (4) Turn the SEL/PUSH EXEC dial to adjust the desired year, then press the dial.
- (5) Set the month, day and hour by turning the SEL/PUSH EXEC dial and pressing the dial.
- (6) Set the minute by turning the SEL/PUSH EXEC dial and pressing the dial by the time signal. The clock starts to move.
- (7) Press MENU to make the menu settings disappear.

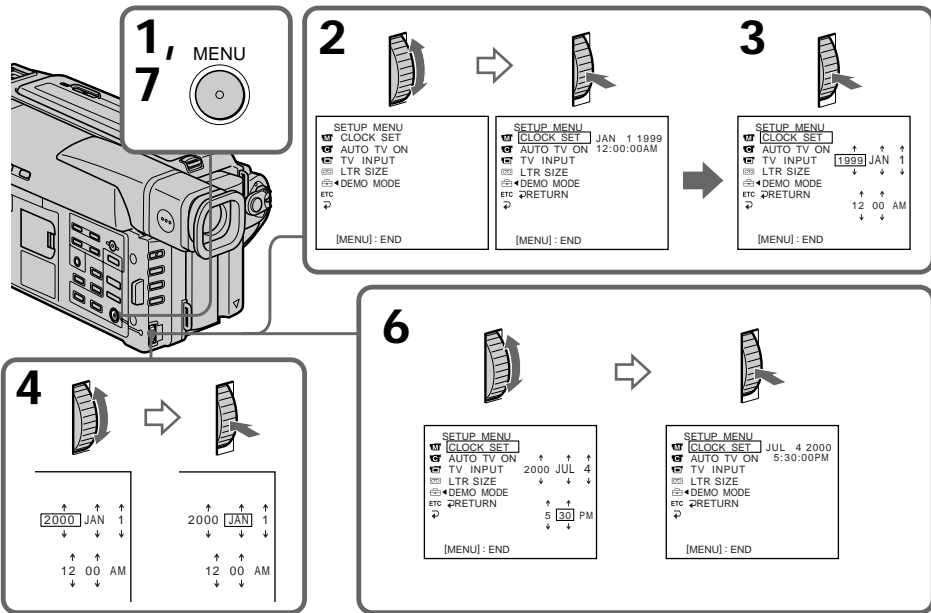

The year changes as follows:

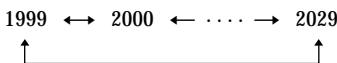

If you do not set the date and time

“-----” “--:--:--” is recorded on the tape and the “Memory Stick”.

Note on the time indicator

The internal clock of your camcorder operates on a 12-hour cycle.

- 12:00 AM stands for midnight.
- 12:00 PM stands for noon.

Using “Memory Stick”-introduction

You can record and play back still images on the “Memory Stick” supplied with your camcorder. You can easily play back, record or delete still images. You can exchange image data with other equipment such as a personal computer etc., using the serial port adaptor for “Memory Stick” (not supplied) or PC card adaptor for “Memory Stick” (not supplied).

On file format (JPEG)

Your camcorder compresses image data in JPEG format (extension .jpg).

Typical image data file name

100-0001: This file name appears on the LCD screen or in the viewfinder of your camcorder.

Dsc00001.jpg: This file name appears on the display of your personal computer.

Before using “Memory Stick”

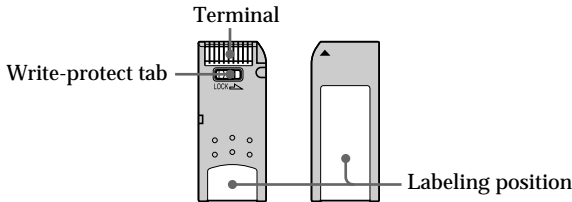

- You cannot record or erase still images when the write-protect tab on the “Memory Stick” is set to LOCK.
- We recommend backing up important data.
- Image data may be damaged in the following cases:
 - If you remove the “Memory Stick”, turn the power off, or detach the battery for replacement when the access lamp is flashing
 - If you use “Memory Stick”s near static electricity or magnetic fields.
- Prevent metallic objects or your finger from coming into contact with the metal parts of the connecting section.
- Stick its label on the labeling position.
- Do not bend, drop or apply strong shock to “Memory Stick”s.
- Do not disassemble or modify “Memory Stick”s.
- Do not let “Memory Stick”s get wet.
- Do not use or keep “Memory Stick”s in locations that are:
 - Extremely hot such as in a car parked in the sun or under the scorching sun
 - Under direct sunlight
 - Very humid or subject to corrosive gases
- When you carry or store a “Memory Stick”, put it in its case.

Formatting the supplied “Memory Stick”

Formatting with this camcorder is not required. The “Memory Stick” has been formatted in the FAT-format at factory.

“Memory Stick” supplied with your camcorder

- Sample images are recorded in the “Memory Stick” (p. 84). Note that these images will be deleted if you format the “Memory Stick.”
- Stick the supplied label on the labeling position to prevent the accidental erasure. As for the labeling position, see the illustration on the previous page.

“Memory Stick”’s formatted by a computer

“Memory Stick”’s formatted by Windows OS or Macintosh computers do not have a guaranteed compatibility with this camcorder.

Notes on image data compatibility

- Image data files recorded on “Memory Stick”’s by your camcorder conform with the Design Rules for Camera File Systems universal standard established by the JEIDA (Japan Electronic Industry Development Association). You cannot play back on your camcorder still images recorded on other equipment (DCR-TRV890E/TRV900/TRV900E or DSC-D700/D770) that does not conform with this universal standard. (These models are not sold in some areas.)
- If you cannot use the “Memory Stick” that has been used on other equipment, format the “Memory Stick” on your camcorder following the steps on page 67. Note that all images on the “Memory Stick” will be deleted if you format it.

“Memory Stick” and  are trademarks of Sony Corporation.

Using “Memory Stick”-introduction

Inserting “Memory Stick”

- (1) Open the lid of the cassette compartment.
- (2) Insert the “Memory Stick” with the ▲ mark facing toward the “Memory Stick” compartment as illustrated until it clicks.
- (3) Close the lid of the cassette compartment.

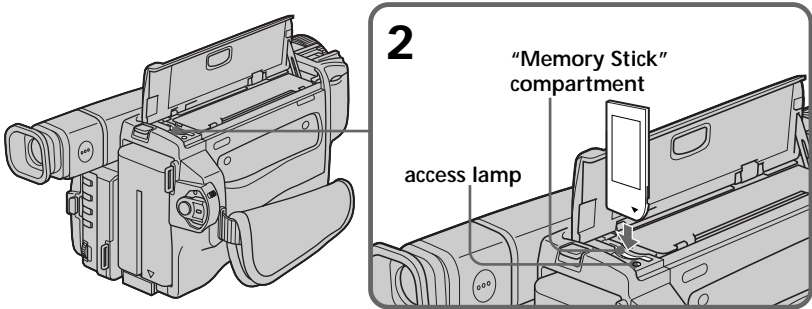

To eject the “Memory Stick”

Open the lid of the cassette compartment, then press the “Memory Stick” once lightly. The “Memory Stick” pops up.

When the access lamp is lit or flashing

Do not shake or strike your camcorder. Do not turn the power off, eject the “Memory Stick” or remove the battery pack. Otherwise, the image data breakdown may occur.

Using “Memory Stick”–introduction

Selecting image quality mode

You can select image quality mode in still image recording. Default setting is FINE.

- (1) Set the POWER switch to VTR or MEMORY. Make sure that the LOCK is set to the right (unlock) position.
- (2) Press MENU to make the menu display appear.
- (3) Turn the SEL/PUSH EXEC dial to select , then press the dial.
- (4) Turn the SEL/PUSH EXEC dial to select QUALITY, then press the dial.
- (5) Turn the SEL/PUSH EXEC dial to select the desired image quality, then press the dial.
- (6) Press MENU to erase the menu display.

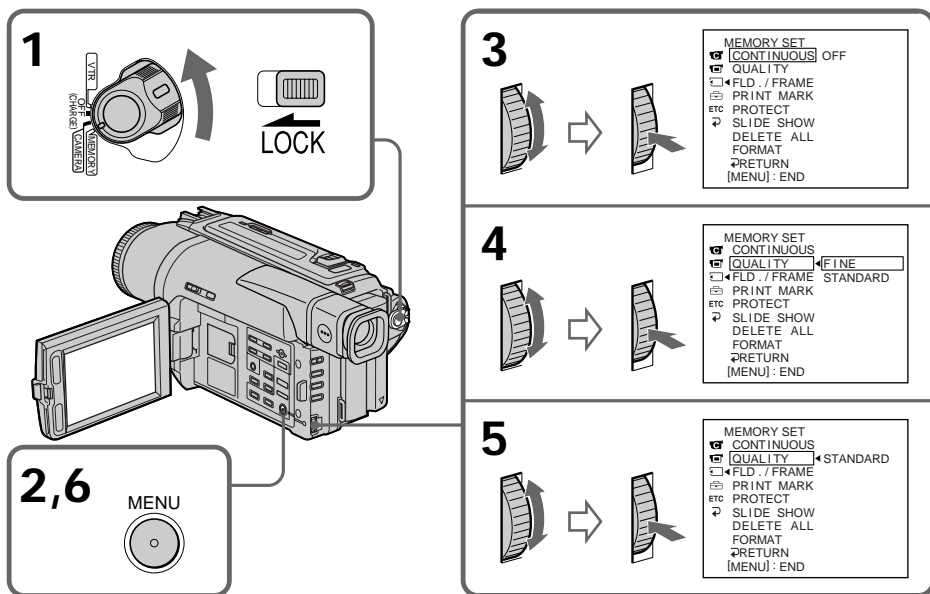

Note

In some cases, changing the image quality mode may not affect the image quality, depending on the types of images you are shooting.

Using “Memory Stick”–introduction

Image quality settings

Setting	Meaning
FINE (FINE)	Use this mode when you want to record high quality images. The image is compressed to about 1/6.
STANDARD (STD)	This is the standard image quality. The image is compressed to about 1/10.

Differences in image quality mode

Recorded images are compressed in JPEG format before being stored into memory. The memory capacity allotted to each image varies depending on the selected image quality mode. Details are shown in the table below. (The number of pixels is 640×480 , regardless of image quality mode. The data size before compression is about 600 KB.)

Image quality mode	Memory capacity
FINE	About 100 KB
STANDARD	About 60 KB

Approximate number of images you can record on a “Memory Stick”

The approximate number of images you can record on a “Memory Stick” formatted using this camcorder varies depending on which image quality mode you select and the complexity of the subject.

Maximum number of images you can record on a “Memory Stick”

Setting	4MB	8MB	16MB	32MB	64MB
FINE	40	81	164	329	659
STANDARD	60	122	246	494	988

Note on the image quality mode indicator

This is only displayed during recording.

Recording still images on “Memory Stick” – Memory Photo recording

You can select the FIELD or FRAME mode in still image recording. Your camcorder compensates for camera-shake when recording moving subjects in the FIELD mode. Your camcorder records still images in high quality in the FRAME mode. Select the FIELD or FRAME in the menu settings (p. 64).

Before operation

Insert a “Memory Stick” into your camcorder.

- (1) Set the POWER switch to MEMORY. Make sure that the LOCK is set to the right (unlock) position.
- (2) Keep pressing PHOTO lightly. The green ● mark stops flashing, then lights up. The brightness of the image and focus are adjusted, being targeted for the middle of the image and are fixed. Recording does not start yet.
- (3) Press PHOTO deeper. The image displayed on the screen will be recorded on the “Memory Stick”. Recording is complete when the bar scroll indicator disappears.

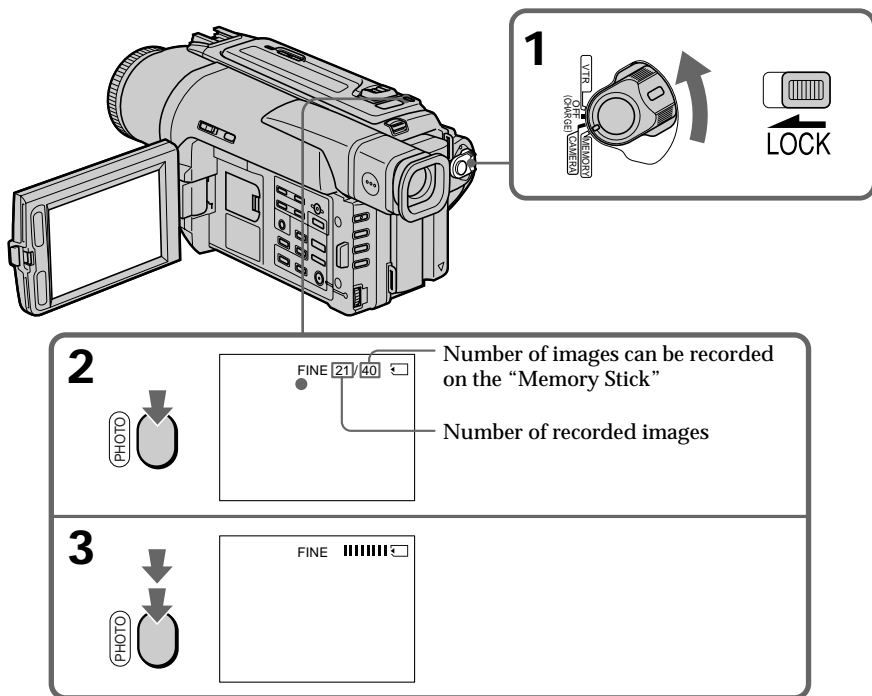

“Memory Stick” operations

Notes

- When recording fast-moving subjects in the FRAME mode, the recorded image blurry.
- When recording in the FRAME mode, your camcorder may not correct camera-shake. We recommend that you shoot objects with a tripod.
- When recording still images at step 2 with the PHOTO button pressed lightly, the image momentarily flickers. This is not a malfunction.
- Before you shoot in autofocus mode, check that the subject is in sharp focus.
- The brightness of the picture and focus are adjusted on the center portion of the image.

Recording still images on “Memory Stick” - Memory Photo recording

When the POWER switch is set to MEMORY

The following functions do not work:

wide mode, digital effect, picture effect, title, low lux mode of PROGRAM AE.

When you are recording a still image

You can neither turn off the power nor press PHOTO.

When you press the PHOTO button on the Remote Commander

Your camcorder immediately records the image that is on the screen when you press the button.

Recording images continuously

You can record still images continuously.

Multi screen mode

You can record 9 still images continuously on a single page.



Recording still images on “Memory Stick” - Memory Photo recording

- (1) Set the POWER switch to MEMORY. Make sure that the LOCK is set to the right (unlock) position.
- (2) Press MENU to make the menu display appear.
- (3) Turn the SEL/PUSH EXEC dial to select , then press the dial.
- (4) Turn the SEL/PUSH EXEC dial to select CONTINUOUS, then press the dial.
- (5) Turn the SEL/PUSH EXEC dial to select the desired setting, then press the dial.
- (6) Press MENU to erase the menu display.

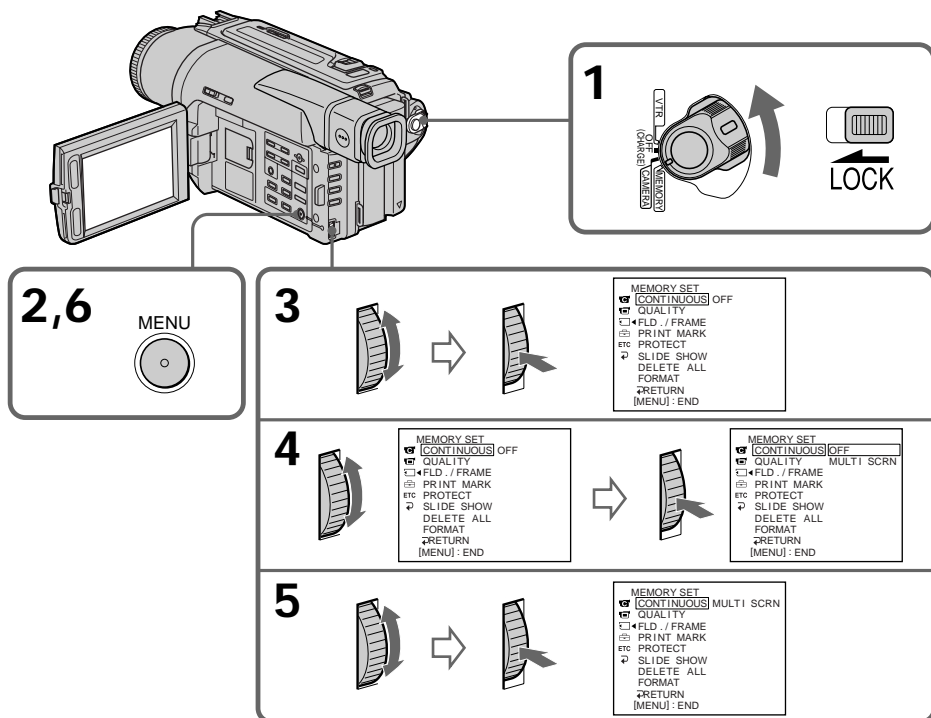

“Memory Stick” operations

If the capacity of the “Memory Stick” becomes full

“FULL” appears on the LCD screen or in the viewfinder, and you cannot record still images on the “Memory Stick”

Recording still images on “Memory Stick” - Memory Photo recording

Continuous shooting settings

Setting	Meaning (indicator on the screen)
OFF	Your camcorder shoots one image at a time. (no indicator)
MULTI SCRN	Your camcorder shoots 9 still images at about 0.3 sec intervals and displays the images on a single page divided into 9 boxes. ()



Note on using the video flash light (not supplied)

The video flash light does not work in the multi screen mode if you install it to the accessory shoe.

Recording still images on “Memory Stick” – Memory Photo recording

Self-timer memory photo recording

You can record still images on “Memory Stick”s with the self-timer. This mode is useful when you want to record yourself. You can use the Remote Commander for this operation.

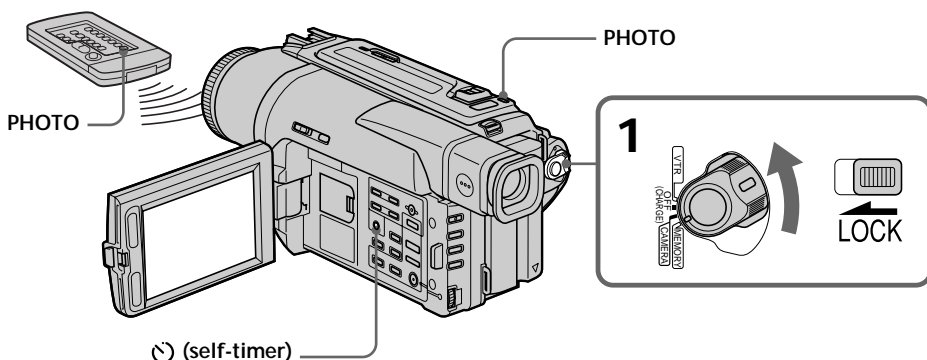

- (1) Set the POWER switch to MEMORY. Make sure that the LOCK is set to the right (unlock) position.
- (2) Press  (self-timer). The  (self-timer) indicator appears on the LCD screen or in the viewfinder.
- (3) Press PHOTO firmly.

Self-timer starts counting down from 10 with a beep sound. In the last two seconds of the countdown, the beep sound gets faster, then recording starts automatically.



“Memory Stick” operations

To cancel self-timer recording

Press  (self-timer) so that the  indicator disappears from the LCD or viewfinder screen while your camcorder is in the standby mode. You cannot cancel self-timer recording with Remote Commander.

Note

The self-timer recording mode is automatically cancelled when:

- Self-timer recording is finished.
- The POWER switch is set to OFF (CHARGE) or VTR.

Superimposing a still image in the “Memory Stick” on a moving image

- MEMORY MIX

You can superimpose a still image you have recorded on the “Memory Stick” on top of the moving image you are recording.

M. CHROM (Memory chroma key)

You can swap a blue area of a still image such as an illustration or a frame with a moving image.

M. LUMI (Memory luminance key)

You can swap a brighter area of a still image such as a handwritten illustration or title with a moving image. Record a title on the “Memory Stick” before a trip or event for convenience.

C. CHROM (Camera chroma key)

You can superimpose a moving image on top of a still image such as an image can be used as background. Shoot the subject against a blue background. The blue area of the moving image will be swapped with a still image.

M. OVERLAP (Memory overlap)

You can make a moving image fade in on top of a still image.

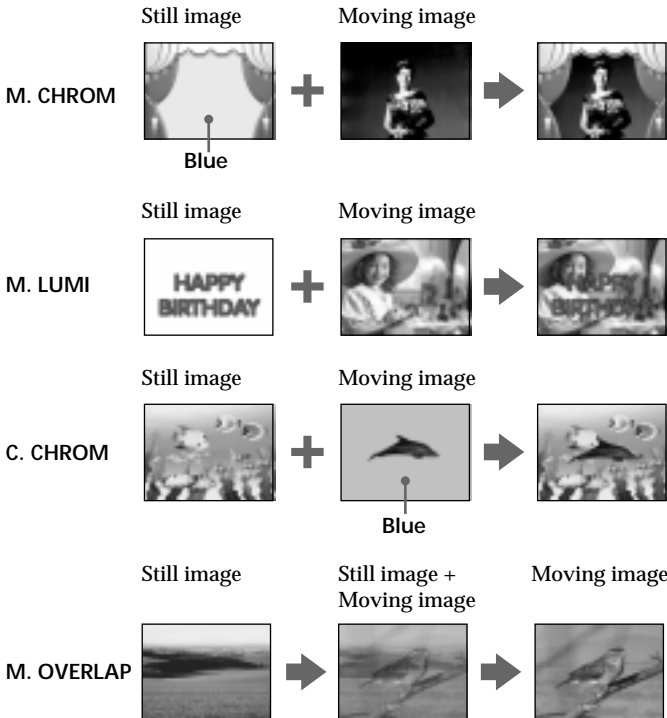

Superimposing a still image in the "Memory Stick" on a moving image - MEMORY MIX

Before operation

Insert a Hi8 **Hi8**/Digital8 **D** tape for recording and a "Memory Stick" into your camcorder.

- (1) Set the POWER switch to CAMERA.
 - (2) Press MEMORY MIX in the standby mode.
The last recorded or last composed image appears on the lower part of the screen as a thumbnail image.
 - (3) Press MEMORY+/- to select the still image you want to superimpose.
To see the previous image, press MEMORY-. To see the next image, press MEMORY+.
 - (4) Turn the SEL/PUSH EXEC dial to select the desired mode.
The mode changes as follows:
M. CHROM ↔ M. LUMI ↔ C. CHROM ↔ M. OVERLAP
 - (5) Press the SEL/PUSH EXEC dial.
The still image is superimposed on the moving image.
 - (6) Turn the SEL/PUSH EXEC dial to adjust the effect.
M. CHROM - The color (blue) scheme of the area in the still image which is to be swapped with a moving image
M. LUMI - The color (bright) scheme of the area in the still image which is to be swapped with a moving image
C. CHROM - The color (blue) scheme of the area in the moving image which is to be swapped with a still image
M. OVERLAP - No adjustment necessary
- The fewer bars there are on the screen, the stronger the effect.
- (7) Press START/STOP to start recording.

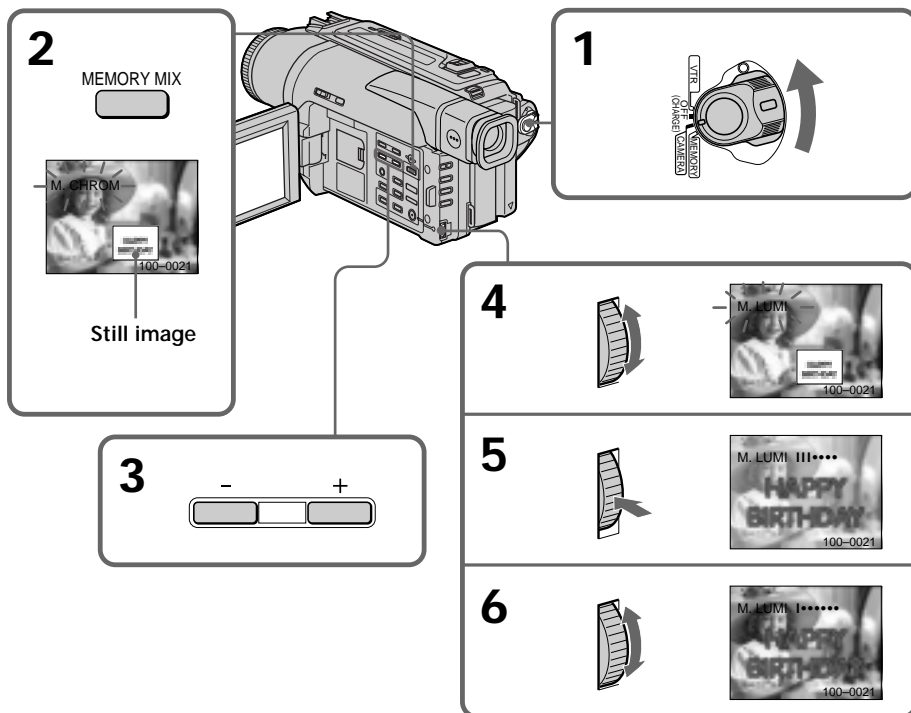

Superimposing a still image in the “Memory Stick” on a moving image – MEMORY MIX

To change the still image to superimpose

Do either of the following:

- Press MEMORY+/- before step 7.
- Press the SEL/PUSH EXEC dial before step 7, and repeat the procedure from step 4.

To change the mode setting

Press the SEL/PUSH EXEC dial before step 7, and repeat the procedure from step 4.

To cancel M. CHROM/M. LUMI/C. CHROM/M.OVERLAP

Press MEMORY MIX.

During recording

You cannot change the mode setting.

The “Memory Stick” supplied with your camcorder stores 20 images

- For M. CHROM: 18 images (such as a frame) 100-0001~100-0018
- For C. CHROM: 2 images (such as a background) 100-0019~100-0020

Sample images

Sample images stored in the “Memory Stick” supplied with your camcorder are protected (p. 97).

When you select M.OVERLAP

You cannot change the still image or the mode setting.

Recording an image from a tape as a still image

Your camcorder can read moving image data recorded on a tape in the Digital8  system, and record it as a still image on a “Memory Stick.”

Your camcorder can also take in moving image data through the input connector and record it as a still image on a “Memory Stick.”

Before operation

Insert a tape recorded in the Digital8  system and a “Memory Stick” into your camcorder.

- (1) Set the POWER switch to VTR.
- (2) Press . The image recorded on the tape is played back.
- (3) Keep pressing PHOTO lightly until the image from the tape freezes. CAPTURE appears on the LCD screen or in the viewfinder. Recording does not start yet.
- (4) Press PHOTO deeper. The image displayed on the screen will be recorded on the “Memory Stick”. Recording is complete when the bar scroll indicator disappears.

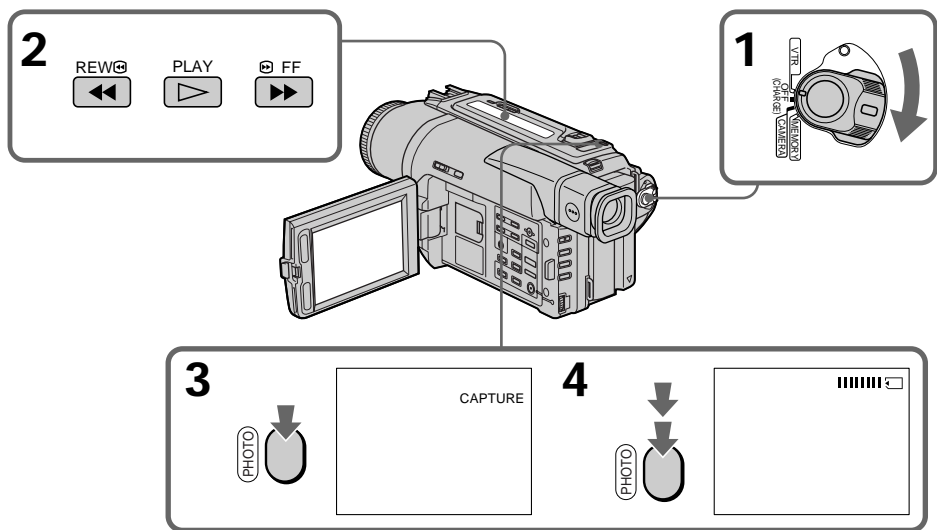

“Memory Stick” operations

When the access lamp is lit or flashing

Never shake or strike the unit. Also do not turn the power off, eject the “Memory Stick” or remove the battery pack. Otherwise, an image data breakdown may occur.

If appears on the LCD screen or in the viewfinder

The inserted “Memory Stick” is incompatible with your camcorder because its format does not conform with your camcorder. Check the format of the “Memory Stick”.

If you press PHOTO lightly in the playback mode

Your camcorder stops momentarily.

Sound recorded on a tape

You cannot record the audio from a tape.

Titles superimposed on tapes

You cannot record the titles on the “Memory Stick.” However, you can record titles which have already been recorded on tapes.

When you press PHOTO on the Remote Commander

Your camcorder immediately records the image that is on the screen when you press the button.

Recording an image from a tape as a still image

Recording a still image from other equipment

- (1) Set the POWER switch to VTR and set DISPLAY to LCD in the menu settings.
- (2) Play back the recorded tape, or turn the TV on to see the desired program.
The image from TV or VCR appears on the LCD or in the viewfinder.
- (3) Follow the steps 3 and 4 on page 85.

Using the A/V connecting cable

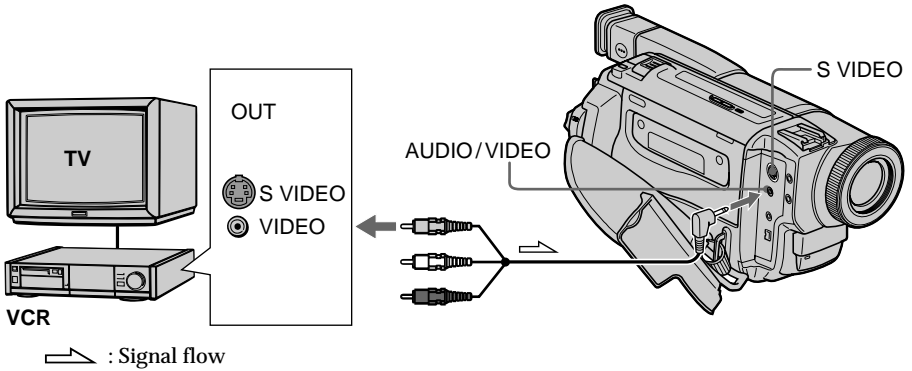

Connect the yellow plug of the A/V connecting cable to the video jack on the VCR or the TV.

If your TV or VCR has an S video jack

Connect using an S video cable (not supplied) to obtain high-quality pictures.

With this connection, you do not need to connect the yellow (video) plug of the A/V connecting cable.

Connect an S video cable (not supplied) to the S video jacks of both your camcorder and the TV or VCR.

Using the i.LINK cable (the DV connecting cable)

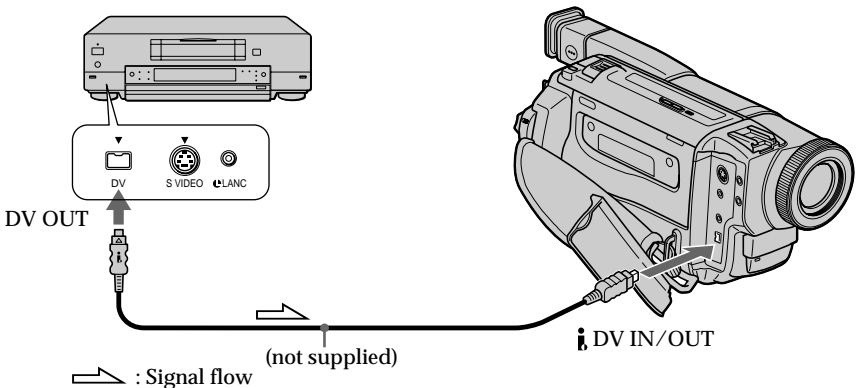



Copying still images from a tape

- Photo save

Using the search function, you can automatically take in only still images from tapes recorded in the Digital8  system and record them on a "Memory Stick" in sequence.

Before operation

- Insert a tape recorded in the Digital8  system and rewind the tape.
- Insert a "Memory Stick" into your camcorder.

- (1) Set the POWER switch to VTR.
- (2) Press MENU to make the menu display appear.
- (3) Turn the SEL/PUSH EXEC dial to select , then press the dial.
- (4) Turn the SEL/PUSH EXEC dial to select PHOTO SAVE, then press the dial. PHOTO BUTTON appears on the LCD screen or in the viewfinder.
- (5) Press PHOTO firmly. The still image from the tape is recorded on the "Memory Stick". The number of still images copied is displayed. END is displayed when copying is completed.

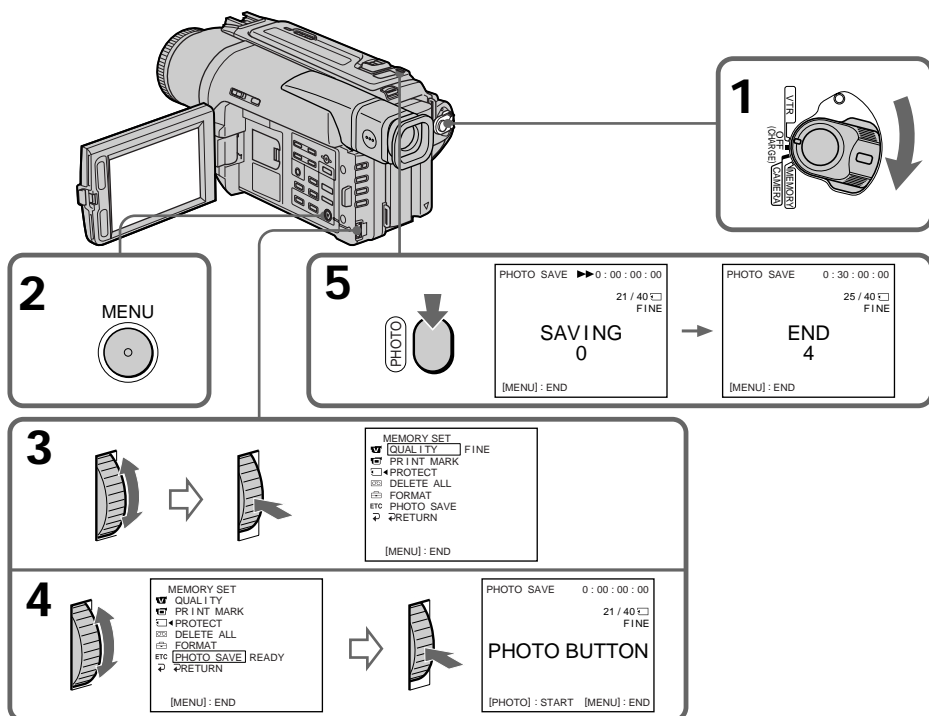

"Memory Stick" operations

Copying still images from a tape – Photo save

To stop copying

Press MENU to stop copying.

When the memory of the “Memory Stick” is full

MEMORY FULL appears on the LCD screen, and the copying stops. Insert another “Memory Stick” and repeat the procedure from step 2.

When the access lamp is lit or flashing

Never shake or strike your camcorder. As well do not turn the power off, eject the “Memory Stick” or remove the battery pack. Otherwise, the image data breakdown may occur.

To record all the images recorded on the tape

Rewind the tape all the way back and start copying.

If the write-protect tab on the “Memory Stick” is set to LOCK

NOT READY appears when you select PHOTO SAVE in the menu settings.

When you change the “Memory Stick” in the middle of copying

Your camcorder resumes copying from the last image recorded on the previous “Memory Stick”.

Viewing a still image – Memory Photo playback

You can play back still images recorded on a “Memory Stick”. You can also play back 6 images at a time by selecting the index screen.

Before operation

Insert a “Memory Stick” into your camcorder.

- (1) Set the POWER switch to MEMORY or VTR. Make sure that the LOCK is set to the right (unlock) position.
- (2) Open the LCD panel while pressing OPEN.
- (3) Press MEMORY PLAY. The last recorded image is displayed.
- (4) Press MEMORY +/– to select the desired still image. To see the previous image, press MEMORY –. To see the next image, press MEMORY +.

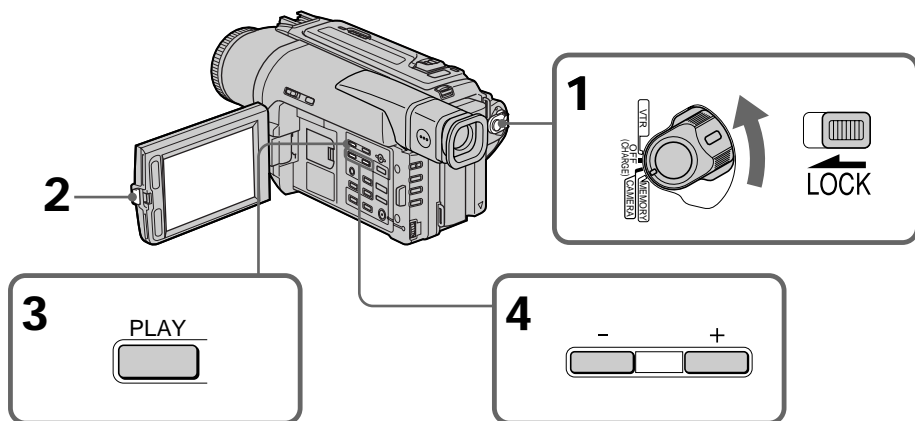

“Memory Stick” operations

To stop memory photo playback

Press MEMORY PLAY.

To play back recorded images on a TV screen

- Connect your camcorder to the TV with the A/V connecting cable supplied with your camcorder before the operation.
- When operating memory photo playback on a TV or the LCD screen, the image quality may appear to have deteriorated. This is not a malfunction. The image data is as good as ever.
- Turn the audio volume of the TV down before operation, or noise (howling) may be output from the TV speakers.

If “ NO FILE” appears on the LCD screen or in the viewfinder

No image is recorded on the “Memory Stick.”

Image data modified with personal computers or shot with other equipment

You may not be able to play them back with your camcorder.

Viewing a still image – Memory Photo playback

Screen indicators during still image playback

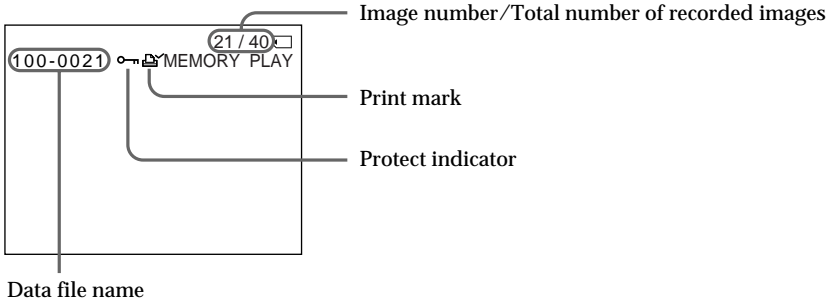

Playing back 6 recorded images at a time (index screen)

You can play back 6 recorded images at a time. This function is especially useful when searching for a particular image.

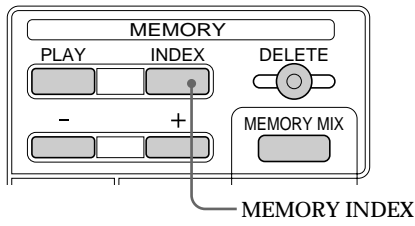

Press MEMORY INDEX.
A red ► mark appears above the image that is displayed before changing to the index screen mode.

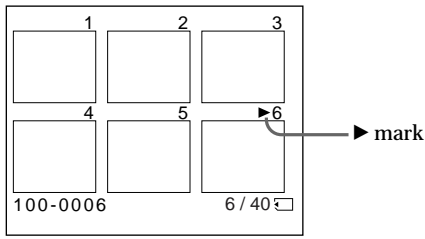

- To display the following 6 images, keep pressing MEMORY +.
- To display the previous 6 images, keep pressing MEMORY -.

To return to the normal playback screen (single screen)

Press MEMORY +/- to move the ► mark to the image you want to display on full screen, then press MEMORY PLAY.

Viewing a still image – Memory Photo playback

Note

When displaying the index screen, the number appears above each image. This indicates the order in which images are recorded on the “Memory Stick”. These numbers are different from the data file names.

Files modified with personal computers

These files may not be displayed on the index screen. Image files shot with other equipment may not be displayed on the index screen either.

Viewing the recorded images using a personal computer

The image data recorded with your camcorder is compressed in the JPEG format. If you use the application software, PictureGear 4.1Lite supplied with your camcorder, you can see images recorded on the “Memory Stick” on a computer screen. Use the PC serial cable supplied with your camcorder for this operation.

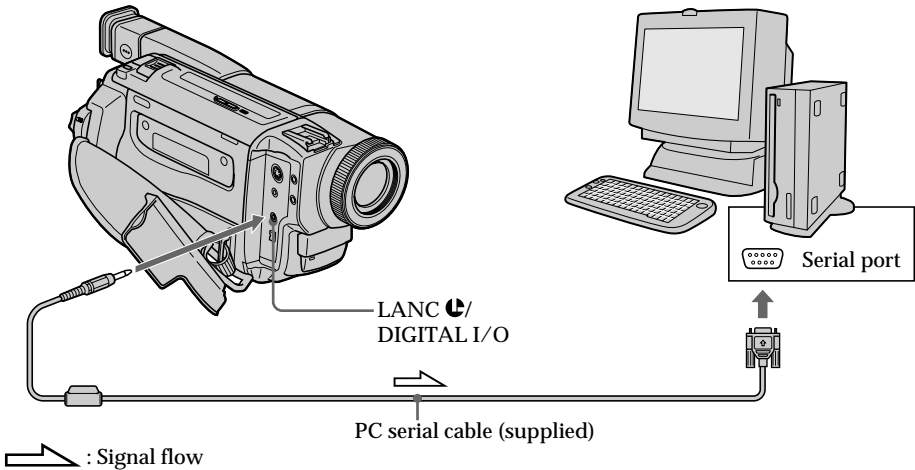

“Memory Stick” operations

Copying the image recorded on "Memory Stick" to tapes

You can copy still images or titles recorded on "Memory Stick"s and record them to Hi8 Hi8/Digital8 tapes.

Before operation

Insert a Hi8 Hi8/Digital8 tape for recording and a "Memory Stick" into your camcorder.

- (1) Set the POWER switch to VTR.
- (2) Using the video control buttons, search a point where you want to record the desired still image. Set the Hi8 Hi8/Digital8 tape to playback pause mode.
- (3) Press ● REC and the button on its right simultaneously on your camcorder. The Hi8 Hi8/Digital8 tape is set to the recording pause mode.
- (4) Press MEMORY PLAY to play back the still image you want to copy (p. 89).
- (5) Press ■ to start recording and press ■ again to stop.
- (6) If you have more to copy, repeat steps 4 and 5.

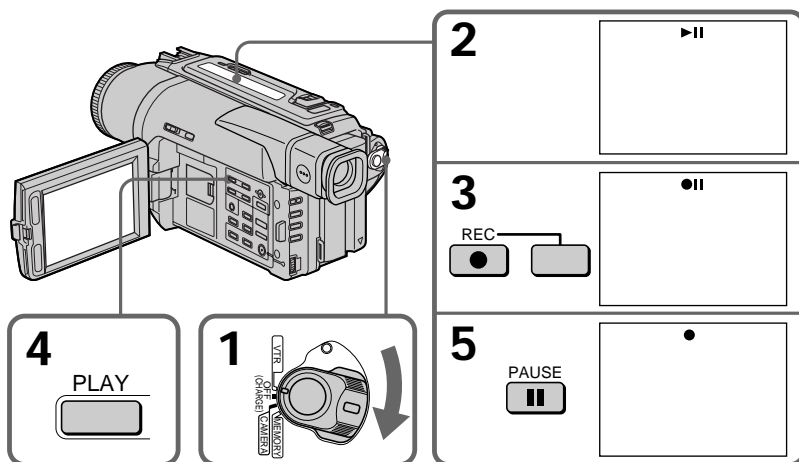

To stop copying in the middle

Press ■.

Copying the image recorded on “Memory Stick” to tapes

During copying

You cannot operate the following buttons:

MEMORY PLAY, MEMORY INDEX, MEMORY DELETE, MEMORY MIX, MEMORY +, and MEMORY –.

Note on the index screen

You cannot record the index screen.



If you press the EDITSEARCH buttons during pause mode

Memory playback stops.

Image data modified with personal computers or shot with other equipment

You may not be able to copy them with your camcorder.

If you press the DISPLAY button in the standby or recording mode

You can see memory playback and the file name indicators in addition to the indicators pertinent to Hi8 /Digital8  tapes, such as the time code indicator.

When copying

You cannot copy the image recorded on “Memory Stick” with titles to tapes.

Enlarging still images recorded on "Memory Stick"s – Memory PB ZOOM

You can enlarge still images recorded on a "Memory Stick."

Before operation

Insert a "Memory Stick" into your camcorder.

- (1) Set the POWER switch to MEMORY or VTR. Make sure that the Lock is set to the right (unlock) position.
- (2) Press PB ZOOM on your camcorder while you are playing back images recorded on "Memory Stick." The still image is enlarged, and $\uparrow\downarrow$ appears on the LCD screen or in the viewfinder.
- (3) Turn SEL/PUSH EXEC dial to move the enlarged image, then press the dial.
 - \uparrow : The image moves downward.
 - \downarrow : The image moves upward.
 - $\leftarrow\rightarrow$ becomes available.
- (4) Turn SEL/PUSH EXEC dial to move the enlarged image, then press the dial.
 - \leftarrow : The image moves rightward. (Turn the dial downward.)
 - \rightarrow : The image moves leftward. (Turn the dial upward.)

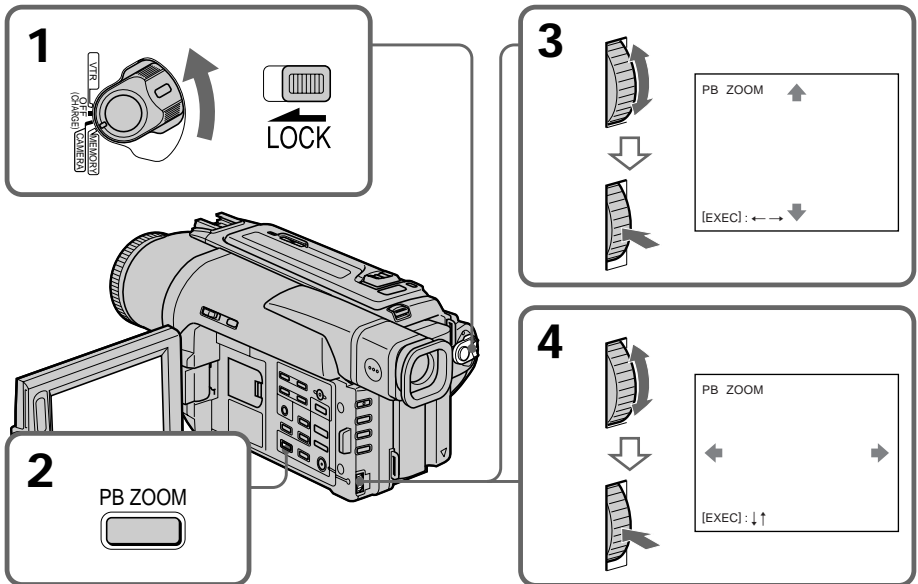

To cancel memory PB ZOOM function

Press PB ZOOM.

Pictures processed by PB ZOOM function

Pictures processed by PB ZOOM function are not output through the \mathbb{I} DV IN/OUT jack.

Playing back images in a continuous loop – SLIDE SHOW

You can automatically play back images in sequence. This function is useful especially when checking recorded images or during a presentation.

Before operation

Insert a “Memory Stick” into your camcorder.

- (1) Set the POWER switch to MEMORY. Make sure that the LOCK is set to the right (unlock) position.
- (2) Press MENU to make the menu display appear.
- (3) Turn the SEL/PUSH EXEC dial to select , then press the dial.
- (4) Turn the SEL/PUSH EXEC dial to select SLIDE SHOW, then press the dial.
- (5) Press MEMORY PLAY. Your camcorder plays back the images recorded on the “Memory Stick” in sequence.

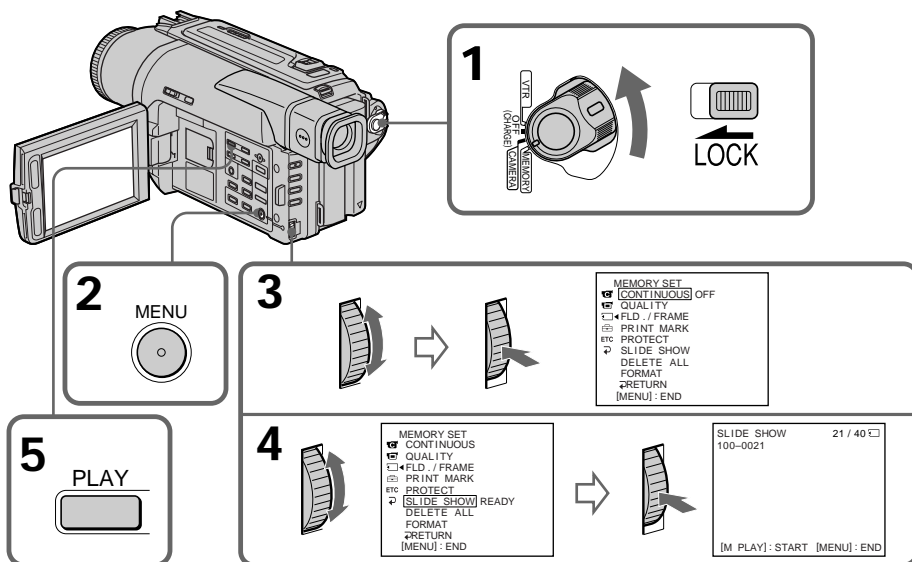

“Memory Stick” operations

To stop the slide show

Press MENU.

To pause during a slide show

Press MEMORY PLAY.

To start the slide show from a particular image

Select the desired image using MEMORY +/- buttons before step 2.

Playing back images in a continuous loop – SLIDE SHOW

To view the recorded images on TV

Connect your camcorder to a TV with the A/V connecting cable supplied with your camcorder before operation.

If you change the “Memory Stick” during operation



The slide show does not operate. If you change the “Memory Stick”, be sure to follow the steps again from the beginning.

Preventing accidental erasure – Image protection

To prevent accidental erasure of important images, you can protect selected images.

Before operation

Insert a “Memory Stick” into your camcorder.

- (1) Set the POWER switch to MEMORY or VTR. Make sure that the LOCK is set to the right (unlock) position.
- (2) Play back the image you want to protect (p. 89).
- (3) Press MENU to make the menu display appear.
- (4) Turn the SEL/PUSH EXEC dial to select , then press the dial.
- (5) Turn the SEL/PUSH EXEC dial to select PROTECT, then press the dial.
- (6) Turn the SEL/PUSH EXEC dial to select ON, then press the dial.
- (7) Press MENU to erase the menu display. The  mark is displayed beside the data file name of the protected image.

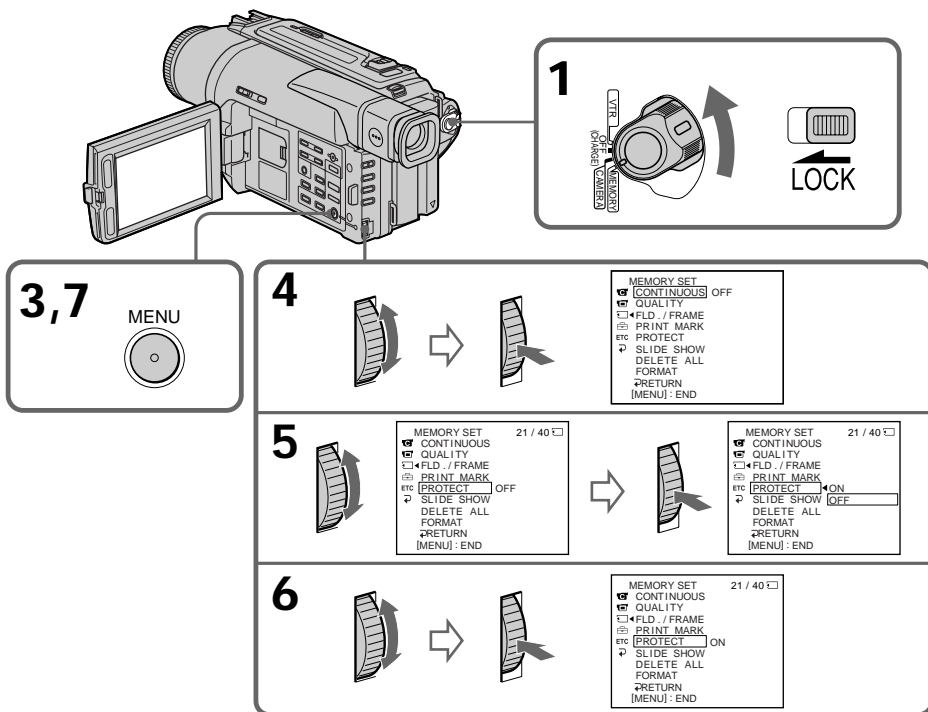

“Memory Stick” operations

To cancel image protection

Select OFF in step 6, then press the SEL/PUSH EXEC dial.

Note

Formatting erases all information on the “Memory Stick”, including the protected image data. Check the contents of the “Memory Stick” before formatting.

If the write-protect tab on the “Memory Stick” is set to LOCK
You cannot carry out image protection.

Deleting images

You can delete images stored in a “Memory Stick.”

Before operation

Insert a “Memory Stick” into your camcorder.

Deleting selected images

- (1) Set the POWER switch to MEMORY or VTR. Make sure that the LOCK is set to the right (unlock) position.
- (2) Play back the image you want to delete (p. 89).
- (3) Press MEMORY DELETE. “DELETE?” appears on the LCD screen.
- (4) Press MEMORY DELETE again. The selected image is deleted.

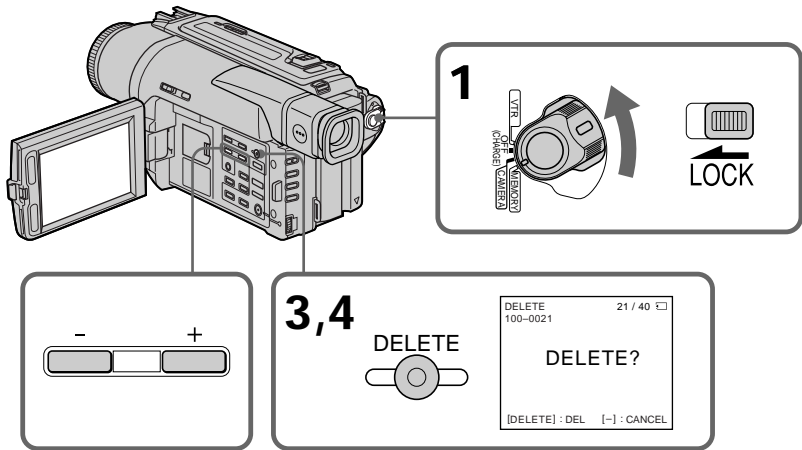

To cancel deleting an image

Press MEMORY - in step 4.

To delete an image displayed on the index screen

Press MEMORY +/- to move the ► indicator to the desired image and follow steps 3 and 4.

Notes

- To delete a protected image, first cancel image protection.
- Once you delete an image, you cannot restore it. Check the images to delete carefully before deleting them.

Deleting images

Deleting all the images

You can delete all the unprotected images in the “Memory Stick”.

- (1) Set the POWER switch to MEMORY or VTR. Make sure that the LOCK is set to the right (unlock) position.
- (2) Press MENU to make the menu display appear.
- (3) Turn the SEL/PUSH EXEC dial to select , then press the dial.
- (4) Turn the SEL/PUSH EXEC dial to select DELETE ALL, then press the dial.
- (5) Turn the SEL/PUSH EXEC dial to select OK, then press the dial. OK changes to EXECUTE.
- (6) Turn the SEL/PUSH EXEC dial to select EXECUTE, then press the dial. DELETING appears on the LCD screen. When all the unprotected images are deleted, COMPLETE is displayed.

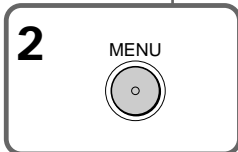
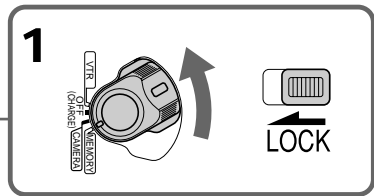
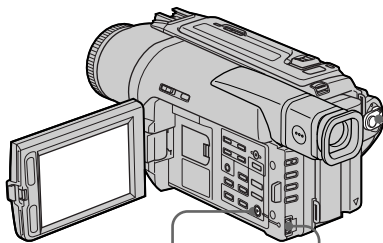

3		<p>MEMORY SET</p> <ul style="list-style-type: none"> <input checked="" type="checkbox"/> CONTINUOUS OFF <input checked="" type="checkbox"/> QUALITY <input type="checkbox"/> FLD./FRAME <input type="checkbox"/> PRINT MARK etc PROTECT <input type="checkbox"/> SLIDE SHOW DELETE ALL FORMAT <input type="checkbox"/> RETURN [MENU]: END
4		<p>MEMORY SET</p> <ul style="list-style-type: none"> <input checked="" type="checkbox"/> CONTINUOUS <input checked="" type="checkbox"/> QUALITY <input type="checkbox"/> FLD./FRAME <input type="checkbox"/> PRINT MARK etc PROTECT <input type="checkbox"/> SLIDE SHOW DELETE ALL READY FORMAT <input type="checkbox"/> RETURN [MENU]: END
5		<p>MEMORY SET</p> <ul style="list-style-type: none"> <input checked="" type="checkbox"/> CONTINUOUS <input checked="" type="checkbox"/> QUALITY <input type="checkbox"/> FLD./FRAME <input type="checkbox"/> PRINT MARK etc PROTECT <input type="checkbox"/> SLIDE SHOW DELETE ALL RETURN FORMAT <input type="checkbox"/> RETURN [MENU]: END
6		<p>MEMORY SET</p> <ul style="list-style-type: none"> <input checked="" type="checkbox"/> CONTINUOUS <input checked="" type="checkbox"/> QUALITY <input type="checkbox"/> FLD./FRAME <input type="checkbox"/> PRINT MARK etc PROTECT <input type="checkbox"/> SLIDE SHOW DELETE ALL DELETING FORMAT <input type="checkbox"/> RETURN [MENU]: END
		<p>MEMORY SET</p> <ul style="list-style-type: none"> <input checked="" type="checkbox"/> CONTINUOUS <input checked="" type="checkbox"/> QUALITY <input type="checkbox"/> FLD./FRAME <input type="checkbox"/> PRINT MARK etc PROTECT <input type="checkbox"/> SLIDE SHOW DELETE ALL COMPLETE FORMAT <input type="checkbox"/> RETURN [MENU]: END

“Memory Stick” operations

To cancel deleting all the images in the “Memory Stick”
Select RETURN in step 5, then press the SEL/PUSH EXEC.

Deleting images

While DELETING appears

Do not turn the POWER switch or press any buttons.

If the write-protect tab on the "Memory Stick" is set to LOCK

You cannot delete images.



Writing a print mark – PRINT MARK

You can specify the recorded still image to print out. This function is useful for printing out still images later.

Your camcorder conforms with the DPOF (Digital Print Order Format) standard for specifying the still images to print out.

Before operation

Insert a “Memory Stick” into your camcorder.

- (1) Set the POWER switch to MEMORY or VTR. Make sure that the LOCK is set to the right (unlock) position.
- (2) Play back the image you want to write a print mark. (p. 89)
- (3) Press MENU to display the menu.
- (4) Turn the SEL/PUSH EXEC dial to select , then press the dial.
- (5) Turn the SEL/PUSH EXEC dial to select PRINT MARK, then press the dial.
- (6) Turn the SEL/PUSH EXEC dial to select ON, then press the dial.
- (7) Press MENU to erase the menu display. The  mark is displayed beside the data file name of the image with a print mark.

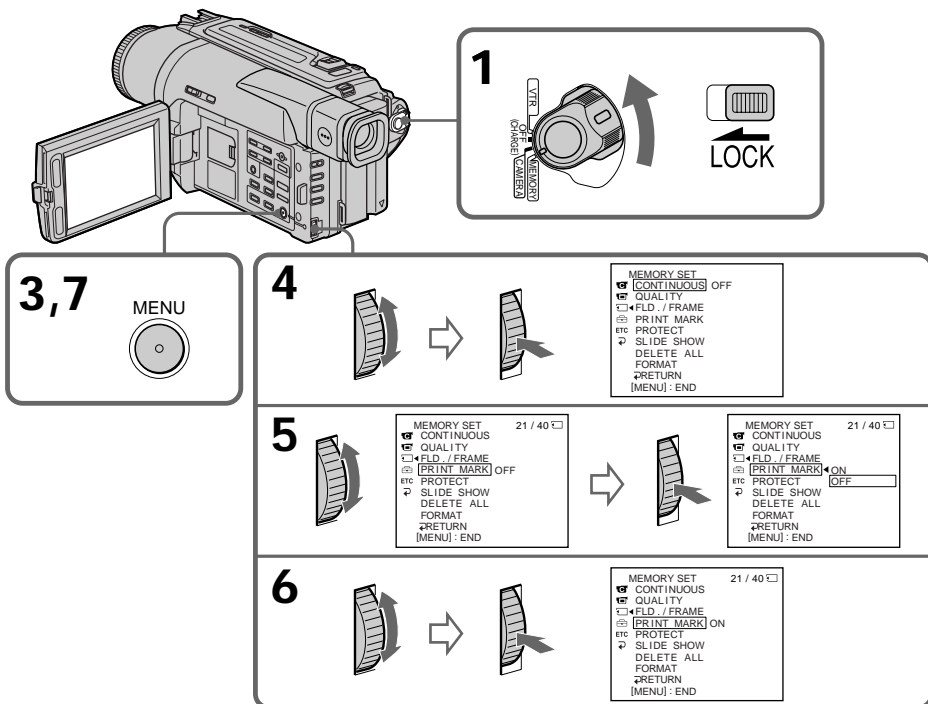



To cancel writing print marks

Select OFF in step 6, then press the SEL/PUSH EXEC dial.

If the write-protect tab on the “Memory Stick” is set to LOCK
 You cannot write print marks on still images.





Digital8 system, recording and playback



What is the “Digital8 system”?

This video system has been developed to enable digital recording to Hi8 /Digital8  video cassette .



Usable cassette tapes

We recommend using Hi8 /Digital8  video cassette. *

The recording time when you use your Digital8  system camcorder on Hi8 /standard 8  tape is half the recording time when using the conventional Hi8 /standard 8  system camcorder. (120 minutes of recording time becomes 60 minutes in the SP mode.)

* If you use standard 8  tape, be sure to play back the tape on this camcorder. Mosaic pattern noise may appear when you play back standard 8  tape on other VCRs (including other DCR-TRV520/TRV525).

Note



Tapes recorded in the Digital8  system cannot be played back on Hi8 /standard 8  (analog) system machine.

 is a trademark.

 is a trademark.



 is a trademark.



Playback system

The Digital8  system or Hi8 /standard 8  system is automatically detected before the tape is played back.

During playback of tapes recorded in the Hi8 /standard 8  system, digital signals are output as the image signals from the  DV IN/OUT jack.

Display during automatic detection of system

The Digital8  system or Hi8 /standard 8  system is automatically detected, and the playback system is automatically switched to. During switching of systems, the screen turns blue, and the following displays appear. A hissing noise also sometimes can be heard.

 → / : During switching from Digital8  to Hi8 /standard 8 

/  → : During switching from Hi8 /standard 8  to Digital8 

Copyright signal

When you play back

Using any other video camera recorder, you cannot record on a tape that has recorded copyright control signals for copyright protection of software which is played back on your camcorder.

When you record

You cannot record software on your camcorder that contains copyright control signals for copyright protection of software.

COPY INHIBIT appears on the LCD screen, in the viewfinder or on the TV screen if you try to record such software. Your camcorder does not record copyright control signals on the tape when it records.

When you playback a dual sound track tape

When you use tapes recorded in the Digital8 system

When you play back a Digital8  system tape which is dubbed from a dual sound track tape recorded in the DV system, set HiFi SOUND to the desired mode in the menu settings (p. 64).

Sound from speaker

HiFi Sound Mode	Playing back a stereo tape	Playing back a dual sound track tape
STEREO	Stereo	Main sound and sub sound
1	Lch	Main sound
2	Rch	Sub sound

When you use a tape recorded in the Hi8/standard 8 system

When you play back a dual sound track tape recorded in an AFM HiFi stereo system, set HiFi SOUND to the desired mode in the menu settings (p. 64).

Sound from speaker

HiFi Sound Mode	Playing back a stereo tape	Playing back a dual sound track tape
STEREO	Stereo	Main sound and sub sound
1	Monaural	Main sound
2	Unnatural Sound	Sub sound

You cannot record dual sound programs on your camcorder.

About i.LINK

The DV jack on this unit is an i.LINK-compliant DV input/output jack. This section describes the i.LINK standard and its features.

What is “i.LINK”?

i.LINK is a digital serial interface for handling digital video, digital audio and other data in two directions between equipment having the i.LINK jack, and for controlling other equipment.

i.LINK-compatible equipment can be connected by a single i.LINK cable. Possible applications are operations and data transactions with various digital AV equipment. When two or more i.LINK-compatible equipment are connected to this unit in a daisy chain, operations and data transactions are possible with not only the equipment that this unit is connected to but also with other devices via the directly connected equipment.

Note, however, that the method of operation sometimes varies according to the characteristics and specifications of the equipment to be connected, and that operations and data transactions are sometimes not possible on some connected equipment.

Note

Normally, only one piece of equipment can be connected to this unit by the i.LINK cable (DV cable). When connecting this unit to i.LINK-compatible equipment having two or more i.LINK jacks (DV jacks), refer to the instruction manual of the equipment to be connected.

About the Name “i.LINK”

i.LINK is a more familiar term for IEEE 1394 data transport bus proposed by SONY, and is a trademark approved by many corporations. IEEE 1394 is an international standard standardized by the Institute of Electrical and Electronic Engineers.

i.LINK Baud rate

i.LINK’s maximum baud rate varies according to the equipment. Three maximum baud rates are defined:

S100 (approx. 100Mbps*)

S200 (approx. 200Mbps)

S400 (approx. 400Mbps)

The baud rate is listed under “Specifications” in the instruction manual of each equipment. It is also indicated near the i.LINK jack on some equipment.

The maximum baud rate of equipment on which it is not indicated such as this unit is “S100”.

When units are unit is connected to equipment having a different maximum baud rate, the baud rate sometimes differs from the indicated baud rate.

* What is “Mbps”?

Mbps stands for megabits per second, or the amount of data that can be sent or received in one second. For example, a baud rate of 100Mbps means that 100 megabits of data can be sent in one second.

About i.LINK

i.LINK Functions on this unit

For details on how to dub when this unit is connected to other video equipment having DV jacks, see page 86.

This unit can also be connected to other i.LINK (DV) compatible equipment made by SONY (e.g. VAIO series personal computer) other than video equipment .

Before connecting this unit to a personal computer, make sure that application software supported by this unit is already installed on the personal computer.

For details on precautions when connecting this unit, also refer to the instruction manuals for the equipment to be connected.

Required i.LINK Cable

Use the Sony i.LINK 4-pin-to-4-pin cable (during DV dubbing).

i.LINK and  are trademarks.

Changing the lithium battery in your camcorder

When replacing the lithium battery, keep the battery pack or other power source attached. Otherwise, you will need to reset the date, time and other items in the menu settings hold in memory by the lithium battery.

Insert the battery with the positive (+) side facing out. When the battery becomes weak or dead, the  indicator flashes on the LCD screen or in the viewfinder for about 5 seconds when you set the POWER switch to CAMERA or MEMORY. In this case, replace the battery with a Sony CR2025 or Duracell DL-2025 lithium battery. Use of any other battery may present a risk of fire or explosion. Discard used batteries according to the manufacturer's instructions.

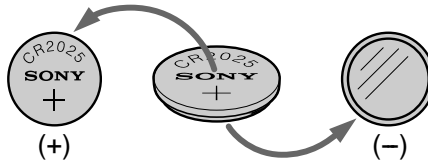

WARNING

The battery may explode if mistreated. Do not recharge, disassemble, nor dispose of it in fire.

Lithium battery

- Keep the lithium battery out of the reach of children.
- Should the battery be swallowed, immediately consult a doctor.
- Wipe the battery with a dry cloth to ensure good contact.

Lithium battery installed at the factory

This battery may not last 1 year.

Changing the lithium battery in your camcorder

Changing the lithium battery

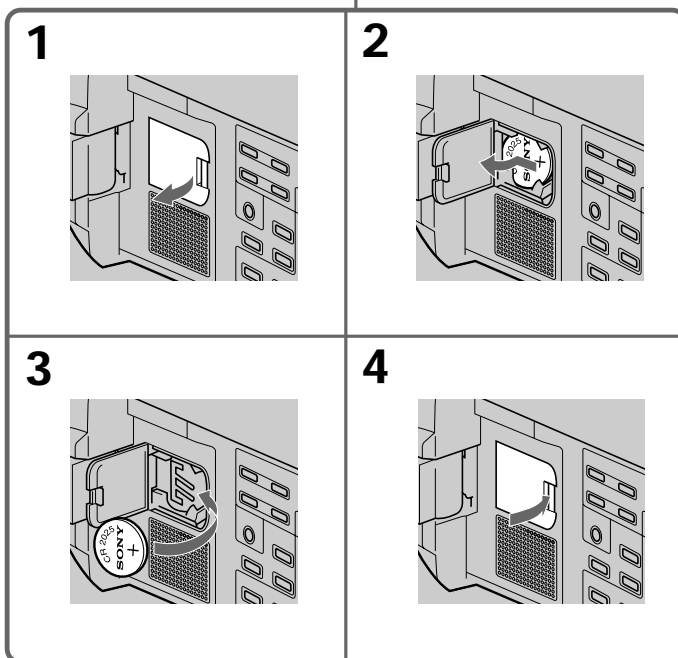
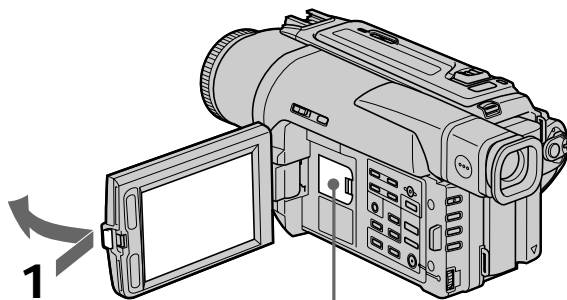

- (1) Open the LCD panel and open the lid of the lithium battery compartment.
- (2) Push the lithium battery in the direction of the arrow and pull it out from the holder.
- (3) Install a Sony CR2025 or Duracell DL-2025 lithium battery with the positive (+) side facing out.
- (4) Close the lid.



Troubleshooting

If you run into any problem using your camcorder, use the following table to troubleshoot the problem. If the problem persists, disconnect the power source and contact your Sony dealer or local authorized Sony service facility. If “C:□□:□□” appears on the LCD screen, in the viewfinder or the display window, the self-diagnosis display function has worked. See page 113.

In the recording mode

Symptom	Cause and/or Corrective Actions
START/STOP does not operate.	<ul style="list-style-type: none"> • The POWER switch is set to OFF (CHARGE), VTR or MEMORY. → Set it to CAMERA. (p. 16) • The tape has run out. → Rewind the tape or insert a new one. (p. 15, 24) • The write-protect tab is set to expose the red mark. → Use a new tape or slide the tab. (p. 15) • The tape is stuck to the drum (moisture condensation). → Remove the cassette and leave your camcorder for at least 1 hour to acclimatize. (p. 117)
The power goes off.	<ul style="list-style-type: none"> • While being operated in CAMERA mode, your camcorder has been in the standby mode for more than 3 minutes. → Set the POWER switch to OFF (CHARGE) and then to CAMERA again. (p. 16)
The image on the viewfinder screen is not clear.	<ul style="list-style-type: none"> • The viewfinder lens is not adjusted. → Adjust the viewfinder lens. (p. 19)
The SteadyShot function does not work.	<ul style="list-style-type: none"> • STEADYSHOT is set to OFF in the menu settings. → Set it to ON. (p. 64) • 16:9WIDE is set to ON in the menu settings. → Set it to OFF. (p. 64)
The autofocus function does not work.	<ul style="list-style-type: none"> • FOCUS is set to MANUAL. → Set it to AUTO. (p. 43) • Shooting conditions are not suitable for autofocus. → Set FOCUS to MANUAL to focus manually. (p. 43)
The fader function does not work.	<ul style="list-style-type: none"> • The digital effect function is working. → Cancel it. (p. 37)
The picture does not appear in the viewfinder.	<ul style="list-style-type: none"> • The LCD panel is open. → Close the LCD panel. (p. 17)
You cannot record in the LP mode.	<ul style="list-style-type: none"> • The tape is the standard 8 tape. → Use Hi8 /Digital8  tapes. (p. 68)

Troubleshooting



Symptom	Cause and/or Corrective Actions
A vertical band appears when you shoot a subject such as lights or a candle flame against a dark background.	<ul style="list-style-type: none"> The contrast between the subject and background is too high. This is not a malfunction.
A vertical band appears when you shoot a very bright subject.	<ul style="list-style-type: none"> This is not a malfunction.
Some tiny white spots appear on the LCD screen or in the viewfinder.	<ul style="list-style-type: none"> Slow shutter, low lux or Super NightShot mode is activated. This is not a malfunction.
An unknown picture is displayed on the LCD screen or in the viewfinder.	<ul style="list-style-type: none"> If 10 minutes elapse after you set the POWER switch to CAMERA or DEMO MODE is set to ON in the menu settings without a cassette inserted, your camcorder automatically starts the demonstration. <ul style="list-style-type: none"> → Insert a cassette and the demonstration stops. You can also cancel DEMO MODE. (p. 69)
The picture is recorded in incorrect or unnatural colors.	<ul style="list-style-type: none"> NIGHTSHOT is set to ON. <ul style="list-style-type: none"> → Set it to OFF. (p. 20)
Picture appears too bright, and the subject does not appear on the LCD screen or in the viewfinder.	<ul style="list-style-type: none"> NIGHTSHOT is set to ON in a bright place. <ul style="list-style-type: none"> → Set it to OFF, or use the NightShot function in a dark place. (p. 20)
A horizontal black band appears when shooting a TV screen or computer screen.	<ul style="list-style-type: none"> Set STEADYSHOT to OFF in the menu setting. (P. 64)

In the playback mode

Symptom	Cause and/or Corrective Actions
The tape does not move when a video control button is pressed.	<ul style="list-style-type: none"> The POWER switch is set to CAMERA, MEMORY or OFF (CHARGE). <ul style="list-style-type: none"> → Set it to VTR. (p. 24)
The playback button does not work.	<ul style="list-style-type: none"> The tape has run out. <ul style="list-style-type: none"> → Rewind the tape. (p. 24)
There are horizontal lines on the picture or the playback picture is not clear or does not appear.	<ul style="list-style-type: none"> The video head may be dirty. <ul style="list-style-type: none"> → Clean the heads using the Sony V8-25CLD cleaning cassette (not supplied). (p. 118)
No sound or only a low sound is heard when playing back a tape.	<ul style="list-style-type: none"> The stereo tape is played back with HiFi SOUND set to 2 in the menu settings. <ul style="list-style-type: none"> → Set it to STEREO. (p. 64) The volume is turned to minimum. <ul style="list-style-type: none"> → Open the LCD panel and press VOLUME +. (p. 24) AUDIO MIX is set to ST2 side in the menu settings. <ul style="list-style-type: none"> → Adjust AUDIO MIX. (p. 64)
The date search does not work correctly.	<ul style="list-style-type: none"> The tape has a blank portion in the recorded portion (p. 53)
The picture which is recorded in the Digital8 system is not played back.	<ul style="list-style-type: none"> PB MODE is set to Hi8/8 in the menu settings. <ul style="list-style-type: none"> → Set it to AUTO. (p. 64)
The tape which is recorded in the Hi8 /standard 8 system is not played back correctly.	<ul style="list-style-type: none"> Set PB MODE to Hi8/8 in the menu settings. (p. 64)

Troubleshooting

In the recording and playback modes

Symptom	Cause and/or Corrective Actions
The power does not turn on.	<ul style="list-style-type: none">• The battery pack is not installed, or is dead or nearly dead. → Install a charged battery pack. (p. 10, 11)• The AC power adaptor is not connected to a wall outlet. → Connect the AC power adaptor to a wall outlet. (p. 14)
The end search function does not work.	<ul style="list-style-type: none">• The tape was ejected after recording.• You have not recorded on the new cassette yet.
The end search function does not work correctly.	<ul style="list-style-type: none">• The tape has a blank portion in the beginning or middle.
The battery pack is quickly discharged.	<ul style="list-style-type: none">• The operating temperature is too low.• The battery pack is not fully charged. → Charge the battery pack fully again. (p. 11)• The battery pack is completely dead, and cannot be recharged. → Replace with a new battery pack. (p. 10)
The battery remaining indicator does not indicate the correct time.	<ul style="list-style-type: none">• You have used the battery pack in an extremely hot or cold environment for a long time.• The battery pack is completely dead, and cannot be recharged. → Replace with a new battery pack. (p. 10)• The battery is dead. → Use a charged battery pack. (p. 10, 11)
The power goes off although the battery remaining indicator indicates that the battery pack has enough power to operate.	<ul style="list-style-type: none">• Charge the battery pack fully again so that the indication on the battery remaining indicator is correct.
The cassette cannot be removed from the holder.	<ul style="list-style-type: none">• The power source is disconnected. → Connect it firmly. (p. 11, 14)• The battery is dead. → Use a charged battery pack. (p. 10, 11)
The  and  indicators flash and no functions except for cassette ejection work.	<ul style="list-style-type: none">• Moisture condensation has occurred. → Remove the cassette and leave your camcorder for at least 1 hour to acclimatize. (p. 117)

Troubleshooting

When operating using the “Memory Stick”

Symptom	Cause and/or Corrective Actions
The “Memory Stick” does not function.	<ul style="list-style-type: none">• The POWER switch is set to CAMERA or OFF (CHARGE). → Set it to MEMORY. (p. 77)• The “Memory Stick” is not inserted. → Insert a “Memory Stick”. (p. 74)
Recording does not function.	<ul style="list-style-type: none">• The “Memory Stick” has already been recorded to its full capacity. → Erase unnecessary images and record again. (p. 77, 98)• The “Memory Stick” formatted incorrectly is inserted. → Format the “Memory Stick” on your camcorder or use another “Memory Stick.” (p. 67)• The write-protect tab on the “Memory Stick” is set to LOCK. → Release the lock. (p. 72)
The image cannot be deleted.	<ul style="list-style-type: none">• The write-protect tab on the “Memory Stick” is set to LOCK. → Release the lock. (p. 72)• The image is protected. → Cancel image protection. (p. 97)
You cannot format the “Memory Stick”.	<ul style="list-style-type: none">• The write-protect tab on the “Memory Stick” is set to LOCK. → Release the lock. (p. 72)
Deleting all the images cannot be carried out.	<ul style="list-style-type: none">• The write-protect tab on the “Memory Stick” is set to LOCK. → Release the lock. (p. 72)
You cannot protect the image.	<ul style="list-style-type: none">• The write-protect tab on the “Memory Stick” is set to LOCK. → Release the lock. (p. 72)• The image to protect is not played back. → Press MEMORY PLAY to play back the image. (p. 89)
You cannot write a print mark on the still image.	<ul style="list-style-type: none">• The write-protect tab on the “Memory Stick” is set to LOCK. → Release the lock. (p. 72)• The image to write a print mark is not played back. → Press MEMORY PLAY to play back the image. (p. 89)
The photo save function does not work.	<ul style="list-style-type: none">• The write-protect tab on the “Memory Stick” is set to LOCK. → Release the lock. (p. 72)

Troubleshooting

Others

Symptom	Cause and/or Corrective Actions
The Remote Commander supplied with your camcorder does not work.	<ul style="list-style-type: none">• COMMANDER is set to OFF in the menu settings. → Set it to ON. (p. 64)• Something is blocking the infrared rays. → Remove the obstacle.• The batteries are inserted in the battery holder with the + - polarities incorrectly matching the + - marks. → Insert the batteries with the correct polarity. (p. 128)• The batteries are dead. → Insert new ones. (p. 128)
The picture from a TV or VCR does not appear even when your camcorder is connected to outputs on the TV or VCR.	<ul style="list-style-type: none">• DISPLAY is set to V-OUT/LCD in the menu settings. → Set it to LCD. (p. 64)
The melody or beep sounds for 5 seconds.	<ul style="list-style-type: none">• Moisture condensation has occurred. → Remove the cassette and leave your camcorder for at least 1 hour to acclimatize. (p. 117)• Some troubles has occurred in your camcorder. → Remove the cassette and insert it again, then operate your camcorder.
While charging the battery pack, no indicator appears or the indicator flashes in the display window.	<ul style="list-style-type: none">• The AC power adaptor is disconnected. → Connect it firmly. (p. 14)• Something is wrong with the battery pack. → Contact your Sony dealer or local authorized Sony service facility.

Self-diagnosis display

Your camcorder has a self-diagnosis display function.

This function displays the current condition of your camcorder as a 5-digit code (a combination of a letter and figures) on the LCD screen, in the viewfinder, or in the display window.

If a 5-digit code is displayed, check the following code chart. The last two digits (indicated by □□) will differ depending on the state of your camcorder.

LCD screen, viewfinder or display window

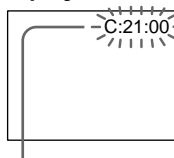

Self-diagnosis display

- C:□□:□□
You can service your camcorder yourself.
- E:□□:□□
Contact your Sony dealer or local authorized Sony facility.

Five-digit display	Cause and/or Corrective Actions
C:04:□□	<ul style="list-style-type: none"> • You are using a battery pack that is not an "InfoLITHIUM" battery pack. → Use an "InfoLITHIUM" battery pack. (p. 13)
C:21:□□	<ul style="list-style-type: none"> • Moisture condensation has occurred. → Remove the cassette and leave your camcorder for at least 1 hour to acclimatize. (p. 117)
C:22:□□	<ul style="list-style-type: none"> • The video heads are dirty. → Clean the heads using the Sony V8-25CLD cleaning cassette (not supplied). (p. 118)
C:31:□□ C:32:□□	<ul style="list-style-type: none"> • A malfunction other than the above that you can service has occurred. → Remove the cassette and insert it again, then operate your camcorder. → Disconnect the power cord of the AC power adaptor or remove the battery pack. After reconnecting the power source, operate your camcorder.
E:61:□□ E:62:□□	<ul style="list-style-type: none"> • A malfunction that you cannot service has occurred. → Contact your Sony dealer or local authorized Sony service facility and inform them of the 5-digit code. (example: E:61:10)

If you are unable to rectify the problem even if you try corrective actions a few times, contact your Sony dealer or local authorized Sony service facility.

Warning indicators and messages

If indicators and messages appear on the LCD screen, in the viewfinder, or in the display window, check the following:

See the page in parentheses “ () ” for more information.

Warning indicators

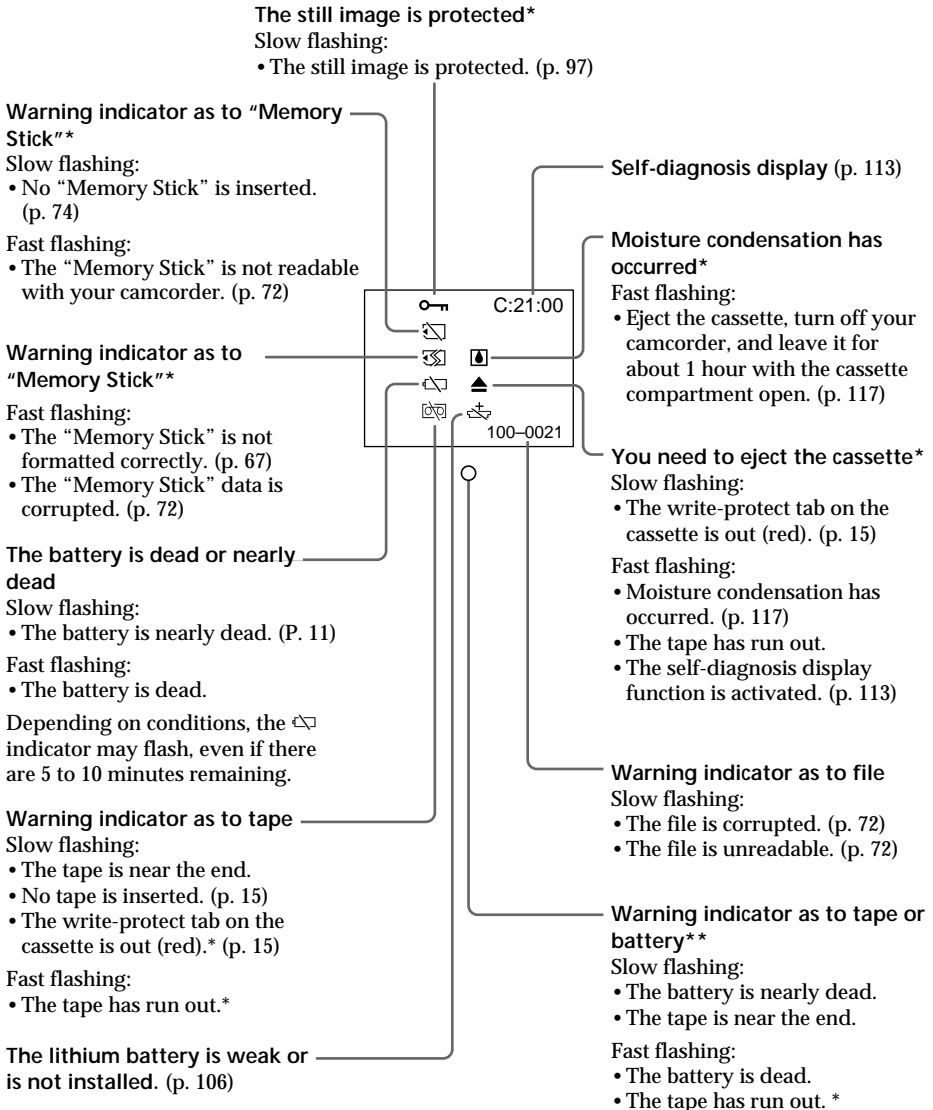



















* You hear the melody or beep sound.



** This indicator appears in the viewfinder only. (DCR-TRV520 only)

Warning indicators and messages

Warning messages

-  CLOCK SET Reset the date and time. (p. 71)
-  FOR “InfoLITHIUM”
BATTERY ONLY Use an “InfoLITHIUM” battery pack. (p. 13)
-  8mm TAPE → SP REC Use Hi8 /Digital8  tapes when you record in the LP mode.* (p. 68)
-   TAPE END The tape has run out.*
-  NO TAPE Insert a cassette tape.* (P. 15)
-  CLEANING CASSETTE** The video heads are dirty. (p. 118)
-  COPY INHIBIT You tried to record a picture that has a copyright control signal.* (p. 102)
-  FULL The “Memory Stick” is full.* (p. 79)
-   The write-protect tab on the “Memory Stick” is set to LOCK.* (p. 72)
-  NO FILE No still image is recorded on the “Memory Stick”.* (p. 89)
-  NO MEMORY STICK No “Memory Stick” is inserted.* (p. 74)
-  MEMORY STICK ERROR The “Memory Stick” data is corrupted.* (p. 72)
-  FORMAT ERROR Check the type of formatting.*
-   DIRECTORY ERROR The “Memory Stick” has more than one directory such as 100msdcf.*

* You hear the melody or beep sound.

** The  indicator and “ CLEANING CASSETTE” message appear one after another on the LCD screen or in the viewfinder.

Using your camcorder abroad

Using your camcorder abroad

You can use your camcorder in any country or area with the AC power adaptor supplied with your camcorder within 100 V to 240 V AC, 50/60 Hz.

When charging the battery pack, use a commercially available AC plug adaptor [a], if necessary, depending on the design of the wall outlet [b].

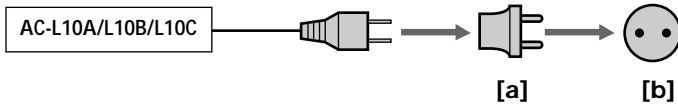

Your camcorder is an NTSC system based camcorder. If you want to view the playback picture on a TV, it must be an NTSC system based TV with VIDEO/AUDIO input jack. The following shows TV color systems used overseas.

NTSC system

Bahama Islands, Bolivia, Canada, Central America, Chile, Colombia, Ecuador, Jamaica, Japan, Korea, Mexico, Peru, Surinam, Taiwan, the Philippines, the U.S.A., Venezuela, etc.

PAL system

Australia, Austria, Belgium, China, Czech Republic, Denmark, Finland, Germany, Great Britain, Holland, Hong Kong, Italy, Kuwait, Malaysia, New Zealand, Norway, Portugal, Singapore, Slovak Republic, Spain, Sweden, Switzerland, Thailand, etc.

PAL-M system

Brazil

PAL-N system

Argentina, Paraguay, Uruguay

SECAM system



Bulgaria, France, Guyana, Hungary, Iran, Iraq, Monaco, Poland, Russia, Ukraine, etc.

Simple setting of clock by time difference

You can easily set the clock to the local time by setting a time difference. Select WORLD TIME in the menu settings. See page 64 for more information.

Maintenance information and precautions

Moisture condensation

If your camcorder is brought directly from a cold place to a warm place, moisture may condense inside your camcorder, on the surface of the tape, or on the lens. In this condition, the tape may stick to the head drum and be damaged or your camcorder may not operate correctly. If there is moisture inside your camcorder, the beep sounds and the  indicator flashes. When the  indicator flashes at the same time, the cassette is inserted in your camcorder. If moisture condenses on the lens, the indicator will not appear.

If moisture condensation occurred

None of the functions except cassette ejection will work. Eject the cassette, turn off your camcorder, and leave it for about 1 hour with the cassette compartment open. Your camcorder can be used again if the  indicator does not appear when the power is turned on again.

Note on moisture condensation

Moisture may condense when you bring your camcorder from a cold place into a warm place (or vice versa) or when you use your camcorder in a hot place as follows:

- You bring your camcorder from a ski slope into a place warmed up by a heating device.
- You bring your camcorder from an air-conditioned car or room into a hot place outside.
- You use your camcorder after a squall or a shower.
- You use your camcorder in a high temperature and humidity place.

How to prevent moisture condensation

When you bring your camcorder from a cold place into a warm place, put your camcorder in a plastic bag and tightly seal it. Remove the bag when the air temperature inside the plastic bag has reached the surrounding temperature (after about 1 hour).

Maintenance information

Cleaning the LCD screen



If fingerprints or dust make the LCD screen dirty, we recommend using a LCD Cleaning Kit (not supplied) to clean the LCD screen.

Cleaning the video head

To ensure normal recording and clear pictures, clean the video heads.

When you playback/record in the Digital8 system

The video head may be dirty when:

- mosaic-pattern noise appears on the playback picture.
- playback pictures do not move.
- playback pictures are hardly visible.
- playback pictures do not appear.
- the  indicator and " CLEANING CASSETTE" message appear one after another on the LCD screen or in the viewfinder.



or

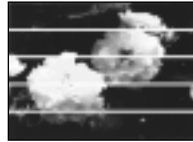

When you play back in the Hi8/Standard 8 (analog) system

The video head may be dirty when:

- playback pictures contain noise.
- playback pictures are hardly visible.
- playback pictures do not appear.



or

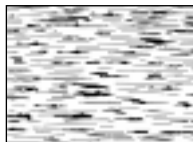

If the above problem occurs, clean the video heads with the Sony V8-25CLD cleaning cassette (not supplied). Check the picture and if the above problem persists, repeat cleaning.

Maintenance information and precautions

Removing dust from inside the viewfinder (DCR-TRV520 only)

- (1) Remove the screw with a screwdriver (not supplied). (2) Then, while holding the RELEASE knob up, (3) turn the eyecup in a counterclockwise direction and pull it out.
- (2) Clean the surface with a commercially available blower for a still camera.
- (3) Turn the eyecup in a clockwise direction, then replace the screw.

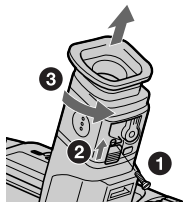

Caution

Do not remove any other screws. You may remove only the screw to remove the eyecup.

Precautions

Camcorder operation

- Operate your camcorder on 7.2 V (battery pack) or 8.4 V (AC power adaptor).
- For DC or AC operation, use the accessories recommended in this operating instructions.
- If any solid object or liquid get inside the casing, unplug your camcorder and have it checked by a Sony dealer before operating it any further.
- Avoid rough handling or mechanical shock. Be particularly careful of the lens.
- Keep the POWER switch set to OFF (CHARGE) when you are not using your camcorder.
- Do not wrap your camcorder with a towel, for example, and operate it. Doing so might cause heat to build up inside.
- Keep your camcorder away from strong magnetic fields or mechanical vibration. Noise may appear on the image.
- Do not touch the LCD screen with your fingers or a sharp-pointed object.
- If your camcorder is used in a cold place, a residual image may appear on the LCD screen or in the viewfinder. This is not a malfunction.
- While using your camcorder, the back of the LCD screen may heat up. This is not a malfunction.



On handling tapes

Do not insert anything into the small holes on the rear of the cassette. These holes are used to sense the type and thickness of the tape and if the recording tab is in or out.

Camcorder care

- Remove the tape, and periodically turn on the power, operate the CAMERA and VTR sections and play back a tape for about 3 minutes when your camcorder is not to be used for a long time.
- Clean the lens with a soft brush to remove dust. If there are fingerprints on the lens, remove them with a soft cloth.
- Clean the camcorder body with a dry soft cloth, or a soft cloth lightly moistened with a mild detergent solution. Do not use any type of solvent which may damage the finish.
- Do not let sand get into your camcorder. When you use your camcorder on a sandy beach or in a dusty place, protect it from the sand or dust. Sand or dust may cause your camcorder to malfunction, and sometimes this malfunction cannot be repaired.

Connection to your PC

- When recording with i.LINK cable the image processed or edited by your PC, use a new Hi8 /Digital8  tape.
- When inputting the image recorded by Hi8/standard 8 (analog) system into your PC, dub the image into a Digital8  or DV tape first, and then input it into your PC.

When inputting the image recorded by Hi8/standard 8 system into Sony VAIO

The Program Capture function of DVgate motion doesn't work. To use this function, dub the image into a Digital8  or DV tape first, and then input it into your Sony VAIO.

AC power adaptor

- Unplug the unit from the wall outlet when you are not using the unit for a long time. To disconnect the power cord, pull it out by the plug. Never pull the power cord itself.
- Do not operate the unit with a damaged cord or if the unit has been dropped or damaged.
- Do not bend the power cord forcibly, or place a heavy object on it. This will damage the cord and may cause fire or electrical shock.
- Prevent metallic objects from coming into contact with the metal parts of the connecting section. If this happens, a short may occur and the unit may be damaged.
- Always keep metal contacts clean.
- Do not disassemble the unit.
- Do not apply mechanical shock or drop the unit.
- While the unit is in use, particularly during charging, keep it away from AM receivers and video equipment. AM receivers and video equipment disturb AM reception and video operation.
- The unit becomes warm during use. This is not a malfunction.
- Do not place the unit in locations that are:
 - Extremely hot or cold
 - Dusty or dirty
 - Very humid
 - Vibrating

Battery pack

- Use only the specified charger or video equipment with the charging function.
- To prevent accident from a short circuit, do not allow metal objects to come into contact with the battery terminals.
- Keep the battery pack away from fire.
- Never expose the battery pack to temperatures above 140°F (60°C), such as in a car parked in the sun or under direct sunlight.
- Keep the battery pack dry.
- Do not expose the battery pack to any mechanical shock.
- Do not disassemble nor modify the battery pack.
- Attach the battery pack to the video equipment securely.
- Charging while some capacity remains does not affect the original battery capacity.

Note on dry batteries

To avoid possible damage from battery leakage or corrosion, observe the following:

- Be sure to insert the batteries with the + - polarities matched to the + - marks.
- Dry batteries are not rechargeable.
- Do not use a combination of new and old batteries.
- Do not use different types of batteries.
- Current flows from batteries when you are not using them for a long time.
- Do not use leaking batteries.

If batteries are leaking

- Wipe off the liquid in the battery compartment carefully before replacing the batteries.
- If you touch the liquid, wash it off with water.
- If the liquid get into your eyes, wash your eyes with a lot of water and then consult a doctor.

If any problem occurs, unplug your camcorder and contact your nearest Sony dealer.

Specifications

Video camera recorder

System

Video recording system

2 rotary heads
Helical scanning system

Audio recording system

Rotary heads, PCM system
Quantization: 12 bits (Fs 32 kHz, stereo 1, stereo 2), 16 bits (Fs 48 kHz, stereo)

Video signal

NTSC color, EIA standards

Recommended cassette

Hi8/Digital8 video cassette

Recording/playback time (using 120 min. Hi8 video cassette)

SP mode: 1 hour

LP mode: 1 hour and 30 minutes

Fastforward/rewind time (using 120 min. Hi8 video cassette)

Approx. 5 min.

Viewfinder

Electric Viewfinder

DCR-TRV520: monochrome

DCR-TRV525: color

Image device

1/4 type CCD

(Charge Coupled Device)

Approx. 460,000 pixels

(Effective: Approx. 290,000 pixels)

Lens

Combined power zoom lens

Filter diameter 1 7/16 in. (37 mm)

25× (Optical), 450× (Digital)

Focal length

5/32 - 2 7/8 in. (3.7 - 92.5 mm)

When converted to a 35 mm still camera

1 5/8 - 32 3/8 in. (48 - 1200 mm)

Color temperature

Auto

Minimum illumination

1 lux (F 1.6)

0 lux (in the NightShot mode)*

* Objects unable to be seen due to the dark can be shot with infrared lighting.

Input/output connectors

S video input/output

4-pin mini DIN

Luminance signal: 1 Vp-p,

75 ohms, unbalanced

Chrominance signal: 0.286 Vp-p,

75 ohms, unbalanced

Audio/Video input/output

AV MINIJACK, 1 Vp-p, 75 ohms,

unbalanced, sync negative 327

mV, (at output impedance more

than 47 kilohms)

Output impedance with less than

2.2 kilohms/Stereo minijack

(ø 3.5 mm)

Input impedance more than 47

kilohms

DV input/output

4-pin connector

Headphone jack

Stereo minijack (ø 3.5 mm)

LANC  /DIGITAL I/O Jack

Stereo mini-minijack (ø 2.5 mm)

Transfer rate:

Max 115.2 Kbps

RS-232C based

MIC jack

Stereo minijack (ø 3.5 mm)

LCD screen

Picture

DCR-TRV520:

3.5 type

2 7/8 × 2 in. (72.2 × 50.4 mm)

DCR-TRV525:

3 type

2 1/2 × 1 3/4 in. (61.0 × 43.8 mm)

Total dot number

123,200 (560 × 220)

General

Power requirements

7.2 V (battery pack)

8.4 V (AC power adaptor)

Average power consumption

(when using the battery pack)

During camera recording using

LCD

4.2W

Viewfinder

DCR-TRV520: 3.3W

DCR-TRV525: 3.0W

Operating temperature

32 °F to 104 °F (0 °C to 40 °C)

Storage temperature

-4 °F to +140 °F (-20 °C to +60 °C)

Dimensions (Approx.)

DCR-TRV520:

4 3/8 × 4 1/4 × 9 1/4 in.

(111 × 106 × 233 mm) (w/h/d)

DCR-TRV525:

4 3/8 × 4 1/4 × 8 1/4 in.

(111 × 106 × 207 mm) (w/h/d)

Mass (approx.)

2 lb 2 oz (980 g)

excluding the battery pack, lithium

battery, cassette and shoulder

strap

2 lb 6 oz (1.1 kg)

including the battery pack

NP-F330, lithium battery CR2025,

120min. Hi8 cassette, and shoulder

strap

Supplied accessories

See page 5.

AC power adaptor

Power requirements

100 - 240 V AC, 50/60 Hz

Power consumption

23 W

Output voltage

DC OUT: 8.4 V, 1.5 A in the

operating mode

Operating temperature

32 °F to 104 °F (0 °C to 40 °C)

Storage temperature

-4 °F to +140 °F (-20 °C to +60 °C)

Dimensions (approx.)

5 × 1 9/16 × 2 1/2 in.

(125 × 39 × 62 mm) (w/h/d)

excluding projecting parts

Mass (approx.)

9.8 oz (280 g)

excluding power cord

Battery pack

Output voltage

DC 7.2 V

Capacity

5.0 Wh

Dimensions (approx.)

1 9/16 × 13/16 × 2 7/8 in.

(38 × 21 × 71 mm) (w/h/d)

Mass (approx.)

3.4 oz (95 g)

Type

Lithium ion

"Memory Stick"

Memory

Flash memory

4MB: MSA-4A

Operating voltage

2.7 - 3.6 V

Power consumption

Approx. 45 mA in the operating mode

Approx. 130 µA in the standby mode

Dimensions (approx.)

2 × 1 8/8 × 7/8 in.

(50 × 2.8 × 21.5 mm) (w/h/d)

Mass (approx.)

0.14 oz (4 g)

Design and specifications are subject to change without notice.

Identifying the parts and controls

Camcorder

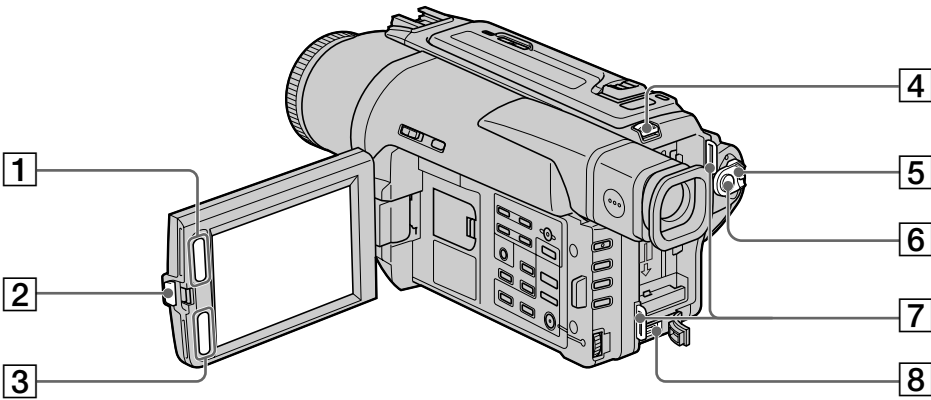

- 1 LCD BRIGHT buttons (p. 17)
- 2 OPEN button (p. 16)
- 3 VOLUME buttons (p. 24)
- 4 BATT RELEASE lever (p. 10)

- 5 POWER switch (p. 16)
- 6 START/STOP button (p. 16)
- 7 Hooks for shoulder strap (p. 125)
- 8 DC IN jack (p. 11)



This mark indicates that this product is a genuine accessory for Sony video products.

When purchasing Sony video products, Sony recommends that you purchase accessories with this "GENUINE VIDEO ACCESSORIES" mark.

Identifying the parts and controls

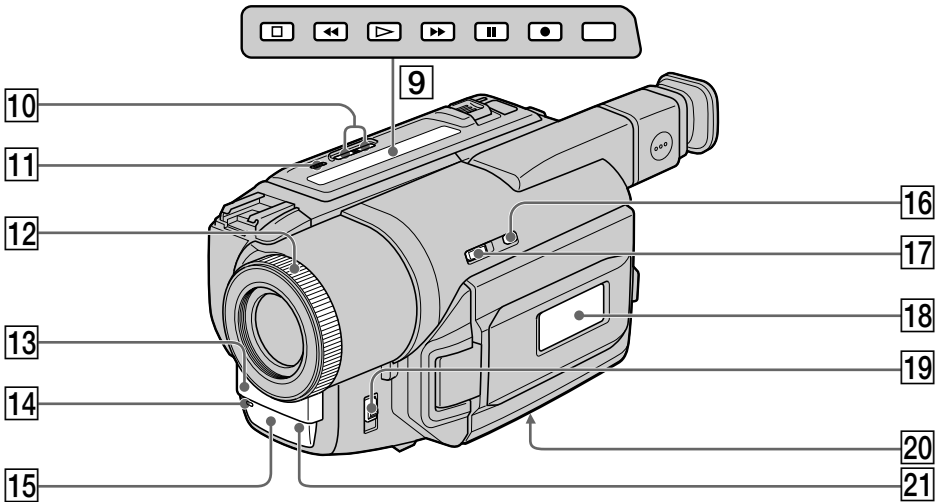

9 Video control buttons (p. 24, 26)

- STOP (stop)
- ◀◀ REW (rewind)
- ▶▶ PLAY (playback)
- ▶▶ FF (fastforward)
- || PAUSE (pause)
- REC (recording)

The control buttons light up when you set the POWER switch to VTR.

10 EDITSEARCH buttons (p. 23)

11 S.LASER LINK button (p. 28)

12 Focus ring (p. 43)

13 Microphone

14 Camera recording lamp (p. 16)

15 Infrared rays emitter (p. 20, 28)

16 SUPER NIGHTSHOT button (p. 20)

17 NIGHTSHOT switch (p. 20)

18 Display window (p. 129)

19 FOCUS switch (p. 43)

20 Tripod receptacle (base)

Make sure that the length of the tripod screw is less than 9/32 inch (6.5 mm). Otherwise, you cannot attach the tripod securely and the screw may damage your camcorder.

21 Remote sensor

What is SUPER LASER LINK?

The super laser link system sends and receives pictures and sound between video equipment having the super laser link mark  by using infrared rays.

Identifying the parts and controls

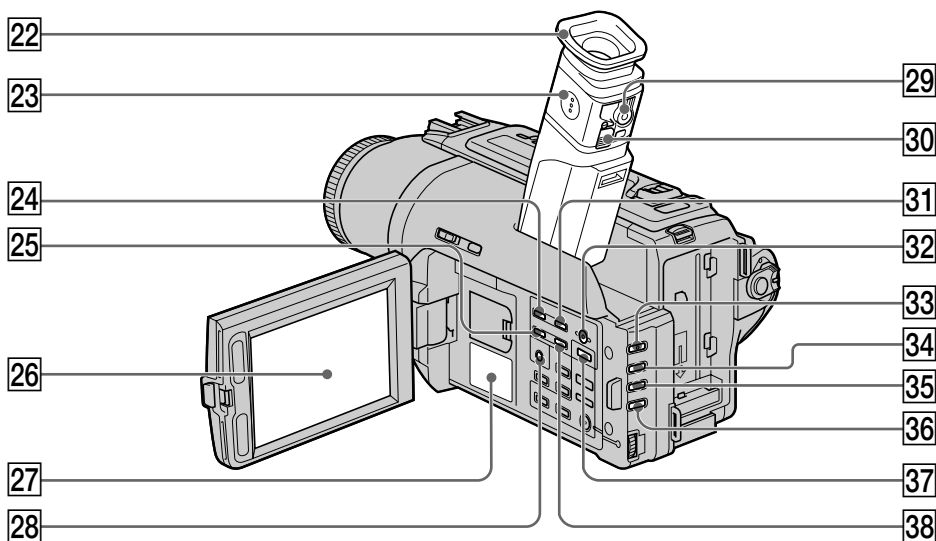

- | | |
|---|--|
| 22 Eyecup | 31 MEMORY INDEX button (p. 90) |
| 23 Viewfinder | 32 MEMORY DELETE button (p. 98) |
| 24 MEMORY PLAY button (p. 89) | 33 FADER button (p. 33) |
| 25 MEMORY - button (p. 83, 89) | 34 BACK LIGHT button (p. 20) |
| 26 LCD screen (p. 17) | 35 PROGRAM AE button (p. 41) |
| 27 Speaker | 36 EXPOSURE button (p. 42) |
| 28 ⏻ (self-timer) button (p. 22) | 37 MEMORY MIX button (p. 83) |
| 29 Viewfinder lens adjustment lever (p. 19) | 38 MEMORY + button (p. 83, 89) |
| 30 Eyecup RELEASE knob (p. 119)
(DCR-TRV520 only) | |

Attaching the shoulder strap

Attach the shoulder strap supplied with your camcorder to the hooks for the shoulder strap.

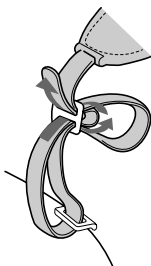

Identifying the parts and controls

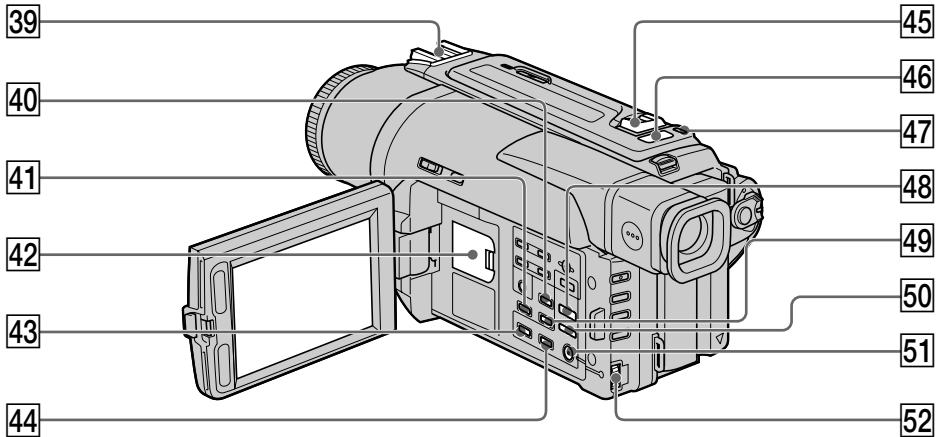

39 Intelligent accessory shoe

40 DATA CODE button (p. 25)

41 DISPLAY button (p. 25)

42 Lithium battery compartment (p. 107)

43 PB ZOOM button (p. 51, 94)

44 TITLE button (p. 44)

45 Power Zoom lever (p. 18)

46 "Memory Stick" lamp
This lamp lights up while "Memory Stick" is in the "Memory Stick" compartment.

47 PHOTO button (p. 29, 77)

48 DIGITAL EFFECT button (p. 38, 50)

49 END SEARCH button (p. 23)

50 PICTURE EFFECT button (p. 36, 49)

51 MENU button (p. 32, 64)

52 SEL/PUSH EXEC dial (p. 32, 64)





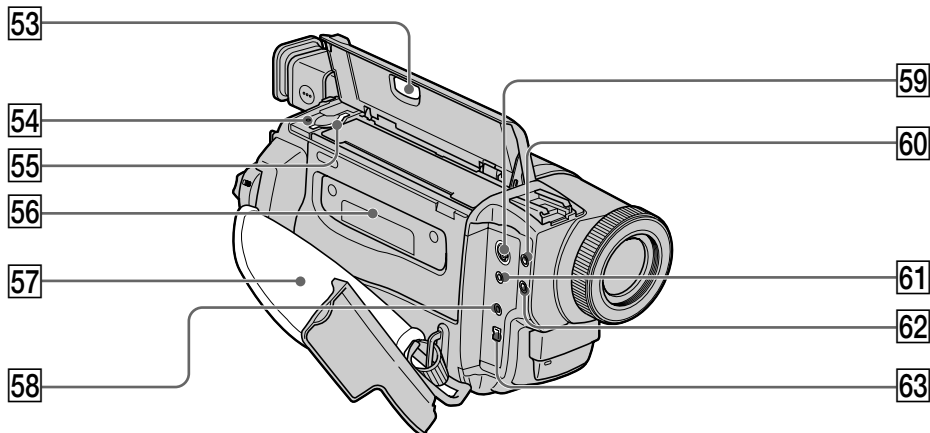

Notes on the intelligent accessory shoe

- The intelligent accessory shoe supplies power to optional accessories such as a video light or microphone.
- The intelligent accessory shoe is linked to the POWER switch, allowing you to turn the power supplied by the shoe on and off. Refer to the operating instructions of the accessory for further information.
- The intelligent accessory shoe has a safety device for fixing the installed accessory securely. To connect an accessory, press down and push it to the end, and then tighten the screw.
- To remove an accessory, loosen the screw, and then press down and pull out the accessory.

Identifying the parts and controls



- 53** EJECT button (p. 15)
- 54** Access lamp (p. 74)
- 55** "Memory Stick" compartment (p. 74)
- 56** Cassette compartment (p. 15)
- 57** Grip strap
- 58** LANC  /DIGITAL I/O jack (p. 91)
LANC stands for Local Application Control Bus System. The LANC control jack is used for controlling the tape transport of video equipment and other peripherals connected to the video equipment. This jack has the same function as the jack indicated as CONTROL L or REMOTE.
- 59** S VIDEO ID-2 jack (p. 27)
- 60**  (headphones) jack
- 61** AUDIO/VIDEO ID-2 jack (p. 27, 31, 57, 86)
- 62** MIC (PLUG IN POWER) jack
Connect an external microphone (not supplied). This jack also accepts a "plug-in-power" microphone.
- 63**  DV IN/OUT jack (p. 58, 86)
The  DV IN/OUT jack is i.LINK compatible.

Fastening the grip strap

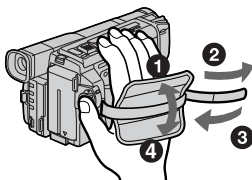

Fasten the grip strap firmly.

Identifying the parts and controls

Remote Commander

The buttons that have the same name on the Remote Commander as on your camcorder function identically to the buttons on your camcorder.

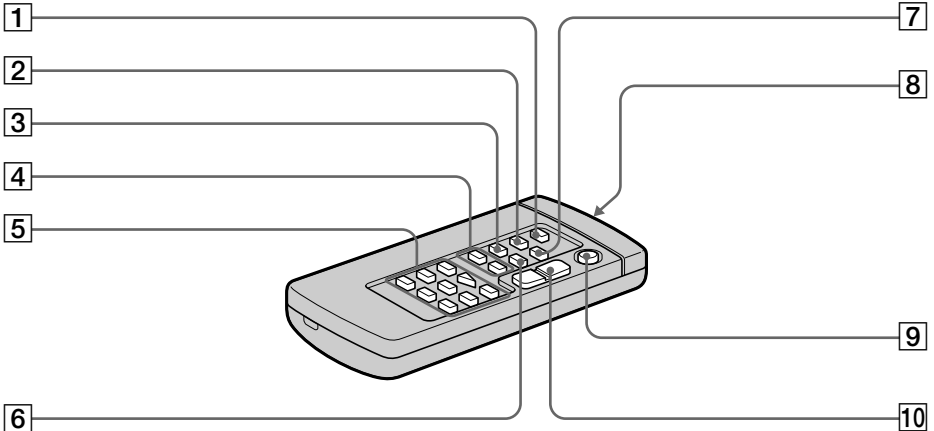

- | | |
|---|---|
| 1 PHOTO button (p. 29, 77) | 7 ZERO SET MEMORY button (p. 48, 52) |
| 2 DISPLAY button (p. 25) | 8 Transmitter
Point toward the remote sensor to control the camcorder after turning on the camcorder. |
| 3 SEARCH MODE button (p. 53, 55) | 9 START/STOP button (p. 16) |
| 4 ◀◀/▶▶ buttons (p. 53, 55) | 10 Power zoom button (p. 18) |
| 5 Tape transport buttons (p. 26) | |
| 6 DATA CODE button (p. 25) | |

To prepare the Remote Commander

Insert 2 size AA (R6) batteries by matching the + and - polarities on the batteries to the + - marks inside the battery compartment.

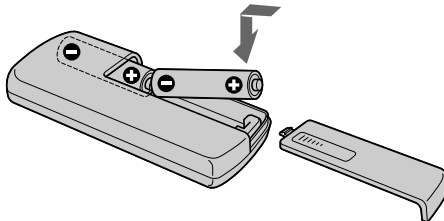

Notes on the Remote Commander

- Point the remote sensor away from strong light sources such as direct sunlight or overhead lighting. Otherwise, the Remote Commander may not function properly.
- Your camcorder works in the Commander mode VTR 2. Commander modes 1, 2 and 3 are used to distinguish your camcorder from other Sony VCRs to avoid remote control misoperation. If you use another Sony VCR in the Commander mode VTR 2, we recommend changing the Commander mode or covering the sensor of the VCR with black paper.

Identifying the parts and controls

Operation indicators

LCD screen and Viewfinder

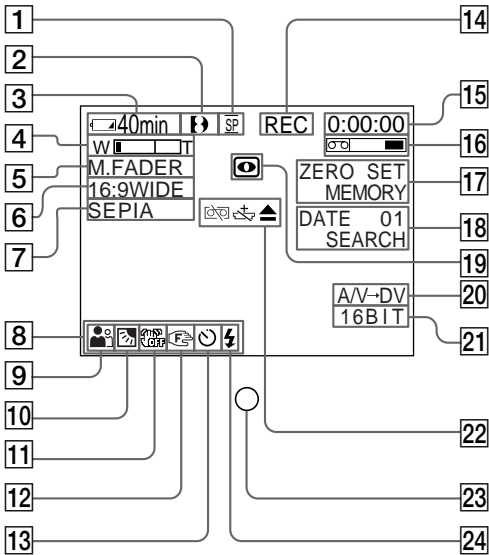

Display window

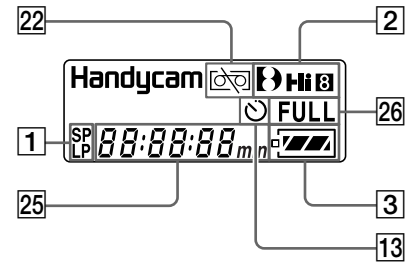

- 1 Recording mode indicator (p. 16) /Mirror mode indicator (p. 17)
- 2 Format indicator (p. 102)
▶, **Hi 8** or **8** indicator appears.
- 3 Remaining battery time indicator (p. 11, 19)
- 4 Zoom indicator (p. 18)/Exposure indicator (p. 42)
- 5 Fader indicator (p. 34)/Digital effect indicator (p. 38, 50)
- 6 Wide mode indicator (p. 32) FRAME indicator (p. 77)
- 7 Picture effect indicator (p. 36, 49)
- 8 LCD bright indicator (p. 17)/Volume indicator (p. 24)/Data code indicator (p. 25)
- 9 PROGRAM AE indicator (p. 40)
- 10 Backlight indicator (p. 20)
- 11 SteadyShot off indicator (p. 65)
- 12 Manual focusing indicator (p. 43)
- 13 Self-timer indicator (p. 22)
- 14 STBY/REC indicator (p. 16)/Video control mode (p. 26)
- 15 Tape counter indicator (p. 19, 48, 52)/ Time code indicator (p. 19)/Self-diagnosis display indicator (p. 113)/ Tape photo recording indicator (p. 29)
- 16 Remaining tape indicator (p. 19)
- 17 ZERO SET MEMORY indicator (p. 48, 52, 63)
- 18 Search mode indicator (p. 23, 53, 55)
- 19 NIGHTSHOT indicator (p. 20)
- 20 A/V → DV indicator (p. 66)/ DV IN indicator (p. 61)
- 21 Audio mode indicator (p. 68)
- 22 Warning indicators (p. 114)
- 23 Recording lamp (p. 16) (DCR-TRV520 only)
 This indicator appears in the viewfinder.
- 24 Video flash ready indicator
 This indicator appears when you use the video flash light (not supplied).
- 25 Tape counter indicator (p. 19, 48, 52)/ Time code indicator (p. 19)Self-diagnosis display indicator (p. 113)/ Remaining battery time indicator (p. 11)
- 26 FULL charge indicator (p. 11)

Quick Function Guide

Functions to adjust exposure (in the recording mode)

- In a dark place NIGHTSHOT (p. 20)
- In insufficient light Low lux mode (p. 40)
- In dark environments such as sunset, fireworks, or general night views Sunset & moon mode (p. 40)
- Shooting backlit subjects BACK LIGHT (p. 20)
- In spotlight, such as at the theater Spotlight mode (p. 40)
- In strong light or reflected light, such as at a beach in midsummer or on a ski slope Beach & ski mode (p. 40)

Functions to give images more impact (in the recording mode)

- Smooth transition between scenes FADER (p. 33)
- Taking a still image Tape photo recording (p. 29)/
Memory photo recording (P. 77)
- Digital processing of images PICTURE EFFECT (p. 36)/
DIGITAL EFFECT (p. 37)
- Creating a soft background for subjects Soft portrait mode (p. 40)
- Superimposing a title TITLE (p. 44)

Functions to give a natural appearance to your recordings (in the recording mode)

- Preventing deterioration of picture quality in digital zoom D ZOOM [MENU] (p. 64)
- Focusing manually Manual focus (p. 43)
- Shooting distant subjects Landscape mode (p. 40)
- Recording fast-moving subjects Sports lesson mode (p. 40)

Functions to use in editing (in the recording mode)

- Watching the picture on a wide-screen TV Wide mode (p. 32)
- Viewing images using a personal computer "Memory Stick" (p. 72)

Functions to use after recording (in the playback mode)

- Digital processing of recorded images PICTURE EFFECT (p. 49)/
DIGITAL EFFECT (p. 50)
- Displaying the date/time or recording data when you recorded Data code (p. 25)
- Quickly locating a desired scene Zero set memory (p. 48, 52)
- Searching for scenes recorded on tape in the photo mode Photo search (p. 55)
- Scanning scenes recorded on tape in the photo mode Photo scan (p. 56)
- Playing back on monaural sound or sub sound HiFi SOUND [MENU] (p. 64)
- Playing back the picture on a TV without connecting a cord SUPER LASER LINK (p. 28)

Index

A, B

AC power adaptor	11
Adjusting viewfinder	19
AFM HiFi Sound	103
AUDIO MIX	66
AUDIO MODE	68
A/V connecting cable	27, 31, 57, 86
BACK LIGHT	20
Battery pack	10
BEEP	70
BOUNCE	33

C, D

Camera chromakey	82
Charging battery	11
Clock set	71
Connection (viewing on TV)	27
(dubbing a tape)	57
Connection to your PC	59
Data code	25
Date search	53
DEMO	69
DIGITAL EFFECT	37, 50
Digital 8 system	102
DIGITAL I/O	127
DISPLAY	25
DOT	33
Dual sound track tape	103
Dubbing a tape	57
DV connecting cable	58, 86

E

EDITSEARCH	23
END SEARCH	23, 26
Exposure	42
External microphone (not supplied)	124

F, G, H

FADER	33
Fade in/out	33
FLASH MOTION	37
FOCUS	43
Format	67
Full charge	11
Grip strap	127
Headphone jack	127
Heads	118
HiFi SOUND	66

I, J, K, L

i.LINK	58, 104, 127
Image protection	97
Image quality mode	75
Index screen	90
"InfoLITHIUM" battery	13
Infrared rays emitter	20, 28
JPEG	72
LANC	127
LCD screen	17
LUMINANCEKEY	37

M, N

Main sound	66
Manual focus	42
Memory chromakey	82
Memory luminancekey	82
MEMORY MIX	82
Memory overlap	82
Memory photo recording	77
"Memory Stick"	72
Menu settings	64
Mirror mode	17
Moisture condensation	117
Monaural	27
MONOTONE	33
Mosaic fader	33
NIGHTSHOT	20
Normal charge	11
NTSC system	116

O, P, Q

OLD MOVIE	37
Operation indicators	129
OVERLAP	33
PB ZOOM	51, 94
PC serial cable	91
Photo scan	56
Photo search	55
PICTURE EFFECT	36, 49
Picture search	26
Playback pause	26
Power sources (battery pack)	10
(house current)	14
(car battery)	14
Print mark	101
PROGRAM AE	40

R

Recording time	12
Rec Review	23
Remaining battery time indicator	19
Remaining tape indicator	19
Remote Commander	128
Remote control jack (LANC)	127
Remote sensor	124

S

Self-diagnosis display	113
Self-timer	22, 81
SEL/PUSH EXEC dial	126
Shoulder strap	125
Signal convert function	59
Skip scan	26
Slide show	95
Slow playback	26
SLOW SHUTTER	37
STEADYSHOT	65
Stereo tape	103
STILL	37
Sub sound	66
SUPER LASER LINK	28, 124
SUPER NIGHTSHOT	21
S video jack	27

T, U, V

Tape counter	19
Tape photo recording	29
Telephoto	18
Time code	19
Title	44
TRAIL	37
Transition	17
TV color systems	116

W, X, Y, Z

Warning indicators	114
Wide-angle	18
Wide mode	32
WIPE	33
WORLD TIME	70
Write-protect tab	15
Zero set memory	48, 52, 63
Zoom	18

