

SONY[®]

4-098-430-11 (1)

WEGA



**Flat Panel Color TV
Operating Instructions**

**KDE42XBR950
KDE50XBR950
KDE61XBR950**

XBR



WEGA ENGINE



WARNING

To reduce the risk of fire or shock hazard, do not expose the TV to rain or moisture.

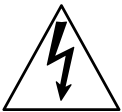

This symbol is intended to alert the user to the presence of uninsulated “dangerous voltage” within the product’s enclosure that may be of sufficient magnitude to constitute a risk of electric shock to persons.



This symbol is intended to alert the user to the presence of important operating and maintenance (servicing) instructions in the literature accompanying the appliance.

CAUTION

To prevent electric shock, do not use this polarized AC plug with an extension cord, receptacle or other outlet unless the blades can be fully inserted to prevent blade exposure.

CAUTION

When using TV games, computers, and similar products with your TV, or viewing a TV station whose logo always stays on the screen, keep the brightness and contrast functions at low settings. If a fixed (non-moving) pattern such as a station logo is left on the screen for long periods of time, especially at a high brightness or contrast setting, the image can be permanently imprinted onto the screen. These types of imprints are not covered by your warranty.

Owner’s Record

The model and serial numbers are located at the rear of the TV, below the Sony logo, on the sticker, and also on the TV box (white label). Record these numbers in the spaces provided below. Refer to them whenever you call upon your Sony dealer regarding this product.

Model No. _____

Serial No. _____

Note on Caption Vision

This television receiver provides display of television closed captioning in accordance with §15.119 of the FCC rules.

Note to CATV System Installer

This reminder is provided to call the CATV system installer’s attention to Article 820-40 of the National Electrical Code (NEC) that provides guidelines for proper grounding and, in particular, specifies that the cable ground shall be connected to the grounding system of the building, as close to the point of cable entry as practical.

Use of this television receiver for other than private viewing of programs broadcast on UHF or VHF or transmitted by cable companies for the use of the general public may require authorization from the broadcaster/cable company and/or program owner.

NOTIFICATION

This equipment has been tested and found to comply with the limits for a Class B digital device pursuant to Part 15 of the FCC Rules. These limits are designed to provide reasonable protection against harmful interference in a residential installation. This equipment generates, uses, and can radiate radio frequency energy and, if not installed and used in accordance with the instructions, may cause harmful interference with radio communications. However, there is no guarantee that interference will not occur in a particular installation. If this equipment does cause harmful interference to radio or television reception, which can be determined by turning the equipment off and on, the user is encouraged to try to correct the interference by one or more of the following measures:

- Reorient or relocate the receiving antennas.
- Increase the separation between the equipment and receiver.
- Connect the equipment into an outlet on a circuit different from that to which the receiver is connected.
- Consult the dealer or an experienced radio/TV technician for help.

You are cautioned that any changes or modifications not expressly approved in this manual could void your authority to operate this equipment.

Safety

- Operate the TV only on 120 V AC.
- The plug is designed, for safety purposes, to fit into the wall outlet only one way. If you are unable to insert the plug fully into the outlet, contact your dealer.
- If any liquid or solid object should fall inside the cabinet, unplug the TV immediately and have it checked by qualified service personnel before operating it further.
- If you will not be using the TV for several days, disconnect the power by pulling the plug itself. Never pull on the cord.
- For details concerning safety precautions, see “Important Safeguards” on page 3.

Important Notice

- When used at an altitude of greater than 2400m or 7872feet (air pressure less than 750hPa), this Plasma Display Panel may generate a low buzzing sound as a result of the difference between the interior and exterior air pressure of the panels. This is not considered a defect and is not covered under by the Limited Warranty.

Installing

- ❑ To prevent internal heat buildup, do not block the ventilation openings.
- ❑ Do not install the TV in a hot or humid place, or in a place subject to excessive dust or mechanical vibration.
- ❑ Avoid operating the TV at temperatures below 5°C (41°F).
- ❑ If the TV is transported directly from a cold to a warm location, or if the room temperature changes suddenly, the picture may be blurred or show poor color due to moisture condensation. In this case, please wait a few hours to let the moisture evaporate before turning on the TV.
- ❑ To obtain the best picture, do not expose the screen to direct illumination or direct sunlight. It is recommended to use spot lighting directed down from the ceiling or to cover the windows that face the screen with opaque drapery. It is desirable to install the TV in a room where the floor and walls are not of a reflective material.

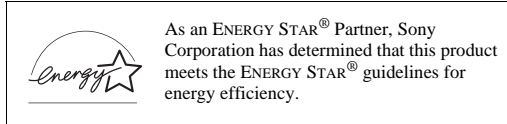

ENERGY STAR® is a U.S. registered mark.

CAUTION

How to reduce the risk of “Image Retention” on your TV

Bright, stationary images such as TV station logos displayed on your TV can cause permanent damage to your TV, resulting in retention of the image in the picture. Please take the following steps to reduce the risk of causing image retention:

View a variety of program sources or programming material.

Image retention can occur when bright stationary images such as TV station logos are viewed. Changing the program material viewed reduces the possibility that a single image will become imprinted on the picture tubes in your TV.

When viewing programs with stationary images, adjust the picture setting to reduce the “Picture” and “Brightness” levels. Image retention is accelerated by higher “Brightness” and higher “Picture” settings.

Please see page 96 for instructions on adjusting picture settings.

This will help you reduce the risk of causing image retention.

IMAGE RETENTION IS NOT COVERED BY YOUR WARRANTY

CAUTION

The following SONY appliance(s) for use only with the following TV STAND or WALL-HANGING RACK UNIT. Use with other TV STAND or WALL-HANGING RACK UNIT is capable of resulting in instability causing possible injury.

SONY APPLIANCE MODEL NO.

KDE42XBR950 (PDM-4210)

KDE50XBR950 (PDM-5010)

KDE61XBR950 (PDM-6110)

SONY TABLE TOP STAND MODEL NO.

SU-P42T2 (for PDM-4210)

SU-P50T2 (for PDM-5010/6110)

SONY WALL-MOUNT BRACKET MODEL NO.

SU-PW2 (for PDM-4210/5010/6110)

SONY FLOATING STAND MODEL NO.

SU-PF1 (for PDM-4210/5010)

SU-PF1L (for PDM-6110)

To Customers

Sufficient expertise is required for installing the specified product. Be sure to subcontract the installation to Sony dealers or contractors and pay adequate attention to safety during the installation.

Trademark Information

TruSurround, SRS and the  symbol are trademarks of SRS Labs, Inc. TruSurround technology is incorporated under license from SRS Labs, Inc.

BBE and BBE Symbol are trademarks of BBE Sound, Inc. and are licensed by BBE Sound, Inc. under U.S. Patent No. 4,638,258 and 4,482,866.

Steady Sound, Digital Reality Creation, Caption Vision, CineMotion, Memory Stick, and Twin View are registered trademarks of Sony Corporation. ClearEdge VM, HD Detailer, and Uniform Brightness Screen are trademarks of Sony Corporation.

Important Safeguards

Before using your TV, please read these instructions completely, and keep this manual for future reference.

Carefully observe and comply with all warnings, cautions and instructions placed on the set or described in the operating instructions or service manual.

WARNING

To guard against injury, the following basic safety precautions should be observed in the installation, use and servicing of the set.

Use

Power Sources

This set should be operated only from the type of power source indicated on the serial/model plate. If you are not sure of the type of electrical power supplied to your home, consult your dealer or local power company. For those sets designed to operate from battery power, refer to the operating instructions.



Grounding or Polarization

This set is equipped with a polarized AC power cord plug (a plug having one blade wider than the other), or with a three-wire grounding type plug (a plug having a third pin for grounding). Follow the instructions below:

For the set with a polarized AC power cord plug

This plug will fit into the power outlet only one way. This is a safety feature. If you are unable to insert the plug fully into the outlet, try reversing the plug. If the plug still fails to fit, contact your electrician to have a suitable outlet installed. Do not defeat the safety purpose of the polarized plug by forcing it in.

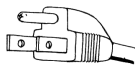

Wall outlet

Do not use a poor fitting outlet.

Insert the plug fully into the outlet. If it is loose, it may cause arcing and result in fire.

Contact your electrician to have the outlet changed.



Wiring

Unplug the AC power cord when wiring cables.

Be sure to unplug the AC power cord for your safety, when hooking up.

Moisture

Do not touch the AC power cord with a wet hand.

If you plug/unplug the AC power cord with a wet hand, it may cause electric shock.



Cleaning

Clean the AC power plug regularly.

If the plug is covered with dust and it picks up moisture, its insulation may deteriorate and result in fire. Unplug the AC power plug and clean it regularly.



For the set with a three-wire grounding type AC plug

This plug will only fit into a grounding-type power outlet. This is a safety feature. If you are unable to insert the plug into the outlet, contact your electrician to have a suitable outlet installed. Do not defeat the safety purpose of the grounding plug.

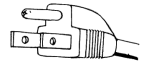

Overloading

Do not overload wall outlets, extension cords or convenience receptacles beyond their capacity, since this can result in fire or electric shock.



Always turn the set off when it is not being used. When the set is left unattended and unused for long periods of time, unplug it from the wall outlet as a precaution against the possibility of an internal malfunction that could create a fire hazard.



If a snapping or popping sound from a TV set is continuous or frequent while the TV is operating, unplug the TV and consult your dealer or service technician. It is normal for some TV sets to make occasional snapping or popping sounds, particularly when being turned on or off.

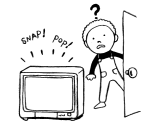

AC power cord and display interface cable

If you damage the AC power cord or display interface cable, it may result in fire or electric shock.

- Do not pinch, bend, or twist the cable excessively. The core lines may be bared and cut, and cause short-circuit, resulting in fire or electric shock.
- Do not convert or damage the AC power cord or display interface cable.
- Do not put anything heavy on the AC power cord or display interface cable. Do not pull the AC power cord or display cable.
- Keep the AC power cord or display interface cable away from heat sources.
- Be sure to grasp the plug when disconnecting the AC power cord.
- Refer to the operating instructions when disconnecting the display interface cable.

If the AC power cord or display interface cable is damaged, stop using it and ask your dealer or Sony service center to exchange it.

Cleaning

Unplug the AC power cord when cleaning this unit. If not, it may result in electric shock.

Object and Liquid Entry

Never push objects of any kind into the set through the cabinet slots as they may touch dangerous voltage points or short out parts that could result in a fire or electric shock. Never spill liquid of any kind on the set.



(Continued)

Ventilation holes

Do not insert anything in the ventilation holes. If metal or something flammable enters, it may result in fire or electric shock.



Cleaning

Clean the cabinet of the TV with a dry soft cloth. To remove dust from the screen, wipe it gently with a soft cloth. Stubborn stains may be removed with a cloth slightly dampened with a solution of mild soap and warm water. Never use strong solvents such as thinner or benzene for cleaning.



If the picture becomes dark after using the TV for a long period of time, it may be necessary to clean the inside of the TV. Consult qualified service personnel.

Attachments

Do not use attachments not recommended by the manufacturer, as they may cause hazards.

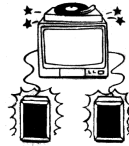

Installation

When installing the display unit on the wall, be sure to have assemblers install and keep away from the unit. If a person other than the assemblers install the display unit on the wall using a wall mount unit, the unit may fall and cause serious injury when an earthquake occurs or when the unit is not installed securely.



Carrying

Carrying the set requires two or more people.

If you carry the set in a manner other than that specified, it may drop and a serious injury may be caused. Be sure two or more people carry the set.

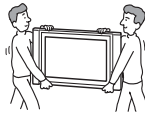

When transporting, do not subject the set to shocks or vibration excessive force. The set may fall and damage the set, causing serious injury.

AC power cord

Unplug the AC power cord when moving the set.

Do not move the set with the AC power cord plugged in. It may damage the AC power cord and result in fire or electric shock.

Medical institution

Do not place this unit in a place where medical equipment is in use.

It may cause malfunction of medical instruments.



Water and Moisture

Do not use power-line operated sets near water — for example, near a bathtub, washbowl, kitchen sink, or laundry tub, in a wet basement, or near a swimming pool, etc. It may result in fire or electric shock.



Accessories

Do not place the set on an unstable cart, stand, table or shelf. The set may fall, causing serious injury to a child or an adult and serious damage to the set. Use only a cart or stand recommended by Sony for the specific model of TV. No part of the TV set should overhang any edge of the TV cart or stand; any overhanging edge is a safety hazard. An appliance and cart combination should be moved with care. Quick stops, excessive force, and uneven surfaces may cause the appliance and cart combination to overturn.



Moisture and flammable objects

- Do not let this unit get wet. Never spill liquid of any kind on the unit. If any liquid or solid object does fall through, do not operate the unit. It may result in electric shock or damage to the unit. Have it checked immediately by qualified personnel.
- To prevent fire, keep inflammable objects or naked lights (e.g. candles) away from the set.

Dispose of used batteries

To preserve our environment, dispose the used batteries according to your local laws or regulations.

Installation and moving

Optional accessories

Observe the following when installing the display unit using a stand or wall mount unit. If not, the unit may fall and cause serious injury.

- Be sure to follow the operating instructions supplied with your stand when installing the unit.
- Be sure to attach the brackets supplied with your stand.



Protruding location

Do not install the display unit in protruding locations. If you install the unit in the following locations, injury may result.

- Do not install the unit in a location where the unit protrudes, such as pillars.
- Do not install the unit in a location that may cause facial injury.

Oils

Do not install this unit in restaurants where oily vapours occur. Dust absorbing oil may enter into the unit and damage the unit.

Corrosion

If you use this unit near the seashore, salt may corrode metal parts of the unit and cause internal damage or fire.

It may also shorten the life of the unit.

Accessories

Secure the display unit from falling down.

If the display unit is not secured properly, it may fall and cause injury. Take measures against it using a stand or other apparatus on the floor or wall in the specified manner, referring to the operating instructions supplied with your stand.

Recommended place for the Media receiver unit

Place the Media receiver unit on a stable, level surface. Otherwise, the Media receiver unit may fall and cause injury. Use an optional Sony stand, which has adequate strength.



Weight

Do not stand on the Media receiver unit. The unit may fall or break, causing injury. Pay special attention to little children.

Ventilation

The slots and openings in the media receiver unit and display unit are provided for necessary ventilation. To ensure reliable operation of the set, and to protect it from overheating, these slots and openings must never be blocked or covered.

Unless proper ventilation is provided, the unit may gather dust and get dirty. For proper ventilation, Observe the following:

- Do not install the unit turned backward or sideways.
- Do not install the unit turned over or upside down.
- Never cover the slots and openings with a cloth or other materials.
- Never block the slots and openings by placing the set on a bed, sofa, rug or other similar surface.
- Never place the set in a confined space, such as a bookcase or built-in cabinet, unless proper ventilation is provided.
- Do not place the set near or over a radiator or heat register, or where it is exposed to direct sunlight.



Ventilation

Leave some space around the unit. Otherwise, adequate air-circulation may be blocked causing overheating and cause fire or damage the unit.

When installing the unit on the wall

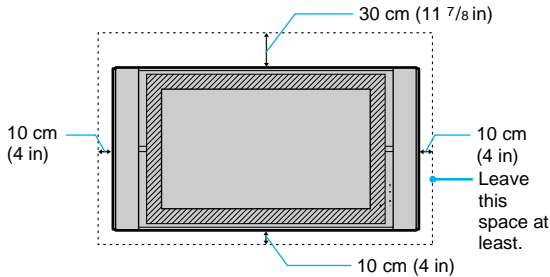

When installing the unit using a stand

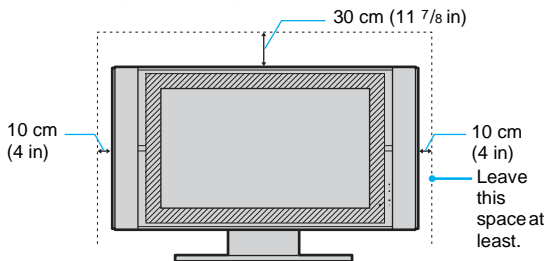

Never install the unit as follows:

Air circulation is blocked.

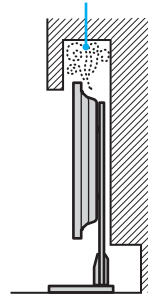

Air circulation is blocked.

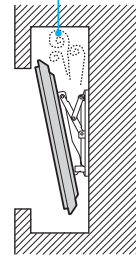

Media receiver unit: Front view

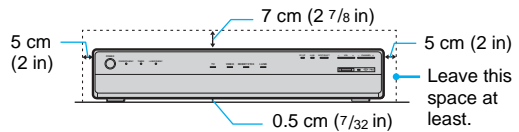

Place the Media receiver unit on a stable level surface so as not to block the inlets at the bottom of the Media receiver unit.

Media receiver unit: Top view

Never place the Media receiver unit in a confined space. It may cause overheating and result in fire, or damage the unit. Ensure reliable operation of the unit by ensuring proper ventilation of the exhaust fan.

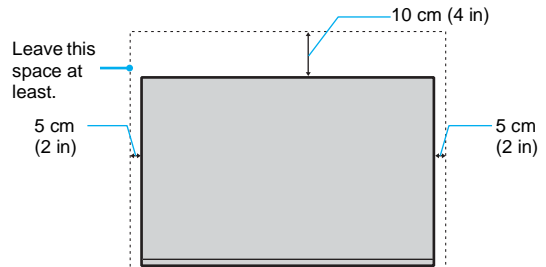

Outdoor use

Do not install this unit outdoors. If the unit is exposed to rain, it may result in fire or electric shock. If the unit is exposed to direct sunlight, the unit may heat up and it may damage the unit.



Vehicle and ceiling

Do not install this unit in a vehicle or hung from the ceiling.

Bumping of the vehicle may cause the set to fall down and cause injury.



(Continued)

Ship and vessel

Do not install this unit in a ship or vessel. If the unit is exposed to seawater, it may cause fire or damage the unit.

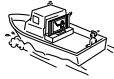

Carrying

Carrying the set requires two or more people.

If you carry the set in a manner other than that specified, it may drop and a serious injury may be caused. Be sure two or more people carry the set.

When transporting, do not subject the set to shocks or vibration, or excessive force. The set may fall and be damaged, causing serious injury.

AC power cord

Unplug the AC power cord when moving the set.

Do not move the set with the AC power cord plugged in. It may damage the AC power cord and result in fire or electric shock.

Fall

Do not hang anything on the unit.

The unit may fall from the stand or wall mount unit, causing damage or serious injury.



Power-Cord Protection

Do not allow anything to rest on or roll over the power cord, and do not place the set where the power cord is subject to wear or abuse.



Antennas

Outdoor Antenna Grounding

If an outdoor antenna is installed, follow the precautions below. An outdoor antenna system should not be located in the vicinity of overhead power lines or other electric light or power circuits, or where it can come in contact with such power lines or circuits.

WHEN INSTALLING AN OUTDOOR ANTENNA SYSTEM, EXTREME CARE SHOULD BE TAKEN TO KEEP FROM CONTACTING SUCH POWER LINES OR CIRCUITS AS CONTACT WITH THEM IS ALMOST INVARIABLY FATAL.

Be sure the antenna system is grounded so as to provide some protection against voltage surges and built-up static charges.

Section 810 of the National Electrical Code (NEC) in USA and Section 54 of the Canadian Electrical Code in Canada provides information with respect to proper grounding of the mast and supporting structure, grounding of the lead-in wire to an antenna discharge unit, size of grounding conductors, location of antenna discharge unit, connection to grounding electrodes, and requirements for the grounding electrode.

Antenna Grounding According to the National Electrical Code, ANSI/NFPA 70

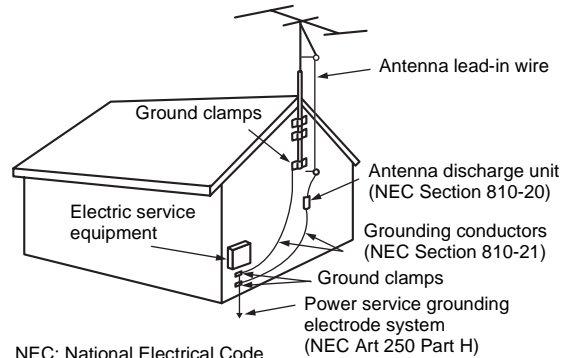

NEC: National Electrical Code

Lightning

For added protection for this television receiver during a lightning storm, or when it is left unattended and unused for long periods of time, unplug it from the wall outlet and disconnect the antenna. This will prevent damage to the receiver due to lightning and power-line surges.

Service

Damage Requiring Service

Unplug the set from the wall outlet and refer servicing to qualified service personnel under the following conditions:

- When the power cord or plug is damaged or frayed.

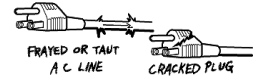

- If liquid has been spilled into the set.

- If the set has been exposed to rain or water.



- If the set has been subject to excessive shock by being dropped, or the cabinet has been damaged.



- If the set does not operate normally when following the operating instructions. Adjust only those controls that are specified in the operating instructions. Improper adjustment of other controls may result in damage and will often require extensive work by a qualified technician to restore the set to normal operation.



- When the set exhibits a distinct change in performance, it indicates a need for service.



Servicing

Do not attempt to service the set yourself since opening the cabinet may expose you to dangerous voltage or other hazards. Refer all servicing to qualified service personnel.



Replacement Parts

When replacement parts are required, be sure the service technician certifies in writing that he has used replacement parts specified by the manufacturer that have the same characteristics as the original parts.

Unauthorized substitutions may result in fire, electric shock or other hazards.



Safety Check

Upon completion of any service or repairs to the set, ask the service technician to perform routine safety checks (as specified by the manufacturer) to determine that the set is in safe operating condition, and to so certify. When the set reaches the end of its useful life, improper disposal could result in a picture tube implosion. Ask a qualified service technician to dispose of the set.



For Safety

Be careful when moving the TV

When you place the TV in position, be careful not to drop it on your foot or fingers.

Watch your footing while installing the TV.

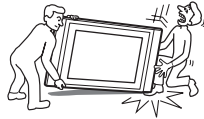

Carry the TV in the specified manner

Carrying the TV requires at least two people.

If you carry the TV in a manner other than that specified and without the specified number of persons, it may drop and a serious injury may result. Be sure to follow the instructions given below.

- Carry the TV with the specified number of persons.
- Carry the TV holding the upper and bottom frames of the TV as illustrated. Do not carry it holding the speaker units.
- Hold the TV securely when carrying it.
- As the glass surface of the display unit has a special coating, be careful to avoid touching the glass surface as far as possible.

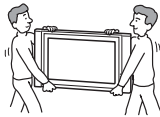

Others

Damage requiring service

If the surface of the display unit cracks, do not touch it until you unplug the AC power cord.

Otherwise electric shock may result.

Object placement

Do not place something heavy on the Media receiver unit.

It may damage the unit.

Liquid placement

Do not place objects containing liquid on the Media receiver unit.

It may result in electric shock or damage the unit.

Moisture

Do not let this unit get wet. It may result in electric shock or damage the unit.

Electric shock

Do not touch the unit with a wet hand.

Doing so may cause electric shock or damage to the unit.

Broken pieces

Do not throw anything at the unit.

The screen glass may explode by the impact and cause serious injury.

Cable wiring

Take care not to catch your feet on the cables. It may damage the unit.

Heat

Do not touch the surface of the display unit.

It remains hot, even for some time after the display unit is turned off.

Important Safety Instructions

- 1) Read these instructions.
 - 2) Keep these instructions.
 - 3) Heed all warnings.
 - 4) Follow all instructions.
 - 5) Do not use this apparatus near water.
 - 6) Clean only with dry cloth.
 - 7) Do not block any ventilation openings. Install in accordance with the manufacturer's instructions.
 - 8) Do not install near any heat sources such as radiators, heat registers, stoves, or other apparatus (including amplifiers) that produce heat.
 - 9) Do not defeat the safety purpose of the polarized or grounding-type plug. A polarized plug has two blades with one wider than the other. A grounding type plug has two blades and a third grounding prong. The wide blade or the third prong are provided for your safety. If the provided plug does not fit into your outlet, consult an electrician for replacement of the obsolete outlet.
 - 10) Protect the power cord from being walked on or pinched particularly at plugs, convenience receptacles, and the point where they exit from the apparatus.
 - 11) Only use attachments/accessories specified by the manufacturer.
 - 12) Use only with the cart, stand, tripod, bracket, or table specified by the manufacturer, or sold with the apparatus. When a cart is used, use caution when moving the cart/apparatus combination to avoid injury from tip-over.
- 
- 13) Unplug this apparatus during lightning storms or when unused for long periods of time.
 - 14) Refer all servicing to qualified service personnel. Servicing is required when the apparatus has been damaged in any way, such as power-supply cord or plug is damaged, liquid has been spilled or objects have fallen into the apparatus, the apparatus has been exposed to rain or moisture, does not operate normally, or has been dropped.

Contents

Introducing the TV

Welcome	13
Package Contents.....	13
Features.....	13

Setting Up the TV

Overview	17
TV Controls and Connectors	18
Display unit.....	18
Media receiver unit Front Panel.....	20
Media receiver unit Rear Panel.....	22
Installing the TV	23
Detaching the speakers (KDE61XBR950 only).....	25
Basic Connections: Connecting a Cable or Antenna	26
Cable or Antenna Only.....	26
Cable Box and Cable Only.....	27
Cable Box Only.....	28
Connecting Optional Equipment	30
About Using S VIDEO.....	30
VCR and Cable.....	31
VCR and Cable Box.....	33
Two VCRs for Tape Editing.....	35
Satellite Receiver.....	37
Satellite Receiver and VCR.....	39
DVD Player with Component Video Connectors.....	41
DVD Player with S VIDEO and Audio Connectors.....	43
Camcorder.....	44
Audio Receiver.....	45
Sub Woofer.....	46
Device with an Optical IN Connector.....	46
Using the CONTROL S Feature.....	47
Setting Up the Channel List	48
Using Auto Setup.....	48

Using the Remote Control

Overview	49
Inserting Batteries	49
Button Descriptions	50
Programming the Remote Control	52
Using Other Equipment with Your TV Remote Control	55
All Equipment.....	55
Operating a VCR or D-VHS.....	55
Operating a Satellite Receiver.....	55
Operating a Cable Box.....	56
Operating a DVD Player.....	56
Operating an MDP (Laserdisc Player).....	56

Using the Features

Overview	57
Watching TV	58
Using Wide Mode	59
Using Twin View	60
Displaying Twin Pictures	60
Activating the Picture	61
Changing the Picture Size.....	62
Using Favorite Channels	63
Creating a List of Favorite Channels.....	63
Displaying a List of Favorite Channels	63
Using the Freeze Function	64
Using Picture Off	65

Using the Digital Program Guide

Displaying the Digital Program Guide	67
Navigating the Digital Program Menus.....	68
Using the Guide Menu	68
Using the Program Options Menu.....	69
Using the Caption Vision Menu	69
Using the Digital Setup Menu.....	70
Customizing Caption Vision	70

Using the Memory Stick Viewer

About Memory Stick	71
Features	71
Memory Stick Compatibility	72
File Compatibility	72
Trademark Information.....	72
Inserting and Removing a Memory Stick	73
Inserting a Memory Stick.....	73
Inserting the Memory Stick Duo	74
Removing a Memory Stick	75
Using the Memory Stick Index	76
Using the Memory Stick Index	77
Viewing Photos	78
Photo Controls	78
Photo Menu Bar Options.....	79
Using Zoom and Pan	80
Using Rotate	80
Playing Movies	81
Movie Controls	81
Movie Menu Bar Options.....	82
Memory Stick Index Menu Bar Options	83
Slide Show Menu Options.....	83
Folder Menu Options.....	84
Memory Stick Menu	84
Notes on Using Memory Stick Media	85
About DCF File Names	85
Memory Stick Precautions	86

Using i.LINK

About i.LINK	87
Using i.LINK Cables	87
Connecting i.LINK Devices	88
Selecting an i.LINK Device	90
Using the i.LINK Control Panel	91
i.LINK Setup	93

Using the Menus

Overview	95
Navigating Through Menus	95
Using the Video Menu	96
Selecting Video Options	96
Using the Audio Menu	99
Selecting Audio Options	99
Using the Screen Menu	101
Selecting Screen Mode Options	101
Using the Channel Menu	103
Selecting Channel Options	103
Using the Parent Menu	105
Selecting Parent Options	105
US Models: Selecting Custom Rating Options	106
Viewing Blocked Programs	106
Canadian Models: Selecting Custom Rating Options	107
Viewing Blocked Programs	107
Using the Setup Menu	108
Selecting Setup Options	108

Other Information

Overview	113
Glossary	114
Contacting Sony	115
Troubleshooting	115
Twin View	115
Remote Control	116
Memory Stick	116
Video	118
Audio	119
Channels	119
General	120
Specifications	121
Optional Accessories	123
Index	124

Introducing the TV

Welcome

Thank you for purchasing the Sony Flat Panel Color TV. This manual is to be used with the following models:

- KDE42XBR950
- KDE50XBR950
- KDE61XBR950

Package Contents

The package contains the following:

- Flat panel display unit (PDM-6110, PDM-5010 or PDM-4210)
- Media receiver unit (MBD-XBR950)
- Remote control (RM-Y1000) and two size AA batteries
- Two AC power cords
- AC plug holder
- Display interface cable
- Antenna cable
- Cleaning cloth
- Frame bars (KDE61XBR950 only)
- Screws (KDE61XBR950 only)
- Operating Instructions

These items are all you need to set up and operate the TV in its basic configuration.

Most components (VCRs, DVD players, etc.) come with the necessary cables to connect them. If you want to set up a complex system, you may need to buy extra cables, connectors, etc. Be sure to have these on hand before you start to connect your system.

Features

Some of the features that you will enjoy with your new TV include:

- Integrated HDTV:** You can watch digital television programs and enjoy the improved audio/video quality offered by these programs.
- WEGA Engine™:** Delivers superb picture quality from any video source by minimizing the signal deterioration caused by digital-to-analog conversion and stabilizing the signal processing. This engine features unique Sony technology, including:

(Continued)

- The first step in the digital processing system, Composite Component Processor2 (CCP2), which enhances input signal to noise ratio by chroma decoder digital processing;
 - **DRC® (Digital Reality Creation)-Multifunction V1:** Unlike conventional line doublers, the DRC Multifunction feature replaces the signal's NTSC waveform with the near-HD equivalent by digital mapping processing. The DRC Palette option lets you customize the level of detail (Reality) and smoothness (Clarity) to create up to three custom palettes.
 - **Multi-Image Driver (MID™-XU):** (Twin View™) Allows you to watch two programs side by side. You can watch pictures from two different sources (1080i, 720p, 480p, and 480i) simultaneously. (Only the left Twin View window can display 1080i, 720p, and 480p sources.)
 - **CineMotion™:** Provides an optimized display by automatically detecting film content and applying a reverse 3/2 pulldown process. Moving pictures will appear clearer and more natural-looking.
 - **Newly developed PDP driver IC:** Achieves high-precision gamma characteristics, using Sony's unique digital technology. Fine gradation of dark scenes, which is not possible with conventional PDP, is realized by greatly enhancing resolution in the low brightness range.
- ❑ **BN Smoother™:** Reduces the block noise caused by digital video encoding and decoding process.
 - ❑ **Wide Screen Mode:** Watch conventional 4:3 aspect ratio broadcasts in wide screen (16:9) mode.
 - ❑ **Favorite Channels:** Allows you to preview and select from 16 of your favorite channels.
 - ❑ **Steady Sound®:** Equalizes volume levels so there is consistent output between programs and commercials.
 - ❑ **Memory Stick® Viewer:** Allows you to view on your TV screen digital images (JPEG) and movies (MPEG1) with background music (MP3) that are stored on Memory Stick media.
 - ❑ **Component Video Inputs:** Offers the best video quality for DVD (480p, 480i), and digital set-top box (HD1080i, 720p) connections.
 - ❑ **Parental Control:** V-Chip technology allows parents to block unsuitable programming from younger viewers.

- **Digital Visual Interface (DVI-HDTV):** Can accommodate a copy-protected digital connection (HDCP^{*}) to other devices (such as digital set-top boxes) that have compatible interfaces. The DVI-HDTV input terminal is compliant with the EIA-861 standard and is not intended for use with personal computers.
- **i.LINK:** Provides a secure digital interface to other digital home entertainment devices. i.LINK allows for the secure transfer of copyright-protected high-definition content between these devices and your digital TV. The i.LINK terminals on the TV are not intended for connection with personal computers.

* High-bandwidth Digital Content Protection

Setting Up the TV

Overview

This chapter includes illustrated instructions for setting up your TV.

<i>Topic</i>	<i>Page(s)</i>
TV Controls and Connectors	18-22
Installing the TV	23
Basic Connections: Connecting a Cable or Antenna	26-29
Connecting Optional Equipment	
About Using S VIDEO	30
VCR and Cable	31
VCR and Cable Box	33
Two VCRs for Tape Editing	35
Satellite Receiver	37
Satellite Receiver and VCR	39
DVD Player with Component Video Connectors	41
DVD Player with S VIDEO and Audio Connectors	43
Camcorder	44
Audio Receiver	45
Sub woofer	46
Connecting Device with an Optical IN Connector	46
Using the CONTROL S Feature	47
Setting Up the Channel List	48

TV Controls and Connectors

Display unit

Setup

Front panel

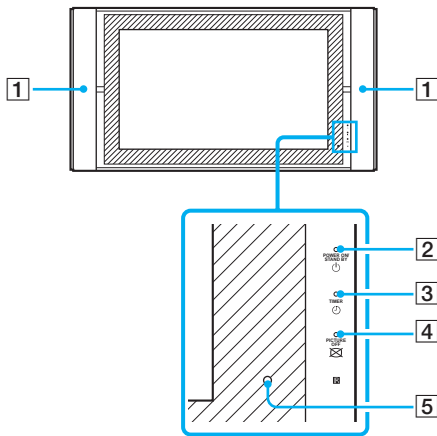

Rear panel

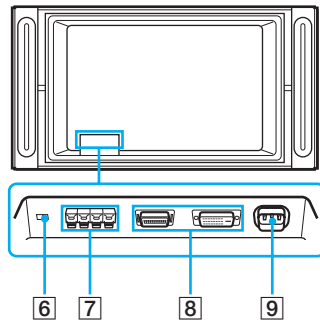

Item	Description
1 Speakers (Left/right)	The speakers on the KDE61XBR950 are detachable. For details, see “Detaching the speakers” on page 25.
2 POWER ON/STAND BY LED	Lights up in green when the TV set is turned on. When in standby mode, the LED lights up in red. The LED does not light up when the main power is turned off. If the LED blinks continuously, this may indicate the display unit needs servicing (see “Contacting Sony” on page 115).
3 TIMER LED	When lit, indicates one of the timers is set. When the timer is set, this LED will remain lit even if the TV set is turned off. For details, see page 110.
4 PICTURE OFF LED	When lit, indicates that the Picture Off feature is activated. For details, see page 65.
5 Infrared Receiver (IR)	Receives IR signals from the TV’s remote control.
6 EXT SP (external speakers) ON/OFF switch (KDE61XBR950 only)	The switch does not function on this TV.
7 EXT SP L/R terminal (KDE61XBR950 only)	The terminals do not function on this TV.

<i>Item</i>	<i>Description</i>
8 DISPLAY SIGNAL IN	Connect to the DISPLAY SIGNAL OUT jacks of the rear of the media receiver unit by using the supplied display interface cable.
9 AC IN	Connects the supplied AC power cord.

Media receiver unit Front Panel

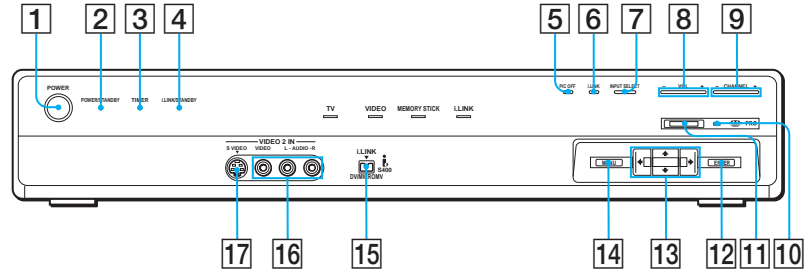

Item	Description
1 Main POWER	Press to turn on and off the main power of the TV Set.
2 POWER/ STANDBY LED	Lights up in green when the TV set is turned on. The LED lights up in red when in standby mode. The LED does not light up when the main power is turned off. If the LED blinks in red continuously, this may indicate the Media receiver unit needs servicing (see “Contacting Sony” on page 115).
3 TIMER LED	When lit, indicates one of the timers is set. When the timer is set, this LED will remain lit even if the TV set is turned off. For details, see page 110.
4 i.LINK/ STANDBY LED	When lit in red, indicates the i.LINK Standby is on. For details, see page 111.
5 PIC OFF	Press to have the TV screen turn off. For details, see page 65.
6 i.LINK	Press to display the i.LINK Control Panel. For details, see page 90.
7 INPUT SELECT	Press repeatedly to cycle through the video equipment connected to the TV’s video inputs.
8 – VOL +	Press to adjust the volume.
9 – CHANNEL +	Press to scan through channels. To scan quickly through channels, press and hold down either CHANNEL .
10 Memory Stick slot	Memory Stick insertion slot. For details, see “Inserting and Removing a Memory Stick” on page 73.
11 Memory Stick indicator	When lit, indicates that the Memory Stick is being read. (Do not remove the Memory Stick when the indicator is lit.)
12 ENTER	Press to select an on-screen menu item.
13 ↑ ↓ ← →	Press to move the on-screen cursor.
14 MENU	Press to display the Menu. Press again to exit from the Menu. For details, see page 95.

<i>Item</i>	<i>Description</i>
15 i.LINK 2	Connects to the i.LINK jack on your i.LINK-compatible portable device. Provides a secure digital connection between your TV and your i.LINK-compatible portable device.
16 VIDEO/ L-AUDIO-R VIDEO 2 IN	Connects to the composite A/V output jacks on your camcorder or other video equipment.
17 S VIDEO 2 IN	Connects to the S VIDEO OUT jack on your camcorder or other video equipment that has S VIDEO. Provides better picture quality than composite video (16).

Media receiver unit Rear Panel

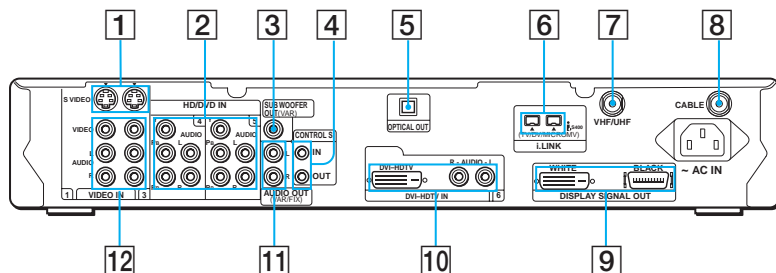

Jack	Description
1 S VIDEO IN 1/3	Connects to the S VIDEO OUT jack of your VCR or other video equipment that has S VIDEO. S VIDEO provides better picture quality than either composite video (12) or VHF/UHF (7) connections.
2 HD/DVD IN 4/5 (1080i/720p/480p/480i)	Connect to your DVD player's or digital set-top box's component video (Y, PB, PR) and audio (L/R) jacks. Component video provides better picture quality than 1, 7, or 12.
3 SUB WOOFER OUT (VAR)	Connects to the input jack of your sub woofer.
4 CONTROL S IN/OUT	Allows the TV to receive (IN) and send (OUT) remote control signals to other Sony infrared-controlled audio or video equipment that has the CONTROL S function.
5 DIGITAL AUDIO (OPTICAL) OUT (PCM/DOLBY* DIGITAL)	Connect to the optical audio input of a digital audio component that is PCM/Dolby Digital compatible.
6 i.LINK 1/3	Used for connecting i.LINK-equipped devices. These terminals are not intended for connection with personal computers.
7 VHF/UHF	RF input that connects to your VHF/UHF antenna or cable box.
8 CABLE	RF input that connects to your cable signal.
9 DISPLAY SIGNAL OUT	Connect to the DISPLAY SIGNAL IN jacks of the display unit by using the supplied display interface cable.
10 DVI-HDTV IN, DVI-HDTV AUDIO R/L, VIDEO IN 6	Can accommodate a copy-protected digital connection (HDCP**) to other devices (such as digital set-top boxes) that have compatible interfaces. The DVI-HDTV input terminal is compliant with the EIA-861 standard and is not intended for use with personal computers. See the instruction manual that came with your equipment for details about connecting and using it with the TV. Use a DVI-D single link cable.
11 AUDIO OUT (VAR/FIX) L/R	Connects to the left and right audio input jacks of your audio or video equipment. You can use these outputs to listen to your TV's audio through your stereo system.
12 VIDEO IN 1/3 VIDEO/L-AUDIO-R	Connect to the composite A/V output jacks on your VCR or other video component. A third composite A/V input jack (VIDEO 2) is located on the front panel of the Media receiver unit. These video connections provide better picture quality than the VHF/UHF (7) connections.

* "Dolby", "Pro Logic", and the double-D symbol are trademarks of Dolby Laboratories.

** High-bandwidth Digital Content Protection

Installing the TV

- 1 Connect the display interface cable (supplied) to the display unit's DISPLAY SIGNAL IN jack, and connect the AC power cord (supplied) to the display unit's AC IN jack.

 **Disconnect all power sources before making any connections.**

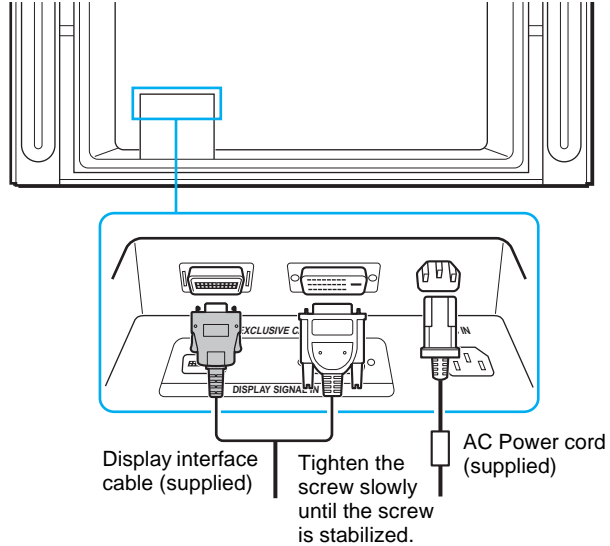

- 2 Secure the AC power plug to the display's AC IN jack.

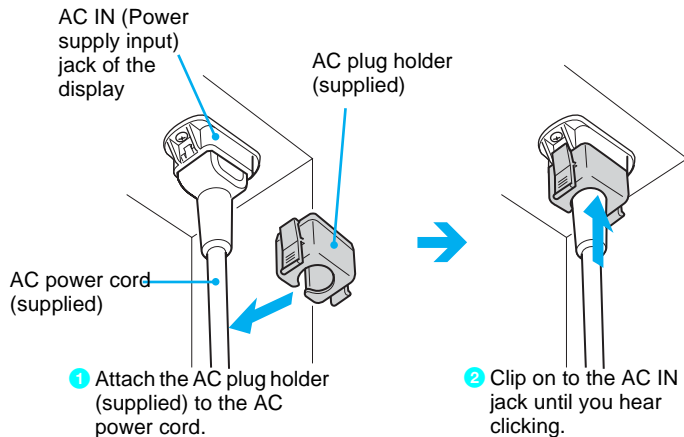

 **When you unplug the AC power cord, drag the AC plug holder down by pushing both sides of the holder, then pull out the plug.**

- 3 Install the display unit using an optional stand or rack unit.
For details, refer to the operating instructions supplied with your stand or rack unit.
- 4 Connect the other end of display interface cable to the Media receiver unit's DISPLAY SIGNAL OUT jacks, and connect the AC power cord (supplied) to the media receiver unit's AC IN jack.

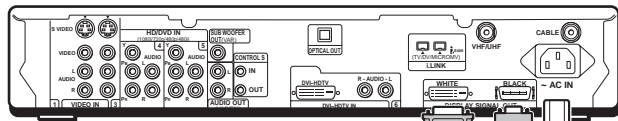

Tighten the screw slowly until the screw is stabilized.

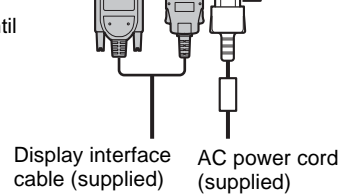

- 5 After making all connections, connect the AC power cords (supplied) to wall outlets.

 **Be sure to use the supplied AC power cords.**

When connecting optional components, do not connect the AC power cords to wall outlets until you have completed making all connections.

Do not tighten the screws too much. It may damage the screws.

Handle the display interface cable with care. If you pull the cable by catching your feet on the cable, this unit may fall and cause injury.

Do not use damaged cables, such as cables whose connectors are deformed.

Detaching the speakers (KDE61XBR950 only)

The speakers on the KDE61XBR950 can be detached.

 **Be sure to remove the speakers before installing the TV on a wall, etc. Detaching the speakers from the TV should be performed by qualified Sony personnel.**

- 1 Place a protective sheet or cloth beneath the TV on a flat floor. Turn the TV over so that you can see its rear panel.
- 2 Remove the four screws marked with arrows on the inside of the rear of the speaker, then pull out the speaker straight to detach.

Rear of the display unit

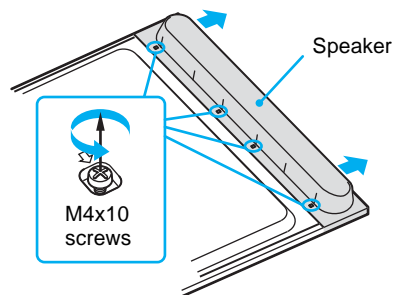

- 3 Attach the supplied frame bar and tighten with the supplied two screws.

Rear of the display unit

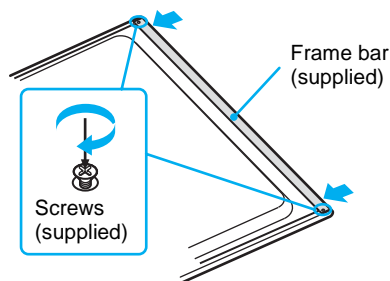

- 4 Repeat steps 2 and 3 for the other speaker.

Basic Connections: Connecting a Cable or Antenna

The way in which you will connect your TV varies, depending on how your home receives a signal (cable, cable box, antenna) and whether or not you plan to connect a VCR.

If You Are Connecting	See Page
Cable or Antenna Only	26
<input type="checkbox"/> No cable box or VCR	
Cable Box and Cable Only	27
<input type="checkbox"/> Cable box unscrambles only some channels (usually premium channels)	
<input type="checkbox"/> No VCR	
Cable Box Only	28
<input type="checkbox"/> Cable box unscrambles all channels	
<input type="checkbox"/> No VCR	

If you are connecting a VCR

- See the connections described on pages 31 and 33.

Cable or Antenna Only

For best results, use this connection if you are connecting a cable or an antenna and you:

- Do not need a cable box to unscramble channels. (If you have a cable box, see page 28.)
- Do not intend to connect a VCR. (If you have a VCR, see pages 31 and 33.)

For antenna connection, use the supplied antenna cable.

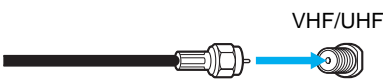
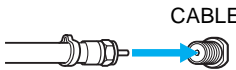
Cable Type	Connect As Shown
VHF Only or combined VHF/UHF	Antenna cable (supplied) 
Cable	75-ohm coaxial cable 

 **When using an indoor antenna, such as rabbit-ear or dipole-antenna, keep the antenna away from the display unit. If not, noise may appear on the screen.**

Note on Using This Connection

To Do This ...	Do This ...
Switch the TV's input between the cable and antenna	Press ANT to switch back and forth between the TV's VHF/UHF and CABLE inputs.

Cable Box and Cable Only

For best results, use this connection if:

- ❑ Your cable company scrambles some channels, such as premium channels (which requires you to use a cable box), but does not scramble all channels.
- ❑ You do not have a VCR. (If you have a VCR, see pages 31 and 33.)

With this connection you can:

- ❑ Use the TV remote control to change channels coming through the cable box to the TV's VHF/UHF input jack. (You must first program the remote control for your specific cable box; see "Programming the Remote Control" on page 52.)
- ❑ Use the TV remote control to change channels coming directly into the TV's CABLE input. (The TV's tuner provides a better signal than the cable box.)

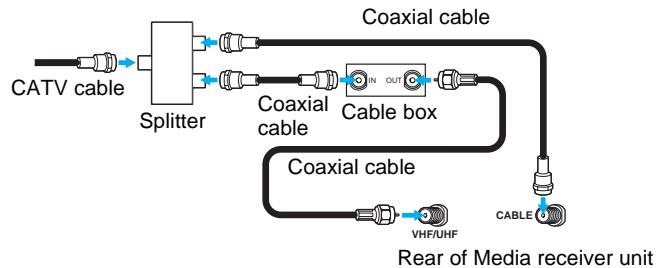

About Using This Connection with Dual Picture (Twin View, etc.) Features

With this connection, you can use all the dual picture features for unscrambled channels coming directly into the TV's CABLE input jack.

Notes on Using This Connection

To Do This ...	Do This ...
Use the cable box	Tune the TV to the channel the cable box is set to (usually channel 3 or 4) and then use the cable box to switch channels.
Set up the TV remote control to operate the cable box	Program the remote control. See "Programming the Remote Control" on page 52.
Activate the remote control to operate the cable box	Press FUNCTION repeatedly until the SAT/CABLE indicator lights up.
Prevent the accidental switching of TV channels	When using the cable box, you need the TV to stay on the channel the cable box is set to (usually channel 3 or 4). You can use the TV's Channel Fix feature to lock in a specific channel. For details, see "Using the Channel Menu" on page 103.
Switch the TV's input between the cable box and cable	Press ANT to switch back and forth between the TV's VHF/UHF (scrambled channels) and CABLE (unscrambled) inputs.

 **Do not leave the display indication of the cable box turned on.**

(Continued)

Cable Box Only

For best results, use this connection if:

- Your cable company scrambles all channels, which requires you to use a cable box.
- You do not have a VCR. (If you have a VCR, see pages 31 and 33.)

With this connection you can:

- Use the TV remote control to change channels coming through the cable box to the TV's VHF/UHF jack. (You must first program the remote control for your specific cable box.)

About Using This Connection with Dual Picture (Twin View, etc.) Features

With this connection, all channels come into the TV through your cable box and only one unscrambled signal is sent to the TV, so you cannot use the dual picture features. If some of your channels are scrambled, but others are not, consider using the "Cable Box and Cable" connection on page 27 instead.

To connect the cable box

- 1 Connect the CATV cable to the cable box's input jack.
- 2 Use the supplied antenna cable to connect the cable box's output jack to the TV's VHF/UHF jack.
- 3 Run the Auto Setup program, as described in "Setting Up the Channel List" on page 48.

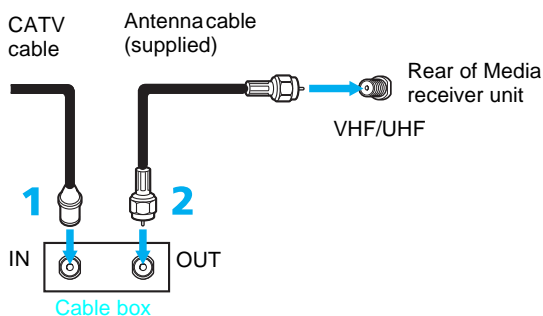

Notes on Using This Connection

To Do This ...	Do This ...
Use the cable box	Tune the TV to the channel the cable box is set to (usually channel 3 or 4) and then use the cable box to switch channels.
Set up the TV remote control to operate the cable box	Program the remote control. See “Programming the Remote Control” on page 52.
Activate the remote control to operate the cable box	Press FUNCTION repeatedly until the SAT/CABLE indicator lights up.
Prevent the accidental switching of TV channels	When using the cable box, you need the TV to stay on the channel the cable box is set to (usually channel 3 or 4). You can use the TV’s Channel Fix feature to lock in a specific channel. For details, see “Using the Channel Menu” on page 103.

 **Do not leave the display indication of the cable box turned on.**

Connecting Optional Equipment

Use the directions in this section to connect the following optional equipment:

<i>If You Are Connecting</i>	<i>See Page</i>
VCR and Cable	31
VCR and Cable Box	33
Two VCRs for Tape Editing	35
Satellite Receiver	37
Satellite Receiver and VCR	39
DVD Player with Component Video Connectors	41
DVD Player with S VIDEO and Audio Connectors	43
Camcorder	44
Audio Receiver	45
Sub Woofer	46
Device with an Optical IN Connector	46

About Using S VIDEO



If the optional equipment you are connecting has an S VIDEO jack (shown at left), you can use an S VIDEO cable for improved picture quality (compared to an A/V cable). Because S VIDEO carries only the video signal, you also need to connect audio cables for sound, as shown below.

Example of an S VIDEO Connection

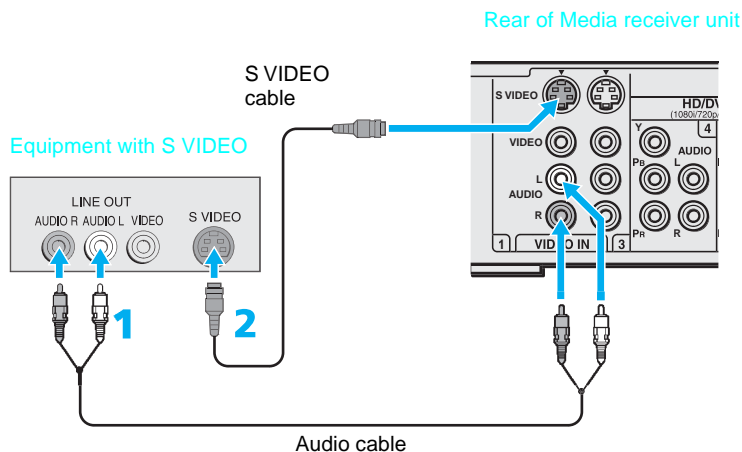

VCR and Cable

For best results, use this connection if:

- Your cable company does not require you to use a cable box.

About Using This Connection with Dual Picture (Twin View, etc.) Features

With this connection, you can use all the dual picture features.

To connect the VCR and cable

- 1 Connect the CATV cable to the VCR's VHF/UHF input jack.
- 2 Use the supplied antenna cable to connect the VCR's VHF/UHF output jack to the TV's CABLE jack.
- 3 Use an A/V cable to connect the VCR's A/V output jacks to the TV's A/V input jacks.
- 4 Run the Auto Setup program, as described in "Setting Up the Channel List" on page 48.

 Using S VIDEO jacks? See page 30.

Rear of Media receiver unit

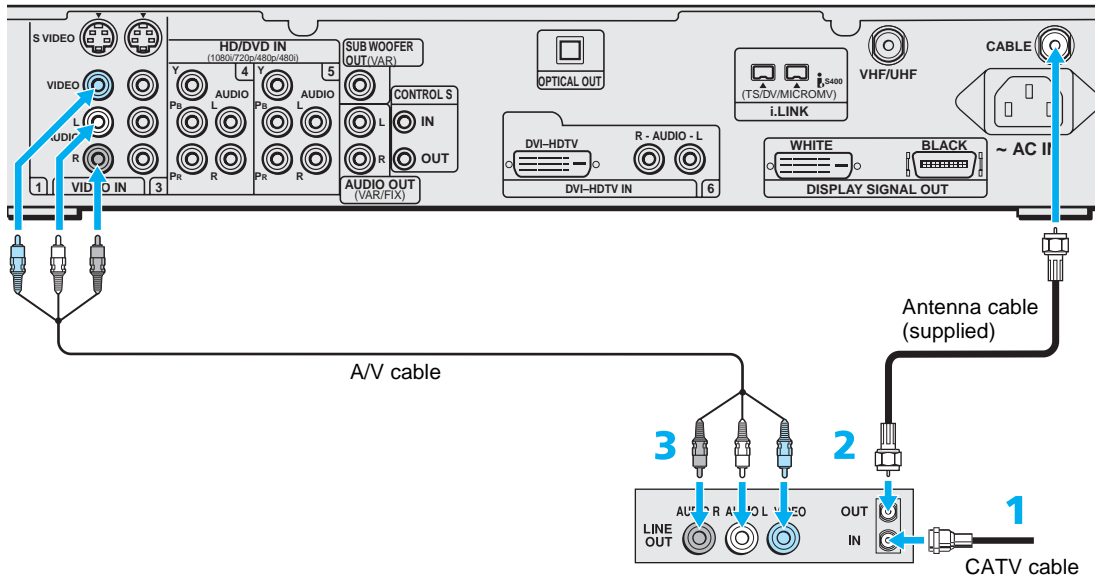

Notes on Using This Connection

To Do This ...	Do This ...
Watch the VCR	Press TV/VIDEO repeatedly to select the VCR input (VIDEO 1 in the illustration).
Watch cable channels	Press TV/VIDEO repeatedly to select the cable input (CABLE in the illustration).
Set up the TV remote control to operate the VCR	If you have a non-Sony VCR, you must program the remote control. See “Programming the Remote Control” on page 52.
Activate the TV remote control to operate the VCR	Press FUNCTION repeatedly until the DVD/VCR indicator lights up.
Control VCR functions with the TV remote control	See “Operating a VCR or D-VHS” on page 55.
Label video inputs to easily identify equipment connected to the TV	See the instructions for setting up Video Labels on page 109.

 **Do not leave the display indication of the VCR turned on.**

VCR and Cable Box

For best results, use this connection if:

- Your cable company scrambles some channels, such as premium channels (which requires you to use a cable box), but does not scramble all channels.

About Using This Connection with Dual Picture (Twin View, etc.) Features

With this connection, you can use all the dual picture features.

With this connection you can:

- Use the TV remote control to change channels coming through the cable box. (You must first program the remote control for your specific cable box; see “Programming the Remote Control” on page 52.)
- Use the TV remote control to change channels coming directly into the TV’s CABLE jack. (The TV’s tuner provides a better signal than the cable box.)
- Record channels coming through the cable box and channels coming directly into the TV.

To connect a VCR and cable box, you need:

- A splitter, which is a small, inexpensive device that you can purchase at your local electronics store.
- Three coaxial cables.
- One A/V cable or one S VIDEO cable with audio cables.

To connect the VCR and cable box

- 1 Connect the CATV cable to the single (input) jack of the splitter.
- 2 Use the supplied antenna cable to connect one of the splitter’s two output jacks to the TV’s CABLE jack.
- 3 Use a coaxial cable to connect the splitter’s other output jack to the cable box’s input jack.
- 4 Use a coaxial cable to connect the cable box’s output jack to the VCR’s RF input jack.
- 5 Use an A/V cable to connect the VCR’s A/V output jacks to the TV’s A/V input jacks.
- 6 Use a coaxial cable to connect the VCR’s RF output jack to the TV’s VHF/UHF jack.
- 7 Run the Auto Setup program, as described in “Setting Up the Channel List” on page 48.

 **Using S VIDEO jacks? See page 30.**

Rear of Media receiver unit

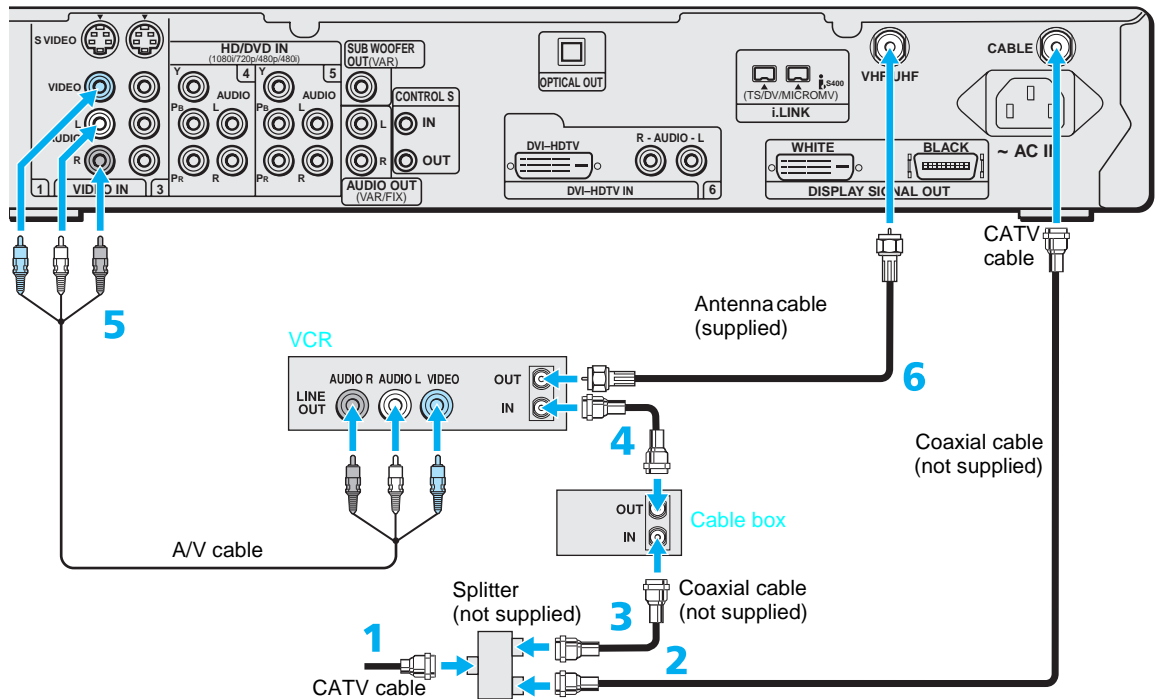

Notes on Using This Connection

To Do This ...	Do This ...
Watch cable (unscrambled) channels	Press TV/VIDEO repeatedly to select the cable input (CABLE in the illustration).
Watch cable box (scrambled) channels	Turn on the VCR and tune it to the channel the cable box is set to (usually channel 3 or 4). Press TV/VIDEO repeatedly to select the VCR input (VIDEO 1 in the illustration). Use the cable box to change channels.
Watch the VCR	Press TV/VIDEO repeatedly to select the VCR input (VIDEO 1 in the illustration).
Set up the TV remote control to operate the cable box or VCR	If you have a non-Sony VCR, you must program the remote control. See “Programming the Remote Control” on page 52.
Activate the remote control to operate the cable box or VCR	For the cable box, press FUNCTION repeatedly until the SAT/CABLE indicator lights up. For the VCR, press FUNCTION repeatedly until the DVD/VCR indicator lights up.
Control specific cable box and VCR functions with the TV remote control	See “Operating a Cable Box” on page 56 and “Operating a VCR or D-VHS” on page 55.
Label video inputs to easily identify equipment connected to the TV	See the instructions for setting up Video Labels on page 109.

 **Do not leave the display indication of the cable box and VCR turned on.**

Two VCRs for Tape Editing

Connecting two VCRs lets you record from one VCR to the other. By connecting them as shown below, you can view (monitor) what is being recorded.

To connect two VCRs for tape editing

- 1 Use an A/V cable to connect the playback VCR's A/V output jacks to the recording VCR's A/V input jacks.
- 2 Use an A/V cable to connect the recording VCR's A/V output jacks to the TV's AUDIO and VIDEO IN jacks.

 **Using S VIDEO jacks? See page 30.**

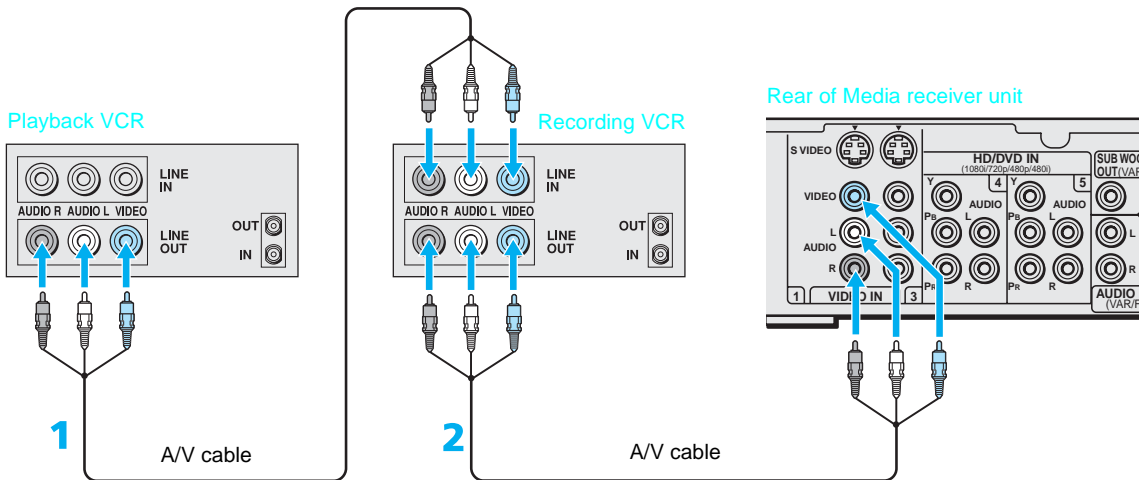

-  **When connecting two VCRs for tape editing;**
- you cannot edit a tape with copy protection.
 - do not connect the TV's A/V input jack and output jack to your VCRs at the same time to avoid looping the signal.

Notes on Using This Connection

To Do This ...	Do This ...
Set up the TV remote control to operate the VCR(s)	If you have a non-Sony VCR, you must program the remote control. See “Programming the Remote Control” on page 52.
Activate the TV remote control to operate the VCR(s)	Press FUNCTION repeatedly until the DVD/VCR indicator lights up.
Control VCR functions with the TV remote control	See “Operating a VCR or D-VHS” on page 55.
Label video inputs to easily identify equipment connected to the TV	See the instructions for setting up Video Labels on page 109.

Satellite Receiver

To connect a satellite receiver

- 1 Connect the satellite antenna cable to the satellite receiver's satellite input jack.
- 2 Use an A/V cable to connect the satellite receiver's A/V output jacks to the TV's A/V input jacks.
- 3 Connect the supplied antenna cable from your cable or antenna to the TV's CABLE or VHF/UHF jack.
- 4 Run the Auto Setup program, as described in "Setting Up the Channel List" on page 48.

 Using S VIDEO jacks? See page 30.

Rear of Media receiver unit

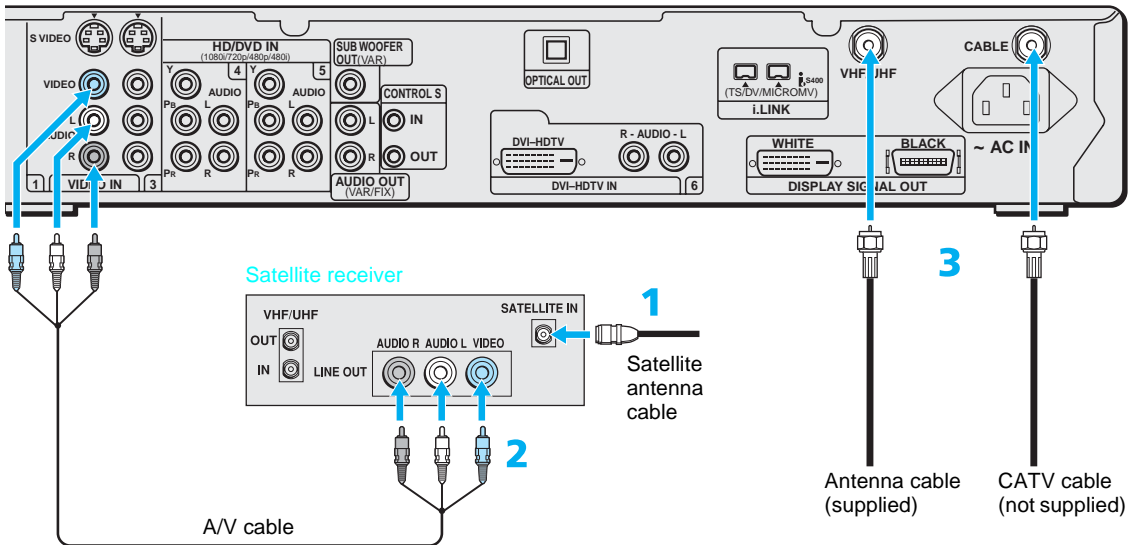

Notes on Using This Connection

To Do This ...	Do This ...
Watch the satellite receiver	Press TV/VIDEO repeatedly to select the satellite receiver input (VIDEO 1 in the illustration).
Set up the TV remote control to operate the satellite receiver	If you have a non-Sony satellite receiver, you must program the remote control. See “Programming the Remote Control” on page 52.
Activate the TV remote control to operate the satellite receiver	Press FUNCTION repeatedly until the SAT/CABLE indicator lights up.
Control satellite receiver functions with the TV remote control	See “Operating a Satellite Receiver” on page 55.
Label video inputs to easily identify equipment connected to the TV	See the instructions for setting up Video Labels on page 109.

 **Do not leave the Electric Program Guide and display indication turned on.**

Satellite Receiver and VCR

To connect a satellite receiver and VCR

- 1 Connect the satellite antenna cable to the satellite receiver's satellite input jack.
- 2 Connect the CATV cable to the VCR's VHF/UHF input jack.
- 3 Use the supplied antenna cable to connect the VCR's VHF/UHF output jack to the TV's CABLE jack.
- 4 Use an A/V cable to connect the satellite receiver's A/V output jacks to the VCR's A/V input jacks.
- 5 Use an A/V cable to connect the VCR's A/V output jacks to the TV's A/V input jacks.
- 6 Run the Auto Setup program, as described in "Setting Up the Channel List" on page 48.

 Using S VIDEO jacks? See page 30.

Rear of Media receiver unit

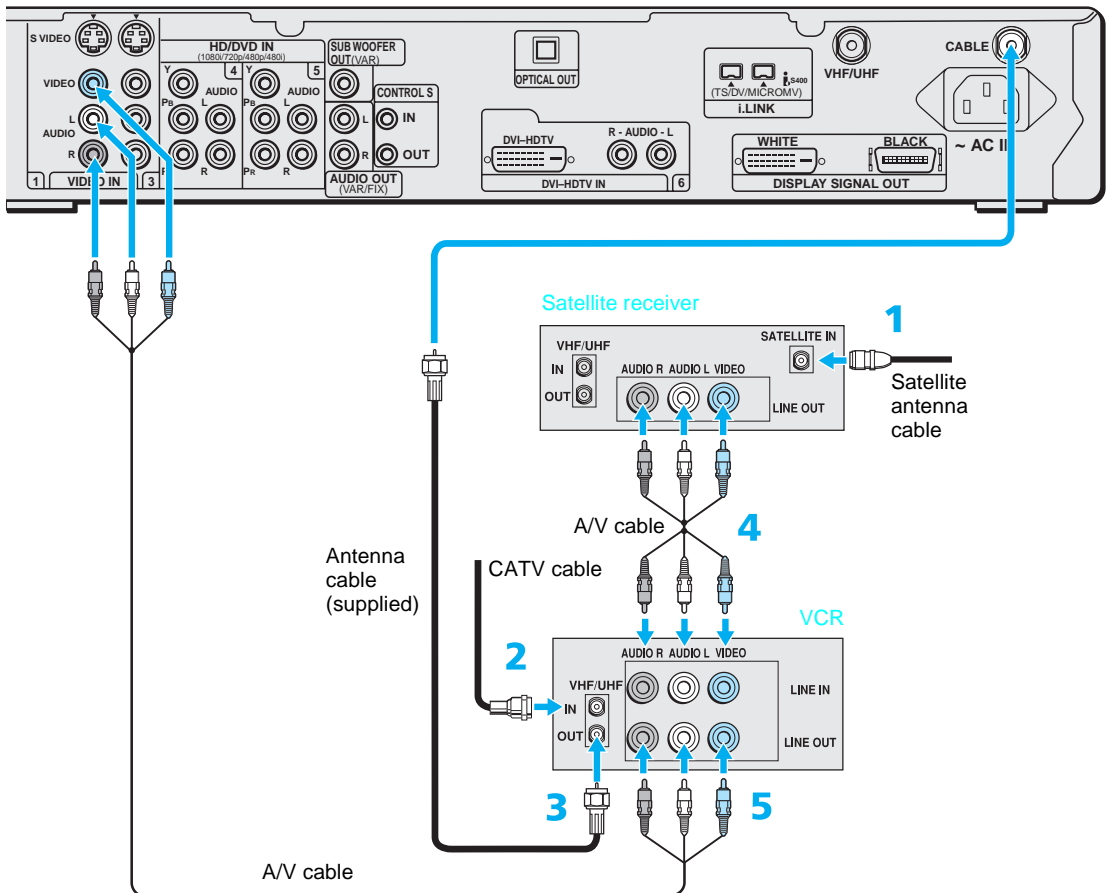

Notes on Using This Connection

To Do This ...	Do This ...
Watch the satellite receiver	Press TV/VIDEO repeatedly to select the VCR input (VIDEO 1 in the illustration). The VCR may need to be turned on and set to the satellite receiver input.
Watch the VCR	Press TV/VIDEO repeatedly to select the input to which the VCR is connected (VIDEO 1 in the illustration).
Set up the TV remote control to operate the satellite receiver or VCR	If you have a non-Sony VCR or satellite receiver, you must program the remote control. See “Programming the Remote Control” on page 52.
Activate the TV remote control to operate the satellite receiver or VCR	For the satellite receiver, press FUNCTION repeatedly until the SAT/CABLE indicator lights up. For the VCR, press FUNCTION repeatedly until the DVD/VCR indicator lights up.
Control satellite receiver and VCR functions with the TV remote control	See “Operating a Satellite Receiver” on page 55 and “Operating a VCR or D-VHS” on page 55.
Label video inputs to easily identify equipment connected to the TV	See the instructions for setting up Video Labels on page 109.

 **Do not leave the Electric Program Guide and display indication turned on.**

DVD Player with Component Video Connectors

For best results, use this connection if your DVD player has component video (Y, PB, PR) jacks.

To connect a DVD player with component video connectors

- 1 Use three separate component video cables to connect the DVD player's Y, PB and PR jacks to the Y, PB and PR jacks (VIDEO 4 or 5) on the TV.
 **The Y, PB and PR jacks on your DVD player are sometimes labeled Y, CB and CR, or Y, B-Y and R-Y. If so, connect the cables to their matching color jacks.**
- 2 Use an audio cable to connect the DVD player's audio output jacks to the TV's VIDEO 4 or 5 audio input jacks.

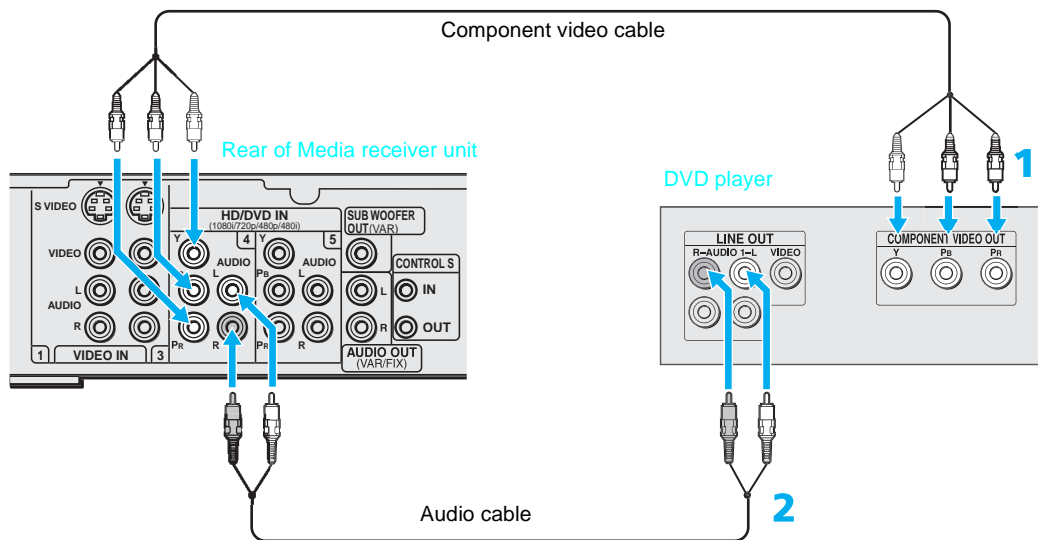

Notes on Using This Connection

To Do This ...	Do This ...
Watch the DVD player	Press TV/VIDEO repeatedly to select the DVD input (VIDEO 4 in the illustration).
Set up the TV remote control to operate the DVD player	If you have a non-Sony DVD player, you must program the remote control. See “Programming the Remote Control” on page 52.
Activate the TV remote control to operate the DVD player	Press FUNCTION repeatedly until the DVD/VCR indicator lights up.
Control DVD functions with the TV remote control	See “Operating a DVD Player” on page 56.
Label video inputs to easily identify equipment connected to the TV	See the instructions for setting up Video Labels on page 109.



You cannot record the signal from any equipment connected into the Y, PB, PR jacks.

Do not leave a still image, such as the DVD menu, displayed on the screen.

DVD Player with S VIDEO and Audio Connectors

Use this connection if your DVD player does not have component video (Y, Pb, Pr) jacks.

To connect a DVD player with A/V connectors

- 1 Use an audio cable to connect the DVD player's audio output jacks to the TV's audio input jacks.
- 2 Use an S VIDEO cable to connect the DVD player's S VIDEO jack to the TV's S VIDEO jack.

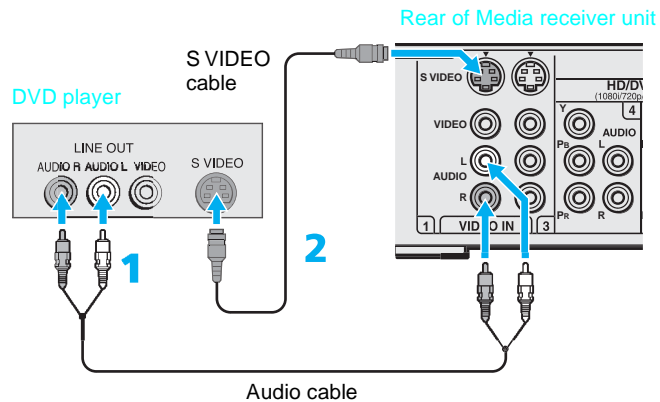

Notes on Using This Connection

To Do This ...	Do This ...
Watch the DVD player	Press TV/VIDEO repeatedly to select the DVD input (VIDEO 1 in the illustration).
Set up the TV remote control to operate the DVD player	If you have a non-Sony DVD player, you must program the remote control. See "Programming the Remote Control" on page 52.
Activate the TV remote control to operate the DVD player	Press FUNCTION repeatedly until the DVD/VCR indicator lights up.
Control DVD functions with the TV remote control	See "Operating a DVD Player" on page 56.
Label video inputs to easily identify equipment connected to the TV	See the instructions for setting up Video Labels on page 109.

 **Do not leave a still image, such as the DVD menu, displayed on the screen.**

Camcorder

For easy connection of a camcorder, the TV has front A/V input jacks. If you prefer, however, you can connect the camcorder to the TV's rear A/V input jacks.

To connect a camcorder

Use an A/V cable to connect the camcorder's A/V output jacks to the TV's A/V input jacks.

 **Using S VIDEO jacks? See page 30.**

Front of the Media receiver unit

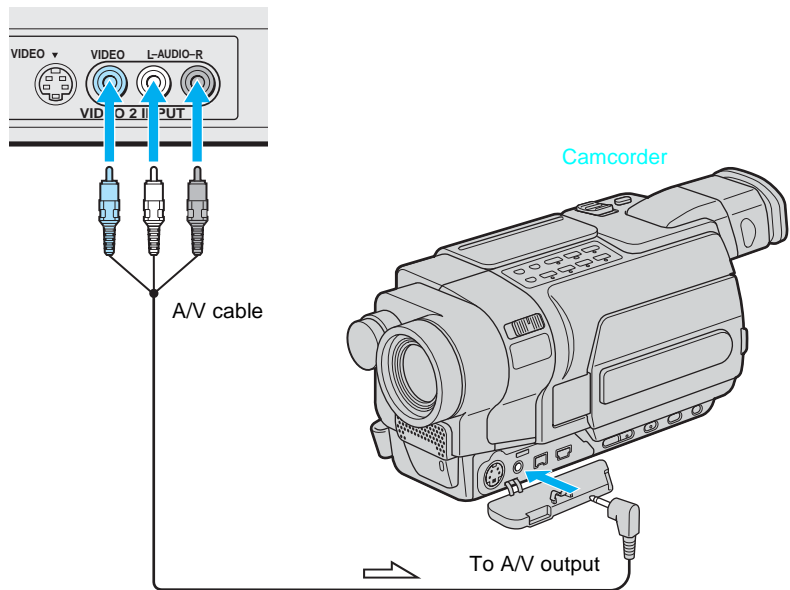

Notes on Using This Connection

To Do This ...	Do This ...
Watch the camcorder	Press TV/VIDEO repeatedly to select the camcorder input (VIDEO 2 in the illustration).
Label video inputs to easily identify equipment connected to the TV	See the instructions for setting up Video Labels on page 109.

 **Do not leave a still image of the camcorder or digital camera displayed on the screen.**

Audio Receiver

For improved sound quality, you may want to play the TV's audio through your stereo system.

To connect an audio system

- 1 Use an audio cable to connect the TV's audio output jacks to the audio receiver's line input jacks.

Rear of Media receiver unit

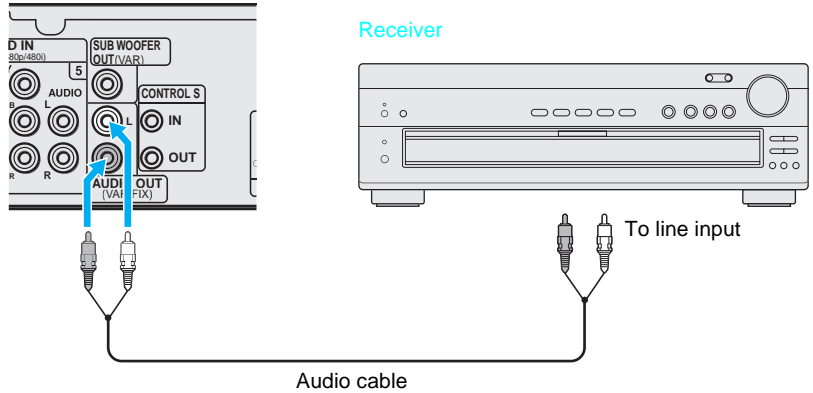

- 2 Using the TV's Audio Menu, set the **Speaker** option to **Off**. Then set the **Audio Out** option to **Fixed** or **Variable**, depending on how you want to control the volume. For details, see "Using the Audio Menu" on page 99.
- 3 Turn on the audio receiver, and then set the receiver's line input to the jack into which you connected the TV.

Sub Woofer

Use a monaural audio cable to connect the TV's SUB WOOFER OUT jack to the sub woofer's input jack.

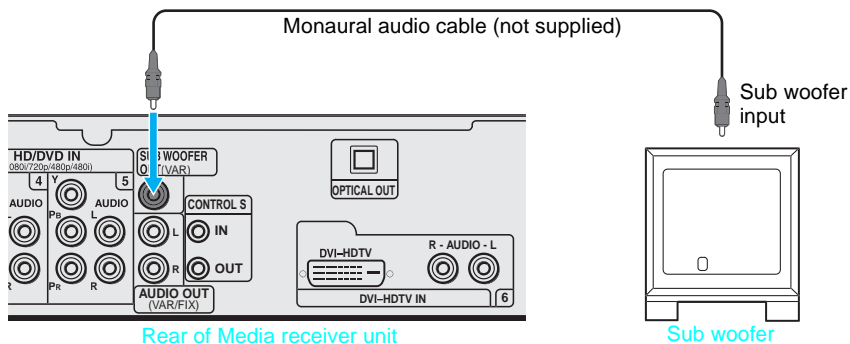

Device with an Optical IN Connector

You can use the TV's DIGITAL AUDIO (OPTICAL) OUT jack to connect a digital audio device that is PCM/Dolby Digital compatible, such as an audio amplifier.

- Using an optical cable, connect the device's OPTICAL IN jack to the TV's DIGITAL AUDIO (OPTICAL) OUT jack.

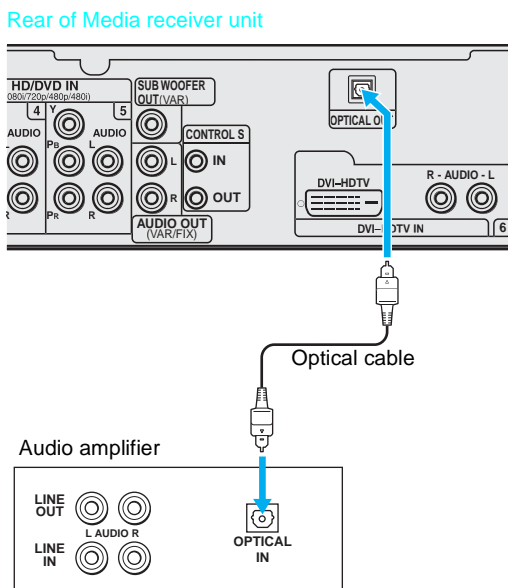

Using the **CONTROL S Feature**

CONTROL S allows you to control your system and other Sony equipment with one remote control. In addition to allowing you to control multiple devices with one remote control, the CONTROL S feature allows you to always point your remote control at your TV, instead of having to point it at the other equipment, which might be hidden or out of direct line of sight.

Use CONTROL S IN to send signals to the TV.

Use CONTROL S OUT to send signals to connected equipment.

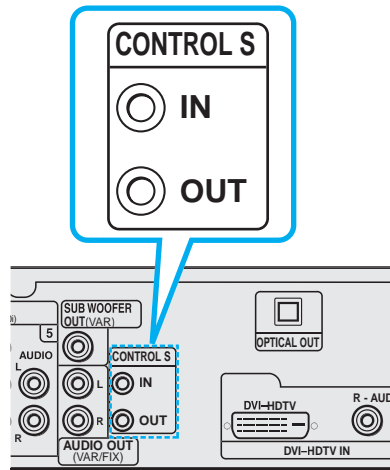

Rear of Media receiver unit

Setting Up the Channel List

After you finish connecting your TV, you need to run Auto Setup, which automatically set up available analog and digital channels. The Auto Program screen appears when you turn on your TV for the first time after hooking it up. If you do not want to set up the channels at this time, you can do it later by selecting the Auto Program option in the Channel Menu (see page 103).

 **The Auto Setup feature does not apply for installations that use a cable box for all channel selection.**

Using Auto Setup

To run Auto Setup the first time you turn on your TV

- 1 Press **POWER** to turn on the TV.
The Initial Setup screen appears.
- 2 Press **▲** or **▼** to select the on-screen display language. Then press **ENTER**.
The message “Start auto program now?” appears.
- 3 Press **▲** or **▼** to select “Yes”, then press **ENTER**.

Auto Setup automatically creates a list of receivable channels. When finished, the lowest numbered channel is displayed.

To run Auto Setup again at a later time

- Use the Auto Program feature as described on page 103.

To add individual digital channels

- Use the Digital Channel feature as described on page 70.

 **Auto Program may take up to 30 minutes to complete. A progress bar is displayed while the channel list is being created.**

Using the Remote Control

Overview

This chapter describes how to set up, program, and use the TV's remote control.

Topic	Page
Inserting Batteries	49
Button Descriptions	50
Programming the Remote Control	52
Using Other Equipment with Your TV Remote Control	55

Inserting Batteries

- 1 Open the battery compartment as illustrated below.
- 2 Insert two size AA batteries (supplied) by matching the \oplus and \ominus terminals on the batteries to the diagram inside the battery compartment.
- 3 Close the battery compartment.

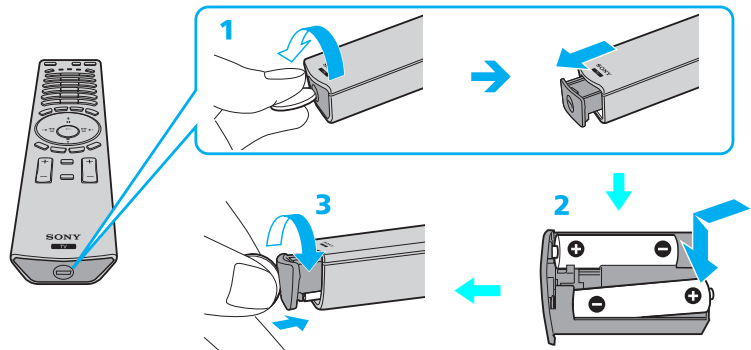

-  **Remove the batteries to avoid damage from possible battery leakage whenever you anticipate that the remote control will not be used for an extended period. Handle the remote control with care. Avoid dropping it, getting it wet, placing it in direct sunlight, near a heater, or where the humidity is high.**

Button Descriptions

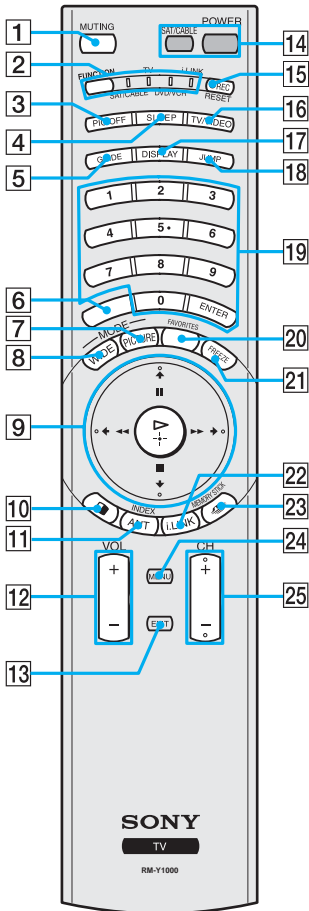

Button	Description
1 MUTING	Press to mute the sound. Press again or press VOL+ to restore the sound.
2 FUNCTION button and indicators	Press to have the remote control operate the equipment you want. Press repeatedly until the indicator of the desired equipment lights up. For details, see “Programming the Remote Control” on page 52.
3 PIC OFF	Press to have the TV screen turn off. For details, see page 65.
4 SLEEP	Press repeatedly until the TV displays the time in minutes (15, 30, 45, 60 or 90) that you want the TV to remain on before shutting off. To cancel Sleep Timer, press SLEEP repeatedly until SLEEP OFF appears.
5 GUIDE If FUNCTION is switched on SAT/CABLE GUIDE*	Press to display the digital program guide. Press to display the program guide of your satellite program provider.
6	Use with 0-9 and ENTER buttons to select digital channels (for example, 2.1). For details on selecting digital channels, see page 68.
7 PICTURE	Press repeatedly to cycle through the available video picture modes: Vivid , Standard , Pro . Also available in the Video Menu. For details, see “Selecting Video Options” on page 96.
8 WIDE	Press repeatedly to step through the Wide Mode settings: Wide Zoom , Normal , Full , Zoom . Also available in the Screen menu. For details, see pages 59 and 101.
9	Press ↑ ↓ ← → to move the on-screen cursor. To select an item, press ⊙ .
If FUNCTION is switched on SAT/CABLE , DVD/VCR or i.LINK	
Transport Buttons	<ul style="list-style-type: none"> Rewind Play Stop Fast forward Pause
10 (Twin View)	Press to turn on and off Twin View. For details, see page 60.
11 ANT	Press to switch between the sources connected to the TV’s VHF/UHF and CABLE inputs. If FUNCTION is switched on SAT/CABLE INDEX*
12 VOL +/-	Press to adjust the volume.
13 EXIT	Press to exit the on-screen menu or display and return to normal viewing.

Button	Description
14 Power Buttons	SAT/CABLE* : Press to turn on and off the satellite receiver, cable box, and other audio/video equipment you have programmed into the remote control. For instructions, see “Programming the Remote Control” on page 52. POWER : Press to turn on and off the TV.
15 RESET	Press to reset the settings to the factory defaults. See pages 96 and 99. Also used to clear Favorite Channels (see page 63). If FUNCTION is switched on DVD/VCR ● REC Press to record a program.
16 TV/VIDEO	Press repeatedly to cycle through the video equipment connected to the TV’s video inputs.
17 DISPLAY	Press once to display the current channel number, current time, and channel label. If set, the current channel number will display for 10 seconds.
18 JUMP	Press to jump back and forth between two channels. The TV alternates between the current channel and the last channel that was selected.
19 0 - 9 ENTER	Press 0 - 9 to select a channel; the channel changes after 3 seconds. Press ENTER to change channels immediately.
20 FAVORITES	Press to display the Favorite Channels list. For details, see page 63.
21 FREEZE	Press to freeze the picture. Press again to restore the picture. For details, see “Using the Freeze Function” on page 64.
22 i.LINK	Press to display the i.LINK Control Panel. For information on using the i.LINK Control Panel, see page 91.
23  MEMORY STICK	Press to display the Memory Stick Menu. For details, see “Using the Memory Stick Viewer” on page 71.
24 MENU	Press to display the Menu. Press again to exit from the Menu. For details, see page 95.
25 CH +/-	Press to scan through channels. To scan quickly through channels, press and hold down either CH .

* If not Sony brand, requires that you first program the remote control (page 52).

Programming the Remote Control

The remote control is preset to operate Sony brand video equipment.

Sony Equipment	Programmable Code Number
Beta, ED Beta VCRs	303
8 mm VCR	302
VHS VCR	301
DVD player	751
i.LINK	901

If you have video equipment other than Sony brand that you want to control with the TV's remote control, use the following procedure to program the remote control.

 **The equipment must have infrared (IR) remote capability in order to be used with the remote control.**

- 1 Turn to the list of "Manufacturer's Codes" on page 53, and find the three-digit code number for the manufacturer of your equipment. (If more than one code number is listed, use the number listed first.)
- 2 Press **FUNCTION** repeatedly until the DVD/VCR, SAT/CABLE or i.LINK indicator lights up.
- 3 Press **SAT/CABLE** for five seconds until the indicator of the selected input flashes.
- 4 While the desired indicator is flashing, enter the three-digit manufacturer's code number.
- 5 Press **ENTER**.
 **You must do step 5 within 10 seconds of step 4, or you must redo steps 4 through 5.**
- 6 To check if the code number works, aim the TV's remote control at the equipment and press **POWER** that corresponds with that equipment. If it responds, you are done. If not, try using another code listed for that manufacturer.

Notes

- If more than one code number is listed, try entering them one by one until you come to the correct code for your equipment.
- If you enter a new code number, the code number you previously entered at that setting is erased.
- In some cases, you may not be able to operate your equipment with the supplied remote control. In such cases, use the equipment's own remote control unit.
- Whenever you remove the batteries to replace them, the code numbers may revert to the factory setting and must be reset.

Manufacturer's Codes

VCRs

<i>Manufacturer</i>	<i>Code</i>
Sony	301, 302, 303
Admiral (M. Ward)	327
Aiwa	338, 344
Audio Dynamic	314, 337
Broksonic	319, 317
Canon	309, 308
Citizen	332
Craig	302, 332
Criterion	315
Curtis Mathes	304, 338, 309
Daewoo	341, 312, 309
DBX	314, 336, 337
Dimensia	304
Emerson	319, 320, 316, 317, 318, 341
Fisher	330, 335
Funai	338
General Electric	329, 304, 309
Go Video	322, 339, 340
Goldstar	332
Hitachi	306, 304, 305, 338
Instant Replay	309, 308
JC Penney	309, 305, 304, 330, 314, 336, 337
JVC	314, 336, 337, 345, 346, 347
Kenwood	314, 336, 332, 337
LG	332
LXI (Sears)	332, 305, 330, 335, 338
Magnavox	308, 309, 310
Marantz	314, 336, 337
Marta	332
Memorex	309, 335
Minolta	305, 304
Mitsubishi/ MGA	323, 324, 325, 326
Multitech	325, 338, 321
NEC	314, 336, 337

<i>Manufacturer</i>	<i>Code</i>
Olympic	309, 308
Optimus	327
Orion	317
Panasonic	308, 309, 306, 307
Pentax	305, 304
Philco	308, 309
Philips	308, 309, 310
Pioneer	308
Quasar	308, 309, 306
RCA/ PROSCAN	304, 305, 308, 309, 311, 312, 313, 310, 329
Realistic	309, 330, 328, 335, 324, 338
Sansui	314
Samsung	322, 313, 321
Sanyo	330, 335
Scott	312, 313, 321, 335, 323, 324, 325, 326
Sharp	327, 328
Signature 2000 (M. Ward)	338, 327
SV2000	338
Sylvania	308, 309, 338, 310
Symphonic	338
Tashiro	332
Tatung	314, 336, 337
Teac	314, 336, 338, 337
Technics	309, 308
Toshiba	312, 311
Wards	327, 328, 335, 331, 332
Yamaha	314, 330, 336, 337
Zenith	331

Laserdisc Players

<i>Manufacturer</i>	<i>Code</i>
Sony	701
Panasonic	704, 710
Pioneer	702

DVD Players

<i>Manufacturer</i>	<i>Code</i>
Sony	751
Sony (i.LINK)	901
APEX	762
General Electric	755
Hitachi	758
JVC	756
Magnavox	757
Mitsubishi	761
Oritron	759
Panasonic	753
Philips	757
Pioneer	752
RCA/Proscan	755
Samsung	758
Toshiba	754
Zenith	760

AV Receiver*¹

<i>Manufacturer</i>	<i>Code</i>
Sony	651

5.1 DVD AV System (DAV)*²

<i>Manufacturer</i>	<i>Code</i>
Sony	601

Cable Boxes

<i>Manufacturer</i>	<i>Code</i>
Sony	230
Hamlin/Regal	222, 223, 224, 225, 226
Jerrold/G. I.	201, 202, 203, 204, 205, 206, 207, 208, 218
Oak	227, 228, 229
Panasonic	219, 220, 221
Pioneer	214, 215
Scientific Atlanta	209, 210, 211
Tocom	216, 217
Zenith	212, 213

Satellite Receivers

<i>Manufacturer</i>	<i>Code</i>
Sony	801
Dish Network	810
Echostar	810
General Electric	802
Hitachi	805
Hughes	804
Mitsubishi	809
Panasonic	803
RCA/ PROSCAN	802, 808
Toshiba	806, 807

*1 This manufacturer code might not work for some models. The following FY03 STR & AVD models are capable of functioning with this code.

STR-DA9000ES/
STR-DA5000ES/
STR-DA3000ES/
STR-DA2000ES/
STR-DA1000ES/
STR-DE995/STR-DE895/
STR-DE695/STR-DE595/
HT-C800DP/AVD-S500ES/
AVD-S700ES

*2 This manufacturer code might not work for some models. The following FY03 DAV models are capable of functioning with this code.







DAV-FC7/DAV-FC8/DAV-FC9

Using Other Equipment with Your TV Remote Control





All Equipment

To Do This ...	Do This ...
Switch the TV's input to the VCR, DVD player, or other connected equipment	Press TV/VIDEO repeatedly to cycle through the video equipment connected to the TV's video inputs.
Set up the TV remote control to operate non-Sony equipment	You must program the remote control the first time you use it. See "Programming the Remote Control" on page 52.

Operating a VCR or D-VHS

To Do This ...	Press
Activate the remote control to operate the VCR	FUNCTION repeatedly until the DVD/VCR or i.LINK indicator lights up.
Turn on/off	SAT/CABLE
Change channels	CH +/-
Record	● REC
Play	
Stop	
Fast forward	
Rewind the tape	
Pause	
Search the picture forward or backward	 or  during playback (release to resume normal playback)





Operating a Satellite Receiver

To Do This ...	Press
Activate the remote control to operate the satellite receiver	FUNCTION repeatedly until the SAT/CABLE indicator lights up.
Turn on/off	SAT/CABLE
Select a channel	0-9, ENTER
Change channels	CH +/-
Back to previous channel	JUMP
Display channel number	DISPLAY
Display SAT Guide	GUIDE
Display SAT Index	INDEX
Display SAT Menu	MENU
Move highlight (cursor)	   
Select item	





Operating a Cable Box

To Do This ...	Press
Activate the remote control to operate the cable box	FUNCTION repeatedly until the SAT/CABLE indicator lights up.
Turn on/off	SAT/CABLE
Select a channel	0-9, ENTER
Change channels	CH +/-
Back to previous channel	JUMP

Operating a DVD Player

To Do This ...	Press
Activate the remote control to operate the DVD	FUNCTION repeatedly until the DVD/VCR indicator lights up.
Turn on/off	SAT/CABLE
Play	
Stop	
Pause	
Step through different tracks of the disc	 to step forward or  to step backward
Step through different chapters of a video disc	CH+ to step forward or CH- to step backward

Operating an MDP (Laserdisc Player)

To Do This ...	Press
Activate the remote control to operate the MDP	FUNCTION repeatedly until the indicator of the position you programmed for the MDP player lights up.
Turn on/off	SAT/CABLE
Play	
Stop	
Pause	
Search the picture forward or backward	 or  during playback (release to resume normal playback)
Search a chapter forward or backward	CH +/-

Using the Features



Overview

This chapter describes how to use the features of your TV.

<i>Topic</i>	<i>Page</i>
Watching TV	58
Using Wide Mode	59
Using Twin View	60
Using Favorite Channels	63
Using the Freeze Function	64
Using Picture Off	65

Watching TV

 For a complete list of all the functions of the remote control, see page 50.

To Do This ...	Do This ...
Activate the remote control to operate the TV	Press FUNCTION repeatedly until the TV indicator lights up.
Turn on/off the TV	Press POWER
Tune directly to a channel	To tune to analog channels, press 0-9 and then ENTER (or wait 3 seconds). For digital subchannels, press 0-9 ,  , press 0-9 again, and then ENTER . For example, to select subchannel 2.1, press 2 ,  , 1 , and then press ENTER .
	 You can also select digital channels using the digital program guide. See page 67 for details.
Adjust the volume	Press VOL +/-
Mute the volume	Press MUTING (press again to unmute)
Alternate back and forth between two channels	Press JUMP The TV alternates between the current channel and the last channel tuned.
Display the current channel number (and other information)	Press DISPLAY once to display the channel number, current time, wide mode, and channel label (if set). Press DISPLAY again to turn Display off.
Switch the TV's input to the VCR, DVD player, or other connected equipment	Press TV/VIDEO repeatedly to cycle through the video equipment connected to the TV's video inputs.
Change video and audio options, customize the TV's setup, set parental controls, and more	Press MENU to display the Menu. For details, see "Using the Menus" on page 95.
Switch the TV's input between sources connected to the TV's VHF/UHF and CABLE inputs	Press ANT to alternate between sources connected to the TV's VHF/UHF and CABLE inputs.
Switch the TV's input to a connected i.LINK device	Press i.LINK to display a list of a available i.LINK devices, and select the desired device from the list. See page 90 for details.

Using Wide Mode

Wide Screen mode lets you watch 4:3 normal broadcasts in several Wide Screen modes (16:9 aspect ratio).

💡 Wide Zoom is recommended for 4:3 picture to prevent image retention.

💡 You can also access the Wide Mode settings in the Screen menu. For details, see page 101.

💡 When you change channels or inputs, the Wide Mode settings revert to the **4:3 Default** setting in the Screen menu. To retain the current Wide Mode setting as channels and inputs are changed, set **4:3 Default** to **Off**. For details, see page 102.

📌 **When viewing high-definition programs broadcast in 720p/1080i, it is not possible to change between Wide Screen modes.**

- ❑ Press **WIDE** repeatedly to toggle through the following Wide Mode settings.

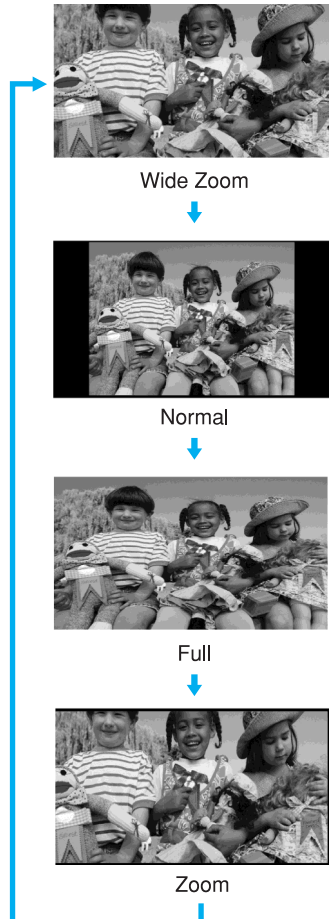

Wide Zoom enlarges the 4:3 picture, while the upper and lower parts of the picture are condensed to fit the 16:9 screen. The picture has a normal appearance, as much as possible.

Normal returns the 4:3 picture to its original size. Black bars are visible at left and right sides to fill the 16:9 screen.

Full Mode stretches the 4:3 picture horizontally only, to fill the 16:9 screen. The picture has an elongated appearance.

Zoom Mode enlarges the 4:3 picture horizontally and vertically to an equal aspect ratio that fills the 16:9 screen. Useful for watching Letterbox movies.

Using Twin View

Twin View lets you see two pictures from two sources — from an antenna, VCR, DVD, etc. — on the screen at the same time. You hear the sound from only one of the sources at a time, but you can choose which source's sound is selected. You can also change the relative size of each of the pictures.

 **Using Twin View for an extended period of time may result in image retention.**



Displaying Twin Pictures

- 1 Tune the TV to a working channel.
- 2 Press .

A second picture appears.



To cancel Twin View and watch the active picture

- Press  or .

Factors Affecting Twin View

- If you use a cable box, you can view the cable box output in one window and view a different source (such as a VCR or DVD player) in the second window by using **TV/VIDEO**. For details, see “Connecting Optional Equipment” on page 30.
- Digital TV channels, as well as any sources connected to the VIDEO 4, VIDEO 5, and VIDEO 6 inputs, display in the left window, but not the right.
- If you are viewing a 4:3 source and a 16:9 enhanced source (such as a DVD) side by side, the 4:3 source appears larger.
- Twin View does not display channels that are blocked by parental settings (see page 105).

Activating the Picture

To activate the picture in the right window

□ Press →.

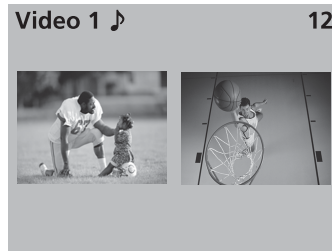

To activate the picture in the left window

□ Press ←.

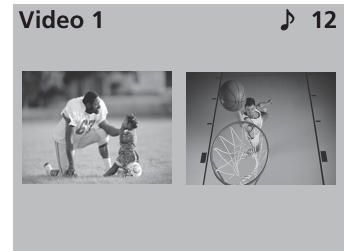

Functions Available in the Active Window

To Do This ...	Do This ...
Tune to a channel	Press 0-9 and then ENTER (or wait 3 seconds) or Press CH+/-
Adjust the volume	Press VOL +/-
Mute the volume	Press MUTING (press again to unmute)
Switch the TV's input between sources connected to the TV's VHF/UHF and CABLE inputs	Press ANT
Switch the TV's input between sources connected to the TV's A/V inputs	Press TV/VIDEO
Change the picture size	Press ↕ or ↴. (For details, see "Changing the Picture Size" on page 62.)

Changing the Picture Size

The zoom feature lets you vary the relative size of the left and right pictures.

- 1 Press ◀ or ▶ to activate the picture that you want to resize.
- 2 Press ▲ to enlarge the picture.
- 3 Press ▼ to make the picture smaller.

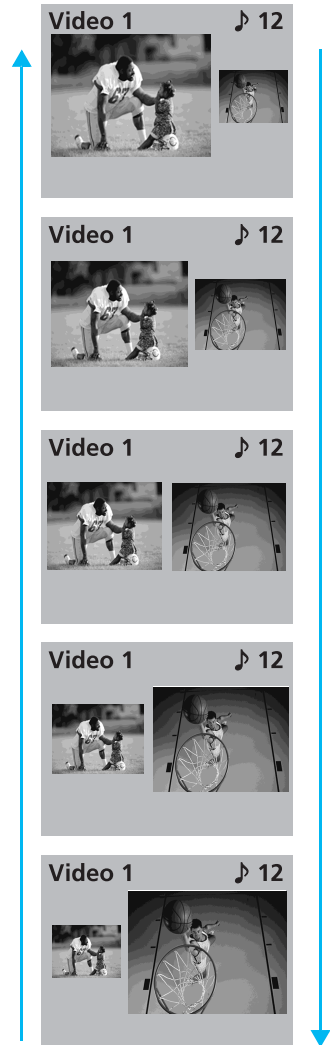







When you adjust the picture sizes, the TV memorizes the change. The next time you use the Twin View function, the memorized sizes appear.

Using Favorite Channels

The Favorite Channels feature lets you select programs from a list of up to 16 favorite channels that you specify.

Creating a List of Favorite Channels

 For details on using the Channel Menu, see page 103.

- 1 Press **MENU** to display the Menu.
- 2 Press **←** or **→** to highlight the Channel icon and press .
- 3 Press  to select **Favorite Channels**.
- 4 Press  to select **Program**.
- 5 Press **↑** or **↓** to highlight a Favorite Channel number (1-16) and press .
- 6 Press **↑** or **↓** to highlight a channel you want to assign to the Favorite Channel number. A preview of the highlighted channel appears in the upper right of the screen. Press  to select that channel as a Favorite Channel.

 **Digital channels are displayed as a black box in the preview window.**
- 7 To add more channels to your favorites list, repeat steps 5-6.

To clear a Favorite Channel, press **↑** or **↓** to highlight the channel you want to clear. Press  and then press **RESET**.
- 8 Press **MENU** to exit the Menu.

Displaying a List of Favorite Channels

 To assign Channel Labels (e.g., ABC, HBO, MTV, etc.) to channel numbers, as shown at right, use the Channel Label feature in the Channel Menu (see page 104).

- 1 Press **FAVORITES**. The Favorite Channels list appears.

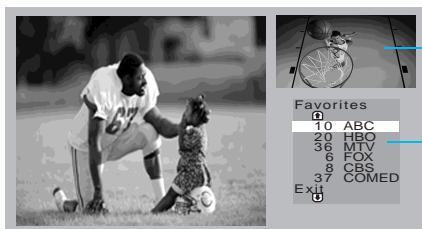

- 2 Press **↑** or **↓** to highlight the channel you want to watch. A preview of the highlighted Favorite Channel appears.
- 3 Press  to select the channel you want to watch. The Favorite Channels list disappears after 90 seconds if you do not operate the TV.

Using the Freeze Function

FREEZE allows you to temporarily capture a program's picture. You can use this feature to write down information such as phone numbers, recipes, etc.

 **The Freeze feature is not available while you are using the Twin View feature.**

- 1 When the program information you want to capture is displayed, press **FREEZE**.
- 2 The TV switches to Twin View mode and displays the “frozen” picture on the right, while the current program continues on the left.

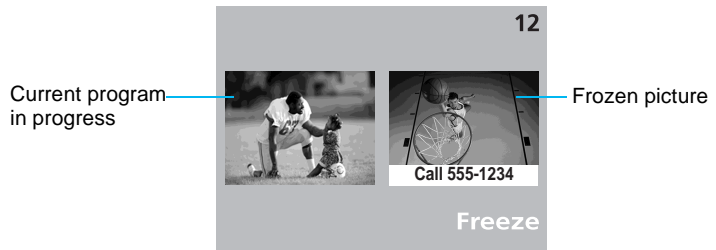

- 3 To cancel and return to normal viewing, press **FREEZE** (or just tune to another channel).

The “frozen” picture disappears automatically after 5 minutes.

Using Picture Off

The Picture Off feature lets you enjoy music from radio programs of digital broadcasts or DVDs with the TV screen turned off.

 **This feature turns off the display unit only.**

1 Press **PIC OFF**.

The PICTURE OFF LED lights up in blue and the screen turns off.

To cancel and return to normal viewing, press any button except for **VOL +/-**, **POWER** and **MUTING**.

Using the Digital Program Guide

Displaying the Digital Program Guide

This TV is equipped to show digital programming, if a digital signal is present. The digital program guide and menus let you review program information, select digital channels and subchannels, set up your TV's digital programming, and enable digital closed captioning.

 **Analog channels are not available in this guide.**

To display the digital program guide:

- 1 Tune your TV to a digital channel by using the **0-9**, , and **ENTER** buttons.
- 2 Press **GUIDE** on the TV's remote control. The digital program guide appears, with the currently selected program showing in the background.

 The digital program guide and menus are not available while using multipicture functions (Twin View, Freeze, i.LINK, Memory Stick, or Favorite Channels).

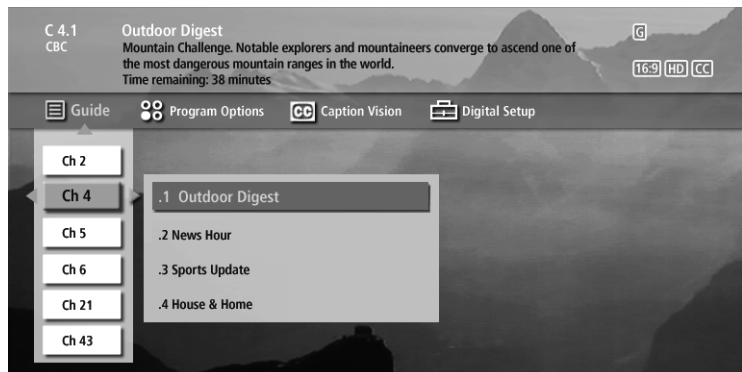

 **Program information in the guide is provided by the broadcasters. As a result, it may sometimes include only the channel number, without a program title or description.**

Navigating the Digital Program Menus

Four digital menus are available on the digital program guide.

Digital Program Menu	See Page
Using the Guide Menu	68
Using the Program Options Menu	69
Using the Caption Vision Menu	69
Using the Digital Setup Menu	70

To navigate to these menus and through the available options:

- 1 Press **↑ ↓ ← →** to navigate through the options.
- 2 Press **Ⓐ** to select the desired option.

Using the Guide Menu

The Guide menu allows you to select digital channels and subchannels from a dropdown list. This list also provides information about the current program being shown on each digital channel.

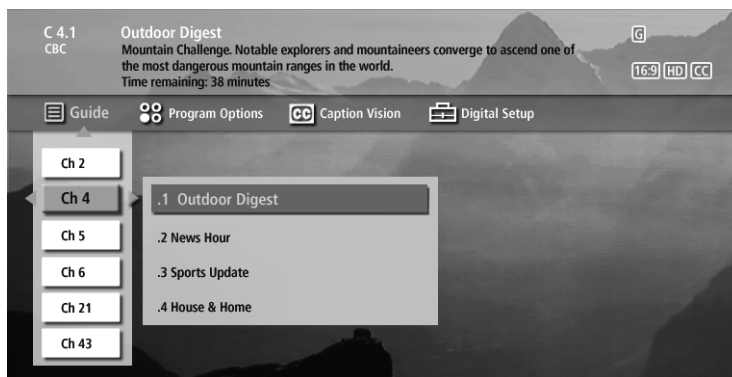

-  **Subchannels are additional channels of programming broadcast simultaneously. For example, channel 4 might include three subchannels (4.1, 4.2, 4.3) that are showing programs at the same time.**

Using the Program Options Menu

The Program Options menu allows you to customize the settings of the program on the currently tuned channel.

Option	Description
Alternate Video	Each program has a main video stream, and may have alternate video streams. This option allows you to switch among these alternate video streams.
Alternate Audio	Each program has a main audio stream (the audio that you hear when the channel is first tuned). This option allows you to switch among these alternate audio streams (e.g., for different languages).

Using the Caption Vision Menu

The Caption Vision menu allows you to turn on/off digital closed captioning, and to modify how digital closed captioning is shown on your TV. Depending on the program, digital closed captioning will be available in a number of different languages, aspect ratios, and reading levels.

- 1 Press **▲** or **▼** to select from the following six services. The service description, if available, applies to the currently tuned channel.

Option	Description
Off	Turns off closed captioning for digital programs
1 XXX YYY ZZZ	XXX = language (English, Spanish, French, etc.)
2 XXX YYY ZZZ	YYY = reader level (standard*, easy)
3 XXX YYY ZZZ	ZZZ = aspect ratio (4:3, 16:9)
4 XXX YYY ZZZ	* When set to this option, the option name is not shown
5 XXX YYY ZZZ	
6 XXX YYY ZZZ	

 **The Caption Vision menu only affects digital channels. For closed captioning on analog channels, see “Using the Setup Menu” on page 108.**

Using the Digital Setup Menu

 This option is the same as the “Digital Channels” option. See “Using the Channel Menu” on page 103.

The Digital Setup menu lets you change the way your digital channels are displayed.

The following digital setup functions are available:

Option	Description
Add Digital Channels	This option allows you to add new digital channels for the currently active antenna mode (Cable or VHF/UHF). This option is useful if the number of digital channels that your TV is able to receive has recently been increased, but you do not want your TV to perform a full Auto Setup.
Channel Show/Hide	This option allows you to remove (hide) digital channels from the Digital Program Guide’s list of channels and subchannels, as well as from channel surfing using CHANNEL +/- . Hidden channels can still be directly tuned using 0-9 and  .
Digital Signal Strength	Displays the current strength of the digital signal on VHF/UHF, to allow you to adjust your antenna for optimal reception. (Does not apply to digital cable channels.)
Digital Caption Setup	Allows you to customize digital closed captioning (see page 70 for details).

Customizing Caption Vision

You can use the Digital Caption Setup menu to customize your TV’s Caption Vision.

Select from the following options to change the visual characteristics of your TV’s digital closed captioning. A preview window displays a sample as you scroll through each option.

Option	Description
Character Size	Small, Standard*, Large
Character Style	Style 1-7 (Style 4*)
Character Color	None, Color 1-8 (White*)
Edge Color	Color 1-8 (Black*)
Edge Type	None*, Raised, Depressed, Outline, Left Shadow, Right Shadow
Background Color	None, Color 1-8 (Teal, Translucent*)
Window Color	None*, Color 1-8

* Indicates factory default setting

Using the Memory Stick Viewer

About Memory Stick



Memory Stick (sold separately) is a new, compact, portable, and versatile Integrated Circuit recording medium with a data capacity that exceeds that of a floppy disk. Memory Stick is specially designed for sharing digital data among Memory Stick compatible products such as digital cameras and digital video cameras. Because it is removable, Memory Stick can also be used for external data storage.

The Memory Stick Viewer on your TV allows you to view files that are stored on Memory Stick media. You can view:

- Digital photos (JPEG files)
- Movies (MPEG1 files)

You can also play slide show background music using MP3 files stored on your Memory Stick.

For more information about handling Memory Stick media, see “Notes on Using Memory Stick Media” on page 85.

Features

With the Memory Stick Viewer, you can:

- View photo (JPEG) and movie (MPEG1) files in a thumbnail index or Slide Show
- Set customized Slide Show options, including transitions and background audio
- Pan, zoom, and rotate photos
- Lock (protect) or delete files on the Memory Stick

Memory Stick Compatibility

This television is compatible with the following Memory Stick media types:

- Memory Stick Media
- Memory Stick Duo Media
- Memory Stick Media with Memory Select Function
- Memory Stick PRO Media

About Memory Stick PRO Media

Memory Stick PRO media features vary by and are dependent upon the design of host hardware devices. Memory Stick Pro in this TV has been tested to support up to 1 GB media capacity and does not support high-speed transfer, MagicGate copyright protection technology, or access control security features.

File Compatibility

The Memory Stick Viewer is compatible with JPEG images taken with Sony digital still cameras and MPEG1* movies taken with Sony digital cameras and camcorders. In order to be viewable in the Memory Stick Viewer, the files must have the following file name extensions:

<i>File Type</i>	<i>Supported File Name Extensions</i>
JPEG	.jpg .jpeg
MPEG1	.mpg .mpeg

Trademark Information

Memory Stick, Memory Stick PRO, and MagicGate are trademarks of Sony Corporation.

* Some variations of MPEG1 movies may not play back correctly.



Inserting and Removing a Memory Stick

If you are using a Memory Stick Duo, see “Inserting the Memory Stick Duo” on page 74.

Inserting a Memory Stick

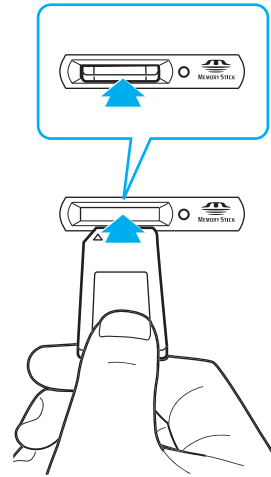
- 1 Locate the Memory Stick slot and insert the Memory Stick into the Memory Stick slot as illustrated below. When inserted properly, it should slide in with little resistance and click into place.



-  **Be sure to insert the Memory Stick in the correct direction. If the Memory Stick is forced in the wrong way, it may become damaged.**
-  **Insert only Memory Stick media into the Memory Stick slot. Attempting to insert other objects into the slot may damage the TV.**

To remove the Memory Stick, see “Removing a Memory Stick” on page 75.

Inserting the Memory Stick Duo

Memory Stick Duo is a new, compact version of the standard-sized Memory Stick recording medium.

CAUTION: Inserting the Memory Stick Duo incorrectly may result in permanent damage to the Memory Stick Duo and the TV.

- 1 Before inserting a Memory Stick Duo into the TV's Memory Stick slot, you must first insert the Memory Stick Duo into an adapter (sold separately).

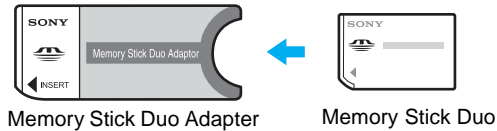

CAUTION: Inserting the Memory Stick Duo into the Memory Stick slot without the adapter may result in permanent damage to the Memory Stick Duo and the TV.

- 2 Insert the Memory Stick Duo and adapter as shown below.

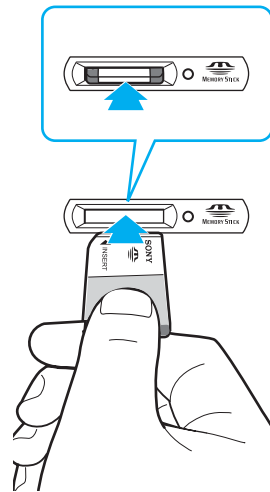

CAUTION: Inserting the Memory Stick adapter backwards or upside down may result in permanent damage to the Memory Stick adapter and the TV.

To remove the Memory Stick Duo, see “Removing a Memory Stick” on page 75.

Removing a Memory Stick

- 1 Check that the Memory Stick indicator is off. (When the light is on, this indicates that the TV is reading data from the Memory Stick.)
⚠ Removing the Memory Stick while a file is being accessed (when the Memory Stick indicator on the TV's front panel is lit) may damage the Memory Stick or its contents.
- 2 Push the Memory Stick gently into the slot, and then release it. The Memory Stick media is ejected.

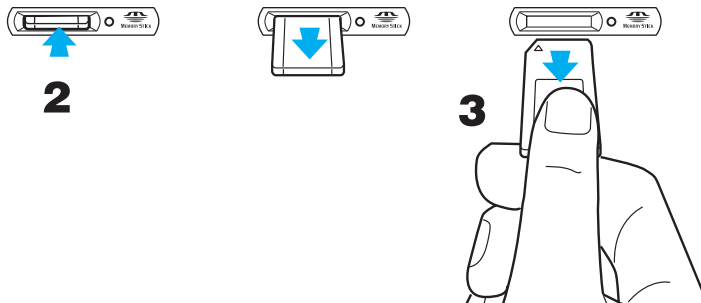



💡 When removing the Memory Stick, do not attempt to just pull it from its slot. Follow steps 1-3 (right).

- 3 Pull the Memory Stick completely out of the slot.
⚠ To protect small children from injury from Memory Stick Media, remove all Memory Stick media from the TV's Memory Stick slot and store it in a safe location when it is not in use.

Using the Memory Stick Index

Turn on the TV and insert a Memory Stick that contains the photo or movie files you want to view. For how to insert a Memory Stick, see page 73.

 **If the Memory Stick Index does not appear, press MEMORY STICK  on the remote control.**

The Memory Stick Index appears, which displays thumbnail images of the files stored on the Memory Stick.



About the Lock and Movie Icons on the Thumbnail Images



Indicates the thumbnail is a movie (MPEG1) file instead of a photo (JPEG) file.



Indicates the thumbnail is locked. Locked files cannot be changed or deleted. For details, see [Protect](#) on page 84.

Using the Memory Stick Index

The following describes how to use the Memory Stick Index.

To Do This ...	Do This ...
Move the highlight to a photo or movie (🖼️) thumbnail	Press ↑ ↓ ← → .
Display the highlighted photo or movie file full screen	Press ⏏ . For details, see “Viewing Photos” on page 78 and “Playing Movies” on page 81.
Display the next page of thumbnails	<ol style="list-style-type: none"> 1 Press ↓ to select ▼. 2 Press ↓ to display the next page of thumbnails.
Display the previous or next page of thumbnails	<ol style="list-style-type: none"> 1 Press ↓ to select ▼. 2 Press ← to select ◀. 3 To go to the previous page, press ▲. To go to the next page, press ▼.
Use the Memory Stick menu bar to access additional options	<ol style="list-style-type: none"> 1 Press ↓ to select ▼. 2 Press ← or → to select Slide Show, Folder, or Memory Stick. 3 Press ↑ or ↓ to select the option you want to change. <p>For details on these options, see “Memory Stick Index Menu Bar Options” on page 83.</p>
Move the highlight from the Memory Stick menu bar back to the thumbnails	<ol style="list-style-type: none"> 1 Press ← or → to select ▼. 2 Press ↑ to return to the currently displayed thumbnails, or ↓ to display the next page of thumbnails.
Exit Memory Stick Viewer	Press MEMORY STICK  on the remote control.

Viewing Photos

When you select a photo from the Memory Stick Index (described on page 76), it displays as shown below, with the following controls.



Information about selected photo

Selected photo

Previous/next buttons

Photo menu bar



 **JPEGs captured using a digital video camera may appear to display motion in full screen. This is a result of the way digital video cameras record still images, and is not a result of a malfunction with the TV.**

Photo Controls

 When the menu is hidden, press ◀ or ▶ to go to the previous or next photo.



To Do This ...	Do This ...
Display the next or previous file on the Memory Stick	Press ▲ or ▼ to highlight the ◀ ▶ (Previous/Next) button. Then press ◀ to go to the previous file, or ▶ to go to the next file.
Hide the Photo menu bar, displaying only the photo	With the highlight in the Photo menu bar, press ▼.
Display the hidden Photo menu bar	Press ▲.
Display the Memory Stick Index again	Press ◀ or ▶ to highlight Index in the Photo menu bar and press  . For details on the Memory Stick Index, see page 77.
Access additional options in the Photo menu bar	See "Photo Menu Bar Options" on page 79.
Exit Memory Stick Viewer	Press MEMORY STICK  on the remote control.



Photo Menu Bar Options

The Photo menu bar lets you access additional photo viewing options.

To access the Photo menu bar

- 1 Press **←** or **→** to select **Slide Show**, **View**, or **File**.
- 2 Use **↑** **↓** **←** **→** to select the desired option.

Option	Description
Index	Displays the Memory Stick Index, with the highlight on the thumbnail of the currently displayed photo. For details, see “Using the Memory Stick Index” on page 76.
Slide Show	Displays the Slide Show menu. For details, see “Slide Show Menu Options” on page 83.
View	Zoom/Pan Allows you to magnify and pan across the photo. For details, see “Using Zoom and Pan” on page 80.
	Rotate Allows you to rotate the photo in 90 degree increments clockwise or counterclockwise. For details, see “Using Rotate” on page 80.
File	Information Allows you to turn on or off the display of file information. Select On or Off .
	Protect Allows you to protect the JPEG file from any changes. When a JPEG file is protected, it cannot be rotated or deleted. Select On or Off .
	Delete Deletes the JPEG file from the Memory Stick. You cannot delete a JPEG file that has been protected (or if the Memory Stick is locked).

 JPEG files that are protected are indicated by the Lock  icon.

Using Zoom and Pan

To Zoom and Pan a photo

- 1 In the Photo menu bar, press ◀ or ▶ to highlight **View**.
- 2 Press ▲ or ▼ to highlight **Zoom/Pan** and press (A+).
- 3 Specify the zoom center point by using ▲ ▼ ◀ ▶; then press (A+) to set the center.

The Zoom and Pan controls are displayed.

Indicates Zoom increment



Zoom and Pan Controls

To Do This ...

Zoom in (increase magnification) or out (decrease magnification)

Do This ...

Press ◀ or ▶ to highlight **Zoom** and press (A+). Then press ▲ to zoom in or ▼ to zoom out.

To stop using Zoom, press (A+).

Pan (left, right, up, down)

(You can use Pan only when the photo is magnified using Zoom.)

Press ◀ or ▶ to highlight **Pan** and press (A+). Then press ◀ ▶ ▲ ▼ to pan around the photo.

To stop using Pan, press (A+).

Exit the Zoom/Pan controls

Press ◀ or ▶ to highlight **Exit** and press (A+).

Exit Memory Stick Viewer

Press **MEMORY STICK**  on the remote control.

Using Rotate

To Rotate a photo

- 1 In the Photo menu bar, press ◀ or ▶ to highlight **View**.
- 2 Press ▲ or ▼ to highlight **Rotate**.
- 3 To rotate clockwise, press ▲ or ▼ to highlight **Clockwise** and press (A+).
To rotate counterclockwise, press ▲ or ▼ to highlight **Counterclockwise** and press (A+).

The photo is rotated 90 degrees each time you press (A+).

Playing Movies

When you select a movie from the Memory Stick Index (described on page 76), it displays as shown below, with the following controls.



Movie Controls

The quality of the movie when enlarged depends on the resolution of the MPEG1 file. See your camera's instruction manuals for details.

To Do This ...	Do This ...
Enlarge the movie window	Press ▲ or ▼ to highlight Enlarge , and then press . To display the movie controls again, press . When the movie playback ends, the movie controls are displayed again.
Play the movie with the movie controls displayed	Press ▲ or ▼ to highlight ▶ (Play) and then press .
Pause the movie	While the movie is playing, the ▶ button changes ⏸ (Pause) button. Press ▲ or ▼ to highlight ⏸ (Pause) and then press .
Display the previous or next file on the Memory Stick	Press ▲ or ▼ to highlight the (Previous/Next) button. Then press ◀ to go to the previous file, or ▶ to go to the next file.
Hide the Movie menu bar, displaying only the movie	With the highlight in the Movie menu bar, press ▼ .
Display the hidden Movie menu bar	Press ▲ .
Access additional options in the Movie menu bar	See "Movie Menu Bar Options" on page 82.
Exit Memory Stick Viewer	Press MEMORY STICK on the remote control.

Movie Menu Bar Options

To access the Movie menu bar

- 1 Use **↑** or **↓** to highlight **Index** in the Movie menu bar.
- 2 Press **←** or **→** to select **Index**, **Slide Show**, or **File**.
- 3 Press **↑** or **↓** to select the desired option.

Option	Description
Index	Displays the Memory Stick Index, with the highlight on the thumbnail of the currently displayed movie.
Slide Show	Displays the Slide Show menu. For details, see “Slide Show Menu Options” on page 83.
File	Information Determines whether file information is displayed. Select On or Off .
	Protect Allows you to protect the MPEG1 file from any changes. When an MPEG1 file is protected, it cannot be deleted. Select On or Off .
	Delete Deletes the MPEG1 file from the Memory Stick. You cannot delete an MPEG1 file that has been protected (or if the Memory Stick is locked).

🔒 MPEG1 files that are protected are indicated by the Lock  icon.

Memory Stick Index Menu Bar Options

Slide Show Menu Options

💡 The Slide Show menu is the same whether you select it from the Memory Stick Index (page 76), Photo (page 78), or Movie (page 81) menus.

💡 When you select **Complete List...**, it may take a moment to display the list of all MP3 files.

💡 Some JPEG files may take longer to display than others, which may make it seem longer than the interval you selected for **Slide Duration**.

The Slide Show menu includes the following options:

Option	Description
Start	Starts the Slide Show.
Music	Allows you to select background audio to play during the Slide Show.
Off	No additional background audio is played during the Slide Show. Audio that is associated with the JPEG or MPEG1 files will play.
Play All	Plays all MP3 files on the Memory Stick. The Piano MP3 file is not played.
Piano	Plays the MP3 file stored in the TV's internal memory. (This file is indicated by a different color than the MP3 files on the Memory Stick.)
Complete List...	Displays a list of all available MP3 files. The list is sorted in alphabetical order, grouped by folder.
Transition Effect	Allows you to select an effect to be used when advancing to the next file in the Slide Show.
Off	Uses a quick change, or cut.
Fade	Uses a cross fade.
Wipe →	Uses a linear sweep that moves across the screen, revealing the next image while covering the previous image.
Wipe ←	
Wipe ↑	
Wipe ↓	
Random	Randomly cycles through all Transition Effects.
Slide Duration	Allows you to specify a timed slide advance after a selected time interval. Select from 3 sec. , 5 sec. , 10 sec. , 30 sec. , 1 min. and 5 min.
Repeat	On Slide Show continuously loops.
	Off Slide Show plays once through all files and ends.

Folder Menu Options

🔒 Files that are protected are indicated by the Lock icon.

🔄 The Rotate and Protect functions do not change the file's modification date.

The Folder menu includes the following options:

Option	Description
Select Contents	Allows you to select different folders to view in the Memory Stick Viewer.
Digital Camera Folders	Selects all folders within the directories defined by the DCF rules used by Sony digital cameras (see page 85). JPEG and MPEG1 files in those directories are recognized even if they do not conform to the DCF file naming rules.
Select a Folder	Allows you to access individual folders on the Memory Stick.
Protect	Allows you to protect files from any changes. When a file is protected, it cannot be rotated or deleted. The Protect options affect files currently shown in the Memory Stick Index.
Protect All	Protects all files.
Protect None	Unprotects all files.
File Order	Allows you to change the order in which the Memory Stick files are displayed.
Date Order	Displays files in chronological order by modification date.
Date Order Reverse	Displays files in reverse chronological order by modification date.
Alphabetical	Displays files in alphabetical order by filename.
Filter	Allows you to selectively display specific file types within the selected folder.
Show All	Displays all readable files.
Show Photos Only	Displays only photo (JPEG) files.
Show Movies Only	Displays only movie (MPEG1) files.

Memory Stick Menu

The Memory Stick menu displays the current status of the Memory Stick, including total capacity, used capacity, and free capacity.

Notes on Using Memory Stick Media

About DCF File Names

Most Sony brand digital still and video cameras automatically record still photo and movie files using DCF compliant directory and file names.

If you selected the [Digital Camera Folders](#) option, as described on page 84, you might want to have your digital camera's instruction manual handy in order to check how files and directories are organized for your specific model of digital camera.

DCF stands for "Design Rules for Camera File Systems," which are specifications established by the Japan Electronics and Information Technology Industries Association (JEITA: former JEIDA).

Memory Stick Precautions

When using Memory Stick media, follow these precautions:

- To avoid permanent damage to still image data, do not turn off the TV or remove Memory Stick media from the insertion slot while data is being read (as indicated by the Memory Stick indicator light being on).
- Avoid touching the terminal of Memory Stick media or bringing it into contact with a metal object.
- Do not drop, bend, or submit Memory Stick media to external shock.
- Do not disassemble or modify Memory Stick media.
- Avoid getting liquid on Memory Stick media.
- Apply labels only within the designated label area.

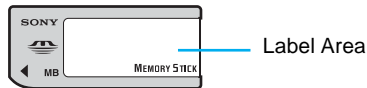

- To avoid permanent damage to still image data, do not use or store Memory Stick media in a location subject to:
 - High temperature (such as near a heater or inside a hot car)
 - High humidity
 - Direct sunlight
 - Corrosive substances
 - Magnetic fields
 - Excessive dust
 - Static electricity or electric noise
 - Electric surges
- Store and carry Memory Stick media in its original case to ensure protection of stored data.
- Save a backup of stored data.

Using i.LINK

About i.LINK

This TV is equipped with i.LINK, which provides a secure digital interface to other digital home entertainment devices, such as digital VCRs, digital camcorders, set-top boxes, and other devices that also are equipped with i.LINK. i.LINK allows for the secure transfer of copyright-protected digital content between these devices and your digital television.

i.LINK is a trademark of Sony Corporation and used only to designate that a product contains an IEEE 1394 connector.

All products with an i.LINK connector may not communicate with each other.

Using i.LINK Cables

This TV has three S400 i.LINK terminals (one in the front panel, and two in the back panel). You can use the following i.LINK cables with this TV:

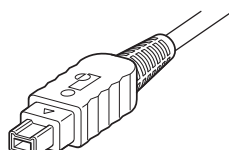

4-pin i.LINK cable

Sony Model	Length
VMC-IL4415	1.5 meters
VMC-IL4435	3.5 meters

 **Do not use cables other than the ones listed above.**

Connecting i.LINK Devices

 Before connecting this unit to i.LINK-compatible equipment, read the instruction manual of the i.LINK device to be connected.

To connect a digital i.LINK device (using only a digital signal)

- 1 Using an i.LINK cable (see page 87), connect the device's i.LINK jack to either of the TV's i.LINK jacks.

To connect an i.LINK device that supports an EIA-775A connection

- 1 Using an i.LINK cable (see page 87), connect the device's i.LINK jack to either of the TV's i.LINK jacks.
- 2 Using an A/V cable, connect the i.LINK device's A/V output jacks to the TV's VIDEO 3 A/V input jacks.

 Only one i.LINK cable should connect the TV and any given i.LINK device.

Rear of Media receiver unit

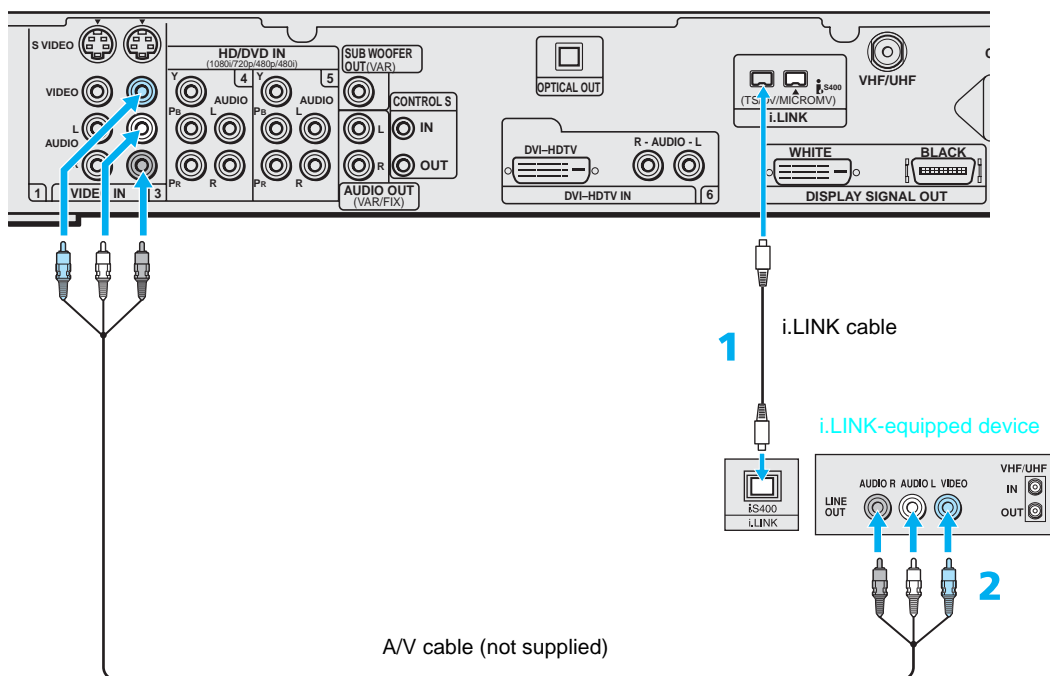

Notes on Using This Connection

To Do This ...	Do This ...
Set up a digital i.LINK device	For digital i.LINK devices (devices that require only the i.LINK connection), no setup is necessary. The TV automatically recognizes the device as soon as the connection is made.
Set up an i.LINK device that supports an EIA-775A analog connection	<ul style="list-style-type: none"> <input type="checkbox"/> Connect analog A/V cables to the VIDEO 3 input (see page 88). <input type="checkbox"/> Use the i.LINK Control Panel to activate the analog connection to your i.LINK device (see page 93).

Notes on Connecting i.LINK Devices

To connect two or more i.LINK devices, use i.LINK cables to connect them as shown below.

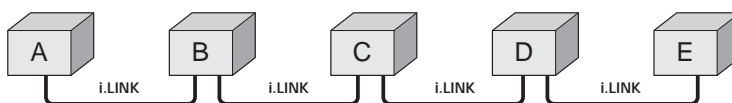

You can connect up to 63 i.LINK devices. However, the maximum number of cables in any serial route is 16.

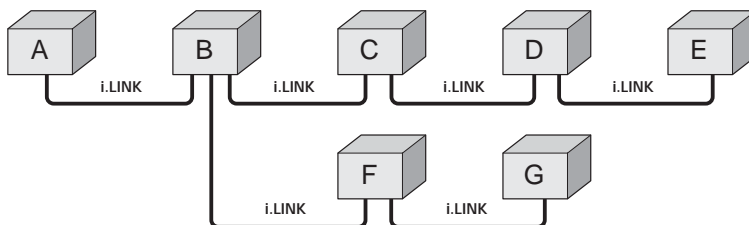

Do not connect i.LINK devices in a way that creates a loop.

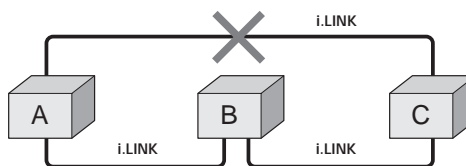

Connecting non-compatible devices, such as PCs or PC peripherals, may result in malfunctions.

Selecting an i.LINK Device

 i.LINK functions are not available while using the following TV features: Twin View, Freeze, and Memory Stick.

Before an i.LINK device can be viewed, it must first be selected via the i.LINK Device List.

- 1 Connect the i.LINK device that you wish to operate.
 **For instructions on connecting i.LINK devices, see page 88.**
- 2 Press **i.LINK** on the remote control.



The TV (DTV), along with all devices connected by i.LINK to the TV, appear on the Device List.



Devices that are not supported by the TV appear on the Device List as “Other Device,” but cannot be controlled using the TV’s remote control or on-screen i.LINK Control Panel. For these devices, use the remote control supplied with the device.

- 3 Press **▲** or **▼** to navigate among the i.LINK-connected devices.
 **i.LINK devices can be connected to one another and to the TV while the TV is powered on. The Device List will automatically update to include the newly-connected device. See page 88 for more information on connecting i.LINK devices.**
- 4 Press **○** to select the desired device and display the device’s i.LINK Control Panel. Use the i.LINK Control Panel to operate the selected device. For details, see page 91.

Using the i.LINK Control Panel

After you select an i.LINK device using the Device List, the TV displays the i.LINK Control Panel, which allows you to use the TV's remote to control the selected i.LINK device.

- 1 If the i.LINK Control Panel is not already displayed, press **i.LINK** on the remote control.

 **If i.LINK is pressed while the TV is displaying an analog or digital channel (not the i.LINK device), then the Device List will appear. Select the desired device from the list and press  to display the Control Panel.**





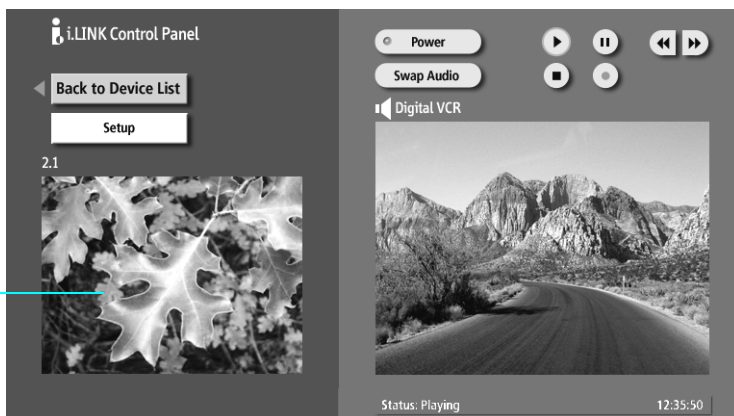









- 2 Press **▲▼◀▶** on the remote control to navigate through the options available in the i.LINK Control Panel.
- 3 Press  to select a desired option.
- 4 Press **EXIT** to exit the Control Panel and view the i.LINK device full-screen.

 **To exit i.LINK mode, select DTV from the Device List or press **CH+/-**.**



The DTV window appears only if the i.LINK menus were entered while watching a digital TV channel

The i.LINK Control Panel displays the signal from the TV to the left (if available), and the signal from the currently selected device to the right.

To Do This ...	Do This ...
Go to the Device List	Press ▲▼◀▶ to highlight Back to Device List and press  .
Change the audio being played from the TV to the current selected device, and vice versa	Press ▲▼◀▶ to highlight Swap Audio and press  . An icon appears next to the window that currently has sound.
Play a recording from the selected i.LINK camcorder or digital VCR	Press ▲▼◀▶ to highlight  and press  .
Fast-forward or rewind a recording from the selected i.LINK camcorder or digital VCR	Press ▲▼◀▶ to highlight  or  and press  .
Record from the TV to the selected i.LINK digital VCR	If the  (record) button is available, press ▲▼◀▶ to highlight  and press  .
Stop a recording from the selected i.LINK digital VCR	Press ▲▼◀▶ to highlight  and press  .
Turn the selected device power on and off	Press ▲▼◀▶ to highlight Power and press  .
Setup the selected device	Press ▲▼◀▶ to highlight Setup and press  . For more details on Setup, see page 93.

Notes About Controlling i.LINK Devices

- You can control the functions of the selected i.LINK device by using the equivalent buttons on the TV's remote control. To program the remote control to operate i.LINK devices, see "Programming the Remote Control" on page 52.
- Some options on the i.LINK Control Panel may not be available, depending on the device being controlled.
- Only i.LINK-equipped digital camcorders and digital VCRs can be controlled directly through the i.LINK Control Panel.
- Not all functions are supported for all i.LINK devices.
- When operating the i.LINK device by using the i.LINK Control Panel, set remote control's function LED to TV.

i.LINK Setup

You can use the i.LINK Control Panel to access digital setup options, some of which are also available through the Digital Program Guide (described on page 67).

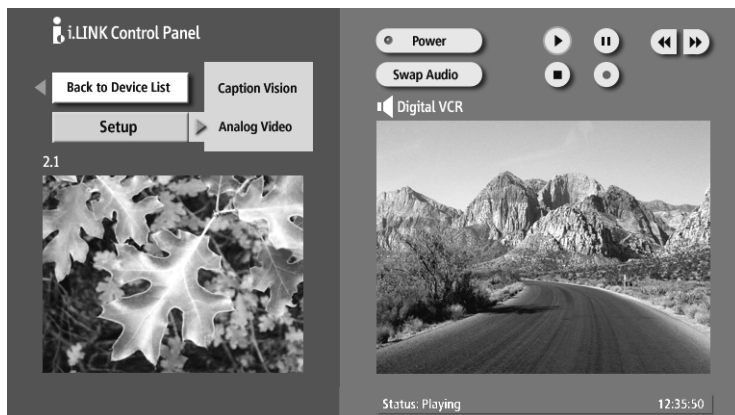

To Do This ...	Do This ...
Set up the selected device	Press ▲ ▼ ◀ ▶ to highlight Setup and press ⏺ .
Set up Caption Vision	Once i.LINK Setup has been selected, Press ▶ then ▲ or ▼ to Caption Vision , and press ⏺ .
	 For details about setting up Caption Vision , see “Using the Caption Vision Menu” on page 69.
Set up i.LINK Analog Video (Set-Top Box)	The TV is able to accept an analog signal from a selected set-top box. The set-top box must be EIA-775A compliant and must be connected to the TV's VIDEO 3 input. To associate the device with the TV's analog VIDEO 3 input, press ▲ or ▼ to select to Analog Video and press ⏺ . All EIA-775A-compliant devices will be shown in the list. Select the desired device from the list and press ⏺ .







Notes on i.LINK

- ❑ The TV can act as an i.LINK repeater, so that i.LINK signals are relayed to another device even when the TV is powered off. To enable this feature, set the **i.LINK Standby** option to **On** using the Setup Menu as described on page 111.
- ❑ Parental Control settings apply to the signal from a selected device. For more details, see page 105.

Using the Menus



Overview

The Menu gives you access to the following features:

Menu Icon	Description	Page
	Allows you to make adjustments to your picture settings. It also allows you to customize the Picture Mode based on the type of program you are viewing, select Advanced Video options, and more.	96
	Offers enhanced audio options such as listening to second audio programming (SAP) or customizing the Effect of the sound on your TV.	99
	Allows you to make Wide Mode adjustments and make changes to the screen's vertical center and vertical size.	101
	Allows you to set up a Favorite Channel list, run the Auto Program function, skip and label channels, and more.	103
	Lets you control the viewing of programs based on their ratings.	105
	Provides options for setting up your system, including setting the Timer, selecting closed caption modes, labeling video inputs, selecting the language of the on-screen menus, and more.	108

 Press **MENU** to enter and exit Menus.

Navigating Through Menus

To Do This ...	Press
Display the Menu	MENU
Move through the Menu	← →
Move through the Menu options	↑ ↓
Select an option to change	
Change an option's settings	↑ ↓ ← →
Select (confirm) changed setting	 or ←
Exit the Menu	MENU

 Menus include navigation help text that appears at the bottom of each Menu.



Using the Video Menu

To select the Video Menu

- 1 Press **MENU**.
- 2 Press **←** or **→** to highlight the Video icon and press **⏏**.
- 3 Press **↑** **↓** **←** **→** to highlight an option. Press **⏏** to select an option.
- 4 Press **↑** **↓** **←** **→** to change settings. Press **⏏** to select the changed setting.
- 5 Press **MENU** to exit the Menu.

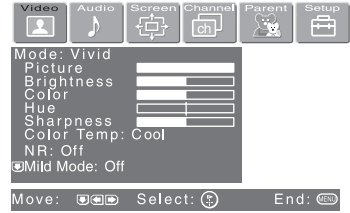

To restore the factory default settings for the Video settings:

- Press **RESET** on the remote control when in the Video Menu.

Selecting Video Options

To change from one Mode to another, use **PICTURE** button on the remote control.

You can alter the video mode (**Vivid**, **Standard**, **Pro**) for each video input (including the TV antenna input).

You can alter the Video Menu settings (**Picture**, **Brightness**, **Color**, etc.) for each Mode.

To prevent image retention, do not use the **Vivid** mode for a long time.

The Video Menu includes the following options:

Option	Description
Mode	Vivid Select for enhanced picture contrast and sharpness.
Customized picture viewing	Standard Select for standard picture settings. Recommended for home entertainment.
	Pro Select for professional monitor like appearance settings.
Picture	Adjust to increase picture contrast and deepen the color, or decrease picture contrast and soften the color.
Brightness	Adjust to brighten or darken the picture.
Color	Adjust to increase or decrease color intensity.
Hue	Adjust to increase or decrease the green tones.
Sharpness	Adjust to sharpen or soften the picture.
Color Temp.	Cool Select to give the white colors a blue tint.
	Neutral Select to give the white colors a neutral tint.
	Warm Select to give the white colors a red tint.
White intensity adjustment	

Option	Description
NR Noise Reduction	Select to reduce the noise level of connected equipment. It is also effective on the signal from the VHF/UHF jack. Select from High , Medium , Low , Off .
Mild Mode	On Select for a natural, soft picture.
	Off Select to turn off the Mild Mode .
Advanced Video	Select Program to choose among the options described below. <div style="background-color: #e0f0ff; padding: 5px; margin: 5px 0;">  Clear White, Enhance Detail, Color Corrector, Black Corrector, Gamma Corrector and White Balance options are available only when Pro mode is selected. </div>
DRC Mode	Creates a high-resolution picture with 4x density, for high quality sources (i.e., DVD player, satellite receiver).
	High Dens. Recommended for moving pictures.
	Progressive Recommended for still images and text.
	CineMotion Provides an optimized display by automatically detecting film content and applying a reverse 3-2 pulldown process. Moving pictures will appear clearer and more natural-looking.

 [DRC Mode](#) and [DRC Palette](#) are not available when watching 480p, 720p, and 1080i sources.

 **DRC Palette** is not available when **Mild Mode** is set to **On**.

 For best results, adjust the **Reality** by pressing **▲▼** until you are satisfied with the level of detail. Then adjust the **Clarity** by pressing **◀▶** until you have a smooth image.

Option	Description
DRC Palette	<p>Allows you to customize the level of detail (Reality) and smoothness (Clarity) for up to three input sources. For example, you can create one Custom setting to optimize your cable input's picture, and create another to optimize your DVD player's picture. You can switch among the three Custom settings in the menu.</p> <ol style="list-style-type: none"> Press ▲▼◀▶ to highlight Custom 1, Custom 2, or Custom 3 and then press ⏏. The DRC palette appears. <div data-bbox="786 425 1032 624" data-label="Diagram"> </div> <ol style="list-style-type: none"> Press ▲▼◀▶ to adjust the position of the marker (●). As you move the ● higher along the Reality axis, the picture becomes more detailed. As you move the ● to the right, along the Clarity axis, the picture becomes smoother. To save the setting, press ⏏. <p>To return the Custom options to the default factory settings, press RESET.</p>
BN Smoother	Select to reduce the block noise caused by digital video encoding and decoding process. It is especially effective for watching a DVD or digital TV picture. Select from High , Medium , Low and Off .
Clear White	Select to emphasize the white colors. Select On or Off .
Detail Enhancer	Select to sharpen picture definition. Select from High , Med. , Low and Off .
Color Corrector	Select to emphasize the red and blue colors. Select On or Off .
Black Corrector	Select to enhance the black colors to give the picture strong contrast. Select from High , Med. , Low and Off .
Gamma Corrector	Select to adjust the balance between bright and dark areas of the picture. Select from High , Med. , Low and Off .
White Balance	Select to fine-adjust the white color intensity by changing the red, green and blue levels. Select Adjust to choose among the R-Gain , G-Gain , B-Gain , R-Bias , G-Bias and B-Bias options. To restore the factory default setting of White Balance , select Initial Set .



Using the Audio Menu

To select the Audio Menu

- 1 Press **MENU**.
- 2 Press **←** or **→** to highlight the Audio icon and press **⏏**.
- 3 Press **↑** **↓** **←** **→** to highlight an option. Press **⏏** to select an option.
- 4 Press **↑** **↓** **←** **→** to change settings. Press **⏏** to select the changed setting.
- 5 Press **MENU** to exit the Menu.

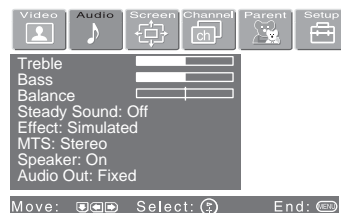

To restore the factory default settings for Treble, Bass, and Balance

- Press **RESET** on the remote control when in the Audio Menu.

Selecting Audio Options

Virtual Dolby and **TruSurround** attempt to create the same surround effect produced by a multichannel system using the left and right speakers. **Virtual Dolby** is most effective for programs encoded in Dolby Surround.

The Audio Menu includes the following options:

Option	Description
Treble	Adjust to decrease or increase higher-pitched sounds.
Bass	Adjust to decrease or increase lower-pitched sounds.
Balance	Adjust to emphasize left or right speaker balance.
Steady Sound	Auto Select to stabilize the volume.
	Off Select to turn off Steady Sound.
Effect	Virtual Dolby Select for Dolby Pro Logic surround sound (for stereo programs only).
	TruSurround Select for surround sound (for stereo programs only).
	Simulated Adds a surround-like effect to mono programs.
	Off Normal stereo or mono reception.
MTS <i>Enjoy stereo, bilingual and mono programs</i>	Stereo Select for stereo reception when viewing a program broadcast in stereo.
	Auto SAP Select to automatically switch the TV to second audio programs when a signal is received. (If no SAP signal is present, the TV remains in Stereo mode.)
	Mono Select for mono reception. (Use to reduce noise during weak stereo broadcasts.)

Option	Description
Speaker	On Select to turn on the TV speakers.
	Off Select to turn off the TV speakers and listen to the TV's sound only through your external audio system speakers.
Audio Out <i>Easy control of volume adjustments</i>	This option can be set only when the Speaker option is set to Off .
	Variable The TV's speakers are turned off, but the audio output from your audio system can still be controlled by the TV's remote control.
	Fixed The TV's speakers are turned off and the audio output of the TV is fixed. Use your audio receiver's remote control to adjust the volume (and other audio settings) through your audio system.



Using the Screen Menu

To select the Screen Menu

- 1 Press **MENU**.
- 2 Press **←** or **→** to move to the Screen icon and press **⏏**.
- 3 Press **↑** or **↓** to move to an option. Press **⏏** to select an option.
- 4 Press **←→↑↓** to change settings. Press **⏏** to select the changed setting.
- 5 Press **MENU** to exit the Menu.

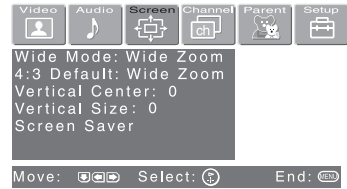

Selecting Screen Mode Options

To change from one Wide Mode to another, use **WIDE** on the remote control.

Wide Zoom is recommended for 4:3 picture to prevent image retention.

For **Wide Zoom** and **Zoom** modes, you can adjust the vertical position and size of the picture. For details, see page 102.

The Screen menu includes the following options:

Option	Description
Wide Mode <i>Select a Wide Mode to use for 4:3 sources.</i>	Wide Zoom Select to enlarge the 4:3 size picture, while the upper and lower parts of the picture are condensed to fit the wide screen.
Normal	Select to return the 4:3 picture to normal mode.
Full	Select to enlarge the 4:3 picture horizontally only, to fill the wide screen.
Zoom	Select to enlarge the 4:3 picture horizontally and vertically to an equal aspect ratio that fills the wide screen.

Wide Mode is unavailable while in Twin View, or when viewing HD (1080i, 720p) sources.

In some cases, wide-screen programs will be shown in aspect ratios that require the display of black bands at the top and bottom of your 16:9 screen. For more details, see page 118.

💡 If **4:3 Default** is set to anything but **Off**, the **Wide Mode** setting changes only for the current channel. When you change channels (or inputs), **Wide Mode** is automatically replaced with the **4:3 Default** setting. To retain the current **Wide Mode** setting as channels and inputs are changed, set **4:3 Default** to **Off**.

Option	Description	
4:3 Default <i>Select the default Screen Mode to use for 4:3 sources</i>	Wide Zoom	Select to enlarge the 4:3 size picture, while the upper and lower parts of the picture are condensed to fit the wide screen.
	Normal	Select to return the 4:3 picture to normal mode.
	Full	Select to enlarge the 4:3 picture horizontally only, to fill the wide screen.
	Zoom	Select to enlarge the 4:3 picture horizontally and vertically to an equal aspect ratio that fills the wide screen.
	Off	Select to continue using the current Wide Mode setting when the channel or input is changed.
Vertical Center	Allows you to move the position of the picture up and down in the window. (Available only in Wide Zoom and Zoom modes.) Press ▲ or ▼ and press ⊕ to choose a correction between +15 and -15 (Zoom mode), and +5 and -5 (Wide Zoom mode).	
Vertical Size	Allows you to adjust the vertical size of the picture. (Available only in Wide Zoom and Zoom modes.) Press ▲ or ▼ and press ⊕ to choose a correction between +7 and -7.	
Screen Saver	Orbit	Moves the picture position to reduce image retention. This does not prevent image retention completely if the same picture is displayed for an extended period of time.
	All White	Displays a white screen to reduce image retention.



Using the Channel Menu

To select the Channel Menu

- 1 Press **MENU**.
- 2 Press **←** or **→** to highlight the Channel icon and press **⏏**.
- 3 Press **↑** **↓** **←** **→** to highlight an option. Press **⏏** to select an option.
- 4 Press **↑** **↓** **←** **→** to change settings. Press **⏏** to select the changed setting.
- 5 Press **MENU** to exit the Menu.



Selecting Channel Options

The Channel Menu includes the following options:

Option	Description
Favorite Channels	Lets you set up a list of your favorite channels. For details, see “Using Favorite Channels” on page 63.
Channel Fix	Off Turns off Channel Fix .
<i>Useful when you have a cable box or satellite receiver connected</i>	2-6 “Fix” your TV’s channel setting to 2-6 and use the cable box or satellite receiver to change channels. Select one of these settings if you connected the equipment to the VHF/UHF jack.
	C2-6 Same as 2-6, except you select one of these settings if you connected the equipment to the CABLE jack (see page 22).
	Video 1 Use this setting if you have connected the equipment to the A/V input jacks.
Auto Program	Automatically sets up the channel list on the TV for all receivable channels.
Digital channels	Add Select to add digital channels.
Channel Skip/Add	Allows you to customize the channel list that appears when you use the CH+/- buttons. <ol style="list-style-type: none"> 1 Press ↑ or ↓ to scroll through the channels until you find the channel you want to skip or add. Then press ⏏ to select it. 2 Press ↑ or ↓ to toggle between Add or Skip. Then press ⏏ to select. 3 To add or skip more channels, repeat steps 1 and 2. 4 Press ← to return to the Channel Menu, or press MENU to exit the Menus.

Channels that you set to be skipped can be accessed only with the **0-9** buttons.

<i>Option</i>	<i>Description</i>
Channel Label	<p>Allows you to assign labels (such as station call letters) to channel numbers. You can label up to 40 channels.</p> <ol style="list-style-type: none"> 1 Press ▲ ▼ ◀ ▶ to highlight Channel and press ⏏. 2 Press ▲ ▼ to scroll through the channel numbers (1-125). Then press ⏏ to select the channel number that you want to assign a label. 3 Press ▲ ▼ ◀ ▶ to highlight Label and press ⏏. 4 Press ▲ ▼ to scroll through the label characters (A-Z, 0-9, etc.). Then press ⏏ to select the highlighted character. 5 Repeat to add up to 5 characters to the label. 6 To assign labels to more channels, repeat steps 1-4. 7 Press ◀ to return to the Channel Menu, or press MENU to exit the Menus.



Using the Parent Menu

The Parent Menu allows you to set up the TV to block programs according to their content and rating levels.

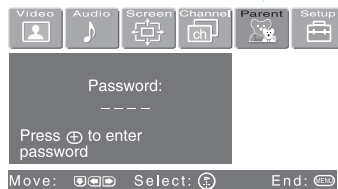

To select the Parent Menu

- 1 Press **MENU**.
- 2 Press **←** or **→** to highlight the Parent icon and press **[Enter]**.
- 3 Use **0-9** on the remote control to enter a four-digit password.
- 4 If this is the first time you are creating this password, confirm the password by entering it again. (The Parent Menu options appear.)
- 5 Press **↑ ↓ ← →** to change settings. Press **[Enter]** to select the changed setting.
- 6 Press **MENU** to exit the Menu.

You need your password for any future access into the Parent Menu. If you lose your password, see “Lost password” on page 120.

Selecting Parent Options

If you are not familiar with the Parental Guideline rating system, you should select **Child**, **Youth**, or **Y. Adult** to help simplify the rating selection. To set more specific ratings, select **Custom**.

For descriptions of **Child**, **Youth**, and **Y. Adult** ratings, see page 106.

The Parent Menu includes the following options:

Option	Description
Parental Lock	Off Parental lock is off. No programs are blocked from viewing.
<i>Turn ratings on/off and select a rating system</i>	<p>Child Maximum ratings permitted are:</p> <ul style="list-style-type: none"> <input type="checkbox"/> US: TV-Y, TV-G, G <input type="checkbox"/> Canada: C, G, TV-Y <p>Youth Maximum ratings permitted are:</p> <ul style="list-style-type: none"> <input type="checkbox"/> US: TV-PG, PG <input type="checkbox"/> Canada: C8+, PG, 8 ans+, TV-PG <p>Y. Adult Maximum ratings permitted are:</p> <ul style="list-style-type: none"> <input type="checkbox"/> US: TV-14, PG-13 <input type="checkbox"/> Canada: 14+, 13 ans+, TV-14 <p>Custom Select to set ratings manually.</p> <ul style="list-style-type: none"> <input type="checkbox"/> US: See page 106 for details. <input type="checkbox"/> Canada: See page 107 for details.
Change Password	For changing your password.
Select Country	<p>U.S.A. Select to use USA ratings (see page 106).</p> <p>Canada Select to use Canadian ratings (see page 107).</p>

US Models: Selecting Custom Rating Options

💡 The Content-Based Ratings are linked to the level of the Age-Based Rating. For example, a program with an Age-Based Rating of **TV-PG V** (Violence) rating may contain moderate violence, while a **TV-14 V** (Violence) rating may contain more intense violence.

💡 To ensure maximum blocking capability, set the Age-Based Ratings.

💡 If you block unrated TV programs, be aware that the following types of programs may be blocked: programs broadcast from another country, emergency broadcasts, political programs, sports, news, public service announcements, religious programs and weather.

Viewing Blocked Programs

For US models, the Custom Rating Menu includes the following options. (For Canadian models, see page 107.)

Option	Description
Movie Rating	G All children and General Audience.
	PG Parental Guidance suggested.
	PG-13 Parental Guidance for children under 13.
	R Restricted viewing, parental guidance is suggested for children under 17.
	NC-17 and X No one 17 or under allowed.
TV Rating <i>Block programs by their rating, content or both</i>	Age-Based Ratings
	TV-Y All children.
	TV-Y7 Directed to children age 7 and older.
	TV-G General Audience.
	TV-PG Parental Guidance suggested.
	TV-14 Parents Strongly cautioned.
	TV-MA Mature Audience only.
	Content-Based Ratings
	FV Fantasy Violence.
	D Suggestive Dialogue.
L Strong Language.	
S Sexual situations.	
V Violence.	
Unrated <i>Block programs or movies that are broadcast without a rating</i>	Allow Allows programs and movies that are broadcast without a rating.
	Block Blocks all programs and movies that are broadcast without a rating.

You can view blocked programs by entering the password. Press **ENTER** when tuned to a blocked program, then enter the password. This temporarily switches off the Parental Lock. To reactivate the Parental Lock settings, turn off the TV. When the TV is turned on again, your Parental Lock settings are reactivated.

Canadian Models: Selecting Custom Rating Options

For Canadian models, the Custom Rating Menu includes the following options. (For US models, see page 106.)

Option	Description	
English Rating	C	All children.
	C8+	Children 8 years and older.
	G	General programming.
	PG	Parental Guidance.
	14+	Viewers 14 and older.
	18+	Adult programming.
French Rating	G	General programming.
	8 ans+	Not recommended for young children.
	13 ans+	Not recommended for ages under 13.
	16 ans+	Not recommended for ages under 16.
	18 ans+	Programming restricted to adults.
U.S.A. Rating	See "US Models" on page 106 for details.	

Viewing Blocked Programs

You can view blocked programs by entering the password. Press **ENTER** when tuned to a blocked program, then enter the password. This temporarily switches off the Parental Lock. To reactivate the Parental Lock settings, turn off the TV. When the TV is turned on again, your Parental Lock settings are reactivated.



Using the Setup Menu

To select the Setup Menu

- 1 Press **MENU**.
- 2 Press **←** or **→** to highlight the Setup icon and press **⏏**.
- 3 Press **↑** **↓** **←** **→** to highlight an option. Press **⏏** to select an option.
- 4 Press **↑** **↓** **←** **→** to change settings. Press **⏏** to select the changed setting.
- 5 Press **MENU** to exit the Menu.



To move from within one Menu to the main Menu of icons, press **←**.

Selecting Setup Options



The Setup Menu includes the following options:



















Option	Description
Caption Vision	Allows you to select from three closed caption modes (for programs that are broadcast with closed caption).
Off	Turns off Caption Vision.
CC1, CC2, CC3, CC4	Displays a printed version of the dialog or sound effects of a program. (Should be set to CC1 for most programs.)
Text1, Text2, Text3, Text4	Displays network/station information presented using either half or the whole screen (if available). For closed captioning, set to CC1 .
Info	Displays the program name and the time remaining in the program (if the broadcaster offers this service). Displays when the channel is changed or DISPLAY is pressed.

💡 When selecting **Game**, or **Web**, the TV decreases brightness to prevent image retention.

💡 The **Skip** label is useful for inputs that do not have equipment connected to them.

Option	Description				
Video Label	<p>Allows you to identify A/V equipment you connected to the TV, such as a VCR, DVD, etc. For example, if you have a DVD player connected to the VIDEO 4 jack, you can select the label DVD for the VIDEO 4 input. Then when you press TV/VIDEO to change inputs, the Video Label you assigned to that input appears on screen.</p> <ol style="list-style-type: none"> 1 Press ▲ or ▼ to highlight the video input (VIDEO 1-6) to which you want to assign a label. Then press ⏏ to select the input. 2 Press ▲ or ▼ to highlight one of the displayed labels. Then press ⏏ to select the label. <p>You can select from the following labels for each input:</p> <table border="1" data-bbox="619 534 1245 690"> <tr> <td data-bbox="619 534 857 564">Video 1-3</td> <td data-bbox="861 534 1245 621">VHS, DVD, Receiver, Satellite, Cable Box, 8mm, DTV, Game, LD, Web, Beta, Skip</td> </tr> <tr> <td data-bbox="619 626 857 656">Video 4-6</td> <td data-bbox="861 626 1245 690">DVD, Satellite, Cable Box, DTV, HD, Game, Skip</td> </tr> </table> <p>📌 If you select Skip, your TV skips this input when you press the TV/VIDEO button.</p>	Video 1-3	VHS, DVD, Receiver, Satellite, Cable Box, 8mm, DTV, Game, LD, Web, Beta, Skip	Video 4-6	DVD, Satellite, Cable Box, DTV, HD, Game, Skip
Video 1-3	VHS, DVD, Receiver, Satellite, Cable Box, 8mm, DTV, Game, LD, Web, Beta, Skip				
Video 4-6	DVD, Satellite, Cable Box, DTV, HD, Game, Skip				
Game Picture	<p>Allows you to move the position of the picture left and right in the window. (Available for the picture of connected equipment.) Select while watching the picture to be adjusted. The TV stores the position in memory for each input.</p>				
Language	<p>Select to display all on-screen Menus in your language of choice.</p>				

 To go directly to programming **Timer 1** or **2**, press  instead of pressing .

Option	Description
Clock/Timers	Lets you set the clock on your TV and allows you to program your TV for scheduled viewing using the Timers.
Sleep	Allows you to select the time in minutes (15, 30, 45, 60, or 90) that you want the TV to remain on before shutting off automatically.
Timer 1 Timer 2	You can use the Timers to program the TV to turn on and off and tune to a specific channel at two scheduled viewing times. Timer 1 & 2 are not available to be set until you set the Current Time .
	<ol style="list-style-type: none"> <li data-bbox="868 510 1243 597">1 Press  or  to highlight Timer 1 or Timer 2. To set the timer, press . <li data-bbox="868 604 1243 869">2 Press  or  to highlight one of the following options, then press . Program: Select to set the Timer by day, time, duration, and channel. Off: Select to turn off the Timer. (Your previous settings are saved.) <li data-bbox="868 876 1243 1117">3 If you selected Program in step 2, press  and  to set the day(s), hour, minute, duration, and channel number. Press  or press  to confirm each setting and move to the next setting. Press  to go back to the previous setting. <li data-bbox="868 1124 1243 1246">4 Press MENU to exit the Menu. An LED on the front panel will light, indicating the timer has been set.
Current Time	<ol style="list-style-type: none"> <li data-bbox="868 1262 1243 1348">1 Press  and  to highlight Current Time and then press . <li data-bbox="868 1355 1243 1529">2 Press  and  to set the current time (day, hour, and minute). Press  (or press ) to confirm each setting and move to the next setting. Press  to go back to the previous setting. <li data-bbox="868 1536 1243 1564">3 Press MENU to exit the Menu.

<i>Option</i>	<i>Description</i>
Illuminated	Allows you to illuminate the Sony logo on the front panel of the display unit and the input indicator on the media receiver unit.
	Yes Illuminates the Sony logo and input indicator while the power is turned on.
	No Illuminates the Sony logo and input indicator only when the power is switched to on or off.
i.LINK Standby	On Allows the i.LINK signal to pass through to connected i.LINK devices even when the TV is turned off. The front panel i.LINK STANDBY LED lights in red. The TV uses more standby power than when this option is set to Off .
	Off Does not allow the i.LINK signal to pass through to connected i.LINK devices when the TV is turned off. The front panel i.LINK STANDBY LED turns off. The TV uses less standby power than when this option is set to On .

Other Information

Overview

This chapter includes the following topics:

<i>Topic</i>	<i>Page</i>
Glossary	114
Contacting Sony	115
Troubleshooting	115
Specifications	121
Optional Accessories	123
Index	124

Glossary

analog signal

A signaling method that uses continuous changes in the amplitude or frequency of an electronic transmission to convey information.

aspect ratio

Refers to the ratio between the width and height of the screen. This TV has a 16:9 (widescreen) aspect ratio, as opposed to a 4:3 aspect ratio.

4:3 aspect ratio



16:9 aspect ratio



component video



Component video is sent through three cables: two color shade (chrominance) signals and one brightness (luminance) signal. Component video achieves greater color accuracy than composite video or S VIDEO by splitting chrominance into two separate portions.

composite video



Composite video is sent through a single cable. Composite video combines the color shade (chrominance) and brightness (luminance) information into one video signal.

digital television (DTV)

A new technology for transmitting and receiving broadcast television signals. DTV provides higher resolution and improved sound quality over analog television.

National Television System Committee (NTSC)

A unit of the Federal Communications Commission, Washington, DC, that establishes television standards in the United States, such as NTSC Color, the standard used in this TV.

RF

Radio Frequency. That part of the frequency spectrum that is used to transmit TV and radio signals.

S VIDEO



S VIDEO requires a single cable, which carries the brightness (luminance) and color (chrominance) signals of the picture separately. S VIDEO provides better resolution than composite video, which carries the signals together.

VHF/UHF

VHF (Very High Frequency) is the part of the frequency spectrum from 30 to 300 megahertz. UHF (Ultra High Frequency) is the part of the frequency spectrum from 300 to 3,000 megahertz.

480i

Provides 480 lines of resolution. Displays images using interlaced scanning, which first transmits all the odd lines on the TV screen and then the even lines.

480p

Provides 480 lines of resolution. Displays images using progressive scanning, which transmits each line from top to bottom.

720p

Provides 720 lines of resolution. Displays images using progressive scanning, which transmits each line from top to bottom.

1080i

Provides 1080 lines of resolution. Displays images using interlaced scanning, which first transmits all the odd lines on the TV screen and then the even lines. 1080i is one of the formats used by HDTV (High Definition TV).

Contacting Sony

If, after reading these operating instructions, you have additional questions related to the use of your Sony television, please call our Customer Information Services Center at 1-800-222-SONY (7669) (US residents only) or (416) 499-SONY (7669) (Canadian residents only).

Troubleshooting

Twin View





Problem	Possible Remedies
I cannot get Twin View to work	<ul style="list-style-type: none">❑ If you are using a cable box to unscramble all channels (as shown on page 28), you cannot use the Twin View feature. This is because the cable box can unscramble only one channel at a time.❑ You can use Twin View to view a signal from a different source that is connected to the TV's A/V jacks (such as a VCR or DVD player) in the second window by pressing TV/VIDEO while in Twin View.❑ Sources connected to the CABLE, VIDEO 4, VIDEO 5, and VIDEO 6 inputs, as well as digital sources, display in the left Twin View window, but not the right.
There is no Twin View window, or it is just static	<ul style="list-style-type: none">❑ Be sure the Twin View window is set to a video input or channel that has a signal airing.❑ You might be tuned to a video input with nothing connected to it. Try cycling through the video inputs by pressing TV/VIDEO.
Twin View cannot display anything but TV channels	<ul style="list-style-type: none">❑ Try cycling through the video inputs by pressing TV/VIDEO. Check that the Video Label option is not set to Skip. (See the Setup Menu on page 109.)
Twin View displays the same program in both windows	<ul style="list-style-type: none">❑ Both Twin View windows might be set to the same channel. Try changing channels in either window.

Remote Control

Problem	Possible Remedies
Remote control does not operate	<ul style="list-style-type: none">❑ The batteries could be weak. Replace the batteries.❑ Check the orientation of the batteries.❑ Press FUNCTION repeatedly until the TV indicator lights up. You may have inadvertently pressed FUNCTION, which changes the remote control to SAT or CABLE mode.❑ Make sure this unit's power cord is connected securely to the wall outlet.❑ Locate the unit at least 3-4 feet away from fluorescent lights.
Cannot change channels with the remote control	<ul style="list-style-type: none">❑ If you are using the TV to change channels, first press FUNCTION repeatedly until the TV indicator lights up.❑ If you are using another device to change channels, be sure you have not inadvertently switched your TV from the channel 3 or 4 setting. Use the Channel Fix option to "fix" the channel based on the hookup you used (see page 103).❑ If you are using another device to change channels, be sure to press FUNCTION for that device. For example, if you are using your cable box to change channels, be sure to press FUNCTION repeatedly until the SAT/CABLE indicator lights up.
Remote control does not operate non-Sony video equipment	<ul style="list-style-type: none">❑ If you replaced the batteries to the remote recently, the code numbers for the video equipment may need to be reset.❑ There may be more than one code for the equipment that you are attempting to operate.❑ There is a possibility that some non-Sony equipment cannot be operated by your Sony TV remote. You may need to use the equipment's original remote control.
Remote control does not operate Sony video equipment	<ul style="list-style-type: none">❑ There is a possibility that some Sony equipment cannot be operated by your Sony TV remote. You may need to use the equipment's original remote control.

Memory Stick

Problem	Possible Remedies
Image does not display/Cannot see all files	<ul style="list-style-type: none">❑ Make sure the image file is a JPEG (.jpg, .jpeg) file or an MPEG1 (.mpg, mpeg) file.❑ Make sure the Memory Stick is inserted properly (see page 73).❑ Check the Filter option setting (see page 84).❑ Check the Select Contents setting (see page 84) and ensure that files are either in DCF directories if Digital Camera Folders is selected (see page 84), or in the currently selected folder if Select a Folder is selected (see page 84).❑ The maximum number of files the Memory Stick Viewer can display is 1,024.
JPEG image displays undesirable motion or flicker in full screen	<ul style="list-style-type: none">❑ JPEGs captured using a digital video camera may appear to display motion in full screen. This is a result of the way digital video cameras record still images, and is not a result of a malfunction with the TV.
Rotation not saved after Memory Stick is ejected or Memory Stick Viewer is closed	<ul style="list-style-type: none">❑ The Memory Stick might be locked. Unlock the Memory Stick and try rotating the image again.❑ The file might not have information (EXIF data) that is usually generated when a digital camera records a photo. In this case, it is not possible to save the rotation.❑ There might be insufficient space on the Memory Stick to save the rotated file. Try deleting one or more files and rotating the image again.

Problem	Possible Remedies	
Cannot show (or hide) file information in full screen or Slide Show	<input type="checkbox"/>	Set the File/Information option to On or Off (see pages 79 and 82).
Cannot see menu	<input type="checkbox"/>	Press ▲ to display the menu again.
Cannot hear audio while using Memory Stick	<input type="checkbox"/>	Check the TV's volume or Speaker (page 100) settings.
	<input type="checkbox"/>	To hear JPEG voice memo, select the Digital Camera Folders option and set the Filter option to Show All .
	<input type="checkbox"/>	Check that the Music option is not set to Off (see page 83).
Not all MP3 files on Memory Stick are included when the Music /Complete List option is selected (page 83)	<input type="checkbox"/>	The maximum number of MP3 files the Memory Stick Viewer can display is 128.
	<input type="checkbox"/>	Make sure that the file is named with the file extension (.mp3).
MPEG1 movie does not play back correctly	<input type="checkbox"/>	Some variations of MPEG1 movies may not be compatible with the Memory Stick Viewer.
MPEG1 quality is poor when enlarged (page 81)	<input type="checkbox"/>	The quality of the movie when enlarged depends on the resolution of the MPEG1 file. See your camera's instruction manual for details.
MP3 files on the Memory Stick are not listed	<input type="checkbox"/>	Only MP3 files that are named with the file extension (.mp3) are displayed in the list.
Music files are playing in wrong order	<input type="checkbox"/>	MP3 files are played in alphabetical order, according to the folder in which they are stored. If you want to change the playlist order, rename your files alphabetically in the order in which you want them to play.
Cannot see MP3 list to play music	<input type="checkbox"/>	MP3 files on your Memory Stick only can be played as background music during a Slide Show (see page 83).
Error message is displayed	<input type="checkbox"/>	No Memory Stick There is no Memory Stick in the slot.
	<input type="checkbox"/>	Memory Stick is locked The lock mechanism on the Memory Stick is engaged.
	<input type="checkbox"/>	Memory Stick Error The Memory Stick in the slot might be damaged; try a different Memory Stick.
	<input type="checkbox"/>	Format Error The Memory Stick may have been formatted using a PC or other device that is not compatible with cameras.
Error icon is displayed		The file is not a valid MPEG1 or JPEG format.
		The thumbnail is not DCF-compatible.
		The file is a JPEG or an MPEG1, but the thumbnail is unreadable.
		The file is unreadable.

Video

Problem	Possible Remedies
No picture (screen not lit), no sound	<ul style="list-style-type: none"> <input type="checkbox"/> If your TV does not turn on, and a red light keeps flashing, your TV may need service. Call your local Sony Service Center. <input type="checkbox"/> Make sure the power cord is plugged in. <input type="checkbox"/> Press POWER on the front of the media receiver unit. <input type="checkbox"/> Press TV/VIDEO to cycle through the connected video sources. <input type="checkbox"/> Try another channel; it could be station trouble. <input type="checkbox"/> Press PIC OFF so that the PICUTRE OFF LED on the display unit goes off. <input type="checkbox"/> Make sure the display interface cable is connected to the display unit and media receiver unit.
Dark, poor or no picture (screen lit), good sound	<ul style="list-style-type: none"> <input type="checkbox"/> Adjust the Picture option in the Video Menu (see page 96). <input type="checkbox"/> Adjust the Brightness option in the Video Menu (see page 96). <input type="checkbox"/> Check the antenna/cable connections.
No color	<ul style="list-style-type: none"> <input type="checkbox"/> Adjust the Color option in the Video Menu (see page 96).
Only snow and noise appear on the screen	<ul style="list-style-type: none"> <input type="checkbox"/> Check the antenna/cable connections. <input type="checkbox"/> Try another channel; it could be station trouble. <input type="checkbox"/> Press ANT to change the input mode (see page 50).
Dotted lines or stripes	<ul style="list-style-type: none"> <input type="checkbox"/> Adjust the antenna. <input type="checkbox"/> Move the TV away from noise sources such as cars, neon signs, or hair-dryers.
Double images or ghosts	<ul style="list-style-type: none"> <input type="checkbox"/> Using a highly directional outdoor antenna or a cable may solve the problem.
Striped noise during playback/recording of a VCR	<ul style="list-style-type: none"> <input type="checkbox"/> Video head interference. Keep your VCR away from the TV. <input type="checkbox"/> Leave a space of 30 cm (11 7/8 inches) between your VCR and the TV to avoid noise. <input type="checkbox"/> Avoid installing your VCR in front of the TV or at the side of the TV.
The screen flickers when turning on the TV.	<ul style="list-style-type: none"> <input type="checkbox"/> This is caused by feature of the Plasma Display Panel, and does not indicate a malfunction of the TV.
“Black box” on screen	<ul style="list-style-type: none"> <input type="checkbox"/> You have selected a text option in the Setup Menu and no text is available. To turn off this feature, set the Caption Vision option to Off. If you were trying to select closed captioning, select CC1 instead of Text 1-4.
Black bands appear at the top and bottom of the screen	<ul style="list-style-type: none"> <input type="checkbox"/> Some wide-screen programs are filmed in aspect ratios that are greater than 16:9 (this is especially common with theatrical releases). Your TV will show these programs with black bands at the top and bottom of the screen. For more details, check the documentation that came with your DVD (or contact your program provider).
Certain programs on DVD or other digital sources display a loss of detail, especially during fast-motion or dark scenes	<ul style="list-style-type: none"> <input type="checkbox"/> The compression used by certain digital broadcasts and DVDs may cause your TV's screen to display less detail than usual, or cause artifacts (small blocks or dots, pixelations) to appear on your screen. This is due to your TV's large screen and ability to show very fine detail, and is normal for certain digitally recorded programs. Adjust the reality/clarity in the DRC Palette menu (see page 98) to optimize the picture while viewing these sources.

Audio

Problem	Possible Remedies
Good picture, no sound	<ul style="list-style-type: none"> <input type="checkbox"/> Press MUTING so that Muting disappears from the screen (see page 50). <input type="checkbox"/> Make sure the Speaker option is set to On in the Audio Menu (see page 100). <input type="checkbox"/> (For KDE61XBR950 only) Make sure the EXT SP switch at the rear of the display unit is set to OFF.
Audio noise	<ul style="list-style-type: none"> <input type="checkbox"/> Communication problems may occur if the infrared communication equipment (e.g., infrared cordless headphones) is used near the TV. Please use headphones other than infrared cordless headphones. Also, if you use the infrared communication equipment other than infrared cordless headphones, move the infrared transceiver away from the TV until the noise is eliminated, or move the transmitter and receiver of the infrared communication equipment closer together.
Cannot gain enough volume when using a cable box	<ul style="list-style-type: none"> <input type="checkbox"/> Increase the volume of the cable box using the cable box's remote control. Then press FUNCTION repeatedly until the TV indicator lights up and adjust the TV's volume.
Sound seems weak or insufficient	<ul style="list-style-type: none"> <input type="checkbox"/> The TV's audio might be set to Auto SAP or Mono, when it might be better set to Stereo. In the Audio Menu (see page 99), set the MTS setting to Stereo. If already set to Stereo, switch to Mono (which may reduce background noise during weak stereo broadcasts).
Cannot raise the volume on external speakers	<ul style="list-style-type: none"> <input type="checkbox"/> If the Speaker option is set to Off and the Audio Out option is set to Fixed (in order to output the sound to your audio system) use your audio receiver to adjust the sound (see page 100). Or, to use the TV remote control, set the Audio Out option to Variable. <input type="checkbox"/> To turn on the TV speakers, set the Speaker option to On (see page 100).

Channels

Problem	Possible Remedies
Cannot receive upper channels (UHF) when using an antenna	<ul style="list-style-type: none"> <input type="checkbox"/> Press ANT to select the VHF/UHF input. (see page 50) <input type="checkbox"/> Use Auto Program in the Channel Menu to add receivable channels that are not presently in the TV's memory (see page 103).
TV is fixed to one channel	<ul style="list-style-type: none"> <input type="checkbox"/> Use Auto Program in the Channel Menu to add receivable channels that are not presently in the TV's memory (see page 103). <input type="checkbox"/> Check your Channel Fix settings (see page 103).
Cannot receive any channels when using cable TV	<ul style="list-style-type: none"> <input type="checkbox"/> Use Auto Program in the Channel Menu to add receivable channels that are not presently in the TV's memory (see page 103). <input type="checkbox"/> Press ANT to select the CABLE input. (see page 50).
Cannot receive or select channels	<ul style="list-style-type: none"> <input type="checkbox"/> Use Auto Program in the Channel Menu to add receivable TV channels that are not presently in TV memory (see page 103).
Some digital cable channels are not being displayed	<ul style="list-style-type: none"> <input type="checkbox"/> Certain cable companies have limitations on the broadcast of digital cable channels. Check with your cable company for more information. <input type="checkbox"/> The digital cable channel may be set to Hide in the Digital Setup Menu (see page 70).

General

Problem	Possible Remedies
How to restore Video settings to factory settings	<input type="checkbox"/> Press RESET on the remote control while in the Video Menu (see page 96).
How to restore Audio settings to factory settings	<input type="checkbox"/> Press RESET on the remote control while in the Audio Menu (see page 99).
Cannot cycle through the other video equipment connected to the TV	<input type="checkbox"/> Be sure the Video Label option is not set to Skip (see page 109).
Cannot operate menu	<input type="checkbox"/> If a menu option appears in gray, this indicates that the menu option is not available.
Lost password	<input type="checkbox"/> In the password screen (see page 105), enter the following master password: 4357 . The master password clears your previous password; it cannot be used to temporarily unblock channels. <input type="checkbox"/> The i.LINK STANDBY LED blinks when the signal from an i.LINK device is being shown.
LED on the display unit is lit	<input type="checkbox"/> The POWER ON/STAND BY LED (see page 18) lights up when the TV is turned on. If the LED blinks continuously, this may indicate the TV needs a service. <input type="checkbox"/> The TIMER LED (see page 18) indicates that the timer is set. When the timer is set, this LED will remain lit even when the TV is turned off. <input type="checkbox"/> If the STANDBY LED blinks, disconnect the AC power cord and leave the TV for three minutes to check that it stops blinking. If the LED does not stop blinking, contact qualified Sony personnel.
The signal from a selected i.LINK device is not being displayed	<input type="checkbox"/> If you have several i.LINK devices connected and operating at once, the TV may not be able to display the signal from the selected device. Turn the other i.LINK devices off, and reselect the desired i.LINK device.

Specifications

Panel System	Plasma Display panel	
Display resolution	KDE42XBR950	1024 pixels (horizontal) × 768 pixels (vertical)
	KDE50XBR950	1365 pixels (horizontal) × 768 pixels (vertical)
	KDE61XBR950	1365 pixels (horizontal) × 768 pixels (vertical)
Antenna	75 ohm external terminal for VHF/UHF	
Television System	NTSC, American TV Standard	
Channel Coverage	VHF	2-13
	UHF	14-69
	DTV	1-999
	CATV	1-125
Power Requirements	120V, 60 Hz	
Inputs/Outputs		
DVI-HDTV	1 terminal, 3.3V T.M.D.S., 50 ohms The DVI-HDTV input terminal is compliant with the EIA-861 standard and is not intended for use with personal computers.	
Video (IN)	3 total (1 on front panel)	1 Vp-p, 75 ohms unbalanced, sync negative
S Video (IN)	3 total (1 on front panel)	Y: 1 Vp-p, 75 ohms unbalanced, sync negative C: 0.286 Vp-p (Burst signal), 75 ohms
Audio (IN)	6 total (1 on front panel)	500 mVrms (100% modulation) Impedance: 47 kilohm
Component Video Input	2 (Y, Pb, Pr)	Y: 1.0 Vp-p, 75 ohms unbalanced, sync negative; Pb: 0.7 Vp-p, 75 ohms Pr: 0.7 Vp-p, 75 ohms
CONTROL S (IN)	1	minijack
CONTROL S (OUT)	1	minijack
Digital Audio Optical Output (PCM/Dolby Digital)	1	Optical Rectangular (1)
i.LINK	3 total (1 on front panel)	4-pin S400 i.LINK terminal
Variable/Fixed Audio (OUT)	1	More than 408 mVrms at the maximum volume setting (Variable) More than 408 mVrms (Fixed) Impedance (output): 2 kilohms
Sub woofer (OUT)	1	phono jack
RF Inputs	2	
Screen Size (measured diagonally)	KDE42XBR950	42 inches
	KDE50XBR950	50 inches
	KDE61XBR950	61 inches
Speaker Output	15W × 2	
Dimensions (W × H × D)	PDM-4210	1352 × 720 × 102 mm (53 1/4 × 28 3/8 × 4 1/8 in)
	PDM-5010	1573 × 856 × 108 mm (62 1/8 × 33 3/4 × 4 3/8 in)
	PDM-6110	1797 × 937 × 110 mm (70 7/8 × 37 × 4 3/8 in)
	MBD-XBR950	430 × 79 × 342.8 mm (17 × 3 1/8 × 13 1/2 in)

(Continued)

Mass	Display unit	
	PDM-4210: 39kg (86 lbs) PDM-5010: 53kg (114 lbs) PDM-6110: 71 kg (156 lbs 8 oz)	
Power Consumption	Media receiver unit	
	MBD-XBR950: 6.5kg (14 lbs 5 oz)	
	In Use	Display unit
		PDM-4210: 430 W PDM-5010: 516 W PDM-6110: 770 W
Media receiver unit		
MBD-XBR950: 53 W		
Supplied Accessories	In Standby	Under 1.5 W
	i.LINK standby	Under 22 W
	Media receiver unit	
Remote Control (1)		RM-Y1000
AA (R6) Batteries (2)		
AC power code (2)		
AC plug holder (1)		
Display interface cable (1)		
Antenna cable (1)		
Cleaning cloth (1)		
Display unit		
Frame bars (2) (KDE61XBR950 only)		
Screws (2) (KDE61XBR950 only)		

Design and specifications are subject to change without notice.

Optional Accessories

- A/V Cable (VC-810S/820S/830S)
- Component Video Cable (VMC-10/30)
- Control S Cable (RK-G69)
- 10M display interface cable (VMC-P10)
- i.LINK cables: VMC-IL4415 (4-pin to 4-pin, 1.5 meters); VMC-IL4435 (4-pin to 4-pin, 3.5 meters)
- Table top stand: SU-P42T2 (for PDM-4210)
SU-P50T2 (for PDM-5010/6110)
Wall-mount bracket: SU-PW2 (for PDM-4210/5010/6110)
- Floating stand: SU-PF1 (for PDM-4210/5010)
SU-PF1L (for PDM-6110)

Index

0-9 buttons 51
16:9 aspect ratio 59
4:3 aspect ratio 59
4:3 Default settings 102

A

Add Digital Channels 70
Alternate Audio 69
Alternate Video 69
ANT button 50, 58
Audio Menu 95, 99
Audio Out 100
audio receiver, connecting 45
Auto Program (channel setup) 48
Auto SAP, MTS setting 99

B

balance, adjusting 99
bass, adjusting 99
batteries, inserting in remote 49
bilingual audio 99
Black Corrector 98
blocking programs. *See ratings.*
brightness, adjusting 96

C

cable
 with VCR, connecting 31
cable box
 connecting with VCR 33
 Twin View issues 60
 using with TV remote control 56
Caption Vision 108
Caption Vision menu, for digital channels 69
CATV. *See cable*
CH buttons 51
changing picture size, in Twin View 62
CHANNEL buttons 20
Channel Menu 95, 103
Channel Show/Hide 70
Channel Skip/Add 103
channels

 creating labels 104
 setting up 48
CineMotion 14, 97
Clear White 98
clearing, Favorite Channels 48, 63
Clock/Timers 110
closed caption modes 95, 108
Color Corrector 98
color, adjusting 96
CONTROL S 47
CONTROL S IN/OUT jack, described 22
Cool, Color Temperature 96

D

Detail Enhancer 98
Digital Caption Setup 70
Digital Caption Setup menu 70
Digital Channels 103
Digital Reality Creation 14
Digital Setup menu 70
Digital Signal Strength 70
Digital Visual Interface (DVI) 15, 22
DISPLAY button 58
DISPLAY SIGNAL OUT, described 22
Display unit
 connecting 23
 controls 18
DRC Function 97
DRC Mode 97
DRC Palette 98
DRC. *See Digital Reality Creation.*
DVD player
 using with TV remote control 56
 with A/V connectors, connecting 43
DVI. *See Digital Visual Interface.*
DVI-HDTV 22, 121

E

ENTER button 51
error messages, Memory Stick 117

F

Fast-forward button 50
 Favorite Channels
 clearing 48, 63
 in Channel Menu 103
 using 63
 FAVORITES button 51
 features 13
 Fixed audio setting 100
 FREEZE button 51, 64
 Freeze, using 64
 Full mode, setting 101
 FUNCTION button and indicators 50

G

Game Picture 109
 Gamma Corrector 98
 GUIDE button 50, 67
 Guide menu 68

H

HD/DVD IN jack (1080i/720p/480p/ 480i) jacks,
 described 22
 hue, adjusting 96

I

i.LINK 87–93
 i.LINK Standby 111
 Illuminated 111
 INPUT SELECT button 20
 interlaced 114

J, K

JUMP button 51, 58

L

label
 channels 104
 Language, setting 109

M

MDP, using with TV remote control 56
 Media receiver unit
 connecting 24
 front panel 20
 rear panel 22
 Memory Stick
 Duo 74

features 71
 Index 76
 inserting 73
 panning photos 80
 photo options 79
 playing movies 81
 precautions 86
 removing 75
 rotating photos 80
 slide show options 83
 troubleshooting 116
 viewing photos 78
 zooming photos 80
 MENU button 51, 58, 95

Menus

 Audio 95, 99
 Channel 95, 103
 Parent 95, 105
 Screen 95, 101
 Setup 108
 Video 95, 96
 Mild Mode 97
 Mono, MTS setting 99
 MTS 99
 MUTING button 50, 58

N

Neutral, Color Temperature 96
 Normal mode, setting 101
 NR 97

O

off, turning off the TV 20
 on, turning on the TV 20

P, Q

Parent Menu 95, 105
 parental control, described 14
 password, changing 105
 Pause button 50
 PIC OFF button 50
 PICTURE button 50
 picture contrast, adjusting 96
 Play button 50
 POWER button 18, 20, 51, 58
 POWER LED 120
 POWER ON/STAND BY indicator 18, 20
 powering on/off, the TV 20
 Pro (Video) mode 96
 problems, troubleshooting 115–120

(Continued)

Program Guide 67
Program Options menu 69
progressive 114

R

ratings, setting 105–107
ratings, viewing blocked programs 106, 107
Record buttons 51
remote control
 inserting batteries 49
 programming 52
removing, Favorite Channels 48, 63
RESET button 51
resetting
 Audio options 99
Rewind button 50

S

S VIDEO jack, described 21, 22
SAT/CABLE indicator 50
SAT/CABLE power button 51
satellite receiver, using with TV remote control 55
Screen Saver 102
setting up channels 48
Setup Menu 108
sharpness, adjusting 96
Simulated, Effect 99
sizing, picture in Twin View 62
SLEEP button 50
speakers
 turning on/off 100
 using external speakers 100
specifications 121
Standard mode 96
Steady Sound
 described 14
 setting 99
Stereo, MTS setting 99
Stop button 50
SUBWOOFER OUT jack, described 22
surround sound 99

T, U

TIMER indicator 18, 20, 120
transport buttons 50
treble, adjusting 99
troubleshooting 115–120
TruSurround, Effect 99

turning on/off the TV 20
TV indicator 58
TV/VIDEO button 51, 58
Twin View
 described 14
 using 60–62
Twin View button 50

V

Variable audio setting 100
VCR
 using with TV remote control 55
 with cable box, connecting 33
 with cable, connecting 31
 with satellite receiver, connecting 39
Vertical Center, adjusting 102
Vertical Size 102
VHF/UHF jack, described 22
VIDEO (L/R)/AUDIO jacks, described 22
Video Menu 95, 96
Video modes, selecting 96
Virtual Dolby, Effect 99
Vivid mode 96
VOL buttons 20, 50, 58

W, X, Y

Warm, Color Temperature 96
White Balance 98
WIDE button 50
Wide Mode 101
Wide Screen, described 14
Wide Zoom mode, setting 101

Z

zoom feature, with Twin View 62
Zoom mode, setting 101

<http://www.sony.net/>



Printed on 100% recycled paper.

Printed in Japan