

# ***Color Rear Video Projector***

---

Operating Instructions

***1080i Capable***

***Digital Reality Creation***

***Multi Image Driver***



***FLASH FOCUS***

***KP-53HS10***

***KP-61HS10***

# WARNING

To prevent fire or shock hazard, do not expose the TV to rain or moisture.

<b>CAUTION</b> RISK OF ELECTRIC SHOCK DO NOT OPEN	
<b>ATTENTION</b> RISQUE DE CHOC ELECTRIQUE, NE PAS OUVRIR	
<b>PRECAUCION</b> RIESGO DE CHOQUE ELECTRICO NO ABRIR	
CAUTION : TO REDUCE THE RISK OF ELECTRIC SHOCK, DO NOT REMOVE COVER (OR BACK). NO USER-SERVICEABLE PARTS INSIDE. REFER SERVICING TO QUALIFIED SERVICE PERSONNEL.	



This symbol is intended to alert the user to the presence of uninsulated "dangerous voltage" within the product's enclosure that may be of sufficient magnitude to constitute a risk of electric shock to persons.



This symbol is intended to alert the user to the presence of important operating and maintenance (servicing) instructions in the literature accompanying the appliance.

## CAUTION

To prevent electric shock, do not use this polarized AC plug with an extension cord, receptacle or other outlet unless the blades can be fully inserted to prevent blade exposure.

## CAUTION

When using TV games, computers, and similar products with your projection TV, keep the brightness and contrast functions at low settings. If a fixed (non-moving) pattern is left on the screen for long periods of time especially at a high brightness or contrast setting, the image can be permanently imprinted onto the screen. These types of imprints are not covered by your warranty because they are the result of misuse.

### Note on Caption Vision

This television receiver provides display of television closed captioning in accordance with §15.119 of the FCC rules.

### Note on convergence adjustment

Before you use your projection TV, make sure to adjust convergence. For details, see page 24.

### Note to CATV system installer

This reminder is provided to call the CATV system installer's attention to Article 820-40 of the NEC that provides guidelines for proper grounding and, in particular, specifies that the cable ground shall be connected to the grounding system of the building, as close to the point of cable entry as practical.

Use of this television receiver for other than private viewing of programs broadcast on UHF or VHF or transmitted by cable companies for the use of the general public may require authorization from the broadcaster/cable company and/or program owner.

## NOTIFICATION

This equipment has been tested and found to comply with the limits for a Class B digital device pursuant to Part 15 of the FCC Rules. These limits are designed to provide reasonable protection against harmful interference in a residential installation. This equipment generates, uses, and can radiate radio frequency energy and, if not installed and used in accordance with the instructions, may cause harmful interference with radio communications. However, there is no guarantee that interference will not occur in a particular installation. If this equipment does cause harmful interference to radio or television reception, which can be determined by turning the equipment off and on, the user is encouraged to try to correct the interference by one or more of the following measures:

- Reorient or relocate the receiving antennas.
- Increase the separation between the equipment and receiver.
- Connect the equipment into an outlet on a circuit different from that to which the receiver is connected.
- Consult the dealer or an experienced radio/TV technician for help.

You are cautioned that any changes or modifications not expressly approved in this manual could void your authority to operate this equipment.

This document is for the remote control RM-Y902  
MODELS: KP-53HS10, KP-61HS10

Please keep this notice with the instruction manual.



As an ENERGY STAR Partner, Sony Corporation has determined that this product meets the ENERGY STAR guidelines for energy efficiency.

## ATTENTION

Pour prévenir les chocs électriques, ne pas utiliser cette fiche polarisée avec un prolongateur, une prise de courant ou une autre sortie de courant, sauf si les lames peuvent être insérées à fond sans en laisser aucune partie à découvert.

## Owner's Record

The model and serial numbers are located at the rear of the projection TV, below the Sony logo, on the sticker, and also on the TV box (white label). Record these numbers in the spaces provided below. Refer to them whenever you call upon your Sony dealer regarding this product.

Model No. \_\_\_\_\_

Serial No. \_\_\_\_\_

# Remote Control



In the instructions that follow, we will refer to the buttons on your remote control. Keep this flap unfolded and use this page for reference.

For a detailed explanation of most buttons, see "Watching the TV" on page 25.

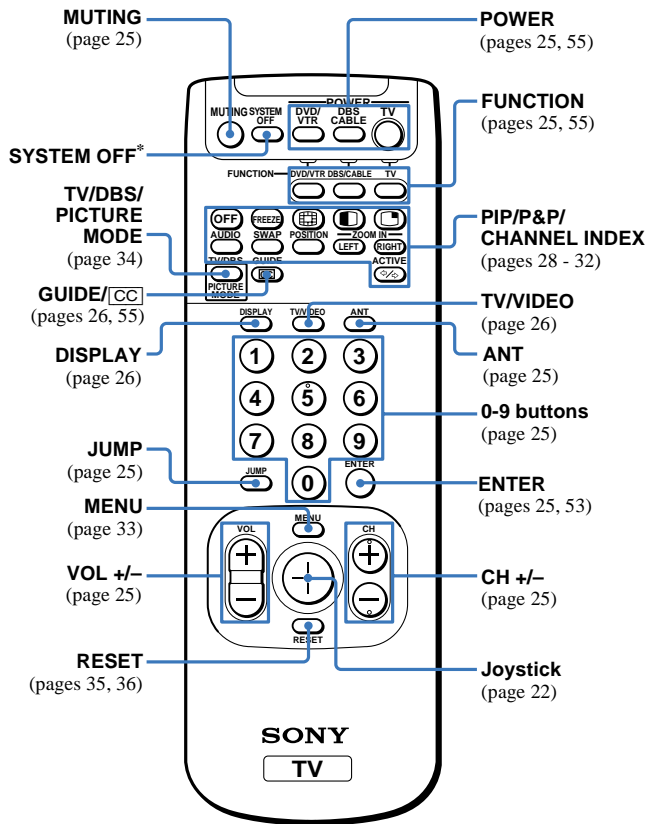
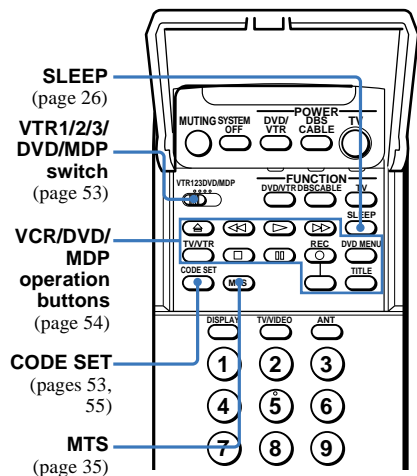

## Getting to know the buttons on the remote control

Names of the buttons on the remote control are presented in different colors to represent the available functions.

### Button color

**Transparent:** Press to select the component you want to control; e.g. VTR (VCR)/MDP/DVD Player, DBS (Direct Broadcast Satellite)/CABLE, or projection TV.

**Green:** Buttons relevant to power operations, like turning the projection TV, DBS/CABLE, or VTR (VCR)/MDP/DVD Player on or off

### Label color

**White:** TV/VTR (VCR)/MDP/DVD Player/DBS (Direct Broadcast Satellite)/CABLE operation buttons

**Yellow:** PIP, P&P, and CHANNEL INDEX operation buttons

**Blue:** DBS operation buttons

**Pink:** DVD Player operation buttons

\* The SYSTEM OFF button does not function with this projection TV.

## Table of Contents

---

### Before You Begin

Welcome! .....	1
Using this Manual .....	2
Precautions.....	2
Important Safeguards.....	3

---

### Installing and Connecting the Projection TV

Carrying Your Projection TV.....	6
Installing the Projection TV.....	6
Connector Types .....	6
Making Connections .....	7
Connecting Directly to a Cable or an Antenna .....	7
Connecting a Cable Box .....	8
Connecting an Antenna/Cable TV System to a VCR .....	9
Connecting a VCR and Projection TV to a Cable Box .....	10
Connecting a DTV (Digital Television) Receiver .....	11
Connecting a DBS (Direct Broadcast Satellite) Receiver .....	13

Connecting a DBS (Direct Broadcast Satellite) Receiver and VCR .....	14
Connecting a Camcorder .....	15
Connecting Two VCRs for Tape Editing .....	16
Connecting a DVD Player With S Video or Composite Video Output Connectors .....	17
Connecting a DVD Player With Component Video Output Connectors .....	18
Connecting an AV Receiver .....	19
Connecting an Audio System .....	20
Connecting an Amplifier That Supports Dolby Pro Logic Decoder .....	21

---

### Basic Set Up

Using the Remote Control .....	22
Setting Up the Projection TV Automatically.....	23
Adjusting the Convergence Automatically (FLASH FOCUS) .....	24

---





### Using Your New Projection TV

Watching the TV .....	25
Watching Digital TV .....	27

Watching Two Programs at One Time — PIP .....	28
Watching Two Programs at One Time — P&P (Twin View™) .....	29
Using CHANNEL INDEX .....	31

---

### Adjusting Your SET UP (menus)

Learning Menu Selection .....	33
 Using the VIDEO Menu .....	34
 Using the AUDIO Menu .....	35
 Using the TIMER Menu .....	36
 Using the CHANNEL SET UP Menu .....	37
Setting and Selecting FAVORITE CHANNEL .....	39
Setting FAVORITE CHANNEL manually .....	39
Resetting FAVORITE CHANNEL choices .....	39
Using FAVORITE CHANNEL .....	40
 Using the SET UP Menu .....	40
Using the PARENTAL CONTROL Feature.....	43
Activating the PARENTAL CONTROL feature .....	43
Selecting a Custom Rating in U.S.A. ....	45
Selecting a Custom Rating in Canada .....	48

Changing the Password . . . . .	49
What the Ratings Mean . . . . .	50
Ratings in U.S.A. . . . .	50
Ratings in Canada . . . . .	51

---

## Additional Operations

Operating Video Equipment. . . . .	53
Setting the Manufacturer's Code . . . . .	53
Operating video equipment . . . . .	54
Operating a Cable Box or DBS Receiver. . . . .	55
Setting the Manufacturer's Code . . . . .	55
Operating a cable box or DBS receiver . . . . .	55

---

## Additional Information

Troubleshooting . . . . .	56
Specifications . . . . .	59
Index . . . . .	60

## Before You Begin

---

### Welcome!

Thank you for purchasing the Sony Color Rear Video Projection TV. This manual is for models KP-53HS10 and KP-61HS10.

Model KP-53HS10 is used for illustration purposes.

The features you will enjoy include:

- "1080i Capable," enabling you to receive the 1080i, 480p and 480i digital TV formats (except for 720p format). By using the VIDEO 5 (DTV) IN jacks, you can connect a DTV (digital television) receiver to view DTV programs.  
The VIDEO 5 (DTV) IN jacks also function as R/G/B connectors with SYNC signal (HD/VD), but are not compatible with a computer's 5BNC video output connectors.
- PARENTAL CONTROL, enabling you to block programs that are unsuitable for your children.
- DRC (Digital Reality Creation), a technology unique to Sony, allowing you to obtain a finer, more detailed picture with four-times higher density than the conventional NTSC picture. (not available for input from the VIDEO 5 (DTV) IN jacks)
- MID (Multi Image Driver), a newly developed device, allowing you to enjoy the following features and, at the same time, to use your projection TV easily. (not available for input from the VIDEO 5 (DTV) IN jacks)

- Picture & Picture (P&P) with zoom-in function (Twin View™)
- Picture-in-Picture (PIP)
- CHANNEL INDEX, allowing you to view and choose from twelve programs
- FAVORITE CHANNEL, allowing you to view and choose from eight of your favorite channels
- FLASH FOCUS, allowing you to adjust convergence automatically.
- Two Y/Pb/Pr inputs for DVD Player connection (480p format capability is on the VIDEO 5 (DTV) IN jacks).
- Four AUDIO/VIDEO/S VIDEO inputs.

TruSurround, SRS and the  symbol are trademarks of SRS Labs, Inc. in the United States and selected foreign countries.

TruSurround and SRS technology is incorporated under license from SRS Labs, Inc.

Manufactured under license from Dolby Laboratories Licensing Corporation. "Dolby," and the double-D symbol  are trademarks of Dolby Laboratories Licensing Corporation.

---

## Using this Manual

We recommend that you carefully review the contents of the following four sections in the order provided to ensure that you fully understand the operation of your new projection TV.

### 1 Installing and Connecting the Projection TV

This section guides you through your initial set up. It shows you how to install your projection TV, to connect your new components and to connect to the antenna and cable.

### 2 Basic Setup

This section teaches you the basic skills needed to operate your new projection TV, including Easy Set Up. It shows you how to operate the remote control's special functions.

### 3 Using Your New Projection TV

This section shows you how to begin using your new projection TV. It shows you how to use your remote control's features.

### 4 Adjusting Your Set Up (menus)

This section teaches you how to access on-screen menus and adjust your projection TV's settings.

*Instructions in this manual are written for the remote control. Similar controls may be found on the projection TV console.*

---

## Precautions

### Safety

- Operate the projection TV only on 120 V AC.
- The plug is designed, for safety purposes, to fit into the wall outlet only one way. If you are unable to insert the plug fully into the outlet, contact your dealer.
- If any liquid or solid object should fall inside the cabinet, unplug the projection TV immediately and have it checked by qualified service personnel before operating it further.
- If you will not be using the projection TV for several days, disconnect the power by pulling the plug itself. Never pull on the cord.

*For details concerning safety precautions, see "Important Safeguards" on page 3.*

### Note on cleaning

Clean the cabinet of the projection TV with a dry soft cloth. To remove dust from the screen, wipe it gently with a soft cloth. Stubborn stains may be removed with a cloth slightly dampened with solution of mild soap and warm water. Never use strong solvents such as thinner or benzine for cleaning.

If the picture becomes dark after using the projection TV for a long period of time, it may be necessary to clean the inside of the projection TV. Consult qualified service personnel.

## Installing

- To prevent internal heat buildup, do not block the ventilation openings.
- Do not install the projection TV in a hot or humid place, or in a place subject to excessive dust or mechanical vibration.
- Avoid operating the projection TV at temperature below 5°C (41°F).
- If the projection TV is transported directly from a cold to a warm location, or if the room temperature changes suddenly, the picture may be blurred or show poor color. In this case, please wait a few hours to let the moisture evaporate before turning on the projection TV.
- To obtain the best picture, do not expose the screen to direct illumination or direct sunlight. It is recommended to use spot lighting directed down from the ceiling or to cover the windows that face the screen with opaque drapery. It is desirable to install the projection TV in a room where the floor and walls are not of a reflective material.

## Important Safeguards

For your protection, please read these instructions completely, and keep this manual for future reference.

Carefully observe and comply with all warnings, cautions and instructions placed on the set, or described in the operating instructions or service manual.

### WARNING

To guard against injury, the following basic safety precautions should be observed in the installation, use, and servicing of the set.

### Use



#### Power Sources

This set should be operated only from the type of power source indicated on the serial/model plate.

If you are not sure of the type of electrical power

supplied to your home, consult your dealer or local power company. For those sets designed to operate from battery power, refer to the operating instructions.

#### Grounding or Polarization

This set is equipped with a polarized AC power cord plug (a plug having one blade wider than the other), or with a three-wire grounding type plug (a plug having a third pin for grounding).

Follow the instructions below:



#### For the set with a polarized AC power cord plug

This plug will fit into the power outlet only one way. This is a safety feature. If you are unable to insert the plug fully into the outlet, try reversing the plug. If the plug should still fail to fit, contact your electrician to have a suitable outlet installed. Do not defeat the safety purpose of the polarized plug by forcing it in.

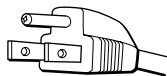

#### Alternate Warning For the set with a three-wire grounding type AC plug

This plug will only fit into a grounding-type power outlet. This is a safety feature. If you are unable to insert the plug into the outlet, contact your electrician to have a suitable outlet installed. Do not defeat the safety purpose of the grounding plug.



#### Overloading

Do not overload wall outlets, extension cords or convenience receptacles beyond their capacity, since this can result in fire or electric shock.

Always turn the set off when it is not to be used. When the set is left unattended and unused for long periods of time, unplug it from the wall outlet as a precaution against



the possibility of an internal malfunction that could create a fire hazard.

#### Object and Liquid Entry

Never push objects of any kind into the set through the cabinet slots as they may touch dangerous voltage points or short out parts that could result in a fire or electric shock. Never spill liquid of any kind on the set.



#### Attachments

Do not use attachments not recommended by the manufacturer, as they may cause hazards.

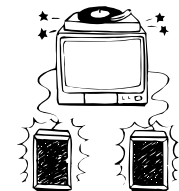

#### Cleaning

Unplug the set from the wall outlet before cleaning or polishing it. Do not use liquid cleaners or aerosol cleaners. Use a cloth lightly dampened with water for cleaning the exterior of the set.



*(continued)*

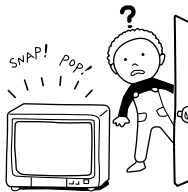

If a snapping or popping sound from a projection TV set is continuous or frequent while the projection TV is operating, unplug the projection TV and consult your dealer or service technician. It is normal for some projection TV sets to make occasional snapping or popping sounds, particularly when being turned on or off.

### Installation



#### Water and Moisture

Do not use power-line operated sets near water—for example, near a bathtub, washbowl, kitchen sink, or laundry tub, in a wet basement or near a swimming pool, etc.



#### Accessories

Do not place the set on an unstable cart, stand, table or shelf. The set may fall, causing serious injury to a child or an adult, and serious damage to the set. Use only a cart or stand recommended by the manufacturer for the specific model of projection TV.



An appliance and cart combination should be moved with care. Quick stops, excessive force, and uneven surfaces may cause the appliance and cart combination to overturn.

### Ventilation

The slots and openings in the cabinet and in the back or bottom are provided for necessary ventilation. To ensure reliable operation of the set, and to protect it from overheating, these slots and openings must never be blocked or covered.

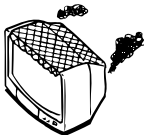

- Never cover the slots and openings with a cloth or other materials.

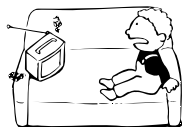

- Never block the slots and openings by placing the set on a bed, sofa, rug or other similar surface.

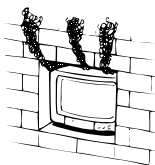

- Never place the set in a confined space, such as a bookcase, or built-in cabinet unless proper ventilation is provided.



- Do not place the set near or over a radiator or heat register, or where it is exposed to direct sunlight.



### Power-Cord Protection

Do not allow anything to rest on or roll over the power cord, and do not place the set where the power cord is subject to wear or abuse.

### Antennas

**Outdoor Antenna Grounding** — If an outdoor antenna is installed, follow the precautions below.

An outdoor antenna system should not be located in the vicinity of overhead power lines or other electric light or power circuits, or where it can come in contact with such power lines or circuits.

**WHEN INSTALLING AN OUTDOOR ANTENNA SYSTEM, EXTREME CARE SHOULD BE TAKEN TO KEEP FROM CONTACTING SUCH POWER LINES OR CIRCUITS AS CONTACT WITH THEM IS ALMOST INVARIABLY FATAL.**

Be sure the antenna system is grounded so as to provide some protection against voltage surges and built-up static charges.

Section 810 of the National Electrical Code (NEC) in USA and Section 54 of the Canadian Electrical Code in Canada provides information with respect to proper grounding of the mast and supporting structure, grounding of the lead-in wire to an antenna discharge unit, size of grounding conductors, location of antenna discharge unit, connection to grounding electrodes, and requirements for the grounding electrode.



## Antenna Grounding According to the NEC

— Refer to section 54-300 of Canadian Electrical Code for Antenna Grounding.

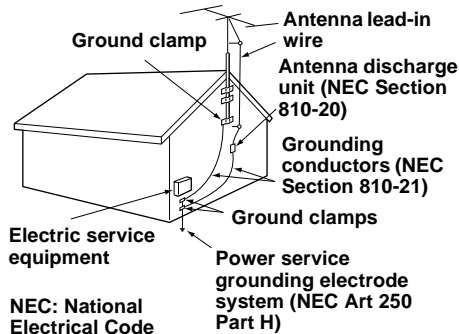

## Lightning

For added protection for this television receiver during a lightning storm, or when it is left unattended and unused for long periods of time, unplug it from the wall outlet and disconnect the antenna. This will prevent damage to the receiver due to lightning and power-line surges.

## Service

### Damage Requiring Service

Unplug the set from the wall outlet and refer servicing to qualified service personnel under the following conditions:



- When the power cord or plug is damaged or frayed.



- If liquid has been spilled into the set.



- If the set has been exposed to rain or water.



- If the set has been subject to excessive shock by being dropped, or the cabinet has been damaged.



- If the set does not operate normally when following the operating instructions. Adjust only those controls that are specified in the operating instructions.

Improper adjustment of other controls may result in damage and will often require extensive work by a qualified technician to restore the set to normal operation.

- When the set exhibits a distinct change in performance—this indicates a need for service.



### Servicing

Do not attempt to service the set yourself since opening the cabinet may expose you to dangerous voltage or other

hazards. Refer all servicing to qualified service personnel.

## Replacement Parts

When replacement parts are required, be sure the service technician certifies in writing that he has used replacement parts specified by the manufacturer that have the same characteristics as the original parts.

Unauthorized substitutions may result in fire, electric shock, or other hazards.

### Safety Check



Upon completion of any service or repairs to the set, ask the service technician to perform routine safety checks (as specified by the manufacturer) to determine that the set is in safe operating condition, and to so certify.



When the set reaches the end of its useful life, improper disposal could result in a picture tube implosion. Ask a qualified service technician to dispose of the set.

## Installing and Connecting the Projection TV

### Carrying Your Projection TV

Carrying the projection TV requires three or more people.

The projection TV has been equipped with casters for easy movement on a hard surface. Please move your projection TV using the casters.

### Installing the Projection TV

#### Recommended viewing area (Horizontal)

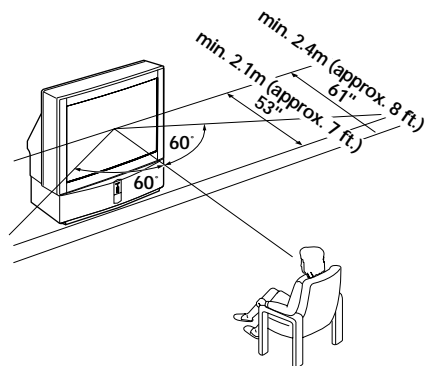

#### Recommended viewing area (Vertical)

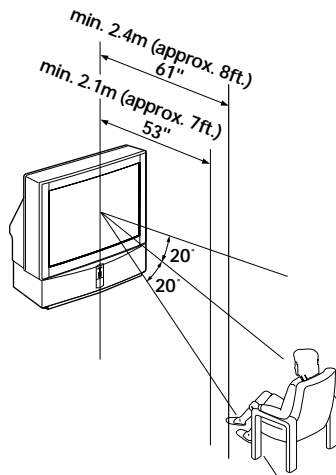

## Connector Types

You may find it necessary to use some of the following connector types during set up.

### Coaxial cable

Standard TV cable and antenna cable  
**Plug Type**



**Screw-on Type**



### S Video cable

High quality video cable for enhanced picture quality



### Audio/Video cable



Video - Yellow  
Audio (Left) - White  
Audio (Right) - Red

Some DVD Players are equipped with the following three video connectors.

Y - Green  
PB (CB, Cb or B-Y) - Blue  
PR (CR, Cr or R-Y) - Red

## Composite video cable for a DTV receiver



G/Y - Green  
 B/P<sub>B</sub> - Blue  
 R/P<sub>R</sub> - Red  
 HD - Gray  
 VD - Black

## CONTROL S cable

Sony cable for CONTROL S connections. These features are exclusive to Sony products and allow greater control of all Sony equipment.



RK-G34  
 (not supplied)

## About the CONTROL S IN/OUT jacks

To control other Sony equipment with the projection TV's remote control, connect the CONTROL S IN jack of the equipment to the CONTROL S OUT jack on the projection TV with the CONTROL S cable.

To control the projection TV with a remote control for another Sony product, connect the CONTROL S OUT jack of the equipment to the CONTROL S IN jack on the projection TV with the CONTROL S cable.

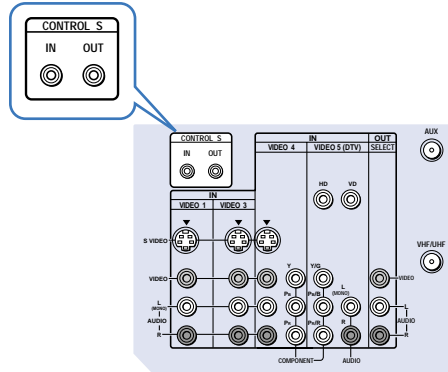

## Making Connections

### Connecting Directly to a Cable or an Antenna

The connection you choose will depend on the cable found in your home. Newer homes will be equipped with standard coaxial cable (see **A**); older homes will probably have 300-ohm twin lead cable (see **B**); still other homes may contain both (see **C**).

#### A

- VHF only  
or
- VHF/UHF  
or
- Cable

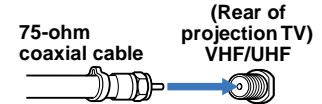

#### B

- VHF only  
or
- UHF only  
or
- VHF/UHF

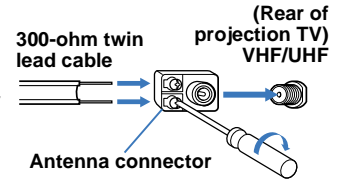

(continued)

## C

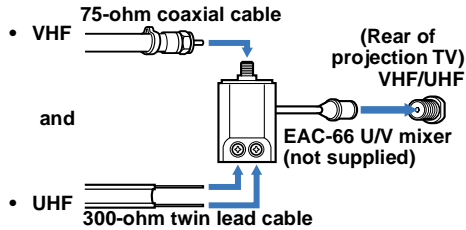

### Cable or antenna

This is the simplest connection. Connection is made directly from the cable or antenna to the projection TV.

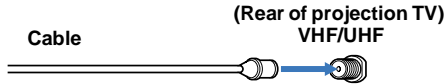

### Cable and antenna

You may find it convenient to use the following set up if your cable provider does not feature local channels that you are able to receive using an antenna.

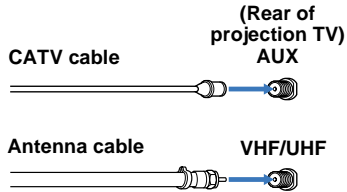

Select Cable or ANT mode by pressing ANT on the remote control.

## Connecting a Cable Box

Some pay cable TV systems use scrambled or encoded signals that require a cable box\* to view all channels.

Also, set CABLE to ON in the CHANNEL SET UP menu. (see page 38)

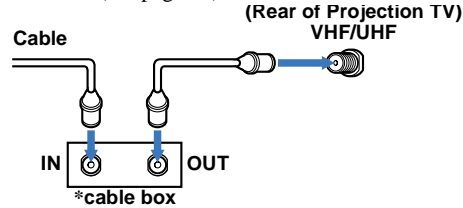

### Note:

- If you will be controlling all channel selection through your cable box, you should consider using the CHANNEL FIX feature. (see "CHANNEL FIX" on page 38)

### Cable box and cable

Some pay cable TV systems use scrambled or encoded signals requiring a cable box\* only for certain channels. (e.g. HBO, SHOWTIME, etc.)

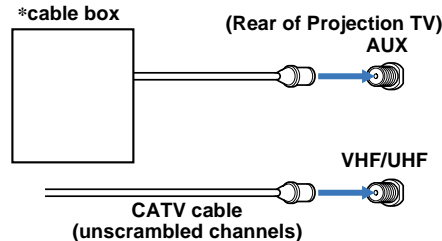

For this set up, you can switch between scrambled channels (through your cable box), and normal (CATV) channels by pressing ANT on your remote control.

### Notes:

- You may be able to program your Sony remote control to operate your cable box. (see "Operating a Cable Box or DBS Receiver" on page 55)
- During PIP, P&P, CHANNEL INDEX or FAVORITE CHANNEL viewing, the AUX input can only be viewed in the main picture.
- If you are connecting a cable box through the AUX input and would like to switch between the AUX and normal (CATV) input, you should consider using CHANNEL FIX. (see "CHANNEL FIX" on page 38)

## Connecting an Antenna/Cable TV System to a VCR

- 1 Attach the coaxial cable from the incoming cable connection or antenna to IN on the VCR.
- 2 Using a coaxial cable, connect OUT on the VCR to VHF/UHF on the projection TV.
- 3 Using AUDIO and S VIDEO\* cables, connect AUDIO and S VIDEO OUT on the VCR to AUDIO and S VIDEO IN on the projection TV (White-AUDIO Left, Red-AUDIO Right).

\* If your VCR is not equipped with S VIDEO, use a VIDEO cable (yellow) instead of the S VIDEO cable.

### Note:

- If you are connecting a monaural VCR, connect only the single audio output to the left (MONO) input on the projection TV.

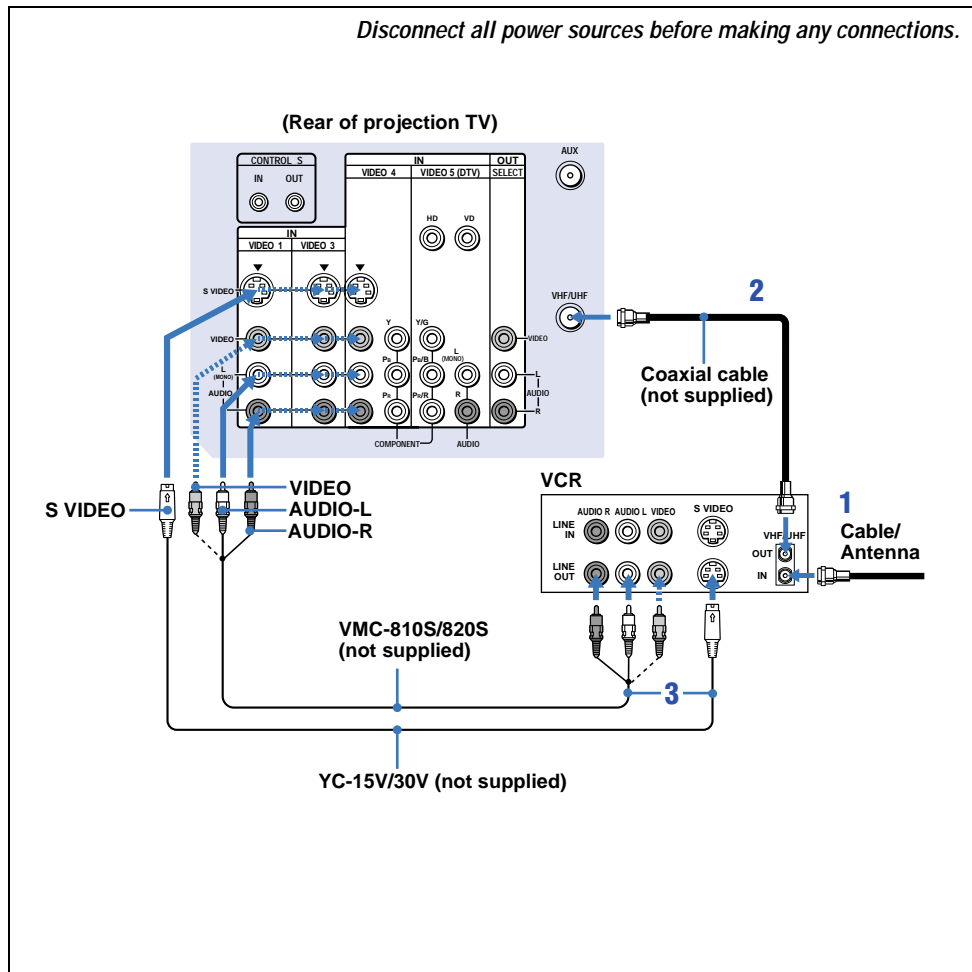

## Connecting a VCR and Projection TV to a Cable Box

- 1 Connect the single (input) jack of the splitter to the incoming cable connection, and connect the other two (output) jacks (using the coaxial cable) to IN on the cable box and VHF/UHF on the projection TV.
- 2 Using a coaxial cable, connect OUT on the cable box to IN on the VCR.
- 3 Using AUDIO and S VIDEO\* cables, connect AUDIO and S VIDEO OUT on the VCR to AUDIO and S VIDEO IN on the projection TV (White-AUDIO Left, Red-AUDIO Right).

\* If your VCR is not equipped with S VIDEO, use a VIDEO cable (yellow) instead of the S VIDEO cable.

### Note:

- To view scrambled channels through the cable box, select the video input which the cable box is connected to by pressing TV/VIDEO.

*Disconnect all power sources before making any connections.*

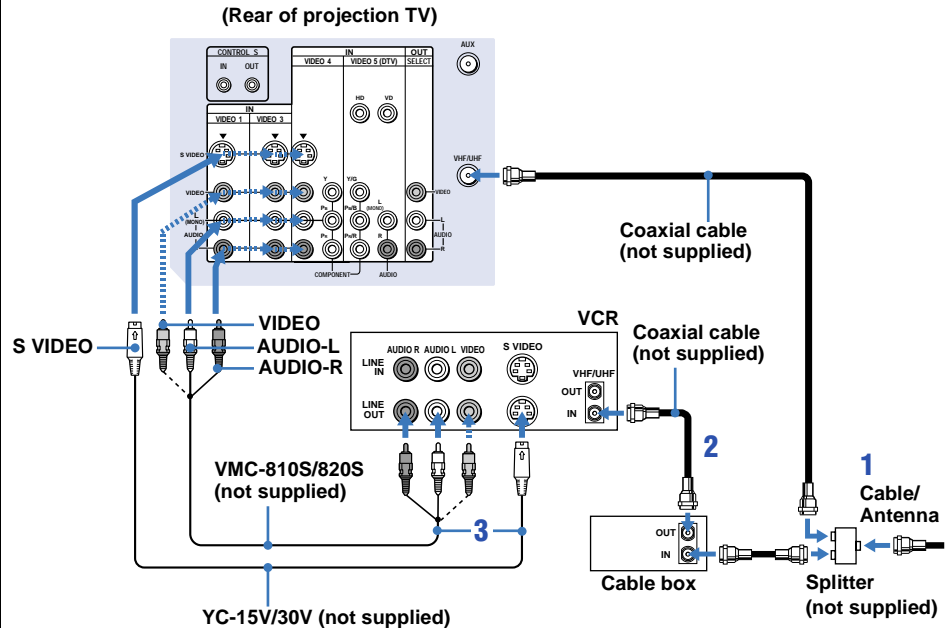

## Connecting a DTV (Digital Television) Receiver

Before connecting, be sure to read the Operating Instructions of the DTV receiver.

### Connecting a DTV (digital television) receiver with the G/B/R/HD/VD jacks

- 1 Attach the coaxial cable from the roof antenna to VHF/UHF on the DTV receiver.
- 2 Using a composite video cable for DTV receiver, connect G, B, R, HD and VD of VIDEO OUT on the DTV receiver to G, B, R, HD and VD respectively of VIDEO 5 (DTV) IN on the projection TV.  
If the DTV receiver is equipped with the Y/P<sub>B</sub>/P<sub>R</sub> jacks, proceed to step 2 in “Connecting a DTV (digital television) receiver with the Y/P<sub>B</sub>/P<sub>R</sub> (component video input) jacks” on page 12.
- 3 Using an AUDIO cable, connect AUDIO OUT on the DTV receiver to AUDIO of VIDEO 5 (DTV) IN on the projection TV (White-AUDIO Left, Red-AUDIO Right).
- 4 Select VIDEO 5 by the TV/VIDEO button.
- 5 Select the SET UP menu and set DTV INPUT to R.G.B. (see “DTV INPUT” on page 43)

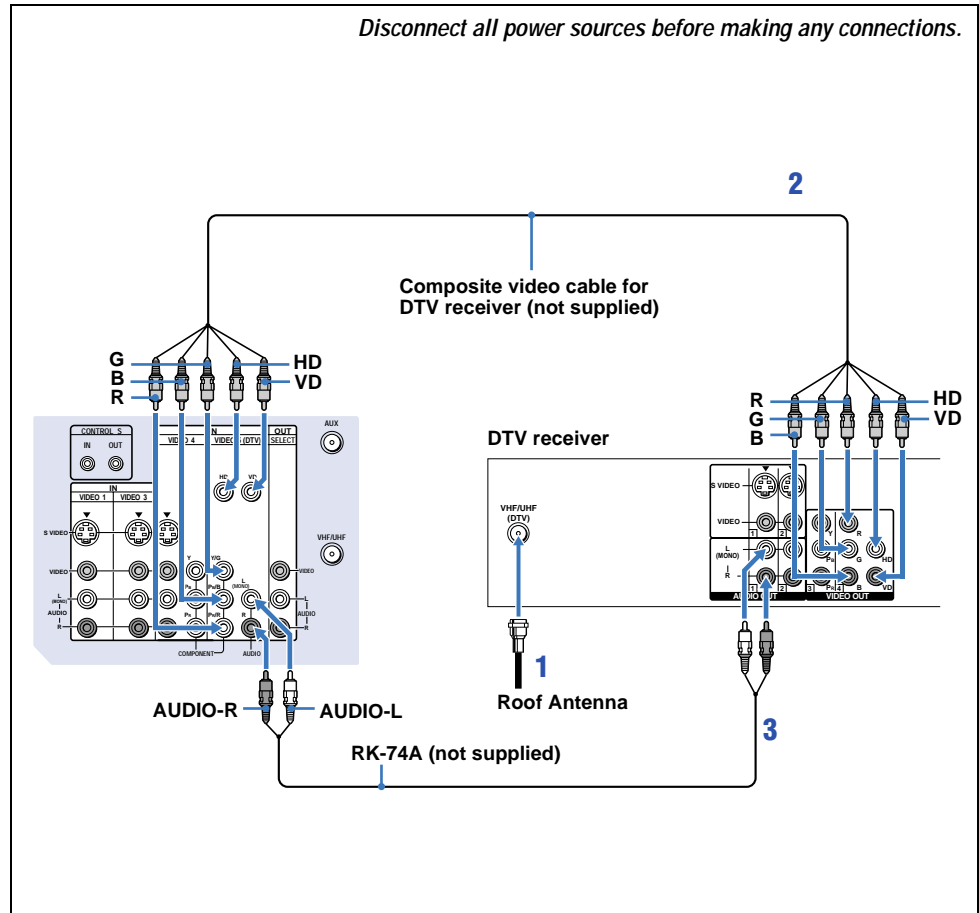

(continued)

## Connecting a DTV (digital television) receiver with the Y/P<sub>B</sub>/P<sub>R</sub> (component video input) jacks

- 1 Attach the coaxial cable from the roof antenna to VHF/UHF on the DTV receiver.
- 2 Using three VIDEO cables, connect Y, P<sub>B</sub> and P<sub>R</sub> of COMPONENT VIDEO OUT on the DTV receiver to Y, P<sub>B</sub> and P<sub>R</sub> of VIDEO 5 (DTV) IN on the projection TV.
- 3 Using an AUDIO cable, connect LINE OUT on the DTV receiver to AUDIO of VIDEO 5 (DTV) IN on the projection TV (White-AUDIO Left, Red-AUDIO Right).
- 4 Select VIDEO 5 by the TV/VIDEO button.
- 5 Select the SET UP menu and set DTV INPUT to Y PB PR. (see "DTV INPUT" on page 43)

### Note:

- Some DTV receiver terminals may be labeled differently. If so, connect as follows:  
Connect Y (green) to Y.  
Connect P<sub>B</sub> (blue) to C<sub>B</sub>, C<sub>b</sub> or B-Y.  
Connect P<sub>R</sub> (red) to C<sub>R</sub>, C<sub>r</sub> or R-Y.

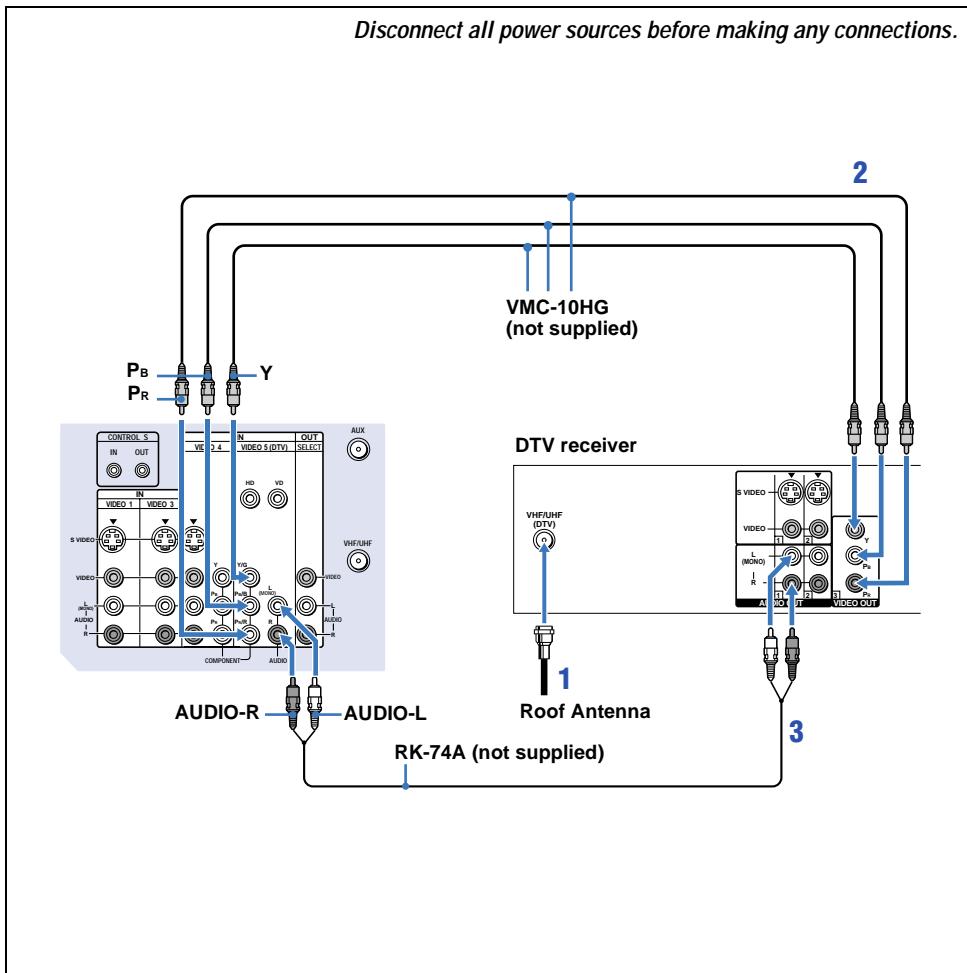



## Connecting a DBS (Direct Broadcast Satellite) Receiver

- 1 Connect the cable from the satellite antenna to the DBS receiver.
- 2 Attach the coaxial cable from the incoming cable connection or antenna to VHF/UHF on the projection TV.
- 3 Using AUDIO and S VIDEO cables, connect AUDIO and S VIDEO OUT on the DBS receiver to AUDIO and S VIDEO IN on the projection TV (White-AUDIO Left, Red-AUDIO Right).

### Note:

- To view input from the DBS, select the video input which the DBS receiver is connected to by pressing TV/VIDEO on the remote control.

Disconnect all power sources before making any connections.

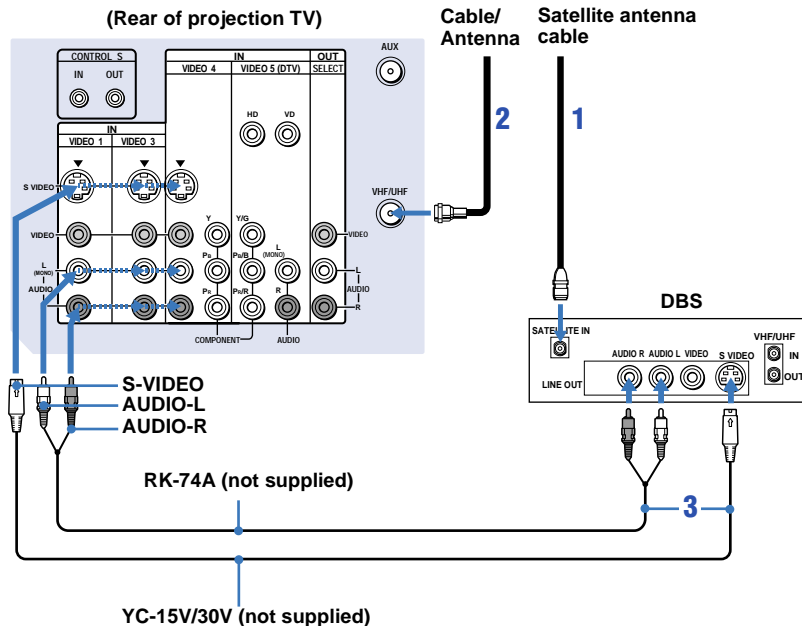

## Connecting a DBS (Direct Broadcast Satellite) Receiver and VCR

- 1 Connect the cable from the satellite antenna to the satellite receiver.
- 2 Attach the coaxial cable from the incoming cable connection or antenna to VHF/UHF IN on the VCR.
- 3 Using a coaxial cable, connect VHF/UHF OUT on the VCR to VHF/UHF on the projection TV.
- 4 Using AUDIO and S VIDEO\* cables, connect AUDIO and S VIDEO OUT on the DBS receiver to AUDIO and S VIDEO IN on the projection TV.
- 5 Using AUDIO and S VIDEO\* cables, connect AUDIO and S VIDEO OUT on the VCR to AUDIO and S VIDEO IN on the projection TV (White-AUDIO Left, Red-AUDIO Right).

\* If your VCR or DBS receiver is not equipped with S VIDEO, use a VIDEO cable (yellow) instead of the S VIDEO cable.

### Note:

- To view input from the DBS or VCR, select the video input which your DBS receiver or VCR is connected to by pressing TV/VIDEO on the remote control.

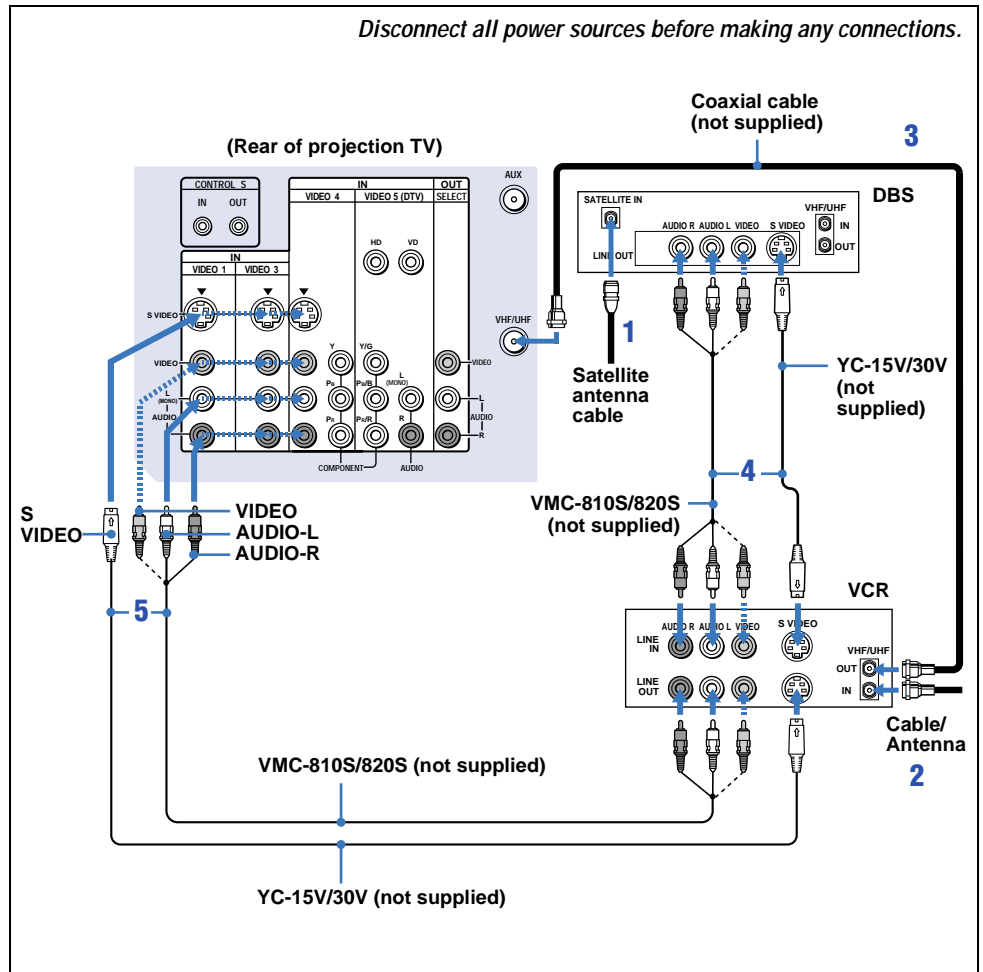

## Connecting a Camcorder

Use this connection to view a picture directly from your camcorder.

- 1 Using AUDIO and S VIDEO\* cables, connect AUDIO and S VIDEO OUT on the camcorder to AUDIO and S VIDEO IN inside the lower front panel on the projection TV (White-AUDIO Left, Red-AUDIO Right\*\*).
- 2 Press VIDEO 2 to select the video inputs from a camcorder.

\* If your camcorder is not equipped with S VIDEO, use a VIDEO cable (yellow) instead of the S VIDEO cable.

\*\*If you are connecting a monaural camcorder, connect only the single audio output to the left (MONO) input on the projection TV.

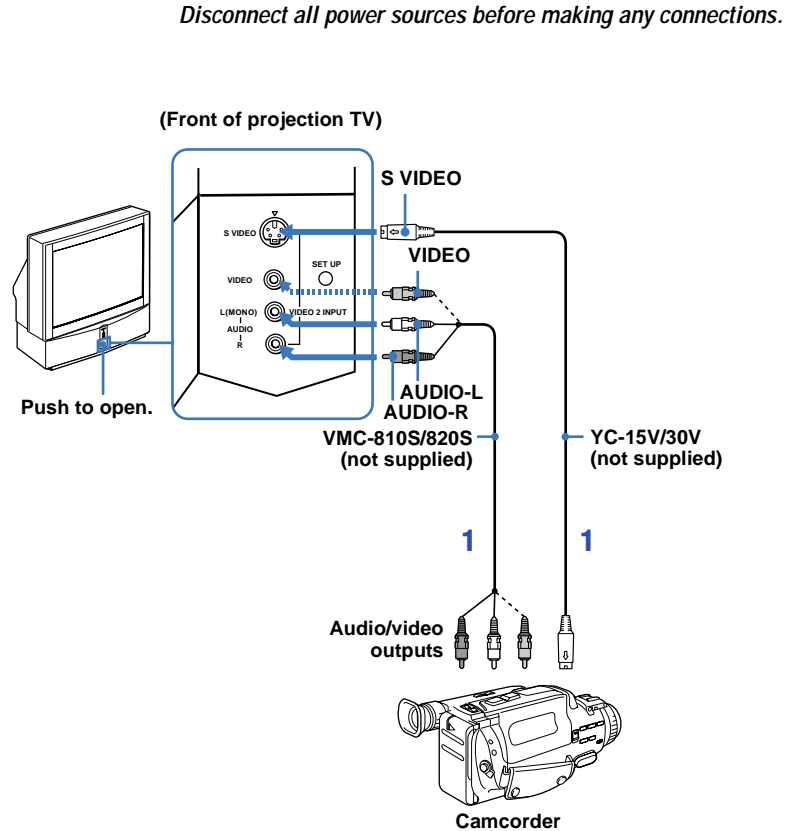

## Connecting Two VCRs for Tape Editing

SELECT OUT gives you the ability to use a second VCR to record a program being played by the primary VCR or to perform tape editing and dubbing.

- 1 Connect the VCR intended for playback using the connection instructions on page 9 of this manual.
- 2 Using an AUDIO/VIDEO cable, connect AUDIO and VIDEO IN on the VCR intended for recording to AUDIO and VIDEO OUT of SELECT OUT on the projection TV.

### Notes:

- Do not change the input signal while editing through SELECT OUT.
- When connecting a single VCR to the projection TV: if VCR LINE OUT is connected to VIDEO IN on the projection TV, do not connect the SELECT OUT on the projection TV to the VCR LINE INPUT (see right). Doing so will cause program interference and other viewing problems.
- You can select the output signal from SELECT OUT from the SET UP menu. (see "SELECT OUT" on page 41)

*Disconnect all power sources before making any connections.*

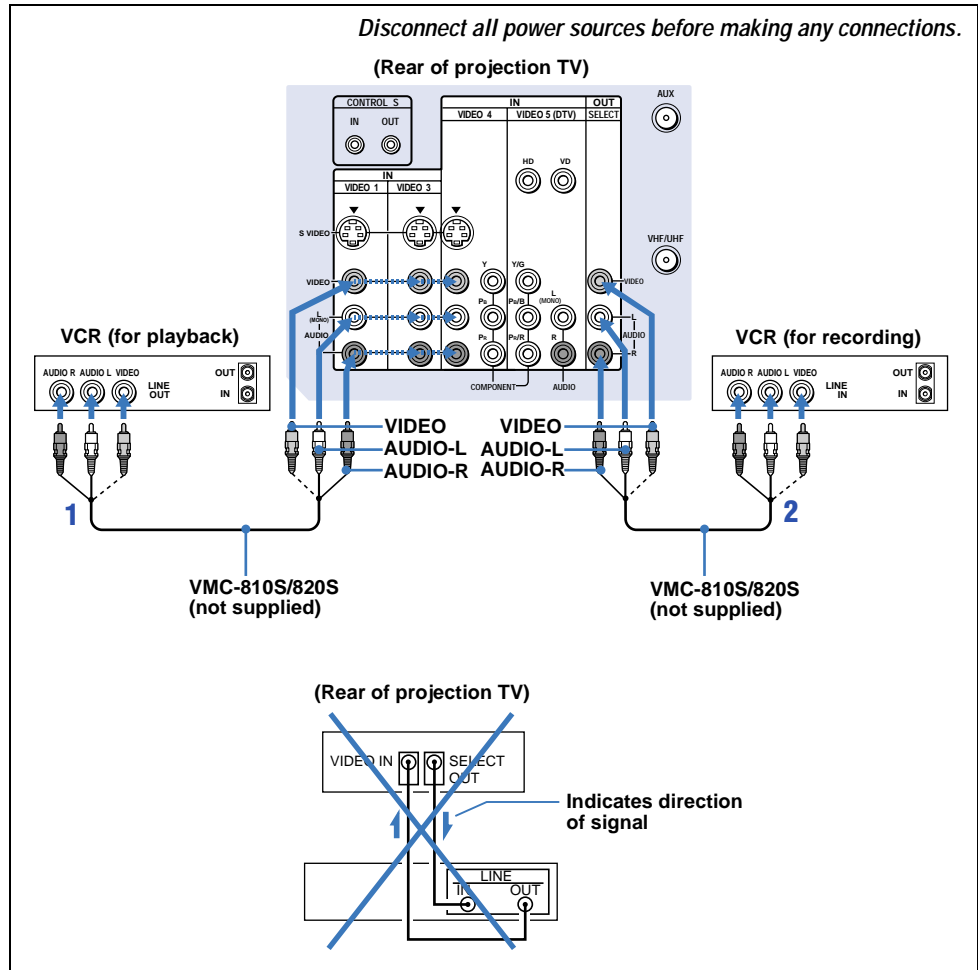

## Connecting a DVD Player With S Video or Composite Video Output Connectors

Using an AUDIO and S VIDEO cables, connect AUDIO and S VIDEO IN on the projection TV to AUDIO and S VIDEO OUT on the DVD Player (White-AUDIO Left, Red-AUDIO Right).

### Note:

- Since the high quality pictures on a DVD disc contain a lot of information, picture noise may appear. In this case, adjust NR in the VIDEO menu. (see “NR” on page 35)

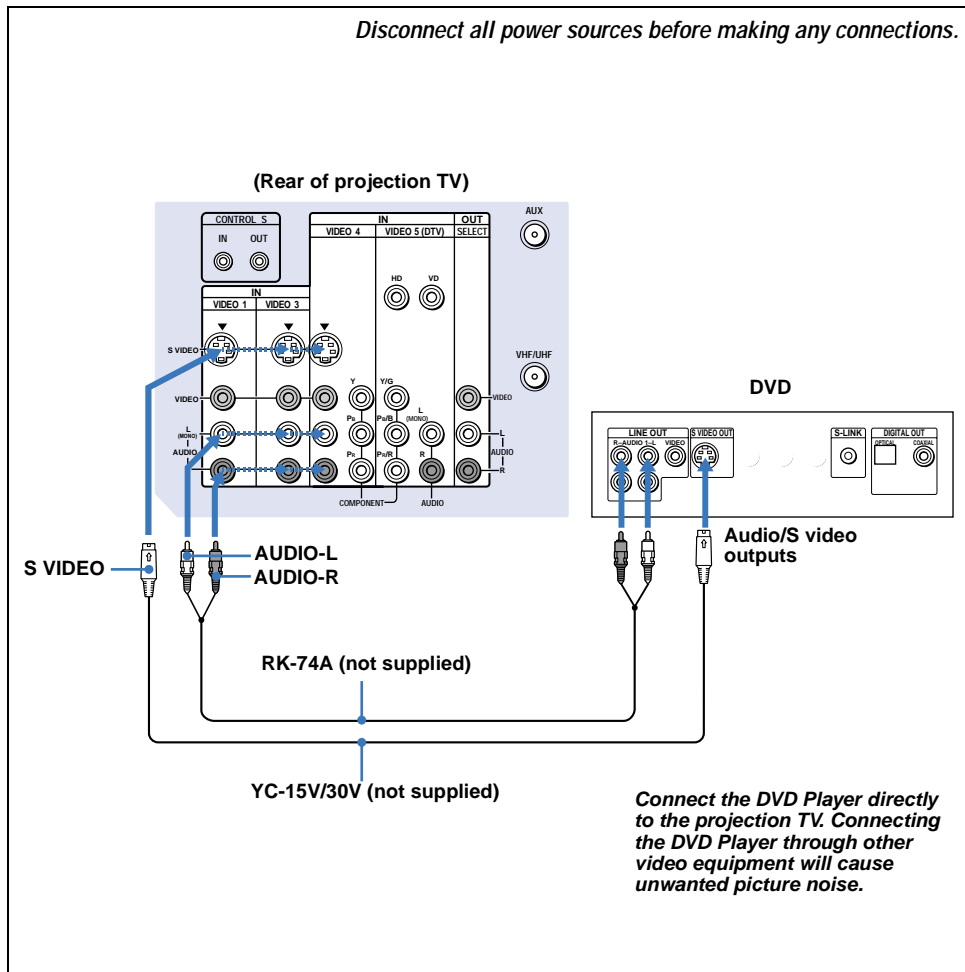

## Connecting a DVD Player With Component Video Output Connectors

- Using an AUDIO cable, connect AUDIO R and L of LINE OUT on the DVD Player to AUDIO R and L of VIDEO 4 IN or VIDEO 5 (DTV) IN on the projection TV (White-AUDIO Left, Red-AUDIO Right).
- Using three VIDEO cables, connect Y, P<sub>B</sub> and P<sub>R</sub> of the COMPONENT VIDEO OUT on the DVD Player to Y, P<sub>B</sub> and P<sub>R</sub> of VIDEO 4 IN or VIDEO 5 (DTV) IN on the projection TV.

### Notes:

- If your DVD Player has 480p format capability, connect it to the Y, P<sub>B</sub> and P<sub>R</sub> of VIDEO 5 (DTV) IN on the projection TV.
- Some DVD Player terminals may be labeled differently. If so, connect as follows:  
Connect Y (green) to Y.  
Connect P<sub>B</sub> (blue) to C<sub>B</sub>, C<sub>b</sub> or B-Y.  
Connect P<sub>R</sub> (red) to C<sub>R</sub>, C<sub>r</sub> or R-Y.
- Since the high quality pictures on a DVD disc contain a lot of information, picture noise may appear. In this case, adjust NR in the VIDEO menu. (see "NR" on page 35)

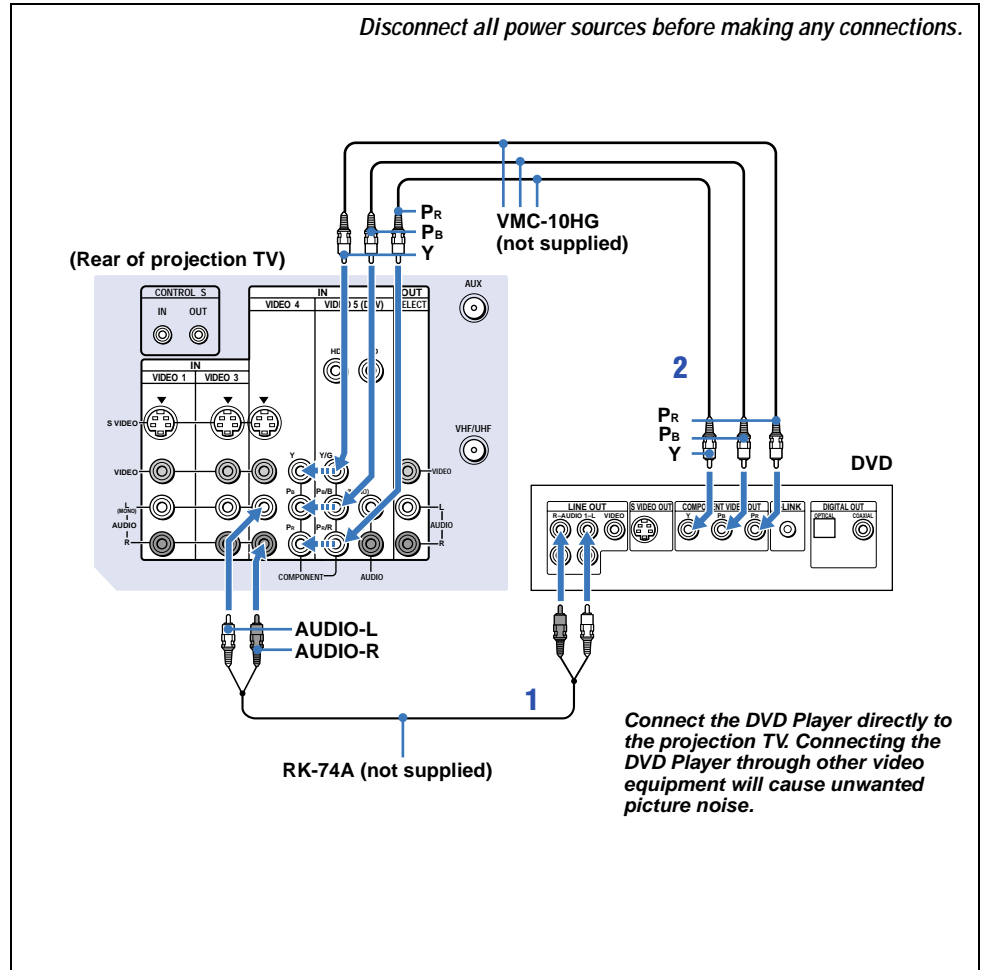

## Connecting an AV Receiver

For greater control of all audio and video equipment, connect an AV receiver.

- 1-2 Perform as described on page 9.
- 3 Using a VIDEO cable, connect VIDEO of VIDEO 1 IN on the projection TV to MONITOR OUT on the AV receiver.
- 4 Using an AUDIO/VIDEO cable, connect SELECT OUT on the projection TV to AUDIO/VIDEO 2 IN on the AV receiver.
- 5 Using an AUDIO/VIDEO cable, connect the video equipment to the AV receiver.
- 6 Select the SET UP menu and set SELECT OUT to TV OUT. (see "SELECT OUT" on page 41)

### Note:

- You may want to use CHANNEL FIX to fix your projection TV's input to the AV receiver (VIDEO 1). (see "CHANNEL FIX" on page 38)

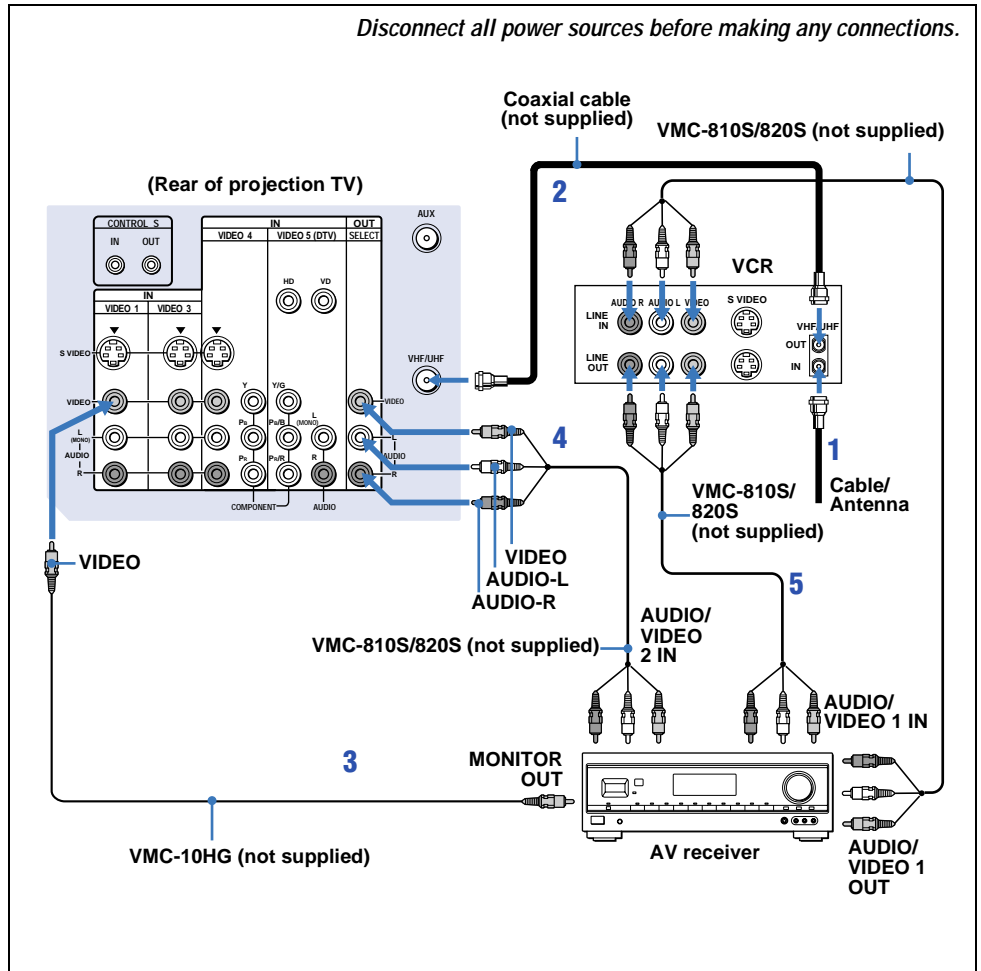

## Connecting an Audio System

For more dynamic sound, connect an audio system to the projection TV.

- 1 Using an AUDIO cable, connect AUDIO (VAR) OUT on the projection TV to one of the unused Line inputs (e.g. Tape-2, AUX1, etc.) on the stereo (White-AUDIO Left, Red-AUDIO Right).
- 2 Set the stereo to the chosen Line input and use the AUDIO menu to switch the projection TV's speakers off. (see "SPEAKER" on page 36)

### Note:

- You can adjust VOLUME, BASS, TREBLE and BALANCE through the projection TV on AUDIO (VAR) OUT only.

*Disconnect all power sources before making any connections.*

(Rear of projection TV)

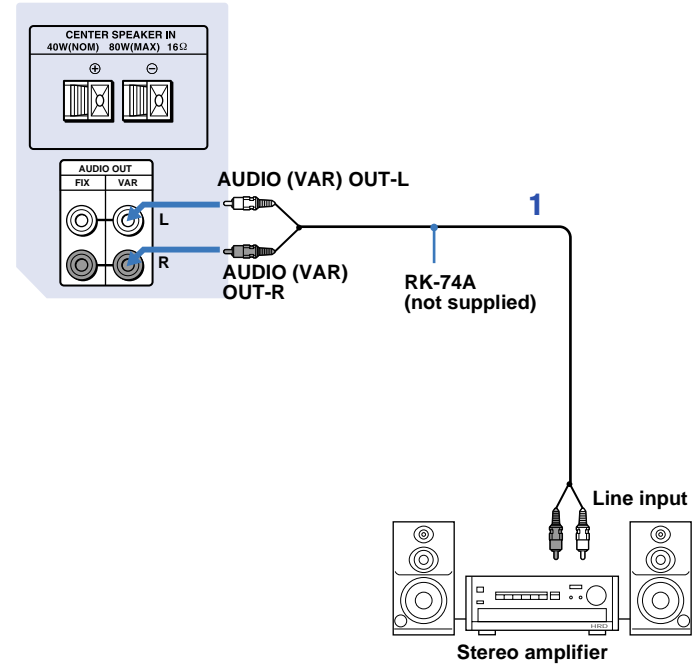



## Connecting an Amplifier That Supports Dolby Pro Logic Decoder

If you use an amplifier with a Dolby Pro Logic decoder instead of the projection TV's audio system, you can still use the projection TV's speaker as a center speaker.

- 1 Using the speaker cords (supplied with the amplifier), connect the speaker terminals on the amplifier to CENTER SPEAKER IN +/- on the projection TV.
- 2 Using an AUDIO cable, connect AUDIO (FIX) OUT on the projection TV to one of the unused Line inputs (e.g. Tape-2, AUX1, etc.) on the amplifier (White-AUDIO Left, red-AUDIO Right).
- 3 Set the amplifier to the chosen Line input and use the AUDIO menu to set "SPEAKER" to "CENTER IN" on the projection TV. (see "SPEAKER" on page 36)

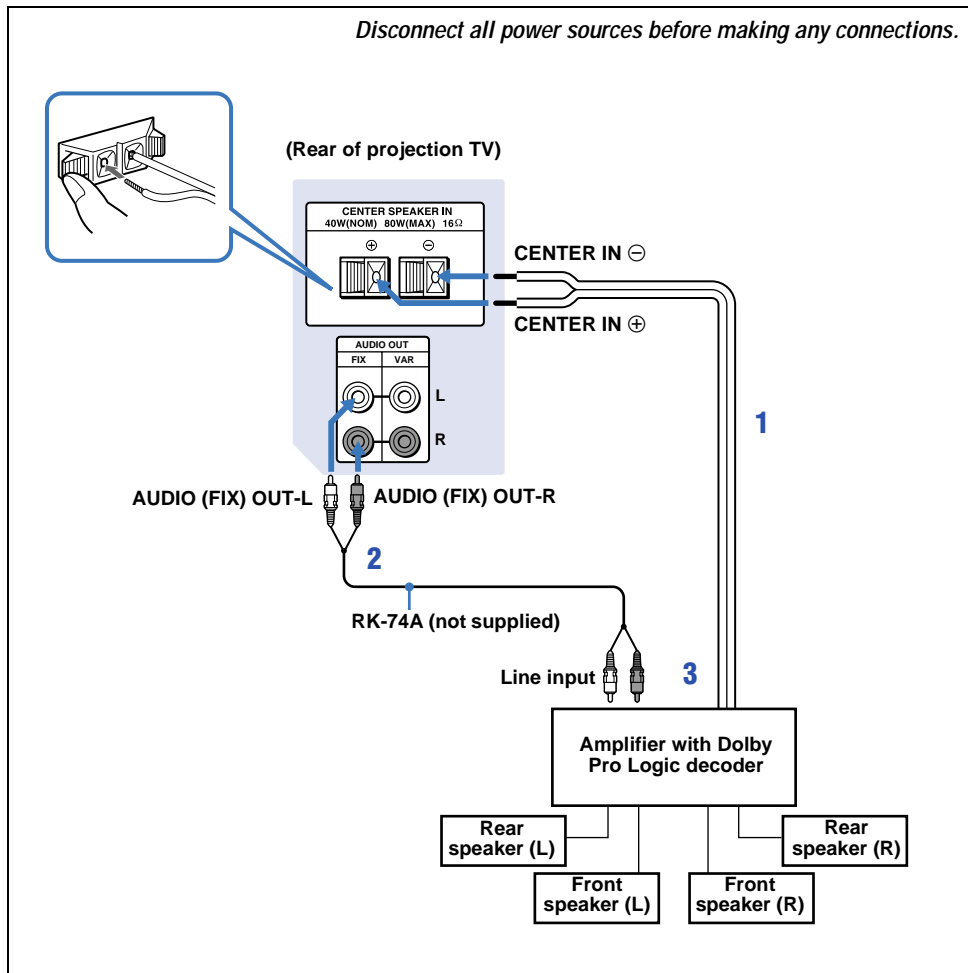

### Using the Remote Control

#### Inserting the batteries

Insert two size AA (R6) batteries (supplied) by matching the + and - on the batteries to the diagram inside the remote control's battery compartment.

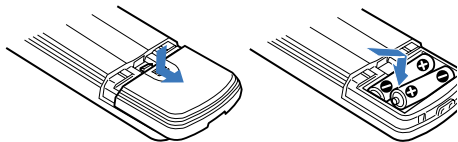

#### Notes:

- Remove the batteries to avoid damage from possible battery leakage whenever you anticipate that the remote control will not be used for an extended period.
- Handle the remote control with care. Avoid dropping it, getting it wet, or placing it in direct sunlight, near a heater or where the humidity is high.
- Your remote control can be programmed to operate most video equipment. (see "Operating Video Equipment" on page 53)

### Using the remote control joystick

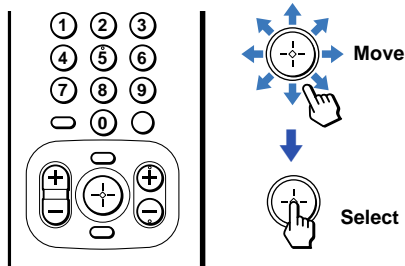

The supplied remote control has a joystick which moves the on-screen selector in eight directions. In most cases, moving the joystick up, down, left or right will cause the selector to move in the selected direction.

In some cases, the selector may move in eight directions according to the function. Pressing down on the center of the joystick (+) will activate the selected item.

You may also move the joystick right to activate a selected item. (There are some exceptions to this option.)

### Adjusting sliders

When menu items present a slider (■ or ▬), move the joystick up, down, left or right to adjust the setting.

### On-line help/instructions

Several menu windows will provide prompts and instructions to assist you in navigating through the different functions.

# Setting Up the Projection TV Automatically

The AUTO SET UP feature will allow you to set the on-screen language and set all receivable channels.

*The AUTO SET UP feature does not apply for installations that use a cable box for all channel selection.*

*You can also set up the projection TV manually. (see "Using the CHANNEL SET UP Menu" on page 37)*

## Notes:

- Perform this function during the day, with the antenna and/or cable properly connected, to ensure that all available channels will be broadcasting and receivable.
- Before you perform AUTO SET UP again, make sure that the input from ANT (not AUX) is selected by pressing ANT until "AUX" does not appear next to the channel number.
- When you perform AUTO PROGRAM, your CHANNEL FIX and ON/OFF TIMER settings will be erased.
- When you perform AUTO PROGRAM, all the settings in the VIDEO and AUDIO menus are reset to the factory settings.

Using the buttons on the front panel and inside the lower front panel on the projection TV:

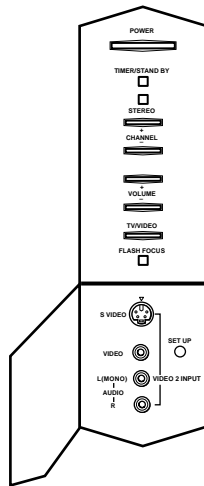

1 Press POWER to turn on the projection TV.

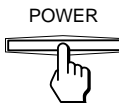

2 Press SET UP inside the lower front panel. The AUTO SET UP screen appears.

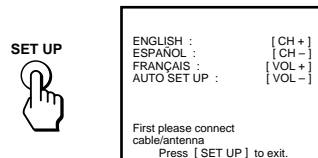

3 Press CHANNEL + to select English, CHANNEL - to select Spanish or VOLUME + to select French.

The screen will change to reflect your choice.

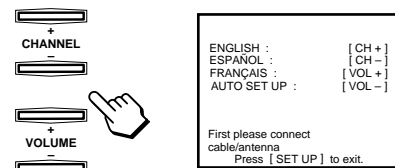

4 Press VOLUME - to continue.

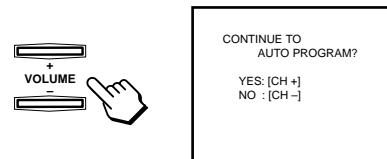

(continued)

- 5 Press CHANNEL + to preset channels automatically.

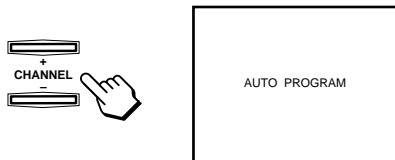

“AUTO PROGRAM” appears and the projection TV starts scanning and presetting channels automatically. While scanning, the received channel will be displayed on the sub screen. When all the receivable channels are stored, the lowest numbered channel will be displayed.

### If your projection TV is not connected to a cable system

If you perform AUTO SET UP, CABLE is set to ON automatically. After finishing AUTO SET UP, set CABLE to OFF in the CHANNEL SET UP menu, then set AUTO PROGRAM to YES to perform automatic channel presetting. (see “CABLE” and “AUTO PROGRAM” on page 38)

### To perform AUTO SET UP again

- Press SET UP inside the lower front panel on the projection TV, and perform steps 3-5 on page 23.
- Press CHANNEL +, CHANNEL – or VOLUME + to select a language.
- Press VOLUME – to restore factory settings (“CONTINUE TO AUTO PROGRAM?” will appear on the screen. Press CHANNEL + to execute or CHANNEL – to exit).
- Press SET UP to exit.

## Adjusting the Convergence Automatically (FLASH FOCUS)

The projection tube image appears on the screen in three layers (red, green and blue). If they do not converge, the color is poor and the picture blurs.

Before you use your projection TV, be sure to adjust the convergence.

The FLASH FOCUS feature allows you to adjust the convergence automatically.

### Tip

- It is recommended to perform FLASH FOCUS about 30 minutes after the projection TV is first turned on.

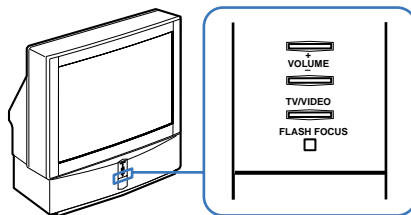

- 1 Receive a TV or cable TV program.
- 2 Press FLASH FOCUS.

FLASH FOCUS



The cross pattern appears and FLASH FOCUS begins to work. The adjustment is completed when the cross pattern becomes white.

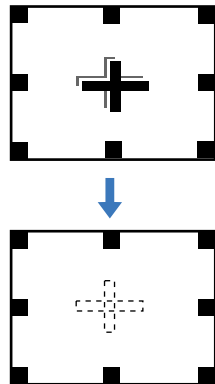

### To obtain an optimum convergence

The optimum convergence alignment varies with digital TV formats. Therefore, perform FLASH FOCUS periodically on conventional and digital TV programs. Also, whenever you find that the picture blurs, press FLASH FOCUS.

### Notes:

- You cannot perform any other functions until FLASH FOCUS has completed its cycle.
- If you perform any other operation while FLASH FOCUS is in progress, FLASH FOCUS operation is canceled.

### Watching the TV

Many TV features can be accessed directly through the remote control. The following will explain the function of some buttons found on your remote control.

### Using the white labeled buttons for projection TV operations



REFER TO THE ILLUSTRATION OF THE REMOTE CONTROL ON THE INSIDE FRONT COVER OF THIS MANUAL AS YOU REVIEW THE FOLLOWING DESCRIPTIONS

#### TV (FUNCTION)

Activates the remote control for use with the projection TV.

#### ANT — (AUX input)

Press to change between the VHF/UHF input and the AUX input. (for detailed connection information, see “Cable and antenna” or “Cable box and cable” on page 8).

#### TV POWER

Turns the projection TV on and off. If a video input indication (e.g., VIDEO 1, VIDEO 2) appears on the screen, press TV/VIDEO until a channel number appears.

#### 0 - 9 and ENTER

Use for direct channel selection. Press 0-9 to select a channel (for example, to select channel 10, press 1 and 0). The channel will change after 2 seconds, or you can press ENTER for immediate selection.

#### CH +/-

Press to scan through the channels (+ up or – down).

#### VOL +/-

Press to adjust the volume (+ up or – down).

#### JUMP

Press to alternate or jump back and forth between two channels. The projection TV will jump between the current channel and the last channel selected using the 0-9 buttons.

#### MUTING

Press to mute the sound. “MUTING” will appear on the screen and will dim three seconds later. To restore sound, press again or press VOL +.

#### FREEZE

— (yellow labeled button)

This is useful when you need to copy down information that appears on the TV’s screen.

Press to freeze the picture.

Press again or press (OFF) to cancel.

If you select TWIN as a FREEZE MODE in the SET UP menu, you can freeze the desired scene and display it on the left while viewing the normal picture on the right. (see “FREEZE MODE” on page 42)

(continued)

### Notes:

- The FREEZE button does not function with the picture from VIDEO 5 (DTV) IN.
- If the frozen picture mode is not canceled for more than an hour, the normal picture is resumed automatically.

### SLEEP

Press repeatedly until the projection TV displays the approximate time in minutes (30, 60, or 90) that you want the projection TV to remain on before shutting off automatically.

Cancel by pressing until “SLEEP OFF” appears.

### DISPLAY

Press to display the channel number, current time, channel caption (if set), and MTS mode (if SAP is selected). The SAP indication disappears and the other indications dim three seconds later.

To turn the display off, press DISPLAY again.

### CC

Press repeatedly to scroll through available displays:

#### XDS (Extended Data Service)

Displays a network name, program name, program type, program length, program description, call letters and time of the show if the broadcaster offers this service.

#### Caption Vision

Displayed on the screen if the broadcaster offers this service. (see “CAPTION VISION” on page 41)

#### No display

“OFF” appears and the display is canceled.

### TV/VIDEO

Press repeatedly to scroll through available video inputs:

#### TV, VIDEO 1, VIDEO 2, VIDEO 3, VIDEO 4 and VIDEO 5

If you select SKIP as a VIDEO LABEL in the SET UP menu, your projection TV will skip the video input you selected. (see “VIDEO LABEL” on page 42)

### MTS

Press to scroll through the Multi-channel TV Sound (MTS) options. (see “MTS” on page 35)

### PICTURE MODE

Press PICTURE MODE repeatedly to directly choose one of five different video modes that best suits the program you are watching.

#### VIVID:

Select for enhanced picture contrast and sharpness.

#### STANDARD:

Select to display a standard picture for normal viewing environments.

#### MOVIE:

Select to display a finely detailed picture for low light environments.

#### GAME:

Select to display graphics such as a video game.

#### PRO (Professional):

Select to display a picture with minimum enhancements.

When you select each mode, you can also adjust the picture quality (such as BRIGHTNESS, COLOR, etc.) to suit your taste.

*For details, see “MODE” on page 34.*

## Watching Digital TV

When you have connected the DTV receiver, you can enjoy digital TV programs. This projection TV is capable of receiving the 1080i, 480p and 480i digital TV formats.

### Note:

- This projection TV is not suitable for 720p digital TV format. When a 720p format signal is received, the picture will dim and “This signal is not available” is displayed on the screen.

### To view a digital TV program

- 1 Connect the DTV receiver to VIDEO 5 (DTV) IN on the projection TV. (for details, see pages 11 and 12)
- 2 Press TV/VIDEO to select VIDEO 5. The digital TV format being received is displayed on the screen for three seconds.

### Note:

- You cannot select VIDEO 5 unless a DTV receiver is connected.

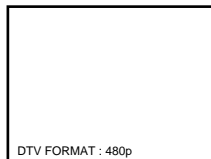

- 3 Select a digital channel on the DTV receiver. For details, see the Operating Instructions of the DTV receiver.



*The optimum convergence alignment varies with digital TV formats. Whenever you find that the picture blurs, press FLASH FOCUS. (for details, see page 24)*

### If the picture appears stretched vertically

Select the SET UP menu and set ASPECT RATIO to 16:9. (for details, see page 43)

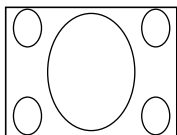

**16:9 picture  
(ASPECT RATIO is  
set to 4:3.)**

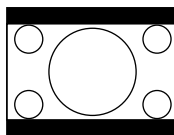

**16:9 picture  
(ASPECT RATIO is  
set to 16:9.)**

### If the picture appears compressed vertically

Select the SET UP menu and set ASPECT RATIO to 4:3. (for details, see page 43)

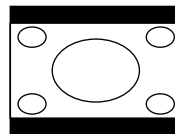

**4:3 compressed  
picture (ASPECT  
RATIO is set to 16:9.)**

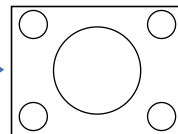

**4:3 picture  
(ASPECT RATIO is  
set to 4:3.)**

# Watching Two Programs at One Time — PIP

The Picture-in-Picture (PIP) feature allows you to view two channels simultaneously, one in the full size “main” picture and one in a smaller “window” picture.

You can move the window picture to any location on the screen (Free Layout PIP).

### Note:

- The PIP feature is not available for the inputs from VIDEO 5 (DTV) IN.

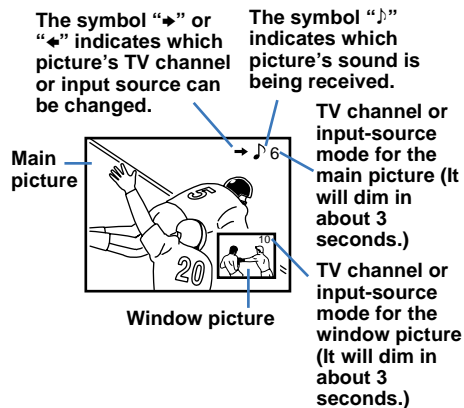

## Using the yellow labeled buttons for PIP operations



REFER TO THE ILLUSTRATION OF THE REMOTE CONTROL ON THE INSIDE FRONT COVER OF THIS MANUAL AS YOU REVIEW THE FOLLOWING DESCRIPTION

### Tip

If you press RESET in PIP mode, the window picture will move to the bottom right (factory-preset location).



Press to display a window picture.

Each time you press this button, the picture size will change (1/4 → 1/9 → 1/16).



Press **OFF** to close the window picture.

### POSITION



Press to change the location of the window picture (counterclockwise) around the main picture.



— (white labeled button)

To change the location of the window picture, move the joystick in any direction and release it when the picture is in the desired location.

### ACTIVE



Press to select either the main or window picture in order to change the TV channel or video source using the white labeled buttons below. The symbol “↔” (or “↔”) will appear to indicate which picture’s channel or input mode can be changed.

### TV/VIDEO



— (white labeled button)

Press repeatedly to scroll through the available video inputs for the picture on which the symbol “↔” (or “↔”) is displayed. (see “TV/VIDEO” on page 26)

### CH

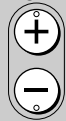

or



and ENTER



— (white labeled button)

Press to select the TV channel on which the symbol “↔” (or “↔”) is displayed. (for details, see “Watching the TV” on page 25)

### ANT



— (white labeled button)

Press to change between the VHF/UHF input and the AUX input for the picture on which the symbol “↔” (or “↔”) is displayed.



## AUDIO



Press to alternate sound between the main picture and the window picture. The symbol “♪” will appear for a few seconds to indicate which picture’s sound is being received.

## FREEZE



This is useful when you need to copy down information that appears on the TV’s screen.

Press to freeze the main and window pictures. The symbols “▶” and “♪” and the channel number disappear.

Press again to resume PIP viewing. Press **OFF** to cancel and resume normal TV viewing.

### Note:

- The FREEZE button does not function with digital TV programs.

## SWAP



Press to switch the audio and video of the main picture and the window picture.

Each time you press SWAP, the picture and sound of the two will be exchanged.



Press to access CHANNEL INDEX for direct channel selection. (see “Using CHANNEL INDEX” on page 31)



Press to cancel the PIP function and return to normal viewing.

### Notes:

- If one of the pictures received through PIP is snowy, the entire screen may become unstable. In this case, erase the snowy channel. (see “CHANNEL SKIP” on page 37)
- If you select VIDEO 5 when the main picture is active, the window picture disappears and you can view the picture from VIDEO 5 (DTV) IN. When the window picture is active, you cannot view the picture from VIDEO 5 (DTV) IN.

## Watching Two Programs at One Time — P&P (Twin View™)

The Picture-and-Picture (P&P) feature allows you to view two channels simultaneously, both in a reduced size screen. The main picture will appear on the right.

You can change the size of both pictures to suit your personal preference.

### Note:

- The P&P feature is not available for the inputs from VIDEO 5 (DTV) IN.

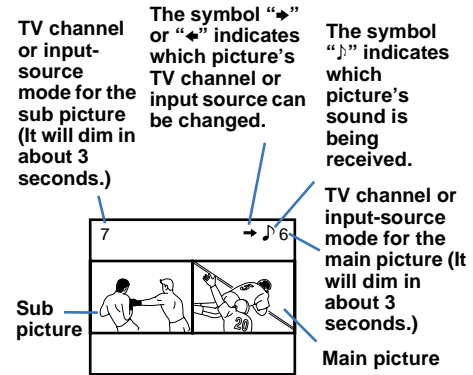

(continued)

## Using the yellow labeled buttons for P&P operations

 REFER TO THE ILLUSTRATION OF THE REMOTE CONTROL ON THE INSIDE FRONT COVER OF THIS MANUAL AS YOU REVIEW THE FOLLOWING DESCRIPTIONS

### Tip

If you press RESET in P&P mode, the right and left pictures will be reset to the same size (factory-preset size.)



Press to display right (main) and left pictures.

Press **OFF** to close the sub picture.



— (white labeled button)

Press and hold either RIGHT or LEFT to zoom in on the selected picture.

Release at the desired size. The other picture will be zoomed out simultaneously.

Moving the joystick right or left will activate the same function.

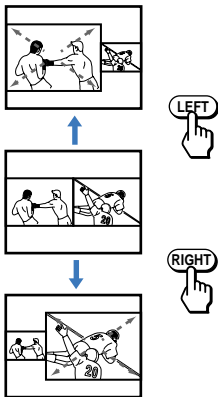

### ACTIVE



Press to select either the right or left picture in order to change the TV channel or video source using the white labeled buttons below. The symbol “▶” (or “◀”) will appear to indicate which picture’s channel or input mode can be changed.

### TV/VIDEO — (white labeled button)



Press repeatedly to scroll through the available video inputs for the picture on which the symbol “▶” (or “◀”) is displayed. (see “TV/VIDEO” on page 26)

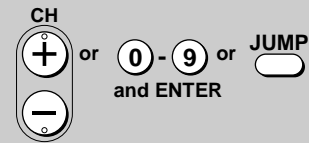

— (white labeled button)

Press to select the TV channel on which the symbol “▶” (or “◀”) is displayed. (for details, see “Watching the TV” on page 25)

### ANT — (white labeled button)



Press to change between the VHF/UHF input and the AUX input for the picture on which the symbol “▶” (or “◀”) is displayed.

### AUDIO



Press to alternate sound between the right and left pictures. The symbol “J” will appear for a few seconds to indicate which picture’s sound is being received.

### FREEZE



This is useful when you need to copy down information that appears on the TV’s screen.

Press to freeze both the right and left pictures.

Press again to resume P&P viewing or press **OFF** to cancel and resume normal TV viewing.

## SWAP



Press to switch the audio and video of the right and left pictures.

Each time you press SWAP, the picture and sound of the two will be exchanged.

## OFF

Press to cancel the P&P function and return to normal viewing.

### Notes:

- If one of the pictures received through P&P is snowy, the entire screen may become unstable. In this case, erase the snowy channel. (see "CHANNEL SKIP" on page 37)
- If you select VIDEO 5 when the right picture is active, the left picture disappears and you can view the picture from VIDEO 5 (DTV) IN. When the left picture is active, you cannot view the picture from VIDEO 5 (DTV) IN.

# Using CHANNEL INDEX

You can use the CHANNEL INDEX feature to display multiple channels and select one directly.

Channels used for the CHANNEL INDEX will come directly from the TV's list of receivable channels (those set during AUTO PROGRAM or through the CHANNEL SET UP menu).

### Note:

- The CHANNEL INDEX feature is not available for the inputs from VIDEO 5 (DTV) IN.

- 1 Press .

The current channel will be reduced in size and displayed in the center of the screen in normal motion picture format. The first twelve receivable channels will appear one after another, clockwise, around the center picture. These small pictures are updated in intervals of one second. The channel number and channel caption (if set) on the second and later appearances will dim.

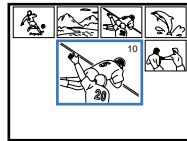

A cyan-colored frame will appear to indicate current channel selection.

- 2 Move the joystick in any direction to move the cyan frame to the picture that you wish to view, and press .

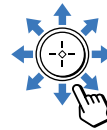

The selected channel will zoom in and move to the center, and the sound of that channel will be heard.



- 3 If you wish to view another channel, repeat step 2.

To view the normal picture of the selected channel, proceed to step 4.

- 4 Press .

The center picture will be enlarged for normal viewing.



(continued)

## Notes:

- You cannot move the cyan frame until all of the surrounding pictures appear.
- The projection TV will continually update each of the surrounding pictures while the CHANNEL INDEX screen is displayed.
- Sound will only be heard from the center picture.
- If one of the pictures received through CHANNEL INDEX is snowy, the entire screen may become unstable. In this case, erase the snowy channel. (see "CHANNEL SKIP" on page 37)
- If you leave the CHANNEL INDEX screen displayed for an hour without any additional operation, CHANNEL INDEX is canceled and the normal picture reappears.

## Using the yellow labeled buttons for CHANNEL INDEX operations



REFER TO THE ILLUSTRATION OF THE REMOTE CONTROL ON THE INSIDE FRONT COVER OF THIS MANUAL AS YOU REVIEW THE FOLLOWING DESCRIPTIONS



Press to display the next twelve receivable channels.



Press to cancel the current operation and return to normal TV viewing.

**FREEZE**



Press to freeze the center picture.

Press again to cancel the frozen picture and resume normal center picture viewing.

## Using the white labeled buttons for center picture operations



REFER TO THE ILLUSTRATION OF THE REMOTE CONTROL ON THE INSIDE FRONT COVER OF THIS MANUAL AS YOU REVIEW THE FOLLOWING DESCRIPTIONS

**TV/VIDEO**



Press to scroll the center picture through the video inputs.

The surrounding channels will not change.

### Note:

- If you press VIDEO 5 while the CHANNEL INDEX screen is displayed, the CHANNEL INDEX feature is canceled and the normal picture of the VIDEO 5 input will be displayed.

**ANT**



Press to switch the center picture between the VHF/UHF input and the AUX input.

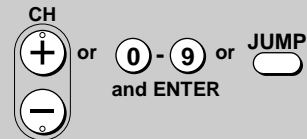

Press to select a channel for the center picture. (for details, see "Watching the TV" on page 25)

# Adjusting Your SET UP (menus)

## Learning Menu Selection

Use the MENU button to access a menu and use the joystick to alter the settings. Use the following example to learn how to modify settings.

- 1 Press the MENU button.

The main menu appears.

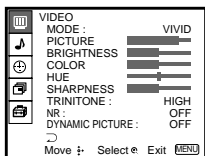

- 2 Move the joystick up or down to highlight the desired menu and press  $\oplus$  (press down on the center of the joystick) to activate it.

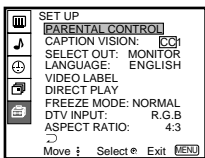
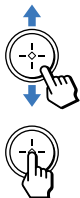

You may also move the joystick right to activate your selection.

- 3 Move the joystick up or down to highlight the desired option.

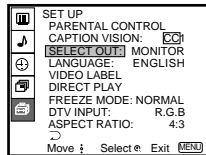

- 4 Press  $\oplus$  (press down on the center of the joystick).

Options for your selection (Pop-up menu or Adjusting menu) will be displayed.

### Pop-up menu

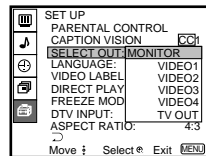

### Adjusting menu

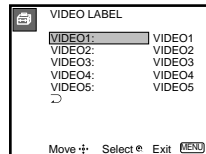

- 5 Move the joystick up or down to make your selection and press  $\oplus$  to activate it.

The previous screen will reappear.

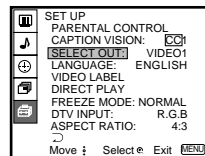

Some adjustment menus may require further operations. For details, see each menu option.

To return to the previous screen (except for the slider adjustment menus), choose  $\leftarrow$  at the bottom of the menu and press  $\oplus$  or move the joystick left.

- 6 Once you have completed all menu corrections, press MENU to exit the menu screens.



## To exit from the menus at any time

Press MENU.

## Using the VIDEO Menu

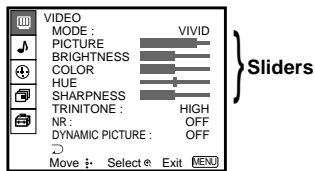

For detailed information on using the remote control to modify menu settings, refer to “Learning Menu Selection” on page 33.

### To select the VIDEO menu:

Display → Highlight → Select

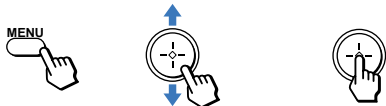

### MODE

#### — Customized picture viewing

You can choose one of five different video modes that best suits the program you are watching. You can also adjust the picture quality (such as BRIGHTNESS, COLOR, etc.) for each MODE to suit your taste.

First select each MODE individually before adjusting the picture quality.

### VIVID:

Select for enhanced picture contrast and sharpness.

### STANDARD:

Select to display a standard picture for normal viewing environments.

### MOVIE:

Select to display a finely detailed picture for low light environments.

### GAME:

Select to display graphics such as a video game.

### PRO (Professional):

Select to display a picture with minimum enhancements.

*Press PICTURE MODE on the remote control for direct selection of a MODE setting.*

### PICTURE

#### — Picture Adjustment

Adjust slider right (up) to increase picture contrast.

Adjust slider left (down) to decrease picture contrast.

### BRIGHTNESS

#### — Picture Adjustment

Adjust slider right (up) to brighten the picture.

Adjust slider left (down) to darken the picture.

### COLOR

#### — Picture Adjustment

Adjust slider right (up) to increase color intensity.

Adjust slider left (down) to decrease color intensity.

### HUE

#### — Picture Adjustment

Adjust slider right (up) to increase the green tones.

Adjust slider left (down) to increase the red tones.

### SHARPNESS

#### — Picture Adjustment

Adjust slider right (up) to sharpen the picture.

Adjust slider left (down) to soften the picture.

### TRINITONE

#### — White Intensity Adjustment

### HIGH:

Select to give the white colors a blueish tint.

### MEDIUM:

Select to give the white colors a neutral tint.

### NTSC STD:

Select to give the white colors a reddish tint.

## NR

### — Picture Noise Reduction

Select **ON** to reduce picture noise.

Select **OFF** to cancel the feature.

## DYNAMIC PICTURE

### — Black Intensity Adjustment

Select **ON** to emphasize the black level and to produce a bolder dynamic picture.

Select **OFF** to cancel the feature.

## To restore the factory settings

Press RESET on the remote control while the VIDEO menu is selected. To restore each MODE to the factory setting, press RESET after selecting the mode to be reset.

# Using the AUDIO Menu

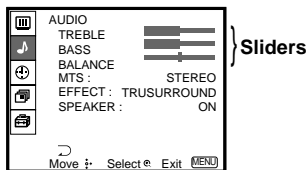

For detailed information on using the remote control to modify menu settings, refer to “Learning Menu Selection” on page 33.

## To select the AUDIO menu:

Display → Highlight → Select

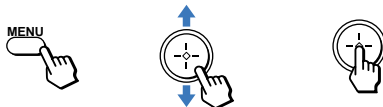

## TREBLE

### — Sound Adjustment

Adjust slider right (up) to increase high pitched sounds.

Adjust slider left (down) to decrease high pitched sounds.

## BASS

### — Sound Adjustment

Adjust slider right (up) to increase low pitched sounds.

Adjust slider left (down) to decrease low pitched sounds.

## BALANCE

### — Sound Adjustment

Adjust slider right (up) to emphasize right speaker volume.

Adjust slider left (down) to emphasize left speaker volume.

## MTS

### — Enjoy stereo, bilingual and mono programs

#### STEREO:

Select for stereo reception when viewing a program broadcast in stereo.

#### SAP:

Select to listen to a bilingual broadcast. (non-SAP programs will be muted when this feature is selected)

#### MONO:

Select for mono reception. (use to reduce noise during stereo broadcasts)

#### Quick MTS access:

Press MTS on your remote control to cycle through the MTS options as follows: (STEREO → SAP → MONO → STEREO)

(continued)

## EFFECT

— *Customizes surround sound effects based on the program's audio type*

EFFECT can only be set when SPEAKER is set to ON.

### TRUSURROUND\*:

Produces a virtual surround effect for Dolby-surround encoded programs.

### SRS 3D MONO:

Adds a surround-like effect to mono programs.

### OFF:

Normal stereo or mono reception.

## SPEAKER

— *Custom selection of audio output source*

### ON:

Select to listen to the sound from the projection TV speakers alone.

### OFF:

Select to turn off the projection TV speakers and listen to the projection TV's sound only through an external audio system's speakers.

### CENTER IN:

Select to use the projection TV as center speaker when you connect an amplifier with a Dolby Pro Logic decoder. (see "Connecting an Amplifier That Supports Dolby Pro Logic Decoder" on page 21)

## To restore the factory settings

Press RESET on the remote control while the AUDIO menu is selected.

### \* TruSurround™

TruSurround, SRS and the  symbol are trademarks of SRS Labs, Inc. in the United States and selected foreign countries.

TruSurround and SRS technology is incorporated under license from SRS Labs, Inc.

## Using the TIMER Menu

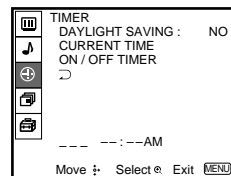

After setting the clock you can use the timer to turn the projection TV on and off.

For detailed information on using the remote control to modify menu settings, refer to "Learning Menu Selection" on page 33.

## To select the **TIMER** menu:

Display → Highlight  → Select

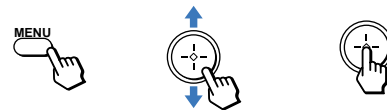

### Tip

Set daylight saving time before setting the clock. Any loss of power will cause these settings to be erased.



## DAYLIGHT SAVING

— Automatically adjusts the time

Select **YES** to compensate for Daylight Saving Time in spring. The current time automatically moves ahead one hour.

Select **NO** at the end of Daylight Saving Time in fall. The current time moves back one hour.

## CURRENT TIME

— Necessary for the **TIMER**

1 Press  $\oplus$ , then move the joystick up or down until the current day (MON-SUN) is displayed, and press  $\oplus$ .

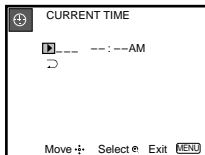

2 Move the joystick up or down until the current hour (1-12) and AM/PM is displayed, and press  $\oplus$ .

3 Move the joystick up or down until the current minute (00-59) is displayed, and press  $\oplus$ .

The Clock has now started. Press MENU to exit.

## ON/OFF TIMER

— Wake up or scheduled viewing

1 Select the desired timer (1 or 2).

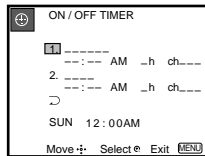

2 Move the joystick up or down until the desired day (MON-SUN) or range of days (EVERY SUN-SAT or EVERY MON-FRI) is displayed, and press  $\oplus$ .

3 Move the joystick up or down until the time (hours and minutes) that you want the projection TV to remain on is displayed, and then press  $\oplus$ .

4 Move the joystick up or down to set the time duration (maximum of 6 hours) and press  $\oplus$ .

5 Move the joystick up or down to select the desired channel and press  $\oplus$ .

The timer is now set. The TIMER/STAND BY indicator on your projection TV will be lit.

Press MENU to exit. To cancel your timer setting, select timer 1 or 2 and press RESET while in the ON/OFF TIMER window. Performing AUTO PROGRAM will erase all TIMER settings.

## Using the CHANNEL SET UP Menu

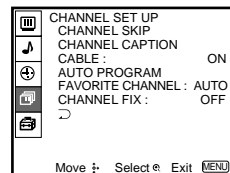

For detailed information on using the remote control to modify menu settings, refer to “Learning Menu Selection” on page 33.

### To select the CHANNEL SET UP menu:

Display → Highlight  → Select

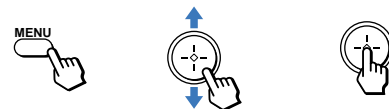

## CHANNEL SKIP

— Skips unnecessary channels

After AUTO PROGRAM, you can erase unnecessary TV channels from the channel preset memory.

With the CHANNEL SKIP window open:

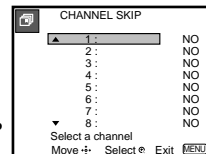

(continued)

- 1 Move the joystick up or down to select the desired channel. You can view the channel that is selected with the CHANNEL SKIP menu in the center sub screen. You can also use CH +/- or 0-9 and ENTER buttons.
- 2 Press  $\oplus$ .
- 3 Move the joystick up or down to select **YES**, and press  $\oplus$ . The selected channel will be erased.

If you want to re-enter the skipped channel, follow the steps above and select **NO**.

### CHANNEL CAPTION

— *Easy recognition of the channel you are watching*

You can add a caption for up to 32 channels of both VHF/UHF and AUX inputs.

With the CHANNEL CAPTION window open:

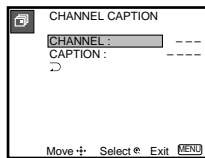

- 1 Press  $\oplus$  and then move the joystick up or down to select the desired channel. You can view the channel that is selected with the CHANNEL CAPTION menu in the center sub screen.
- 2 Press  $\oplus$ .
- 3 Move the joystick up or down to display the first letter or number of the caption and press  $\oplus$  to select it.
- 4 Repeat until up to four digits are selected.
- 5 Press  $\oplus$ .

To erase a caption, press RESET.

### CABLE

— *Cable system setting*

Select **ON** if your projection TV is connected to a cable system.

Select **OFF** if your projection TV is connected to an antenna.

AUTO SET UP will automatically set CABLE to **ON**.

### AUTO PROGRAM

— *Automatic channel presetting*

Select **YES** to signal the projection TV to automatically program all receivable TV channels. When all the receivable channels are stored, the lowest numbered channel will be displayed.

Select **NO** to cancel AUTO PROGRAM.

### FAVORITE CHANNEL

— *User's favorite channels*

The FAVORITE CHANNEL feature enables easy access to the eight channels that you preset (or the last channel that you were watching). (for details on how to set up this feature, see “Setting and Selecting FAVORITE CHANNEL” on page 39)

### CHANNEL FIX

— *Locks selection of your projection TV's input when used in conjunction with external equipment such as a cable box, AV receiver, etc.*

#### 2-6:

When the cable box is connected to the VHF/UHF input, you can fix the TV's input to one of the channels between 2 and 6. Press DBS/CABLE (FUNCTION) and then CH +/- to change the cable box channels.

#### AUX 2-6:

Use this when a cable box is connected to AUX, and a cable or antenna is connected to VHF/UHF.

#### VIDEO 1:

Use this when you have connected external video equipment (e.g. AV receiver) and you want the projection TV's input fixed to it.

#### OFF:

When you want to switch CHANNEL FIX off.

If the projection TV is in the AUX mode when you turn CHANNEL FIX off, press ANT to return to UHF input mode.

*TIMER settings are erased when CHANNEL FIX is set.*

#### Note:

- You cannot change channels with the TV's tuner when you set CHANNEL FIX. If you want to use the TV's tuner while fixing the TV's input to VIDEO 1, use the SET UP menu to set SELECT OUT to TV OUT. (see “SELECT OUT” on page 41)

# Setting and Selecting FAVORITE CHANNEL

The FAVORITE CHANNEL feature of your projection TV enables easy access to the eight channels that you preset (or the last channel that you were watching).

Your FAVORITE CHANNEL options can be set automatically or manually.

The factory setting for FAVORITE CHANNEL is AUTO.

When FAVORITE CHANNEL is set to AUTO, the last eight channels selected with the 0–9 buttons will be set as FAVORITE CHANNEL options. If you want to input your own selections as FAVORITE CHANNEL settings, set to MANUAL.

## Setting FAVORITE CHANNEL manually

- 1 Select FAVORITE CHANNEL from the CHANNEL SET UP menu. (see pages 37 and 38)

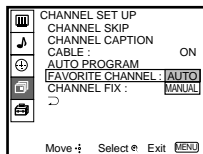

- 2 Move the joystick up or down to select MANUAL and press (+).  
The FAVORITE CHANNEL menu will appear. If you set CHANNEL CAPTION names (e.g. CNN, HBO), they will also be displayed. (see “CHANNEL CAPTION” on page 38)

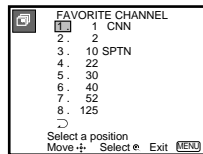
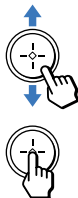

- 3 Move the joystick up or down to select a position (1–8), and press (+).

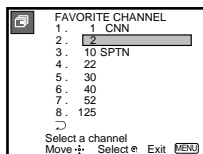
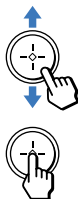

- 4 Move the joystick up or down to select a channel.  
You have now selected a favorite channel.

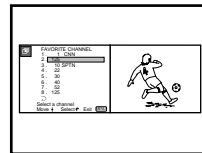

- 5 Press (+) and use the joystick to program other favorite channels. (Follow steps 3 and 4.)
- 6 Press MENU when you have finished.  
Your favorite channels are now ready for use.

## Resetting FAVORITE CHANNEL choices

You have the option of returning to the FAVORITE CHANNEL screen to adjust any of your favorite channel choices.

Simply proceed as described in “Setting FAVORITE CHANNEL manually” (skip step 2 if MANUAL is already selected).

(continued)

When you reach step 3, select the position you want to change and press **+**. Press **RESET** to clear the channel for that position.

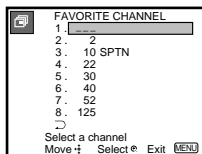

Move the joystick up or down to select a new channel.

Press **MENU** when you are done.

**Note:**

- The FAVORITE CHANNEL feature is not available for the picture input from AUX or VIDEO 1-5 (DTV) IN.

## Using FAVORITE CHANNEL

You can use the FAVORITE CHANNEL feature to directly select the channel you want to watch.

- 1 Press **+** once.

The favorite channel menu and a window picture will be superimposed over the current

channel. The window picture displays the channel selected from the menu.

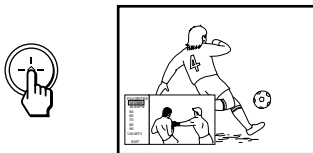

- 2 Move the joystick up or down to select the channel that you wish to view from the menu.

The picture of the selected channel will be displayed in the window picture.

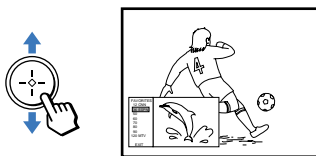

- 3 Press **+** to select the channel.

The selected channel will be displayed for normal viewing.

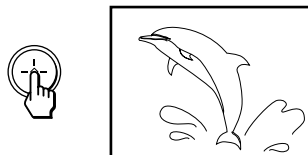

To cancel the favorite channel menu before selecting a channel, move the joystick up or down to select **EXIT** at the bottom of the menu and press **+**.

## Using the SET UP Menu

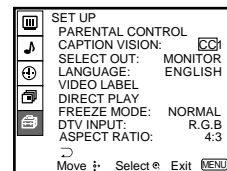

For detailed information on using the remote control to modify menu settings, refer to “Learning Menu Selection” on page 33.

### To select the SET UP menu:

Display → Highlight → Select

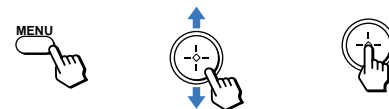

### PARENTAL CONTROL — Blocks programs unsuitable for children

Allows you to block TV programs that you feel are unsuitable for your children. (see “Using the PARENTAL CONTROL Feature” on page 43 for details)

## CAPTION VISION

### — Television closed caption display

Some programs are broadcast with Caption Vision.

To display Caption Vision,

select **CC 1**, **CC 2**, **CC**

**3**, **CC 4**, **TEXT1**,

**TEXT2**, **TEXT3** or **TEXT4** from the menu. Then

press the **CC** button until Caption Vision is displayed.

**CC 1**, **CC 2**, **CC 3** or **CC 4** displays a printed version of the dialogue or sound effects of a program. (The mode should be set to **CC 1** for most programs.) **TEXT1**, **TEXT2**, **TEXT3** or **TEXT4** displays network/station information presented using either half or the whole screen.

#### Notes:

- Poor reception of TV programs can cause errors in Caption Vision and XDS. Captions may appear with a white box or other errors instead of the intended text.
- XDS, Caption Vision, and the status display cannot be used at the same time.

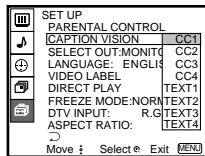

## SELECT OUT

### — Output signal selection from SELECT OUT

You can select the desired output signal from the SELECT OUT jacks at the rear of the projection TV.

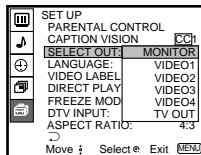

#### Note:

- SELECT OUT setting is not available for the inputs from VIDEO 5 (DTV) IN.

#### MONITOR:

Select to edit tapes while monitoring. SELECT OUT outputs the picture displayed on the screen.

#### VIDEO1–VIDEO4:

Select to edit tapes while viewing an input image different from that being recorded. SELECT OUT outputs the signal input to the projection TV regardless of the displayed picture on the screen.

#### TV OUT:

Select if you connect an AV receiver to VIDEO 1 IN. SELECT OUT outputs the signal that the TV is tuned to, regardless of the displayed picture. (see “Connecting an AV Receiver” on page 19 for connection)

If you select **TV OUT**, the following pop-up menu appears.

Select **YES** only if you have connected an AV receiver, with no other equipment, to your projection TV. You can always select the signal from the receiver by pressing TV/VIDEO once.

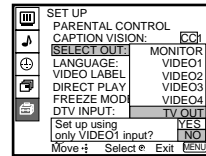

Select **NO** if you have connected multiple components to your projection TV. You can select an input (VIDEO1 – VIDEO5) with the TV/VIDEO button.

#### Note:

- The SELECT OUT signal is only available when the projection TV is on.

## LANGUAGE

### — User's preferred language

Select from available languages (**ENGLISH**, **ESPAÑOL** or **Français**) to display all menus in your language of choice.

(continued)

## VIDEO LABEL

— Easy recognition of connected equipment (e.g. DBS, VHS, etc.)

This feature allows you to label each input mode so that you can easily identify the connected equipment (e.g. you can label VIDEO 1 IN as VHS).

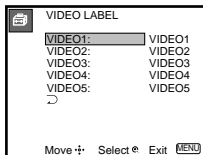

With the VIDEO LABEL window open:

- 1 Move the joystick up or down to select the input mode you want to label and press  $\odot$ .

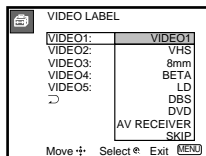

- 2 Move the joystick up or down to select the label and press  $\odot$ .

### VIDEO LABEL Options:

**VIDEO 1:** VIDEO 1, VHS, 8mm, BETA, LD, DBS, DVD, AV RECEIVER, SKIP

**VIDEO 2–4:** VIDEO 2–4, VHS, 8mm, BETA, LD, DBS, DVD, SKIP

**VIDEO 5:** VIDEO 5, DTV, DVD, SKIP

*If you select SKIP, your projection TV will skip this connection when you scan through video sources using the TV/VIDEO button.*

## DIRECT PLAY

— Easy operation of a connected VCR

This feature allows you to switch the input mode from the TV to a Sony VCR (MDP or DVD) and start playing by only pressing the  $\blacktriangleright$  (playback) button on the remote control. You have to set the VTR 1/2/3/DVD/MDP switch on the remote control. You have to set the VTR 1/2/3/DVD/MDP switch to VTR 3). With the DIRECT PLAY window open:

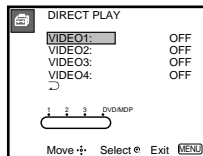

- 1 Move the joystick up or down to select the input to which your video equipment is connected, and press  $\odot$ .

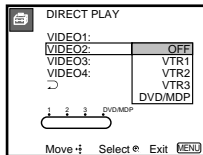

- 2 Move the joystick up or down to select the position of the VTR 1/2/3/DVD/MDP switch, and press  $\odot$ .

### Note:

- DIRECT PLAY setting is not available for the inputs from VIDEO 5 (DTV) IN.

## FREEZE MODE

— Freeze picture mode

Useful when you need to copy down information that appears on the TV's screen.

### Note:

- The FREEZE MODE feature is not available for the inputs from VIDEO 5 (DTV) IN jacks.

### NORMAL:

Select to freeze the whole picture on the screen by pressing FREEZE.



The current picture freezes.

### TWIN:

Select to freeze the desired scene and display it on the left of the screen while viewing the normal picture of the current channel on the right by pressing FREEZE.

This mode is not available for PIP, P&P or CH INDEX screens.

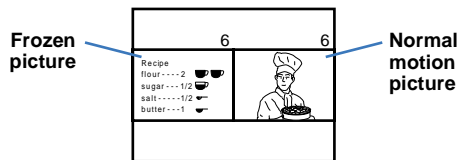

Press FREEZE again or press **OFF** to display the normal picture.

### DTV INPUT

— *Input signal selection from the DTV receiver*

Select **R.G.B** when you connect a DTV receiver to the G/B/R/HD/VD jacks of VIDEO 5 (DTV) IN on the rear of the projection TV. Select **Y PB PR** when you connect a DTV receiver to the Y/P<sub>B</sub>/P<sub>R</sub> jacks of VIDEO 5 (DTV) IN.

#### Note:

- Picture color will be incorrect if wrong DTV INPUT is selected.

### ASPECT RATIO

— *Wide picture mode for digital TV*

The feature allows you to display a compressed 4:3 picture in 16:9 aspect ratio with higher-density (available for 480p and 480i formats only). (see page 27)

Normally, set to **4:3**. Select **16:9** if the picture of DTV 480p or 480i format appears stretched vertically.

## Using the PARENTAL CONTROL Feature

The TV programs and movies shown on TV are given a rating signal based on the following rating systems.

**In U.S.A.:** U.S. Television Parental Guidelines to rate television programs (U.S. TV ratings), and Motion Picture Association of America (MPAA) Guidelines to rate movies including those shown on TV (movie ratings)

**In Canada:** Canadian English Language ratings to rate television programs in English, and Canadian French Language ratings to rate those in French.

To block programs you feel are unsuitable for your children, you need to set the TV for the desired rating systems. Sony's predetermined ratings are also available. See page 50 for a description of the ratings.

The Parental Control feature of the TV functions by receiving the rating signal from your local broadcasting station or cable service provider.

#### Note:

- The PARENTAL CONTROL feature is not available for the inputs from VIDEO 5 (DTV) IN.

## Activating the PARENTAL CONTROL feature

First, set a password, then select your desired rating from Sony's predetermined ratings.

- 1 Select PARENTAL CONTROL from the SET UP menu. (see page 40)

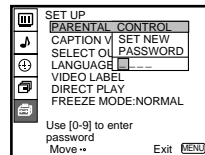

- 2 Enter a four digit password\* using the 0–9 buttons.

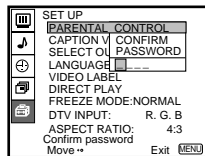

\* Do not enter "4357" corresponding to "HELP" on a phone number pad. (see page 49)

- 3 To confirm the password, re-enter the same password with the 0–9 buttons.

Your password is stored and the PARENTAL CONTROL menu automatically appears.

If you want to change the password, see page 49.

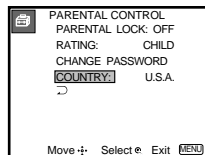

(continued)

- 4 Make sure that COUNTRY is highlighted, and press  $\oplus$ .

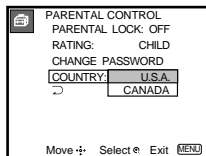

- 5 Move the joystick up or down to select your country (U.S.A. or CANADA), and press  $\oplus$ .



- 6 Move the joystick up or down to select PARENTAL LOCK, and press  $\oplus$ .

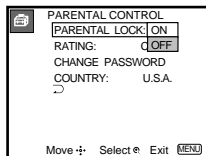

- 7 Move the joystick up or down to select ON, and press  $\oplus$ .

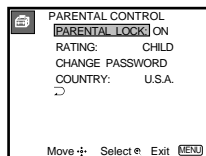
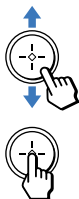

- 8 Move the joystick up or down to select RATING, and press  $\oplus$ .

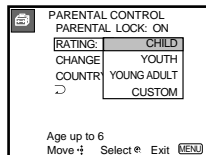
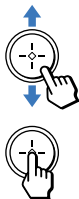

- 9 Move the joystick up or down to select a desired rating (CHILD, YOUTH and YOUNG ADULT), and press  $\oplus$ .

If you want to select the ratings from CUSTOM, go to step 4 of “Selecting a Custom Rating in U.S.A.” on page 45 or “Selecting a Custom Rating in Canada” on page 48, according to your COUNTRY setting.

- 10 Press MENU to exit the menu.

## To deactivate the PARENTAL CONTROL feature

If you set PARENTAL LOCK in the PARENTAL CONTROL menu to OFF, the PARENTAL CONTROL feature will be canceled and you can view all TV programs and movies shown on TV.

- 1 Select PARENTAL CONTROL from the SET UP menu. (see page 40)

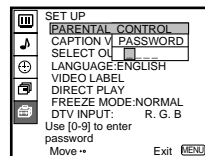

- 2 Enter your four digit password using the 0-9 buttons.

The PARENTAL CONTROL menu appears.

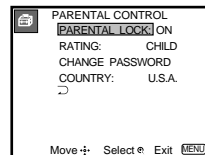



- 3 Move the joystick up or down to select PARENTAL LOCK, and press .

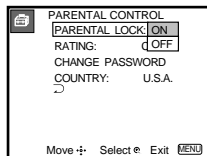

- 4 Move the joystick up or down to select OFF, and press .

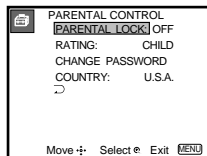

- 5 Press MENU to exit the menu.

### To unlock the PARENTAL CONTROL feature temporarily

When you select a PARENTAL CONTROL program, no sound or picture except for a channel number will appear. The indicator is displayed. To view the program, follow the steps below.

- 1 Press ENTER to display the “Password” screen.
- 2 Enter your password using the 0–9 buttons. PARENTAL CONTROL will be canceled (PARENTAL LOCK set to OFF) until you turn your projection TV off.

### Selecting a Custom Rating in U.S.A.

If you want to select the ratings to be blocked from CUSTOM once you have activated the PARENTAL CONTROL feature (page 43), follow the procedure below.

For a detailed description of each rating, see page 50.

- 1 Select PARENTAL CONTROL from the SET UP menu. (see page 40)

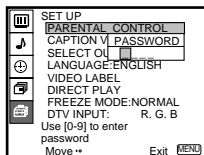

- 2 Enter your four digit password using the 0–9 buttons.

The PARENTAL CONTROL menu appears. Make sure that COUNTRY is set to U.S.A.

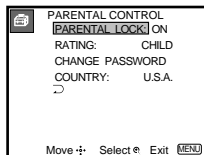

- 3 Move the joystick up or down to select RATING, and press .

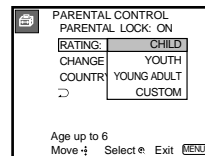

- 4 Move the joystick up or down to select CUSTOM, and press .

First, select a TV rating.

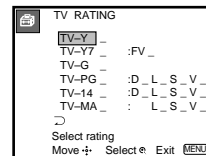

- 5 Move the joystick up or down to select TV RATING, and press .

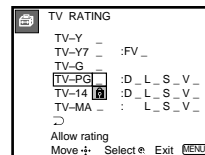

- 6 Move the joystick up or down to select the TV rating to be blocked, and press .



(continued)

- 7 Move the joystick up or down to select , and press .

The  indicator automatically appears beside the selected rating and all “higher” ratings, indicating that the programs that match the ratings will be blocked.

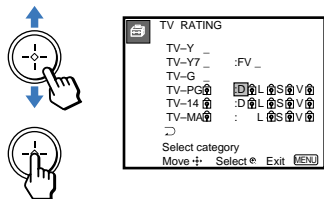

Some ratings have additional content ratings called “extenders.” The extenders are defined as follows: D (sexually suggestive Dialog), FV (Fantasy Violence), L (coarse Language), S (Sexual situations) and V (Violence). By setting the extenders, you can define additional viewing limits. For more details of extenders, see page 51.

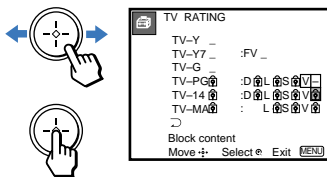

All of the extenders included in the selected ratings will be blocked. If you wish to allow any of them to be viewed, go to step 8.

- 8 Move the joystick left or right to select the extender to be viewed, and press .



- 9 Move the joystick up or down to select “-,” and press .

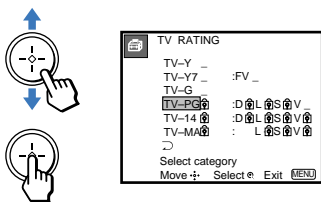

“-” appears beside the selected extender, indicating that the programs that match the extender can be viewed.

If you select ,  is displayed to show that the programs that match the extender will be blocked again.



- 10 Repeat steps 8 and 9 for other extenders.

All programs that match the ratings you select and higher, except for the extenders that were canceled, will be blocked.

- 11 After setting of the TV rating is complete, move the joystick up or down to select , and press .

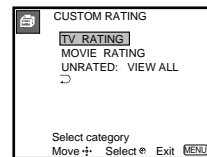

Second, select a movie rating.

- 12 Move the joystick up or down to select MOVIE RATING, and press .

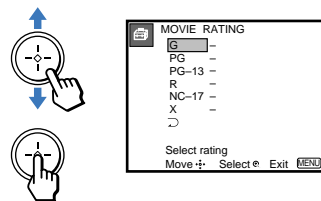

- 13** Move the joystick up or down to select the movie rating to be blocked, and press  $\oplus$ .

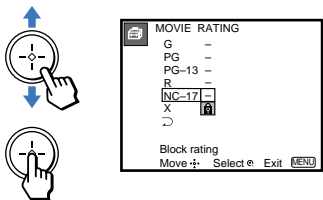

- 14** Move the joystick up or down to select  $\mathcal{L}$ , and press  $\oplus$ .

The  $\mathcal{L}$  indicator automatically appears beside the selected rating and all “higher” ratings, indicating that the programs that match the ratings will be blocked.

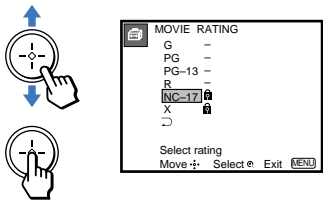

- 15** Press MENU to exit the menu.

## To block TV programs and/or movies for which a rating is not given (NR and N/A)

For a description of the NR and N/A ratings, see page 50.

- 1 Perform steps 1–4 of “Selecting a Custom Rating in U.S.A.” on page 45.
- 2 Move the joystick up or down to select UNRATED, and press  $\oplus$ .

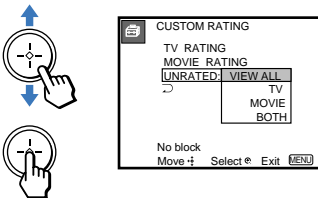

- 3 Move the joystick up or down to select the type of programs to be blocked, and press  $\oplus$ .

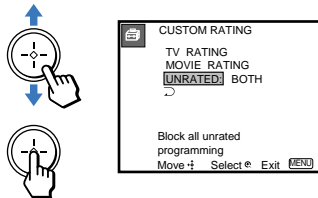

To block ...	Select ...
No program (to view any unrated TV program and movie)	VIEW ALL
Unrated TV programs	TV
Unrated movies	MOVIE
Unrated TV programs and movies	BOTH

- 4 Press MENU to exit the menu.

### Note:

- Programs with no rating signal will automatically be blocked when TV, MOVIE or BOTH is selected.

## Selecting a Custom Rating in Canada

If you want to select the ratings to be blocked from CUSTOM once you have activated the PARENTAL CONTROL feature (page 43), follow the procedure below.

For a detailed description of each rating, see “Ratings in Canada” on page 51.

- 1 Select PARENTAL CONTROL from the SET UP menu. (see page 40)

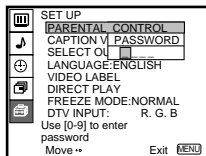

- 2 Enter your four digit password using the 0-9 buttons.

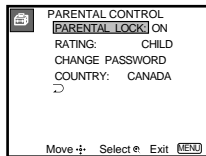

The PARENTAL CONTROL menu appears. Make sure that COUNTRY is set to CANADA.

- 3 Move the joystick up or down to select RATING, and press (+).

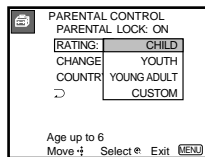

- 4 Move the joystick up or down to select CUSTOM, and press (+).

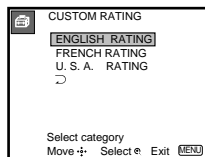

- 5 Move the joystick up or down to select the rating you want to block, and press (+).



### Canadian English Rating

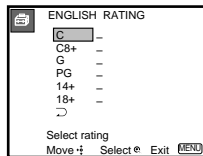

### Canadian French Rating U.S. TV Rating

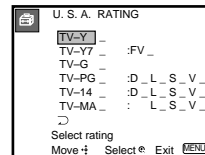
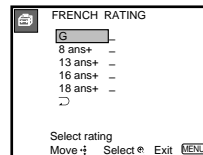



- 6 Move the joystick up or down to select the TV rating to be blocked, and press (+).

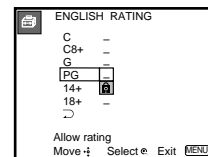

### Example: Canadian English Rating



- 7 Move the joystick up or down to select , and press .

The  indicator automatically appears beside the selected rating and all “higher” ratings, indicating that the programs that match the ratings will be blocked.

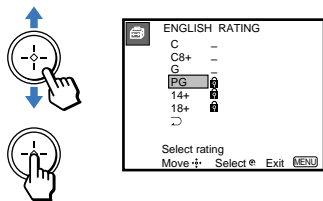

Some U.S. TV ratings have additional content ratings called “extenders,” such as D, FV, L, S and V. By setting the extenders, see steps 7 to 10 of “Selecting a Custom Rating in U.S.A.” on page 45. For more details of extenders, see page 51.

All of the extenders included in the selected ratings will be blocked. If you wish to allow any of them to be viewed, go to step 8 on page 46.

- 8 Press MENU to exit the menu.

## Changing the Password

- 1 Select PARENTAL CONTROL from the SET UP menu. (see page 40)

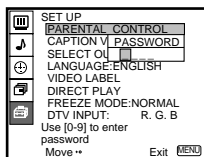

- 2 Enter your four digit password using the 0–9 buttons.

The PARENTAL CONTROL menu appears.

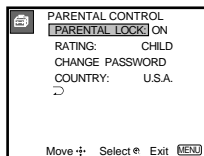

- 3 Move the joystick up or down to select CHANGE PASSWORD, and press .

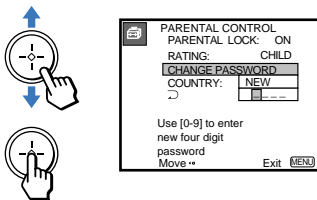

- 4 Enter a new four digit password using the 0–9 buttons.

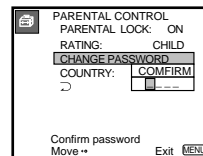

- 5 Enter the password set in step 4 again to confirm.

If you entered it incorrectly, “Password incorrect” appears.

Re-enter the correct password.

- 6 Press MENU to exit the menu.

### If you have forgotten your password

In step 2 of “Changing the Password,” enter the master password “4357” (corresponding to “HELP” on a phone number pad). You can then store a new password.

#### Notes:

- If you entered “4357” as your password the first time, you cannot store a new password. (see step 2 of “Activating the PARENTAL CONTROL feature” on page 43)
- When you select a PARENTAL CONTROL program and the  indicator is displayed on the screen, you cannot view that program even if you enter “4357.” (see “To unlock the PARENTAL CONTROL feature temporarily” on page 45)

---

# What the Ratings Mean

## Ratings in U.S.A.

### **Sony's predetermined ratings**

These are original ratings that Sony predetermined according to the viewer's age. Each rating allows you to view the certain programs, as follows.

*See the center column for a description of TV and movie ratings.*

#### **CHILD:**

Suitable for children under the age of 6.

Viewable U.S. movie ratings: G, NR, and N/A

Viewable U.S. TV ratings: TV-Y, TV-G, and TV-NR

#### **YOUTH:**

Suitable for children aged 7 and older.

Viewable U.S. movie ratings: G, PG, NR, and N/A

Viewable U.S. TV ratings: TV-Y, TV-Y7, TV-G, TV-PG, and TV-NR

#### **YOUNG ADULT:**

Suitable for children aged 13 and older.

Viewable U.S. movie ratings: G, PG, PG-13, NR, and N/A

Viewable U.S. TV ratings: TV-Y, TV-Y7, TV-G, TV-PG, TV-14, and TV-NR

### **U.S. movie ratings**

U.S. movie ratings are for movies (including those shown on TV) rated according to the Motion Picture Association of America (MPAA) Guidelines.

#### **G (General Audiences—All Ages Admitted):**

In G-rated films no strong words are used, the violence is at a minimum, nudity and sex scenes are not present, nor is there any drug use.

#### **PG (Parental Guidance Suggested. Some Material May Not Be Suitable For Children):**

This is a film which may need to be monitored first by parents.

#### **PG-13 (Parents Strongly Cautioned. Some Material May Be Inappropriate For Children Under 13):**

Parents are alerted to be very careful about the attendance of their under-teenage children when viewing.

#### **R (Restricted, Under 17 Require Accompanying Parent Or Adult Guardian):**

This film includes hard language, tough violence, nudity, drug abuse or other elements of concern.

#### **NC-17 or X (No One 17 Or Under Admitted.):**

This is a film that most parents would consider not suitable for children aged 17 and under. There may be violence, sex, aberrational behavior, drug abuse or other elements of concern.

#### **NR (Not Rated):**

This is a film that a producer has not rated, intending to have his film widely released.

#### **N/A (Not Applicable):**

This is a film that a producer considers outside the scope of the MPAA ratings.

#### **Note:**

- NR and N/A ratings are shown together as UNRATED in the menu.

### **U.S. TV ratings**

U.S. TV ratings are for TV programs rated according to the U.S. Television Parental Guidelines.

#### **TV-Y (All Children):**

This program is designed for young children aged 2–6 and is appropriate for all children.

#### **TV-Y7 (Directed to Older Children):**

This program is designed for children aged 7 and above. Themes and elements in this program may include mild fantasy violence or slapstick violence, or may frighten children under the age of 7.

#### **TV-G (General Audience):**

Most parents would find this program suitable for all ages. It contains little or no violence, no strong language and little or no sexual dialog or situations.

#### **TV-PG (Parental Guidance Suggested):**

This program contains some material that parents may find unsuitable for younger children.

**TV-14 (Parents Strongly Cautioned):**

This program contains some material that many parents would find unsuitable for children under the age of 14.

**TV-MA (Mature Audience Only):**

This program is specifically designed to be viewed by adults and therefore may be unsuitable for children under the age of 17.

**TV-NR (Not Rated/Unrated):**

This is a program broadcast without any rating, such as news, news flashes or sports.

**Note:**

- The TV-NR rating is shown as UNRATED in the menu.

**About the extenders of U.S. TV ratings**

TV-Y7, TV-PG, TV-14 and TV-MA ratings have additional content ratings called “extenders” to define additional viewing limits. The extenders are defined as follows:

**D (sexually suggestive Dialog):**

Programs containing suggestive dialog, or sexual innuendo

**TV (Fantasy Violence):**

Programs containing cartoon violence occurring in TV-Y7 programs only

**L (coarse Language):**

Programs containing coarse language

**S (Sexual situations):**

Programs containing sexual content

**V (Violence):**

Programs containing violence

There may be some profanity, violence or brief nudity in these programs.

**Ratings in Canada****Sony's predetermined ratings**

These are original ratings that Sony predetermined according to the viewer's age. Each rating allows you to view the certain programs, as follows.

*See the right column for a description of each rating.*

**CHILD:**

Suitable for children under the age of 7.

Viewable Canadian English Language ratings: C and G

Viewable Canadian French Language ratings: G

Viewable U.S. TV ratings: TV-Y, TV-G, and TV-NR

**YOUTH:**

Suitable for children aged 8 and older.

Viewable Canadian English Language ratings: C, G, C8+ and PG

Viewable Canadian French Language ratings: G and 8 ans+

Viewable U.S. TV ratings: TV-Y, TV-Y7, TV-G, TV-PG, and TV-NR

**YOUNG ADULT:**

Suitable for children aged 14 and older.

Viewable Canadian English Language ratings: C, G, C8+, PG and 14+

Viewable Canadian French Language ratings: G, 8 ans+, 13 ans+

Viewable U.S. TV ratings: TV-Y, TV-Y7, TV-G, TV-PG, TV-14, and TV-NR

**Canadian English Language ratings**

The Canadian English Language Ratings are for TV programs in English broadcast in Canada.

**C (Programming intended for children under age 8):**

There will be no realistic scenes of violence or no offensive language, nudity or sexual content. Careful attention is paid to themes, which could threaten children's sense of security and well-being.

**C8+ (Programming generally considered acceptable for children 8 years and over to watch on their own):**

Violence will not be portrayed as the preferred, acceptable, or only way to resolve conflict; or encourage children to imitate dangerous acts which they may see on television. There will be no profanity, nudity or sexual content.

**G (General Audience):**

Will contain very little violence, either physical or verbal or emotional. There may be some inoffensive slang, no profanity and no nudity.

**PG (Parental Guidance):**

Programming intended for a general audience but which may not be suitable for younger children. Parents may consider some content inappropriate for unsupervised viewing by children aged 8 – 13.

**14+ (Programming contains themes or content which may not be suitable for viewers under the age of 14):**

Parents are strongly cautioned to exercise discretion in permitting viewing by pre-teens and early teens.

**18+ (Adult):**

May contain violence integral to the development of the plot, character or theme, intended for adult audiences. May contain graphic language and explicit portrayals of nudity and/or sex.

**E (Exempt):**

Exempt programming includes: news, sports documentaries and other information programming: talk shows, music videos, and variety programming.

**Note:**

- The E (Exempt) rating is not shown in the menu.

**Canadian French Language ratings**

The Canadian French Language Ratings are for TV programs in French broadcast in Canada.

**G (General):**

Programming intended for audience of all ages. Contains no violence, or the violence it contains is

minimal or is depicted appropriately with humor or caricature or in an unrealistic manner.

**8 ans+ (8+ General - Not recommended for young children):**

Programming intended for a broad audience but contains light or occasional violence that could disturb young children. Viewing with an adult is recommended for young children (under the age of 8).

**13 ans+ (Programming may not suitable for children under the age of 13):**

Viewing with an adult is strongly recommended for children under 13.

**16 ans+ (Programming is not suitable for children under the age of 16):**

Contains frequent scenes of violence or intense violence.

**18 ans+ (Programming restricted to adults):**

Contains constant violence or scenes of extreme violence.

**E (Exempt):**

Exempt programming.

**Note:**

- The E (Exempt) rating is not shown in the menu.



## Operating Video Equipment

### Setting the Manufacturer's Code

You can use the supplied remote control to operate Sony or non-Sony video equipment that has an infrared sensor.

- 1 Set the VTR 1/2/3/DVD/MDP switch to the input through which you would like to access your video equipment.

The following Sony equipment is preset to each input as shown below:

VTR1 (303)	Beta, ED Beta VCRs
VTR2 (302)	8 mm VCR
VTR3 (301)	VHS VCR
DVD/MDP (751)	DVD Player

- 2 Press CODE SET, DVD/VTR (FUNCTION), and the 0-9 buttons to enter the manufacturer's code number (see the following chart), then press ENTER.

For example, to operate a Sony 8mm VCR:



### If the remote control doesn't work

- See the tips on page 55.

### VCR manufacturer code numbers

Manufacturer	Code
Sony	301, 302, 303
Aiwa	338
Admiral (M. Ward)	327
Audio Dynamic	314, 337
Bell & Howell (M. Ward)	330, 343
Broksonic	319, 317
Canon	309, 308
Citizen	332
Craig	315, 302, 332
Criterion	315
Curtis Mathis	304, 338, 309
Daewoo	341, 312, 309
DBX	314, 336, 337
Dimensia	304
Emerson	319, 320, 316, 317, 318, 341
Fisher	330, 334, 335, 333
Funai	338
General Electric	329, 304, 309
Go Video	340, 339, 322
Goldstar	332
Hitachi	306, 304, 305, 338
Instant Replay	309, 308
JC Penney	309, 305, 304, 330, 314, 336, 337
JVC	314, 336, 337
Kenwood	314, 336, 332, 337
LXI (Sears)	332, 305, 333, 334, 330, 335, 338
Magnavox	308, 309, 310
Marantz	314, 336, 337
Marta	332
Memorex	309, 335
Minolta	305, 304

Mitsubishi/MGA	323, 324, 325, 326
Multitech	325, 338, 321
NEC	314, 336, 337
Olympic	309, 308
Optimus	327
Panasonic	308, 309, 306, 307
Pentax	305, 304
Philco	308, 309
Philips	308, 309, 310
Pioneer	308
Quasar	308, 309, 306
RCA/PROSCAN	304, 305, 308, 309, 311, 329, 312, 313, 310
Realistic	309, 330, 328, 335, 324, 338
Sansui	314
Singer	315
Samsung	322, 313, 321
Sanyo	330, 335
Scott	312, 313, 321, 335, 323, 324, 325, 326
Sharp	327, 328
Shintom	315
Signature 2000 (M. Ward)	338, 327
Sylvania	308, 309, 338, 310
Symphonic	338
SV2000	338
Tashiro	332
Tatung	314, 336, 337
Teac	314, 336, 338, 337
Technics	309, 308
Teknica	342, 338
Toshiba	312, 311
Wards	327, 328, 335, 331, 332
XR-1000	315
Yamaha	330, 314, 336, 337
Zenith	331

(continued)

## MDP manufacturer code numbers

Manufacturer	Code
Sony	701
Panasonic	704
Pioneer	702

## DVD Player manufacturer code numbers

Manufacturer	Code
Sony	751
Panasonic	753
Pioneer	752
RCA	755
Toshiba	754









### Tips

- In some rare cases, you may not be able to operate your non-Sony video equipment with the supplied remote control. In this case, please use the equipment's own remote control.
- When you remove the batteries, the code number may revert to the factory setting.





## Operating video equipment

- 1 Set the VTR1/2/3/DVD/MDP switch to the input through which you would like to access your video equipment.
- 2 Press DVD/VTR (FUNCTION).
- 3 Use the VCR/DVD/MDP operation buttons indicated in the following tables.





## Operating a VCR using the remote control

To turn On/Off	Press DVD/VTR (POWER). [Green Button]
To select a channel	Press the 0 – 9 buttons.
To change channels	Press CH +/-.
To record	Press  (REC) while pressing  (lower).
To play	Press  .
To stop	Press  .
To fast forward	Press  .
To rewind the tape	Press  .
To pause	Press  . Press again to resume normal playback.
To search the picture forward or backward	Press  or  during playback. Release to resume normal playback.
To change input mode	Press TV/VTR.

## Operating an MDP using the remote control

To turn On/Off	Press DVD/VTR (POWER). [Green Button]
To play	Press  .
To stop	Press  .
To pause	Press  . Press again to resume normal playback.
To search the picture forward or backward	Press  or  during playback. Release to resume normal playback.
To search a chapter forward or backward	Press CH +/-.

## Operating a DVD Player using the remote control

To turn On/Off	Press DVD/VTR (POWER). [Green Button]
To play	Press  .
To stop	Press  .
To pause	Press  . Press again to resume normal playback.
To step through different tracks of an audio disc	Press  to step forward or  to step backward.
To step through different chapters of a video disc	Press CH+ to step forward or CH- to step backward.
To display the Title menu	Press TITLE.
To display the DVD menu	Press DVD MENU.
To select tracks directly	Press 0-9 buttons.
To display the menu (Set up)	Press MENU.

# Operating a Cable Box or DBS Receiver

## Setting the Manufacturer's Code

You can program the supplied remote control to operate a cable box or DBS receiver.

Press CODE SET, DBS/CABLE (FUNCTION), and the 0-9 buttons to enter the manufacturer's code number (see the following chart), then press ENTER.

For example, to operate a Sony DBS receiver:



## Manufacturer code numbers (cable box)

Manufacturer	Code
Gemini	233
Hamlin/Regal	222, 223, 224, 225, 226
Jerrold/G. I.	201, 202, 203, 204, 205, 222, 206, 207, 208, 218
Macom	230, 231, 232
Magnavox	234
Oak	227, 228, 229
Panasonic	219, 220, 221
Philips	236, 237, 238, 239, 240, 241
Pioneer	214, 215
Samsung	235
Scientific Atlanta	209, 210, 211
Tocom	216, 217
Zenith	212, 213

## Manufacturer code numbers (DBS receiver)

Manufacturer	Code
Sony	801 (preset code for remote control)
General Electric	802
RCA/PROSCAN	802

## Operating a cable box or DBS receiver

- 1 Press DBS/CABLE (POWER) [Green Button] to turn on/off the cable box or DBS receiver.
- 2 Press DBS/CABLE (FUNCTION).
- 3 For other operations, refer to the operating instructions that come with the equipment. Blue-labeled buttons such as the GUIDE button can be used only with a DBS receiver.

## If the remote control doesn't work

Try repeating the set up procedures using the other codes listed for your equipment.

## To operate the projection TV

Press TV (FUNCTION). Then use the projection TV control buttons to control the projection TV.

### Tips

- If more than one code number is listed, try entering them one by one until you come to the correct code for your equipment.
- If you enter a new code number, the code number you previously entered at that setting is erased.
- In some rare cases, you may not be able to operate your equipment with the supplied remote control. In this case, use the equipment's own remote control unit.
- Whenever you remove the batteries — to replace them, for example — if too much time is taken, the code numbers may revert to the factory setting and must be reset.

### Troubleshooting

If, after reading the following instructions, you have additional questions related to the use of your Sony projection TV, please call one of the following numbers (English only). Customers in the continental United States contact the Direct Response Center at: **1-800-222-SONY (7669)** Customers in Canada contact the Customer Relations Center at: **(416) 499-SONY (7669)**

#### The picture turns off and the TIMER/STAND BY indicator on the front panel flashes (self-diagnosis function)

- ➔ The projection TV is equipped with a self-diagnosis function. If there is a problem with your projection TV, the TIMER/STAND BY indicator on the front panel will flash repeatedly. Counting the number of flashes helps you inform qualified Sony personnel of the projection TV's condition.

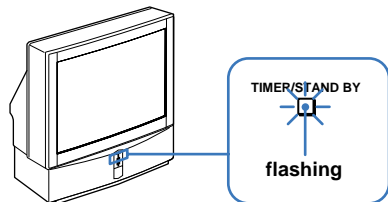

- 1 Count how many times the TIMER/STAND BY indicator flashes in total. It flashes twice at 3 seconds' intervals. If, for example, the indicator flashes twice, stops flashing for 3 seconds, and flashes twice again, that counts as twice.
- 2 Press POWER on the projection TV to turn it off, then inform qualified Sony personnel or the above Direct Response Center of the number of flashes.

#### No picture (screen not lit), no sound

- ➔ Make sure the power cord is plugged in.
- ➔ Operate with the buttons on both the projection TV and the remote control.
- ➔ Check to see if the TV/VIDEO setting is correct: when watching TV, set to TV, and when watching video tapes, set to VIDEO 1, 2, 3, 4 or 5.
- ➔ Try another channel. *It could be station trouble.*
- ➔ Perform AUTO SET UP again using the SET UP button to return to the factory preset condition. (see "To perform AUTO SET UP again" on page 24)
- ➔ The PARENTAL CONTROL feature is activated. (see "Using the PARENTAL CONTROL Feature" on page 43)

#### Remote control does not operate.

- ➔ Batteries could be weak. Replace the batteries.
- ➔ Press TV (FUNCTION) when operating your projection TV.
- ➔ Make sure the projection TV's power cord is connected securely to the wall outlet.
- ➔ Locate the projection TV at least 3-4 feet away from fluorescent lights.
- ➔ Check the polarity of the batteries.

#### Dark, poor or no picture (screen lit), good sound

- ➔ Adjust PICTURE in the VIDEO menu. (see "PICTURE" on page 34)
- ➔ Adjust BRIGHTNESS in the VIDEO menu. (see "BRIGHTNESS" on page 34)
- ➔ Check antenna/cable connections.
- ➔ Perform AUTO SET UP again using the SET UP button to return to the factory preset condition. (see "To perform AUTO SET UP again" on page 24)
- ➔ Adjust the convergence again using the FLASH FOCUS button. (see "Adjusting the Convergence Automatically (FLASH FOCUS)" on page 24)

#### Good picture, no sound

- ➔ Press MUTING so that "MUTING" disappears from the screen. (see "MUTING" on page 25)
- ➔ Check the MTS setting in the AUDIO menu. (see "MTS" on page 35)
- ➔ Make sure SPEAKER is set to ON in the AUDIO menu. (see "SPEAKER" on page 36)
- ➔ Perform AUTO SET UP again using the SET UP button to return to the factory preset condition. (see "To perform AUTO SET UP again" on page 24).

### Cannot receive digital channels (when a DTV receiver is connected)

- ➔ Check the connections between the DTV receiver and the projection TV. (see pages 11 and 12)
- ➔ Check your local listings to find out if you can receive digital broadcasts in your area.

### The color of the digital TV program is not correct

- ➔ Check the DTV INPUT setting in the SET UP menu. (see “DTV INPUT” on page 43)

### Cannot receive upper channels (UHF) when using an antenna

- ➔ Make sure CABLE is OFF in the CHANNEL SET UP menu. (see “CABLE” on page 38)
- ➔ Use AUTO PROGRAM to add receivable channels that are not presently in the TV’s memory. (see “AUTO PROGRAM” on page 38)

### No color

- ➔ Adjust the COLOR in the VIDEO menu. (see “COLOR” on page 34)
- ➔ Black and white programs cannot be seen in color.
- ➔ Perform AUTO SET UP again using the SET UP button to return to the factory preset condition. (see “To perform AUTO SET UP again” on page 24)

### Only snow and noise appear on the screen

- ➔ Check the CABLE setting in the CHANNEL SET UP menu. (see “CABLE” on page 38)
- ➔ Check the antenna/cable connections.
- ➔ Make sure the channel is broadcasting programs.
- ➔ Press ANT to change the input mode. (see “ANT” on page 25)

### Dotted lines or stripes

- ➔ Adjust the antenna.
- ➔ Keep the projection TV away from noise sources such as cars, neon signs or hair-dryers.

### TV is fixed to one channel

- ➔ Use AUTO PROGRAM to add receivable channels that are not presently in TV’s memory. (see “AUTO PROGRAM” on page 38)
- ➔ Try turning CHANNEL FIX off. (see “CHANNEL FIX” on page 38)

### Double images or ghosts

- ➔ Use a highly directional outdoor antenna or a cable (when the problem is caused by reflections from nearby mountains or tall buildings).

### Cannot operate the menu

- ➔ If the item you want to choose appears in gray, you cannot select it.
- ➔ Press the projection TV’s power button off and on again.

### Cannot receive any channels when using cable TV

- ➔ Check the connection with a cable box again. (see pages 8 and 10)
- ➔ Make sure CABLE is ON in the CHANNEL SET UP menu. (see “CABLE” on page 38)
- ➔ Use AUTO PROGRAM to add receivable channels that are not presently in the TV’s memory. (see “AUTO PROGRAM” on page 38)

### Cannot gain enough volume when using a cable box

- ➔ Increase the volume at the cable box. Then press TV (FUNCTION) and adjust the projection TV’s volume.

### CHANNEL INDEX does not display all available channels

- ➔ Make sure CABLE is ON in the CHANNEL SET UP menu. (see “CABLE” on page 38)
- ➔ Use AUTO PROGRAM to add receivable channels that are not presently in the TV’s memory. (see “AUTO PROGRAM” on page 38)

*(continued)*

### **FAVORITE CHANNEL does not display your choices**

- ➔ Verify that FAVORITE CHANNEL is set to MANUAL in the CHANNEL SET UP menu. (see “Setting FAVORITE CHANNEL manually” on page 39)

### **Some video sources do not appear when you press TV/VIDEO**

- ➔ Ensure that VIDEO LABEL is not set to SKIP. (see “VIDEO LABEL” on page 42)

### **Recording through SELECT OUT does not function properly when recording in PIP or P&P mode**

- ➔ SELECT OUT will not record both images in PIP or P&P. Only the main picture will be recorded.
- ➔ If you are recording the main picture and you switch to the sound of the sub picture using the AUDIO button, the main picture will be recorded with sound from the other program.

### **Cannot play shooting games**

- ➔ Some shooting games which involve pointing a light beam at the TV screen with an electronic gun or rifle cannot be used with this projection TV. For details, see the instruction manual supplied with the video game software.

# Specifications

## Projection system

3 picture tubes, 3 lenses, horizontal in-line system

## Picture tube

7-inch high-brightness monochrome tubes (6.3 raster size), with optical coupling and liquid cooling system

## Projection lenses

High performance, large diameter hybrid lens F1.1

## Television system

American TV standard

## Channel coverage

VHF: 2-13/UHF: 14-69/CATV: 1-125

## Antenna

75 ohm external terminal for VHF/UHF

## Screen size (measured diagonally)

53 inches (KP-53HS10)

61 inches (KP-61HS10)

## Inputs/outputs

### VIDEO 1/3 IN

### VIDEO 2 INPUT

S VIDEO IN (4-pin mini DIN):

Y: 1 Vp-p, 75-ohms unbalanced, sync negative

C: 0.286 Vp-p (Burst signal), 75 ohms

VIDEO (phono jack): 1 Vp-p, 75-ohms unbalanced, sync negative

AUDIO (phono jacks): 500 mVrms (100% modulation), Impedance: 47 kilohms

### VIDEO 4 IN

S VIDEO IN (4-pin mini DIN):

Y: 1 Vp-p, 75-ohms unbalanced, sync negative

C: 0.286 Vp-p (Burst signal), 75 ohms

VIDEO (phono jack): 1 Vp-p, 75-ohms unbalanced, sync negative

Y: 1 Vp-p, 75 ohms, sync negative

Pb: 0.7 Vp-p, 75 ohms

Pr: 0.7 Vp-p, 75 ohms

AUDIO (phono jacks): 500 mVrms (100% modulation), Impedance: 47 kilohms

## VIDEO 5 (DTV) IN

Maximum scanning rate: 1080i

Y: 1 Vp-p, 75 ohms, negative or tri-level sync

Pb: 0.7 Vp-p, 75 ohms

Pr: 0.7 Vp-p, 75 ohms

or

G: 0.7 Vp-p, 75 ohms

B: 0.7 Vp-p, 75 ohms

R: 0.7 Vp-p, 75 ohms

HD: 0.5-5 Vp-p, 2.2 kilohms

VD: 0.6-5 Vp-p, 2.2 kilohms

### Note:

The VIDEO 5 (DTV) IN jacks are not compatible with a computer's 5BNC (R/G/B/HD/VD) video output connectors.

AUDIO (phono jacks): 500 mVrms (100% modulation),

Impedance: 47 kilohms

### SELECT OUT

VIDEO (phono jack): 1 Vp-p, 75-ohms unbalanced, sync negative

AUDIO (phono jacks): 470 mVrms (100% modulation),

Impedance: 47 kilohms

AUDIO (VAR) OUT (phono jacks): 700 mVrms (100% modulation)

AUDIO (FIX) OUT (phono jacks): 500 mVrms (100% modulation)

CONTROL S IN/OUT: minijacks

### Speaker

Front (Tweeter): 66 mm (2<sup>5</sup>/<sub>8</sub>" ) × 2

Front (Woofer):

130 mm (5<sup>1</sup>/<sub>8</sub>" ) × 2 (KP-53HS10)

160 mm (6<sup>3</sup>/<sub>8</sub>" ) × 2 (KP-61HS10)

### Speaker output

Front: 20 W × 2

### Power requirement

120 V AC, 60 Hz

### Power consumption

In use (Max.): 240 W

In standby: 1 W

## Dimensions (W/H/D)

1,218 × 1,459 × 635 mm (48 × 57<sup>1</sup>/<sub>2</sub> × 25 inches)

(KP-53HS10)

1,372 × 1,558 × 670 mm (54<sup>1</sup>/<sub>8</sub> × 61<sup>3</sup>/<sub>8</sub> × 26<sup>1</sup>/<sub>2</sub> inches)

(KP-61HS10)

## Mass

84 kg (185 lbs 3 oz) (KP-53HS10)

102 kg (224 lbs 14 oz) (KP-61HS10)

## Supplied accessories

Remote control RM-Y902 (1)

Batteries size AA (R6) (2)

## Optional accessories

Connecting cables

RK-G34, RK-74A, RKG-69HG, VMC-10HG,

VMC-720M, VMC-810S/820S, YC-15V/30V

U/V mixer EAC-66

*Design and specifications are subject to change without notice.*

# Index



## A

ACTIVE button .....28, 30  
ANT button .....25, 28, 30  
Antenna cable .....8  
Antenna connector .....7  
ASPECT RATIO .....27, 43  
AUDIO button .....29, 30  
AUDIO menu operations  .....35  
Audio/Video cable .....6  
AUTO PROGRAM .....38  
AUTO SET UP .....23  
AUX Hookup .....8

## B

BALANCE .....35  
BASS .....35  
BRIGHTNESS .....34

## C

CABLE .....38  
Cable box  
  connection .....8, 10  
  operation .....55  
CAPTION VISION .....41  
CATV cable .....8  
 button .....26  
CH +/- buttons .....25  
CHANNEL CAPTION .....38  
CHANNEL FIX .....38  
CHANNEL INDEX .....31  
CHANNEL SET UP menu  
  operations  .....37  
CHANNEL SKIP .....37  
Coaxial cable .....6, 9

COLOR .....34  
Connecting Projection TV to  
  amplifier that supports Dolby  
  Pro Logic decoder .....21  
antenna .....7  
audio system .....20  
AV receiver .....19  
cable .....7  
cable box and cable .....8  
camcorder .....15  
DBS receiver .....13  
DBS receiver and VCR .....14  
DTV receiver .....11, 12  
DVD Player .....17, 18  
  two VCRs .....16  
  VCR .....9, 10  
CONTROL S feature .....7  
Convergence .....24  
CURRENT TIME .....37

## D

DAYLIGHT SAVING .....37  
DBS receiver operation .....55  
Digital TV program .....27  
DIRECT PLAY .....42  
DISPLAY button .....26  
DRC .....1  
DTV INPUT .....43  
DVD  
  connection .....17, 18  
  operation .....54  
DYNAMIC PICTURE .....35

## E

Editing using SELECT OUT .....16  
EFFECT  
  OFF .....36

SRS 3D MONO .....36  
TRUSURROUND .....36

## F

Factory settings .....35, 36  
FAVORITE CHANNEL  
  selecting .....40  
  setting .....39  
FLASH FOCUS .....24  
FREEZE button .....25, 29, 30  
FREEZE MODE  
  NORMAL .....42  
  TWIN .....42

## G

G/B/R/HD/VD .....11, 43

## H

Hookups .....7  
HUE .....34

## J

Joystick .....22  
JUMP button .....25

## L

LANGUAGE selection .....41  
Learning menus  
  AUDIO .....35  
  CHANNEL SET UP .....37  
  SET UP .....40  
  TIMER .....36  
  VIDEO .....34

## M

MDP operation .....54

Menu selection .....33  
MODE

  GAME .....26, 34  
  MOVIE .....26, 34  
  PRO .....26, 34  
  STANDARD .....26, 34  
  VIVID .....26, 34

Movie rating .....50

## MTS

  MONO .....35  
  SAP .....35  
  STEREO .....35  
MUTING button .....25

## N

NR .....35



## O

ON/OFF TIMER .....37  
On-line help .....22  
Operating video equipment .....53

## P

PARENTAL CONTROL .....43  
  Password .....43  
  PICTURE .....34  
  PICTURE MODE button .....34  
  Picture-and-Picture (P&P) .....29  
  Picture-in-Picture (PIP) .....28  
  PIP/P&P operations  
    ACTIVE .....28, 30  
    ANT .....28, 30  
    AUDIO .....29, 30  
    CH +/- .....28, 30  
    CHANNEL INDEX .....31  
    FREEZE .....29, 30  
    POSITION .....28



SWAP .....	29, 31	TV POWER button .....	25
TV/VIDEO .....	28, 30	TV rating .....	50
Zoom in feature .....	30	TV/VIDEO button .....	26
<b>R</b>			
Remote control		<b>V</b>	
Battery installation .....	22	VCR .....	9, 10
Function buttons .....	25	VCR manufacturer code	
Graphic illustration ..	inside cover	numbers .....	53
<b>S</b>			
S Video cable .....	6	VCR operation .....	54
Safety .....	2	VIDEO LABEL .....	42
SAP .....	35	VIDEO menu operations  .....	34
Select button .....	22	VOL +/- buttons .....	25
SELECT OUT .....	41	<b>X</b>	
SET UP button .....	23	XDS .....	26
SET UP menu operations  .....	40	<b>Y</b>	
Setting up the projection TV		Y/PB/PR .....	12, 18
automatically .....	23		
SHARPNESS .....	34		
SLEEP button .....	26		
Sliders .....	22		
SPEAKER			
CENTER IN .....	36		
OFF .....	36		
ON .....	36		
Specifications .....	59		
Splitter .....	10		
SWAP button .....	29, 31		
<b>T</b>			
TIMER menu operations  .....	36		
TREBLE .....	35		
TRINITONE .....	34		
Troubleshooting .....	56		
TV (FUNCTION) button .....	25		

---

Sony  line <http://www.world.sony.com/>

---

Printed in U.S.A

If, after reading this instruction manual, you have additional questions related to the use of your Sony projection TV, please call one of the following numbers (English only).

**Customers in the continental United States contact the Direct Response Center at:**  
**1-800-222-SONY (7669)**

**Customers in Canada contact the Customer Relations Center at:**  
**(416) 499-SONY (7669)**