

**SONY**<sup>®</sup>

4-086-340-22



**FD Trinitron**  
**WEGA**<sup>®</sup>

---

Operating Instructions

KV-13FS100  
KV-13FS110  
KV-20FS100  
KV-24FS100



## WARNING

To reduce the risk of fire or electric shock, do not expose the TV to rain or moisture.



This symbol is intended to alert the user to the presence of uninsulated “dangerous voltage” within the product’s enclosure that may be of sufficient magnitude to constitute a risk of electric shock to persons.



This symbol is intended to alert the user to the presence of important operating and maintenance (servicing) instructions in the literature accompanying the appliance.

### Note to the CATV Installer

This reminder is provided to call the CATV system installer’s attention to Article 820-40 of the NEC that provides guidelines for proper grounding and, in particular, specifies that the cable ground shall be connected to the grounding system of the building as close to the point of cable entry as practical.

### SAFETY PRECAUTIONS

- Operate the TV only on 120 V AC.
- One blade of the power plug is wider than the other for safety purposes and will fit into the power outlet only one way. If you are unable to insert the plug fully into the outlet, contact your dealer.
- If any liquid or solid object falls into the TV, unplug it and have it checked by qualified personnel before operating it further.

### CAUTION

When using TV games, computers, and similar products with your TV, keep the brightness and contrast functions at low settings. If a fixed (non-moving) pattern is left on the screen for long periods of time at a high brightness or contrast setting, the image can be permanently imprinted onto the screen. Continuously watching the same channel can cause the imprint of station logos onto the TV screen. These types of imprints are not covered by your warranty because they are the results of misuse.



**To reduce the risk of electric shock, do not use this polarized plug with an extension cord, receptacle, or other outlet unless the blades can be fully inserted to prevent blade exposure.**

 You are cautioned that any changes or modifications not expressly approved in this manual could void your authority to operate this equipment.

### **NOTIFICATION**

This equipment has been tested and found to comply with the limits for a Class B digital device pursuant to Part 15 of the FCC Rules. These limits are designed to provide reasonable protection against harmful interference in a residential installation. This equipment generates, uses, and can radiate radio frequency energy and, if not installed and used in accordance with the instructions, may cause harmful interference with radio communications. However, there is no guarantee that interference will not occur in a particular installation. If this equipment does cause harmful interference to radio or television reception, which can be determined by turning the equipment off and on, the user is encouraged to try to correct the interference by one or more of the following measures:

- Reorient or relocate the receiving antennas.
- Increase the separation between the equipment and receiver.
- Connect the equipment into an outlet on a circuit different from that to which the receiver is connected.
- Consult the dealer or an experienced radio/TV technician for help.

### **Protecting the TV**

- To prevent internal heat build-up, do not block the ventilation openings.
- Do not install the TV in a hot or humid place, or in a place subject to excessive dust or mechanical vibration.

### **Note on Caption Vision**

This television receiver provides display of television closed captioning in accordance with § 15.119 of the FCC rules.

Use of this television for other than private viewing of programs broadcast on UHF or VHF or transmitted by cable companies for the use of the general public may require authorization from the broadcaster-cable company and/or program owner.

### **Owner's Record**

The model and serial numbers are located on the front cover of this manual and at the rear of your TV.

### **Trademarks and Copyrights**

ENERGY STAR<sup>®</sup> is a registered mark.



As an ENERGY STAR<sup>®</sup> Partner, Sony has determined that this product or product model meets the ENERGY STAR<sup>®</sup> guidelines for energy efficiency.

## IMPORTANT SAFEGUARDS

For your protection, please read these instructions completely, and keep this manual for future reference. Carefully observe and comply with all warnings, cautions and instructions placed on the set, or described in the operating instructions or service manual.

### WARNING

To guard against injury, the following basic safety precautions should be observed in the installation, use, and servicing of the set.

#### Use

##### Power Sources

This set should be operated only from the type of power source indicated on the serial/model plate. If you are not sure of the type of electrical power supplied to your home, consult your dealer or local power company. For those sets designed to operate from battery power, refer to the operating instructions.



##### Grounding or Polarization

This set is equipped with a polarized AC power cord plug (a plug having one blade wider than the other), or with a three-wire grounding type plug (a plug having a third pin for grounding).

Refer to the following instructions:

##### For the set with a polarized AC power cord plug

This plug will fit into the power outlet only one way. This is a safety feature. If you are unable to insert the plug fully into the outlet, try reversing the plug. If the plug still fails to fit, contact your electrician to have a suitable outlet installed. Do not defeat the safety purpose of the polarized plug by forcing it in.



##### Alternate Warning

##### For the set with a three-wire grounding type AC plug

This plug will only fit into a grounding-type power outlet. This is a safety feature. If you are unable to insert the plug into the outlet, contact your electrician to have a suitable outlet installed. Do not defeat the safety purpose of the grounding plug.

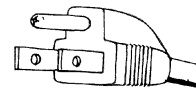

### Overloading

Do not overload wall outlets, extension cords or convenience receptacles beyond their capacity, since this can result in fire or electric shock. Always turn the set off when it is not to be used. When the set is left unattended and unused for long periods of time, unplug it from the wall outlet as a precaution against the possibility of an internal malfunction that could create a fire hazard.



Do not disconnect the antenna or the power cord during a heavy storm. Lightning may strike while you are holding the cable or cord, causing serious injury. Turn off your TV and wait for the weather to improve.

### Object and Liquid Entry

Never push objects of any kind into the set through the cabinet slots as they may touch dangerous voltage points or short out parts that could result in a fire or electric shock. Never spill liquid of any kind on the set.



### Attachments

Do not use attachments not recommended by the manufacturer, as they may cause hazards.

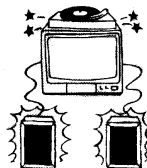

Do not place any objects, especially heavy objects, on top of the set. The object may fall from the set, causing injury.

### Cleaning

Unplug the set from the wall outlet before cleaning or polishing it. Do not use liquid cleaners or aerosol cleaners. Use a cloth lightly dampened with water for cleaning the exterior of the set.



If a snapping or popping sound from a TV set is continuous or frequent while the TV is operating, unplug the TV and consult your dealer or service technician. It is normal for some TV sets to make occasional snapping or popping sounds, particularly when being turned on or off.

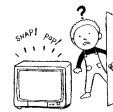

### Installation

Always use two or more people to lift or move the set. The set is heavy and the bottom surface is flat. Serious injury can result from trying to move the set by yourself alone, or from unsteady handling. Install the set on a stable, level surface.

### Water and Moisture

Do not use power-line operated sets near water — for example, near a bathtub, washbowl, kitchen sink, or laundry tub, in a wet basement, or near a swimming pool, etc.

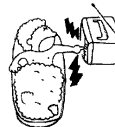

### Accessories

Do not place the set on an unstable cart, stand, tripod, bracket, table, or shelf. The set may fall, causing serious injury to a child or an adult, and serious damage to the set. Use only a cart or stand recommended by the manufacturer for the specific model of TV. Any mounting of the product should follow the manufacturer's instructions, and should use a mounting accessory recommended by the manufacturer. An appliance and cart combination should be moved with care. Quick stops, excessive force, and uneven surfaces may cause the appliance and cart combination to overturn.

Disconnect all cables and cords from the set before attempting to move the set.



Do not allow children or pets to climb up onto, or push against, the set. The set may fall, causing serious injury.

### Ventilation

The slots and openings in the cabinet and in the back or bottom are provided for necessary ventilation. To ensure reliable operation of the set, and to protect it from overheating, these slots and openings must never be blocked or covered.

- **Never cover the slots and openings with a cloth or other materials.**



- **Never block the slots and openings by placing the set on a bed, sofa, rug or other similar surface.**

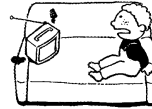

- **Never place the set in a confined space, such as a bookcase or built-in cabinet, unless proper ventilation is provided.**



- **Do not place the set near or over a radiator or heat register, or where it is exposed to direct sunlight.**



### Power-Cord Protection

Do not allow anything to rest on or roll over the power cord, and do not place the set where the power cord is subject to wear or abuse.



## Grounding or Polarization

This set may be equipped with a polarized alternating current line plug (a plug having one blade wider than other). This plug will fit into the power outlet only one way. This is a safety feature. If you are unable to insert the plug fully into the outlet, try reversing the plug. If the plug still fails to fit, contact your electrician to replace your obsolete outlet. Do not defeat the safety purpose of the polarized plug.

## Antennas

### Outdoor Antenna Grounding

If an outdoor antenna is installed, follow the precautions below. An outdoor antenna system should not be located in the vicinity of overhead power lines or other electric light or power circuits, or where it can come in contact with such power lines or circuits.

WHEN INSTALLING AN OUTDOOR ANTENNA SYSTEM, EXTREME CARE SHOULD BE TAKEN TO KEEP FROM CONTACTING SUCH POWER LINES OR CIRCUITS AS CONTACT WITH THEM IS ALMOST INVARIABLY FATAL.

Be sure the antenna system is grounded so as to provide some protection against voltage surges and built-up static charges. Section 810 of the National Electrical Code (NEC) in USA and Section 54 of the Canadian Electrical Code in Canada provides information with respect to proper grounding of the mast and supporting structure, grounding of the lead-in wire to an antenna discharge unit, size of grounding conductors, location of antenna discharge unit, connection to grounding electrodes, and requirements for the grounding electrode.

### Antenna Grounding According to the NEC

Antenna Grounding According to the National Electrical Code, ANSI/NFPA 70.

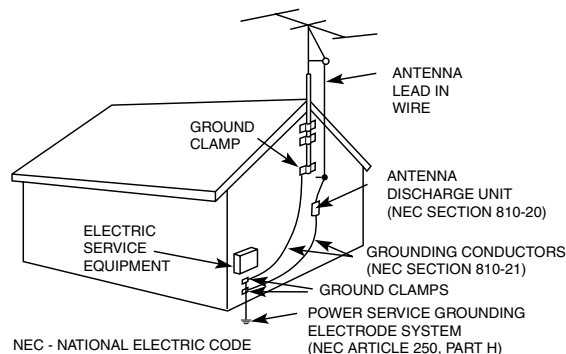

## Lightning

For added protection for this television receiver during a lightning storm, or when it is left unattended and unused for long periods of time, unplug it from the wall outlet and disconnect the antenna. This will prevent damage to the receiver due to lightning and power-line surges.



## Service

### Damage Requiring Service

Unplug the set from the wall outlet and refer servicing to qualified service personnel under the following conditions:

- When the power cord or plug is damaged or frayed.



- If liquid has been spilled into the set or objects have fallen into the product.

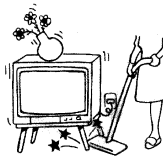

- If the set has been exposed to rain or water.



- If the set has been subject to excessive shock by being dropped, or the cabinet has been damaged.

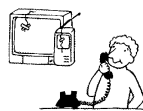

- If the set does not operate normally when following the operating instructions. Adjust only those controls that are specified in the operating instructions. Improper adjustment of other controls may result in damage and will often require extensive work by a qualified technician to restore the set to normal operation.



- When the set exhibits a distinct change in performance — this indicates a need for service.

### Servicing

Do not attempt to service the set yourself since opening the cabinet may expose you to dangerous voltage or other hazards. Refer all servicing to qualified service personnel.



### Replacement Parts

When replacement parts are required, be sure the service technician certifies in writing that he has used replacement parts specified by the manufacturer that have the same characteristics as the original parts. Unauthorized substitutions may result in fire, electric shock, or other hazards.



### Safety Check

Upon completion of any service or repairs to the set, ask the service technician to perform routine safety checks (as specified by the manufacturer) to determine that the set is in safe operating condition, and to so certify. When the set reaches the end of its useful life, improper disposal could result in a picture tube implosion. Ask a qualified service technician to dispose of the set.





# Contents

## Introduction

Introducing the FD Trinitron WEGA® Features.....	1
Batteries for the Remote Control .....	2
About this Manual .....	2
Front Panel Menu Controls .....	2







## Connecting Your TV

TV Rear Panel .....	3
Basic Connections .....	4
Connecting Additional Equipment .....	5

## Using the Remote Control and Basic Functions

Using the Remote Control .....	12
Setting Up the TV Automatically .....	14
Quick Start to the Menus .....	15

## Using the Menus

To Access a Menu.....	17
Using the Video  Menu .....	18
Using the Audio  Menu .....	19
Using the Channel Setup  Menu.....	20
Parental Control .....	22
Using the Parental Control  Menu .....	25
Using the Timer  Menu.....	28
Using the Setup  Menu .....	29

## Other Information

Troubleshooting .....	31
Specifications .....	33

<b>Index</b> .....	<b>35</b>
--------------------	-----------



# Introduction

Congratulations on your purchase of the Sony FD Trinitron WEGA<sup>®</sup>. Before you begin using this manual, please check the model number located on the rear of your TV or on the front cover of this manual.

## Introducing the FD Trinitron WEGA<sup>®</sup> Features

Some of the features you will enjoy include:

- ❑ **FD Trinitron FLAT CRT** — Technologically advanced tube delivers a picture with uncompromising accuracy and outstanding image detail.
- ❑ **Y, Pb, Pr Inputs** — A component video input connection for a superior picture quality.
- ❑ **Parental Control (V-Chip)** — A tool to help parents monitor what their children watch on TV by establishing rating limits.
- ❑ **Favorite Channels** — Instant access to your favorite channels with the touch of a button.
- ❑ **Energy Star<sup>®</sup>** — A recognized symbol of energy efficiency.
- ❑ **Direct MTS** — Allows direct access for changing your Multi-Channel TV Sound: Stereo, Mono, or Auto SAP (Second Audio Program) with the touch of a button.
- ❑ **Trilingual Menus** — Choose between English, French, or Spanish menus.
- ❑ **Front Panel Controls** — Allows access to the on-screen menus without the use of a remote control.
- ❑ **Front A/V Inputs** — A quick connection for video games, camcorders, stereo/mono equipment, or headphones.
- ❑ **Auto Mute** — A friendly feature designed to automatically mute your TV when no signal is received.

### Batteries for the Remote Control

Insert two AA (R6) batteries (supplied) into the remote control using the following illustration as a guide.

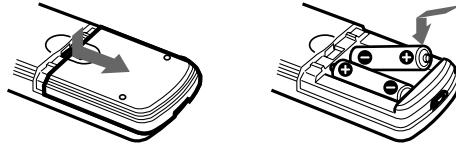

 Under normal conditions, batteries will last up to six months. If the remote control does not operate properly, the batteries might be worn out.

 If you will not be using the remote control for an extended period of time, remove the batteries to avoid possible damage from battery leakage.









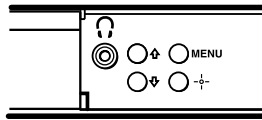

### About this Manual

This manual provides instructions to help you enjoy your new TV. It shows you how to connect to an antenna or cable, cable box, VCR, DVD, satellite receiver, stereo system, or camcorder. Once you're connected, follow the instructions and use the remote control to access the on-screen menus.

 The TV front and rear panels illustrated in this manual are for KV-24FS100. The front and rear panels on your TV may not look exactly like those illustrated.

### Front Panel Menu Controls



The front Audio/Video panel controls allows you to access the menu without the remote control. Press  to display the on-screen menu. Use the  and  buttons on the front Audio/Video panel instead of the  and  buttons on the remote control. Use the  button on the front Audio/Video panel instead of the , , and  buttons on the remote control. Press  again when the setting or adjustment is complete.

 To navigate the menus with your remote control, see "Using the Menus" on page 17.

# Connecting Your TV

Read this section before setting up your TV for the first time. This section covers basic connections in addition to any optional equipment you may be connecting.

## TV Rear Panel

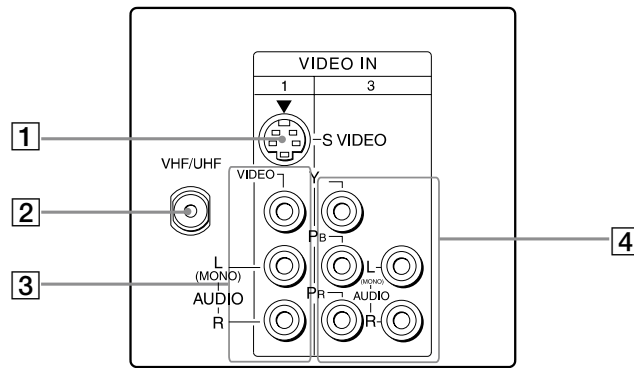

Jack	Description
<b>1 S VIDEO</b>	Connects to the S VIDEO OUT jack on your VCR or other video equipment that has S VIDEO. S VIDEO provides better picture quality than the VHF/UHF jacks or the video input jack. S VIDEO does not provide sound; the audio cables must still be connected.
<b>2 VHF/UHF</b>	Connects to your VHF/UHF antenna or cable.
<b>3 VIDEO/ AUDIO (L/R)</b>	Connects to the AUDIO and VIDEO output jacks on your VCR or other video equipment. A second video input jack (VIDEO 2) is located on the front panel of the TV. These AUDIO/VIDEO input jacks provide better picture quality than the VHF/UHF jack.
<b>4 Y, P<sub>B</sub>, P<sub>R</sub>/ L, R</b>	Connects to the component video Y, P <sub>B</sub> , P <sub>R</sub> to AUDIO L and R output jacks on your DVD player or Digital Set-top box.

 The rear panels illustrated in this manual are for KV-24FS100. The rear panels on your TV may not look exactly like those illustrated.

## Basic Connections

### TV with indoor or outdoor antenna, or CATV cable

Depending on the cable available in your home, choose one of the connections below:

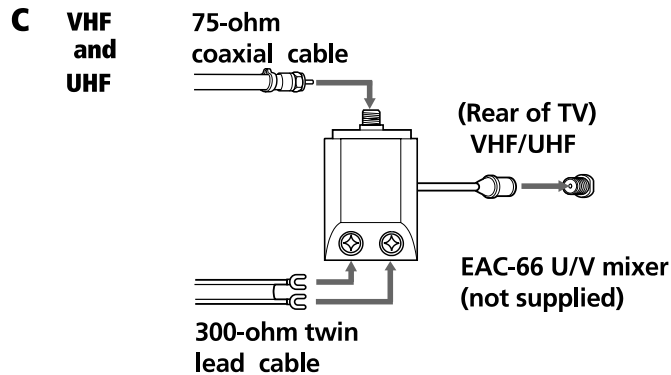
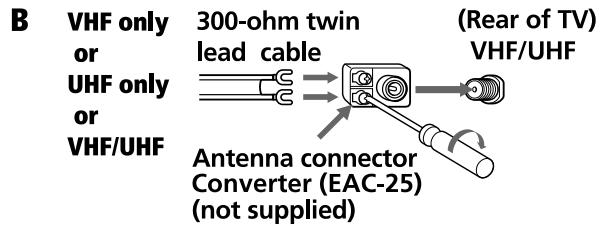
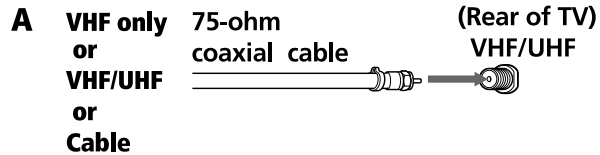

 If you are connecting to an indoor or outdoor antenna, you may need to adjust the orientation of the antenna for best reception.



## Connecting Additional Equipment

### TV and VCR

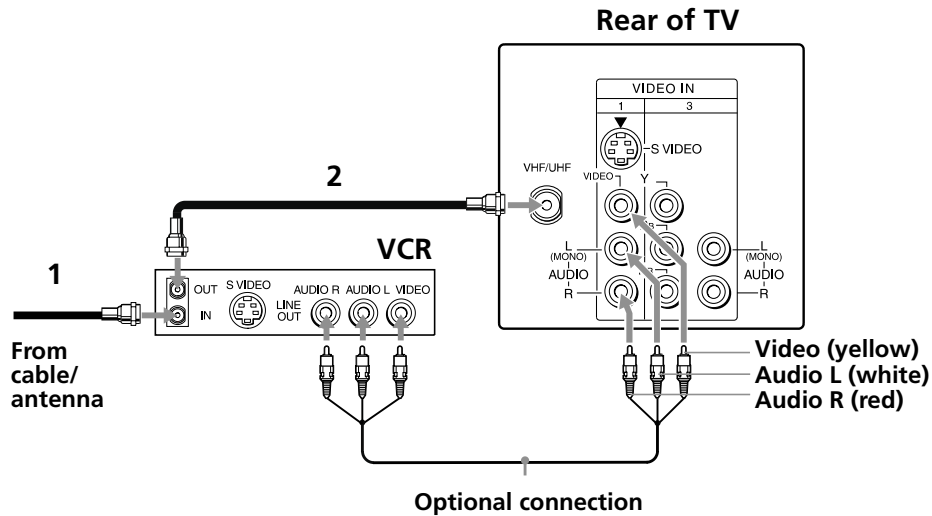

To watch video programs from your VCR, tune your TV to channel 3 or 4 (as set on the rear of your VCR).

- 1** Connect the coaxial cable from your TV antenna or cable service to the IN jack on your VCR.
- 2** Connect a coaxial cable (not supplied) from the OUT jack on your VCR to the VHF/UHF jack on the TV.

#### Optional connection

If your VCR is equipped with video outputs, you can get better picture quality by connecting Audio/Video cables (not supplied) from AUDIO and VIDEO OUT on your VCR to AUDIO/VIDEO IN on your TV.

You can use the button to switch between the VHF/UHF and VIDEO inputs.

For better picture quality, use S VIDEO instead of the yellow Audio/Video cable. S VIDEO does not provide sound; the audio cables must still be connected.

## Operating Instructions

### TV and Cable Box

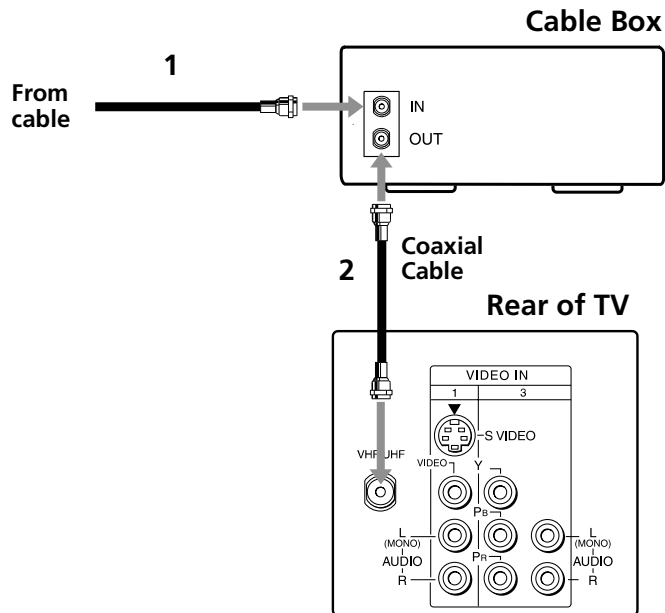

- 1** Connect the coaxial cable from your cable service to the IN jack on your cable box.
- 2** Connect a coaxial cable (not supplied) from the OUT jack on your cable box to the VHF/UHF jack on the TV.

 To view channels from your cable box, tune your TV to channel 3 or 4 (as set on the rear panel of your cable box) and use the cable box's remote control to change channels.

 If you will be controlling all channel selection through your cable box, you should consider using the Channel Fix feature by setting your TV to channel 3 or 4 (see page 20).

**TV, VCR, and Cable Box**

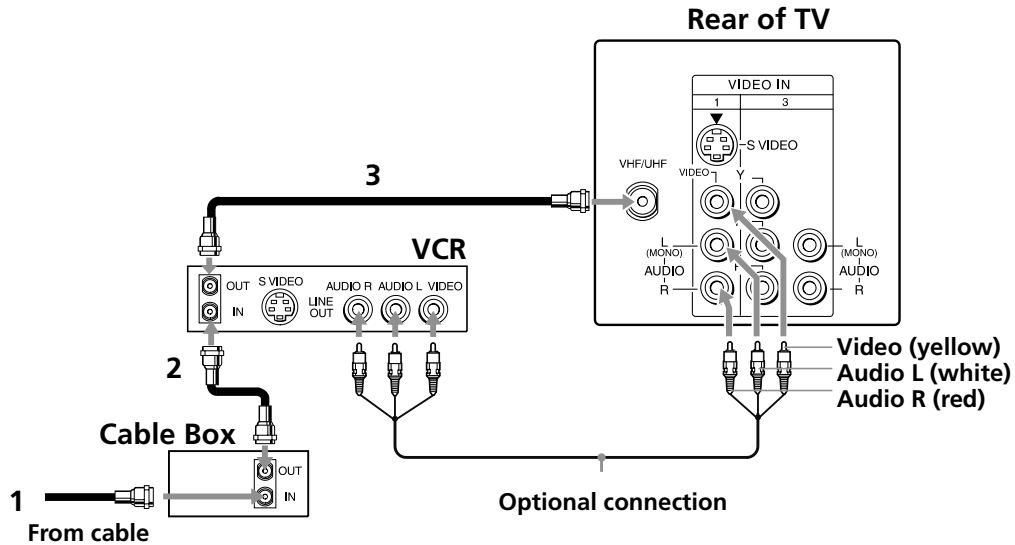

- 1** Connect the coaxial cable from your cable service to the IN jack on your cable box.
- 2** Connect a coaxial cable (not supplied) from the OUT jack on your cable box to the IN jack on your VCR.
- 3** Connect a coaxial cable (not supplied) from the OUT jack on your VCR to the VHF/UHF jack on the TV.

If you will be controlling all channel selection through your cable box, you should consider using the Channel Fix feature by setting your TV to channel 3 or 4 (see page 20).

**Optional connection**

If your VCR is equipped with video outputs, you can get better picture quality by connecting Audio/Video cables (not supplied) from AUDIO and VIDEO OUT on your VCR to AUDIO/VIDEO IN on your TV.

You can use the button to switch between the VHF/UHF and VIDEO inputs.

For better picture quality, use S VIDEO instead of the yellow Audio/ Video cable. S VIDEO does not provide sound; the audio cables must still be connected.

## Operating Instructions

### TV and Satellite Receiver

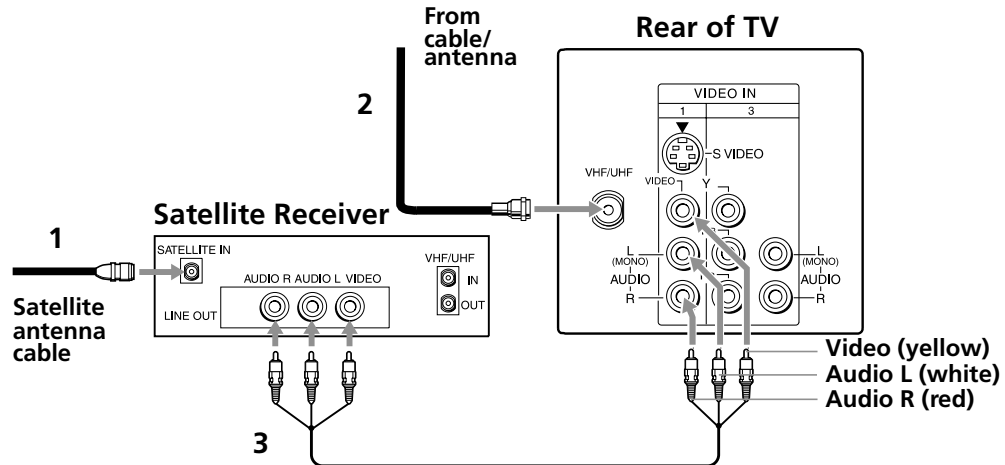

- 1** Connect the cable from your satellite antenna to SATELLITE IN on your satellite receiver.
- 2** Connect the coaxial cable from your cable service or antenna to the VHF/UHF jack on your TV.
- 3** Using Audio/Video cables (not supplied), connect AUDIO and VIDEO OUT on your satellite receiver to AUDIO and VIDEO IN on your TV.

You can use the button to switch between the VHF/UHF and VIDEO inputs.

For better picture quality, use S VIDEO instead of the yellow Audio/Video cable. S VIDEO does not provide sound; the audio cables must still be connected.

**TV, Satellite Receiver, and VCR**

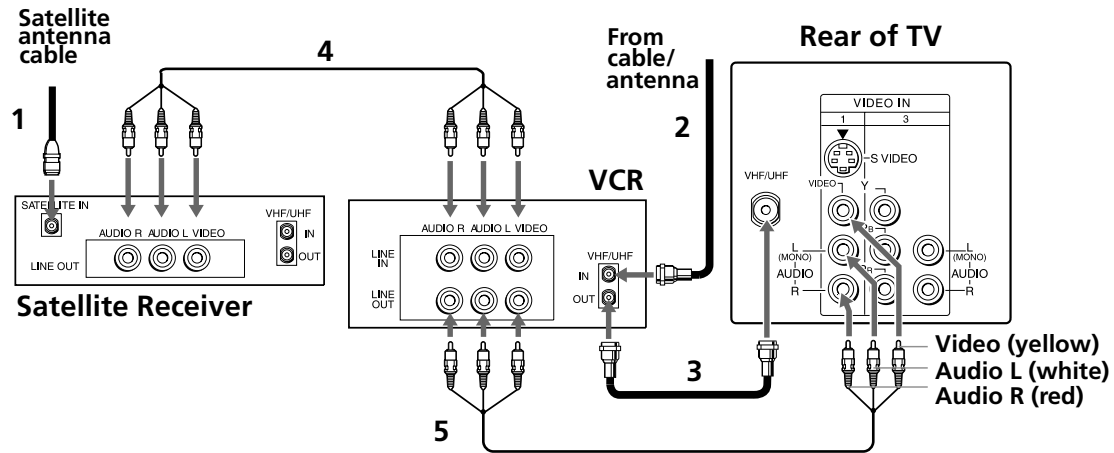

- 1** Connect the cable from your satellite antenna to SATELLITE IN on the satellite receiver.
- 2** Connect the coaxial cable from your cable service or antenna to the IN jack on your VCR.
- 3** Using a coaxial cable (not supplied), connect the OUT jack on your VCR to the VHF/UHF jack on your TV.
- 4** Using Audio/Video cables (not supplied), connect AUDIO and VIDEO OUT on your satellite receiver to AUDIO and VIDEO IN on your VCR.
- 5** Using Audio/Video cables (not supplied), connect AUDIO and VIDEO OUT on your VCR to AUDIO and VIDEO IN on your TV.

 To view from the satellite receiver or VCR, select the video input to which your satellite receiver or VCR is connected by pressing **TV/VIDEO** on the remote control.

## Operating Instructions

### Connecting a DVD Player

Using Audio/Video cables (not supplied), connect AUDIO and VIDEO OUT on your DVD player to AUDIO and VIDEO IN on your TV.

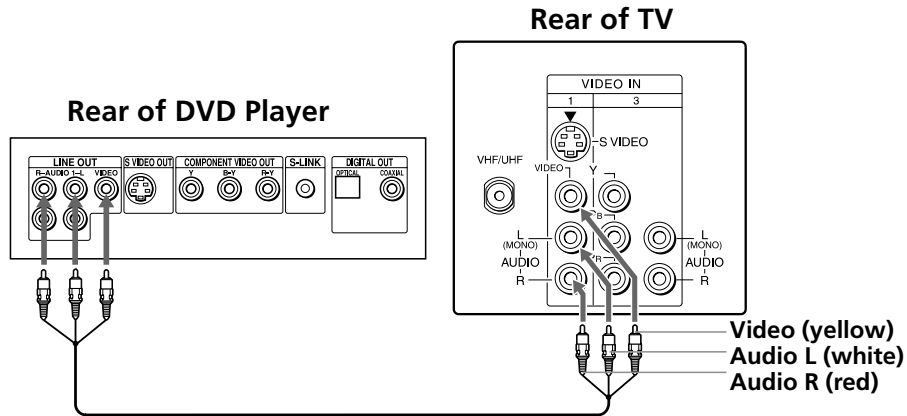

 For better picture quality, use S VIDEO instead of the yellow Audio/Video cable. S VIDEO does not provide sound; the audio cables must still be connected.

### Optional connection

If your DVD player is equipped with component video outputs (Y, P<sub>B</sub>, P<sub>R</sub>), you can optimize the picture quality by using component video cables.

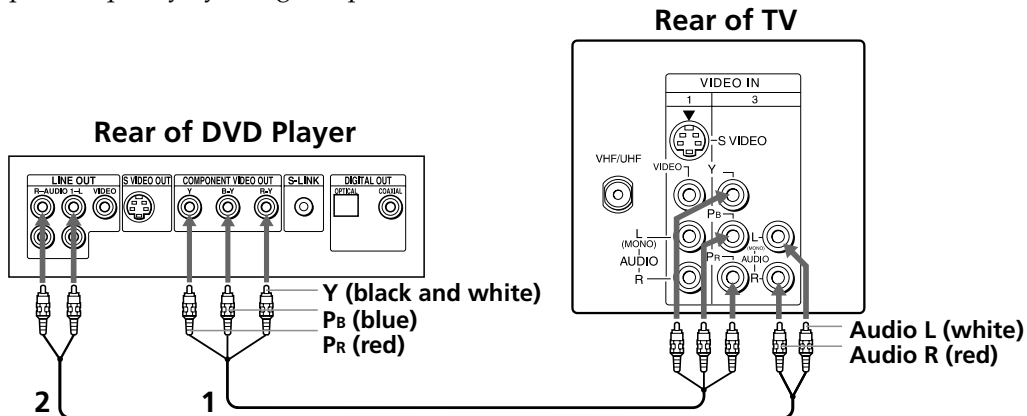

- 1 Using component video cables (not supplied), connect the Y, P<sub>B</sub>, P<sub>R</sub> OUT on your DVD player to Y, P<sub>B</sub>, P<sub>R</sub> IN on your TV.
- 2 Connect AUDIO OUT on your DVD player to AUDIO IN on your TV.

 The Y, P<sub>B</sub>, P<sub>R</sub> outputs on your DVD player are sometimes labeled Y, C<sub>B</sub>, and C<sub>R</sub> or Y, B-Y, and R-Y. If so, connect the cables to like colors.

### Connecting a Camcorder

Using Audio/Video cables (not supplied), connect AUDIO and VIDEO OUT on your camcorder to AUDIO and VIDEO IN on your TV.

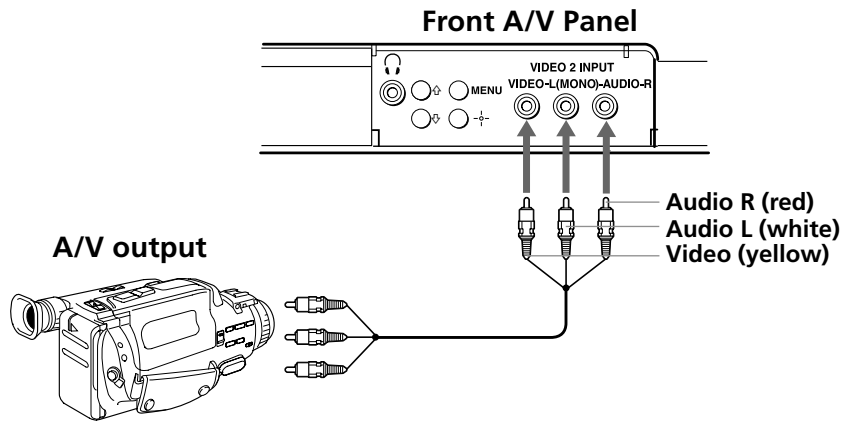

### Connecting Headphones

Connect the headphones to the  jack on the front of your TV. Headphone jack is STEREO.

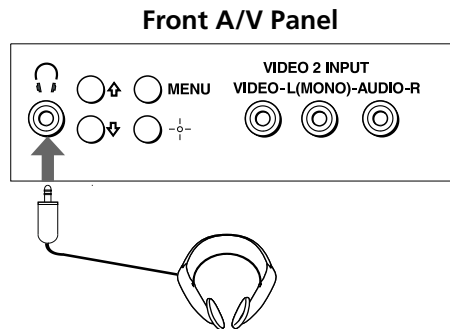

# Using the Remote Control and Basic Functions

This section shows you how to use the buttons on the remote control and how to navigate the on-screen menus.

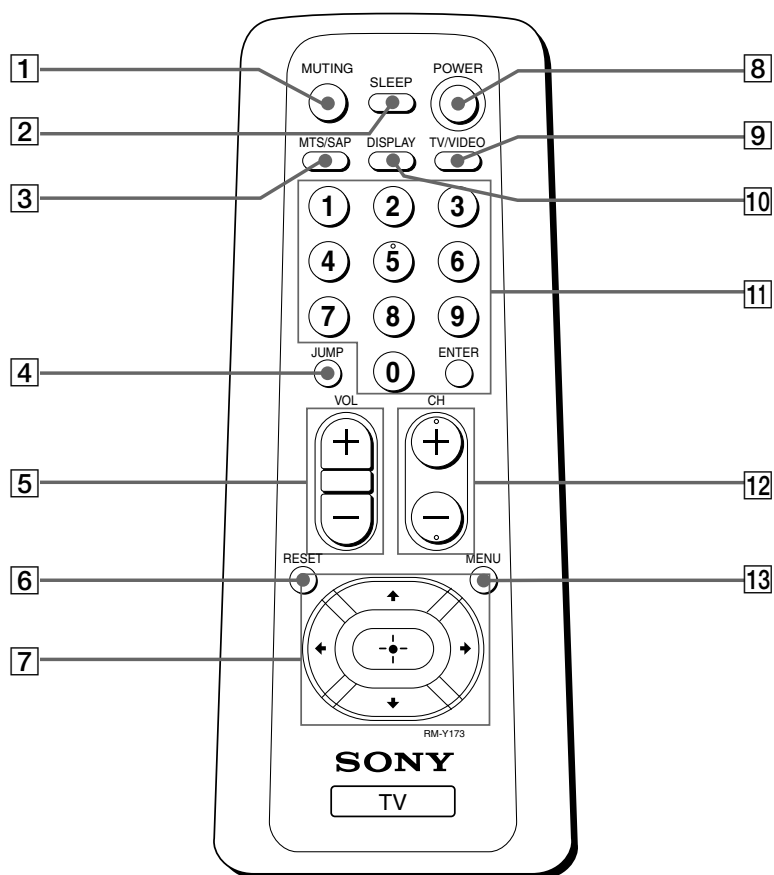

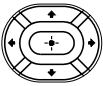

## Using the Remote Control

Button	Description
1 <b>MUTING</b>	Instantly turns off the sound. Press again or press  to restore the sound.
2 <b>SLEEP</b>	Turns the TV off automatically in approximately 15, 30, 45, 60, or 90 minutes. Cancel by pressing until SLEEP OFF appears.
3 <b>MTS/SAP</b>	Cycles through the Multi-channel TV Sound (MTS) options: Stereo, Mono, and Auto SAP (Second Audio Program).
4 <b>JUMP</b>	Press to jump back and forth between two channels. The TV alternates between current channel and the last channel that was selected.
5 <b>VOL (volume)</b>	Press when you want to adjust the volume.
6 <b>RESET</b>	Press to return to factory settings while in an on-screen menu.
7 	Moves the cursor in the on-screen menus. Press the arrow buttons to move the cursor, then press the center button to select or access an option.
8 <b>POWER</b>	Press when you want to turn the TV on or off.
9 <b>TV/VIDEO</b>	Cycles through available video inputs.
10 <b>DISPLAY</b>	Press to display the current time (if set) and channel number. Press again to turn DISPLAY off.
11 <b>0-9 and ENTER</b>	Change the channels directly. Press 0-9 buttons to select a channel, then press ENTER.
12 <b>CH (channel)</b>	Press when you want to change channels.
13 <b>MENU</b>	Displays the on-screen menu. Press again to exit the menu at any time.



 If you lose your remote control, see page 32.

### Setting Up the TV Automatically

After you have finished connecting your TV, you can perform Auto Program to set up your channels.

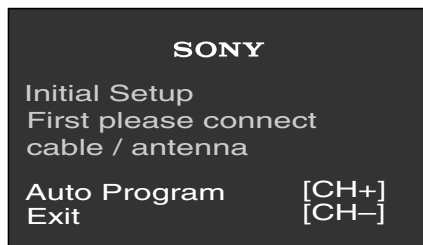









- 1 Press  to turn on the TV. The Initial Setup screen appears.





- 2 Press  on the remote control or on the TV front panel to perform Auto Program, or press  to exit.

 The Initial Setup screen appears each time you turn on the TV until you perform Auto Program.





#### To perform Auto Program again

- 1 Press .
- 2 Press  to highlight Channel Setup (  ).
- 3 Press  to highlight Cable. Press  to select.
- 4 Press  or  to select On or Off according to how you connected your TV. Press .
- 5 Press  to highlight Auto Program. Press  to search for channels.

 After performing Auto Program, press  to exit.

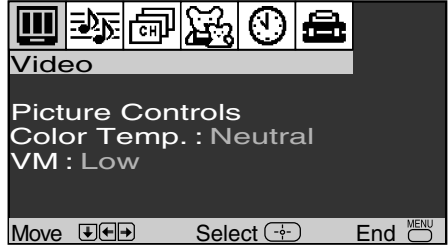
## Quick Start to the Menus

The following settings are available in your on-screen menus:

Menu	Allows you to
 <p>The screenshot shows the 'Video' menu with a navigation bar at the top containing icons for TV, Music, CH, Parental, Clock, and Print. Below the icons, the text reads 'Video', 'Picture Controls', 'Color Temp. : Neutral', and 'VM : Low'. At the bottom, there is a control bar with 'Move' (left and right arrows), 'Select' (center arrow), and 'End' (MENU button icon).</p>	<p>Make adjustments to your picture settings.</p>
 <p>The screenshot shows the 'Audio' menu with the same navigation bar as the Video menu. The text below the icons reads 'Audio' and 'MTS : Stereo'. The bottom control bar is identical to the previous menu.</p>	<p>Change your audio settings.</p>
 <p>The screenshot shows the 'Channel Setup' menu with the same navigation bar. The text below the icons reads 'Channel Setup', 'Favorite Channels', 'Cable : On', 'Channel Fix : Off', 'Auto Program', 'Channel Skip/Add', and 'Channel Label'. The bottom control bar is identical to the previous menus.</p>	<p>Customize your channel settings.</p>
 <p>The screenshot shows the 'Parental Control' menu with the same navigation bar. The text below the icons reads 'Parental Control' and 'Password : ____'. The bottom control bar is identical to the previous menus.</p>	<p>Set rating limits on your TV based on a program's rating or content.</p>

 The menus shown in this manual are for KV-24FS100. Your menus may not look like those illustrated.

## Operating Instructions

---

### Menu



### Allows you to

Set the clock on your TV and program scheduled viewing using Timer 1 and Timer 2.













Select closed captioning options, label video inputs, adjust tilt correction, select menu languages, or run a demo of the menus.

# Using the Menus

This section shows the options available for setting up and adjusting your TV.

## To Access a Menu

- 1** Press  to display the on-screen menu.
- 2** Use the  or  buttons to highlight the desired menu, then press .
- 3** Use the  or  buttons to highlight the desired option, then press .
- 4** Press  to complete the adjustment or follow the instructions that will appear on your screen to activate the desired option.
- 5** Press  to exit the menu.

 Press  once to display the on-screen menu, and press again to return to normal viewing. If no buttons are pressed, the menu closes automatically after about 90 seconds.

## Using the Video Menu

To access the Video menu, refer to the following steps:

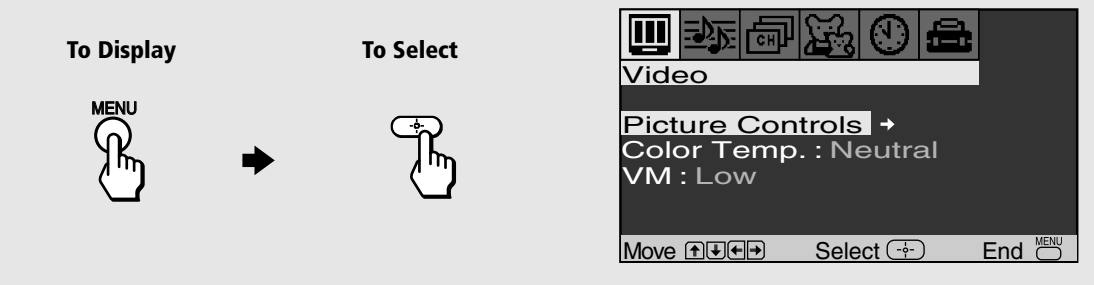

<b>Picture Controls</b>	<p>Press ⇨ to open Picture Controls menu:</p> <p><b>Picture:</b> Press ⇐ to decrease the contrast. Press ⇨ to increase contrast.</p> <p><b>Brightness:</b> Press ⇐ to darken the picture. Press ⇨ to brighten the picture.</p> <p><b>Color:</b> Press ⇐ to decrease color saturation. Press ⇨ to increase color saturation.</p> <p><b>Hue:</b> Press ⇐ to increase the red tones. Press ⇨ to increase the green tones.</p> <p><b>Sharpness:</b> Press ⇐ to soften the picture. Press ⇨ to sharpen the picture.</p>
<b>Color Temp.</b> <i>White color tint adjustment</i>	<p>Use the ⬆ or ⬇ buttons to select from one of the following options:</p> <p><b>Cool:</b> Gives the white colors a blue tint.</p> <p><b>Neutral:</b> Gives the white colors a neutral tint.</p> <p><b>Warm:</b> Gives the white colors a red tint.</p>
<b>VM</b> <i>Velocity Modulation</i>	<p><b>KV-20FS100 and KV-24FS100 only</b></p> <p>Sharpens picture definition to give objects a sharp, clean edge. Use the ⬆ or ⬇ buttons to select from one of the following options: <b>Off, High, Low.</b></p>

## Using the Audio Menu

To access the Audio menu, refer to the following steps:

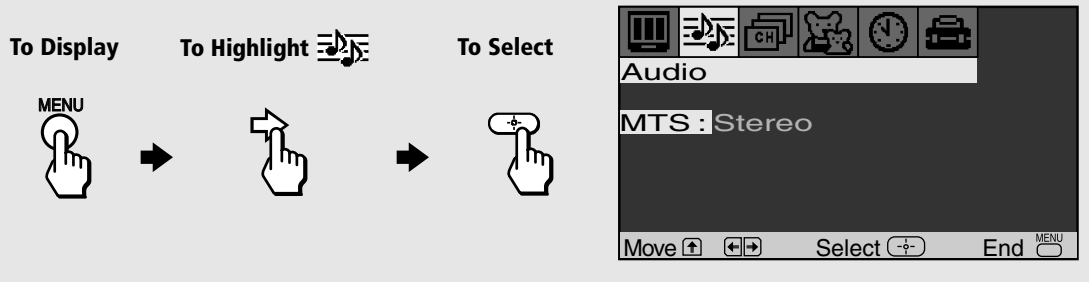

**MTS**  
Multi-Channel  
TV Sound

Press  $\uparrow$  or  $\downarrow$  to select one of the following options:

**Stereo:** Select when viewing a broadcast in stereo.

**Mono:** Select to reduce noise in areas of poor reception.

**Auto SAP:** Select to have the TV automatically switch to a Second Audio Program (SAP) when a signal is received.

 Press  $\text{MTS/SAP}$  to access MTS settings (Stereo, Mono, Auto SAP) directly.

 If your TV is set to Auto SAP, some programs may be muted or distorted. If your TV does not output sound, change your Audio setting to Stereo or Mono.

## Using the Channel Setup Menu

To access the Channel Setup menu, refer to the following steps:

The diagram illustrates the steps to access the Channel Setup menu. It shows three stages: 'To Display' with a hand pressing the MENU button, 'To Highlight' with a hand pointing to the Channel Setup icon in the menu bar, and 'To Select' with a hand pressing the Channel Setup icon. To the right is a screenshot of the Channel Setup menu with 'Channel Setup' highlighted. The menu options are: Channel Setup, Favorite Channels (with a right arrow), Cable : On, Channel Fix : Off, Auto Program, Channel Skip/Add, and Channel Label. At the bottom of the menu are navigation controls: Move (up, down, left, right arrows), Select (right arrow), and End (MENU button).

**Favorite Channels**  
*Quick access to favorite channels*

- Press ⇨ to open the Favorite Channels menu:
- 1 Use the ⇧ or ⇩ buttons to select the position (1-5) where you want to set a favorite channel, then press ⇨.
  - 2 Using the ⇧ or ⇩ button, select the desired channel.
  - 3 Press ⇨ to change to the channel selected.
  - 4 Press ⇨ to return to the Channel Setup menu or press  to exit.

 To use Favorite Channels: Exit all menus and press ⇨. Press ⇧ or ⇩ to move the cursor to the desired channel number and press ⇨.

**Cable**      **On:** Select if you are receiving cable channels with a CATV cable.  
**Off:** Select if you are using a TV antenna.

 After changing your cable settings, you will need to perform Auto Program. When Channel Fix is set, you will not be able to use your Cable settings.

**Channel Fix**      **2-6:** Select when you want to control all channel selection through a cable box or VCR. Select the appropriate channel (usually 3 or 4) and use the cable box's or VCR's remote control for channel selection.  
**Video 1:** Select from available video inputs when you have connected video equipment (e.g. satellite receiver) and you want your TV fixed to it.  
**Off:** Channel Fix is not set.

**Auto Program**      Press ⇨ to perform Auto Program.  
The TV will scan through all available channels and program receivable channels.



### Channel Skip/Add

Use this feature after you run Auto Program to skip unwanted channels or add new ones. Press  $\Rightarrow$  to open the Channel Skip/Add menu:

- 1 Use the  $\uparrow$  or  $\downarrow$  buttons to select the position of the desired channel, then press  $\oplus$ .
- 2 Use the  $\uparrow$  or  $\downarrow$  buttons to select Skip or Add, then press  $\oplus$ .
- 3 Press  $\leftarrow$  to return to the Channel Setup menu or press  $\text{MENU}$  to exit.

 Pressing CH+ or CH- will skip over channels that have been skipped. You can still use the 0-9 buttons to directly tune to skipped channels.

### Channel Label

*Label up to 40 channels with their call letters*

Press  $\Rightarrow$  to open the Channel Label menu:

- 1 Press  $\oplus$ , then press  $\uparrow$  or  $\downarrow$  until you reach the desired channel number. Press  $\oplus$  to activate the channel.
- 2 Press  $\oplus$ , then use the  $\uparrow$  or  $\downarrow$  button to display the first call letter or number of the caption, then press  $\oplus$  to select it. When finished, press  $\oplus$  to activate.

 Favorite Channels, Cable, Channel Skip/Add, and Channel Label cannot be used when Channel Fix is set.

# Parental Control

The Parental Control feature is designed to help parents monitor what their children watch on television. This section shows you the different rating systems available and how to set your TV's rating limit.

## Overview of the Ratings

Once you have become familiar with these rating systems, you should be ready to set your TV's rating limit.

## Movie Rating

### (U.S. models only)

This system defines the rating levels of movies shown in theaters and on prime cable channels.

Rating	Defined as
<b>G</b>	General audience
<b>PG</b>	Parental Guidance suggested
<b>PG-13</b>	Parents strongly cautioned
<b>R</b>	Restricted
<b>NC-17</b>	No one 17 and under admitted
<b>X</b>	Adult audience only

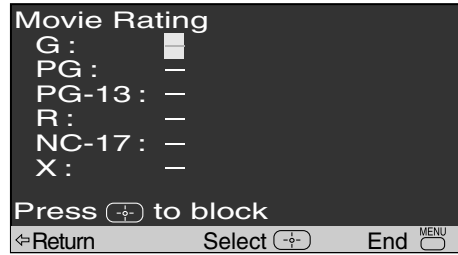

## TV Rating

### (U.S. models only)

The TV rating is divided into two groups: age-based and content-based.

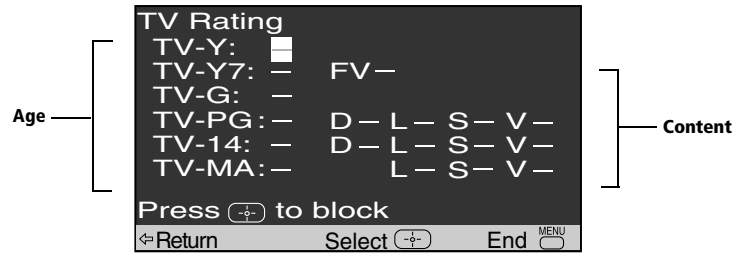

Age	Defined as
<b>TV-Y</b>	All children
<b>TV-Y7</b>	Directed to older children
<b>TV-G</b>	General audience
<b>TV-PG</b>	Parental Guidance suggested
<b>TV-14</b>	Parents strongly cautioned
<b>TV-MA</b>	Mature Audience only

Content	Defined as
<b>FV</b>	Fantasy Violence
<b>D</b>	Suggestive dialogue
<b>L</b>	Strong language
<b>S</b>	Sexual situations
<b>V</b>	Violence

The content ratings will increase depending on the level of the age-based rating. For example, a program with a TV-PG V (Violence) rating may contain moderate violence, while a TV-14 V (Violence) rating may contain intense violence.

## Unrated

### (U.S. models only)

You have the option of blocking TV programs or movies that are not rated.

<b>Allow</b>	Allows all unrated programs
<b>Block</b>	Blocks all unrated programs



If you choose to block unrated TV programs, please be aware that the following programs may be blocked: emergency broadcasts, political programs, sports, news, public service announcements, religious programs, and weather.

## Operating Instructions

### English Rating

#### (Canadian models only)

These ratings are for Canadian programs that are broadcast in English.

Rating	Defined as
<b>C</b>	Children
<b>C8+</b>	Children 8 years and older
<b>G</b>	General programming
<b>PG</b>	Parental Guidance
<b>14+</b>	Viewers 14 and older
<b>18+</b>	Adult programming

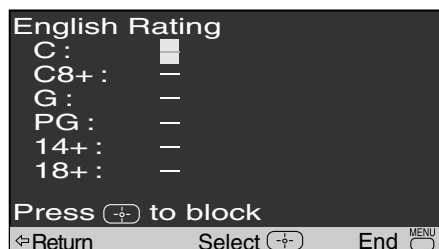

### French Rating

#### (Canadian models only)

These ratings are for Canadian programs that are broadcast in French.

Rating	Defined as
<b>G</b>	General
<b>8 ans+ :</b>	Not recommended for younger children
<b>13 ans+ :</b>	Not recommended for children under age 13
<b>16 ans+ :</b>	Not recommended for ages under 16
<b>18 ans+ :</b>	This program is restricted to adults

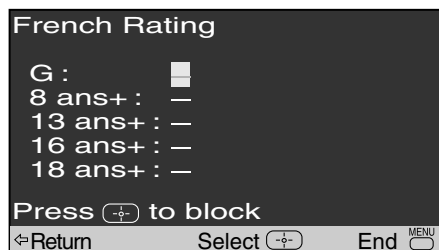

### U.S.A. Rating

#### (Canadian models only)



For programs from the United States, please see “TV Rating” on page 23.

## Using the Parental Control Menu

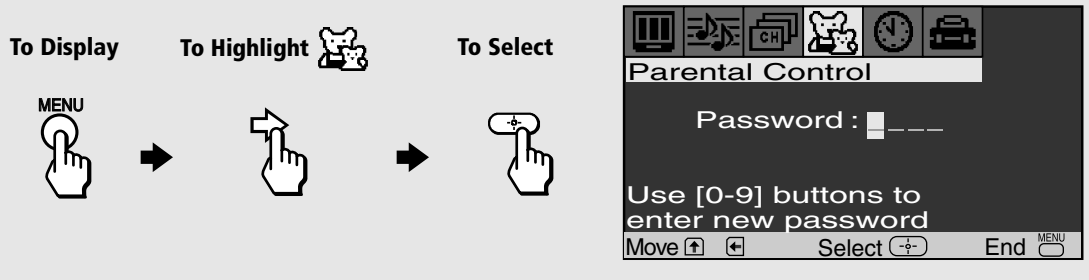
To access the Parental Control menu, refer to the following steps:



In the Parental Control  menu, you will be asked to set a 4-digit password for any further access into Parental Control.

- 1 Press , then use the  buttons to enter a 4-digit password.

 Keep this manual in a safe place. If you forget your password, see page 32.

- 2 Confirm your password by entering it again.

Once your password is set correctly, the next Parental Control menu appears. For future access to this menu, use your password. A password is needed every time you want to access Parental Control menu.

## Operating Instructions

### Setting the Rating

You can change the Rating by selecting one of the Lock options.



- 1 With Lock highlighted, press **↵**.

If you are not familiar with the Parental Guidelines rating system, use one of the following preselected categories to simplify the rating selections: Child, Youth, Young Adult.

- 2 Use the **↑** or **↓** buttons to select the desired rating, then press **↵**.

Rating	TV will allow a maximum rating of
Child	TV-Y, TV-G, G (U.S. models only), G (Canadian models only)
Youth	TV-PG, PG (U.S. models only), PG (Canadian models only)
Young Adult	TV-14, PG-13 (U.S. models only), 14+ (Canadian models only)
Custom	Select to set more restrictive ratings (see next section)
Off	No rating limit

### Changing your Password

- 1 Use the **↑** or **↓** button to move the cursor to Change Password and press **↵**.
- 2 Follow steps 1 and 2 for “Using the Parental Control Menu” on page 25.

### Information for Parents

#### To view a program that exceeds the TV rating

- Press **ENTER**, then use the **0-9** buttons to enter your password.

 Entering your password to view a blocked program will temporarily turn Lock to Off. To reactivate your Lock settings, turn the TV off. When you turn the TV on, your Lock settings are restored.

### Using the Custom Menu

Before setting Custom ratings, see pages 22-24, "Overview of the Ratings," for a description of the available rating systems.

Follow the instructions on the screen to make your custom settings. Select the country desired for your TV's rating limit. See page 23 for U.S. models and page 24 for Canadian models for more information.

 Once you have blocked a rating or content, all higher ratings or content will be automatically blocked.

## Using the Timer ⌚ Menu

To access the Timer menu, refer to the following steps:

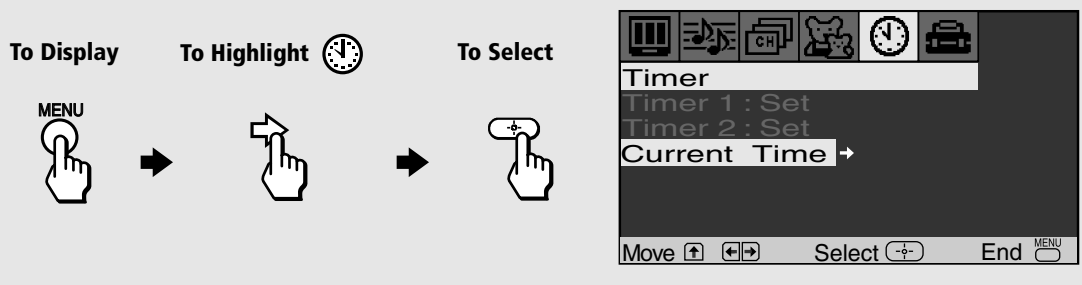

- Current Time** Set your TV to the current day and time.  
Press to open Current Time menu:
- 1 Use the or button to enter the day and time, then press .
  - 2 Press to exit the menu.

You must set the Current Time before you can use Timer 1 and Timer 2.

- Timer 1 and Timer 2** Use your timers settings to program your TV by day, time, duration and channel. The timer's duration is maximum of 6 hours. When the channel is fixed, it is not necessary to set the channel.  
*Scheduled viewing*
- With the menu open, set cursor on Timer 1 or Timer 2:
- 1 Press or to select Timer 1 or Timer 2, then press .
  - 2 Press or to enter the desired day, time, duration and channel, then press . The Timer status should be On when the Timer has been set.
  - 3 Press to exit the menu.

You can set the Timer to On, Off, or Set. Once the timer is set, you can turn it On or Off without having to go through the settings. When you set Timer 1 or Timer 2, a red light on the front panel of your TV will turn on.

When you perform Auto Program, Timer 1 and Timer 2 settings will be cleared. Also, in the event of any loss of power, Current Time and Timer 1 and Timer 2 settings will be cleared.



## Using the Setup Menu

To access the Setup menu, refer to the following steps:

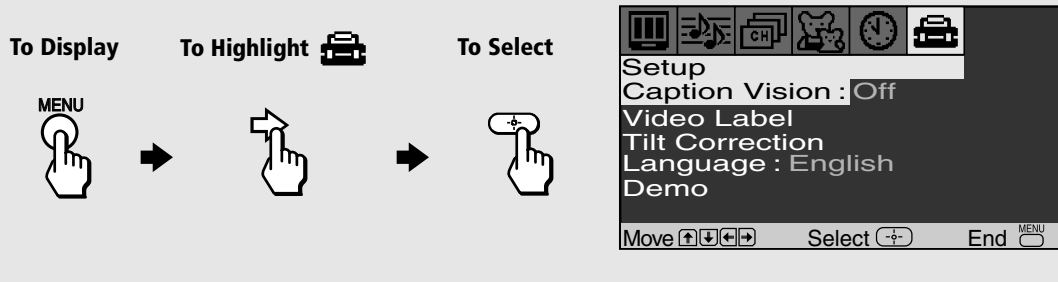

<b>Caption Vision</b> <i>Closed-Captioning</i>	Allows you to select from three closed caption modes (for programs that are broadcast with closed caption). Press $\uparrow$ or $\downarrow$ to select one of the following options: <b>CC1, 2, 3, 4:</b> Displays printed dialogue and sound effects of a program. <b>Text1, 2, 3, 4:</b> Displays network/station information. <b>XDS</b> (Extended Data Services): Displays the name of the current program and its remaining time, if available. <b>Off:</b> Caption Vision is not activated.
<b>Video Label</b> <i>Label connected equipment</i>	Allows you to label the audio/video components you connected to the TV: VCR, DVD, etc. When you press TV/VIDEO to switch inputs, the Video Label will display on-screen. Press $\Rightarrow$ to open the Video Label menu: <b>1</b> Press $\uparrow$ or $\downarrow$ to access the input you want to label and press $\Rightarrow$ . <b>2</b> Press $\uparrow$ or $\downarrow$ to choose a label and press $\Rightarrow$ .
<b>Tilt Correction</b>	Press $\Rightarrow$ to open Tilt Correction: Press $\uparrow$ or $\downarrow$ to correct any tilt of the picture from -5 to +5, then press $\Rightarrow$ to activate and return to the Setup menu.
<b>Language</b>	Display all menus in the language of your choice. Use the $\uparrow$ or $\downarrow$ buttons to select desired language and press $\Rightarrow$ .
<b>Demo</b>	Press $\Rightarrow$ to run a demonstration of the on-screen menus.

 You can press any key to exit the Demo mode.



# Other Information

## Troubleshooting

If you are having a problem with your TV, try the suggestions below. If the problem persists, contact your nearest Sony Dealer.

---

<b>No picture, no sound</b>	<ul style="list-style-type: none"><li><input type="checkbox"/> Make sure the power cord is plugged in.</li><li><input type="checkbox"/> If a red light is flashing on the front of your TV for more than a few minutes, disconnect and reconnect the power cord to restore the TV. If the problem continues, call your local service center.</li><li><input type="checkbox"/> Check the TV/VIDEO settings: when watching TV, set to TV; when watching video equipment, set to VIDEO (page 13).</li><li><input type="checkbox"/> Make sure the batteries have been inserted correctly into the remote control (page 2).</li><li><input type="checkbox"/> Try another channel; it could be station trouble.</li></ul>
<b>Poor or no picture, good sound</b>	<ul style="list-style-type: none"><li><input type="checkbox"/> Adjust Picture in the Picture Controls menu under Video (page 18).</li><li><input type="checkbox"/> Adjust Brightness in the Picture Controls menu under Video (page 18).</li><li><input type="checkbox"/> Check the antenna and/or cable connections (page 4).</li></ul>
<b>Good picture, no sound</b>	<ul style="list-style-type: none"><li><input type="checkbox"/> Press  so that MUTING disappears from the screen (page 13).</li><li><input type="checkbox"/> Check your Audio settings. Your TV may be set to Auto SAP (page 19).</li></ul>
<b>No color</b>	<ul style="list-style-type: none"><li><input type="checkbox"/> Adjust Color in the Picture Controls menu under Video (page 18).</li></ul>
<b>Only snow appears on the screen</b>	<ul style="list-style-type: none"><li><input type="checkbox"/> Check the Cable setting in the Channel Setup menu (page 20).</li><li><input type="checkbox"/> Check the antenna and/or cable connections (page 4).</li><li><input type="checkbox"/> Make sure the channel selected is currently broadcasting.</li></ul>
<b>Dotted lines or stripes</b>	<ul style="list-style-type: none"><li><input type="checkbox"/> Adjust the antenna.</li><li><input type="checkbox"/> Move the TV away from other electronic equipment. Some electronic equipment can create electrical noise, which can interfere with TV reception.</li></ul>
<b>Double images or ghosts</b>	<ul style="list-style-type: none"><li><input type="checkbox"/> Check your outdoor antenna or call your cable service.</li></ul>

---

## Operating Instructions

---

<b>Cannot receive higher number channels (UHF) when using an antenna</b>	<ul style="list-style-type: none"><li><input type="checkbox"/> Make sure Cable is set to Off in the Channel Setup menu (page 20).</li><li><input type="checkbox"/> Perform Auto Program to add channels that are not presently in the memory (page 14).</li></ul>
<b>Cable stations don't seem to work</b>	<ul style="list-style-type: none"><li><input type="checkbox"/> Make sure Cable is set to On in the Channel Setup menu (page 20).</li><li><input type="checkbox"/> Perform Auto Program to add channels that are not presently in the memory (page 14).</li></ul>
<b>Remote control does not operate</b>	<ul style="list-style-type: none"><li><input type="checkbox"/> Batteries could be weak. Replace them (page 2).</li><li><input type="checkbox"/> Move the TV 3-4 or more feet away from fluorescent lights.</li></ul>
<b>The TV needs to be cleaned</b>	<ul style="list-style-type: none"><li><input type="checkbox"/> Clean the TV with a soft dry cloth. Never use strong solvents such as thinner or benzine, which might damage the finish of the cabinet.</li></ul>
<b>Lost password for Parental Control</b>	<ul style="list-style-type: none"><li><input type="checkbox"/> In the password screen, enter the following master password: 4357. After using the master password, you must create a new password, it cannot be used to unlock currently blocked channels.</li></ul>
<b>You lost your remote control</b>	<ul style="list-style-type: none"><li><input type="checkbox"/> You can use the front Audio/Video panel controls to access the menu (page 2). Contact your nearest Sony Dealer to order a replacement.</li></ul>

*If, after reading these Operating Instructions, you have additional questions related to the use of your Sony television, please call our Direct Response Center at 1-800-222-SONY (7669) (U.S. residents only) or (416) 499-SONY (7669) (Canadian residents only).*

## Specifications

### For all models (except as noted)

Television system	American TV standard/NTSC
Channel coverage	VHF: 2-13/UHF: 14-69/CATV: 1-125
Antenna	75-ohm external antenna terminal for VHF/UHF
Picture tube	FD Trinitron® tube
Power requirements	120V, 60 Hz
Supplied Accessories	Size AA (R6) batteries (2) Remote Control RM-Y173 (1)
Optional Accessories	Connecting cables VMC-810S/820S, VMC-720M, YC-YC-15V/30V, RK74A EAC-66 U/V mixer

### **KV-13FS100, KV-13FS110**

Screen size	Visible screen size: 13 inches (330 mm) measured diagonally Actual screen size: 14 inches (355.6 mm) measured diagonally
Inputs/outputs	2 video, 2 audio 1 Y, P <sub>B</sub> , P <sub>R</sub> , 1 audio 1 headphone jack
Speaker output	3 W x 2
Power Consumption	100 W in use 1 W in standby
Dimensions (W/H/D)	407 x 340 x 411 mm (16x 13 <sup>3</sup> / <sub>8</sub> x 16 <sup>1</sup> / <sub>8</sub> in.)
Mass	12 kg (26 lbs. 7 oz.)

### **KV-20FS100**

Screen size	Visible screen size: 20 inches (508 mm) measured diagonally Actual screen size: 21 inches (533.4 mm) measured diagonally
Inputs/outputs	2 video, 2 audio 1 Y, P <sub>B</sub> , P <sub>R</sub> , 1 audio 1 headphone jack
Speaker output	5 W x 2
Power Consumption	120 W in use 1 W in standby
Dimensions (W/H/D)	592 x 466 x 494 mm (23 <sup>1</sup> / <sub>4</sub> x 18 <sup>3</sup> / <sub>8</sub> x 19 <sup>1</sup> / <sub>2</sub> in.)
Mass	24.8 kg (54 lbs. 10 oz.)

## Operating Instructions

---

### **KV-24FS100**

Screen size	Visible screen size: 24 inches (610 mm) measured diagonally Actual screen size: 25 inches (635 mm) measured diagonally
Inputs/outputs	2 video, 2 audio 1 S VIDEO 1 Y, P <sub>B</sub> , P <sub>R</sub> , 1 audio 1 headphone jack
Speaker output	7.5 W x 2
Power Consumption	145 W in use 1 W in standby
Dimensions (W/H/D)	704 x 524 x 472 mm (27 <sup>3</sup> / <sub>4</sub> x 20 <sup>5</sup> / <sub>8</sub> x 18 <sup>1</sup> / <sub>2</sub> in.)
Mass	35 kg (77 lbs. 1oz.)

Design and specifications are subject to change without notice.

# Index

## A

Audio  Menu 19  
Auto Program 14, 20  
Auto SAP 19

## B

Battery Installation 2  
Brightness 18

## C

Cable 20  
Caption Vision 29  
Channel Fix 20  
Channel Label 21  
Channel Setup  Menu 20  
Channel Skip/Add 21  
Color 18  
Connections  
    Cable and Antenna 4  
    Connecting a Camcorder 11  
    Connecting a DVD Player 10  
    Connecting Headphones 11  
    TV and Cable Box 6  
    TV and VCR 5  
    TV and Satellite Receiver 8  
    TV, Satellite Receiver, and VCR 9  
    TV, VCR, and Cable Box 7  
Current Time 28

## D

Demo 29  
DISPLAY 13

## F

Favorite Channels 20  
Front A/V Panel (*see TV Front Panel*) 2





## H

Hue 18

## L

Language 29

## M

Menus  
    Audio  19  
    Channel Setup  20  
    Parental Control  25  
    Setup  29  
    Timer  28

Video  18  
Mono 19  
MTS  
    Auto SAP 19  
    Mono 19  
    Stereo 19

## P

Parental Control 22  
Parental Control  menu 25  
Picture 18  
Picture Controls 18  
    Brightness 18  
    Color 18  
    Hue 18  
    Picture 18  
    Sharpness 18

## R

Ratings  
    English Rating 24  
    French Rating 24  
    Movie Rating 22  
    TV Rating 23  
    Unrated 23  
    U.S.A. Rating 24  
Remote Control 12

## S

Setup  menu 29  
Sharpness 18  
SLEEP 13  
Specifications 33  
Stereo 19

## T

Tilt Correction 29  
Timer  Menu 28  
Timer 1 and Timer 2 28  
Troubleshooting 31  
TV Features 1  
TV Front Panel 2  
TV Rear Panel 3

## V

Video  Menu 18  
Video Label 29  
VM 18

