

**SONY**

3-866-074-21

# **Trinitron<sup>®</sup> Color TV**

---

Operating Instructions

*KV-27S42*  
*KV-27S46*  
*KV-27S66*  
*KV-27V42*  
*KV-27V66*

L

© 1999 by Sony Corporation

# Introduction

Congratulations on your purchase of the Sony Trinitron® Color TV. Before you begin using this manual, please check the model number located on the front cover of this instruction manual.

The menu and illustrations used in these instructions are for KV-27S46. Differences in operation or features will be indicated in the text, for example, "KV-27S46 only."

## Trinitron® Color TV Features



Depending on your TV, some of the features you will enjoy include:

- ❑ **PARENTAL CONTROL** — A tool for parents to help monitor what their children watch on TV by establishing rating limits.
- ❑ **FAVORITE CHANNEL** — Instant access to your favorite channels with the touch of a button.
- ❑ **Picture in Picture (PIP)** — Allows you to view two channels simultaneously, (KV-27S46, 27S66, 27V66 only).
- ❑ **Universal Remote Control** — Program your remote control to operate your connected cable box, VCR, digital satellite receiver or DVD player.
- ❑ **Energy Star** — A recognized symbol of energy efficiency.
- ❑ **S VIDEO** — A video input that offers enhanced picture quality.
- ❑ **Direct MTS** — Allows direct access to changing your Multi-Channel TV Sound: STEREO, SAP (Second Audio Program) or MONO, with the touch of a button.
- ❑ **Front A/V inputs** — A quick connection for video games, camcorders or stereo equipment, (KV-27V42, 27V66 only).

## Batteries for the Remote Control

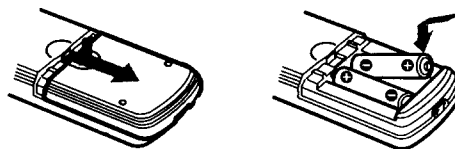
Insert two AA (R6) batteries (supplied) into the remote control using the following illustration as a guide.



-  Under normal conditions, batteries will last up to six months. If the remote control does not operate properly, the batteries might be worn out.
-  Remove the batteries to avoid possible damage from battery leakage if you will not be using the remote control for an extended period of time.
-  Your remote control can be programmed to operate most video equipment, (see page 31).

## About this Manual

This manual provides instructions to help you enjoy your new TV. It shows you how to connect to an antenna or cable, cable box, VCR, DVD, satellite receiver, stereo system or camcorder. Once you're connected, follow the instructions to learn how to use the remote control to access the on-screen menus.

# Connecting Your TV

This section covers basic connections in addition to any optional equipment you may be connecting.

## Basic Connections

### TV with indoor or outdoor antenna, or CATV cable

Depending on the cable available in your home, choose one of the connections below:

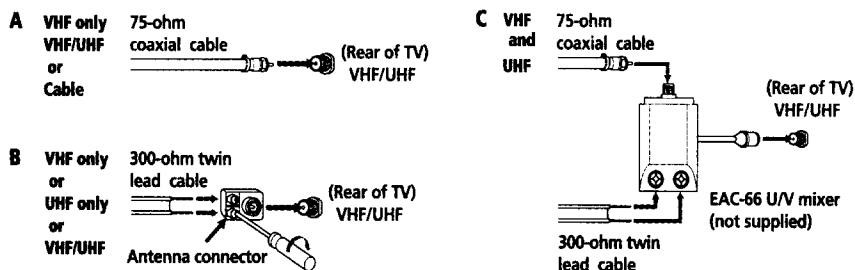

If you are connecting to an indoor or outdoor antenna, it will be necessary to adjust the orientation of the antenna for best reception.

### Cable and antenna

KV-27S66, 27V66 only

If your cable provider does not feature local channels, you may find this set up convenient.

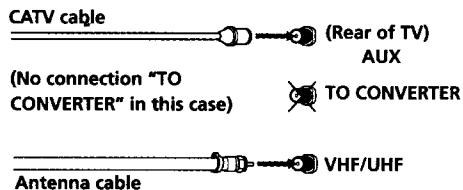

Select CABLE or ANT mode by pressing on the remote control.

## Connecting Additional Equipment

### TV and VCR

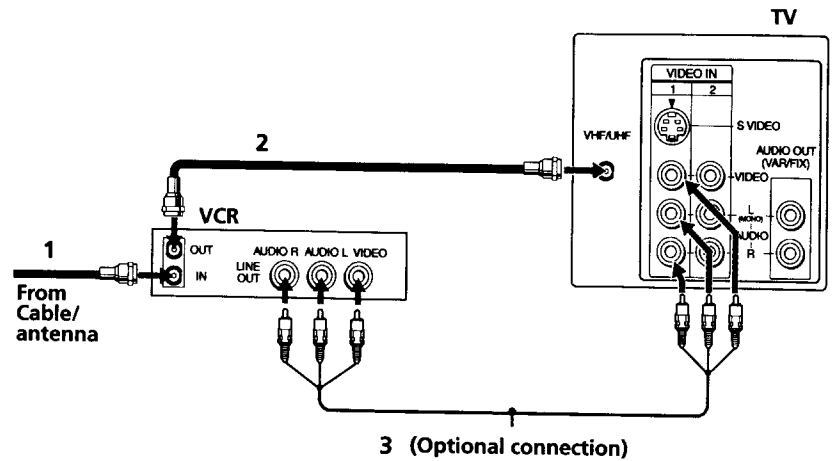

! VCR must be connected and turned on to operate PIP. (KV-27S46 only)

- 1 Connect the coaxial cable from your TV antenna or cable TV to the IN jack on your VCR.
- 2 Connect a coaxial cable (not supplied) from the OUT jack on your VCR to the VHF/UHF IN jack on the TV.

🔧 To watch video programs from your VCR, tune your TV to channel 3 or 4 (as set on the rear of your VCR)



#### (Optional connection)

- 3 If your VCR is equipped with video inputs, for better picture quality you should connect A/V cables to AUDIO and VIDEO OUT on your VCR to AUDIO/VIDEO IN on your TV. You can use the  button to switch between the TV and VCR inputs.

🔧 For optimum picture quality, use S VIDEO instead of the yellow A/V cable. S VIDEO does not provide sound, the audio cables must still be connected.

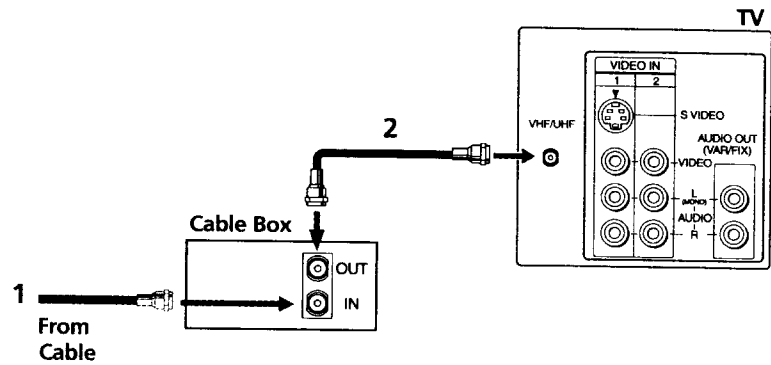
## TV and Cable Box



- 1** Connect the coaxial cable from the wall to the IN jack on your cable box.
  - 2** Connect a coaxial cable (not supplied) from the OUT jack on your cable box to the VHF/UHF IN jack on the TV.
-  To view channels from your cable box, tune your TV to channel 3 or 4 (as set on the rear panel of your cable box).
-  If you will be controlling all channel selection through your cable box, you should consider using the CHANNEL FIX feature on page 24.

## TV, Cable box and Cable

**KV-27S66, 27V66 only**

For this set up, you can switch between scrambled channels (through your cable box), and normal (CATV) channels by pressing **ANT** on your remote control.

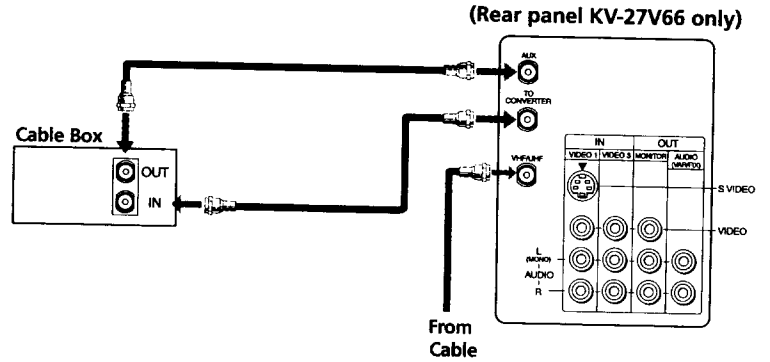

⚠ When using PIP, the AUX input cannot be viewed in the window picture.

## TV, VCR, and Cable box

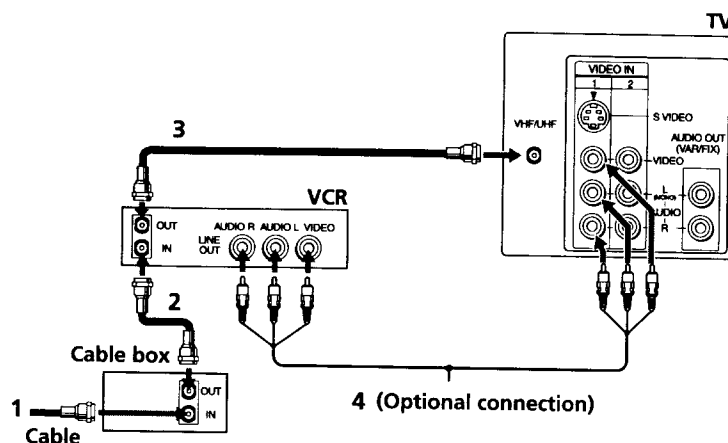

- 1** Connect the coaxial cable from the wall to the IN jack on your cable box.
- 2** Connect a coaxial cable (not supplied) from the OUT jack on your cable box to the IN jack on your VCR.
- 3** Connect a coaxial cable (not supplied) from the OUT jack on your VCR to the VHF/UHF IN jack on the TV.

If you will be controlling all channel selection through your cable box, you should consider using the CHANNEL FIX feature on page 24.

**(Optional connection)**

- 4** If your VCR is equipped with video inputs, for better picture quality you should connect A/V cables to AUDIO and VIDEO OUT on your VCR to AUDIO/VIDEO IN on your TV. You can use the button to switch between the TV and VCR inputs.

For optimum picture quality, use S VIDEO instead of the yellow A/V cable. S VIDEO does not provide sound, the audio cables must still be connected.



## TV and Digital Satellite Receiver

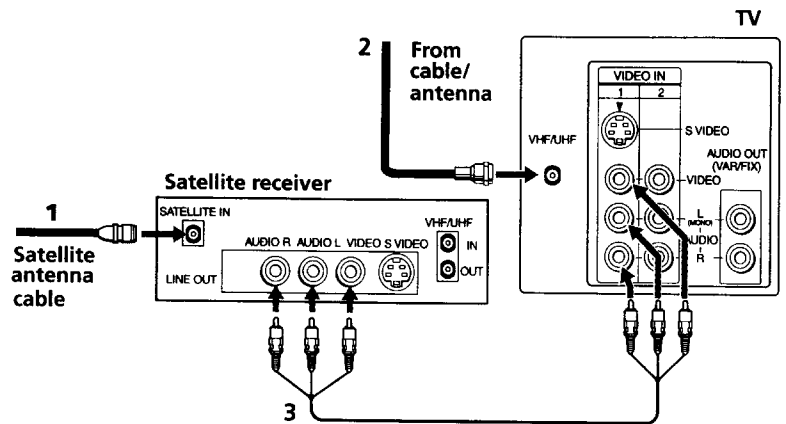



- 1** Connect the cable from your satellite antenna to SATELLITE IN on the satellite receiver.
- 2** Attach the coaxial connector from your cable or antenna to VHF/UHF IN on your TV.
- 3** Using A/V connectors, connect AUDIO and VIDEO OUT on your satellite receiver to AUDIO and VIDEO IN on your TV. You can use the  button to switch between the satellite receiver and the TV.

 For optimum picture quality, use S VIDEO instead of the yellow A/V cable. S VIDEO does not provide sound, your audio connectors must still be connected.

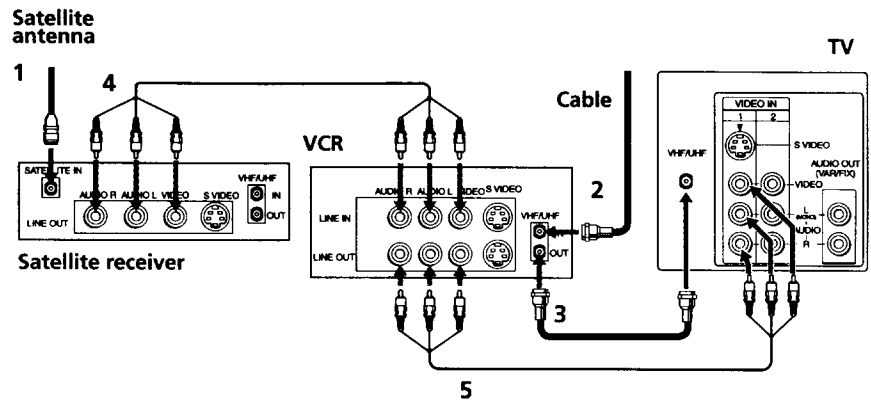
## TV, Digital Satellite Receiver and VCR



- 1** Connect the cable from your satellite antenna to SATELLITE IN on the satellite receiver.
- 2** Attach the coaxial connector from your cable or antenna to VHF/UHF IN on your VCR.
- 3** Using a coaxial cable, connect VHF/UHF OUT on your VCR to VHF/UHF IN on your TV.
- 4** Using A/V connectors, connect AUDIO and VIDEO OUT on your satellite receiver to AUDIO and VIDEO IN on your VCR.
- 5** Using A/V connectors, connect AUDIO and VIDEO OUT on your VCR to AUDIO and VIDEO IN on your TV.

 To view from the satellite or VCR, select the video input to which your satellite receiver or VCR is connected by pressing  on the remote control.

## Connecting a Camcorder

Using A/V cables, connect AUDIO and VIDEO OUT on your camcorder to AUDIO and VIDEO IN on your TV.

(Front A/V Panel KV-27V42, 27V66 only)

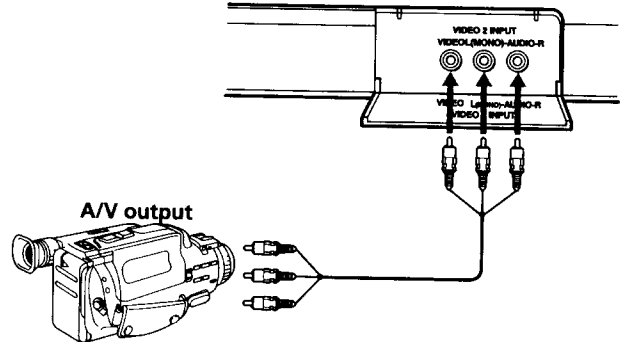

⚠ Connection can also be made to the rear A/V panel of your TV.

## Connecting a DVD Player

Using A/V connectors, connect LINE OUT on your DVD to VIDEO IN on your TV.

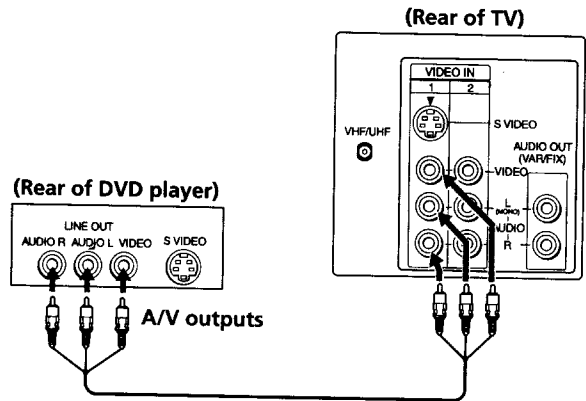

⚠ For optimum picture quality, use S VIDEO instead of the yellow A/V cable. S VIDEO does not provide sound, your audio connectors must still be connected.

## Connecting an audio system

Using audio connectors, connect AUDIO OUT on your TV to one of the unused line inputs (e.g. TV, AUX, TAPE 2) on your stereo.

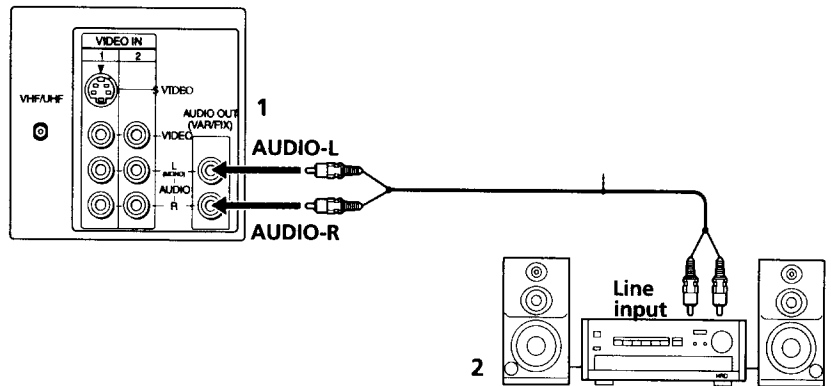

- Set your stereo to the chosen line input. (See page 20 for additional audio setup instructions.)

## Connecting two VCRs for Tape Editing

KV-27V42, 27V66 only

MONITOR OUT gives you the ability to use a second VCR to record a program being played by the primary VCR to perform tape editing.

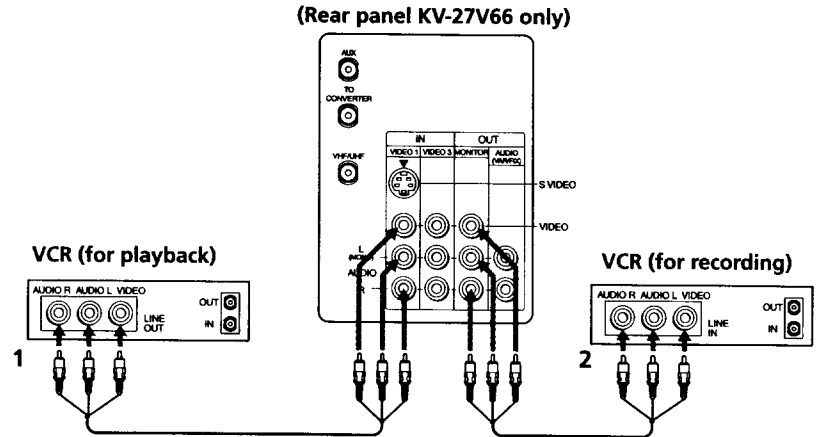

- 1 Connect the VCR intended for playback using the setup instructions on page 4 of this manual.
- 2 Using A/V connectors, connect AUDIO and VIDEO IN on your VCR intended for recording to MONITOR AUDIO and VIDEO OUT on your TV.

 To perform tape editing; set the TV to the video input intended for playback by pressing  on the remote control.

# Using the Remote Control and Basic Functions

This section shows you how to use more advanced buttons on the remote control and how to use the on-screen menus.

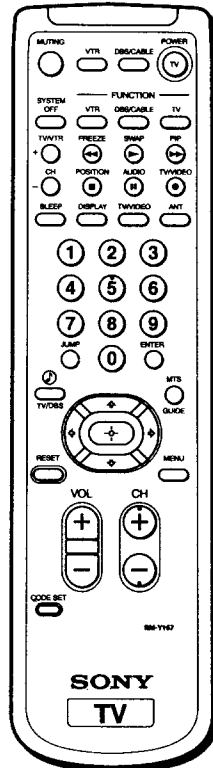

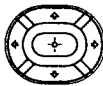
<b>POWER</b>	Press when you want to turn connected equipment on and off.
<b>FUNCTION</b>	Press when you want to control connected equipment with your remote control.
	Moves the cursor in the on-screen menus. Press the arrow buttons to move the cursor, press the center button to select or access an option.
<b>RESET</b>	Press to return to factory settings while in the on-screen menu.
<b>JUMP</b>	Alternates back and forth between the last two channels selected with the 0-9 buttons.
<b>MENU</b>	Displays the on-screen menu. Press again to exit the menu at any time.
<b>MUTING</b>	Instantly turns off the sound. Press again or press VOL+ to restore sound.
<b>SLEEP</b>	Turns the TV off automatically in approximately 30, 60 or 90 minutes. Cancel by pressing until SLEEP OFF appears.
<b>DISPLAY</b>	Press once to show current time, (if set) and channel number. Press again to activate CAPTION VISION settings, if available. To cancel, press again until DISPLAY OFF appears.
<b>TV/VIDEO</b>	Cycles through available video inputs.
<b>ANT</b>	Press to change the VHF/UHF input to the AUX input. (KV-27S66, 27V66 only).

<b>TV/VTR</b>	Press when you are finished using a VCR and you want to switch to the TV input. Your VCR power will remain on.
<b>MTS/GUIDE</b>	Cycles through the Multi-channel TV Sound (MTS) options: STEREO, SAP (Second Audio Programming), MONO.
<b>SYSTEM OFF</b>	Powers off all Sony equipment at once. (May not work with older equipment).
	Cycles through available AUDIO settings (see page 20).
<b>CODE SET</b>	Use to program your remote control to operate connected video equipment. (see page 31)

 For information on Picture in Picture (PIP) operation buttons, please see page 16.

## Setting Up the TV Automatically

After you have finished connecting your TV, you will want to run AUTO PROGRAM to set up your channels.

- 1** Press  to turn on the TV, the initial setup screen appears.

### (U.S. models only)

ENGLISH:	[CH+]
ESPAÑOL:	[CH-]
AUTO SET UP:	[VOL+]
DEMO:	[VOL-]
MENU	[TV/VIDEO]
First please connect cable/antenna Press [SET UP] to exit	

### (Canadian models only)

ENGLISH:	[CH+]
ESPAÑOL:	[CH-]
FRANÇAIS:	[VOL+]
AUTO SET UP:	[VOL-]
DEMO:	[TV/VIDEO]
First please connect cable/antenna Press [SET UP] to exit	



- 2** Make your language selection, the menus will change to reflect your choice.
- 3** Follow the on-screen instructions to continue AUTO SET UP or for a DEMO of the menus.

### For U.S. models only

- 4** Press  to operate the on-screen menus without the use of a remote control. Follow the on-screen instructions to make adjustments to your TV settings.

### To perform AUTO SETUP again

- Press the  button on the front panel of the TV.

 To reset your TV to factory settings, turn the TV on. Then, while pressing the  button on the remote control, press POWER on the TV. The TV will turn itself off, then back on, the original settings will be restored.



## Using Picture in Picture (PIP)

The Picture-in-Picture (PIP) feature allows you to view two channels simultaneously, one in the full size "main" picture and one in a smaller "window" picture.

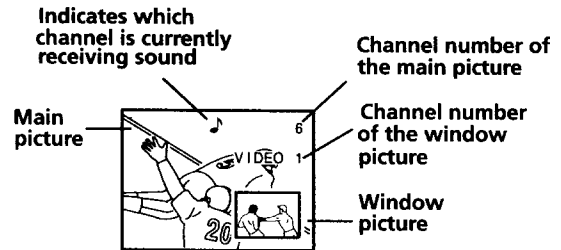

### Single Turner PIP

KV-27S46 only

This model is equipped with a single tuner. This simply means that a VCR must be connected and turned on for PIP to operate (see page 4).









- ❑ Your remote control needs to be programmed to operate the VCR (see page 31).

PIP 	Press to display and change the size of the window picture.
TV/VIDEO 	Press until you reach the VCR input in the window picture.
TV/VIDEO 	Press until you reach the TV input in the main picture.
AUDIO 	Press to alternate sound between the main picture and the window picture.
CH 	<b>To change the main picture:</b> Press  (FUNCTION), then press  or <b>To change the window picture:</b> Press  (FUNCTION), then press  or .
POSITION 	Press to move the location of the window picture.
FREEZE 	Press to freeze the window picture. Press again to restore the picture.
SWAP 	Press to swap the audio and video of the main picture with the window picture.

## Dual Tuner PIP

### KV-27S66, 27V66 only

These models are equipped with dual tuners. This means that PIP is "ready to use."

PIP 	Press to display and change the size of the window picture.
TV/VIDEO 	Press repeatedly to cycle through available video inputs.
AUDIO 	Press to alternate sound between the main picture and the window picture.
TV/VTR +  CH - 	Press to change the channel in the window picture.
POSITION 	Press to move the location of the window picture.
FREEZE 	Press to freeze the window picture. Press again to restore the picture.
SWAP 	Press to swap the main picture with the window picture.

 The AUX input cannot be viewed in the window picture.

## Quick Start to the Menus

The following settings are available in your on-screen menus:

### Menu

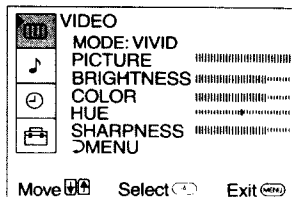

Make adjustments to your picture settings.

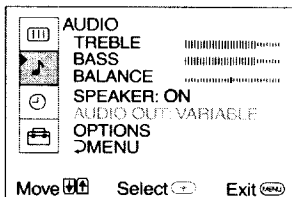

Change your audio settings.

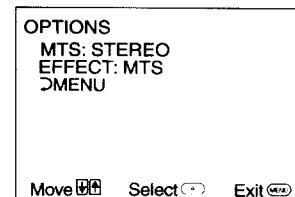

The OPTIONS menu offers customized audio features.

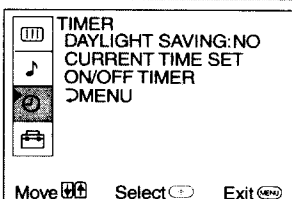

Set the clock on your TV, (CURRENT TIME SET) and program scheduled viewing using the ON/OFF TIMER.

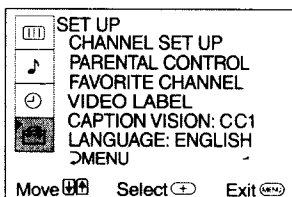

Program your channels, set TV rating, or select menu language.

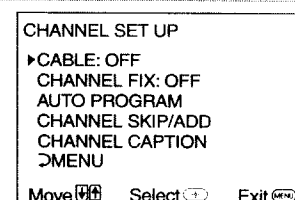





The CHANNEL SET UP menu provides further options for setting up your channels.

 The menus shown are for KV-27S46. Your menus may not look like those illustrated.

# Using the Menus

This chapter shows the options available for setting up and adjusting your TV.



## To access a menu

- 1 Press .
- 2 Use the  or  buttons to highlight an option.
- 3 Press  to access the menu.

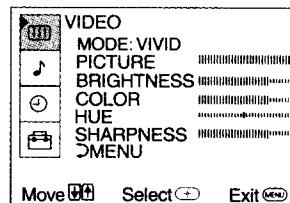
## Using the VIDEO menu



**MODE:** *Custom picture settings*  
**VIVID:** Select for enhanced picture and contrast.  
**STANDARD:** Select for a standard picture.  
**MOVIE:** Select for a darker picture for movie viewing.

Item	Press  to	Press  to
<b>PICTURE</b>	Decrease picture contrast	Increase picture contrast
<b>BRIGHTNESS</b>	Darken the picture	Brighten the picture
<b>COLOR</b>	Decrease color intensity	Increase color saturation
<b>HUE</b>	Increase the red tones	Increase the green tones
<b>SHARPNESS</b>	Soften the picture	Sharpen the picture

## Using the AUDIO 🎵 menu

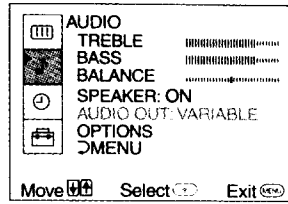

<b>TREBLE</b>	Adjust left or right to adjust higher pitched sound.
<b>BASS</b>	Adjust left or right to adjust low pitched sound.
<b>BALANCE</b>	Adjust left or right to emphasize speaker balance.
<b>AUTO VOLUME</b> <i>Stabilizes volume</i>	<b>(KV-27V42, 27V66 only)</b> <b>ON:</b> Select to stabilize the volume when changing channels. <b>OFF:</b> Select to turn AUTO VOLUME off.
<b>SPEAKER</b> <i>Custom selection of audio output source</i>	<b>ON:</b> Select to listen to the sound from the TV speakers with or without a separate stereo system. <b>OFF:</b> Select to turn off the TV speakers and listen to the TV's sound only through external audio system speakers.
<b>AUDIO OUT</b>	AUDIO OUT can only be set when SPEAKER is set to OFF. <b>VARIABLE:</b> Adjust the volume through your TV. <b>FIXED:</b> Adjust the TV volume through a connected stereo.

➤ Press  for a direct selection of available AUDIO settings.

## OPTIONS menu

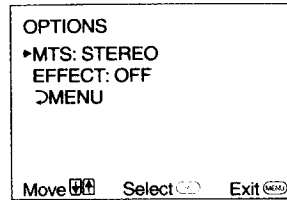

### MTS

*Multi-Channel  
TV Sound*

**STEREO:** Select when viewing a broadcast in stereo.

**SAP:** Listen to bilingual broadcast or other Second Audio Programs (SAP).

**MONO:** Select to reduce noise in areas of poor reception.

### EFFECT



*Custom audio  
settings*

**SRS:** Produces a dynamic three dimensional sound for stereo audio signals, (KV-27V42, 27V66 only).

**SURROUND:** Simulates theater quality sound for stereo programs, (KV-27S42, 27S46, 27S66 only).

**SIMULATED:** Add a surround-like effect to mono programs, (KV-27V42, 27V66 only).

 If your TV is set to SAP, all non-SAP programs will be muted. If your TV does not have sound, check your AUDIO settings.

 For direct MTS settings, press the  button on your remote control.

## Using the TIMER ⌚ menu

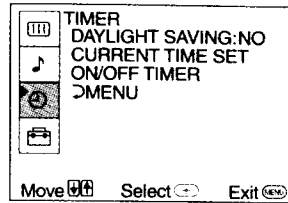

### DAYLIGHT SAVING

**YES:** Select in spring to compensate for Daylight Savings.  
**NO:** Select in fall at the end of Daylight Savings.

### CURRENT TIME SET

With the menu open:

- 1 Press  $\rightarrow$ .
- 2 Press  $\uparrow$  or  $\downarrow$  to cycle through the days, then press  $\rightarrow$ .
- 3 Press  $\uparrow$  or  $\downarrow$  until the current hour is displayed, then press  $\rightarrow$ .
- 4 Press  $\uparrow$  or  $\downarrow$  until the current minute is displayed, then press  $\rightarrow$ .

### ON/OFF TIMER

*Scheduled viewing*

CURRENT TIME SET must be programmed before the ON/OFF TIMER menu is available.

With the menu open:

- 1 Press  $\rightarrow$ .
- 2 Press  $\uparrow$  or  $\downarrow$  until the desired day or range of days is displayed, then press  $\rightarrow$ .
- 3 Indicate the time that you want the TV to turn on by pressing  $\uparrow$  or  $\downarrow$  and the  $\rightarrow$ , (for hour and minutes).
- 4 Press  $\uparrow$  or  $\downarrow$  to set the duration, up to 6 hours, then press  $\rightarrow$ .
- 5 Press  $\uparrow$  or  $\downarrow$  to set the channel and press  $\rightarrow$ .

When you perform AUTO PROGRAM, all ON/OFF TIMER settings will be cleared.

Any loss of power will cause the ON/OFF TIMER settings to be cleared.

## Using the SET UP menu

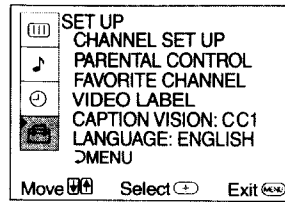

### PARENTAL CONTROL

The PARENTAL CONTROL feature provides parents several options for programming the TV to block shows based on their rating, (see page 25).

### FAVORITE CHANNEL

*Quick access to favorite channels*

With the FAVORITE CHANNEL menu open:

- 1 Use the  $\uparrow$  or  $\downarrow$  buttons to select AUTO or MANUAL, (selecting AUTO will display the last five channels accessed by the  $\text{0}$ - $\text{9}$  buttons).
- 2 Select the position (1-5) where you want to program a channel.
- 3 Using the  $\uparrow$  or  $\downarrow$  buttons, select the desired channel.
- 4 Press  $\text{ENTER}$ , the TV will change to the channel entered.

 To use FAVORITE CHANNEL: Exit all menus and press  $\text{ENTER}$ . Press  $\downarrow$  or  $\uparrow$  to move the cursor to the desired channel number and press  $\text{ENTER}$ . (For KV-27S66, 27V66, you can preview your channels by setting PREVIEW to ON).

### VIDEO LABEL

*Label connected equipment*

With the VIDEO LABEL window open:

- 1 Press  $\uparrow$  or  $\downarrow$  to access the input you want to label and press  $\text{ENTER}$ .
- 2 Press  $\uparrow$  or  $\downarrow$  to choose a label and press  $\text{ENTER}$ .

### CAPTION VISION

*Closed-Captioning*

**CC1, 2, 3, 4:** Displays printed dialogue of a program.  
**TEXT1, 2, 3, 4:** Displays network/station information.  
**XDS (Extended Data Services):** Displays information about the network and current program, if available.

 Press the  button to activate your CAPTION VISION setting.

### LANGUAGE

Display all menus in your language of choice.

- 1 Point cursor at LANGUAGE and press  $\text{ENTER}$ .
- 2 Using the  $\uparrow$  or  $\downarrow$  buttons, highlight desired language and press  $\text{ENTER}$ .

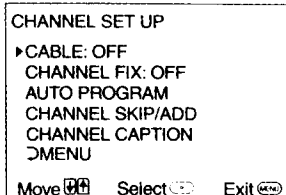

**CHANNEL SET UP menu**

**CABLE**      **ON:** Select if you are receiving cable channels with a CATV cable.  
**OFF:** Select if you are using an antenna.

After changing your CABLE settings, you will need to run AUTO PROGRAM.

**CHANNEL FIX**    **2-6:** Select when you want to control all channel selection through a cable box.  
**AUX:** When a cable box is connected to AUX and a cable/antenna is connected to VHF/UHF, (KV-27S66, 27V66 only).  
**VIDEO:** Select from available video inputs when you have connected video equipment, (e.g. satellite receiver) and you want your TV fixed to it.

FAVORITE CHANNEL cannot be used when CHANNEL FIX is set.

**AUTO PROGRAM**    Run AUTO PROGRAM whenever setting up your TV. It will cycle through all available channels and program any receivable channels.

**CHANNEL SKIP/ADD**    Use this feature after you run AUTO PROGRAM to skip unwanted channels or add new ones.  
**1** Use the  $\uparrow$  or  $\downarrow$  buttons to access the desired channel.  
**2** Press  $\rightarrow$  to SKIP or ADD, (only one option will be available).

**CHANNEL CAPTION**    With the CHANNEL CAPTION window open:  
**1** Press  $\rightarrow$ , then press  $\uparrow$  or  $\downarrow$  until you reach the desired channel number.  
**2** Press  $\rightarrow$  to activate the channel.  
**3** Press  $\uparrow$  or  $\downarrow$  to display the first call letter or number of the caption and press  $\rightarrow$  to select it.

## Using PARENTAL CONTROL

The PARENTAL CONTROL feature is designed to help parents monitor what their children watch on television. This section shows you the different rating systems available and how to set your TV's rating.

### Overview of the Ratings

Once you have become familiar with these rating systems, you should be ready to set your TV's rating.

### TV RATINGS

The TV ratings are divided into two groups: age-based and content-based.

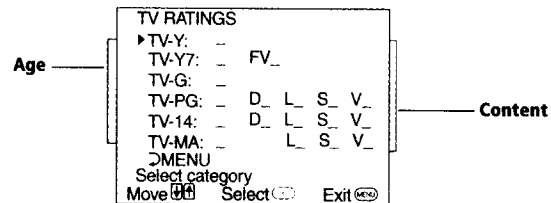

Age	Defined as
TV-Y	All children
TV-Y7	Directed to older children
TV-G	General audience
TV-PG	Parental Guidance suggested
TV-14	Parents Strongly cautioned
TV-MA	Mature Audience only

Contents	Defined as
FV	Fantasy Violence
D	Suggestive dialogue
L	Strong language
S	Sexual situations
V	Violence

 The content ratings will increase depending on the level of the age-based rating. For example, a program with a TV-PG V (Violence) rating may contain moderate violence, while a TV-14 V (Violence) rating may contain intense violence.

## MOVIE RATINGS

### (U.S. models only)

This system defines the rating levels of movies shown on the big screen and those on prime cable channels.

Rating	Defined as
<b>G</b>	General audience
<b>PG</b>	Parental Guidance suggested
<b>PG-13</b>	Parents strongly cautioned
<b>R</b>	Restricted
<b>NC-17</b>	No one 17 and under admitted
<b>X</b>	No one 17 and under admitted

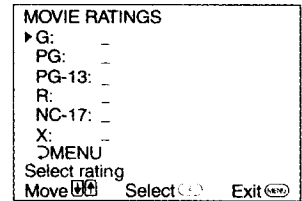

## UNRATED

### (U.S. models only)

You have the option of blocking TV programs or movies that are not rated.

<b>VIEW ALL</b>	Allows all unrated programs
<b>BLOCK TV</b>	Block all unrated TV programs
<b>BLOCK MOVIE</b>	Block all unrated movies
<b>BLOCK ALL</b>	Block all unrated programming

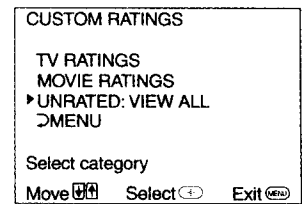

**!** If you choose to block unrated TV programs, please be aware that the following programs may be blocked: emergency broadcasts, political programs, sports, news, public service announcements, religious programs and weather.

**ENGLISH RATINGS****(Canadian models only)**

These ratings are for Canadian programs that are broadcast in English.

Rating	Defined as
<b>C</b>	Children
<b>C8+</b>	Children 8 years and older
<b>G</b>	General programming
<b>PG</b>	Parental Guidance
<b>14+</b>	Viewers 14 and older
<b>18+</b>	Adult programming

ENGLISH RATINGS	
▶ C:	-
C8+:	-
G:	-
PG:	-
14+:	-
18+:	-
◀MENU	
Select rating	
Move	[Left] [Right]
Select	[Enter]
Exit	[Esc]

**FRENCH RATINGS****(Canadian models only)**

These ratings are for Canadian programs that are broadcast in French.



Rating	Defined as
<b>C</b>	General
<b>8 ans+</b>	Not recommended for younger children
<b>13 ans+</b>	Not recommended for children under age 13
<b>16 ans+</b>	Not recommended for ages under 16
<b>18 ans+</b>	This program is restricted to adults

FRENCH RATINGS	
▶ G:	-
8 ans+:	-
13 ans+:	-
16 ans+:	-
18 ans+:	-
◀MENU	
Select rating	
Move	[Left] [Right]
Select	[Enter]
Exit	[Esc]

**U.S.A. RATINGS****(Canadian models only)**

For programs from the United States. Please see, "TV RATINGS" on page 25 for information on U.S.A. RATINGS.

**Initial access into PARENTAL CONTROL**

- 1 In the SET UP  menu, point the cursor to PARENTAL CONTROL and press , (you will be asked to set a 4-digit password for any future access into PARENTAL CONTROL).

- Press  $\leftarrow$ , then use the  $\text{0}$ - $\text{9}$  buttons to enter a 4-digit password.

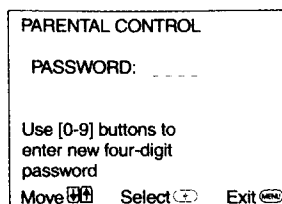

- Keep this instruction manual in a safe place. In the event that you forget your password, please see page 35.

- Confirm your password by entering it again.

Once your password is set correctly, you will be taken into the PARENTAL CONTROL menu.

### Activating PARENTAL LOCK

In order to change the RATING, you will need to set PARENTAL LOCK to ON.

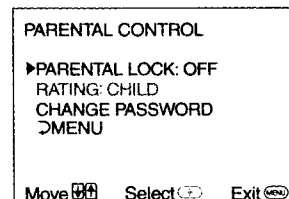

- Point the cursor to PARENTAL LOCK and press  $\leftarrow$ .
- Using the  $\uparrow$  or  $\downarrow$  buttons, highlight ON and press  $\leftarrow$  to activate.

### Setting the RATING

If you are not familiar with the Parental Guidelines rating system, you should use one of the following preselected categories to simplify the rating selections: CHILD, YOUTH or YOUNG ADULT.

- Point the cursor to RATING and press  $\leftarrow$ .

- 2** Using the  $\uparrow$  or  $\downarrow$  buttons, select the desired rating and press  $\rightarrow$ .

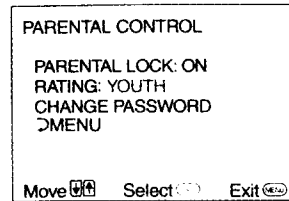

Rating	TV will allow a maximum rating of:
CHILD	TV-Y, TV-G, G (U.S. models only), G (Canadian models only)
YOUTH	TV-PG, PG (U.S. models only), PG (Canadian models only)
YOUNG ADULT	TV-14, PG-13 (U.S. models only), 14+ (Canadian models only)
CUSTOM	Select to set more restrictive ratings. (see next section)

### Using the CUSTOM menu

You should be familiar with the rating systems before attempting to set CUSTOM ratings. Refer to pages 25-26, "Overview of the Ratings," for a description of the available rating systems.

- 1** In the RATING option, use  $\uparrow$  or  $\downarrow$  to highlight CUSTOM and press  $\rightarrow$ .
- 2** Using the  $\uparrow$  or  $\downarrow$  buttons, select the desired rating category and press  $\rightarrow$ .
- 3** Use  $\uparrow$  or  $\downarrow$  to select the maximum rating or content and press  $\rightarrow$ .
- 4** Press  $\uparrow$  or  $\downarrow$  to block (🔒) or unblock ( ) the rating or content and press  $\rightarrow$ .

 Once you have blocked a rating or content, all higher ratings or contents will be automatically blocked.

## Resetting your password

- 1 Use the  $\uparrow$  or  $\downarrow$  buttons to move the cursor to CHANGE PASSWORD and press  $\text{ENTER}$ .
- 2 Follow the directions for, "Initial Access into Parental Control," on pages 27-28 for information on changing your password.

## Information for Parents







### To view a program that exceeds the TV rating

- Press  $\text{ENTER}$  on the remote control, then use the  $\text{0}$ - $\text{9}$  buttons to enter your password.
-  Entering your password to view a blocked program will temporarily turn PARENTAL LOCK to OFF. To reactivate your PARENTAL LOCK settings, turn the TV off then back on; the TV will return to the settings that you have selected.

# Other Information

## Programming the Remote Control

You can use the supplied remote control to operate Sony or non-Sony video equipment.

- 1 Press .
- 2 Press  or .
- 3 Use the - buttons to key in the code number from the following chart.
- 4 Press .

### VCR codes

Sony	301, 302, 303	JC Penney	309, 305, 304, 330, 314, 336, 337
Admiral (M.Ward)	327	JVC	314, 336, 337, 345, 346, 347
Aiwa	338, 344	Kenwood	314, 336, 332, 337
Audio Dynamic	314, 337	LXI (Sears)	332, 305, 330, 335, 338
Broksonic	319, 317	Magnavox	308, 309, 310
Canon	309, 308	Marantz	314, 336, 337
Citizen	332	Marta	332
Craig	302, 332	Memorex	309, 335
Criterion	315	Minolta	305, 304
Curtis Mathis	304, 338, 309	Mitsubishi/MGA	323, 324, 325, 326
Daewoo	341, 312, 309	Multitech	325, 338, 321
DBX	314, 336, 337	NEC	314, 336, 337
Dimensia	304	Olympic	309, 308
Emerson	319, 320, 316, 317, 318, 341	Optimus	327
Fisher	330, 335	Panasonic	308, 309, 306, 307
Funai	338	Pentax	305, 304
General Electric	329, 304, 309	Philco	308, 309
Go Video	322, 339, 340	Philips	308, 309, 310
Goldstar	332	Pioneer	308
Hitachi	306, 304, 305, 338	Quasar	308, 309, 306
Instant Replay	309, 308	RCA/PROSCAN	304, 305, 308, 309, 311, 312, 313, 310, 329



Realistic	309, 330, 328, 335, 324, 338
Sansui	314
Samsung	322, 313, 321
Sanyo	330, 335
Scott	312, 313, 321, 335, 323, 324, 325, 326
Sharp	327, 328
Shintom	315
Signature 2000 (M.Ward)	338, 327
SV2000	338
Sylvania	308, 309, 338, 310

Symphonic	338
Tashiro	332
Tatung	314, 336, 337
Teac	314, 336, 338, 337
Technics	309, 308
Toshiba	312, 311
Wards	327, 328, 335, 331, 332
Yamaha	314, 330, 336, 337
Zenith	331

**Cable box codes**

Hamlin/Regal	222, 223, 224, 225, 226
Jerrold/G. I.	201, 202, 203, 204, 205, 206, 207, 208, 218
Oak	227, 228, 229
Panasonic	219, 220, 221
Pioneer	214, 215
Scientific Atlanta	209, 210, 211
Tocom	216, 217
Zenith	212, 213

**Satellite receiver codes**

Sony	801 (preset code for remote control)
General Electric	802
Hitachi	805
Hughes	804
Panasonic	803
RCA/PROSCAN	802, 808
Toshiba	806, 807

**Laser Disc Player codes**

Sony	701
Panasonic	704, 710
Pioneer	702

**DVD codes**









Sony	751
Panasonic	753
Pioneer	752
RCA	755
Toshiba	754

 If more than one code number is listed, try entering them one by one until you come to the correct code for your equipment.



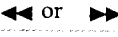





 Whenever you remove the batteries the code numbers may revert to the factory setting and must be reset.

 In some rare cases, you may not be able to operate your equipment with the supplied remote control. In this case, use the equipment's supplied remote control.



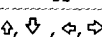

### Operating a VCR

Press	To
	Power on the VCR
	Select channels directly
	Change channels
	Play video tape
	Stop
	Search forward or backward
	Pause
	Record
at the same time	
	Change between VCR and TV inputs

### Operating a DVD

Press	To
	Power on the DVD
	Select chapters directly
	Search chapters forward or backward
	Play DVD
	Stop
	Pause
	Move the cursor in the menu
	Display the DVD menu

### Operating a Laser Disc

Press	To
	Power on the laser disc
	Search chapters forward or backward
	Play disc
	Stop
	Pause

## Troubleshooting

If you are having a problem with your TV, try the suggestions below. If the problem persists, contact your nearest Sony dealer.

<b>Cannot operate single tuner PIP (KV-27S46)</b>	<ul style="list-style-type: none"> <li><input type="checkbox"/> Make sure the VCR is connected correctly (see page 4).</li> <li><input type="checkbox"/> Check to see if the VCR is on.</li> <li><input type="checkbox"/> Make sure your remote control is programmed to operate your VCR (see page 31).</li> </ul>
<b>No picture, no sound</b>	<ul style="list-style-type: none"> <li><input type="checkbox"/> Make sure the power cord is plugged in.</li> <li><input type="checkbox"/> If a red light is flashing on the front of your TV for more than a few minutes, call your local service center.</li> <li><input type="checkbox"/> Check the TV/VIDEO settings: when watching TV, set to TV; when watching video equipment, set to VIDEO (page 19).</li> <li><input type="checkbox"/> Make sure the batteries have been inserted correctly into the remote control.</li> <li><input type="checkbox"/> Check your PARENTAL CONTROL settings (pages 28-29).</li> <li><input type="checkbox"/> Try another channel, it could be station trouble.</li> </ul>
<b>Poor or no picture, good sound</b>	<ul style="list-style-type: none"> <li><input type="checkbox"/> Adjust PICTURE in the VIDEO menu (page 19).</li> <li><input type="checkbox"/> Adjust BRIGHTNESS in the VIDEO menu (page 19).</li> <li><input type="checkbox"/> Check the antenna and/or cable connections (page 3).</li> </ul>
<b>Good picture, no sound</b>	<ul style="list-style-type: none"> <li><input type="checkbox"/> Press <b>MUTING</b> so that MUTING disappears from the screen (page 13).</li> <li><input type="checkbox"/> Check your AUDIO settings. Your TV may be set to SAP (page 21).</li> </ul>
<b>No color</b>	<ul style="list-style-type: none"> <li><input type="checkbox"/> Adjust COLOR in the VIDEO menu (page 19).</li> </ul>
<b>Only snow appears on the screen</b>	<ul style="list-style-type: none"> <li><input type="checkbox"/> Check the CABLE setting in the CHANNEL SET UP menu (page 24).</li> <li><input type="checkbox"/> Check the antenna and/or cable connections (page 3).</li> <li><input type="checkbox"/> Make sure the channel selected is currently broadcasting.</li> <li><input type="checkbox"/> Press the <b>ANT</b> button on the remote control.</li> </ul>

- |  |  |
|--|--|
| <b>Dotted lines or stripes</b>   | <input type="checkbox"/> Adjust the antenna.   |
|  | <input type="checkbox"/> Move the TV away from other electronic equipment. Some electronic equipment can create electrical noise, which can interfere with TV reception.   |
| <b>Double images or ghosts</b>   | <input type="checkbox"/> Check your outdoor antenna or call your cable service.  |
| <b>Cannot receive higher number channels (UHF) when using an antenna</b> | <input type="checkbox"/> Make sure CABLE is set to OFF in the CHANNEL SET UP menu (page 24).   |
|  | <input type="checkbox"/> Use AUTO PROGRAM to add channels that are not presently in the memory (page 24).  |
| <b>Cable stations don't seem to work</b>                                 | <input type="checkbox"/> Make sure CABLE is set to ON in the CHANNEL SET UP menu (page 24).  |
|  | <input type="checkbox"/> Use AUTO PROGRAM to add channels that are not presently in the memory (page 24).  |
| <b>Remote Control does not operate</b>                                   | <input type="checkbox"/> Batteries could be weak. Replace them (page 2).   |
|  | <input type="checkbox"/> Move the TV 3-4 feet away from fluorescent lights.  |
| <b>The TV needs to be cleaned</b>  | <input type="checkbox"/> Clean the TV with a soft dry cloth. Never use strong solvents such as thinner or benzine, which might damage the finish of the cabinet.   |
| <b>Lost password for PARENTAL CONTROL</b>                                | <input type="checkbox"/> In the password screen, enter the following master password: 4357. After using the master password, you must create a new password, it cannot be used to unlock currently blocked channels. |

*If, after reading these operating instructions, you have additional questions related to the use of your Sony television, please call our Direct Response Center at 1-800-222-SONY (7669) (U.S. residents only) or (416) 499-SONY (7669) (Canadian residents only).*

## Specifications

### For all models (except as noted)

Television system	American TV standard/NTSC
Channel coverage	VHF: 2-13/UHF: 14-69/CATV: 1-125
Antenna	75-ohms external antenna terminal for VHF/UHF
Picture tube	Trinitron® tube
Power requirements	120 V, 60 Hz
Supplied Accessories	Size AA (R6) batteries (2) Remote Control RM-Y165 (1) (KV-27S42, 27V42) Remote Control RM-Y167 (1) (KV-27S46, 27S66, 27V66)
Optional Accessories	Antenna dipole Connecting cables: VMC-810S/820S, VMC-720M, YC-15V/30V, RK-74A TV Stand: SU-27A4 U/V mixer: EAC-66

### KV-27S42, 27S46, 27S66

Screen size	Visible screen size: 27 inch picture measured diagonally Actual screen size: 29 inch picture measured diagonally
Inputs/outputs	1 video, 1 audio (KV-27S42) 2 video, 2 audio 1 S VIDEO 1 AUDIO OUT
Speaker output	5 W x 2
Power Consumption	140 W in use 150 W in use (KV-27S66) 2 W in standby
Dimensions (W/H/D)	660.4 x 598 x 505.5 mm (26 x 23 <sup>9</sup> / <sub>16</sub> x 20 in.)
Mass	39 kg (86 lbs.)

### KV-27V42, 27V66

Screen size	Visible screen size: 27 inch picture measured diagonally Actual screen size: 29 inch picture measured diagonally
Inputs/outputs	3 video, 3 audio 1 S VIDEO (KV-27V42) 2 S VIDEO (KV-27V66) 1 MONITOR OUT 1 AUDIO OUT
Speaker output	5 W x 2 (KV-27V42) 10 W x 2 (KV-27V66)
Power Consumption	140 W in use (KV-27V42) 180 W in use (KV-27V66) 2 W in standby
Dimensions (W/H/D)	690 x 575.4 x 503.4 mm (27 <sup>1</sup> / <sub>4</sub> x 22 <sup>3</sup> / <sub>4</sub> x 19 <sup>7</sup> / <sub>8</sub> in.)
Mass	42.4 kg (93 lbs. 8 oz)

Design and specifications are subject to change without notice.

# Index

## A

AUDIO 🎵 menu 20  
 AUTO PROGRAM 24  
 AUTO VOLUME CONTROL 20

## B

Battery Installation 2  
 BRIGHTNESS 19

## C

CAPTION VISION 23  
 CHANNEL CAPTION 24  
 CHANNEL FIX 24  
 CHANGE PASSWORD 30  
 CHANNEL SET UP 24  
 CHANNEL SKIP/ADD 24  
 COLOR 19

### Code numbers

Cable box 32  
 Digital Satellite Receiver 32  
 DVD 32  
 Laser Disc 32  
 VCR 31

### Connections

Cable and antenna 3  
 Connecting a Camcorder 10  
 Connecting a DVD player 10  
 Connecting an audio system 11  
 Connecting two VCR's for Tape Editing 12  
 TV and Cable Box 5  
 TV and Digital Satellite Receiver 8  
 TV and Digital Satellite Receiver and VCR 9  
 TV, Cable box and Cable 6  
 TV and VCR 4  
 TV, VCR, and Cable box 7  
 CURRENT TIME SET 22

## D

DAYLIGHT SAVING 22

## E

ENGLISH RATINGS 27

## F

FAVORITE CHANNEL 1, 23  
 FRENCH RATINGS 27

## H

HUE 19

## L

LANGUAGE 23

## M

### Menus

AUDIO 🎵 20  
 SET UP 23  
 TIMER ⌚ 22  
 VIDEO 📺 19  
 MOVIE RATING 26  
 MTS 21  
 MONO 21  
 SAP 21  
 STEREO 21

## O

ON/OFF TIMER 1, 22

## P

PARENTAL CONTROL 1, 25  
 Password  
 Entering 30  
 Lost 35  
 PICTURE 19  
 PIP (Picture in Picture)  
 Single Tuner (KV-27S46) 16  
 Dual Tuner (KV-27S66, KV-27V66) 17

## R

RATINGS  
 ENGLISH 27  
 FRENCH 27  
 MOVIE 26  
 TV 25

- UNRATED 26
- U.S.A. 27
- Remote Control 13
- S**
- SET UP menu 23
- SHARPNESS 19
- SIMULATED 21
- SRS 21
- Specifications 36
- SURROUND 21
- T**
- TIMER menu 22
- Troubleshooting 34
- TV Features 1
- TV RATING 25
- U**
- U.S.A. RATINGS 27
- UNRATED 26
- V**
- VIDEO menu 19
- VIDEO MODE 19
- VIVID 19
- STANDARD 19
- MOVIE 19
- VIDEO LABEL 23