

Canon

PowerShot S100
DIGITAL ELPH

DIGITAL
IXUS

Camera User Guide

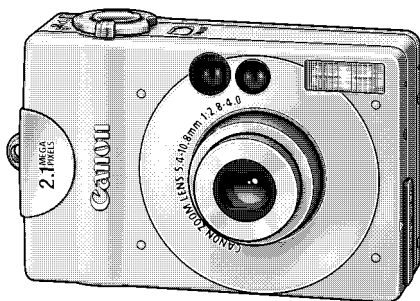

This camera has three basic functions:

Shooting

▶ Replaying

▶ Downloading Images to a Computer

This guide explains the shooting and replay functions.

The downloading function is covered separately in the Software Starter Guide.

- Please read the precautions on the next page before using your camera for the first time.



ENGLISH

Precautions

Camera Body Temperature

If your camera is used for prolonged periods, the camera body may become warm. Please be aware of this and take care when operating the camera for an extended period.

About the LCD monitor

The LCD monitor is produced with extremely high-precision manufacturing techniques. With more than 99.99% of the pixels operating to specifications, less than 0.01% of the pixels may occasionally misfire or appear as black, red or green dots. This has no effect on the recorded image and does not constitute a malfunction.

Notice: Please ensure that you read and follow the handling and safety precautions on pages 4 to 8 of this guide before attempting to use the camera.

Disclaimer

- While every effort has been made to ensure that the information contained in this guide is accurate and complete, no liability can be accepted for any errors or omissions. Canon Inc. reserves the right to change the specifications of the hardware and software described herein at any time without prior notice.
- No part of this guide may be reproduced, transmitted, transcribed, stored in a retrieval system, or translated into any language in any form, by any means, without the prior written permission of Canon Inc.
- Canon Inc. makes no warranties for damages resulting from corrupted or lost data due to a mistaken operation or malfunction of the camera, the software, the CompactFlash™ cards (CF cards), personal computers, peripheral devices, or use of non-Canon CF cards.

Trademark Acknowledgments

- Canon is a trademark of Canon Inc.
- CompactFlash is a trademark of SanDisk Corporation.
- Other names and products not mentioned above may be registered trademarks or trademarks of their respective companies.

Table of Contents

Read This First

Please Read	4
Safety Precautions	4
Warnings	5
Cautions	7
Preventing Malfunctions	8

Preparing the Camera

Guide to Components	9
Front View	9
Back View	10
Operation Panel	11
Charging the Battery Pack	12
Installing the Battery Pack	14
Using the AC Adapter (Optional)	16
Installing a CF Card	17
Attaching the Wrist Strap	18
Setting the Date and Time	19

Quick Start

Shooting	20
Replaying	21

Basic Functions

Turning the Power On/Off	22
Switching between the Shooting/Replay Modes	23
Using the Optical Viewfinder	23
Using the LCD Monitor	25
Shooting Mode	25
Replay Mode	26
Information Displayed on the LCD Monitor	26
Shooting Mode	26
Replay Mode	27
LCD Monitor Menus/Switching between Display Modes ..	28
Shooting Mode	28
Replay Mode	28
Pressing the Shutter Button	30
Using the Zoom	31
Telephoto/Wide Angle	31
Digital Zoom	32

Shooting

Selecting a Shooting Mode	33
Functions Available in Each Shooting Mode	34
Adjusting the Image Quality	35
Using the Flash	36
Using the Self-Timer	37
Shooting Continuously	38
Shooting Close-Ups/Infinity Shots	39
Adjusting the Exposure Compensation	40
Setting the White Balance	41
Shooting in Stitch Assist Mode	42
Framing a Subject	42
Shooting	43
Shooting/Replaying with a TV Monitor	45

Replaying/Erasing

Displaying Images Singly (Single Image Replay)	46
Zooming an Image	46
Displaying Images in Sets of Nine (Multi Image Replay) .	47
Switching between Sets of Nine Images	47
Rotating Images in the Display	48
Automating Playback (Auto Play)	49
Protecting Images	51
Print Settings (DPOF Settings)	52
Displaying the Print Settings Menu	52
Setting the Print Style	53
Selecting Images for Printing	54
Resetting Print Settings	56
Erasing Images	57
Erasing Images Singly	57
Erasing All Images	58

Camera Settings

Displaying the Setup Menu	59
Switching the Digital Zoom On/Off	60
Resetting the File Number	61
Saving the Shooting Mode Setting	62
Switching the Beep On/Off	63
Switching the AtuoPower Down Function On/Off	64
Formatting CF Cards	65
Setting the Language	66

Appendices

Care and Maintenance of the Camera	67
Troubleshooting	68
List of Messages	72
Specifications	74
Index	76
Canon Customer Support Help Desk	78

Read This First

Please Read

Test Shots

Before you shoot images of subjects of importance to you, we strongly recommend that you shoot several trial images to confirm that you are operating the camera correctly. Please note that Canon Inc., its subsidiaries and affiliates, and distributors of its digital cameras are not liable for any consequential damages arising from any malfunction of the Canon digital camera or CompactFlash™ card (CF card) resulting in the failure of an image to be recorded or to be recorded in a format that is machine sensible.

Warning Against Copyright Infringement

Please note that Canon digital cameras are intended for personal use and must be used in a manner that respects international and domestic copyright laws and regulations. Please be advised that in certain cases the copying of images from performances, exhibitions, or commercial properties by means of a camera or other device may contravene copyright or other legal rights even if the image was recorded for personal use.

Use of the Equipment in a Foreign Country

This camera is manufactured according to the specifications of the country in which it is sold and the warranty is only effective in the country of sale. If a problem arises while the camera is in use abroad, please convey it back to the country of sale before proceeding with a warranty claim to a Canon Customer Support Help Desk.

Safety Precautions

- Before using the camera, please ensure that you have read and understood the safety precautions described below. Always ensure that the camera is operated correctly.
- The safety precautions noted on the following pages are intended to instruct you in the safe and correct operation of the camera and its accessories to prevent injuries or damage to yourself, other persons and equipment.
- In the next few pages, the term “equipment” refers primarily to the camera and its power supply accessories.

⚠ WARNINGS

- Do not aim the camera directly into the sun or at other intense light sources which could damage your eyesight.

- Do not trigger the flash in close proximity to human or animal eyes. Exposure to the intense light produced by the flash may damage eyesight. In particular, remain at least one meter (39 inches) away from infants when using the flash.

- Store this equipment out of the reach of children and infants. Accidental damage to the camera or batteries by a child could result in serious injury. In addition, placement of the wrist strap around the child's neck could result in asphyxiation.

- Do not attempt to disassemble or alter any part of the equipment that is not expressly described in this guide. Disassembly or alteration may result in high-voltage electrical shock. Internal inspections, alterations and repairs should be conducted by qualified service personnel authorized by your camera distributor or a Canon Customer Support Help Desk.

- To avoid the risk of high-voltage electrical shock, do not touch the flash portion of the camera if it has been damaged. Similarly, never touch internal portions of the equipment which become exposed as a result of damage. There is a risk of high-voltage electrical shock. Please take the first opportunity to consult your camera distributor or a Canon Customer Support Help Desk.

- Stop operating the equipment immediately in the event that it emits smoke or noxious fumes. Failure to do so may result in fire or electrical shock. Immediately turn the camera's power off and remove the camera battery or unplug the power cord from the electrical outlet. Confirm that smoke or fume emissions have ceased. Please consult your camera distributor or the closest Canon Customer Support Help Desk.

- Stop operating the equipment if it is dropped or the casing is damaged. Failure to do so may result in fire or electrical shock. Immediately turn the camera's power off and remove the camera battery or unplug the power cord from the electrical outlet. Please consult your camera distributor or the closest Canon Customer Support Help Desk.

-
- Do not allow the equipment to come into contact with, or become immersed in, water or other liquids. Do not allow liquids to enter the interior. The camera has not been waterproofed. If the exterior comes into contact with liquids or salt air, wipe it dry with a soft, absorbent cloth. In the event that water or other foreign substances enter the interior, immediately turn the camera's power off and remove the camera battery or unplug the power cord from the electrical outlet. Continued use of the equipment may result in fire or electrical shock. Please consult your camera distributor or the closest Canon Customer Support Help Desk.
-
- Do not use substances containing alcohol, benzene, thinners or other flammable substances to clean or maintain the equipment. The use of these substances may lead to fire.
-
- Do not cut, damage, alter or place heavy items on the power adapter cord. Any of these actions may cause an electrical short circuit, which may lead to fire or electrical shock. Replace a broken or damaged power adapter cord.
-
- Do not handle the power cord if your hands are wet. Handling it with wet hands may lead to electrical shock. When unplugging the cord, ensure that you hold the solid portion of the plug. Pulling on the flexible portion of the cord may damage or expose the wire and insulation, creating the potential for fires or electrical shocks.
-
- Use of power sources not expressly recommended for this equipment may lead to overheating, distortion of the equipment, fire, electrical shock or other hazards. Use only the recommended power accessories.
-
- Do not place the batteries near a heat source or expose them to direct flame or heat. Neither should you immerse them in water. Such exposure may damage the batteries and lead to the leakage of corrosive liquids, fire, electrical shock, explosion or serious injury.
-
- Do not attempt to disassemble, alter or apply heat to the batteries. There is serious risk of injury due to an explosion. Immediately flush with water any area of the body, including the eyes and mouth, or clothing, that comes into contact with the inner contents of a battery. If the eyes or mouth contact these substances, immediately flush with water and seek medical assistance.
-
- Avoid dropping or subjecting the batteries to severe impacts that could damage the casings. It could lead to leakage and injury.
-
- Do not short-circuit the battery terminals with metallic objects, such as key holders. It could lead to overheating, burns and other injuries. Use the supplied battery case to transport or store the battery pack.
-

- Before you discard a battery, cover the terminals with tape or other insulators to prevent direct contact with other objects. Contact with the metallic components of other materials in waste containers may lead to fire or explosions. Discard the batteries in specialized waste facilities if available in your area.

- Use of batteries not expressly recommended for this equipment may cause explosions or leaks, resulting in fire, injury and damage to the surroundings. Use only recommended batteries and accessories.

- Use only the recommended battery charger to charge the Battery Pack NB-1L rechargeable batteries. Use of chargers not expressly recommended may result in overheating, distortion, fire or electrical shock.

- Disconnect the battery charger or the compact power adapter from both the camera and electrical outlet after recharging and when the camera is not in use to avoid fires and other hazards.

- The camera terminal of the battery charger cord and the compact power cord is designed for exclusive use with your camera. Do not use it with other products or batteries. There is a risk of fire and other hazards.

CAUTIONS

- Avoid using, placing or storing the equipment in places subject to strong sunlight or high temperatures, such as the dashboard or trunk (boot) of a car. Exposure to intense sunlight and heat may cause the batteries to leak, overheat or explode, resulting in fire, burns or other injuries. High temperatures may also cause deformation of the casing. Ensure that there is good ventilation when using the compact power adapter to charge the battery pack or power the camera.

- Do not store the equipment in humid or dusty areas. Storage in such areas could lead to fire, electrical shock or other damage.

- Be careful not to bang the camera or subject it to strong impacts or shocks that could lead to injury or damage the equipment when wearing or holding it by the wrist strap.

- Be careful not to cover the flash with your fingers when shooting. In addition, do not touch the surface of the flash after taking several pictures in rapid succession. Either action could result in burns.

- If your camera is used for prolonged periods, the camera body may become warm. Please take care when operating the camera for an extended period as your hands may experience a burning sensation.

Preventing Malfunctions

Avoid Strong Magnetic Fields

Never place the camera in close proximity to electric motors or other equipment generating strong electromagnetic fields. Exposure to strong magnetic fields may cause malfunctions or corrupt image data.

Avoid Condensation Related Problems

Moving the equipment rapidly between hot and cold temperatures may cause condensation (water droplets) to form on its external and internal surfaces. You can avoid this by placing the equipment in an airtight, resealable plastic bag and letting it adjust to temperature changes slowly before removing it from the bag.

If Condensation Forms Inside the Camera

Stop using the camera immediately if you detect condensation. Continued use may damage the equipment. Remove the CF card and battery or power cord (if connected) from the camera and wait until the moisture evaporates completely before resuming use.

Extended Storage

When not using the camera for extended periods of time, remove the battery pack and store the equipment in a safe place. Storing the camera for extended periods with a battery pack installed will run down the battery pack and may damage the camera. Please note, however, that the date, time and other camera settings may reset to the default settings if the battery pack has been removed for approximately three weeks. Follow the instructions in this guide to reset the desired settings.

Preparing the Camera

Guide to Components

Front View

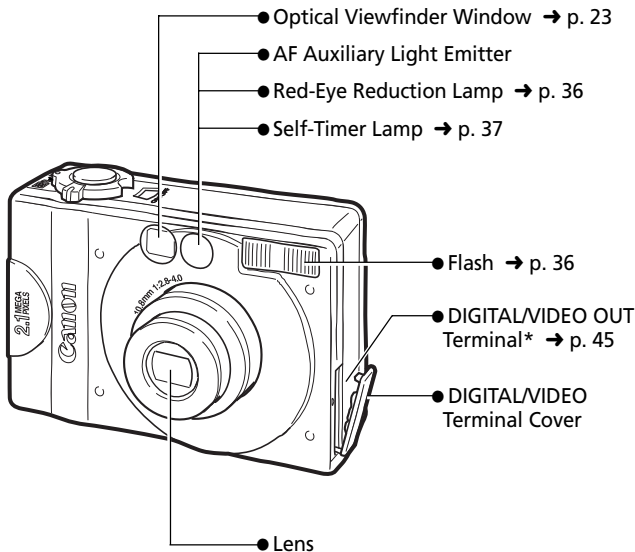

* Used to connect the camera to a TV or computer. Open the cover and use the supplied video cable to connect to a TV or use the supplied interface cable to connect to a computer.

Back View

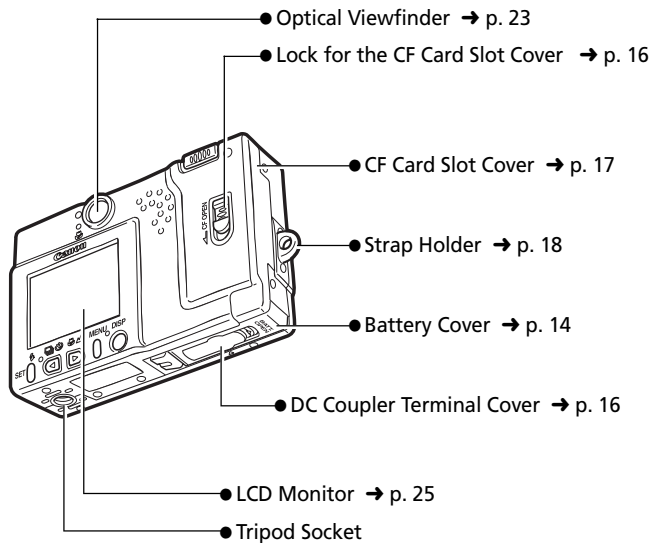

Operation Panel

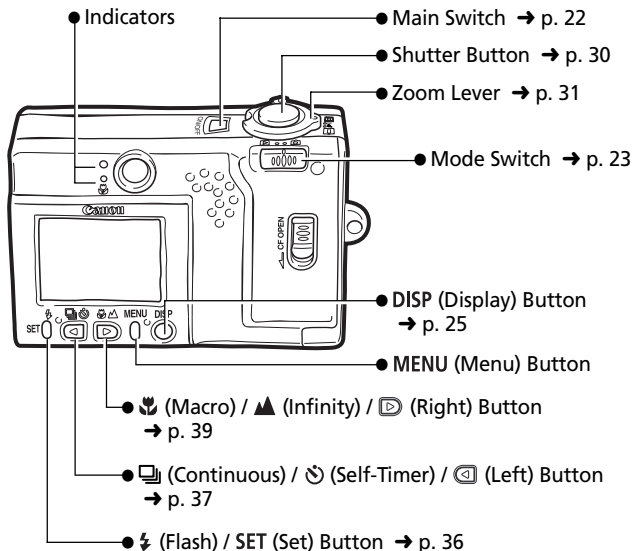

Indicators

- The indicators will light or flash when the main switch is pressed or at various stages as the shutter button is pressed.

Upper Indicator

Green:	Ready to record
Flashing Green:	During camera warm-up / Recording to CF card / Reading CF card / Deleting CF card images
Red:	Ready to record with flash
Flashing Red:	Ready to record but the camera blur warning / low light warning is flashing

Lower Indicator

Orange:	Macro mode
---------	------------

Charging the Battery Pack

Recharge the battery pack with battery charger CB-2L or CB-2LE the first time you use the camera or when the "Change the battery pack" message is displayed.

Battery charger model names and types vary by region.

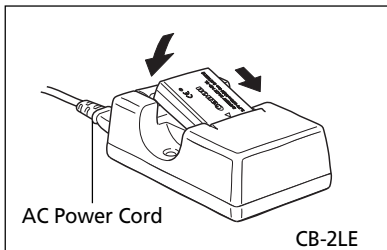
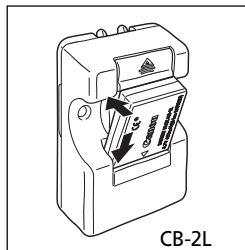

- Insert the battery pack into the charger as shown and plug the charger into an electrical outlet.
- The charging indicator will flash red while the battery pack is charging. It will change to a steady red when the charge is complete.
- After charging, unplug the battery charger and remove the battery pack from it.

- The battery pack utilizes lithium ion cells, avoiding the need to completely use or discharge the battery charge before recharging it. You may recharge the battery at any charge state without permanently reducing its capacity.
- It takes approximately 120 minutes to charge a battery pack fully from a fully discharged state. (Based on standard Canon testing conditions) Please charge it at an ambient temperature ranging between 5 and 40 °C (41 and 104 °F).
- Charge times may vary according to the ambient temperature and the charge state of the battery pack.

- To protect and prolong the life of the battery pack, do not charge it for longer than 24 hours at a time.

Handling Precautions

- Do not charge the battery pack in poorly ventilated areas.
- Do not charge batteries other than Battery Pack NB-1L in this charger.
- The battery pack continues to discharge a minimal portion of its power while installed in the camera, even with the camera power off. This will shorten battery life. To conserve the battery pack, remove it from the camera during extended periods of disuse and store it in its case in a cool, dry place. Recharge it fully before using it again.
- If the performance of the battery pack diminishes substantially even when it is fully charged, the battery pack should be replaced.

Installing the Battery Pack

Install rechargeable Battery Pack NB-1L in the camera as shown below.

- Please recharge the battery pack (→ p. 12) before you use it for the first time.

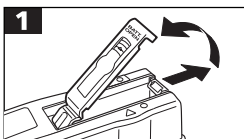

- Slide the battery cover in the direction of the arrows.

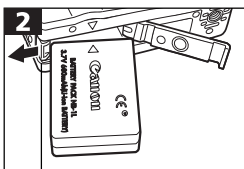

- Press the battery lock while inserting the battery pack all the way in until the lock clicks.
- To remove the battery pack, press the battery lock and pull the battery pack out.

Battery Lock

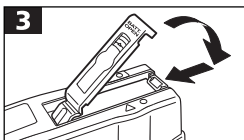

- Slide the battery cover closed.

- The camera contains a built-in rechargeable lithium battery to save the date and time settings whenever the main battery is removed. The main battery and AC adapter (optional) recharge this battery whenever the camera is powered by them. When you first purchase the camera, please leave the main battery in the camera for approximately four hours or plug in the AC adapter (optional) for that length of time. This battery will recharge even when the camera's main switch is set to Off.
- If the Set Date/Time menu displays when the main switch is turned on, the charge of the built-in lithium battery is low. Please follow the procedure in the previous paragraph to recharge it.

- Never open the battery cover or remove the battery pack when the main switch is on.
- Remove the battery pack from the camera when the camera is not in use. Please note, however, that the date, time and other camera settings may reset to the default settings if the battery pack has been removed for approximately three weeks.
- Please use the AC adapter (optional) for this camera for extended periods of use (→ p. 16).

Battery Performance

	Recordable Images		Replay Time
	LCD Monitor On	LCD Monitor Off	
Battery Pack NB-1L (fully charged)	Approx. 85 shots	Approx. 270 shots	Approx. 50 min.

- The actual performance may vary from the above data according to the shooting conditions and the shooting mode.
- At low operating temperatures, the battery performance may drop and the battery icon may appear sooner than at high temperatures. To improve performance at these temperatures, warm the battery in your pocket just before using it in the camera.





<Test Conditions>

Shooting: 23 °C (73 °F),  (Fine / Large), zoom used, flash used one in four shots

Replay: 23 °C (73 °F), continuous replay, 3 seconds per image

Battery Pack Charge

The following icons and messages will display when the charge of the battery pack is low.

	Battery pack charge is low. Recharge it as soon as possible before it is required for an extended period. When the LCD monitor is off, this icon will display when you press the  ,  or  button.
Change the battery pack	Battery charge is insufficient to operate the camera. Replace the battery pack immediately.

Using the AC Adapter (optional)

It is recommended that you use the optional Canon AC adapter Kit ACK300, which includes the Compact Power Adapter CA-PS300, the DC Coupler DR-300 and the power cord, when using the camera for extended periods of time to shoot or connect to a computer.

- Turn the camera power off before connecting or disconnecting the AC adapter.

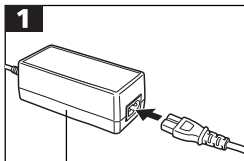

Compact Power Adapter
CA-PS300

- Connect the power cord to the compact power adapter first and then plug the other end into the electrical outlet.

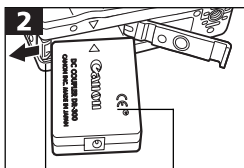

Battery Lock DC Coupler
DR-300

- Open the battery cover and press the battery lock in the direction shown while inserting DC Coupler DR-300. Insert the DC coupler all the way in until the battery lock clicks. Slide the battery cover closed.

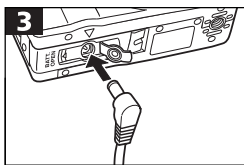

- Open the DC coupler terminal cover and attach the cord to the DC terminal.
- After you have finished using the camera, unplug the AC adapter from the electrical outlet.

Installing a CF Card

Turn the camera power off and insert the CF card with the following procedures.

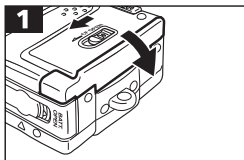

- Slide the lock down and open the CF card slot cover.

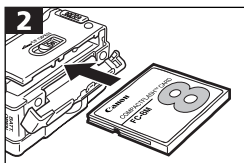

- Insert the CF card until the slot's eject button fully extends. Close the CF card slot cover.

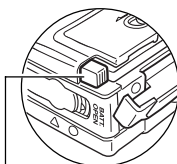

CF Card Eject Button

- To remove the CF card, push the eject button and pull the CF card out.

CF Cards and Estimated Capacities (Recordable Images)

Quality	FC-8M	FC-16M	FC-30M	FC-48M
S L Super-Fine / Large (1600 x 1200 pixels)	4	9	20	31
L Fine / Large (1600 x 1200 pixels)	12	25	52	79
S Fine / Small (640 x 480 pixels)	46	92	192	289

- These figures reflect standard shooting conditions established by Canon. Actual totals may vary according to the subject, shooting conditions and shooting mode.

- Never open the CF card cover while the main switch is on.
- When the indicator flashes green, the camera is recording, reading or deleting images to and from the CF card. Never turn off the power or remove the CF card while the indicator flashes green.
- Please note that CF cards from other manufacturers, or CF cards which have been edited with application software using other formats, may not operate correctly in the camera.

Handling Precautions for CF Cards

- CF cards are high-precision electronic devices. Do not bend them, apply force to them, or subject them to shocks or vibration.
- Do not attempt to disassemble or alter a CF card.
- Moving a CF card rapidly between temperature extremes will cause condensation to form in the card and lead to a malfunction. To avoid condensation, place the CF card in a sealed plastic bag before moving it into a different temperature zone and allow it to adjust slowly to the new temperature. If condensation forms on the CF card, store it at room temperature until the water droplets have evaporated naturally.
- Place the CF card in the supplied case for storage.
- Do not use or store CF cards in the following types of location.
 - Locations subject to strong magnetic fields
 - Location subject to dust or sand
 - Locations subject to high humidity and high temperatures

Attaching the Wrist Strap

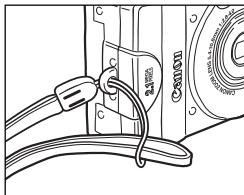

- Thread the small loop of the wrist strap through the strap holder on the camera and pull the large loop through the small loop until the small loop fits snugly against the strap holder.

- Be careful not to wave the camera about or catch it on other items when dangling it from the wrist strap.

Setting the Date and Time

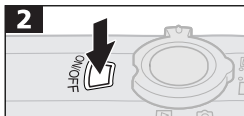
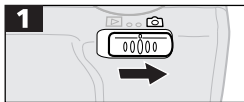

- The Set Date/Time menu will appear the first time the camera power is turned on or whenever the built-in rechargeable lithium battery charge is low. Start from Step 4 to set the date and time.

- Press the main switch until the indicator glows green.
- Press the **MENU** button several times until the Setup menu displays (→ p. 59).
- Use the or button to select .
- Select a field (year, month, day, hour, minutes and date format) with the **SET** button.
- The factory default for the date format in some regions may differ from that shown.
- Use the or button to change the value in a field.

- Press the **SET** button.

- Press the **MENU** button to close the Setup menu.

- Please note that the date and time settings may reset to the default settings if the camera battery has been removed for approximately three weeks. Reset the settings when this occurs.

Quick Start

Shooting

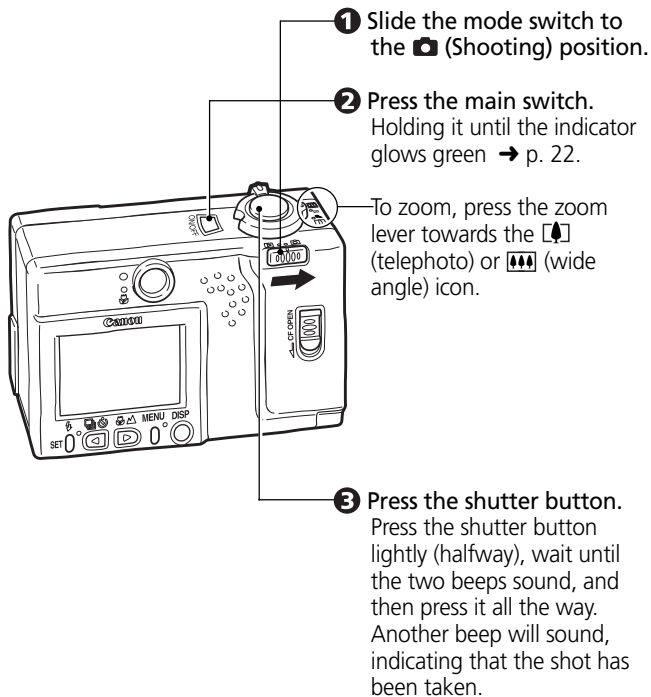

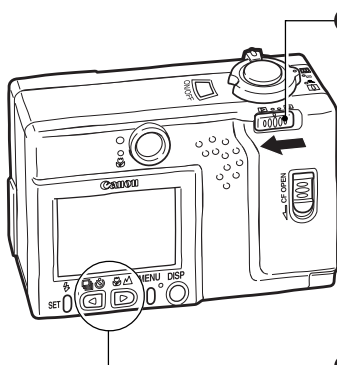

Replaying





- 1 Slide the mode switch to the  (Replay) position. The last image will appear in the LCD monitor.



- 2 Press these buttons to switch to another image. The  button displays the previous image. The  button displays the next image.

When you have finished viewing images, press the main switch to turn off the power.

Erasing Shortcut

1. Hold down the **SET** button and press the  button.
2. Use the  button to select [OK] and press the **SET** button.



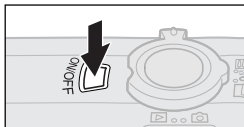

Basic Functions

Turning the Power On/Off



Press the main switch until the indicator glows green.

- When the mode switch is set to  (Shooting), the lens will extend when the main switch is turned on.
 - When the mode switch is set to  (Replay), the LCD monitor will turn on.
- Turn off the power by pressing the main switch again.

- The Set Date/Time menu will appear the first time the camera power is turned on. Please set the date and time (→ p. 19).
- If the power save function turns off the power, press the main switch again to restore it.

Auto Power Down Function

Shooting Mode

The power will automatically shut off approximately 3 minutes after the last function is accessed.

Replay Mode

The power will automatically shut off approximately 5 minutes after the last function is accessed.

While Connected to a Computer

A warning message will appear on the computer screen approximately 5 minutes after the last function is accessed. The power will automatically shut off approximately 1 minute later if no functions are accessed.

- The auto power down function will not activate while the camera is in auto play mode.
- The camera's settings can be changed to turn off the auto power down function (the auto power down function is always on when the camera is connected to a computer.) (→ p. 64)

Switching between the Shooting/Replay Modes

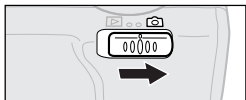



Shooting

Slide the mode switch to the  position.



Replay

Slide the mode switch to the  position.

- The lens remains extended when the mode switch is first switched to replay. It retracts when you press the  or  button.

Using the Optical Viewfinder

This camera is equipped with an optical viewfinder for standard shots.

Align the square brackets (autofocus metering field) inside the viewfinder on the primary subject to compose the image.

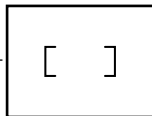
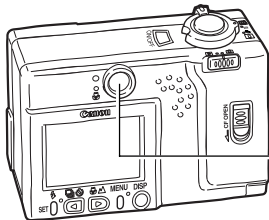

Optical Viewfinder

About the Autofocus Function

This camera employs AiAF (artificial intelligence autofocus) technology which uses a broad metering field to calculate the focal distance with high precision. It delivers a crisp focus even when the photographic subject is slightly off-center.

Using the Focus Lock

The following types of subject may not be suited to autofocus photography. Use the focus lock in these situations.

- Subjects with extremely low contrast to the surroundings
- Subjects with extremely bright objects at the center of the composition
- Subjects that are moving quickly

When recording through glass, try to shoot as close to the glass as possible to reduce the chances of light reflecting back off the glass.

How to Use the Focus Lock

1. Aim the camera so that a subject at the same focal distance as the main subject is centered in the brackets in the optical viewfinder.
2. Press the shutter button halfway and wait until two beeps sound.
3. Re-aim the camera to compose the shot as desired and press the shutter button all the way.

Using the LCD Monitor

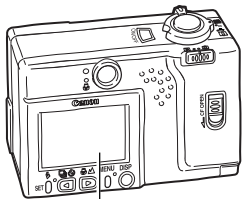

The LCD monitor can be used to shoot or replay images.

- The image in the LCD monitor will darken in strong sunlight or bright light. This does not constitute a malfunction.

LCD Monitor

Shooting Mode



- Pressing the **DISP** button turns the LCD monitor on or off.

- The LCD monitor setting (On or Off) is saved by the camera when the power is turned off so that the same setting is automatically available when the power is turned on again. However, the setting may be lost when the power has been turned off after the "Change the battery pack" message has displayed, while the LCD monitor was on in shooting mode.
- In macro mode, the parallax phenomenon may cause images composed with the optical viewfinder to be off-center. Use the LCD monitor to compose close-ups in macro mode (p. 39).

- In insufficient light, the camera blur warning icon  will display in the center of the LCD monitor when the recording preparations are complete. The upper indicator will also flash red. Use the flash or affix the camera to a tripod to obtain better results.

Replay Mode



- Sliding the mode switch to the position turns the LCD monitor on.
- In replay mode, pressing the **DISP** button cycles between display modes.

Single Image Replay

Standard → Detailed → No Display

Multi Image Replay (9 Images)

Standard → No Display

Information Displayed on the LCD Monitor

Shooting Mode

In shooting mode, information about the current settings and remaining image capacity will display on the LCD monitor for approximately six seconds when the actions below are taken, regardless of whether the LCD monitor is set to On or Off.

While this information is displayed, you may set the flash, continuous mode, self-timer, macro and infinity settings.

- The power is turned on.
- The **DISP**, , , or button is pressed.
- The camera settings are changed.
- The Setup menu is closed.
- The shutter button has been pressed and a shot has been taken.
(LCD monitor must be on)



Remaining Image
Capacity

Information Displayed

Shooting Mode		p.33
Exposure Compensation	-2 ... ±0 ... +2	p.40
White Balance		p.41
Image Quality		p.35
Flash		p.36
Shooting Method		p.37
Macro/Infinity		p.39

Replay Mode

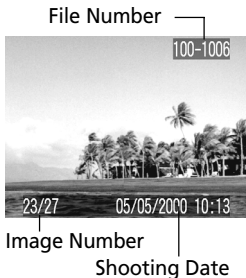

In standard mode, the following information is displayed.

- File Number
- Image Number (Image Number/Total Number of Images)
- Shooting Date
- Protection Status (🔒)



In detailed mode, the following supplementary information is displayed.

Shooting Mode		p.33
Macro/Infinity		p.39
Shooting Method		p.37
Flash		p.36
Exposure Compensation	-2 ... ±0 ... +2	p.40
White Balance		p.41
Image Quality		p.35

The following information may also be displayed with some images.

	A sound file (WAV file) is attached (this camera does not feature sound recording).
	A sound file in a format other than the WAV format is attached or the file format is not recognized.

- Images shot with this camera may not display the information in detailed mode on other digital cameras.

LCD Monitor Menus / Switching between Display Modes

Shooting Mode

The following menus will display on the LCD monitor according to the shooting mode selection.

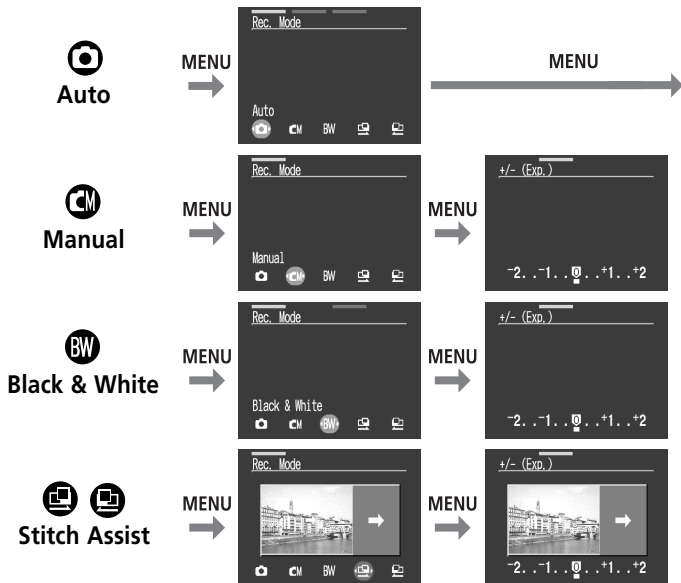

Replay Mode

The zoom lever can be used to switch between magnification levels.



Zoomed Image



Entire Image
(Single Image Display)

Four red bars appear at the top of each menu. Each one represents, from left to right, the [Rec. Mode], [+/- (Exp.)], [White Balance] and [Setup] menus. The bar for the currently selected menu becomes orange. Bars displayed in gray represent menus that cannot be displayed in the shooting mode which is currently selected.

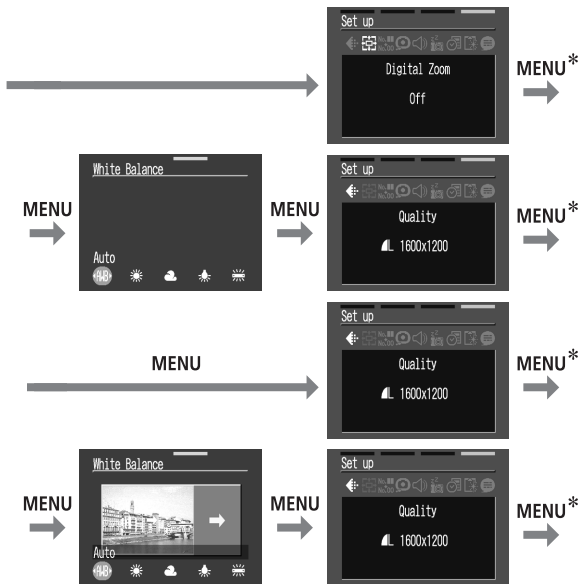

* Closes the Setup menu and prepares the camera for shooting.



Displays Nine Images
(Multi Image Display)



Switches between
Sets of Nine Images

Pressing the Shutter Button

The shutter button features a two-stage action.

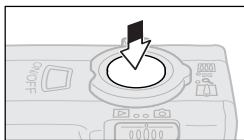

Pressing Halfway

The camera uses the first stage to automatically set the exposure, autofocus and white balance. When it has finished metering, two beeps sound and the upper indicator glows green.

When the flash is used, the indicator glows red when the flash is ready to fire. A flashing red indicator warns of insufficient light or the risk of camera blur.

In macro mode, the lower indicator also glows orange.

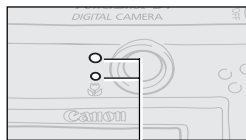

Indicator

Pressing Fully

Pressing the shutter button down fully activates the shutter and causes one beep to sound. While the image is being recorded to the CF card, the indicator flashes green.

If you keep the shutter button pressed down after the shot, the image displays on the LCD monitor. Pressing the **SET** button in this state causes the image to remain in the LCD monitor even if you release the shutter button.



- The displayed image can be erased immediately by holding down the **SET** button and pressing the  button (→ p. 21).
- The image ceases to display when the shutter button is pressed halfway again.

- Recorded images are temporarily stored in the camera's built-in memory and then written to the CF card. The next image can be recorded immediately after the first as long as sufficient built-in memory is available.

Using the Zoom

The zoom can be adjusted to any setting in the 35 to 70 mm range in 35 mm film equivalent terms.

Telephoto/Wide Angle

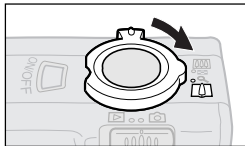

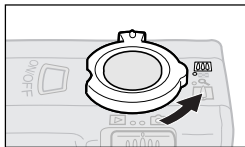

Pressing the zoom lever towards  (telephoto) zooms in on the subject, making it appear closer.



Pressing the zoom lever towards  (wide angle) zooms out from the subject, making it appear more distant.

Digital Zoom

- The digital zoom is available when the LCD monitor is on and the digital zoom feature is set to On in the Setup menu (→ p. 59).
- The digital zoom is not available in the  or  modes.

If you continue to press the zoom lever towards  after the lens is fully extended, you will activate the digital zoom, which makes the subject appear even closer.

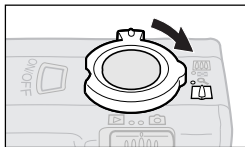

Zoom Setting



Continuing to press the zoom lever towards  further zooms the image in successive steps up to a power of 4.

Double-clicking the zoom lever towards  zooms the image to a power of 2 on the first double-click, and a power of 4 on the second.





Pressing the zoom lever towards  zooms out.

- The digital zoom function combines the optical zoom with a digital teleconverter feature. Please note, however, that the more the image is zoomed with the digital zoom, the grainier the image becomes.



Shooting

Selecting a Shooting Mode

The camera features the following shooting modes.

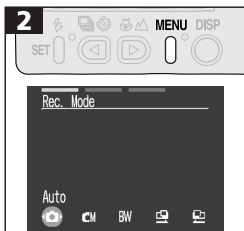
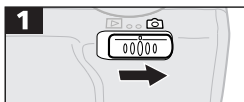
	Auto Mode	Most settings are automatically selected by the camera.
	Manual Mode	The image quality, exposure, white balance and other settings are manually selected by the user.
	Black & White Mode	Images are shot in black and white.
	Stitch Assist Mode	Images are shot in overlapping series to create single panoramic images.



















- Use the  or  button to select a shooting mode.

- The shooting mode resets to  when the power is turned off, unless the camera is set to remember the last selected mode in the Setup menu.



Functions Available in Each Shooting Mode

Function		 Auto	 Manual	 Black & White	 Stitch Assist	Reference Page
Digital Zoom		●	●	●	—	p.60
Flash	Auto 	●*	●*	●*	—	p.36
	Red-Eye Reduction 	—	●	●	—	
	On 	—	●	●	▲	
	Off 	●	●	●	▲*	
	Slow-Synchro 	—	●	●	▲	
Image Quality	Super-Fine/Large 	—	●	●	▲	p.35
	Fine/Large 	●*	●*	●*	▲*	
	Fine/Small 	—	●	●	▲	
Shooting Method	Single 	●*	●*	●*	▲*	—
	Continuous 	—	●	●	—	p.38
	Self-Timer 	●	●	●	▲	p.37
Macro Mode 	●	●	●	▲	p.39	
Infinity Mode 	—	●	●	▲	p.39	
Exposure Compensation	—	●	●	▲	p.40	
White Balance	—	●	—	▲	p.41	

* Default value.

● Setting available.

▲ Selectable for first frame only.

Adjusting the Image Quality

Images can be recorded at the following quality (resolution and compression) settings.

S L	Super-Fine / Large	(1600 x 1200 pixels)
L L	Fine / Large	(1600 x 1200 pixels)
S S	Fine / Small	(640 x 480 pixels)

1

Select a shooting mode
(→ p. 33)

2



3



4



- Available with the **CM**, **BW**, **☐** and **☐** modes. **☐** **☐** : selectable for the first image only
- Press the **MENU** button several times until the Setup menu displays (→ p. 59).
- Use the **◀** or **▶** button to select **☐**.
- Press the **SET** button to choose the quality function.
- Use the **◀** or **▶** button to choose a quality setting. Then press the **SET** button to select the chosen quality.

Approximate File Size of One Image

Image Quality	File Size
S L	1458 KB
L L	580 KB
S S	153 KB

* These figures reflect standard shooting conditions established by Canon. Actual totals may vary according to the subject, shooting conditions and shooting mode.

- Image quality settings are retained even when the shooting mode is changed, except for **☐** mode.
- See page 17 regarding available CF card types and their estimated capacities.
- The image quality settings are saved when the power is turned off.

Using the Flash

	Auto	The flash fires automatically as required by the light level.
	Red-Eye Reduction	A series of flashes are fired to reduce the red-eye phenomenon.
	On	A flash fires with every shot.
	Off	A flash will not fire.
	Slow-Synchro	The flash timing is adjusted to slow shutter speeds. This reduces the chance that the background will be dark when shots are taken at night or in rooms with artificial lighting. Use of a tripod is recommended.

1

Select a shooting mode
(→ p. 33)

1. Available with the , , , , and modes.

	●	●	●	–
	–	●	●	–
	–	●	●	▲
	●	●	●	▲
	–	●	●	▲

- Setting available.
- ▲ Can be selected for first image only.

2











- Press the button to cycle through the flash settings.

- The flash mode may be adjusted while information about the current settings is displayed on the LCD monitor (→ p. 26). When the image information is not displayed, you can press any of the , , or /▲ buttons to activate the display.
- The flash can be fired when the upper indicator glows a steady red.
- The flash takes approximately 10 seconds to charge. Recharging time may vary with the state of the battery charge.

Red-Eye Reduction

The red-eye phenomenon is caused by light reflected from the blood vessels in the back of the eye; the effect is most often seen when using a flash to photograph people in dimly lit environments. This phenomenon can be prevented by recording in the  red-eye reduction mode. The red-eye reduction flash will fire when the shutter button is pressed halfway, helping to reduce the chance that eyes will appear red.

- Please note that a slow shutter speed will be selected in dark places when the flash is set to off. Be careful to avoid camera blur under these conditions.
 - When shooting in  mode, be extremely careful to hold the camera still to avoid camera blur.
 - Always fix the camera to a tripod to shoot in , ,  and  modes since the shutter speed is slower than in  mode. If an image shot in  mode is dark, re-shooting it in  mode will produce a brighter image.









Using the Self-Timer





1

Select a shooting mode
(→ p. 33)

2



- Available with the , , ,  and  modes. (  : selectable for first image only)
- Display .
- When the shutter button is pressed, the self-timer indicator will flash and the shutter will activate after 10 seconds. The flashing will accelerate two seconds before the picture is taken.

- The self-timer mode may be set while information about the current settings is displayed on the LCD monitor (→ p. 26). When the image information is not displayed, you can press any of the , ,  or  buttons to activate the display.
- To switch off the self-timer, press the  again.

Shooting Continuously



1

Select a shooting mode
(→ p. 33)

2



- Available with the **CM** and **BW** modes.
- Display .
- The camera will shoot continuously at approximately 2 images per second* (with the LCD monitor off) while the shutter button is held down. Recording ceases when the shutter button is released.
- * This figure reflects standard shooting conditions established by Canon. Actual figures may vary according to the subject and shooting conditions.

- The continuous mode may be set while information about the current settings is displayed on the LCD monitor (→ p. 26). When the image information is not displayed, you can press any of the ,  or  buttons to activate the display.
- Images may be recorded consecutively in continuous mode until the CF card is full.
- The interval between shots may lengthen slightly when the camera's built-in memory becomes full.

Shooting Close-Ups/Infinity Shots

	Macro Mode	Use this mode to record subjects in the range of 10 to 57 cm (4 to 22 in.) from the tip of the lens when set to wide angle and in the range of 27 to 57 cm (11 to 22 in.) when set to telephoto.
	Infinity Mode	Use this mode to record landscapes and distant objects. It can also be used for compositions combining both near and distant objects.

1

Select a shooting mode
(→ p. 33)

- Available with the , , , and modes.

	●	●	●	▲
	—	●	●	▲

- Setting available.
- ▲ Selectable for first image only.

2



- Display or .

- The macro/infinity modes may be set while information about current settings is displayed on the LCD monitor (→ p. 26). When the image information is not displayed, you can press any of the , or buttons to activate the display.
- Turning the power off will deselect the settings.
- In macro mode, the parallax phenomenon may cause images composed with the optical viewfinder to be off-center. Use the LCD monitor to compose close-ups in macro mode.

Adjusting the Exposure Compensation

An image can be under-exposed if the subject is backlit or positioned in a bright location. Lights in night shots may also appear too bright. To avoid under-exposing the image, use the exposure compensation function.

1

Select a shooting mode
(→ p. 33)

2

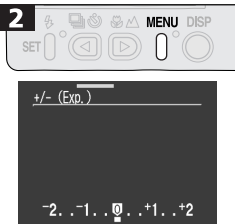

3







- Available with the , , and modes. (: selectable for the first image only)
- Press the **MENU** button several times until the +/- (Exp.) menu displays (→ p. 28).
- Use the or button to select a setting.
- A shot can be taken immediately after. The menu will reappear after the shot, allowing you to adjust the setting.

- The selected exposure compensation setting will remain effective even after the power is turned off.





Setting the White Balance

Setting the white balance to match the dominant light source when shooting will adjust the coloring of the image to the correct settings for the prevailing light conditions.

	Auto	Settings are automatically selected by the camera.
	Daylight	Use this setting for recording outdoors on a bright day.
	Cloudy	Use this setting for overcast, shaded, twilight or evening skies.
	Tungsten	Use this setting for recording under tungsten lighting.
	Fluorescent	User this setting for recording under fluorescent lighting



1

Select a shooting mode
(→ p. 33)

- Available with the ,  and  modes. (  : selectable for the first image only)

2



- Press the **MENU** button several times until the White Balance menu displays (→ p. 28).
- Use the  or  button to select a setting.
- A shot can be taken immediately after. The menu will reappear after the shot, allowing you to adjust the setting.

3



- The selected white balance setting will remain effective even after the power is turned off.

Shooting in Stitch Assist Mode

Stitch Assist mode can be used to shoot images, which overlap, and which can later be merged to create one panoramic image on a computer.

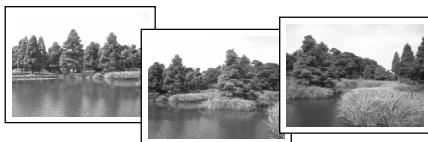

The overlapping seams of several adjacent images can be joined into a single panoramic image.

- To merge the images on the computer, use PhotoStitch, one of the supplied programs.

Framing a Subject

The PhotoStitch program detects the overlapping portions of adjoining images and merges them. When shooting, try to include a distinctive item (landmark) in the overlapping portions.

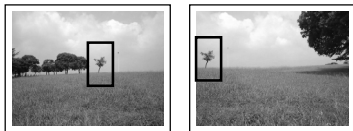

- Compose each frame so that it overlaps 30 - 50% of the adjoining image. Try to keep the vertical misalignment to less than 10% of the image height.
- Do not include moving items in the overlap.
- Do not try to stitch images that include both distant and close items. Objects may appear warped or doubled up.

- Make the brightness in each image consistent. The final image will appear unnatural if the difference in brightness is too great.

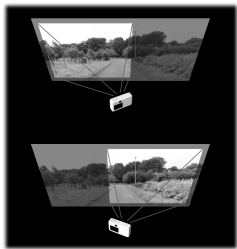



For good results, pan (swivel) the camera to take successive shots.

To shoot close-ups, slide the camera over the subject, keeping it parallel as you move.

Shooting

Images can be shot in two sequences.

	Left to right horizontally
	Right to left horizontally

1

Select a shooting mode
(→ p. 33)



Left to right horizontally

2



- Shoot the first frame in the series.
- The exposure and white balance settings are set and locked with the first image. Successive images use the same settings.

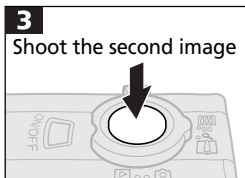

- Compose the second image so that it overlaps a portion of the first and shoot.



- Pressing the or button allows you to check the images that have been recorded.

• Minor discrepancies in the overlapping portions can be corrected when the images are stitched together.

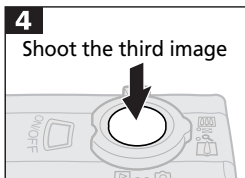

- Repeat the procedure for additional images. A sequence may contain up to 26 images.



- Press the **SET** button to close Stitch Assist mode.

• The zoom, flash (, ,), image quality, exposure compensation, white balance and macro/infinity mode (,) settings can only be adjusted for the first image. The remaining images use the same settings. Additional images use the same settings.

- The digital zoom, certain flash settings (,) and continuous shooting mode cannot be used with the Stitch Assist mode.
- A TV monitor cannot be used when shooting in Stitch Assist mode.

Shooting/Replaying with a TV Monitor

A TV monitor can be used to shoot or replay images when it is connected to the camera via the supplied video cable (VC-200). Always turn the camera and TV power off when attaching or detaching the video cable.

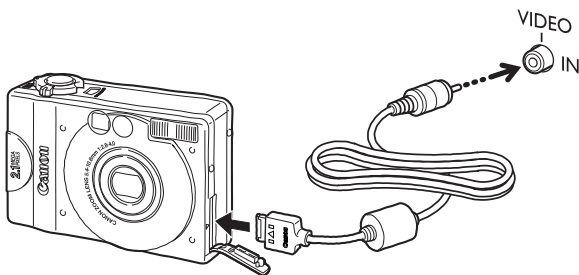

- After the cable has been attached, turn on the TV and switch it to the Video mode.
- Turn the camera power on and use the mode switch to select the shooting or replay mode. You can use the normal procedures to shoot or replay images.
- If the image does not appear on the TV when shooting, press the **DISP** button.

- TV monitors cannot be used in Stitch Assist mode.
- Images will not appear in the camera's LCD monitor when the TV is used as the monitor.
- Due to different video signal standards [NTSC/PAL], a camera purchased in one region may not display images properly when connected to a TV from another region.

Replaying/Erasing

Displaying Images Singly (Single Image Replay)

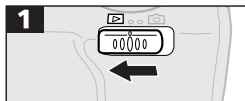

- The last recorded image will appear in the display (single image replay).



- Press the button to switch the display to the previous image. The button switches to the next image. Hold down the button to advance through the images more rapidly. Images will appear coarser at the faster speed.

Zooming an Image

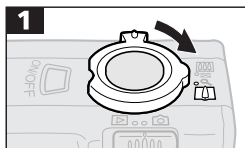

- An image can be magnified approximately 2.5 times in the single image replay mode.



Approximate Location of the Magnified Area



- Use the or button to move the selection area around the image.
- Press the zoom lever towards to reset the zoom setting to normal.

- You can erase the displayed image with a shortcut by holding down the SET button and pressing the button (→ p. 21).
- A TV monitor can be used to replay images (→ p. 45).

Displaying Images in Sets of Nine (Multi Image Replay)

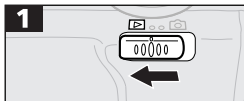

- The last recorded image will appear in the display (single image replay).

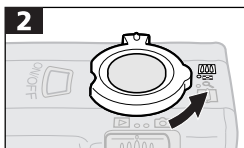

- A set of nine images will appear in the display (multi image replay).



Selected Image



- You can change the image selection with the ◀ or ▶ button. Pressing the zoom lever towards Q will cause the selected image to fill the display.

- You can erase the displayed image by holding down the SET button and pressing the ◀ button (→ p. 21).

Switching between Sets of Nine Images

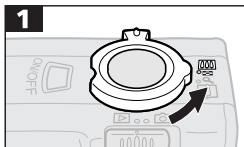

- Successive sets of nine images can be shown in the display.



- Press the ◀ button to display the previous set of nine images. The ▶ button displays the next set of nine.
- Pressing the zoom lever towards Q returns the display to the multi image replay mode.

Rotating Images in the Display

Images can be rotated 90° or 270° clockwise in the display.



0° (Original)



90°



270°



- Use the  or  button to select  then press the **SET** button.



- Cycle between the 90°/270°/0° orientation each time you press the **SET** button.





- Press the **MENU** button several times until the replay screen reappears.

- If an image has been rotated in the camera before being loaded onto a computer, the particular software in use will determine whether or not the rotation settings are retained.

Automating Playback (Auto Play)

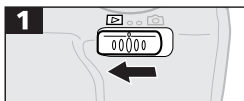
All of the images on a CF card can be displayed one-by-one automatically with the auto play function. Each image is displayed for approximately 3 seconds.



- Use the ◀ or ▶ button to select  then press the **SET** button.
- The camera will read the images on the CF card and start auto play.
- As with the single image display mode, pressing the ◀ or ▶ button during auto play will advance through the images more rapidly.

- The display interval may vary for some images.

Pausing and Resuming Auto Play



- Pressing the **SET** button temporarily pauses auto play. Press the **SET** button again to resume auto play.
- If the ◀ or ▶ button is pressed while auto play is paused, the display can be switched to the previous or next image, respectively.
- Hold down the ◀ or ▶ button to advance through the images more rapidly.

Stopping Auto Play



Protecting Images

You can protect important images to prevent their accidental erasure.

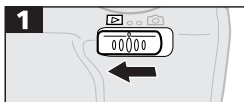

- Use the ◀ or ▶ button to select  then press **SET**.



- Use the ◀ or ▶ button to select an image. Press the **SET** button to protect it.
- Pressing the **SET** button protects the image. If the **SET** button is pressed a second time, the protection is removed.



Protected
Icon



- Press the **MENU** button several times until the replay screen reappears.

• Please note that even protected images are erased when a CF card is reformatted.

Print Settings (DPOF Settings)

Images on a CF card can be individually selected for printing in a specified number of copies. The print type and date or file number printing options can also be selected. These settings are compatible with Digital Print Order Format (DPOF) standards so that images can be printed conveniently on DPOF compliant digital printers or at participating photo labs.

Displaying the Print Settings Menu



- Use the  or  button to select  then press the **SET** button.

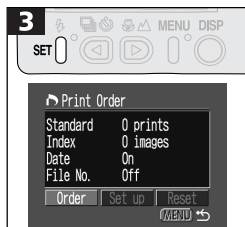







- The following settings can be adjusted in the Print Order menu.
 - [Order]: Selecting Images for Printing
→ p. 54
 - [Set up]: Setting the Print Style
→ p. 53
 - [Reset]: Resetting Print Settings
→ p. 56

- The  mark will display on images that have had print marks set by another DPOF-compliant camera. These settings will be overwritten by any settings set by your camera.

Setting the Print Style

The following settings can be selected.

	Print Type	 Standard	Prints one image per page.
		 Index	Prints the selected images in a single sheet.
		 Both	Prints the images in both standard and index formats.
	Date		Adds the date to the print.
	File No.		Adds the file number to the print.

1



Display the Print Settings menu (→ p. 52).

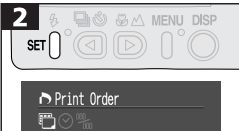

- Use the ◀ or ▶ button to select [Set up].

2



- Use the ◀ or ▶ button to select ,  or .

3



4



- Use the ◀ or ▶ button to select a setting. Press the SET button.

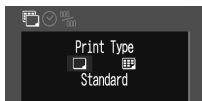

 (Print Type)

You may select [Standard], [Index] or [Both] options.

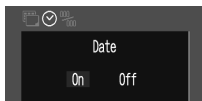

 (Date)

You may select either [On] or [Off].

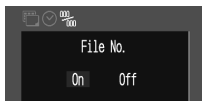

 (File No.)

You may select either [On] or [Off].





- Press the **MENU** button several times until the replay screen reappears.

- The date is printed in the format selected in the date format field of the Set Date/Time menu.

- The date and file number options cannot both be set to On when [Index] is selected as the print type.

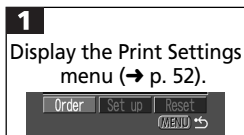
Selecting Images for Printing





- Use the  or  button to select [Order].



The selection method will vary according to the print type () (→ p. 53).

Standard/Both







- Use the  or  button to select an image.
- You can use the zoom lever to switch between the single image and multi image (3 images) display.



Number of Print Copies





- Pressing the **SET** button displays the  icon so that the number of print copies can be specified. Pressing the **SET** button a second time causes the  icon to disappear and restores the image selection mode.
- Use the  or  button to select the number of copies. The maximum is 99 copies.



- Press the **MENU** button several times until the replay screen reappears.

Index



- Use the  or  button to select an image.



Check Mark for Index Printing



- Pressing the **SET** button causes a check mark icon to appear. Pressing the **SET** button a second time deselects the image.



- Press the **MENU** button several times until the replay screen reappears.

- Images are printed in the order of the oldest image to the newest.
- When the print type is set to [Both] and both the date and file number are set to [On], only the file number will print on the index sheet.

- The output of some printers or developing labs may not reflect the specified print settings.

Resetting Print Settings

Resetting the print settings removes them from all the selected images and resets the print type to [Standard], the date setting to [Off] and the file number setting to [Off].

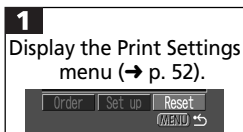

- Use the ◀ or ▶ button to select [Reset].

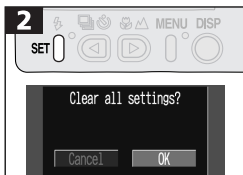

- Use the ◀ or ▶ button to select [OK].
- To cancel instead of resetting, select [Cancel].



3



Erasing Images

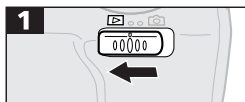

Erasing Images Singly



- Please note that erased images cannot be recovered. Exercise adequate caution before erasing a file.
- Protected images cannot be erased with this function.

- Use the  or  button to select  then press the **SET** button.

- Use the  or  button to select the image you wish to erase.

- Use the  or  button to select [OK].
- To cancel instead of erasing, select [Cancel].

- Images can also be erased using a shortcut (→ p. 21).

Erasing All Images

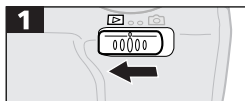

- Please note that erased images cannot be recovered. Exercise adequate caution before erasing a file.
- Protected images cannot be erased with this function.
- Use the ◀ or ▶ button to select  then press the SET button.
- Use the ◀ or ▶ button to select [OK].
- To cancel the command, select [Cancel].



Camera Settings

Displaying the Setup Menu

The Setup menu is used to adjust the camera settings. The procedure for displaying the Setup menu is slightly different for each shooting mode (p. 33). Use the procedures shown below.

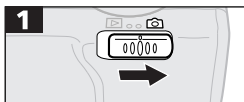
Please see page 35 for instructions on changing the image quality settings.



- The Setup menu can be displayed in the  mode, but not the  mode.



- Press the **MENU** button until the Setup menu displays.



- After adjusting the settings, press the **MENU** button again to close the menu.

Switching the Digital Zoom On/Off

1

Display the Setup menu
(→ p. 59)





- Use the  or  button to select  then press the **SET** button.

2

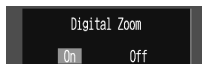

SET   MENU DISP



- Use the  or  button to select [On] or [Off].

3

SET   MENU DISP

- This function is not available in the  or  mode.

Resetting the File Number

You can select the method which the camera uses to assign file numbers with the File No. Reset function.

On	The starting file number is reset to 100-0001 each time a new CF card is inserted. New images recorded on previously recorded CF cards with existing files are assigned the next available number.
Off	The file number of the last recorded image is saved so that the next image recorded on any CF card, including a new one, is assigned the next available number.

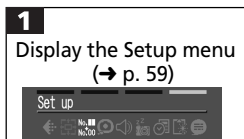

- Use the or button to select then press the **SET** button.

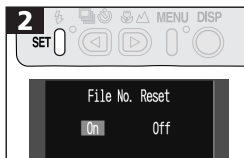

- Use the or button to select [On] or [Off].



- Shooting with the File No. Reset set to Off is useful for avoiding file name duplication when the images are uploaded to a computer and organized in a single directory or album.

About File Numbers

- Images are assigned individual frame numbers ranging from 0001 to 9900 and organized in folders containing up to 100 images. The folders are assigned names from 100 to 998. (Folder numbers cannot contain 99 in the last two digits.)
- Since images shot in , or are always saved into the same folder, some folders may contain 101 or more images.

Saving the Shooting Mode Setting

You can select whether or not to save the shooting mode settings when the camera is turned off. When set to [Last], the current shooting mode setting will still be effective when the camera is turned on again.

1

Display the Setup menu
(→ p. 59)



- Use the ◀ or ▶ button to select  then press the SET button.

2

Startup Mode



- Use the ◀ or ▶ button to select [Last] or [Auto].

3

Startup Mode



- When [Auto] is selected, the shooting setting will reset to  when the camera power is turned on the next time.

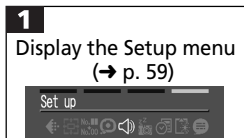

Switching the Beep On/Off

A beep sounds for confirmation purposes when the shutter button is pressed or a camera setting is changed. The beep can be turned off.

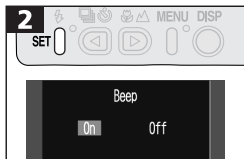

- Use the  or  button to select  then press the **SET** button.



- Use the  or  button to select [On] or [Off].



- The warning beep is not controlled by this setting and will still sound.

Switching the Auto Power Down Function On/Off

The auto power down function can be set to automatically turn the camera power off after a set period of time passes without the camera being used.

On	The camera shuts off after approximately 3 minutes in shooting mode or approximately 5 minutes in replay mode if the camera is not used. Press the main switch to restore power.
Off	If it is on, the LCD monitor shuts off after approximately 3 minutes in the shooting mode if the camera is not used. Pressing any button other than the main switch will turn the LCD monitor on again.

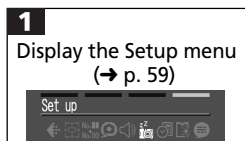

- Use the or button to select then press the **SET** button.

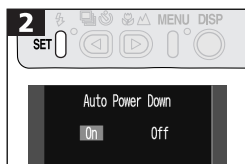

- Use the or button to select [On] or [Off].



- The auto power down function will not activate while the camera is in auto play mode.

Formatting CF Cards

New CF cards must be formatted in accordance with the following procedures before use.

- Please note that formatting a CF card erases all its data, including protected images and other types of data.



1

Display the Setup menu
(→ p. 59)



- Use the  or  button to select  then press the **SET** button.

2



- Use the  or  button to select [OK].
- To cancel formatting, select [Cancel].

3

- When the camera is not operating as expected, reformatting the CF card may solve the problem.
- When a non-Canon brand CF card is malfunctioning, reformatting it may solve the problem.

Setting the Language

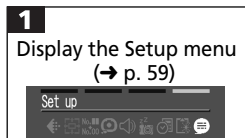
The language in which menus and messages are displayed can be selected with this function.



- Use the ◀ or ▶ button to select  then press the **SET** button.



- Use the ◀ or ▶ button to select a language.



- The Language menu can also be displayed in replay mode by holding down the SET button and pressing the MENU button.
- The Language menu may appear differently on cameras in some regions.

Appendices

Care and Maintenance of the Camera

Use the following procedures to clean the camera body, lens, viewfinder and LCD monitor.

- Never use thinners, benzene, synthetic cleansers or water to clean the camera. These substances may distort or damage the equipment.

Camera Body

Gently wipe dirt off the camera body with a soft cloth or eyeglass lens wiper.

Lens

First use a lens blower brush to remove dust and dirt, then remove any remaining dirt by wiping the lens lightly with a soft cloth.

- Never use synthetic cleansers on the camera body or lens.
- If dirt remains, contact the closest Canon Customer Support Help Desk (see the back of this guide).

Viewfinder and LCD Monitor

Use a lens blower brush to remove dust and dirt. If necessary, gently wipe the viewfinder with a soft cloth or an eyeglass lens wiper to remove stubborn dirt.



- Never rub or press strongly on the LCD monitor. These actions may damage it or lead to other problems.

Troubleshooting

🔍 Camera will not operate

Cause	Solution
Power is not on	<ul style="list-style-type: none"> • Press the main switch for a few moments.
Battery cover or CF card cover opened	<ul style="list-style-type: none"> • Close the battery cover or CF card cover and then press the main switch again to turn the camera off.
Insufficient battery voltage	<ul style="list-style-type: none"> • Insert a fully charged battery pack. • Use an approved AC power source.
Poor contact between battery pack and camera terminals	<ul style="list-style-type: none"> • Wipe the battery terminals with a clean, dry cloth.

🔍 Camera will not record

Cause	Solution
Mode switch is set to  (Replay)	<ul style="list-style-type: none"> • Slide the mode switch to the  (Shooting) position.
Flash is charging	<ul style="list-style-type: none"> • Wait until the flash charges. When the indicator glows red you can press the shutter button.
CF card full	<ul style="list-style-type: none"> • Replace the CF card. • If necessary, download the images to a computer and then erase all or some of the card's images to create space.
CF card not formatted correctly	<ul style="list-style-type: none"> • Format CF card. See Formatting a CF Card (→ p. 65). • If reformatting does not work, the CF card logic circuits may be faulty or damaged. Contact the nearest Canon Customer Support Help Desk.

Lens will not retract

Cause	Solution
Battery cover or CF card cover opened with main switch turned on	<ul style="list-style-type: none"> • Close the battery cover or CF card cover and then press the main switch again to turn the camera off.
Battery cover or CF card cover opened while camera was recording to the CF card (warning signal sounds)	<ul style="list-style-type: none"> • Close the battery cover or CF card cover and then press the main switch to turn the camera off.

Battery pack consumed quickly

Cause	Solution
Battery pack capacity reduced because of disuse for an extended period of time, such as one year	<ul style="list-style-type: none"> • Fully charge and discharge the battery pack several times to restore its capacity.

Battery pack will not charge

Cause	Solution
Battery pack life exceeded	<ul style="list-style-type: none"> • Replace battery pack with a new one.
Poor connection between battery pack and battery charger	<ul style="list-style-type: none"> • Seat the battery pack more firmly in the charger. • Plug the battery charger all the way into the electrical outlet.

🔍 Image is blurred, out of focus, or not as expected

Cause	Solution
Camera moved	<ul style="list-style-type: none"> • Be careful not to move the camera when pressing the shutter button.
Subject is out of focal range	<ul style="list-style-type: none"> • Ensure that there is at least 57 cm (22 in.) between the camera lens and subject. • Use the macro mode to shoot close-ups between 10 and 57 cm (4 and 22 in.) from the lens when set to wide angle and between 27 and 57 cm (11 and 22 in.) when set to telephoto. • Use the infinity mode to shoot distant subjects.
Autofocus function is hampered by something obstructing the AF auxiliary light emitter	<ul style="list-style-type: none"> • Be careful not to block the AF auxiliary light emitter with your fingers or other items.

🔍 Subject is too dark in image

Cause	Solution
Insufficient light for shooting	<ul style="list-style-type: none"> • Set the flash to On.
Subject is much darker than its surroundings	<ul style="list-style-type: none"> • Set the exposure compensation to a positive (+) setting.
Subject is too far away for flash to reach	<ul style="list-style-type: none"> • Shoot within 27 cm to 3 m (11 in. to 10 ft.) of the subject at the maximum wide angle or 27 cm to 2 m (11 in. to 7 ft.) of the subject at the maximum telephoto setting when using the flash.

🔍 Subject is too bright

Cause	Solution
Subject is too close	<ul style="list-style-type: none"> • When using the flash, stay 27 cm to 3 m (11 in. to 10 ft.) from the subject at the maximum wide angle or 27 cm to 2 m (11 in. to 7 ft.) from the subject at the maximum telephoto setting.
Subject is much brighter than its surroundings	<ul style="list-style-type: none"> • Adjust the exposure compensation to a negative (-) setting.
Light is shining directly on subject or reflected off subject onto camera	<ul style="list-style-type: none"> • Change the shooting angle.
Flash is set to On	<ul style="list-style-type: none"> • Set the flash to Auto or Off.

🔍 Flash will not fire

Cause	Solution
Flash is set to Off	<ul style="list-style-type: none"> • Set the flash to Auto or On.

List of Messages

The following messages may appear in the LCD monitor.

Busy...:	Image is being recorded to, or read from, CF card
No CF card:	You attempted to shoot or replay images without a CF card installed.
Cannot record!:	You attempted to shoot an image without a CF card installed.
CF card error:	CF card has experienced an anomaly.
CF card full:	CF card is too full to accommodate more images or print settings.
Naming error!:	The file could not be created because there is a file with the same name as the directory that the camera is attempting to create, or the highest possible file number has already been reached. Save all the images you wish to retain onto a computer, then reformat the CF card. Please note that formatting will erase all the existing images and other data.
Change the battery pack:	Battery charge is insufficient to operate the camera. Charge the battery pack immediately.
No image:	No images recorded on CF card.
Image too large:	You attempted to replay an image larger than 3200 x 2400 pixels.
Incompatible JPEG format:	You attempted to replay an incompatible JPEG file.

Corrupted Data:	You attempted to replay an image with corrupted data.
CCD RAW:	You attempted to replay a CCD RAW image.
Unidentified Image:	You attempted to replay an image that was recorded in a special format (proprietary format used by the camera of another manufacturer, etc.).
Cannot magnify!:	You attempted to magnify an image which was photographed with another camera, recorded in a different format, or edited on a computer.
Cannot rotate:	You attempted to rotate an image which was photographed with another camera, recorded in a different format, or edited on a computer.
Protected!:	You attempted to erase a protected image.
Too many marks:	Too many images have been marked for printing. Cannot process any more.
Cannot complete!:	Failed to save print settings.
Exx:	(xx: number) Camera malfunction. Turn the power off and then back on, then shoot or replay. Problem exists if error code reappears. Note the number and contact Canon Customer Support Help Desk. If an error code displays directly after taking a picture, the shot may not have been recorded. Check image in replay mode.

Specifications

PowerShot S100 DIGITAL ELPH / DIGITAL IXUS

Image Sensor:	Approx. 2.11 million-pixel 1/2.7 inch charge coupled device (effective pixels: approx. 2.02 million)
Image Quality:	Super-Fine / Large (1600 x 1200 pixels) Fine / Large (1600 x 1200 pixels) Fine / Small (640 x 480 pixels)
Recording Media:	CompactFlash™ Card (Type I)
Image Format:	Design rule for Camera File System (Images / Thumbnails: JPEG)
Sensitivity:	Equivalent to ISO 100
Lens:	5.4 - 10.8 mm (35 mm film equivalent: 35 - 70 mm) F 2.8 (wide angle) - F4.0 (telephoto)
Digital Teleconverter:	2x / 4x
Focusing Range:	Standard: 57 cm - ∞ (22 in. - ∞) Macro: 10 - 57 cm (4 - 22 in.) (wide angle) 27 - 57 cm (11 - 22 in.) (telephoto)
Viewfinder:	Real-image optical viewfinder 1.5 inch low-temperature polycrystalline silicon TFT LCD
Metering Method:	Center weighted metering
Focusing Method:	TTL 3 point AiAF
Auto Exposure Method:	TTL program AE
White Balance Control:	TTL auto / manual
Shutter:	Mechanical + electronic
Shutter Speed:	1 - 1/1500 sec. (1-sec. for Slow-Synchro mode and manual mode with flash set to Off)
Flash:	Built-in (Auto, On, Off, Red-Eye Reduction, Slow- Synchro)
Flash Range:	27 cm - 3 m (11 in. - 10 ft.) (wide angle) 27 cm - 2 m (11 in. - 7 ft.) (telephoto)
Camera Modes:	Shooting / Replay

Interface:	USB / CF Card Slot (Type I) / Video Out
Power Supply:	Battery Pack NB-1L Compact Power Adapter CA-PS300 (with DC Coupler DR-300)
Operating Temperatures:	0 - 40 °C (32 - 104 °F)
Operating Humidity:	10 - 90%
Dimensions:	87.0 x 57.0 x 26.9 mm (3.4 x 2.2 x 1.1 in.) excluding protrusion
Weight:	Approx. 190 g (6.7 oz.) excluding battery and CF card

Battery Pack NB-1L

Type:	Rechargeable lithium ion cell
Rated Voltage:	3.7 V
Rated Amperage:	680 mAh
Life-span:	Approx. 300 charge cycles
Operating Temperatures:	0 - 40 °C (32 - 104 °F)
Dimensions:	32.3 x 49.8 x 10.6 mm (1.3 x 1.9 x 0.4 in.)
Weight:	Approx. 29 g (1.0 oz.)

Battery Charger

CB-2L

CB-2LE

Input Voltage:	AC 100 - 240 V (50/60 Hz)	
Rated Output:	4.2 V / 0.58 A	4.2 V / 0.65 A
Rated Input:	7.5 VA (100 V)	12.5 VA (240 V)
Operating Temperatures:	0 - 40 °C (32 - 104 °F)	
Dimensions :	65 x 105 x 36 mm (2.6 x 4.1 x 1.4 in.)	
Weight:	Approx.110 g (3.9 oz.)	Approx.95 g (3.4 oz.)

CompactFlash™Card

Card Slot Type:	Type I
Dimensions:	36.4 x 42.8 x 3.3 mm (1.4 x 1.7 x 0.1 in.)
Weight:	Approx. 10 g (0.4 oz.)

* All data is based on Canon's standard testing methods. Subject to change without notice.

Index

A

- AC Adapter 16
- Autofocus 24
- Auto Mode 33
- Auto Play 49
- Auto Power Down 22
 - On/Off 64

B

- Battery
 - AC Power Supply 16
 - Handling 13
 - Installing 14
 - Performance 15
 - Recharging 12
- Battery Pack 12
- Beep 63
- Black and White Mode 33

C

- Camera Settings 59
- Care and Maintenance 67
- CF Card
 - Capacity 17
 - Formatting 65
 - Handling 18
 - Installing 17
- Continuous Shooting 38

D

- Date and Time 19
- Digital Zoom 32, 60
- Displaying Information 26
- DPOF 52

E

- Erasing 57
 - Erasing All Images 58
 - Erasing Images Singly 57
 - Erasing the Displayed Image 21
- Exposure 40

F

- File Number 61
- Flash 35
- Focus Lock 24

I

- Image Quality 35
- Indicator 11
- Infinity Mode 39
- Information Display 26

L

- Language Settings 66
- LCD Monitor 10
 - Menus/ Switching between Display Modes 28
 - Using 25

M

- Macro Mode 39
- Main Switch 11, 22
- Magnifying Images 46
- Manual Mode 33
- Mode Switch 11, 23
- Multi Image Replay 47

O

Optical Viewfinder 23

P

Power On/Off 22
 Pressing Fully 30
 Pressing Halfway 30
 Print Settings 52
 Selecting 54
 Print Style 53
 Resetting Print Settings
 56
 Protecting Images 51

R

Red-Eye Reduction 36
 Replay 21, 46
 TV Monitor 45
 Rotate 48

S

Self-Timer 37
 Setup Menu 59
 Shooting 20, 33
 TV Monitor 45
 Functions Available in each
 Shooting Mode 34
 List of Modes 33
 Saving the Shooting Mode
 Setting 62
 Selecting 33
 Shutter Button 11, 30
 Pressing Fully 30
 Pressing Halfway 30
 Single Image Replay 46
 Stitch Assist Mode 42

T

Telephoto 31

V

Video Cable VC-200 45
 Viewfinder 23

W

White Balance 41
 Wide Angle 31
 Wrist Strap 18

Z

Zoom 31
 Zooming Images 46
 Zoom Lever 11, 31

Canon Customer Support

Canon Inc.

30-2 Shimomaruko 3-chome, Ohta-ku, Tokyo
146-8501, Japan

NORTH AMERICA

Canon U.S.A., Inc.

Canon Customer Care Center
Phone (US): 1-800-828-4040
(Available Mon. - Fri., 9 AM to 8 PM Eastern Time)

Canon Canada Inc.

Phone (Canada): 1-800-OK-CANON (1-800-652-2666)
(24 hours/day, 7 days/week)

EUROPE

Europe, Africa & Middle East

Canon Europa N.V.

PO Box 2262, 1180 EG Amstelveen, The Netherlands

Canon (UK) Ltd.

Helpdesk
Tel No.: 08705 143 723 (Calls may be recorded.)
Fax No.: 08705 143 340 BBS No.: 08705 143 350

Canon France S.A.

Hotline : 01.41.99.70.70
Tél : 01.41.99.77.77 Télécopie : 01.41.99.79.51

Canon Photo Vidéo France S.A.

Hotline : 01.49.04.01.00 Télécopie : 01.49.04.01.01

Canon Deutschland GmbH

Canon-Hotline-Service
Customer-Support: (02151) 349-555
Telefax: (02151) 349-588
Info-Desk Tel: (02151) 349-566
Info-Desk Fax : (02151) 349-599
Mailbox : (02151) 349-577

Canon Euro-Photo GmbH

Customer-Support: (02154) 495-610

Info-Desk: (02154) 495-444

Fax: (02154) 495-333

Canon Italia S.p.A.

Pronto Canon : 02 8249 2000 BBS : 02 8249 2099

Canon Belgium N.V. / S.A.

Helpdesk: 0900-10627

Tel.: (02) 722.04.11 Fax: (02) 721.32.74

Canon Luxembourg S.A.

Tel.: (352) 48 47 961 Fax: (352) 48 47 96232

Canon Nederland N.V.

Helpdesk: 023 - 5 681 681

Tel.: 023 - 5 670 123 Fax: 023 - 5 670 124

Canon Danmark A/S

Hotline: 44 88 26 66

Canon España S.A.

Help Desk: 906 301 255

Tel: (91) 538 45 00 Fax: (91) 411 41 76

E-mail: helpdesk@btlink.net

Canon Norge as

Tlf. 22 62 93 21 Faks: 22 62 06 15

E-mail: helpdesk@canon.no

Finland**Canon OY**

Puhelin: 010 54420 Fax: 010 544 4571

Help Desk: 0600 0 22606 (14,80 mk/min+pvm)

Help Desk: 0600 0 22666 (enint. 40mk/puhelu+pvm)

Sähköposti: helpdesk@canon.fi

Canon (Schweiz) AG

Tel. 01-835-6161, Fax 01-835-6860

Hotline 0900 57 55 20

Canon Svenska AB

Stensåtravägen 13, S-127 88, Skärholmen, Sweden

Austria

Canon GmbH

Zetschegasse 11, 1232 Wien, Austria

Tel: 01 680 88-0

Fax: 01 680 88-222

OCEANIA

Canon Australia Pty. Ltd.

Info-Line: (02) 9805 2864

Canon New Zealand Ltd.

Info-Line: 0900-522666

ASIA

Canon Singapore Pte. Ltd.

79 Anson Road, #09-01 / 06, Singapore 079906

Phone: (65) 532 4400 Fax: (65) 221 7577

Canon Hongkong Co., Ltd.

9/F, The Hong Kong Club Building, 3A Chater Road, Central, Hong Kong

Phone: 852-2739-0802 Fax: 852-2369-7701

Canon Marketing Services

No.1 Jalan Kilang Timor, #09-00, Pacific Tech Centre,
Singapore 159303

Phone: (65) 799 8888 Fax: (65) 273 3317

Canon Marketing (Malaysia) Sdn. Bhd.

Wisma General Lumber, Block D, Peremba Square,
Saujana Resort, Section U2, 40150,

Shah Alam, Selangor Darul Ehsan, Malaysia

Phone: (60) 3 744 6000, (60) 3 745 0055

Fax: (60) 3 745 0505

Canon Marketing (Thailand) Co., Ltd.

10th Floor, Bangkok City Tower,

179/34-45 South Sathorn Road,

Bangkok 10120, Thailand

Phone: (662) 344 9999 Fax: (662) 344 9910

Canon Marketing (Hongkong) Co., Ltd.

10/F, Mirror Tower, 61 Mody Road, Tsimshatsui East
Kowloon HongKong

Phone: 852-2170-2828 Fax: 852-2723-9684

FCC Notice

(Digital Camera, Model PC1001)

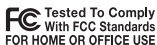

This device complies with Part 15 of the FCC Rules. Operation is subject to the following two conditions;

- (1) this device may not cause harmful interference, and
- (2) this device must accept any interference received, including interference that may cause undesired operation.

Note: This equipment has been tested and found to comply with the limits for Class B digital devices, pursuant to Part 15 of the FCC rules. These limits are designed to provide reasonable protection against harmful interference in a residential installation. This equipment generates, uses and can radiate radio frequency energy and, if not installed and used in accordance with the instructions, may cause harmful interference to radio communications. However, there is no guarantee that interference will not occur in a particular installation. If this equipment does cause harmful interference to radio or television reception, which can be determined by turning the equipment off and on, the user is encouraged to try to correct the interference by one or more of the following measures:

- Reorient or relocate the receiving antenna.
- Increase the separation between the equipment and receiver.
- Connect the equipment into an outlet on a circuit different from that to which the receiver is connected.
- Consult the dealer or an experienced radio/TV technician for help.

Use of shielded cable is required to comply with Class B limits in Subpart B of Part 15 of the FCC rules.

Do not make any changes or modifications to the equipment unless otherwise specified in the manual. If such changes or modifications should be made, you could be required to stop operation of the equipment.

Canon U.S.A. Inc.

One Canon Plaza, Lake Success, NY 11042, U.S.A.

Tel No. (516) 328-5600

Canadian Radio Interference Regulations

THIS CLASS B DIGITAL APPARATUS MEETS ALL REQUIREMENTS OF THE CANADIAN INTERFERENCE CAUSING EQUIPMENT REGULATIONS.

Règlementation canadienne sur les interférences radio

CET APPAREIL NUMERIQUE DE LA CLASSE B RESPECTE TOUTES LES EXIGENCES DU REGLEMENT SUR LE MATERIEL BROUILLEUR DU CANADA.

Canon