

Canon
ZR10

DIGITAL VIDEO CAMCORDER

Instruction Manual

CAMESCOPE ET LECTEUR VIDEO NUMERIQUES

Mode d'emploi

VIDEOCAMARA Y GRABADORA DIGITAL

Manual de Instrucciones

ENGLISH

E

FRANÇAIS

F

ESPAÑOL

Es

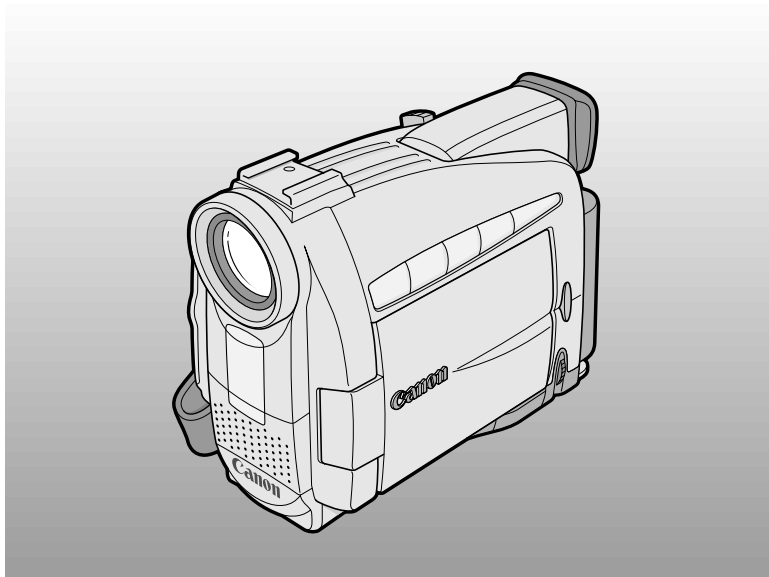

Canon

ZR10

NTSC

Mini DV Digital
Video
Cassette

Important Usage Instructions

E

WARNING:

TO REDUCE THE RISK OF FIRE OR ELECTRIC SHOCK, DO NOT EXPOSE THIS PRODUCT TO RAIN OR MOISTURE.

WARNING:

TO REDUCE THE RISK OF ELECTRIC SHOCK AND TO REDUCE ANNOYING INTERFERENCE, USE THE RECOMMENDED ACCESSORIES ONLY.

COPYRIGHT WARNING:

Unauthorized recording of copyrighted materials may infringe on the rights of copyright owners and be contrary to copyright laws.

Digital Video Camcorder, ZR10 A and Compact Power Adapter, CA-560

This device complies with Part 15 of the FCC Rules. Operation is subject to the following two conditions: (1) This device may not cause harmful interference, and (2) this device must accept any interference received, including interference that may cause undesired operation.

Note: This equipment has been tested and found to comply with the limits for class B digital device, pursuant to Part 15 of the FCC Rules. These limits are designed to provide reasonable protection against harmful interference in a residential installation. This equipment generates, uses and can radiate radio frequency energy and, if not installed and use in accordance with the instructions, may cause harmful interference to radio communications. However, there is no guarantee that interference will not occur in a particular installation. If this equipment does cause harmful interference to radio or television reception, which can be determined by turning the equipment off and on, the user is encouraged to try to correct the interference by one or more of the following measures:

- Reorient or relocate the receiving antenna.
- Increase the separation between the equipment and receiver.
- Connect the equipment into an outlet on a circuit different from that to which the receiver is connected.
- Consult the dealer or an experienced radio/TV technician for help.

Use of shielded cable is required to comply with class B limits in Subpart B of Part 15 of FCC Rules. Do not make any changes or modifications to the equipment unless otherwise specified in the manual. If such changes or modifications should be made, you could be required to stop operation of the equipment.

Canon U.S.A. Inc.
One Canon Plaza, Lake Success, NY 11042, U.S.A.
Tel No. (516)328-5600

Introduction

CAUTION:

TO PREVENT ELECTRIC SHOCK, MATCH WIDE BLADE OF PLUG TO WIDE SLOT, FULLY INSERT.

Important Warning

The lightning flash with arrowhead symbol, within an equilateral triangle, is intended to alert the user to the presence of uninsulated "dangerous voltage" within the product's enclosure, that may be of sufficient magnitude to constitute a risk of electric shock to persons.

CAUTION:

TO REDUCE THE RISK OF ELECTRIC SHOCK, DO NOT REMOVE COVER (OR BACK). NO USER-SERVICEABLE PARTS INSIDE. REFER SERVICING TO QUALIFIED SERVICE PERSONNEL.



The exclamation point, within an equilateral triangle, is intended to alert the user to the presence of important operating and maintenance (servicing) instructions in the literature accompanying the product.

IMPORTANT SAFETY INSTRUCTIONS

In these safety instructions the word “product” refers to the Canon Digital Video Camcorder ZR10 A and all its accessories.

1. **Read Instructions** — All the safety and operating instructions should be read before the product is operated.
2. **Retain Instructions** — The safety and operating instructions should be retained for future reference.
3. **Heed Warnings** — All warnings on the product and in the operating instructions should be adhered to.
4. **Follow Instructions** — All operating and maintenance instructions should be followed.
5. **Cleaning** — Unplug this product from the wall outlet before cleaning. Do not use liquid or aerosol cleaners. The product should be cleaned only as recommended in this manual.
6. **Accessories** — Do not use accessories not recommended in this manual as they may be hazardous.
7. **Avoid magnetic or electric fields** — Do not use the camera close to TV transmitters, portable communication devices or other sources of electric or magnetic radiation. They may cause picture interference, or permanently damage the camera.
8. **Water and Moisture** — Hazard of electric shock — Do not use this product near water or in rainy/moist situations.
9. **Placing or Moving** — Do not place on an unstable cart, stand, tripod, bracket or table. The product may fall, causing serious injury to a child or adult, and serious damage to the product.
A product and cart combination should be moved with care. Quick stops, excessive force, and uneven surfaces may cause the product and cart combination to overturn.



10. **Power Sources** — The CA-560 Compact Power Adapter should be operated only from the type of power source indicated on the marking label. If you are not sure of the type of power supply to your home, consult your product dealer or local power company. Regarding other power sources such as battery power, refer to instructions in this manual.
11. **Polarization** — The CA-560 Compact Power Adapter is equipped with a polarized 2-prong plug (a plug having one blade wider than the other). The 2-prong polarized plug will fit into the power outlet only one way. This is a safety feature. If you are unable to insert the plug fully into the outlet, try reversing the plug. If the plug still fails to fit, contact your electrician to replace your obsolete outlet. Do not defeat the safety purpose of the polarized plug.
12. **Power Cord Protection** — Power cords should be routed so that they are not likely to be walked on or pinched by items placed upon or against them. Pay particular attention to plugs and the point from which the cords exit the product.
13. **Outdoor Antenna Grounding** — If an outside antenna is connected to the product, be sure the antenna is grounded so as to provide some protection against voltage surges and built-up static charges. Section 810 of the National Electrical Code, ANSI / NFPA No. 70—1984, provides information with respect to proper grounding of the mast and supporting structure, grounding of the lead-in wire to an antenna discharge unit, size of grounding conductors, location of antenna discharge unit, connection to grounding electrodes, and requirements for the grounding electrode. See figure 1.

E

Introduction

E

Fig. 1

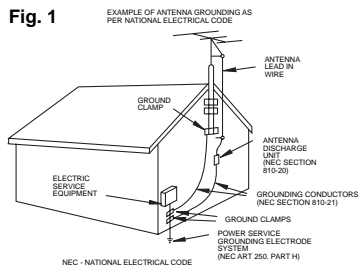

Introduction

14. **Lightning** — For added protection of this product during a lightning storm, or when it is left unattended and unused for long periods of time, disconnect it from the wall outlet and disconnect the antenna. This will prevent damage to the product due to lightning and power-line surges.
15. **Power Lines** — An outside antenna system should not be located in the vicinity of overhead power lines or other electric light or power circuits, or where it can fall into such power lines or circuits. When installing an outside antenna system, extreme care should be taken to keep from touching such power lines or circuits as contact with them might be fatal.
16. **Overloading** — Do not overload wall outlets and extension cords as this can result in a risk of fire or electric shock.
17. **Objects and Liquid Entry** — Never push objects of any kind into this product through openings as they may touch dangerous voltage points or short out parts that could result in a fire or electric shock. Be careful not to spill liquid of any kind onto the product.
18. **Servicing** — Do not attempt to service this product yourself as opening or removing covers may expose you to dangerous voltage or other hazards. Refer all servicing to qualified service personnel.
19. **Damage Requiring Service** — Disconnect this product from the wall outlet and all power sources including battery, and refer servicing to qualified service personnel under the following conditions:
 - a. When the power-supply cord or plug is damaged.
 - b. If any liquid has been spilled onto, or objects have fallen into, the product.
 - c. If the product has been exposed to rain or water.
 - d. If the product does not operate normally even if you follow the operating instructions. Adjust only those controls that are covered by the operation instructions. Improper adjustment of other controls may result in damage and will often require extensive work by a qualified technician to restore the product to its normal operation.
 - e. If the product has been dropped or the cabinet has been damaged.
 - f. When the product exhibits a distinct change in performance. This indicates a need for service.
20. **Replacement Parts** — When replacement parts are required, be sure the service technician has used replacement parts that are specified by Canon or that have the same characteristics as the original part. Unauthorized substitutions may result in fire, electric shock or other hazards.
21. **Safety Check** — Upon completion of any service or repairs to this product, ask the service technician to perform safety checks to determine that the product is in safe operating order.

Contents

Introduction

Important Usage Instructions	2
IMPORTANT SAFETY INSTRUCTIONS	3
Thank you for Choosing a Canon	6

Quick Overview

Introducing the ZR10	7
Finding Your Way Around the ZR10	8
Powering Your Camcorder	11
Loading a Cassette	16
Basic Recording	18
Zooming	22
Using the LCD Screen	23
Playing Back a Cassette	27
Connections for Playback on a TV Screen.....	30
Tips for Making Better Videos	32

Using the Full Range of Features

~ General ... ~	
Turning the Image Stabilizer Off	34
Selecting from the Menus	35
Using the Wireless Controller	38
~ For Recording ...~	
Setting the Date and Time	41
Taking Still Pictures	44
Transferring Still Pictures to a PC with the FR-100 (optional).....	46
Searching and Reviewing While Recording	47
Using the Various Recording Programs.....	48
Using Digital Effects	52

Audio Recording	58
Setting the Self-Timer	60

~ When Making Manual Adjustments ...~

Adjusting Exposure Manually.....	62
Adjusting Focus Manually	65
Setting the White Balance	66

~ For Playback ...~

Displaying Date, Time and Camera Data (Data Code)	68
Searching the Tape (Photo Search/Date Search).....	71
Returning to a Pre-Marked Position	72

Editing

Editing to a VCR.....	73
Dubbing with Digital Video Equipment	74
Recording from a VCR, TV or Analog Camcorder (Analog Line-in)	76
Recording Over Existing Scenes (A/V Insert Editing)	78
Audio Dubbing	81
Setting the Audio Mix	84

Additional Information

Preparing the Camera	86
Notes on Using the Batteries.....	88
Maintenance	91
Troubleshooting.....	95
The ZR10 System Diagram.....	98
Optional Accessories	99
Screen Displays	103
Specifications	108
Index	109

E

Introduction

The serial number of this product may be found on the bottom of the camera. No others have the same serial number as yours. You should record the number and other vital information here and retain this book as a permanent record of your purchase to aid identification in case of theft.

Date of Purchase
 Dealer Purchased From
 Dealer Address
 Dealer Phone No.
 Model Name ZR10
 Serial No.

Thank you for Choosing a Canon

E

First, we'd like to thank you for purchasing this Canon camcorder. Its advanced technology makes it very easy to use — you will soon be making high-quality videos which will give you pleasure for years to come.

To get the most out of your new camcorder, we recommend that you read this manual thoroughly — there are many sophisticated features which will add to your recording enjoyment.

Getting started

To get started we suggest that you master the basic operations of the camcorder first, before moving on to use its full range of features.

For quick reference (in addition to the contents and index) please refer to:

- Finding your way around the ZR10 (8)
- Screen displays (103)
- Troubleshooting — in case you run into any problems (95)

Symbols used in this instruction manual:



📖 : Reference page numbers

📖 : Supplementary notes for camcorder operation

🎵 : Operation confirmation beeps (21)

- Capital letters are used to refer to settings displayed in the menus and buttons labeled on the camcorder itself, e.g. Press the MENU button.

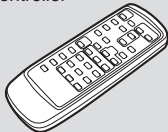
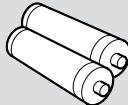
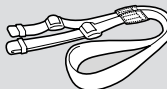
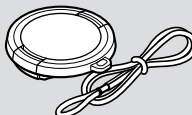
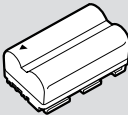
Your camcorder is supplied with the following accessories:

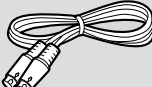
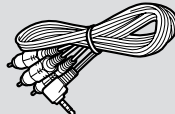
WL-D74 Wireless Controller 	Two AA batteries 
SS-600 Shoulder Strap 	Lens cap and lens cap cord 
BP-511 Battery Pack 	CA-560 Compact Power Adapter (including AC power cable) 
Lithium button battery 	S-150 S-video Cable 
STV-250 Stereo Video Cable 	

Introducing the ZR10

Digital Video



ZR10 is a next generation digital video camcorder that conforms to the digital video D standard to give you outstanding picture quality.

2.5" LCD Screen

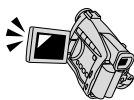

A 2.5" LCD screen makes it easy for you to shoot colorful, well composed video. It is also great for playback.

Image Stabilizer



Stabilizes your recordings even in long telephoto shots.

10× Lens and 40×/200× Digital Zoom



From wide-angle to 10× telephoto—with unparalleled optical quality. The digital zoom magnifies this up to 200× for even more dramatic results.

Still Photos



The ZR10 has the technology to capture crisp, clear, digital still pictures.

Digital Effects

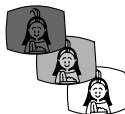

Advanced digital technology allows you to add special effects during recording or playback.

Audio Dubbing/A/V Insert Editing



Add new sound to original sound, or replace original sound and images on a prerecorded tape.

Analog Line-in Recording

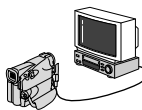

Connect to a VCR or analog camcorder and record onto a DV tape in the ZR10.

Internal charging

The ZR10 can charge a battery pack itself, smoothing the transition between charging and shooting, and allowing for a smaller, lighter AC power adapter.

PCM Digital Sound

DV Terminal (IEEE 1394)

ZR10 is equipped with a DV terminal that conforms to IEEE1394. With a single cable, it lets you edit, copy and transfer data digitally to and from other digital equipment with the same terminal, with virtually no generation loss in image and sound quality.

E

Quick Overview

Finding Your Way Around the ZR10

E

Quick Overview

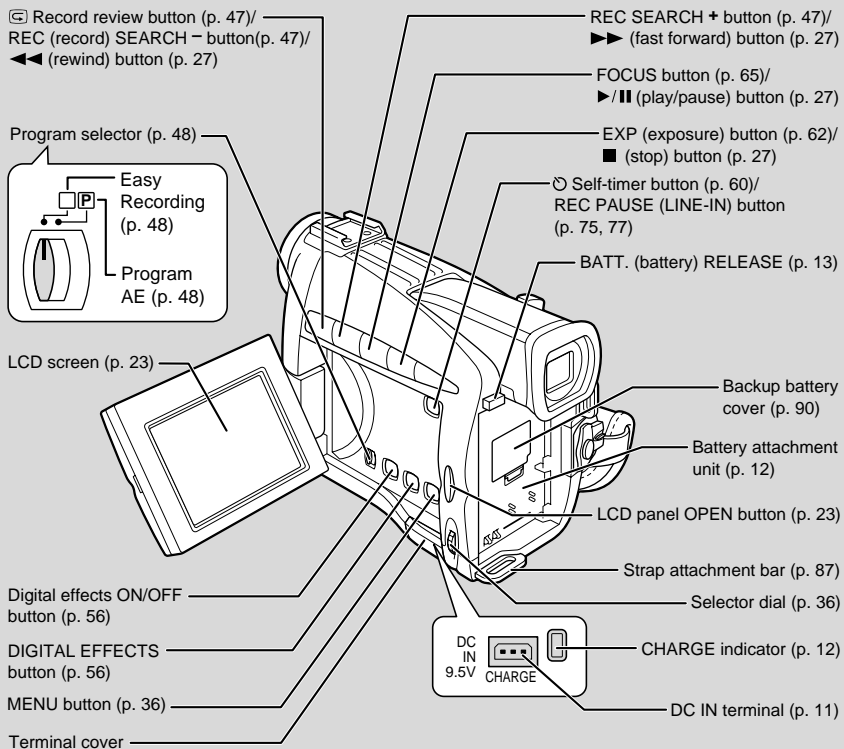

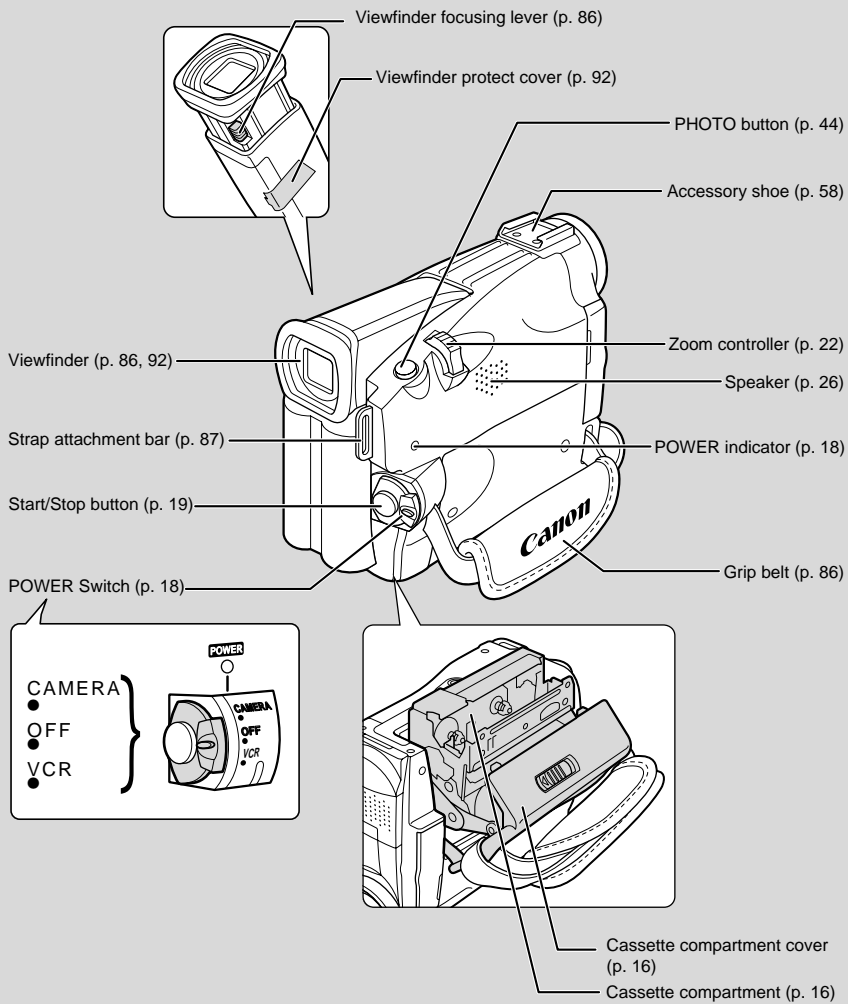

E

Quick Overview

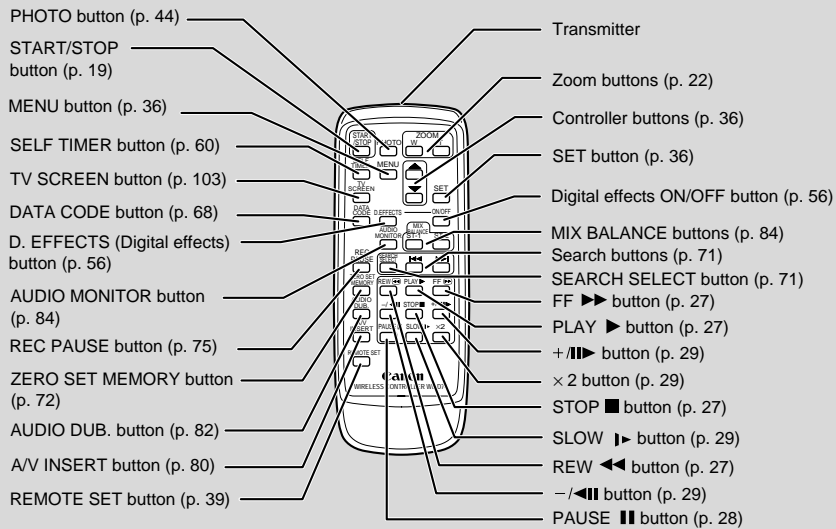
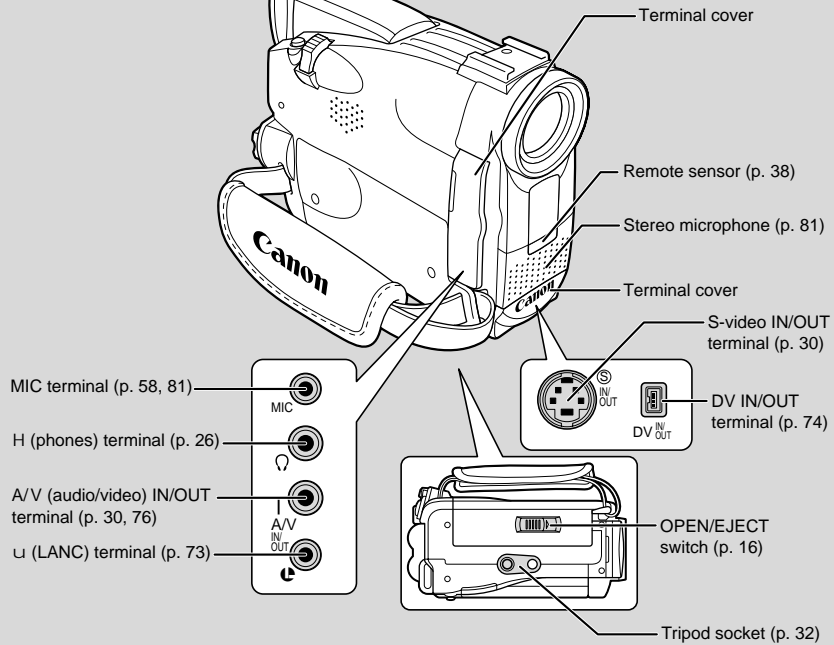

Powering Your Camcorder

Before operating your camera, you will need to use the power adapter to:

Provide power from an AC outlet

or

Charge a battery pack



- The power adapter converts current from a household power socket (100–240 V AC, 50/60 Hz) to the DC current used by your camera.
- If the adapter is used next to a TV, it may cause bars to appear on the TV — move the adapter away from the TV or the antenna cable.

Connecting the camera to an AC outlet

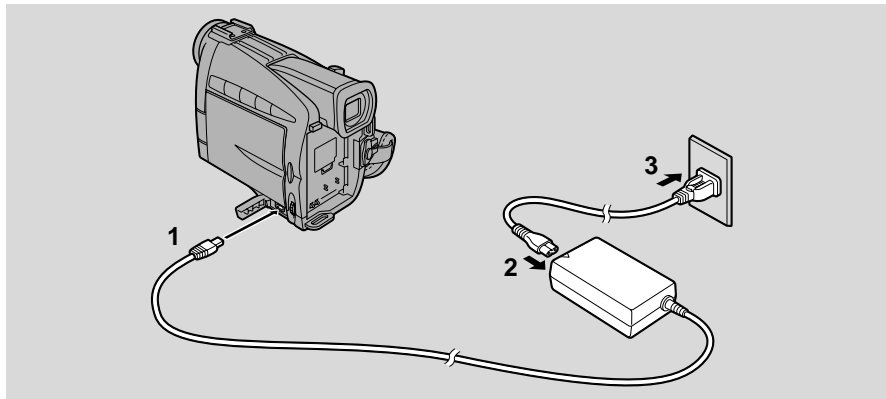

Use the power adapter to provide your camera with instant power from an AC outlet. Always turn the camera off before connecting/removing the power source.

- 1. Connect the power adapter to the camera's DC IN terminal.**
- 2. Connect the power cable to the power adapter.**
- 3. Plug the adapter into an AC outlet.**
- 4. Disconnect the power adapter from the camera after use. Unplug the power cable from the AC outlet, then disconnect it from the adapter.**

E

Quick Overview

E

Attaching and charging the battery packs

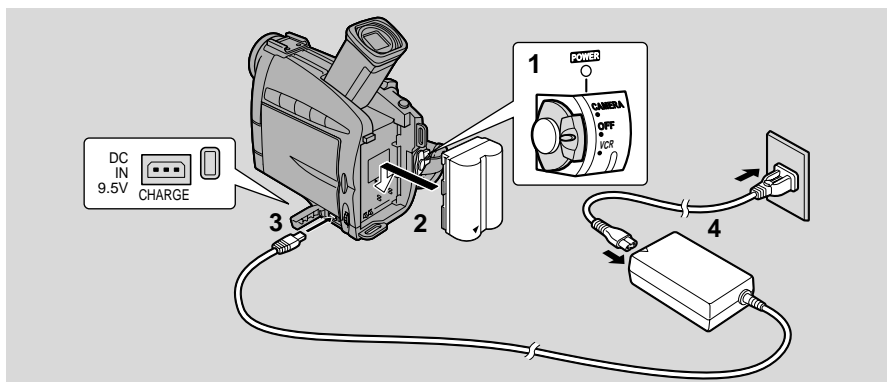

Your battery pack was partially charged before it left the factory. It should have enough power for you to check that your camera is working properly. However, you must charge the battery pack fully if you want it to power the camera for more than a few minutes.

Always turn the camera off and raise the viewfinder before connecting/removing the battery.

Quick Overview

1. Set the POWER switch to OFF.

2. Attach the battery to the camera.

- Remove the battery pack's terminal cover.
- Rotate the viewfinder upwards.
- With the triangle on the battery pack pointing downwards, align the edge of the battery pack with the line on the camera, press lightly and slide the battery down until it clicks into place.

3. Connect the power adapter to the camera.

4. Connect the power cable to the adapter and plug it into an AC outlet.

- The charge indicator flashes red to show that charging is in progress. Single flashes mean that the battery pack is less than 50% charged. Double flashes mean that it is between 50% and 75% charged. Triple flashes mean that it is more than 75% charged. The indicator glows steadily when the battery pack is fully charged. If the indicator blinks twice a second, the battery pack may be defective.
- Charging will also take place when the camera is set to VCR and in stop mode, or the camera has turned itself off after being left in record pause mode for more than about 5 minutes.

5. When charging is complete, disconnect the power adapter from the camera. Unplug the power cable from the AC outlet, then disconnect it from the adapter.

E

6. Remove the battery pack after use.

- Rotate the viewfinder upwards.
- Press and hold the BATT. RELEASE button while you slide the battery up.



- Never connect an unspecified product to the camera's DC terminal. Likewise, do not connect the power adapter to an unspecified product.
- You can find detailed notes for using the batteries in the "Notes on Using the Batteries" (88). These notes include charging and recording times and how to install the backup battery.

CA-560 Compact Power Adapter

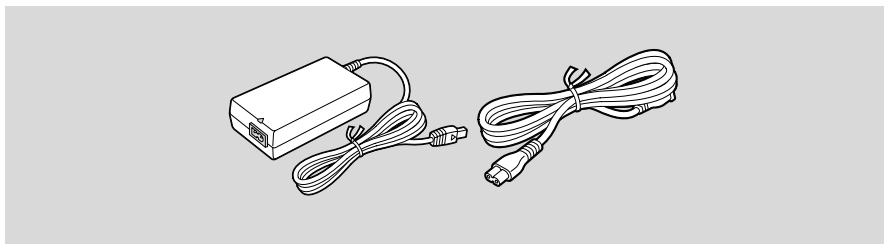

Specifications

Power supply	100–240 V AC, 50/60 Hz
Power consumption	34 W
Rated output	9.5 V, 2.7 A DC
Operating temperature range	32°F–104°F (0°C–40°C)
Dimensions	2 1/4 × 1 1/8 × 4 1/8 in (57 × 28 × 104 mm)
Weight	6 3/8 oz (180 g) (without power cable)

Weight and dimensions are approximate.

Errors and omissions excepted.

Subject to change without notice.

When replacement of power supply is required, please return it to the responsible nearest Canon Service Center and please replace it with the same type number CA-560 or equivalent.

The Adapter can be used with a power supply between 100 and 240 V AC. For areas where 120 V AC power is not used, you will need a special plug adapter. Contact your nearest Canon Service Center for further information.

E**Using the Charge Adapter CR-560 Kit (optional)**

The Compact Power Adapter CA-560 included with the camera can be used along with the CR-560 Kit for 3 different ways to power the camera or charge battery packs:

1. Charge the BP-500 Series battery packs with power from your car battery.
2. Operate the camera with power from your car battery.
3. Charge the BP-500 Series battery packs from a household AC outlet.

The Charge Adapter/Car Battery Cable Kit CR-560 includes the following:

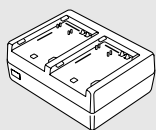

Charge Adapter

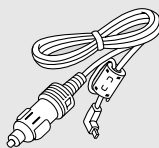

Car Battery Cable

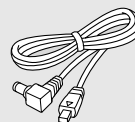

DC Cable

Quick Overview**1. Charge the BP-500 Series battery packs with power from your car battery.**

1 or 2 battery pack(s) + Charge Adapter + Car Battery Cable → car's cigarette lighter

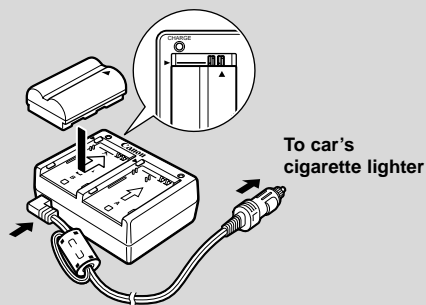

- Fast charging for the high-capacity BP-522 (optional). Fifteen minutes of charging gives 70 minutes of recording (using the viewfinder).

	Time required for full charge from car battery or household outlet
BP-511	1 hr. 20 min.
BP-522 (optional)	1 hr. 40 min.

2. Operate the camera with power from your car battery.

Camera + DC Cable + Charge Adapter + Car Battery Cable → car's cigarette lighter

E

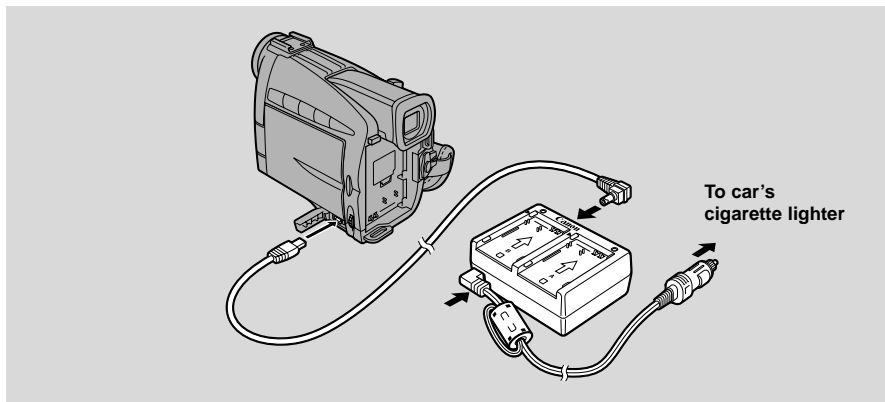

3. Charge the BP-500 Series battery packs from a household AC outlet.

1 or 2 battery pack(s) + Charge Adapter + Compact Power Adapter

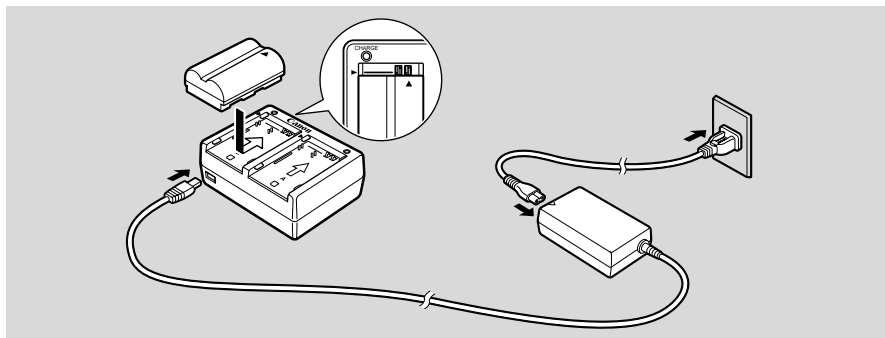

- Fast charging for the high-capacity BP-522 (optional). Fifteen minutes of charging gives 70 minutes of recording (using the viewfinder).



- For full details of how to use the CR-560, refer to its instruction manual.

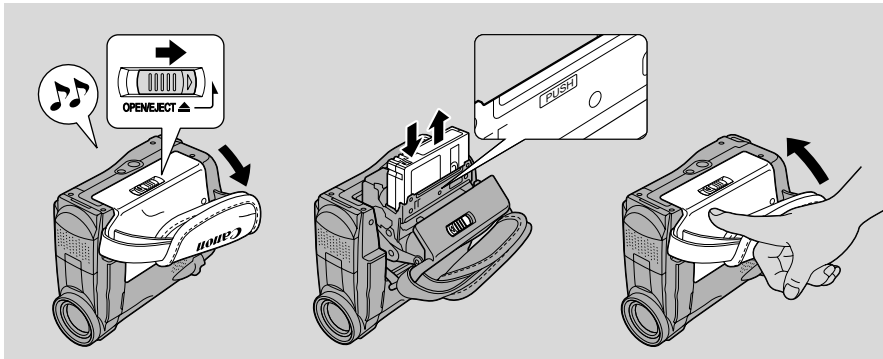

Loading a Cassette

E





Only use videocassettes marked with the  logo.*

Loading and unloading

1. **Make sure that you have attached a power source.**
2. **Slide the OPEN / EJECT  switch to release the cassette compartment cover.**
 - Pull the cover fully open (while holding the button) and wait a couple of seconds for the cassette compartment to open automatically.
 - The confirmation beep sounds when the cassette cover fully opens.
3. **Load or unload the cassette.**
 - Insert the cassette gently with the window facing out, and the REC/SAVE tab up.
 - Remove the cassette by pulling it straight out.
4. **Press the  mark on the compartment until it clicks, and wait for it to close.**
5. **Click the cover back into place.**

*  is a trade mark.



- After loading a cassette, use record search ( 47) to find the point where you want to start recording.
- Do not interfere with the cassette compartment while it is opening or closing automatically, or attempt to close the cover.
- Be careful not to get your fingers caught in the cassette compartment cover.
- Do not leave the cassette in the camera after use — return it to its case and store it in a cool, clean, dry place.
- When you turn the camera's power on,  flashes in the display until you load a cassette.
- With some types of tapes, the remaining tape display may not give an accurate reading ( 103).

Protecting tapes from accidental erasure

E

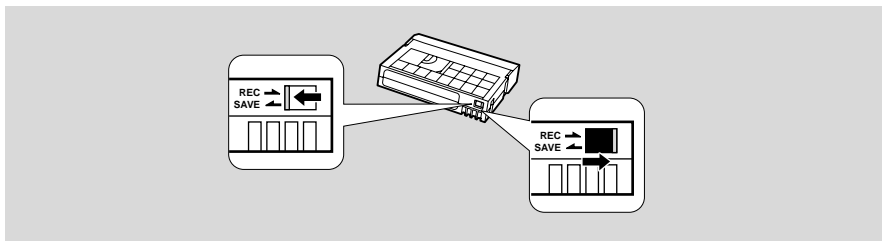

To protect your recording from accidental erasure, slide the tab on the cassette so that it exposes the hole. (This switch position is usually labeled SAVE or ERASE OFF.)

If you load this cassette and put the camera in record pause mode (18), “THE TAPE IS SET FOR ERASURE PREVENTION” is displayed for approx. four seconds and then the mark flashes in the display. The camera also shows the above phrase if you accidentally press the REC PAUSE button on the camera or the wireless controller with the camera switched to VCR mode.

If you want to record on the cassette again, slide the tab back so the hole is closed.

Handling cassettes

- To protect the tape heads, transfer cassettes directly from the tape case to the camcorder — do not open the tape protect cover or touch the tape itself.
- Do not use cassettes where the tape has been damaged or spliced — they may damage the camcorder.
- Do not insert anything into the small holes on the cassette or cover them with cellophane tape.
- Handle cassettes with care — dropping them or exposing them to external shocks may cause internal damage.
- Store cassettes in the provided case, first rewinding them to the start of the tape and then storing them upright.
- A cassette with metal plated terminals may become dirty with use, affecting information transfer. Therefore, after using a tape about ten times, be sure to clean the terminals with a cotton swab.

Cassette Memory

You are unable to use the cassette memory function with this camcorder.

Quick Overview

Basic Recording

E

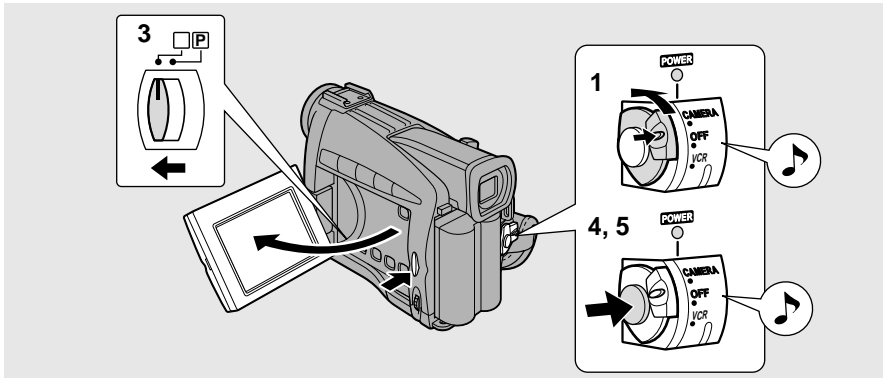

Before you start recording

Have you completed the following steps?

- Attached a power source (11).
- Removed the lens cap (86) and fastened the shoulder strap (87).
- Chosen the display: viewfinder (86) or LCD screen (23)

Quick Overview



- When you're using the viewfinder, fully close the LCD or rotate the LCD so that it faces the same direction as the lens (25).
- When using the viewfinder with the BP-522 Battery Pack (optional) attached, extend the viewfinder (86).

You may also want to install the backup battery (90) in order to set the date and time display (41).

To record

1. **Push the small green button on the POWER switch and hold, turn the POWER switch to CAMERA.**
 - The camera automatically sets to record pause mode. PAUSE appears in the display.
 - The camera power indicator lights up red.
 - The confirmation beep sounds.
 - The camera will turn itself off if you leave it in record pause mode for more than about five minutes. To return to record pause mode, set the POWER switch to OFF and then back to CAMERA.
2. **Load a cassette (16).**

3. Slide the program selector to [.

- This selects the camera's Easy Recording program. It allows you to simply point and shoot without making any manual adjustments ( 50).

4. Press and release the start/stop button once to begin recording.

- To take still photographs, see p. 44.

5. Press and release the start/stop button again to pause recording.

- The camera returns to record pause mode and PAUSE reappears in the display.
- You can stop and restart recording as often as you like by pressing the start/stop button.



- After loading a cassette, start recording when the tape counter has stopped.

When you have finished recording

- Replace the lens cap.
- Return the viewfinder to its retracted position.
- Return the LCD screen flush to the camera body.
- Unload the cassette.
- Set the POWER switch to OFF.
- Disconnect the power source.



- To check that the camera is recording correctly, make a test recording first.
- Before making important recordings, clean the video heads using a Canon DVM-CL Digital Video Head Cleaning Cassette or a commercially available digital video head cleaning cassette.
- To close the LCD panel, rotate it vertically until the screen faces you, then push it in flat against the side of the camera until it clicks securely.
- You cannot monitor the sound from the speaker when recording.
- For tips on how to make better videos, see p. 32.
- For extra recording time, set REC MODE in the camera menu to LP ( 20).

E**Quick Overview**

E**Changing the recording mode (SP/LP)**

You can record and play back a tape in SP (standard play) and LP (long play) modes. LP extends tape usage by 1.5 times.

To switch to LP mode, select REC MODE from the camera or VCR menu, select LP and then close the menu (for instructions on how to use the menus, see p. 36).

You can't add sound (audio dubbing) or images (A/V insert) to a tape that has been recorded in LP mode. If you plan to use either of these functions later, record in SP mode.



- When recording and playing back tapes in LP mode, the nature of the tape and usage conditions may affect recording, mosaic-like noise may appear in the image and the sound may be distorted during playback of tapes recorded in LP mode. For important recordings, therefore, set the camera to SP mode.
- If you record in both modes on the same tape, the picture may become distorted during playback and the time code may not be written correctly.
- A tape recorded in LP mode on other digital equipment may produce mosaic-like noise and the sound may become distorted when played back on this camcorder, and vice versa.

Quick Overview

16:9 (Widescreen TV recording)

Produces images in the 16:9 format for playback on widescreen TVs.

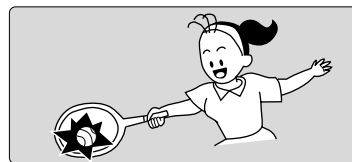

- 1. Select 16:9 from the camera menu and turn it ON/OFF.**
- 2. Press the MENU button once more to close the menu.**



- "16:9" is shown in the display when you switch the 16:9 effect on.
- You cannot use the 16:9 mode with the Easy Recording program.
- If you play back a recording made for 16:9 on a normal TV screen, the image will appear to be vertically "squashed" (compressed).
- If you connect the camera to a TV with an S1 terminal or the Video ID-1 system, recordings made in the 16:9 mode for wide screen TVs will automatically play back in wide screen mode on the TV screen.

Confirmation/Warning beeps

E

The camera's short operation confirmation beeps are indicated by  in the illustrations. Beeps sound upon certain camera operations such as when you turn the camera on, during the self-timer countdown, right before the camera's automatic shut-off, and also upon any unusual condition of the camera. Beeps are not recorded on the tape. You can turn them OFF through the menu.

 **MENU**
( 35, 36)

 BEEP.....ON

Quick Overview

Zooming

E

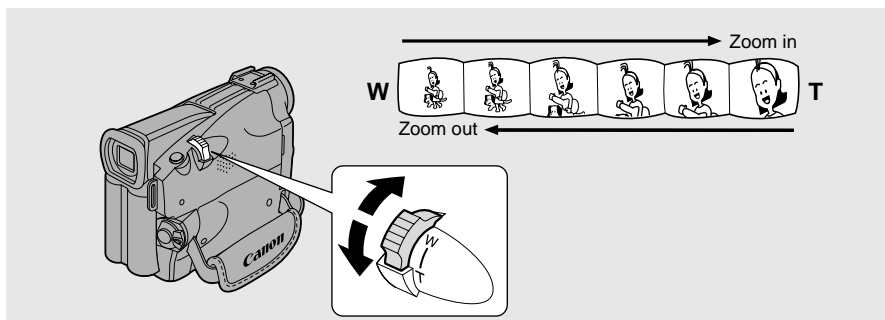

10× optical zoom

The camera's 10× zoom lens allows you to choose the best picture angle for each scene:

- Move the zoom control towards W to zoom out to wide-angle.
- Move it towards T to zoom in to telephoto.

You can also control the speed of zooming:

- Move the control slightly to zoom slowly.
- Move it farther to zoom more quickly. (The farther you move the zoom control, the faster the zoom speed.)

The T and W buttons on the wireless controller adjust the picture angle, but not the zoom speed.

40×/200× digital zoom

Turn the digital zoom on by choosing D.ZOOM from the camera menu, to magnify the camera's zoom range by up to 20×.



The zoom control continues to work as usual. You can freely zoom in and out between 1× and 40× or 1× and 200× magnification — the camera automatically switches between optical zooming (up to 10×) and digital zooming (10× to 40× or 10× to 200×).



- When zooming, as a rule, keep at least 3 ft $3\frac{3}{8}$ in (1 m) between you and your subject. However when the zoom is at the wide-angle position, you can focus on a subject as close as $\frac{3}{8}$ in (1 cm).
- Image resolution is slightly lower when the magnification is greater than 10×.
- When the digital zoom is set to 40×, the zoom indicator extends (light blue).
When the digital zoom is set to 200× zoom, the zoom indicator extends again (a darker blue).

Using the LCD Screen

Open the LCD screen

Push the LCD panel OPEN button and open the panel by pulling it away from the camera. This automatically switches the LCD screen on and the viewfinder off. When you close the LCD panel, the LCD screen automatically switches off and the viewfinder switches back on.

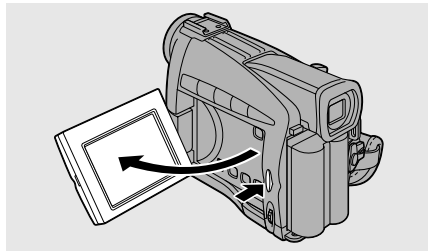

E

Changing the angle of the LCD screen

You can choose the angle of the screen that suits you best by opening and rotating the screen, also you can rotate the LCD screen so that it faces in the direction of the lens (25).

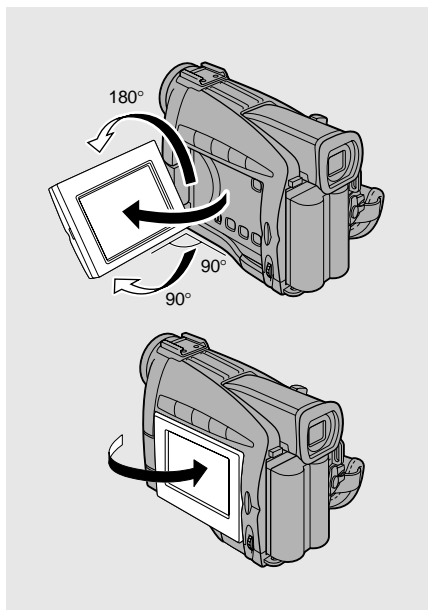

Quick Overview

You can also push the panel flat against the camera until it is flush with the side, with the screen facing outwards.

E

- Avoid touching the LCD screen when moving the LCD panel.
- Do not hold the camera by the LCD panel or the viewfinder.
- Make sure you open the LCD panel at 90°, before attempting to rotate it.
- Always rotate the LCD panel vertically into place, before closing it or pushing it flat against the side of the camera.
- Always fully close the LCD panel until it clicks securely.
- Be careful not to leave the LCD, viewfinder or lens exposed to direct sunlight outdoors or in a window. Doing so could cause damage.
- Bright light falling on the LCD screen may cause glare that makes it difficult for you to view the image. In this case, switch to using the viewfinder. You are also able to adjust the brightness of the screen (see “Adjusting the LCD screen” below).

Adjusting the LCD screen

You can adjust the brightness of the LCD screen. Adjust the level by choosing BRIGHTNESS from the menu.

A bar showing the level appears in the display for 4 seconds.

- Turn the selector dial up to make the display brighter.
- Turn the selector dial down to make the display darker.

Quick Overview

**MENU**

(35, 36)

▶ BRIGHTNESS ·····▶



- The camera will remember your brightness setting even after you turn it off.
- The brightness of the LCD does not affect that of the recorded images or the viewfinder.

About the LCD Screen

The LCD screen built into this camcorder is a high precision product. However, small black dots or bright points of light (red, blue or green) may appear constantly on the LCD screen. This is not a malfunction of the LCD screen and they are not recorded on the tape. (Effective dots: more than 99.99%)

Allowing the subject to monitor recording

E

When you turn the LCD panel so that it faces the same direction as the lens, you can watch yourself during recording or let your subject monitor recording. The viewfinder is also activated when the panel is in this position.

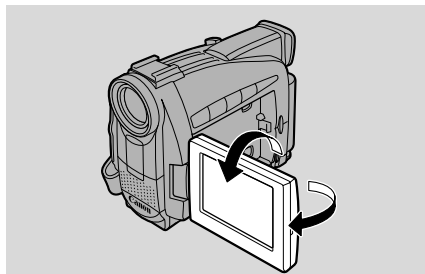

- You can choose the display style, reversed (mirror on) or not (mirror off). The recording itself is unaffected regardless of which one you choose.



1. Open the camera menu and point the arrow at **MIRROR**.
2. Select the **OFF** setting and close the menu.

The 4 indicators that appear in the LCD display when **MIRROR** is turned on:

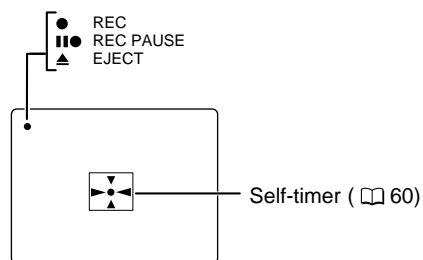

- These and all other indicators appear normally in the viewfinder.

Quick Overview

E**Built-in speaker and headphone terminal**

The camcorder has a built-in speaker and a headphone terminal so you can review the sound track alongside the picture during playback. The built-in speaker is monaural; use headphones for stereo sound.

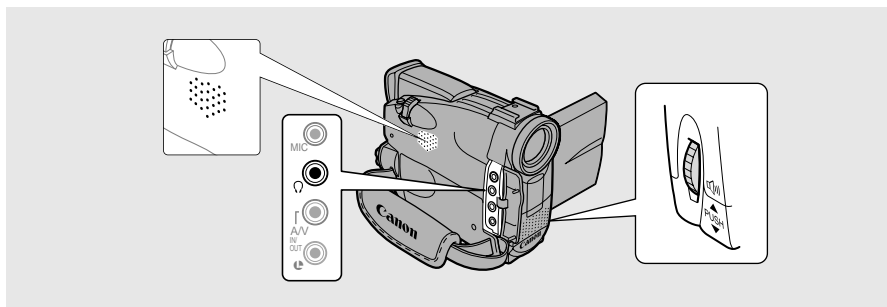

Adjust the speaker and headphone volume by turning the selector dial.

- Turn the selector dial up to increase the volume, and down to lower the volume.
- A VOLUME bar appears in the display to indicate the current volume. It disappears in four seconds.
- You can turn off the volume completely by turning the selector dial down until OFF appears.
- You can also adjust the headphone volume separately from the built-in speaker, either during VCR mode or camera mode. The volume level is the same regardless of mode.
- The levels you adjust for the built-in speaker and headphones are memorized separately. The camera remembers your levels even if you turn the camera off and back on again.



- The speaker turns off when the camera is set to camera mode or when you use headphones.
- Sometimes audio may sound distorted when the volume is turned up high. If this happens, turn down the volume.

Playing Back a Cassette

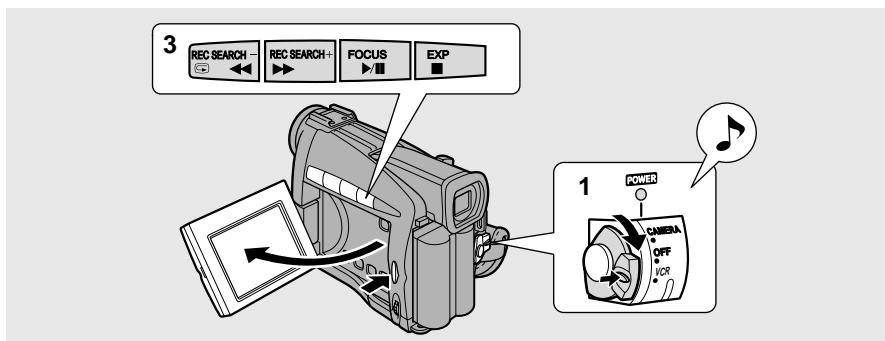

E

You can use the LCD screen for instant, on-the-spot playback. The camera also plays back the sound track via the built-in speaker (26).

- When you play back a tape, you can also close the LCD panel with its screen side facing up.
- When you're using the viewfinder to view playback, close the LCD panel.

To play back your recordings on a TV, see p. 30.

To use the wireless controller, see p. 38.



- To avoid accidental recording, make sure that you slide the tab on the cassette so that it exposes the hole (the switch position is usually labeled SAVE or ERASE OFF).

1. Attach a power source and turn the POWER switch to VCR.

- The power indicator lights up green.

2. Load the cassette.

3. Press the ► (play) button to start playback.

- To end playback, press the ■ (stop) button.
- To wind the tape forwards, stop playback and press the ►► (fast forward) button.
- To wind the tape backwards, stop playback and press the ◀◀ (rewind) button.
- If the playback picture is rough (mosaic-like noise), clean the video heads using a Canon DVM-CL Digital Video Head Cleaning Cassette or a commercially available digital video head cleaning cassette.

Quick Overview

E

Other playback modes

Playback pause

Press the **||** (pause) button. To resume normal playback, press it again, or press the **▶** (play) button. The camera automatically goes into stop mode after about five minutes' playback pause.

Fast forward playback

To play back the recording at about 9.5 times normal speed, press and hold the **▶▶** (fast forward) button during normal playback or press and hold the **▶▶** (fast forward) button during normal fast forward.

Rewind playback

For reverse playback at about 9.5 times normal speed, press and hold the **◀◀** (rewind) button during normal playback or press and hold the **◀◀** (rewind) button during normal rewind.

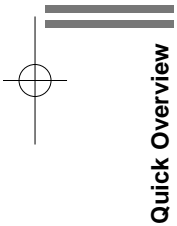
**Quick Overview**

Special playback

E

These can only be operated from the wireless controller (38).

Frame Advance

To play back frame by frame, press the +/  button repeatedly during playback pause.
Press and hold to play back continuous frame advance.

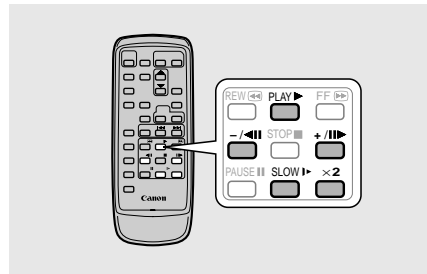

Frame Reverse

To play back in reverse frame by frame, press the -/  button repeatedly during playback pause.
Press and hold to play back continuous frame reverse.

Slow Forward Playback

To play back at about 1/5 normal speed, press the SLOW M button during normal playback.

Press the PLAY  button to return to normal playback.

- The camera automatically returns to playback after about 30 seconds of slow playback.

Slow Reverse Playback

To play back in reverse at about 1/5 normal speed, press the -/  button and then the SLOW M button during normal playback.

Press PLAY  to return to normal playback.

- The camera automatically returns to $\times 1$ reverse playback after about 30 seconds of slow playback.

Reverse Playback

To play back in reverse at normal speed, press the -/  button during normal forward playback.

Press the PLAY  button to return to normal forward playback.

Forward $\times 2$ Playback

Press the $\times 2$ button during normal playback.

Press the PLAY  button to return to normal playback.

Reverse $\times 2$ Playback

Press the -/  button and then the $\times 2$ button during normal playback.

Press the PLAY  button to return to normal playback.



- Mosaic-like noise appears on the screen during some of the special playback modes.
- There's no audio during special playback.

Connections for Playback on a TV Screen

E

You can connect the camera to a TV or VCR in order to play back your recordings. You will need to attach a power source to the camera (11). Power off all devices before starting the connections.

See your TV or VCR instruction manual for further details.

If your TV (or VCR) has an S (S1) -video input terminal

For higher picture quality, we recommend playing back recordings on a TV with an S (S1) terminal. If you connect the camera to a TV with an S1 terminal or the Video ID-1 system, recordings made in the 16:9 mode for wide screen TVs will automatically play back in wide screen mode on the TV screen.

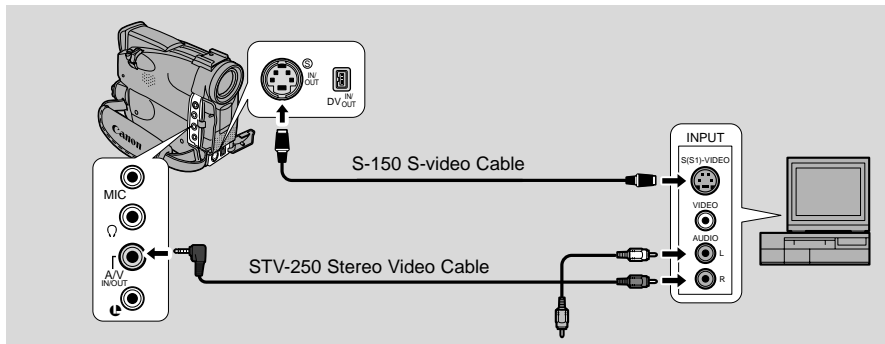

Quick Overview

- Use the S-150 S-video Cable to connect the S-video terminals. Use the STV-250 Stereo Video Cable to connect the AUDIO terminals. Connect the white plug to the white AUDIO terminal **L** (left). Connect the red plug to the red AUDIO terminal **R** (right). Do not connect the yellow plug.
- If you are connecting the camera to a TV, set the TV/VIDEO selector on the television to VIDEO.
- If you are connecting the camera to a VCR, set the input selector on the VCR to LINE.

If your TV (or VCR) has audio/video input terminals

E

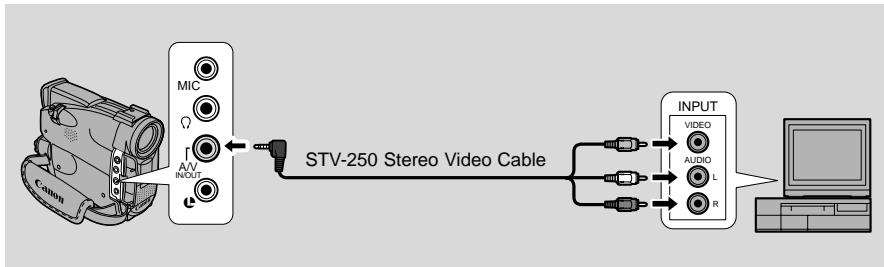

- Connect the camera using the STV-250 Stereo Video Cable. Connect the white plug to the white audio terminal **L** (left). Connect the red plug to the red audio terminal **R** (right). Connect the yellow plug to the yellow video terminal **VIDEO**.
- If you are connecting the camera to a TV, set the TV/VIDEO selector on the television to VIDEO.
- If you are connecting the camera to a VCR, set the input selector on the VCR to LINE.



- If you are going to use the TV as a monitor while you are shooting, remember to keep the TV volume turned down as long as the camera's audio terminals are connected. If the sound from the TV speakers is picked up by the microphone, an unpleasant high-pitched squeal, called feedback, may be produced.
- For TVs having the Video ID-1 system:
If you connect the camera to the TV's S terminal or video in terminal, recordings made in the 16:9 mode for wide screen TVs will automatically play back in wide screen mode on the TV screen.

Quick Overview

Tips for Making Better Videos

E

Holding the camera

For maximum stability, grip the camera in your right hand and keep your right elbow pressed against your body. If necessary support the camera with your left hand. With practice, you will be able to operate the controls by touch, without taking your eye off the action.

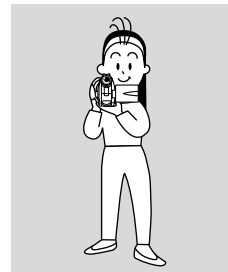

Using a tripod

To prevent any unwanted movement, you can mount the camera on a tripod, (or any flat surface at a suitable height) and operate it with the wireless controller.

- When you are using a tripod, be careful not to leave the viewfinder exposed to bright sunlight or it may melt. (The light is concentrated by the viewfinder lens.)
- Make sure that the fastening screw of the tripod is no longer than $\frac{1}{4}$ inch (5.5 mm), or it will damage the camera.

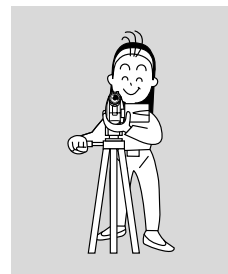

Quick Overview

Composition

The most important element in the scene does not have to be in the center. For a more interesting picture, try to position your subject so it is slightly to one side. Leave some space on the side of the frame that the subject is facing or moving towards.

Don't cut off the top of the subject's head, and don't cut people off at the neck, hips or knees (move a little bit above or below).

Watch out for distracting objects in the background.

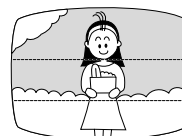

Picture angle

Instead of zooming while recording, try to choose your picture angle before you begin. A good way to tell a story with video is to begin with a long shot that establishes the situation, and then move in with medium shots and close-ups to show the details. Remember to change your viewpoint for each shot.

Remember that any camera movement or change in picture angle should have a definite purpose. Avoid unnecessary or half-hearted movements.



Long shot



Medium shot



Close-up

E

Camera moves

Use pans to record a landscape or follow a moving subject. Decide the area you want to cover and stand facing the end of your panning angle. Without moving your feet, turn your waist to the starting position. Start recording, and after a few seconds begin to turn slowly from the waist. Hold the final image for a few seconds before you stop recording.

Tilt the camera up to exaggerate the height of the subject. Tilt down from the top of a building, for example, as an introduction to subjects at the bottom.

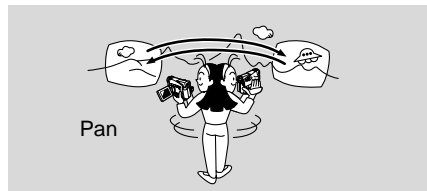

Pan

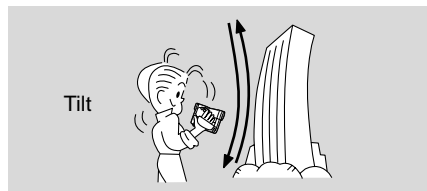

Tilt

Quick Overview

Turning the Image Stabilizer Off

E

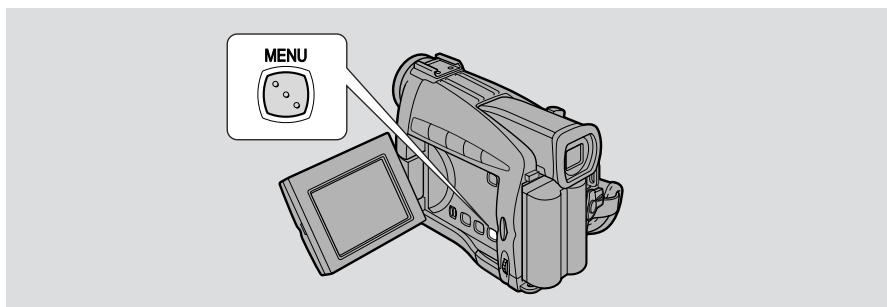

With most camcorders, even the slightest hand movements will be noticeable during telephoto recording. However, the ZR10's image stabilizer allows you to obtain steady recordings even at high magnification.



1. To turn the image stabilizer off, open the camera menu and point the arrow at IMAGE S. ().

2. Select the OFF setting and close the menu.

- The () mark disappears from the display when the stabilizer is off.
- The image stabilizer cannot be turned off when the program selector is set to the □ (Easy Recording) position.



- The image stabilizer is designed to deal with a normal degree of camera shake.
- Keep the image stabilizer turned off when the camera is mounted on a tripod.
- The image stabilizer is not as effective as usual when the tele-converter (optional) is attached.

Using the Full
Range of Features

Selecting from the Menus

Many of the camera's advanced functions are selected from menus which appear in the display. Availability of items in the menus depends on the mode the camera is set to. Unavailable items appear in purple.

E

There are two main menus:

1. **Camera menu (when the POWER switch is set to CAMERA)**
2. **VCR menu (when the POWER switch is set to VCR)**

Camera menu (CAM. MENU)

①	Shutter speed.....	63
②	Digital zoom	22
③	Image stabilizer.....	34
④	16:9 effect	20
⑤	White balance	66
⑥	Wireless controller	39
⑦	Record mode.....	20
⑧	Beep	21
⑨	Wind screen	59
⑩	Audio mode	58
⑪	Brightness	24
⑫	Mirror mode.....	25
⑬	TV Screen.....	103
⑭	Date/time display	43
⑮	Time zone/ Daylight saving time.....	41
⑯	Date/time set.....	43

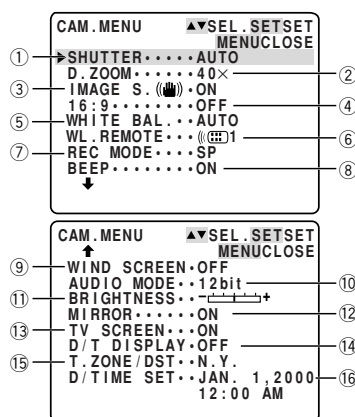

Using the Full
Range of Features

E

VCR menu

- | | | |
|---|--------------------------|-----|
| ① | Wireless controller..... | 39 |
| ② | Record mode..... | 20 |
| ③ | Data code..... | 69 |
| ④ | Date/time select..... | 68 |
| ⑤ | Brightness..... | 24 |
| ⑥ | Displays..... | 103 |
| ⑦ | 6-second auto date..... | 70 |
| ⑧ | Output channel..... | 85 |
| ⑨ | Audio dubbing..... | 82 |
| ⑩ | Wind screen..... | 59 |
| ⑪ | Audio mode..... | 58 |
| ⑫ | Beep..... | 21 |

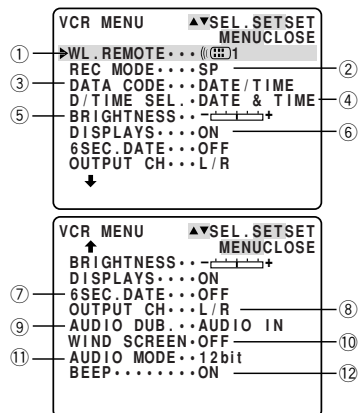

Turn to the appropriate page for a detailed explanation of each function.

Using the Full
Range of Features

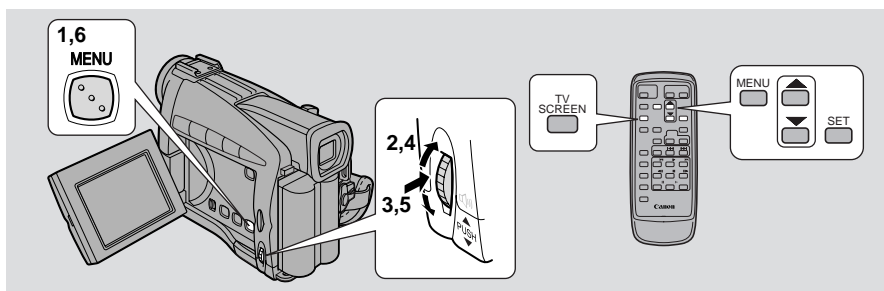

1. Press the MENU button to open the menu.
2. Turn the selector dial to move the arrow up or down the display.
3. Press the selector dial in to select your chosen option from the menu.
 - Your selected option remains on the screen and all other options are removed.
4. Turn the selector dial up or down to choose its setting.
5. Press the selector dial in.
 - However, if you are setting anything other than the white balance or the shutter speed, you can skip this step.
6. Press the MENU button to close the menu.



- You can only see eight options on the screen at one time. Pointers at the top/bottom of the screen indicate that there are more options that you can scroll through.
- You may often find it convenient to use the wireless controller to move around the menus. Press its MENU button to enter/leave the menu and use the arrow keys in place of turning the selector dial. Push the SET button to select.
- Pressing the start/stop button or the PHOTO button will close the menu and start recording.
- You can display the menus on a connected TV screen by turning TV SCREEN on through the camera menu or using the wireless controller's TV SCREEN button. See p. 30 for TV hookup instructions.

A grey rectangular box containing the letter 'E' in a white square.Three thick horizontal lines stacked vertically.







Using the Full
Range of Features

Using the Wireless Controller

E

The supplied wireless controller can operate the camera from a distance of up to 16 feet (5 m). Point it at the camera's remote sensor while you press the buttons.

There are seven functions that cannot be operated without the wireless controller:

- Special playback ( 29)
- Photo/date search ( 71)
- Zero set memory ( 72)
- Audio mix ( 84)
- A/V insert ( 78)
- Audio dubbing ( 81)
- Data code ( 68)

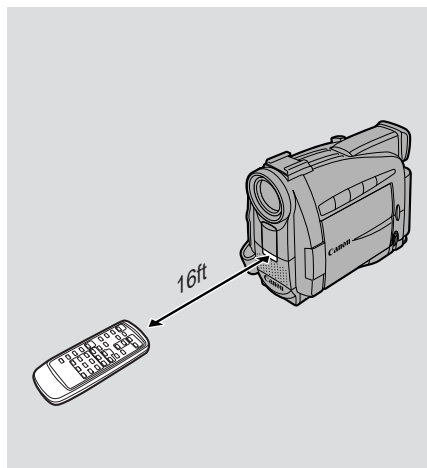

Inserting batteries

Insert two AA batteries, following the \oplus and \ominus markings. Be careful not to reverse the polarity of the batteries.

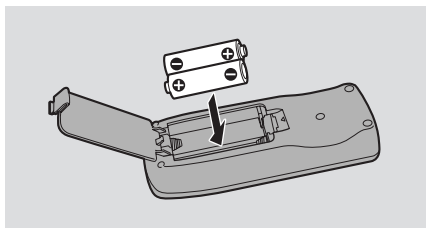

Using the Full
Range of Features



- When using the wireless controller in brightly lit places or outdoors, the effective range will be less.
- The camera may have difficulty picking up the remote control signals at extremely close range.
- Do not leave the controller exposed to direct sunlight, or in hot or humid places.
- When the batteries run out, replace them both together.
- If the wireless controller doesn't work, see p. 40.

Setting the remote sensor mode

To prevent interference from other Canon wireless controllers being used nearby, there are two remote sensor modes and an off setting. The wireless controller and the camera have to be set to the same mode in order to be compatible.

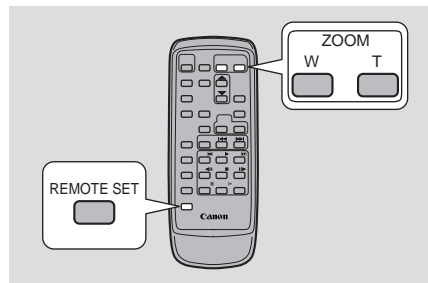

The wireless controller and the camera have been preset to mode 1. If you change the mode on the camera, be sure to change the mode on the wireless controller to the same mode.

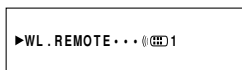

Ⓜ 1 : Mode 1
 Ⓜ 2 : Mode 2
 OFF Ⓜ : Sensor off

To turn the remote sensor off:

1. **Open either the camera or the VCR menu and select WL. REMOTE.**
2. **Choose OFF Ⓜ and close the menu.**
 - Ⓜ appears in the display.

To change the mode...
 ...on the camera:

1. **Open either the camera or the VCR menu and select WL. REMOTE.**
2. **Choose Ⓜ 1 or Ⓜ 2 and close the menu.**
 - The selected mode will appear on the display for four seconds.

...on the wireless controller:

Press and hold the REMOTE SET button on the wireless controller. Simultaneously press the ZOOM W button for mode 1 or the ZOOM T button for mode 2. Continue to press simultaneously for over two seconds.

- Be sure to set the wireless controller to the same mode as the camera.

E

Using the Full
 Range of Features

E**If your wireless controller isn't working:**

Make sure the camera and the wireless controller are both set to the same mode. Check the mode the camera is set to by pushing any button other than the REMOTE SET button on the wireless controller. The camera's mode appears in purple for about four seconds. Set the wireless controller's mode accordingly by pressing the aforementioned button combinations. If the wireless controller still doesn't work, change the batteries.



- The mode the camera is set to also appears for four seconds when you turn the power on.



Using the Full
Range of Features

Setting the Date and Time

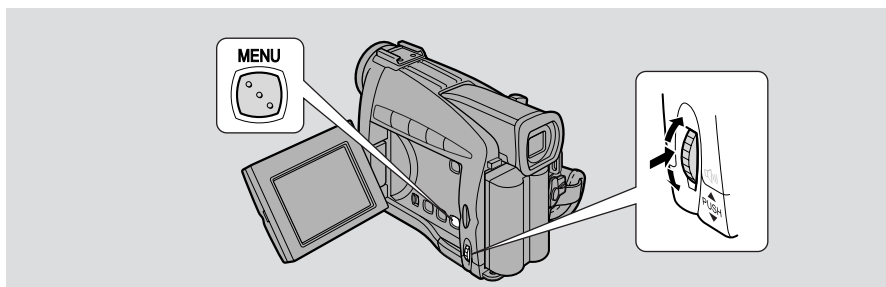

E

The date and/or time display forms part of the data code. You can choose to display or hide it during playback (68).

Set the date and time display when you first start using your camera. Install the backup battery before you begin (90).

- Before you start setting the date and time, select your home time zone from the menu.

Setting the time zone/daylight saving time

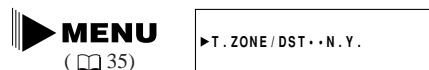

- 1. Set the camera to record pause mode.**
 - PAUSE appears in the display.
- 2. Open the menu and move the arrow to T. ZONE/DST with the selector dial.**
- 3. Press the selector dial in.**
 - The time zone display appears on the screen.
 - Your camcorder's time zone is factory-preset to New York. If you are at another time zone, select your time zone first and daylight saving time (DST) setting if necessary.
- 4. Move up or down the list of time zones by turning the selector dial. Press the selector dial in to select the option that represents your time zone.**
 - If you are now in daylight saving time, select the time zone with the daylight saving time mark  next to the area.
- 5. Press the MENU button.**

Using the Full
Range of Features

E

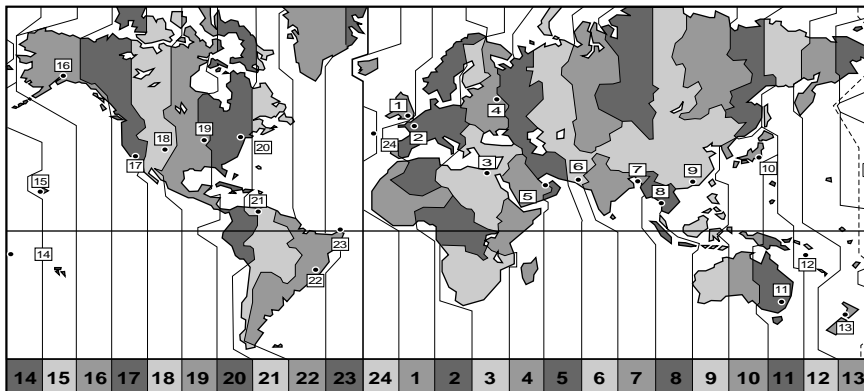

No.	Time zone	No.	Time zone
1	LONDON	13	WELLGTN (Wellington)
2	PARIS	14	SAMOA
3	CAIRO	15	HONOLU (Honolulu)
4	MOSCOW	16	ANCHOR (Anchorage)
5	DUBAI	17	L.A. (Los Angeles)
6	KARACHI	18	DENVER
7	DACCA	19	CHICAGO
8	BANGKOK	20	N.Y. (New York)
9	H. KONG (Hong Kong)	21	CARACAS
10	TOKYO	22	RIO (Rio de Janeiro)
11	SYDNEY	23	FERNAN. (Fernando de Noronha)
12	SOLOMON	24	AZORES

Using the Full Range of Features



- After you have selected your time zone and set the date and time, when you travel to another time zone, there is no need to reset the date and time. Just set the time zone to your destination and the camera's clock will automatically change to display the correct time for your destination.
- The camera automatically accounts for the number of days in a month and leap year.

Setting the clock

E

After you set the date and time, the date/time and home time zone will be displayed for about four seconds each time you turn the power on.



1. **Set the camera to record pause mode.**
2. **Open the menu and select D/TIME SET.**
 - The year display starts to flash.
3. **Turn the selector dial up and down to change the year. Press the dial in to move to another part of the display.**
 - Once you move from the year, the next part of the display starts flashing.
4. **Set the month, day, hours, and minutes in the same way.**
5. **Press the MENU button when finished, and to start the clock.**

- The date can be set to any year between 2000 and 2050.
- If you press the MENU button in the middle of setting the date and time, you leave the menu, and the clock starts.
- If you press the selector dial in after setting the minutes you can set the date and time again from the start.

Date and time display

You can choose to display or hide the date and time display during recording. When the date and time display is set to ON, the date and time show in the lower left-hand corner of the display but the time zone disappears in about four seconds. The large, four-second display will no longer appear when you turn on the power. It is not recorded onto your tape.



1. **Set the camera to record pause mode.**
2. **Open the menu and select D/T DISPLAY.**
3. **Select ON and close the menu.**

Using the Full
Range of Features

Taking Still Pictures

E

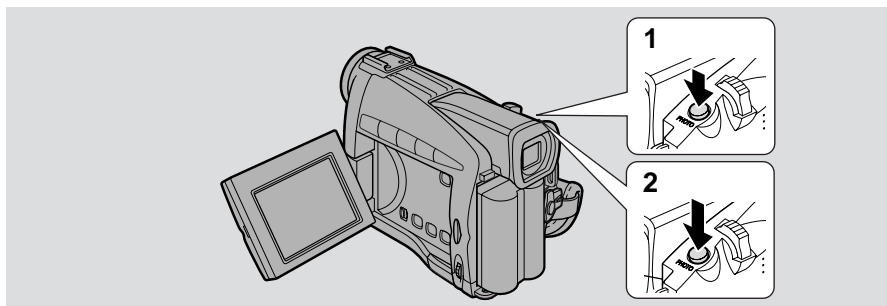

You can record still pictures like a photograph. The camera records the picture and sound to tape for approximately 6 seconds. The exposure is automatically adjusted.

Take still photos that you can record onto a floppy disk with the optional Floppy Disk Still Image Recorder FR-100 (46) and transfer to a PC for image enhancement and printout. Also, starting your shooting with a still photo makes it easy to find the beginning again later with the Photo Search function (71).

Take still pictures from the body of the camera or from the wireless controller. You can take a still picture at any time during regular video recording, or you can put the camcorder into record pause mode first, then take a still picture.

During record mode

Press the PHOTO button fully down and the still picture will be taken immediately.

- The camera takes the image immediately, and then records the “photo” to the tape for approximately six seconds. During this time the camera also records the sound, and the display shows the still picture.
- A counter display appears, and counts up to six seconds as the camcorder records the picture.

During record pause mode

1. Press the PHOTO button halfway down and hold it:

- “PHOTO” flashes at the bottom right of display.
- Exposure is locked the instant the PHOTO button is pressed halfway down.
- During autofocus ● flashes white in the display as the camcorder adjusts the focus and it is displayed continuously as a green mark when the camera is ready to take the still picture.
- If the subject is unsuitable for autofocus (96), the camera may not be able to focus, and ● may continue to flash white in the display. Adjust the focus manually with the selector dial.
- If you are using manual focus (65), the ● mark starts as a continuous green mark. Focus with the selector dial.

Using the Full
Range of Features

2. Press the PHOTO button fully down to take the still picture.

- The camera takes the image immediately, and then records the “photo” to the tape for approximately six seconds. During this time the camera also records the sound, and the display shows the still picture.
- A counter display appears, and counts up to six seconds as the camcorder records the picture. ● disappears from the display.



- While the camera records the still, you cannot use the camera functions (controls, POWER switch/zoom lever, etc., do not respond until recording is complete). This applies even when you haven't loaded a cassette.
- The wireless controller's PHOTO button has no half-way setting. Press the button fully and the camera immediately takes the “photo”.
- Only take “photos” where it is bright enough to see the image in the display.
- If you want to use an effect, make sure you set it before you take your picture.

**E**
Using the Full
Range of Features

Transferring Still Pictures to a PC with the FR-100 (optional)

E

The FR-100 captures images taken with the camera, compressing them in JPEG format and recording them as still images onto a floppy disk.

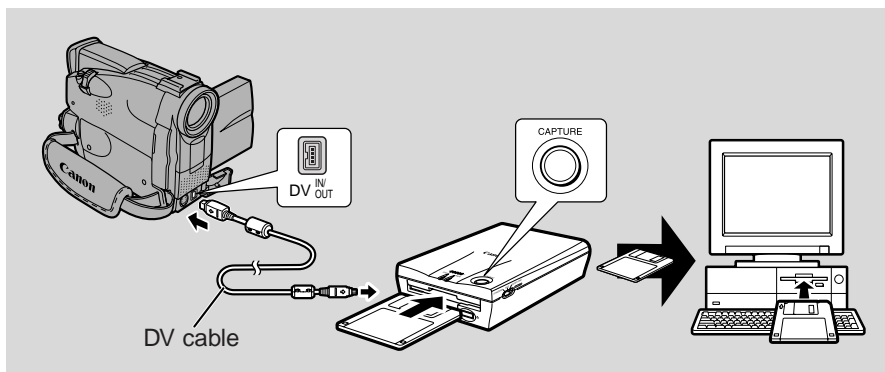

1. Connect the power sources for the camera and the FR-100.
2. Turn the camera's POWER switch to VCR, and connect the camera and the FR-100 with the DV cable (supplied with the FR-100).
3. Insert a floppy disk into the FR-100.
4. Play back your cassette in the camera and search for the image you want to capture. Find exactly the frame you want by using frame advance/reverse ( 29).
5. Press the FR-100's CAPTURE button to record the image onto the floppy disk.
6. After you have finished recording images, remove the floppy disk and insert it into your PC's disk drive.



- For full details of how to use the FR-100, refer to its instruction manual.

Using the Full
Range of Features

Searching and Reviewing While Recording

Record search

When the camera is in record pause mode, you can use record search to play the tape forwards or backwards to find the point where you want to start or resume recording. This is useful when you want to add a new scene to a previously used cassette. By using record search, you can ensure a smooth, noise-free join between the new scene and the old one.

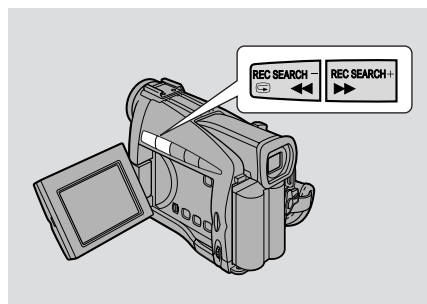

E

- 1. Make sure the camera is in record pause mode.**
- 2. Press and hold the REC SEARCH + or – button on the camera while you check the picture in the display.**
 - The + button plays the recording forwards and the – button plays it backwards.
- 3. Release the button when you find the point where you want to start recording.**
 - The camera returns to record pause mode.

Record review

When the camera is in record pause mode, you can use record review to play back the last few seconds of your recording and then return automatically to record pause mode. You can quickly make sure that a scene has recorded properly and then go on to shoot the next scene, without producing any noise in the picture.

- 1. Make sure the camera is in record pause mode.**
- 2. Press and release the  (record review) button while you check the picture in the display.**
 - The camera rewinds the tape, plays back the last few seconds, and returns to record pause mode.



- Noise may appear on the screen when you play the tape backwards.



Using the Full
Range of Features

Using the Various Recording Programs

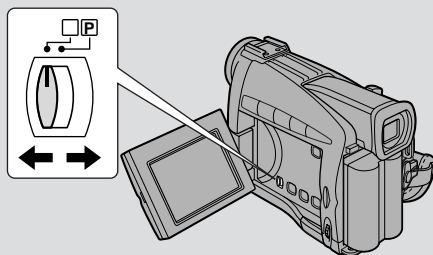
E





The camera provides you with a choice of seven recording programs. They use different combinations of camera settings in order to adjust the exposure and other functions to match the recording situation.

- For simple point-and-shoot operation, select the Easy Recording program. Slide the program selector to the □ position.
- For normal shooting conditions, slide the program selector to  (program AE) mode. Open the program menu and select AUTO ( 49).
- For various other recording conditions, the camera has five more specialized AE (auto exposure) programs.

Availability of functions in each recording program

Using the Full Range of Features

Position of program selector							
Recording Program	□ (Easy Recording)	Auto	Sports	Portrait	Spotlight	Sand & Snow	Low Light
Shutter Speed	A	h	A				
Focus		h					
Exposure		h					
White balance		h					
Image stabilizer (ON/OFF)		ON	h				OFF
Digital effects	i	h					
16:9	i	h					

h : Available i : Not available A : Automatic function only

Setting the program AE mode

E

1. Set the camera to record pause mode.
2. Slide the program selector to **P** (program AE) mode.
3. Push the selector dial in to display the program menu.
4. Turn the selector dial to move the arrow up or down the display.
5. Push the selector dial in to select the desired program.
 - The program will appear in the display.
6. Press the start/stop button to begin recording.



- The name of your selected recording program appears constantly on the left of the display, with the exception of Auto, which is displayed and then disappears after 4 seconds.
- Avoid changing programs during recording as the brightness of the image may change suddenly.
- The specialized AE programs are not suitable for all kinds of lighting. The image may flicker, or a bright line may appear on the screen if you use them in the wrong lighting conditions.
- If you switch the camera from the program to the **P** program, the camera returns to the Auto program.



Using the Full
Range of Features

E

Easy Recording

The simplest way to use the camera is with the program selector set to the [] position. The camera will take care of focus, exposure and other adjustments, leaving you free to point and shoot.



Auto

This is the same as the Easy Recording program, except that you now have the option of using any of the camera's manual functions.



Sports

This program is useful for recording high-speed sports scenes in brightly lit conditions. Normal playback will be slightly jerky, but you will get clear images which can be analyzed frame by frame during slow or paused playback.



Portrait

Use this program outdoors to make subjects stand out from a softened foreground and background. It works well for still-lives and close-ups. The effect is most noticeable when the zoom position is between the middle range and the telephoto end. Focus manually for maximum accuracy, and be careful when recording action scenes, as this program may cause fast moving objects to shudder.



Using the Full
Range of Features

Spotlight

This program is designed for recording spotlight scenes, such as on a stage. The exposure is automatically adjusted for glare-free recordings of subjects lit by a concentrated light source.

SPOTLIGHT



E

Sand & Snow

Use this program in places where the background is so bright that the subject appears underexposed in the display — a sunny beach or ski resort, for example. You may notice some shudder when recording moving subjects.

SAND&SNOW



Low Light

This program allows you to record in dimly lit places. It is generally best used for close-ups of slow or stationary subjects, as moving subjects may leave a trailing after-image. However, you can take advantage of this to create special effects, by rapid zooming or by panning along with a moving subject. Picture quality will not be as good as in normal lighting conditions, and autofocus may not work as well as usual.

LOW LIGHT



Using the Full
Range of Features

Using Digital Effects

E

Use the camera's 2 types of digital effects for more interesting productions.

- **Faders:** Start or end scenes with a fade to or from black (☐ 54).
Fade Trigger, Vertical Wipe, Horizontal Wipe, Mosaic Fade
- **Effects:** Add flavor to your recordings (☐ 55).
Art, Black and White, Sepia, Mosaic



Availability of digital effects in CAMERA mode

Recording Program		<input type="checkbox"/> (Easy Recording)		<input checked="" type="checkbox"/> (Program AE)	
		MOVIE	PHOTO	MOVIE	PHOTO
Faders	FADE-T	i		h	i
	WIPE II				
Effects	WIPE =	i		h	
	M. FADE				
	ART				
	BLK&WHT				
	SEPIA	i		h	
	MOSAIC				

h : Available i : Not available

Using the Full
Range of Features

Availability of digital effects in VCR playback modes

		Playback	Reverse Playback	Still picture playback	Slow forward/reverse playback	Forward/reverse ×2 playback
Faders	FADE-T WIPE  WIPE  M. FADE	h (Press PAUSE to fade out)	Set only	h (Press PLAY or PAUSE to fade in)	Set only	
Effects	ART BLK&WHT SEPIA MOSAIC	h				

h : Available



- When you do not want to use digital effects, press the DIGITAL EFFECTS button and select D.EFFECT | from the digital effects menu. Press the DIGITAL EFFECTS button to close the menu.
- The camera remembers your chosen digital effect setting until you change it.
- Digital effects cannot be operated on a blank blue screen (appears during playback). The display continues to flash.
- Digital effects operated during VCR mode are not recorded onto the original tape.
- Digital effects can be added to another tape when dubbing using the A/V out terminal (VCR mode), but not the DV out terminal.
- You cannot operate digital effects while photo/date searching.
- If you slide the program selector to (Easy Recording) while the digital effect display is flashing, it will disappear from the display and reappear when you return to (program AE) mode.
- The digital effect display will flash for two seconds after setting, even if DISPLAYS is set to OFF in the VCR menu.





Using the Full
Range of Features

E

● Faders

Fade Trigger (FADE-T)

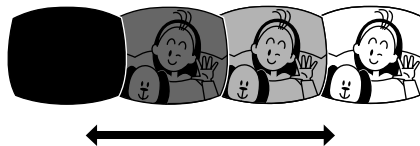
When you start recording, the scene gradually fades in from a black screen. When you stop recording, it gradually fades out.



Vertical Wipe (WIPE II)

When you start recording, the picture begins as a thin vertical line in the center of the screen which gradually expands sideways until it fills the whole of the screen. When you end a scene, the image is wiped from both sides of the screen.

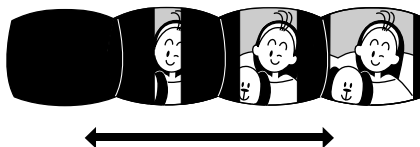

Horizontal Wipe (WIPE =)

When you start recording, the picture begins as a thin horizontal line in the center of the screen which gradually expands upwards and downwards until it fills the whole screen. When you end a scene, the image is wiped from the top and bottom of screen.

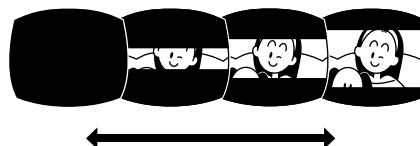

Mosaic Fade (M. FADE)

Blurs the image by enlarging the size of some pixels. The image appears as increasingly large squares of color as it fades out, and smaller squares when it fades in.

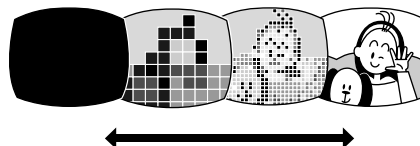

Using the Full
Range of Features

● Effects

Art (ART)

Adds a paint-like effect, called solarization, to the image.

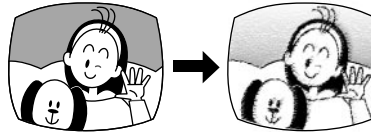

E

Black and White (BLK & WHT)

Records the image in black and white.

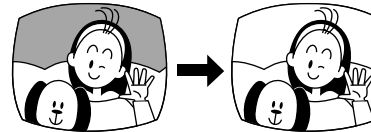

Sepia (SEPIA)

Records a monochrome image with a brownish tint.

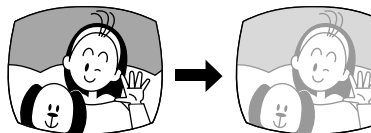

Mosaic (MOSAIC)

Blurs the image by enlarging the size of some pixels.

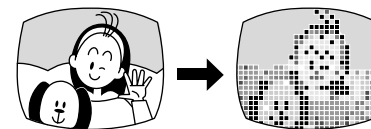

Using the Full
Range of Features

E

Digital effects can be set with the controls on the body of the camera or the wireless controller. Pressing the ▲/▼ buttons on the wireless controller correspond to turning the selector dial up and down, and pressing the SET button corresponds to pressing the selector dial in.

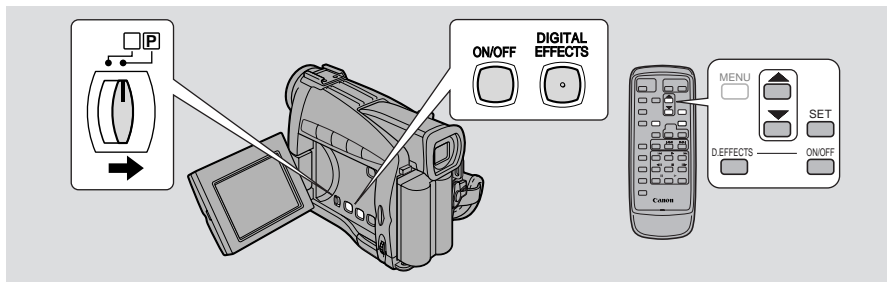

Operating faders

Sound and image fade together.

When operating faders while recording, make sure the program selector is set to **P**.

Set fader

1. **Press the DIGITAL EFFECTS button to open the digital effects menu.**
2. **Move the arrow up and down with the selector dial.**
 - Point the arrow at FADER.
3. **Press the selector dial in.**
 - FADE-T, WIPE II, WIPE =, M.FADE settings appear.
4. **Turn the selector dial.**
 - Point the arrow at your selected setting.
5. **Press the DIGITAL EFFECTS button.**
 - The menu disappears and the name of your selected setting flashes in the display.

Fader on/off

6. **Press the ON/OFF button.**
 - The name of your selection stops flashing.
 - Each time you press the ON/OFF button, the chosen fader is activated (display lights continuously) or deactivated (display flashes).
7. **If you're in camera mode:**
 - Fade in-** Press the start/stop button.
 - Fade out-** Press the start/stop button.
- If you're in VCR mode:**
 - Fade in-** Press the ► (play) button.
 - Fade out-** Press the || (pause) button.

Operating effects

E

Sound records/plays back normally.

When operating effects while recording, make sure the program selector is set to **P**.

Set effect

- 1. Press the DIGITAL EFFECTS button to open the digital effects menu.**
- 2. Move the arrow up and down with the selector dial.**
 - Point the arrow at EFFECT.
- 3. Press the selector dial in.**
 - ART, BLK&WHT, SEPIA and MOSAIC settings appear.
- 4. Turn the selector dial.**
 - Point the arrow at your selected setting.
- 5. Press the DIGITAL EFFECTS button.**
 - The menu disappears and the name of your selected setting flashes in the display.

Effect on/off

- 6. If you're playing back, press the ► (play) button.**
- 7. Press the ON/OFF button.**
 - The name of your selection stops flashing and takes effect on the display.
 - Each time you press the ON/OFF button, the chosen effect is activated or deactivated.



Using the Full
Range of Features

Audio Recording

E

Selecting the audio mode

ZR10 can record sound in two audio modes — 16-bit and 12-bit. The 16-bit mode produces the higher sound quality (slightly superior to CD) while the 12-bit mode records on two channels (stereo 1), leaving two channels free (stereo 2) for you to add new sound at a later date.



1. To switch to the 16-bit mode, open the menu and select **AUDIO MODE**.
2. Select **“16 bit”** and close the menu.
 - “16 bit” is shown in the display for approximately four seconds.



- For details on adding new sound, see p. 81.
- For details of playing back a tape that has new sound on stereo 2, see p. 84.
- When you record to the ZR10 from a camcorder with DV terminal outputs, the audio mode display becomes set to “---”.

External microphone

Using the Full
Range of Features

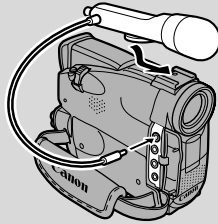

For greater creative control over audio recording, you can connect an external microphone to the camera via the MIC terminal. When using the MIC terminal, use a microphone with a built-in power supply (condenser microphone). It is possible to connect almost any stereo microphone with a plug diameter of $\frac{1}{8}$ inch (3.5 mm), however, their audio levels will be different from that of the built-in microphone.

1. Slide the microphone onto the accessory shoe.
2. Connect the microphone to the MIC terminal.



- Use the Microphone Boom MB-100 (optional) to keep long microphones out of the frame.
- You can monitor the sound while recording by attaching stereo headphones to the  terminal.

E

Wind screen

The camera has an automatic wind screen to prevent wind noise from interfering with the sound track. Make sure it's off when you want the microphone to be as sensitive as possible. Use the wind screen when recording in windy places such as the beach or near buildings.



1. Open the camera menu and point the arrow at **WIND SCREEN**.
2. Select the **ON** setting and close the menu.
 - WS **ON** is shown in the display.



- The wind screen can be used for audio dubbing with the built-in microphone as well as recording.
- The wind screen does not operate with an external microphone. The WIND SCREEN menu options disappear (“– –”) when an external microphone is connected to the MIC terminal.



Using the Full
Range of Features

Setting the Self-Timer

E

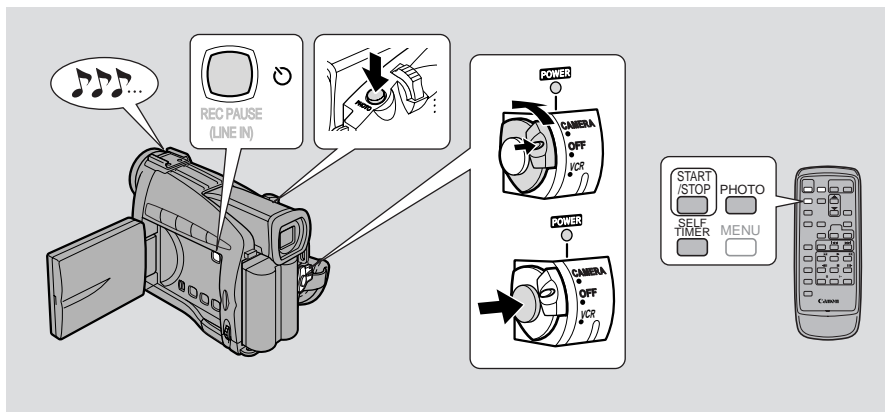

This is useful when you want to include yourself in the picture when recording movies or still photographs.

For movie

1. Set the camera to record pause mode.
2. Press the  self-timer button on the body of the camera
or
the **SELF TIMER** button on the wireless controller.



- SELF T. appears in the display.
- To have the subject monitor recording, rotate the LCD panel 180° ( 25).

3. Press the start/stop button.



- The camera starts to record after a 10-second countdown period (or after two seconds when you use the wireless controller). The time remaining counts down in the display (e.g. "5 SEC").
- SELF T. disappears from the display when recording begins.

4. Press the start/stop button to end recording.



- When taking a still photo, set the self-timer and press a PHOTO button on the camera body or the wireless controller. The camera automatically adjusts the focus two seconds before the countdown is complete. The  mark flashes white then turns green after the focus and exposure are set. If you are using the wireless controller, the  mark starts flashing immediately after you press the PHOTO button. The camcorder takes the picture for approximately six seconds then automatically goes into record pause mode.

Using the Full Range of Features

- To cancel the self-timer before the countdown has begun, press the  SELF TIMER button.
- To cancel the self-timer once the countdown has begun, press the  SELF TIMER button, start/stop if you're shooting movies, or PHOTO if you're taking a still photograph.



E



Using the Full
Range of Features

Adjusting Exposure Manually

E

Exposure lock

When you are recording in situations where the lighting may change suddenly, you can lock the exposure at the current level in order to control the brightness of the image.

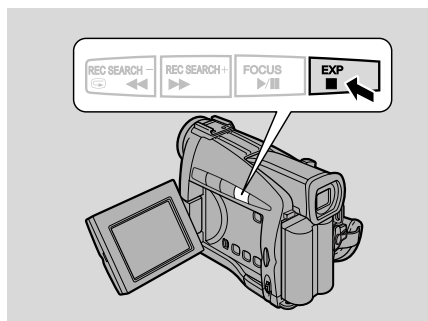

To lock the exposure, press the EXP button. Press it again to return to auto exposure.

Exposure adjustment

When the exposure is locked, you can adjust it manually, making the picture brighter or darker in order to deal with difficult lighting conditions. The camera's iris can be manually set to any position from fully closed to fully open.

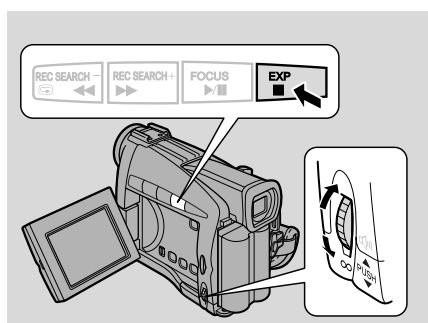

Using the Full
Range of Features

To make the recorded image brighter, turn the selector dial upwards (to a maximum of +11). This may be necessary if the background is very bright, or if the subject is lit from behind.

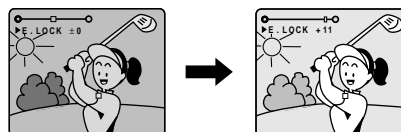

To make the recorded image darker, turn the selector dial downwards (to a minimum of -11). This may be necessary if the background is very dark, or if the subject is spotlighted.

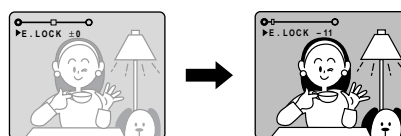



- You cannot adjust the exposure without the ► mark before E.LOCK in the display. Push the EXP button so that ► appears before E.LOCK. Then you can adjust the exposure manually.
- The standard exposure level depends on which recording program you have selected.
- Exposure lock is canceled if you change recording programs.
- You cannot use exposure lock or adjustment when the program selector is set to the □ (Easy Recording) position.
- If you zoom while the exposure is locked, the brightness of the scene may change.

E

Shutter speed

Set the shutter speed manually to take stable shots of quickly moving subjects.



MENU

(35)

► SHUTTER AUTO

1. Make sure the camera is set to record pause mode in the **P** (program AE) mode.
2. Press the selector dial in and choose AUTO from the program menu.
3. Open the camera menu and select SHUTTER.
4. Press the selector dial in to select the desired shutter speed.

AUTO		
1/60	↑	slower
1/100		
1/250		
1/500		
1/1000		
1/2000		
1/4000		
1/8000	↓	faster

5. Close the menu.

- The camera returns to the auto shutter setting when you slide the program selector to □ (Easy Recording), or change the recording program.

Using the Full
Range of Features

E**Concerning shooting in fluorescent lighting**

When the camera is set to (Easy Recording) mode or auto mode, it automatically detects the flicker of fluorescent lighting and adjusts the shutter speed to compensate. However, if the brightness of the LCD or viewfinder display starts to flicker, make sure the camera is set to the Auto recording program and select the 1/100 shutter speed.

Guidelines for shooting using high shutter speeds

- When shooting with a shutter speed of 1/1000 or higher, do not shoot the sun directly.

Recommended shutter speeds when shooting:

- People doing outdoor sports such as golf or tennis



1/2000 or 1/4000
(or 1/8000 to freeze
the action even more
clearly)

- Moving cars or trains or other rapidly moving vehicles such as roller coasters



1/1000, 1/500 or
1/250

- People doing indoor sports such as basketball



1/100

Using the Full
Range of Features



- You are unable to set the shutter speed when exposure lock is set in any recording program other than AUTO. The SHUTTER display becomes set to “_ _ _ .”
- The image may not appear smooth when a high shutter speed is set.

Adjusting Focus Manually

The camera can focus automatically. All you have to do is point it, and whatever is in the center of the display will usually be in sharp focus. If it does not seem to be focusing well, it may be because the subject is not suitable for autofocus.

E

You can use the manual focusing function for more control over focusing.

Focus lock

Press the FOCUS button to turn off autofocus. The focus remains locked at the point set by autofocus.

(▶M.FOCUS appears in the display.)

You can now adjust the focus manually with the selector dial. Press the FOCUS button again when you want to return to autofocus.

- If you zoom in on your subject after turning off autofocus, it may not stay in focus. It is generally best to adjust the zoom first, and then the focus.

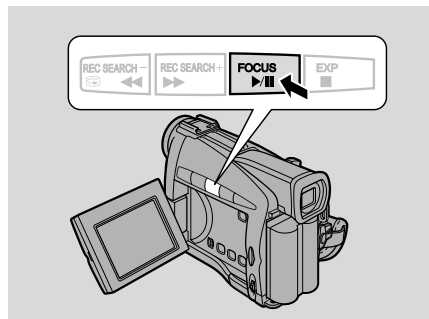

Manual focus

Use the selector dial to set the focus.

- Turn the selector dial downward to move the focus farther away.
- Turn the selector dial upwards to bring the focus nearer.

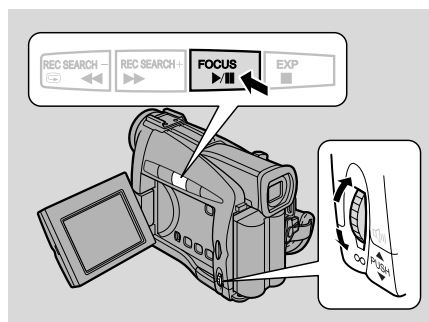

Using the Full
Range of Features





- You cannot adjust the focus without the ▶ mark before M.FOCUS in the display. Push the FOCUS button so that ▶ appears before M.FOCUS. Then you can adjust the focus manually.
- The manual focus setting is canceled if you select the [(Easy Recording) program.
- When you are using the [(Easy Recording) program, autofocus cannot be turned off.
- See “Troubleshooting” on p. 95 for a list of subjects which may not be suitable for autofocus.

Setting the White Balance

E



The camera's auto white balance system compensates for a wide range of lighting conditions. Although slight variations are unavoidable, colors will appear natural in virtually every situation.

In some cases, you will get better results by setting the white balance yourself, or using one of the two preset modes:

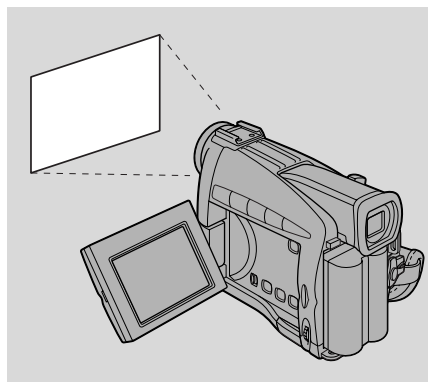
-  Indoor Mode
 - Under halogen or studio/video lighting
 - Subject is of one dominant color
 - Close ups
-  Outdoor mode
 - In daylight, especially for close-ups and where the subject is of one dominant color



Using the Full Range of Features

1. Make sure the camera is set to record pause mode in the **P** (program AE) mode.
2. Open the camera menu and point the arrow at **WHITE BAL.**
3. a) For the indoor, outdoor or auto settings, press the selector dial in to choose the setting.
 -  appears in the display when you set the white balance to indoor/outdoor mode.
- b) To set the white balance yourself, point the camera at a white object (such as a sheet of paper) and zoom in until it fills the display. Then press the selector dial in to select **SET**.
 - The  display flashes then remains lit.
 - Depending on the light source, the flashing may at times continue. The result will remain better than with the auto setting and you can continue recording.
4. Close the menu.

Setting the white balance manually will probably work better than auto white balance when shooting:

Subjects with one dominant color, such as sky, sea or forest



Close-ups



In rapidly changing lighting conditions



In places lit by certain types of fluorescent or mercury vapor lights



- Turn the digital zoom off (if necessary) to set a more accurate white balance.
- If you have set the white balance and lighting conditions change, reset the white balance.
- Try to record with light from a single source. Correct white balance cannot be obtained for two types of lighting at once.
- You cannot set the white balance or choose the indoor/outdoor mode when the program selector is set to the (Easy Recording) program.
- The white balance returns to the AUTO setting when you slide the program selector to (Easy Recording).
- When you turn the camera on, the white balance returns to AUTO. If you then switch the white balance to SET, the camera will remember your last setting.
- During normal outdoor shooting, setting to AUTO may provide better results.

E

Using the Full
Range of Features

Displaying Date, Time and Camera Data (Data Code)

E

A data code, containing the date and time the recording was made and other camera data (shutter speed and exposure settings) is automatically recorded on a special data section of the tape.

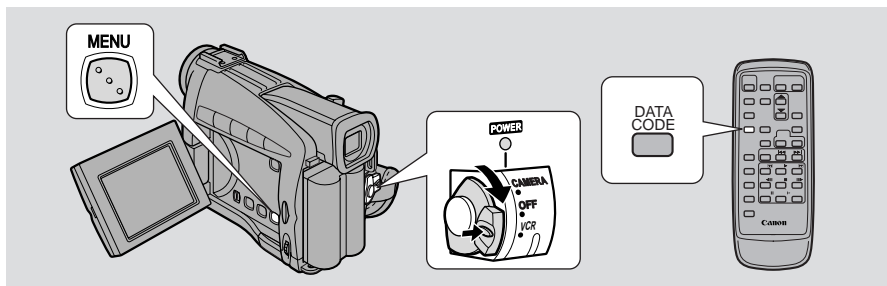

During VCR mode, the data code can be displayed or hidden while the camera is in play, slow or still mode.

Camera data may be displayed as “- - -” during fast forward, rewind, reverse playback, forward and reverse $\times 2$ playback.

Press the **DATA CODE** button on the wireless controller.

- Press it once to display, once more to hide it.

Selecting date/time

Using the Full
Range of Features

Select whether you want the date, the time, or both to show up on your data code display (69).

MENU
(36)

▶D/TIME SEL..DATE & TIME

1. Turn the **POWER** switch to **VCR**.
2. Open the menu and select **D/TIME SEL**.
3. Choose between **DATE**, **TIME** and **DATE & TIME**.
4. Press the **MENU** button to close the menu.

Setting the data code

E

You can also choose which type of data code to display — either the date/time, camera data or both.



1. Select **DATA CODE** from the **VCR** menu.
2. Choose between **DATE/TIME**, **CAMERA DATA** and **CAM. & D/T**.
3. Press the **MENU** button once more to close the menu.

Possible data code combinations:

DATA CODE D/TIME SEL.	Date/Time	Camera data	Date/Time & Camera data
Date	JAN. 1, 2000	F32 1/2000	F32 1/2000 JAN. 1, 2000
Time	12:00:00 AM	F32 1/2000	F32 1/2000 12:00:00 AM
Date & Time	12:00 AM JAN. 1, 2000	F32 1/2000	F32 1/2000 12:00 AM JAN. 1, 2000



- The data code will read “-- --” in the following situations:
 - During playback of a blank section of tape.
 - If the tape was recorded before entering the date and time in the camera’s memory.
 - If the tape was recorded on a camera without a data code function.
 - If noise or tape damage prevents the data code from being read.
- If a recording made on ZR10 is played back on a different DV camcorder, the data code may not be displayed correctly.
- The data code will appear in the display even if **DISPLAYS** (103) has been set to **OFF** through the **VCR** menu.

Using the Full
Range of Features

E**Six-second auto date**

The six-second auto date appears for six seconds to mark the changeover of a day if the tape was being recorded at 12:00 midnight. It also appears for six seconds when you start playback and have the data code turned off. The six-second auto date will adjust for any time zone changes you have indicated.

**MENU**

(36)

▶ 6SEC. DATE...OFF

You can turn the six-second auto date on:

1. Turn the **POWER** switch to **VCR**.
2. Open the menu and select **6SEC.DATE**.
3. Select **ON** and close the menu.



- When 6SEC.DATE is turned on but DISPLAYS (103) is turned off, the six-second auto date will still appear for six seconds.



Using the Full
Range of Features

Searching the Tape (Photo Search/Date Search)

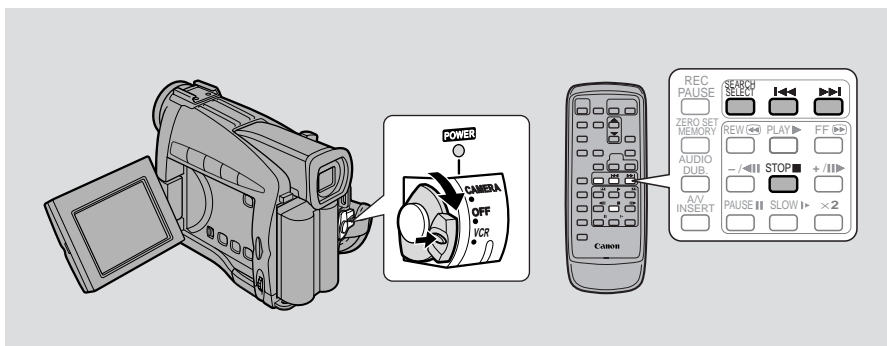

E

This allows you to move quickly through still pictures recorded anywhere on a tape (photo search) or between different days or areas of recording (date search).

- You can only use this function from the wireless controller.

1. Turn the POWER switch to VCR.

2. Press the SEARCH SELECT button to choose between photo/date search.

- PHOTO SEARCH or DATE SEARCH is shown in the display for four seconds.

3. Press the ◀◀ and ▶▶ buttons to move backwards or forwards through the still pictures or between different days of recording.

- Press once to move to the start of the previous/next still picture or day on the tape.
- You can press more than once to move to the corresponding still picture or day (up to a maximum of ten times), e.g. press the ▶▶ button five times to move forward five still pictures or days.
- PHOTO SEARCH/DATE SEARCH appears in the middle of the display alongside the ◀◀ or ▶▶ mark and number to search through. The recording mode is also shown (SP/LP).



- Press ■ (stop) to stop mid-search.
- If you begin a search very close to the start of a recorded still picture during photo search, the camera may skip straight past it.
- When you have set the area for the World Clock, date search also looks for the change in date based on the adjusted time.
- A date/area cannot be identified if the total recording time on that day/area was less than one minute.
- Date search playback may start just before or after the beginning of the located section.
- If the data code is not displayed correctly you will not be able to operate the date search correctly.

Using the Full
Range of Features

Returning to a Pre-Marked Position

E

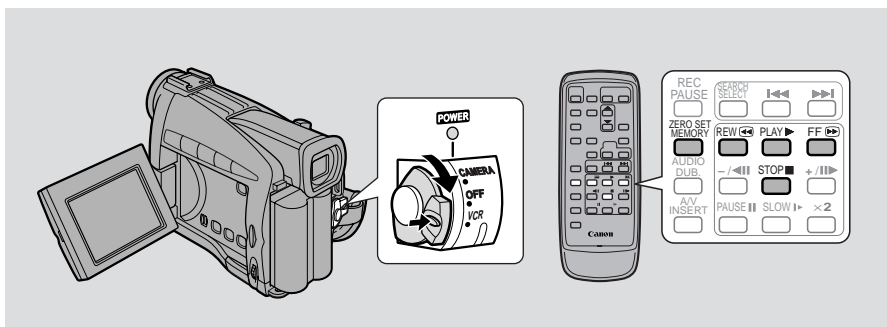

Use the wireless controller to mark a point on a tape that you want to return to following playback.

1. Press the ZERO SET MEMORY button on the wireless controller during playback at a point you want to return to later.

- The time code is replaced by a tape counter that is set to zero with the **M** indication.
- Press the ZERO SET MEMORY button once more to cancel the zero set memory.

2. When you have finished playback, fast forward or rewind the tape. The tape stops automatically when it reaches the zero set position.

- **RTN▶▶** or **◀◀RTN** appears in the display.
- The tape counter with **M** indication disappears from the display and the time code reappears.



- The zero set memory may not function correctly where there is a break between recordings on the tape.
- You can also use zero set memory to mark a position on a tape in camera mode. When you then play back the tape, pressing rewind will take you back to the pre-marked position.
- If you remove the tape while the zero set memory is set, the memory is canceled and the tape counter reverts to time code.
- The camera remembers your setting even if you turn it off and back on again or move the program selector.

Using the Full
Range of Features

Editing to a VCR

By connecting the camera to another VCR, you can edit your recordings in order to remove unwanted scenes — or combine different shots to create your own video productions.

E

Preparations

- 1. Connect the camera to the VCR.**
 - See “Connections for Playback on a TV Screen” on p. 30.
- 2. Prepare the TV and VCR.**
 - Turn on the TV and set the TV/VIDEO selector to VIDEO.
 - Turn on the VCR, and set its input selector to LINE. Load a blank cassette, and put the VCR in record pause mode.
 - See your TV and VCR instruction manuals for details.
- 3. Turn the camera’s POWER switch to VCR, and load your recorded cassette.**

Editing

- 1. Find a point on your recorded cassette slightly before the section you want to copy.**
- 2. Start to play it back while you monitor the picture on the TV.**
- 3. Start recording on the VCR as soon as the section you want to copy appears on the screen.**
- 4. Pause the VCR at the end of the section you want to copy, then stop playback on the camera.**
- 5. Repeat steps 1 to 4 until your edited recording is complete.**





- The quality of the edited tape will be slightly lower than that of the original.

(LANC) terminal

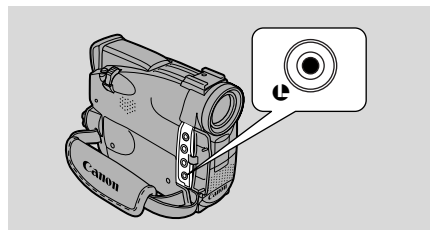
The  terminal allows you to connect the camera to equipment. Some buttons on editing equipment may operate differently from those on the camera.



-  (LANC) is a trademark. It stands for Local Application Control Bus System.
- We cannot guarantee the results when connecting to equipment not bearing the LANC  symbol.



Editing

Dubbing with Digital Video Equipment

E

Digital video equipment fitted with the DV terminal lets you edit, copy and transfer data digitally, with virtually no generation loss in image and sound quality. The DV terminal is for both line-in and line-out, since a single DV cable can handle data in both directions.

- If a digital VCR is connected and an anomalous signal is sent from the VCR, the images recorded on the tape may also be anomalous (although it may not appear so on the TV image), or not recorded at all.
- You are unable to dub tapes recorded with the copyright protective signal.

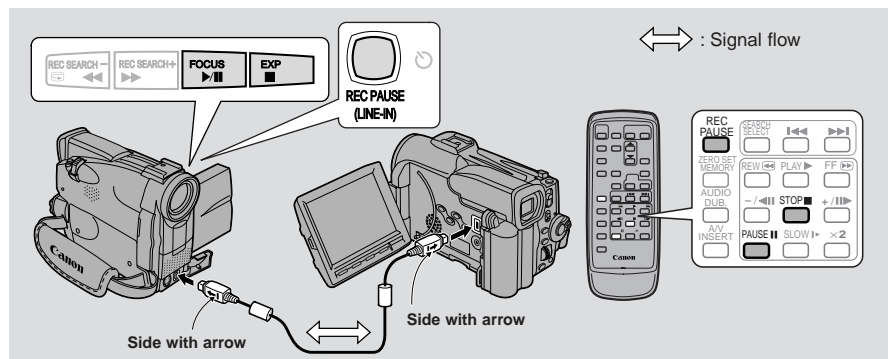

Preparations

- 1. Connect the camera and the other digital device.**
 - Connect the Canon CV-150F DV cable (optional) with the sides of the plugs marked with the arrows facing as shown above.
- 2. Prepare the other device.**
 - Turn on the power and load a recorded cassette.
- 3. Turn the camera's POWER switch to VCR and load a blank cassette.**
 - DV IN appears in the display.

Editing

Dubbing

E

Operate from the controls on the body of the camera or the wireless controller.

Example dubbing to the camera

1. **Find a point on your recorded cassette slightly before the section you want to copy and set it to playback pause mode.**
2. **Press the camera's REC PAUSE button.**
 - The camera enters record pause mode.
3. **Start playback on the other digital device while you monitor the picture.**
4. **Press the pause button.**
 - Recording starts.
5. **When you get to the point where you want to stop recording, press the stop button or the pause button.**
 - Recording stops.
6. **Stop playback on the other device.**



- If the cable is not connected properly, or if the cable is unconnected when you press REC PAUSE, the camera displays the caution "CHECK THE DV INPUT." An anomalous image may also flash onto the screen.
- Blanks between recordings on the playback tape are recorded as anomalous images on the tape that is being recorded to.
- During DV dubbing you cannot add digital effects or faders.

Copyright signal

Certain pre-recorded software tapes are copyright protected. If you try to play back such a cassette, "COPYRIGHT PROTECTED PLAYBACK IS RESTRICTED" appears in the display for a few seconds and then the camera displays a blank blue screen; you cannot view the contents of the cassette. If you try to record from such a tape via the digital cable "COPYRIGHT PROTECTED DUBBING RESTRICTED" appears in the display; you cannot record the contents of the tape.

Editing

Recording from a VCR, TV or Analog Camcorder (Analog Line-in)

E

You can record a TV program or a video played on your VCR or analog camcorder (for digital camcorders, see p. 74) onto a tape in the ZR10, if the TV or other device has audio/video outputs.

- If an anomalous signal is sent from the TV or VCR, the images recorded on the tape may also be anomalous (although it may not appear so on the TV image), or not recorded at all.
- You are unable to dub tapes recorded with the copyright protective signal.

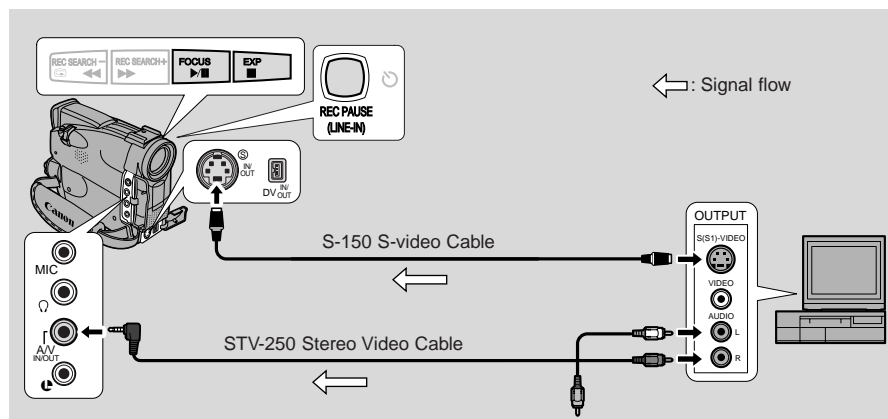

Preparations

1. **Connect the camera to the VCR, TV or other camcorder.**
2. **Prepare the TV and VCR.**
 - Set the TV/Video selector on the television to Video. For further details, see “Connections for Playback on a TV Screen” on p. 30.
 - Turn on the VCR. Load your recorded cassette, and put the VCR in playback pause mode.
 - See your TV and VCR instruction manuals for details.
3. **Turn the camera’s POWER switch to VCR, and load a blank cassette.**

Editing

Dubbing

E

Operate from either the body of the camera or the wireless controller.

- 1. Find a point on your recorded cassette slightly before the section you want to copy and set it to playback pause mode.**
- 2. Press the REC PAUSE button.**
 - S-video and A/V IN/OUT terminals automatically work as input terminals.
 - The camera enters record pause mode.
- 3. Start playback on the other device while you monitor the picture.**
- 4. Press the pause button.**
 - Recording starts.
- 5. When you get to the point where you want to stop recording, press the stop button or the pause button.**
 - Recording stops.
- 6. Stop playback on the other device.**





- You can monitor the picture in the viewfinder or LCD.



Editing

Recording Over Existing Scenes (AV Insert Editing)

E

You can insert new scenes from your VCR or other camcorder onto your pre-recorded tape using the ZR10's analog line-in ( 76) or DV in ( 74) terminals. Original video and audio will be replaced with the new video and audio.

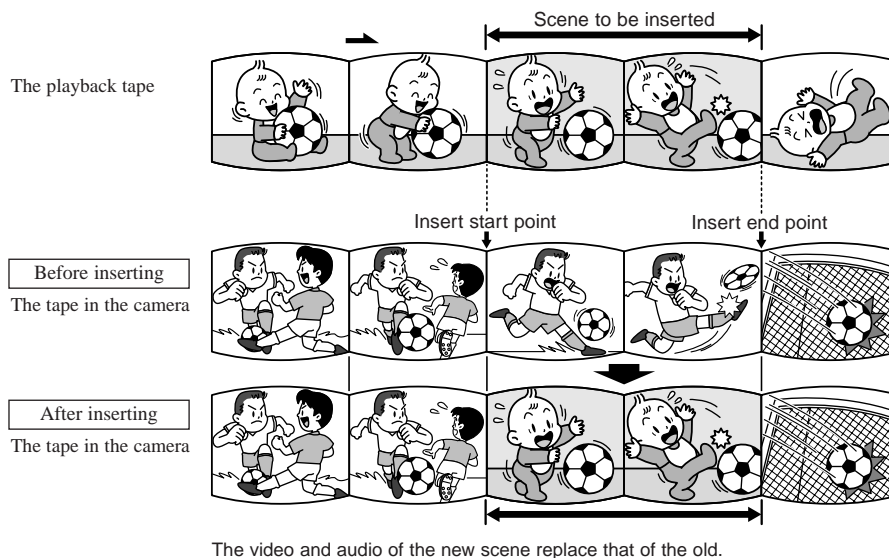
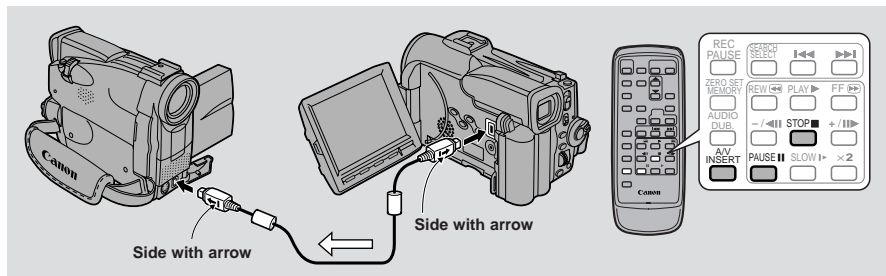
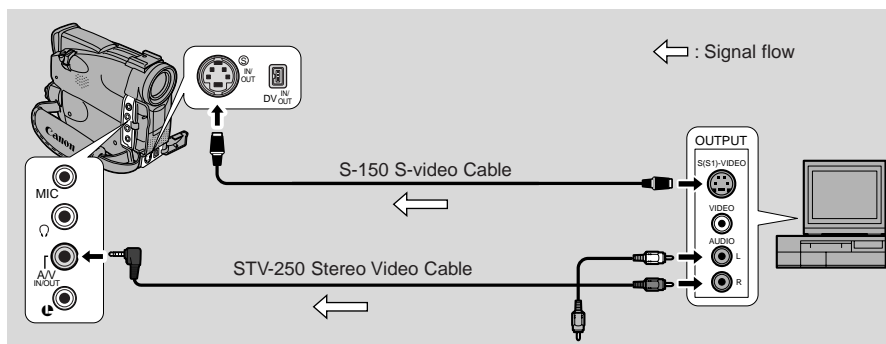
Editing

Preparations

E

The tape in the camera:

When using the ZR10's A/V insert function, only record to tapes recorded in SP mode with continuously recorded time codes.

If there are non-recorded portions or portions recorded in LP mode on the tape, recording will stop.

The playback tape:

Use only tapes without non-recorded portions.

If there are non-recorded portions or changes in the recording mode, you may not be able to insert A/V correctly.

You cannot insert A/V in the following cases:

- The playback tape has been poorly recorded.
- During special playback: fast forward playback, rewind playback or slow playback etc. (analog only).

TV:

You cannot insert A/V from a TV program with anomalous synchronized signals, such as when the program itself received poor signals.

Example recording from a VCR

1. Connect the camera to the VCR/TV.

2. Prepare the TV and VCR.

- Set the TV/Video selector on the television to Video. For further details, see "Connections for Playback on a TV Screen" on p. 30.
- Turn on the VCR and load a recorded cassette.
- See your TV and VCR instruction manuals for details.

3. Turn the camera's POWER switch to VCR and load a recorded cassette.

- Make sure the REC/SAVE tab on the cassette has been slid to REC (closed position).



E**Editing**

Use the wireless controller to operate A/V insert.

- 1. On the VCR, locate a point three seconds before the scene to be inserted. Set the VCR to playback pause mode.**
- 2. On the camera, press PLAY and locate the recording start point. Set the camera to playback pause mode.**
 - You can use the playback buttons on the body of the camera or the special playback functions on the wireless controller in the same way as in playback mode.
- 3. Press the A/V INSERT button.**
 - A/V INSERT and ●|| appear in the display.
- 4. Play back the cassette in the VCR.**
- 5. To start inserting, press the PAUSE button on the camera.**
 - ●|| changes to ●.
- 6. To stop inserting, press the STOP button on the camera.**
 - Inserting stops and A/V INSERT disappears from the display. The camera returns to stop mode.
 - If instead of pressing STOP you press PAUSE, the camera returns to the A/V insert pause mode.
 - If you set the zero set memory at the position on the tape where you want to stop inserting, every time you return to that point, the camera will cancel its A/V inserting and enter stop mode.
- 7. Stop playback on the VCR.**

Audio Dubbing

You can add sound to the original sound on a prerecorded tape from audio products (AUDIO IN) or with the internal or external microphone (MIC. IN). The original sound will not be erased. For best results, add sound to tapes that have been recorded with this camera in SP mode with 12-bit sound. If there are non-recorded portions on the tape, or portions recorded in LP mode, or with 16-bit or 12-bit, 4-channel sound, dubbing will stop. If your tape hasn't been recorded in SP mode with 12-bit sound, we recommend dubbing your original tape onto a blank tape using the ZR10's analog line-in function, then dubbing audio onto the new tape. Make absolutely sure to set the audio mode of the new tape to 12-bit and the recording mode to SP.

E

To connect other audio equipment:

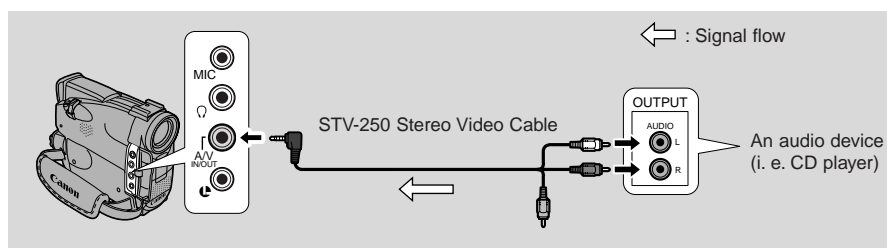

- Do not use the yellow video terminal.
- The A/V terminal doesn't put out any video, so connect the S-video terminals and check your TV, or check the LCD or the viewfinder as you add new sound. Always check the new sound with the speaker or the headphones.

To connect an external microphone:

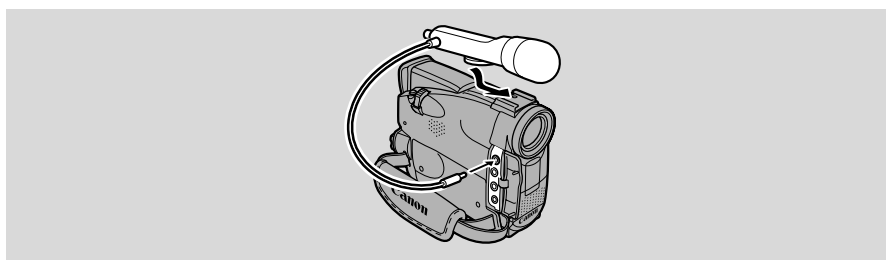

- When you add sound using the built-in microphone make sure not to connect any cables to the MIC terminal.
- To use your TV to monitor video, connect the S-video terminal or the A/V terminal (use only the video plug) to your TV. You can monitor the sound with headphones.



Editing

E

Preparations

Turn the camera's POWER switch to VCR and load a recorded cassette.

- Make sure the REC/SAVE tab on the cassette has been slid to REC (closed position).

Dubbing

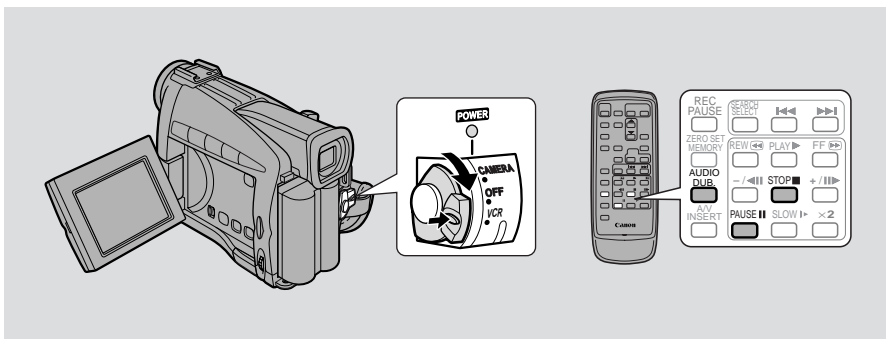



Use the wireless controller when dubbing audio.

Do not connect/disconnect any cables to/from the camera when dubbing audio or preparing to dub audio.



▶AUDIO DUB...AUDIO IN

Editing

1. **Open the VCR menu, select AUDIO DUB.**
2. **Select AUDIO IN or MIC. IN and close the menu.**
3. **Locate the point where you want to start audio dubbing, then press the PAUSE button.**
 - You can use the playback buttons on the body of the camera or the special playback functions on the wireless controller in the same way as in playback mode.
 - The camera becomes set to playback pause mode.
4. **Press AUDIO DUB.**
 - AUDIO DUB. and  appear on the display.
5. **Press the PAUSE button (and start play on the other audio device if AUDIO IN).**
 - Audio dubbing starts.
 - If MIC. IN, direct your voice into the microphone.
 -  changes to .

6. When you get to the point where you want to stop dubbing, press the STOP button (and then stop play on the other audio device if AUDIO IN).

- Audio dubbing stops and AUDIO DUB. disappears from the display.
- The camera returns to stop mode.
- You can also set zero set memory ( 72) at the place you want to stop audio dubbing, then every time you return to that position, audio dubbing will cancel.
- If instead of pressing STOP you press PAUSE, the camera will return to the playback pause mode.



- You can not use the DV terminal while adding sound.
- You might want to adjust the audio mix ( 84) when playing back a tape with added sound.
- There may be a loss of sound quality if you add sound to a tape recorded on a camcorder other than the ZR10.
- After adding sound three or more times to the same place on a tape, there may be some loss in sound quality.

**E**
Editing

Setting the Audio Mix

E

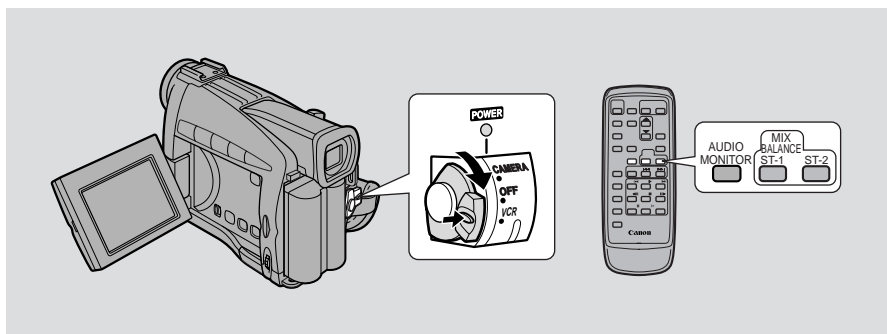

When you play back a tape that was recorded in 12-bit mode, you can set the audio output to play: stereo 1 (the original sound), stereo 2 (any new sound, dubbed to the tape after recording), or mix the balance between the two.

- Audio from the 16-bit mode only contains stereo 1 sound and so you cannot/do not need to select the audio mix. The same is true for the 12-bit stereo 1 mode, unless new sound has been added post-recording.
- You can choose the output using the wireless controller only.

1. Turn the **POWER** switch to **VCR**.

2. Choose the output.

- Press **AUDIO MONITOR** on the wireless controller.
- Starting with the last selected setting, four settings appear as you push the button:
 - **STEREO1** for just stereo 1.
 - **STEREO2** for just stereo 2.
 - **MIX/FIXED** for an equal mix of stereo 1 and 2.
 - **MIX/VARI.** (mix variable) for when you want to mix the balance between stereo 1 and 2.
- To simply choose **STEREO1**, **STEREO2** or **MIX/FIXED**, make sure your choice appears on the display.
- If you choose **MIX/VARI.**, you can go on to mix the balance.
- Use the **ST-1/ST-2** keys to mix the balance. A bar showing the mix appears on the screen for four seconds.



- When you have chosen the output, **STEREO1**, **STEREO2**, **MIX/FIXED** or **MIX/VARI.** is shown in the top left of the display for a few seconds. If you turn the power off the output is set to **STEREO1**.

Selecting audio output channels

E

When you play back a tape whose audio has been recorded on multiple channels, you can change the output channels of that sound.



1. Turn the **POWER** switch to **VCR**, load a tape recorded with **multiple-channel audio**.
2. Open the **VCR** menu and select **OUTPUT CH**.
3. Select the output channel.
 - Refer to the following list.

OUTPUT CH setting	Played back sound	
	Tape recorded with stereo sound	Tape recorded on multiple channels
L/R	L+R channels	main + sub
L/L	L channel only	main only
R/R	R channel only	sub only

Editing

Preparing the Camera

E

Adjust the viewfinder

- Turn the POWER on and set the camera to record pause mode. Extend the viewfinder straight out, then adjust the viewfinder focusing lever to suit your eyesight.
- Rotate the viewfinder to an angle that allows you to view comfortably. Store the camera with the viewfinder flush with the body of the camera.
- To view with the viewfinder, make sure the LCD panel is either turned so that the subject can monitor viewing, or totally closed with the screen facing inwards.

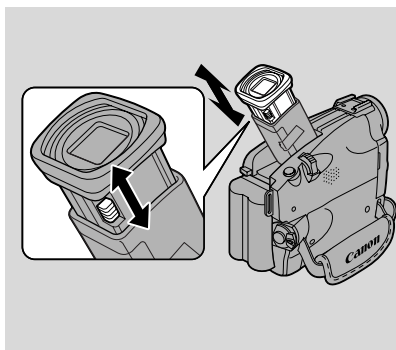

Prepare the lens cap

- Attach the cord to the lens cap, and pass the grip belt through the loop on the cord.
- Hook the lens cap on to the grip belt while you are recording, and place it over the lens when you have finished.

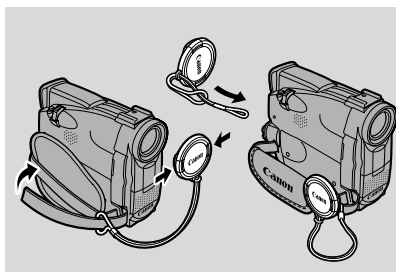

Fasten the grip belt

- Release the Velcro fastening and hold the camera with your right hand while you adjust the belt with your left. Your index finger should reach the zoom control and photo button, and your thumb should reach the start/stop button comfortably.

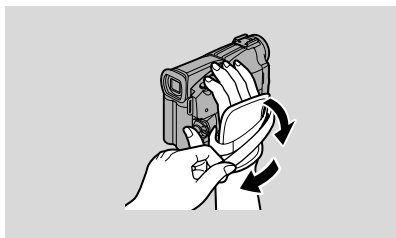
**Additional
Information**

Attach the shoulder strap

- For extra security and portability, attach the shoulder strap before using the camera.
- Pass the ends through the attachment bars and adjust the length as shown.

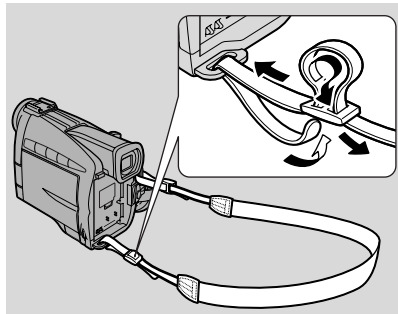
**E**

- Be careful not to leave the viewfinder exposed to bright sunlight, or it will melt. (The light is concentrated by the viewfinder lens.) Adjust the angle of the viewfinder to prevent sunlight from entering.

**Additional
Information**

Notes on Using the Batteries

E

Charging and recording times

- These times vary — the safest policy is always to have two or three times as many battery packs as you think you will need.
- You will get more recording time if you turn the camera off between shots, instead of leaving it in record pause mode.

Battery pack	BP-511	BP-522 (optional)
Time needed for full recharge	1 hr. 35 min.	2 hr. 35 min.
Maximum recording time	Using the viewfinder: 2 hr. 30 min. Using the LCD screen: 2 hr.	5 hr. 10 min. 4 hr. 5 min.

- Recording time will be shorter than usual at low temperatures. You can use the battery pack between 32° and 104°F (0° to 40°C), but it works best between 50° and 86°F (10° to 30°C).
- If the battery pack starts to give you much less recording time than usual, it has reached the end of its life and must be replaced.





- These figures show how long you can view playback with the LCD, after attaching a fully-charged battery pack. Playback time will be shortened at low temperatures.

Battery pack	Playback time (using the LCD screen)
BP-511	2 hr. 10 min.
BP-522	4 hr. 25 min.

How much power is left?

The indicator in the display shows you approximately how much charge the battery pack has left:

 100%

 75%

 50%

 25%

 0%

CHANGE THE BATTERY PACK

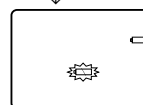

- “CHANGE THE BATTERY PACK” appears in the display for four seconds when the power is completely exhausted. The empty battery mark then appears and starts to flash. The power indicator light also flashes.
- The indicator is not constant — different levels will be shown when you subject the battery pack and camcorder to different conditions.

When to recharge

E

You can recharge a lithium ion battery pack whenever it is convenient. Unlike a conventional battery pack, it does not have to be fully discharged first. However, as the battery pack will naturally discharge itself over time, it is best to charge it the same day you plan to use it, or the day before.

Taking care of the battery pack

Always attach the terminal cover.

- Do not allow any metal objects to touch the terminals, as this can cause a short circuit and damage the battery pack. Attach the terminal cover whenever the battery pack is not being used.

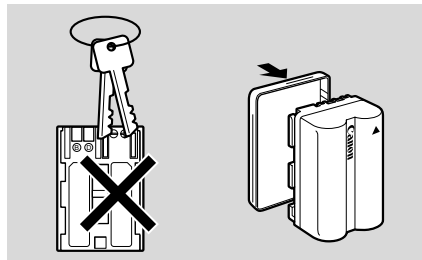

Keep the terminals clean.

- The camera, adapter or battery pack will not work properly if the terminals are dirty. Check them before use, and wipe them with a dry cloth or tissue if necessary.

Storing the battery pack

- If you do not use a battery pack for a period of more than a few months any remaining charge may cause damage to the battery pack, and reduce usage time. To prevent damage therefore, aim to use a battery pack's complete charge before storage. See the BP-511 and BP-522 instructions for further details.

Additional
Information

E**Installing the backup battery**

Open the backup battery cover on the battery attachment unit, and insert the CR2025 lithium battery with the + side facing outwards. Click the cover back into place.

This backup battery allows the camera to remember the date and time and other settings when main power source is removed. It has a life span of about a year.

When it needs replacing (or if it has not been installed), the γ mark flashes in the display. Remove the old battery by pushing up then releasing and lifting out. Make sure to attach a power source to the camera first, so it will remember your chosen settings when you change the battery.

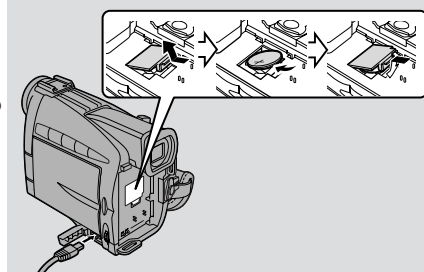
**DANGER!****Treat the battery pack with care.**

- Keep it away from fire (or it might explode).
- Do not expose the battery pack to temperatures greater than 140°F (60°C). Do not leave it near a heater, or inside a car in hot weather, for example.
- Do not try to disassemble or modify it.
- Do not drop or knock it.
- Do not get it wet.

WARNING!

- The battery used in this device may present a fire or chemical burn hazard if mistreated. Do not recharge, disassemble, heat above 212°F (100°C) or incinerate.
- Replace the battery with a Sony, Sanyo or Panasonic CR2025, or Duracell DL2025. Use of another battery may present a risk of fire or explosion.

**Additional
Information****Cautions:**

- Do not pick up the battery using tweezers or other metal tools — this will cause a short circuit.
- Wipe the battery with a clean, dry cloth to ensure proper contact.
- Keep the battery pack out of reach of children — if it is swallowed, contact a physician immediately, as the battery case may break down and the battery fluids damage the stomach and intestines.
- Do not disassemble, heat or immerse the battery in water, to avoid the risk of explosion.

Maintenance

Cautions

E**Avoid high temperatures and high humidity.**

- Do not leave the camera inside a car in hot weather, for example.
- Be careful of heat radiating from video lighting equipment.
- Do not take the camera into a humid room.

Avoid sudden changes in temperature.

- If you take the camera from a cold place to a warm place, condensation may form on the lens and internal parts ( 94).

Do not point the lens or viewfinder at strong light sources.

- Never point it at the sun, and do not leave it aimed at a bright subject.
- Be especially careful when leaving the camera on a tripod.

Avoid magnetic or electric fields.

- Do not use the camera close to TV transmitters, portable communication devices or other sources of electric or magnetic radiation. They may cause picture interference, or permanently damage the camera.

Do not expose the camera to water.

- Cover the camera when you are recording in rain or mist.
- There is a risk of electric shock if water gets inside the camera — contact qualified service personnel as soon as possible.

Protect the lens.

- Sand and dust can damage the lens — be especially careful on windy days.

Handle the camera gently.

- Vibration or shock can cause damage.
- Do not use the viewfinder or LCD panel as a carrying handle.

Do not disassemble the camera.

- This is very dangerous as there is a risk of electric shock — if the camera does not function properly, take it to qualified service personnel.

**Additional
Information**

E**Storage**

If you do not intend to use the camera for some time, store it in an area which is free of dust and moisture, and where the temperature is no higher than 86°F (30°C). After storage, check each part and function of your camera to make sure everything is still working properly.



- These cautions also apply to accessories such as battery packs and cassettes.

Maintenance**Viewfinder**

- Clean the viewfinder screen. Rotate the viewfinder upwards. Remove the viewfinder protect cover and clean by inserting a cotton swab. When finished, return it flush with the camera.
- The viewfinder screen scratches easily. Take care when cleaning.

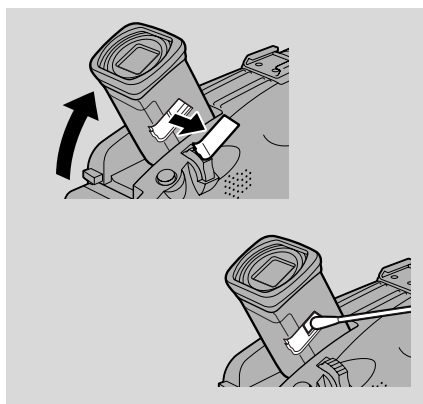
**LCD**

- Clean the LCD screen using a commercially available cleaning cloth for glasses.
- Where there is a big change in temperature, moisture may form on the surface of the screen. Wipe clean with a soft, dry cloth.
- At low temperatures the display may appear to be much darker than usual. This is not a fault, and as the screen warms up the display will return to normal.

Camera body and lens

- Use a soft, dry cloth to clean the camera body or lens. Never use chemically treated cloth or volatile solvents such as paint thinner.

Video heads

- When mosaic-like noise appears on the playback picture, the video heads may be dirty. When the video heads are badly contaminated, the camera may show a blank blue screen.
- For the best picture possible, after using the camera for approximately 20 hours, clean the video heads using Canon's DVM-CL Digital Video Head Cleaning Cassette. If the "noise" remains, repeat the cleaning (up to maximum of five times).
- Do not use a wet-type cleaning cassette, as this can cause damage.



Using the camera abroad

E

Power sources

- You can use the compact power adapter to operate your camera and charge battery packs in any country where the electricity supply is between 100 and 240 V AC, 50/60 Hz. Contact your Canon dealer for information about plug adapters for overseas use.

TV playback

- Although you can always play back your recordings on the LCD screen, your camera can only be connected to TVs which use its NTSC system. This TV system is used in the following countries:
American Samoa, Bahama, Barbados, Bermuda, Bolivia, Canada, Chile, Columbia, Costa Rica, Cuba, Ecuador, El Salvador, Guam, Guatemala, Greenland, Haiti, Honduras, Jamaica, Japan, Korea, Mexico, Micronesia, Myanmar, Nicaragua, Panama, Peru, Philippines, Puerto Rico, Saint Lucia, Surinam, Taiwan, Trinidad and Tobago, USA, Venezuela.

**Additional
Information**

E**Condensation**

Condensation may form on the camera when it is moved from a cold place to a warm place. Using the camera while condensation is present can damage both the tape and the camera.

Condensation may become a problem:

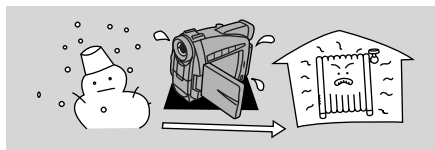

When you take the camera from a cold place to a warm room



When a cold room is heated rapidly

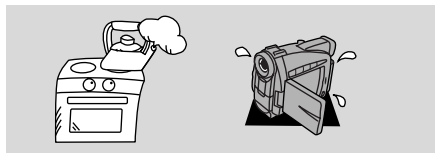

When the camera is left in a humid room

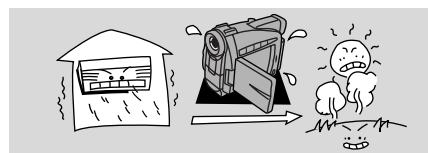



When the camera is taken from an air-conditioned room to a warm, humid place

Protecting the camera from condensation

- Before you take the camera to a warm or humid place where condensation is likely to be a problem, unload the cassette and put the camera in a plastic bag. Wait until the camera reaches room temperature before you take it out of the bag.

What happens when condensation is detected

- “CONDENSATION HAS BEEN DETECTED” is displayed for approximately four seconds. Then, the power indicator flashes and the  mark flashes in the display. If there is a cassette in the camera, it stops automatically and “REMOVE THE CASSETTE” is displayed for approximately four seconds and then  flashes in the display. If you have the beep turned on, it will sound.
- The camera may not detect the condensation immediately — the condensation warning may not start flashing for 10 to 15 minutes.
- You cannot load a cassette when condensation is detected.

What you should do

- Remove the cassette, leave the cassette compartment open, and turn the camera off.
- Leave it in a dry place until the condensation evaporates. After the condensation warning stops flashing, wait at least another hour before trying to use the camera.

Troubleshooting

Refer to this checklist first if you have any problems with your camcorder. Possible explanations are given for each problem on the list — turn to the page numbers in parentheses for more information.

E

Make sure that the camera is properly connected if you are using it with a TV or VCR. Consult your dealer or service outlet if problems persist.

Recording/Playback

Problem	Cause and/or what to do about it
<p>? Nothing happens when I press the buttons.</p>	<ul style="list-style-type: none"> • The camera is not switched on (18, 27). • The cassette is not loaded or is set for erasure prevention (16-17). • The tape has reached the end. • The power source is not properly connected, or the battery pack is exhausted or not properly attached (11-15, 88). • The function cannot be used in that recording program (48).
<p>? The camera turned itself off.</p>	<ul style="list-style-type: none"> • The camera was in record pause mode for more than about five minutes (18). • The battery pack is exhausted (12-13, 88).
<p>? The cassette compartment stopped mid-operation while loading/unloading a cassette.</p>	<ul style="list-style-type: none"> • The battery pack's power is exhausted. Recharge or change to a new battery pack (12).
<p>? The start/stop button doesn't work.</p>	<ul style="list-style-type: none"> • The cassette is not loaded or is set for erasure prevention (16-17). • The tape has reached the end.
<p>? There's no picture in the display.</p>	<ul style="list-style-type: none"> • The POWER switch is not set to CAMERA (18).
<p>? There's a blank blue screen in the display.</p>	<ul style="list-style-type: none"> • You are attempting to play back or record from a copyright protected cassette (75). • The video heads are badly contaminated (92).
<p>? The camera won't focus.</p>	<ul style="list-style-type: none"> • The camera is on manual focus (65). • The viewfinder lens needs adjusting (86). • The lens is dirty (92).

Additional
Information

E



- Some subjects are not suitable for autofocus. In these situations, you will often get better results using manual focus ( 65). Focus on something which is about the same distance away, lock the focus, and then point the camera at your original, hard-to-focus subject.



Horizontal stripes



Many subjects at different distances



Behind glass

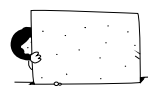

Without much contrast (e.g. a white wall)

Reflective surfaces
(e.g. shiny car surfaces)

Fast moving objects



Slanted subjects



Dark subjects





Night scenes

Recording/Playback (Contd.)

Problem

- ❓ **Some/all of the digital effects don't work.**
- ❓ **The ► (play) button doesn't work.**
- ❓ **There's a bright stripe on the screen.**

Cause and/or what to do about it

- There are a number of restrictions on using the digital effects. ( 52-57).
- The POWER switch is not set to VCR ( 27).
- The cassette is not loaded ( 16).
- The tape has reached the end.
- When recording in dark places a bright light in the scene may cause a vertical light bar ("smear") to appear. This is a normal feature of camcorders.



? The playback picture is rough (with mosaic-like noise).

? There's no picture on the TV screen, even though the tape is moving.

? There's no sound coming from the speaker during playback.

- The video heads need cleaning (92).

- The video heads need cleaning (92).

- The TV/VIDEO selector on the TV isn't set to VIDEO (30).

- The speaker has been turned off with the selector dial (26).

- Headphones are being used.

E

Miscellaneous

Problem

? The wireless controller doesn't work.

? The power indicator is flashing.

? The camera malfunctions.

? The DV cable is connected correctly, but there's nothing in the display.

? The camera becomes warm during use.

Cause and/or what to do about it

- The remote sensor mode is set to OFF (39) in the menu (39).

- The remote sensor modes of the wireless controller and the camera itself are different (39).

- The batteries are dead or not inserted.

- Check the screen displays (103).

- External interference may cause the camera's microprocessor to malfunction temporarily. If random letters appear in the display or if normal operation is interrupted, remove and then replace the power source.

- Remove the cable and then reconnect it or turn the power off and back on again.

- This is not a malfunction.

Additional
Information

The ZR10 System Diagram (Availability differs from area to area)

E

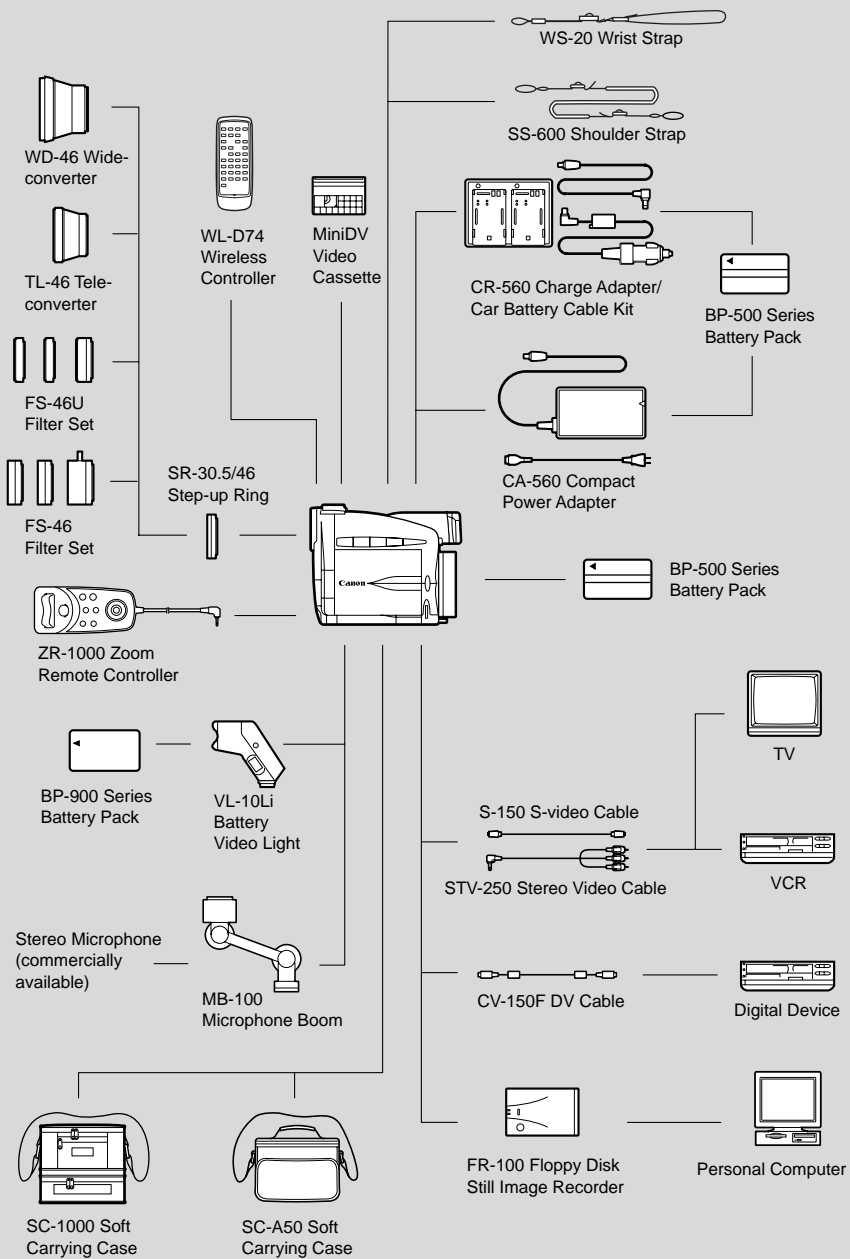

Additional Information

Optional Accessories

Call or visit your local retailer/dealer for genuine Canon video accessories. You can also obtain genuine accessories for your Canon camcorder by calling: 1-800-828-4040, Canon U.S.A. Information Center.

E

BP-500 Series Battery Packs

Extra batteries for use with the ZR10.

BP-511

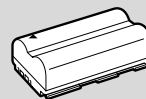

BP-522

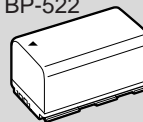

CR-560 Charge Adapter/Car Battery Cable Kit

Connect the car battery cable to power your camera or recharge battery packs on the move. The car battery cable plugs into your car's cigarette lighter socket and runs off a 12-24 V DC negative ground battery. Also, when used with the CA-560 Compact Power Adapter, this charge adapter can charge the BP-500 series lithium ion battery packs from an AC outlet.

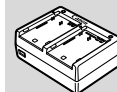

SR-30.5/46 Step-up Ring

This makes it possible to use the 46 mm filters and converters (shown below) with ZR10. When you attach the filter or conversion lens, you cannot use the supplied lens cap.

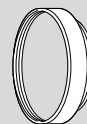

TL-46 Tele-converter

This tele-converter lens increases the focal length of the camera lens by a factor of 1.4.

- The image stabilizer is not as effective as usual when the tele-converter is attached.

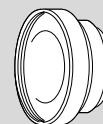

Additional
Information

E**WD-46 Wide-converter**

This lens decreases focal length by a factor of 0.7, giving you a wide perspective for indoor shots or panoramic views.

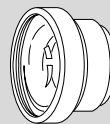
**FS-46 Filter Set**

Three special effects filters to add a creative touch to your recordings: multiple-image, R-cross and zoom-spot.

- Focus manually when using special effects filters.

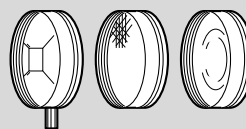
**FS-46U Filter Set**

Ultraviolet, neutral density and circular polarizing filters to help you take control of difficult lighting conditions.

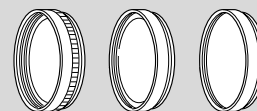
**VL-10Li Battery Video Light**

This compact yet powerful video light can be used for both indoor and outdoor shooting.

- Use the BP-900 Series battery packs to power the light. Approximate usage times are as follows:
BP-915 60 min. BP-930 120 min.
BP-941 160 min. BP-945 170 min.
- Charge the BP-900 Series battery packs with the CA-910 Compact Power Adapter (optional).

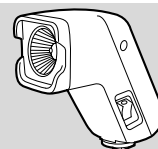

**Additional
Information**

Zoom Remote Controller ZR-1000

When this product is plugged into the LANC  terminal of a Canon camcorder, it is possible to control functions such as the start and stop of recording and the zoom and focusing functions while the camcorder is mounted on a tripod, without touching the camcorder body itself.

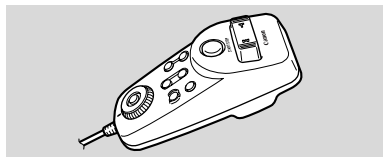

E

MB-100 Microphone Boom

Provides a firm, flexible support for your external microphone, so you can take full advantage of the sound quality and creative control it offers. Also keeps long microphones out of the picture.

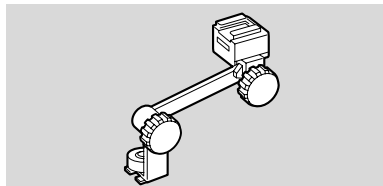
**WS-20 Wrist Strap**

Provides an extra measure of protection for active shooting.

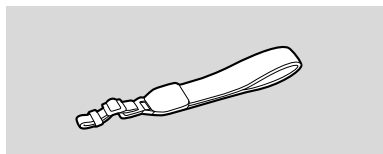
**SC-1000 Soft Carrying Case**

A handy camera bag with padded compartments and plenty of space for accessories.

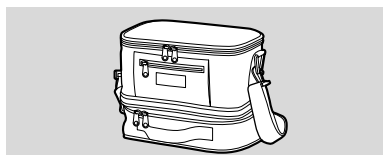

Additional
Information

E**SC-A50 Soft Carrying Case**

This lightweight bag keeps the camera within easy reach without weighing you down or getting in the way. Genuine leather.

**FR-100 Floppy Disk Still Image Recorder**

The FR-100 captures images taken with your digital camcorder, compressing them in JPEG format and recording them as still images onto a floppy disk. Image files can then be easily opened and viewed on your computer.

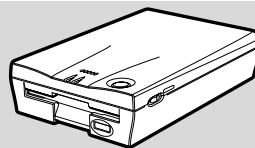

This mark identifies genuine Canon video accessories. When you use Canon video equipment, we recommend Canon-brand accessories or products bearing the same mark.

Provided accessories:

WL-D74 Wireless Controller	D83-0522-000
CA-560 Compact Power Adapter	D85-1100-201
BP-511 Battery Pack	D85-1112-000
SS-600 Shoulder Strap	D81-1330-201
S-150 S-video Cable	D82-0330-000
STV-250 Stereo Video Cable	D82-0516-000
Lens cap	D52-0100-000

Optional accessories:

CR-560 Charge Adapter/ Car Battery Cable Kit	D85-0680-201
BP-522 Battery Pack	D85-1122-002
BP-915 Battery Pack	D85-0952-201
BP-930 Battery Pack	D85-0962-201
BP-941 Battery Pack	D85-0862-201
BP-945 Battery Pack	D85-0972-201
CA-910 Compact Power Adapter	D85-1022-000

SC-1000 Soft Carrying Case	D81-1200-001
SC-A50 Soft Carrying Case	D81-1302-201
WD-46 Wide-converter	D78-0013-201
TL-46 Tele-converter	D78-0014-201
FS-46U Filter Set	D78-0008-201
FS-46 Filter Set	D78-0006-201
SR-30.5/46 Step-up Ring	D56-0060-201
VL-10Li Battery Video Light	D86-0081-201
JR7.2V 10WF Halogen Bulb	DY4-4530-000
MB-100 Microphone Boom	D89-0200-202
ZR-1000 Zoom Remote Controller	D83-0540-002
FR-100 Floppy Disk Still Image Recorder	D89-0732-002
WS-20 Wrist Strap	D81-0190-202
DVM-CL Digital Video Head Cleaning Cassette	D36-0032-201

Additional
Information

Screen Displays

To display the date and time, press the wireless controller's DATA CODE button. See also p. 68.

Press the wireless controller's TV SCREEN button or turn TV SCREEN on through the camera menu to see the other displays on the TV screen. (The displays appear white on-screen.) They will not be added to any recordings you make with the camera. For instructions on how to hook the camera up to your TV, see p. 30.

 indicates a flashing display.

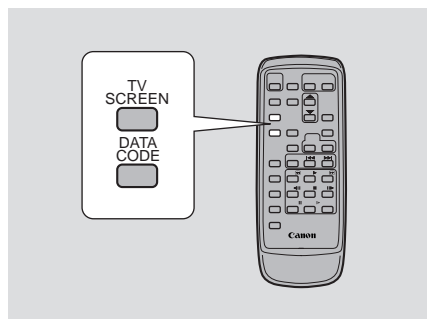

E

Turning off the LCD screen displays

You can turn off the displays to give you a clear screen for playback.

Set the camera to VCR mode, open the VCR menu and choose the DISPLAYS option. Set the displays to OFF and then close the menu.

- The LCD screen will now be completely blank, but the camera will continue to show warning/caution displays when necessary.

Record pause mode
( 18)



Remaining tape
(Green: more than five minutes.



Yellow: less than five minutes.
Red: final few seconds.)

The backup battery is not properly installed, or needs replacing
( 90).



...finally, it tells you when you have completely run out of tape.



Shows how much battery power remains
( 88).



The camera is ejecting the tape ( 16).



The battery pack is exhausted ( 88).



The safety mechanism is activated. Unload the cassette and turn the camera off. Turn it on again and reload the cassette.



No cassette is loaded, or it is set for erasure prevention
( 16, 17).



Recording mode
( 20)



Additional
Information

E

Playback is stopped
(27).



Normal playback
(27)



Fast forward (27)



Rewind (27)



Fast forward playback
(28)



Rewind playback
(28)



Frame advance
playback (29)



Frame reverse
playback (29)



Playback pause
(forward and reverse)
(28)

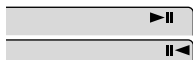

Slow playback
(forward and reverse)
(29)



×2 playback (forward
and reverse) (29)

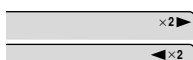

×1 playback (forward
and reverse) (29)



**Additional
Information**

Photo Search (71)



Date Search (71)



Zero set memory
(forward and reverse)
(72)



A/V Insert Editing
(78)



Audio Dubbing
(81)



Zoom display (22):
Optical zoom

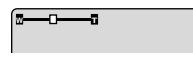

Optical plus 40×
digital zoom



Optical plus 200×
digital zoom



Zoom in



Zoom out

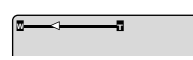

The image stabilizer is
turned on (34).

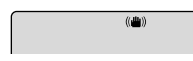

Camera menu
(35)

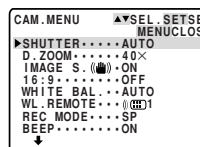

VCR menu (36)

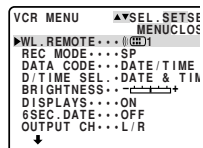

The remote sensor is
turned off (39).



Self-timer countdown
(60)



Zero set memory
(72)

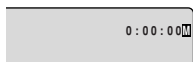

Audio mode (58)



Data code (69)



Photo mode (44)



- Setting the AF/AE. mark flashes white
- AF/AE locked. mark lights up green
- Timer



Recording programs
(48).

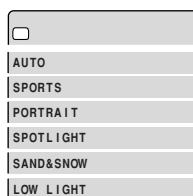

Manual exposure
display (62):
Exposure locked

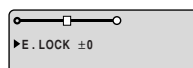

Brighter than standard
exposure level

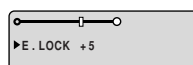

Darker than standard
exposure level

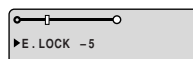

Manual focus is
selected (65).

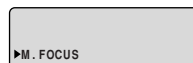

Shutter speed (63)



White balance is
(66)

Set
Indoor
Outdoor

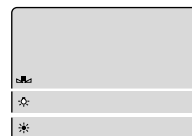

The 16:9 effect: the
display flashes when
the effect is being
selected, and appears
steadily when it is
activated (20).



Digital effects. The
display flashes when
the function is being
selected and appears
steadily when it is
activated (52).



The wind screen is
turned on (59).



Volume level (26)

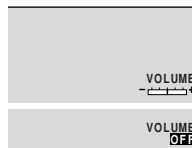





Audio output (84)

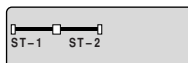

E

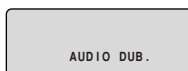
Additional
Information

EMix balance ( 84)Audio/visual insert
( 78)Audio dubbing
( 81)Audio input ( 82)Microphone input
( 82)DV input ( 74)Condensation warning
( 94)

Time Code

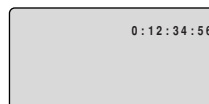

This records counter information, including hour, minute, second, and frame number on a special data code area on the tape itself. It is reset automatically when a new tape is loaded. In camera mode, the frame number doesn't appear in the display.

Recording reminder

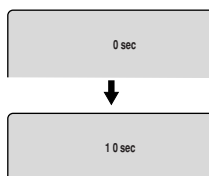

When you start recording, the camera counts from 0SEC to 10SEC. Shots which are shorter than ten seconds may be difficult to edit later. On the other hand, if you are not planning to edit the recording, remember that a shot which does not contain action should generally last no longer than ten seconds.

**Additional
Information**

Caution phrases

The camera displays various caution phrases — they appear for four seconds before disappearing.

Appears each time you turn the power on, until you set the time zone, date and time ( 41).

SET THE TIME ZONE,
DATE AND TIME

Appears as a warning to protect the tape and also when condensation is detected. Remove the tape as soon as possible after the camera has displayed the caution.

REMOVE THE CASSETTE

Refer to p.75

Appears when the battery pack is exhausted ( 12, 88).

CHANGE THE BATTERY PACK

COPYRIGHT PROTECTED
PLAYBACK IS RESTRICTED

Refer to p. 75

Appears when the tape has reached the end.

TAPE END

COPYRIGHT PROTECTED
DUBBING RESTRICTED

Refer to p.17

THE TAPE IS SET FOR
ERASURE PREVENTION

Appears when you try to do audio dubbing or A/V insert on a tape recorded in LP mode( 78, 81).

CHECK THE CASSETTE
[LP MODE]

Appears if you press the REC PAUSE button when the DV cable is not connected properly ( 75).

CHECK THE DV INPUT

Appears when you try to do audio dubbing on a tape recorded in 16-bit audio or 12-bit, 4-channel mode ( 81-83).

CHECK THE CASSETTE
[AUDIO MODE]

Refer to p. 94

CONDENSATION
HAS BEEN DETECTED

Appears when the camera detects a blank section of a tape during audio dubbing or A/V insert ( 78, 81).

CHECK THE CASSETTE
[BLANK]

E

Additional
Information

Specifications

E

ZR10

Power Supply (rated): 7.4 V DC

Power Consumption (while recording with the AF turned on):

3.7 W (Using viewfinder),

4.6 W (Using LCD screen)

Television system:

EIA standard (525 lines, 60 fields) NTSC color signal

Video recording system:

2 rotary heads, helical scanning

DV system (Consumer digital VCR SD system)

Digital component recording

Audio recording system: PCM digital

sound: 16 bit (48kHz/2ch),

12 bit (32kHz/4ch)

Image sensor: 1/4" CCD (charge coupled

device), approx. 460,000 pixels

(approx. 290,000 effective pixels)

Tape format: Videocassettes bearing the Mini DV mark.

Tape speed:

SP: 3/4 ips (18.81 mm/s);

LP: 1/2 ips (12.56 mm/s)

Maximum recording time:

SP: 80 min. (with a 80 min. cassette);

LP: 120 min. (with a 80 min. cassette)

Fast forward/rewind time:

Approx. 2 min. 30 sec. (with a 60 min. cassette)

Lens: F/1.8–2.9, 10× power zoom,

4.2–42.0 mm

Focusing system: TTL autofocus, manual focusing possible

Minimum focusing distance: 3ft 3³/₈ in (1 m) (3³/₈ in (1 cm) on maximum wide angle)

Maximum shutter speed:

1/8,000 sec.

Minimum illumination: 2.5 lx (using the low light program)

Recommended illumination:

More than 100 lx

Filter diameter: 30.5 mm

Viewfinder: 0.44 in, TFT color LCD, approx. 113,000 pixels

LCD screen: 2.5 in measured diagonally, TFT color, approx. 112,000 pixels

Microphone: Stereo electret condenser microphone

DV Terminal input/output:

Special 4-pin connector (conforms to IEEE1394)

A/V terminal input/output: ϕ 3.5 mm

Audio input: –10dBV/ at least 47 kohms, (L, R), unbalanced

output: –10dBV (47 kohm load)/

less than 3 kohms,

unbalanced

Video: 1 Vp-p/75 ohms unbalanced

S-video terminal input/output:

1 Vp-p (Y signal), 0.286 Vp-p (C signal)

MIC terminal input: ϕ 3.5 mm stereo

mini-jack, –61 dBV (with 600 ohm

mic)/ at least 5 kohms

Operating temperature range: 32–104 °F (0–40 °C)

Dimensions: 2¹/₄ × 4 × 5¹/₈ in

(57 × 101 × 129 mm)

Weight: 1lb 3 ³/₈ oz (550 g)

BP-511 Battery Pack

Battery type: Rechargeable lithium ion battery

Rated voltage: 7.4 V DC

Operating temperature: 32°–104°F (0°–40°C)

Battery capacity: 1100 mAh

Dimensions: 1¹/₂ × 7⁷/₈ × 2¹/₈ in

(38 × 21 × 55 mm)

Weight: 2¹/₂ oz (70 g)

Weight and dimensions are approximate

Errors and omissions excepted.

Subject to change without notice.

Canon is a trademark of Canon Inc.

Additional Information

Index

16:9, 20

A

Abroad, Using the Camera, 93
 Accessories, 6, 99
 Adapter, AC, 11, 13
 AE Programs, 48
 Analog line-in, 76
 Art, 55
 Audio Dubbing, 81
 Audio Mix, 84
 Audio Mode, 58
 Audio Output, 85
 Audio Recording and Playback,
 26, 58
 Audio/Video Terminal, 30
 Auto, 50
 Autofocus, 65
 A/V Insert, 78

B

Backup Battery, 90
 Basic Recording, 18
 Battery Charger, 14
 Battery Pack, 12, 14, 15, 88
 Beep, 21
 Black and White, 55

C

Cables, 6, 30
 Cassettes, 16
 Charging the Battery Pack,
 12-15, 88
 Choosing a Recording Program, 48
 Cleaning the Camera, 92
 Clock, 43
 Condensation, 94
 Connection to TV or VCR, 30

D

Data Code, 68
 Date and Time, 41
 Date Search, 71
 Digital Effects, 52
 Digital Video, 7
 Digital Zoom, 22
 DV Dubbing, 74

E

Easy Recording, 50
 Editing to a VCR, 73
 Effects, 55
 Exposure, 62
 External Microphone, 58, 81

F

Fade Trigger, 54
 Faders, 54
 Fast Forward, 27
 Feedback, 31
 Finding Your Way Around
 the ZR10, 8
 Floppy Disk Still Image Recorder, 46
 Focusing, 65

H

Head Cleaning, 92
 Headphones, 26
 Horizontal Wipe, 54

I

Image Stabilizer, 34
 Introducing the ZR10, 7

L

LANC, 73
 LCD Screen, 23
 Lens Cap, 86
 Loading Cassettes, 16
 Low Light, 51
 LP Mode, 20

M

Maintenance, 91
 Making Better Videos, 32
 Manual Exposure Control, 62
 Manual Focus, 65
 Menus, 35
 Microphone, 58, 81
 Monitor Recording, 25
 Mosaic, 54, 55
 Mosaic Fade, 54

E

Additional
 Information

E**O**

Optional Accessories, 99

P

Pause, Record, 18
 Photo Search, 71
 Playback, 27
 Playback Connection, 30
 Playback Pause, 28
 Portrait, 50
 Power Adapter, 11, 13
 Powering Your Camcorder, 11
 Pre-Marked Position, 72
 Preparing the Camera, 86
 Problems, 95

R

Recharging the Battery Pack, 88
 Recording, 18
 Recording Programs, 48
 Record Pause Mode, 18
 Record Review, 47
 Record Search, 47
 Remote Control, 38
 Remote Sensor, 39
 Rewind, 27

S

S1 video input terminal, 30
 Sand & Snow, 51
 Screen Displays, 103
 Self-Timer, 60
 Sepia, 55
 Shoulder Strap, 87
 Shutter Speed, 63
 Speaker, 26
 Specifications, 108
 SP Mode, 20
 Sports, 50
 Spotlight, 51
 Still Picture, 44
 Storage, 92
 S-video, 30
 System Diagram, 98

T

Tape Protection, 17
 Telephoto, 22
 Temperature, 90, 92
 Time Code, 106
 Time Zone, 41
 Tips for Making Better Videos, 32
 Tripod, 32
 Troubleshooting, 95
 TV, 30, 103

U

Using the Camera Abroad, 93
 Using the Menus, 35

V

VCR, 30
 Vertical Wipe, 54
 Videocassettes, 16
 Video Heads, 92
 Video ID-1 system, 31
 Viewfinder, 86, 92

W

White Balance, 66
 Wide-angle, 22
 Widescreen TV, 20
 Wind Screen, 59
 Wipe, 54
 Wireless Controller, 38

Z

Zero Set Memory, 72
 Zooming, 22

U.S.A.**CANON® ZR10 DIGITAL VIDEO CAMCORDER LIMITED WARRANTY**

The limited warranty set forth below is given by Canon U.S.A., Inc. ("CUSA") with respect to each Canon ZR10 Digital Video Camcorder ("DV Camcorder") purchased and used in the United States.

Each Canon DV Camcorder, when delivered to you in new condition in its original container, is warranted against defective material or workmanship as follows: for a period of one (1) year from the date of original purchase (three (3) months in the case of the video head part), defective parts or DV Camcorders returned to a CUSA factory service center ("CUSA Center") or an authorized DV Camcorder service facility ("Service Facility"), and proven to be defective upon inspection, will be repaired or exchanged for new or comparable rebuilt parts or DV Camcorders. The warranty period for repaired or replacement parts or DV Camcorders shall begin upon shipment of the same, but shall in no event exceed the original warranty period of the defective part or DV Camcorder.

Non-Canon brand peripheral equipment and software which may be distributed with Canon DV Camcorders are sold "AS IS", without warranty of any kind by CUSA, including any implied warranty regarding merchantability or fitness for a particular purpose. The sole warranty with respect to such non-Canon brand items is given by the manufacturer or producer thereof.

CUSA shall have no responsibility under this limited warranty for use of Canon DV Camcorders in conjunction with incompatible peripheral equipment and incompatible software.

In order to obtain warranty service, contact the authorized Canon retail dealer from whom you purchased the DV Camcorder or call the CANON INFORMATION CENTER AT 1-800-828-4040 (which is open from 9:00 a.m. to 5:00 p.m. (E.S.T.), Monday through Friday, excluding holidays). Have your unit serial number and your date of purchase available when you make the call to expedite service. In either case you will be directed to ship the DV Camcorder, postage prepaid, to the CUSA Center or Service Facility nearest to you. You must include a copy of the proof of purchase (bill of sale) and a complete explanation of the problem. DV Camcorders covered by this limited warranty will be repaired and returned to you without charge by the CUSA Center or the Service Facility. Repairs not under warranty will be at such cost as the CUSA Center or Service Facility may from time to time generally establish.

This limited warranty covers all defects encountered in normal use of the DV Camcorder, and does not apply in the following cases:

- (a) Loss of or damage to the DV Camcorder due to abuse, mishandling, improper packaging by you, alteration, accident, leaking batteries, exterior nicks, scratches or dents, electrical current fluctuations, failure to follow operating instructions, maintenance and environmental instructions prescribed in CUSA's instruction manual, or service performed by other than a CUSA Center or Service Facility.
- (b) Use of parts or supplies (other than those sold by CUSA) which cause damage to the DV Camcorder or cause abnormally frequent service calls or service problems.
- (c) If any DV Camcorder has had its serial number or dating altered or removed.

This limited warranty does not apply to accessories or consumables for the DV Camcorder, which are sold "AS IS", without warranty of any kind by CUSA.

NO IMPLIED WARRANTY, INCLUDING ANY IMPLIED WARRANTY OF MERCHANTABILITY OR FITNESS FOR A PARTICULAR PURPOSE, APPLIES TO THE DV CAMCORDER AFTER THE APPLICABLE PERIOD OF EXPRESS WARRANTY STATED ABOVE, AND NO OTHER EXPRESS WARRANTY OR GUARANTY, EXCEPT AS MENTIONED ABOVE, GIVEN BY ANY PERSON, FIRM OR CORPORATION WITH RESPECT TO THE DV CAMCORDER SHALL BIND CUSA. (SOME STATES DO NOT ALLOW LIMITATIONS ON HOW LONG AN IMPLIED WARRANTY LASTS, SO THE ABOVE LIMITATION MAY NOT APPLY TO YOU) CUSA SHALL NOT BE LIABLE FOR LOSS OF REVENUES OR PROFITS, EXPENSE FOR SUBSTITUTE EQUIPMENT OR SERVICE, STORAGE CHARGES, LOSS OF DATA, OR ANY OTHER SPECIAL, INCIDENTAL OR CONSEQUENTIAL DAMAGES CAUSED BY THE USE, MISUSE OR INABILITY TO USE THE DV CAMCORDER, REGARDLESS OF THE LEGAL THEORY ON WHICH THE CLAIM IS BASED, AND EVEN IF CUSA HAS BEEN ADVISED OF THE POSSIBILITY OF SUCH DAMAGES. NOR SHALL RECOVERY OF ANY KIND AGAINST CUSA BE GREATER IN AMOUNT THAN THE PURCHASE PRICE OF THE DV CAMCORDER SOLD BY CUSA AND CAUSING THE ALLEGED DAMAGE. WITHOUT LIMITING THE FOREGOING, YOU ASSUME ALL RISK AND LIABILITY FOR LOSS, DAMAGE OR INJURY TO YOU AND YOUR PROPERTY AND TO OTHERS AND THEIR PROPERTY ARISING OUT OF USE, MISUSE OR INABILITY TO USE THE DV CAMCORDER NOT CAUSED DIRECTLY BY THE NEGLIGENCE OF CUSA. (SOME STATES DO NOT ALLOW THE EXCLUSION OR LIMITATION OF INCIDENTAL OR CONSEQUENTIAL DAMAGES, SO THE ABOVE LIMITATION MAY NOT APPLY TO YOU.) THIS LIMITED WARRANTY SHALL NOT EXTEND TO ANYONE OTHER THAN THE ORIGINAL PURCHASER OF ANY DV CAMCORDER, OR THE PERSON FOR WHOM IT WAS PURCHASED AS A GIFT, AND STATES YOUR EXCLUSIVE REMEDY.

This limited warranty gives you specific legal rights, and you may also have other rights which vary from state to state.

Canon U.S.A., Inc.
One Canon Plaza
Lake Success, New York 11042

E**Additional
Information**

CANADA**E****CANON CONSUMER DIGITAL VIDEO EQUIPMENT LIMITED WARRANTY**

The limited warranty set forth below is given by Canon Canada Inc. ("Canon Canada") with respect to Canon digital video equipment purchased in Canada. This limited warranty is only effective upon presentation of a bill of sale or other proof of purchase for this Canon digital video equipment to a Canon Service Facility when repairs are required.

Canon consumer video digital equipment is warranted under normal, non-commercial, personal use, against defective materials or workmanship as follows:

Parts: Defective parts will be exchanged for new parts or, at Canon Canada's option, comparable rebuilt parts for a period of one year from the date of original purchase, except Video Heads which will be exchanged for a period of 3 months from the date of purchase.

Labour: For a period of one year from the date of original purchase, labour will be provided free of charge by our Canon Service Facilities in Canada.

This limited warranty covers all defects except where:

- (a) The loss or damage to the product results from:
- i) accident, natural disaster, mishandling, abuse, neglect, unauthorized product modification or failure to follow instructions contained in the instruction manual;
 - ii) the use of accessories, attachments, products, supplies, parts or devices with this Canon product that do not conform to Canon specifications or that cause abnormally frequent service problems;
 - iii) repairs or services performed by any party other than a Canon Service Facility;
 - iv) defective batteries or any exposure to water, sand or dirt;
 - v) shipping (claim must be presented to the shipper);
- (b) Any serial number on the video equipment is altered or removed.
- (c) The digital video equipment is used for commercial, professional or industrial purposes.
- This limited warranty does not cover the cabinet (exterior finish) of the digital video equipment, video cassette tapes, head cleanings, nor does it apply to digital video equipment purchased outside Canada.

TO OBTAIN WARRANTY SERVICE

Ship your Canon digital video equipment in its original carton, box or equivalent, properly packed, fully insured with shipping charges prepaid, together with a copy of your bill of sale or other proof of purchase and a description of the problem to any of the Canon Service Facilities in Canada.

LIMITATIONS

Except as otherwise required by applicable legislation, this warranty is in lieu of all other warranties, conditions, guarantees or representations, express or implied, statutory or otherwise, relative to this Canon product, including implied warranties or conditions of merchantability or fitness for a particular purpose.

Canon Canada assumes no liability for special, consequential or incidental damages or loss that may arise, whether on account of negligence or otherwise, from the use, misuse or inability to use this Canon product (including loss of profit, revenue, video tapes or enjoyment) or from failure to conform to any express or implied warranties, conditions, guarantees or representations. Any recovery under this limited warranty shall not exceed the purchase price of the product. Canon Canada does not assume or authorize any other person to assume for Canon Canada any other liability with respect to this Canon product.

This warranty does not extend to any person other than the original purchaser of this Canon product or the person for whom it was purchased as a gift and states your exclusive remedy.

NOTICE TO CONSUMER

If you plan to take important videos or if the product has not been used for some time, please check all functions with the instruction book before using it.

**Additional
Information**



CANON INC.

U.S.A. ————— **CANON U.S.A., INC. NEW JERSEY OFFICE**
100 Jamesburg Road, Jamesburg, NJ 08831 USA

CANON U.S.A., INC. CHICAGO OFFICE
100 Park Blvd., Itasca, IL 60143 USA

CANON U.S.A., INC. LOS ANGELES OFFICE
15955 Alton Parkway, Irvine, CA 92718 USA

CANON U.S.A., INC. HONOLULU OFFICE
1020 Auahi Street, Bldg. #8, Honolulu, HI 96814 USA

- **If you have any questions, call the Canon U.S.A. Information Center toll-free at 1-800-828-4040 (U.S.A. only).**

CANADA ————— **CANON CANADA INC. NATIONAL HEADQUARTERS**
6390 Dixie Road, Mississauga, Ontario L5T 1P7

CANON CANADA INC. CALGARY
2828, 16th Street, N.E. Calgary, Alberta T2E 7K7

CANON CANADA INC. MONTREAL
5990 Côte de Liesse, Quebec H4T 1V7

- **If you have any questions, call the Canon Canada Information Center toll-free at 1-800-828-4040. (Canada only)**

- **Si vous avez des questions, veuillez téléphoner sans frais au Canada 1-800-828-4040. (Canada seulement)**

MEXICO ————— **CANON MEXICANA, S. DE R.L. DE C.V.**
Periferico Sur No. 4124 Col. Ex-Rancho de Anzaldo C.P. 01900
México, D.F., México

CENTRO Y SURAMÉRICA ————— **CANON LATIN AMERICA, INC.**
6505 Blue Lagoon Drive Suite 325 Miami FL 33126 USA

ASIA ————— **CANON HONGKONG COMPANY LTD.**
9/F, The Hong Kong Club Building, 3A Chater Road, Central, Hong Kong



Printed on 70% reused paper.
Document réalisé avec du papier recyclé à 70%.
El papel aqui utilizado es 70% reciclado.

PUB.DIM-339
0300.A/XXXX

© CANON INC. 2000
DY8-9120-239-000

PRINTED IN JAPAN
IMPRIME AU JAPON