

# Instruction Manual

**ETX-90EC Astro Telescope**

**ETX-105EC Astro Telescope**

**ETX-125EC Astro Telescope**



**Meade Instruments Corporation**





### WARNING!

Never use a Meade® ETX® Astro Telescope to look at the Sun! Looking at or near the Sun will cause instant and irreversible damage to your eye. Eye damage is often painless, so there is no warning to the observer that damage has occurred until it is too late. Do not point the telescope or its viewfinder at or near the Sun. Do not look through the telescope or its viewfinder as it is moving. Children should always have adult supervision while observing.

### CAUTION!

Use care to install batteries as indicated by the battery compartment. Follow battery manufacturer's precautions. Do not install batteries backward or mix new and used batteries. Do not mix battery types. If these precautions are not followed, batteries may explode, catch fire, or leak. Improperly installed batteries void your Meade warranty.

If you are anxious to use your ETX Astro Telescope for the first time, before a thorough reading of this instruction manual, see the QUICK-START GUIDE on page 4.

## CONTENTS

<b>Quick-Start Guide</b> .....	<b>4</b>
<b>Telescope Electronic Controller Functions</b> .....	<b>5</b>
ETX: Your Personal Window on the Universe .....	6
Telescope Controls .....	6
Electronic Controller Functions .....	8
<b>Getting Started</b> .....	<b>9</b>
Parts Listing .....	9
Assembly Instructions .....	9
Using the Viewfinder .....	10
Focusing the Viewfinder .....	10
Aligning the Viewfinder .....	10
<b>Observation Techniques</b> .....	<b>11</b>
Choosing an Eyepiece .....	11
Understanding Magnification .....	12
Terrestrial Observing .....	12
Astronomical Observing .....	13
Sidereal Rate .....	13
The Electronic Controller .....	13
Slew Speeds .....	13
Modes of Operation .....	14
Telescope Mountings .....	14
Alt/Az Mode .....	14
Polar Mode .....	15
Celestial Coordinates .....	16
Locating the Celestial Pole .....	16
Polar Alignment Procedure .....	16
<b>Photography</b> .....	<b>18</b>
A Few Tips on Photography .....	19
<b>Optional Accessories</b> .....	<b>20</b>
<b>General Maintenance</b> .....	<b>22</b>
Storage and Transport .....	22
Inspecting the Optics .....	23
Troubleshooting .....	23
Meade Customer Service .....	24
Telescope Specifications .....	25
<b>Appendix A: Advanced Controller Functions</b> .....	<b>26</b>
Tracking Motor Speed .....	26
Changing Modes .....	26
<b>Appendix B: Helpful Charts</b> .....	<b>27</b>
Latitude Chart for Major Cities of the World .....	27
Star Locator .....	27
<b>Appendix C: Polar Alignment; Setting Circles</b> .....	<b>28</b>
Precise Polar Alignment .....	28
Setting Circles .....	28
<b>Appendix D: You and the Universe</b> .....	<b>29</b>
Objects in Space .....	29
The Moon .....	29
Planets .....	29
Deep-Sky Objects .....	30

® The name "Meade," the Meade logo, and "ETX" are trademarks registered with the U.S. Patent Office and in principal countries throughout the world. All rights reserved.

© 2001 Meade Instruments Corporation.

## QUICK-START GUIDE

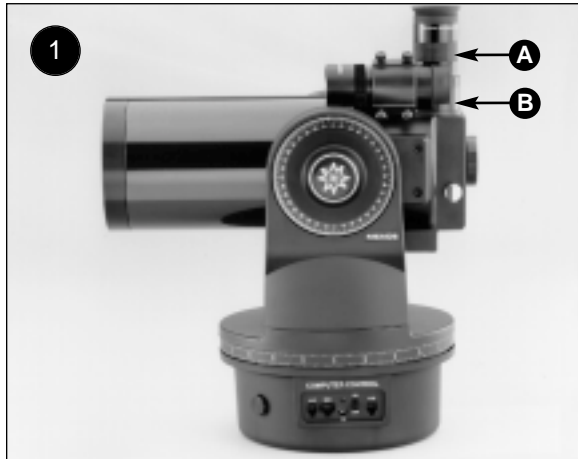

Remove the ETX from its packaging and place it on a sturdy surface. Place the eyepiece (A) and viewfinder (B) into their appropriate positions on the telescope and tighten their respective attachment screws to a firm feel only.

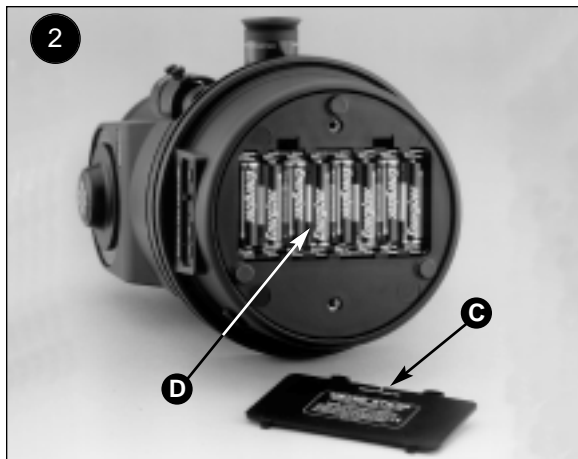

Securely place the ETX on its side and remove the battery compartment cover (C) from the underside of the drive base. Insert eight (user-supplied) AA-size batteries into the battery compartment (D) in the proper orientation. Replace the cover and return the telescope to an upright position.

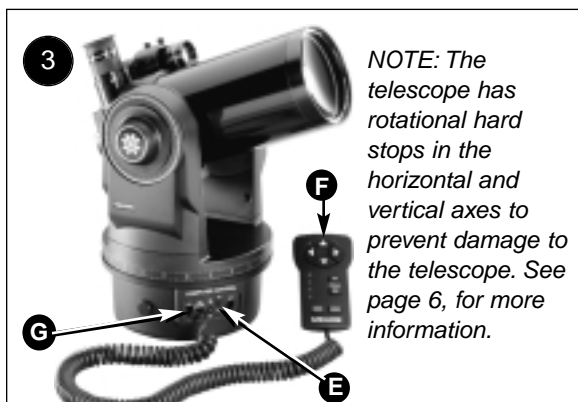

**NOTE:** The telescope has rotational hard stops in the horizontal and vertical axes to prevent damage to the telescope. See page 6, for more information.

Verify that the Computer Control panel power switch (E) is in the OFF position. Remove the Electronic Controller (F) from the packing materials and plug it into the HBX port (G). Tighten the vertical and horizontal locks (6 and 9, Fig. 1) and then remove the dust cover (19, Fig. 1) from the end of the telescope tube.

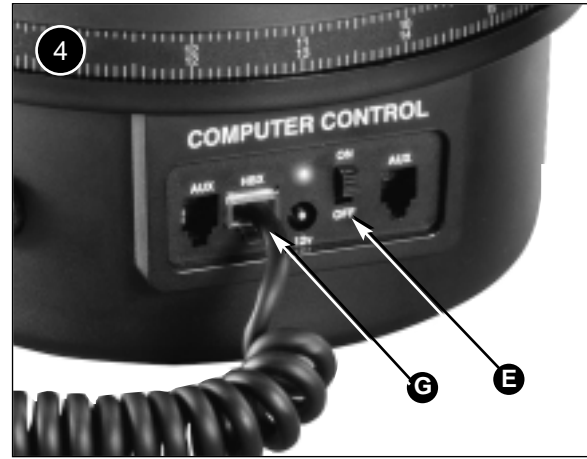

Slide the Power Switch (E) on the Computer Control panel to the ON position. The lights flicker on the Electronic Controller. Press any key and the motors briefly move the telescope. The Electronic Controller is now operational.

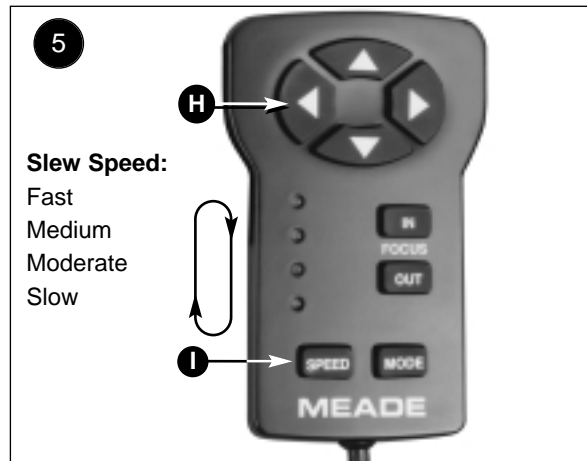

Use the Electronic Controller Arrow keys (H) to move the telescope up, down, left, and/or right. To change the telescope's slew speed, press the SPEED key (I). The indicator lights signify the speed, with the upper light showing the highest speed. Each press slows the speed down one level, then cycles back to the highest speed.

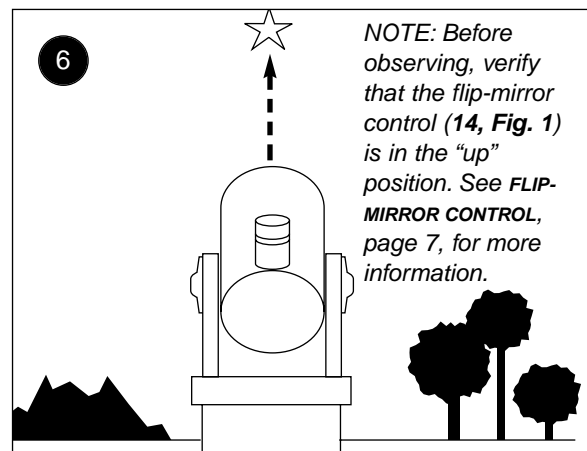

**NOTE:** Before observing, verify that the flip-mirror control (14, Fig. 1) is in the "up" position. See **FLIP-MIRROR CONTROL**, page 7, for more information.

Sight along the side of the telescope's main tube to locate an object. Practice using the Electronic Controller Arrow keys to center an object in the telescope's field of view. Use the telescope's focus knob (8, Fig. 1) to bring the object into focus.

# TELESCOPE AND ELECTRONIC CONTROLLER FUNCTIONS

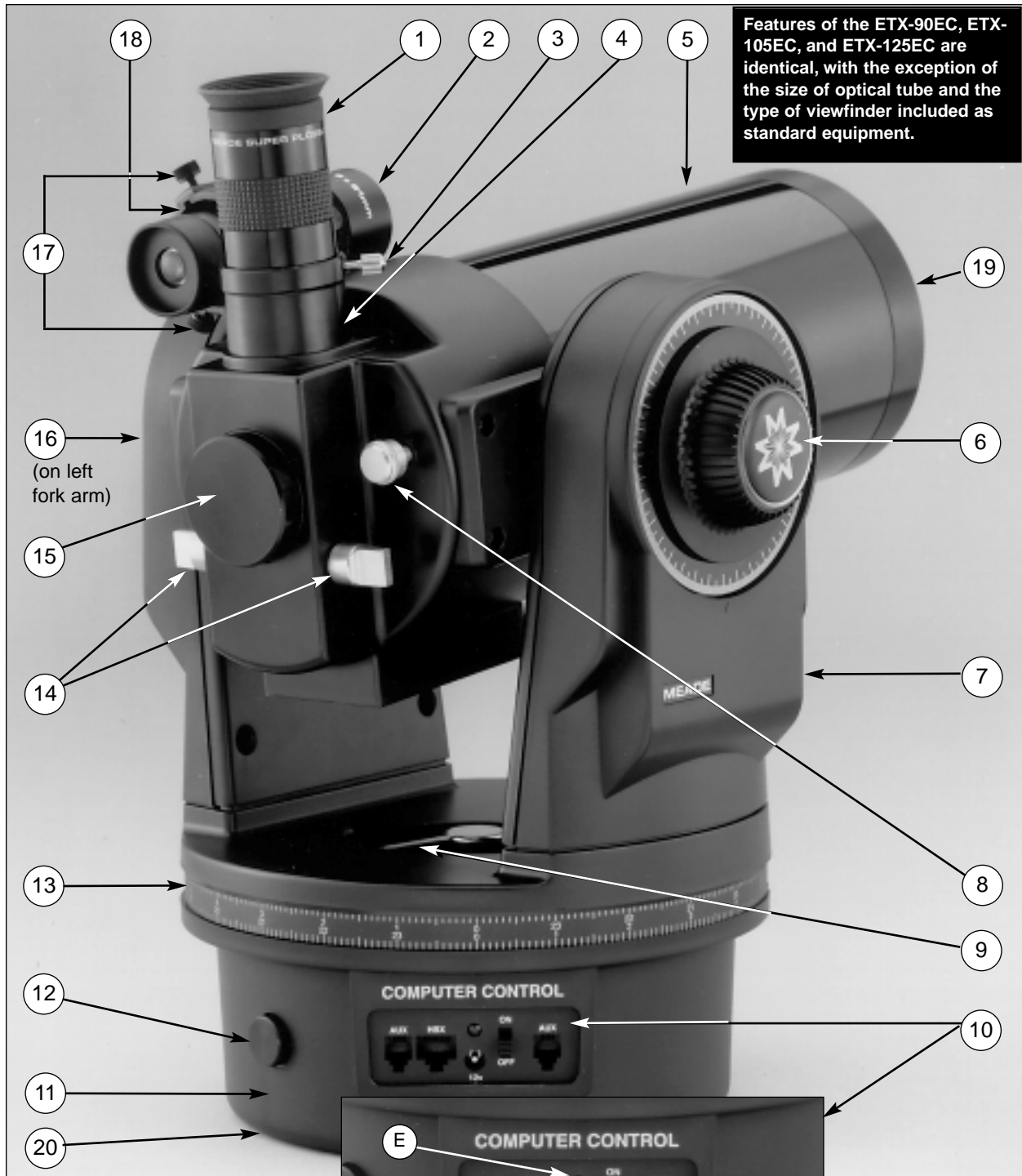

**Fig. 1:** The ETX-90EC Astro Telescope.

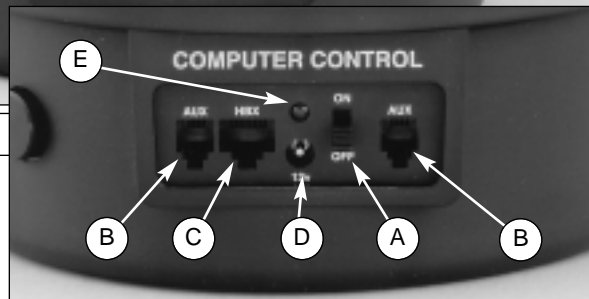

**Fig. 1 (Inset):** Computer Control Panel. (A) On/Off switch; (B) Auxiliary ports; (C) Handbox port; (D) 12v connector; (E) Power indicator light.

## ETX: Your Personal Window to the Universe

The Meade ETX-90EC, ETX-105EC, and the ETX-125EC are extremely versatile, high-resolution telescopes with features similar to those once available only with larger and more specialized imaging systems. With pushbutton controls, automatic tracking of celestial objects (with one of the optional tripods), and diffraction-limited imaging, an ETX telescope may be all the telescope ever required by many terrestrial and astronomical observers.

Your ETX telescope reveals nature in an ever-expanding level of detail. Observe the feather structure of an eagle from 50 yards or study the rings of the planet Saturn from a distance of 800 million miles. Focus beyond the Solar System and observe majestic nebulae, ancient star clusters, remote galaxies, and even stars recently discovered to have planets orbiting about them. Meade ETX telescopes are instruments fully capable of growing with your interest and are ideal for both the casual observer and serious astronomer alike.

## Telescope Controls

An important array of features and manual controls facilitates operation of an ETX telescope. *Be sure to become acquainted with all of these controls before attempting observations through the telescope.*

- ❶ **Eyepiece** - Place the supplied SP 26mm eyepiece into the 90° Eyepiece Holder (4, Fig. 1) and tighten in place with thumbscrew (3, Fig.1).
- ❷ **Viewfinder** -
  - a. **ETX-90EC: 8 x 21mm Viewfinder:** Slide the eyepiece end of the viewfinder through the *front* of the viewfinder bracket (1, Fig. 5).
  - b. **ETX-105EC, ETX-125EC: 8 x 25mm Right-Angle Viewfinder:** Slide the front cell end of the right-angle viewfinder through the *rear* of the viewfinder bracket (2, Fig. 5).
- ❸ **Eyepiece Holder Thumbscrew** - Tightens the eyepiece in place. Tighten to a firm feel only.
- ❹ **90° Eyepiece Holder** - Holds the eyepiece upright for easy viewing.
- ❺ **Optical Tube** - The main optical component that gathers the light from distant objects and brings this light to a focus for examination with the eyepiece.
- ❻ **Vertical Lock** - Controls the manual vertical movement of the telescope. Turning the vertical lock counterclockwise unlocks the telescope enabling it to be freely rotated by hand about the vertical axis. Turning the vertical lock clockwise (to a firm feel only) prevents the telescope from being moved manually, but engages the vertical motor drive clutch for Electronic Controller operation. When polar aligned, the vertical lock serves as the Declination, or Dec. lock (see **DECLINATION**, page 16).

*Note: The vertical lock knob is a knurled knob located on the fork arm to the right of the focus knob (8, Fig. 1). Mounted beneath the knob is a circular scale with no numbers. Do not confuse this scale with the Dec. setting circle (16, Fig. 1) on the opposite fork arm which has a numbered scale used to locate astronomical objects.*

**CAUTION:** When loosening the vertical lock, be sure to support the optical tube (5, Fig. 1). The tube may swing downward suddenly and damage the telescope.
- ❼ **Fork Arms** - Hold the optical tube in place.

*Note: The telescope base and fork mount are designed with internal "rotational limit stops." The horizontal limit stop prevents the telescope from rotating more than 360° to avoid damage to the internal wiring. The vertical limit stop prevents the viewfinder from contacting the fork mount when the telescope is pointed upward just past 90° and prevents the optical tube from contacting the base if pointed downward more than 30°. Do not force the telescope to move beyond these stops or damage to the telescope will result.*
- ❽ **Focus Knob** - Moves the telescope's optical tube (5, Fig. 1) in a finely-controlled motion to achieve precise image focus. The ETX telescopes can be focused on objects from a distance of about 11.5 ft (ETX-90EC) or 15 ft (ETX-105EC or ETX-125EC) to infinity. Rotate the focus knob clockwise to focus on distant objects, and counterclockwise to focus on nearby objects.
- ❾ **Horizontal Lock** - Controls the manual horizontal rotation of the telescope. Loosen the horizontal lock counterclockwise to unlock the telescope, enabling it to be freely rotated by hand about the horizontal axis. Tightening the horizontal lock clockwise prevents the telescope from being rotated manually, but engages the horizontal motor drive clutch for Electronic Controller operation. When polar aligned, the horizontal lock serves as the Right Ascension, or R.A. lock (see **RIGHT ASCENSION**, page 16).

**10 Computer Control Panel**

**A. ON/OFF Switch** - Turns the Computer Control Panel and Electronic Controller ON or OFF.

*Note: Always remove the batteries if they are not to be used for a long period of time.*

**B. Auxiliary (AUX) Ports (2)** - Provide connection for current and future Meade accessories, such as the Meade "AstroFinder Software with #505 Cable Connector Kit," which allows you to control your ETX from a PC. See **OPTIONAL ACCESSORIES**, page 20.

**C. Handbox (HBX) Port** - Plug the Electronic Controller or the optional #497 Autostar handbox into this port.

**D. 12v:** The 12v connector is designed to accept an external power supply such as the optional #541 AC Adapter or the #607 Power Cord (see **OPTIONAL ACCESSORIES**, page 20). When one of the external power supply options is used, the internal batteries are disconnected from the power circuit.

**E. LED** - The red power indicator light illuminates when power is supplied to the connected handbox and to the telescope's motor drive.

**11 Base Housing** - Supports the telescope for placement on a flat, level surface, such as a tabletop or optional tripod. See **OPTIONAL ACCESSORIES**, page 20.

**12 Holes for Optional Tripod** - See your tripod's instruction sheet for mounting information.

**13 Right Ascension (R.A.) Setting Circle** - See page 28 for detailed information.

**14 Flip-Mirror and Flip-Mirror Control Knobs** - ETX telescopes include an internal mirror. With the flip-mirror control in the "up" position, as shown in **Fig. 2a**, light is diverted to the eyepiece. With the flip-mirror control in the "down" position, as shown in **Fig. 2b**, light proceeds straight out the photo port for photography. See **PHOTOGRAPHY**, page 18.

*Note: The flip-mirror control is in the "up" position when the control is vertical (perpendicular to the telescope tube). To place the flip-mirror in the "down" position, turn the control until it is horizontal.*



**Fig. 2a:** Flip mirror control in the "up" position.



**Fig. 2b:** Flip mirror control in the "down" position.

**15 Photo Port** - Attach any 35mm camera with a removable lens to this port using an optional #64ST T-Adapter or attach the #932 Erecting Prism for correctly oriented images through the eyepiece. See **OPTIONAL ACCESSORIES**, page 20.

**16 Declination (Dec.) Setting Circle** (on left fork arm) - See page 28 for detailed information.

**17 Viewfinder Alignment Screws** -Adjust these screws to align the viewfinder. See pages 9 through 11 for more information.

**18 Viewfinder Alignment Bracket** -Attach the viewfinder to this bracket. See pages 9 through 11 for more information.

**19 Dust Cap** - Unthread the dust cap counterclockwise from the front lens of the telescope.

*Note: The dust cap should be replaced after each observing session and the power turned off to the telescope. Verify that any dew that might have collected during the observing session has evaporated prior to replacing the dust cap. Do not overtighten.*

**20 Battery Compartment (not shown, underneath base)** - Install eight user-supplied AA batteries in this compartment. See page 9 for more information.

## Electronic Controller Functions

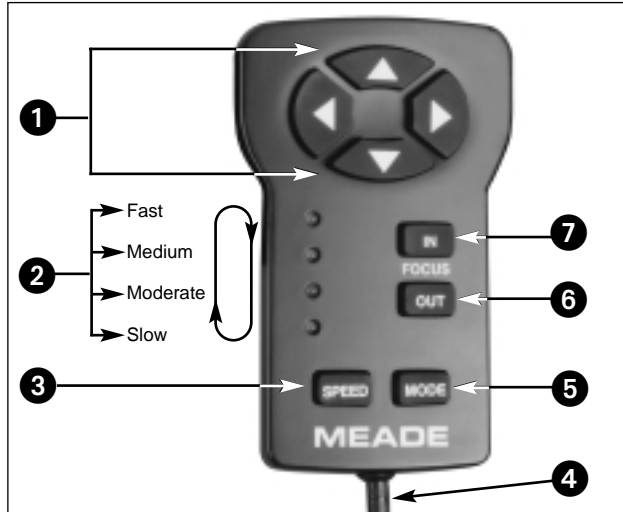

**Fig. 3:** Electronic Controller. (1) Arrow Keys; (2) Indicator Lights; (3) SPEED Key; (4) Coil Cord; (5) MODE Key; (6) OUT Key; (7) IN Key.

The Electronic Controller provides you with the means to control the telescope motors from a compact handbox. The Electronic Controller (**Fig. 3**) has soft-touch keys designed to have a positive feel, even through gloves.

The primary functions of the Electronic Controller are to move (slew) the telescope to an object, indicate the slew speed, and to operate the optional #1244 (ETX-90EC or ETX-105EC) or #1247 (ETX-125EC) Electric Focuser (see **OPTIONAL ACCESSORIES**, page 20). Other functions are also possible when using the MODE key. A detailed description of the functions and operation of the Electronic Controller is found in **ADVANCED ELECTRONIC CONTROLLER FUNCTIONS**, page 26.

- ➊ **Arrow Keys (1, Fig. 3):** Press one of the four Arrow keys to slew the telescope (*i.e.*, up, down, left, and right) at any one of four slew speeds (see **SPEED KEY** below).

***Important Note:** If you reverse directions while using the Arrow keys to slew to objects, there may be a slight pause as the telescope motors compensate for the reversal of the internal gears.*

- ➋ **Indicator Lights (2, Fig. 3):** The four red LED (Light Emitting Diode) lights indicate the current slew speed of the telescope.

***Note:** For purposes of this manual, the lights are identified as 1 through 4, with 1 being the top light and 4 being the bottom light.*

- ➌ **SPEED Key (3, Fig. 3):** Press the SPEED key to change the speed at which the telescope slews to an object. Each press of the SPEED key changes the slew speed to the next *slower* setting. If the controller is already on the slowest slew speed (light 4), pressing the SPEED key cycles back to the highest speed (light 1). Slew speeds are signified by the indicator lights (**2, Fig. 3**).

- ➍ **Coil Cord (4, Fig. 3):** Plug into the HBX connector of the Computer Control Panel.

- ➎ **MODE Key (5, Fig. 3):** Press and hold the MODE key to place the Electronic Controller into the Mode function (see **APPENDIX A**, page 26).

- ➏ **OUT Key (6, Fig. 3):** When using the optional #1244 (ETX-90EC or ETX-105EC) or #1247 (ETX-125EC) Electric Focuser (see **OPTIONAL ACCESSORIES**, page 20), press the OUT key to move the focus point outward.

- ➐ **IN Key (7, Fig. 3):** When using the optional #1244 (ETX-90EC or ETX-105EC) or #1247 (ETX-125EC) Electric Focuser (see **OPTIONAL ACCESSORIES**, page 20), press the IN key to move the focus point inward.

Light No.	Light Status
● Light 1	● On
● Light 2	☀ Blinking
● Light 3	○ Off
● Light 4	

### Indicator Light Key

The procedures in this manual identify the status of the four indicator lights as depicted above: *on*, *blinking*, or *off*.



## GETTING STARTED

### Parts List

ETX telescopes are assembled virtually complete at the Meade factory. Getting the telescope ready for first observations requires only a few minutes. When first opening the packing box, note carefully the following parts:

- The ETX Astro Telescope with fork-mount system.
- Electronic Controller with attached coil cord.
- Viewfinder.
- Super Plössl (SP) 26mm eyepiece, packed in a plastic storage container.
- Hex-wrench set (2 wrenches), packed with the manual.

The viewfinder is packed separately from the main telescope to avoid the possibility of the viewfinder slipping in its bracket and scratching during shipment.

### Assembly Instructions

Assembly of your telescope requires the following procedures: install batteries, insert an eyepiece, attach the viewfinder, and plug in the handbox.

### Install the Batteries

Assembly of all three of the ETX model telescopes requires eight user-supplied AA-size batteries and the following steps:

The telescope's battery compartment (6, Fig. 4) is at the bottom of the drive base. Place the telescope securely on its side as shown in Fig. 4. Open the battery compartment by simultaneously depressing the two release latches (4, Fig. 4) and pulling the battery cover (5, Fig. 4) away from the drive base. Insert eight AA-size batteries into the battery compartment, oriented as shown on the battery mounting board. Slide and snap the cover back in place. Return the telescope to an upright position.

### Insert an Eyepiece

Remove the SP 26mm eyepiece (1, Fig. 1) from its container and place it in the eyepiece holder (4, Fig. 1). Tighten the thumbscrew (3, Fig. 1) to a firm feel only.

### Plug in the Handbox

Be certain that the power switch on the Computer Control panel (10A, Fig. 1) is in the OFF position. Plug the coil cord of the Electronic Controller into the HBX port (10C, Fig. 1).

### Attach the Viewfinder

**ETX-90EC: 8 x 21mm Viewfinder:** Slide the eyepiece end of the viewfinder through the front of the viewfinder bracket (1, Fig. 5).

**ETX-105EC or ETX-125EC: 8 x 25mm Right-Angle Viewfinder:** Slide the front cell end of the right-angle viewfinder through the rear of the viewfinder bracket (2, Fig. 5).

Unthread the six alignment screws slightly to fit the viewfinder through the bracket. With the viewfinder in place, tighten the six alignment screws to a firm feel only against the viewfinder tube.

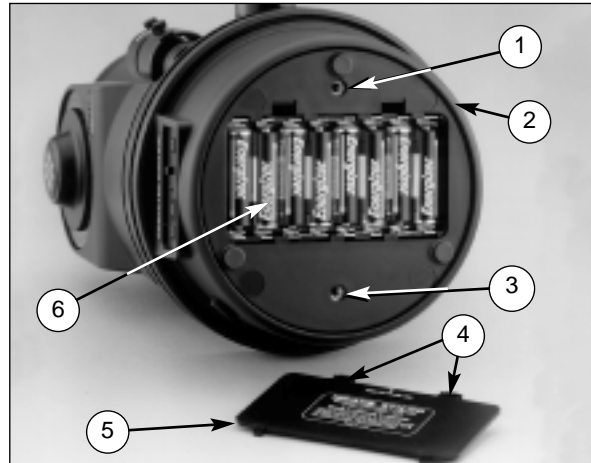

**Fig. 4:** Bottom view of an ETX showing eight AA-size batteries mounted inside the battery compartment. (1) High-latitude tripod leg hole; (2) Drive base; (3) Alternate tripod leg hole; (4) Release latches; (5) Battery compartment cover; (6) Battery compartment.



## TIPS FOR BEGINNERS



### Join an Astronomy Club

### Attend a Star Party

One fun way to learn about astronomy is to join an astronomy club. Check your local newspaper, school, library, or telescope dealer/store to find out if there's a club in your area.

At club meetings, you will meet other astronomy enthusiasts with whom you will be able to share your discoveries. Clubs are an excellent way to learn more about observing the sky, to find out where the best observing sites are, and to compare notes about telescopes, eyepieces, filters, tripods, and so forth.

Often, club members are excellent photographers. Not only will you be able to see examples of their art, but you may even be able to pick up some "tricks of the trade" to try out on your ETX telescope. See page 18 for more information about photography with the ETX.

Many groups also hold regularly scheduled Star Parties at which you can check out and observe with many different telescopes and other pieces of astronomical equipment. Magazines such as *Sky & Telescope* and *Astronomy* print schedules for many popular Star Parties around the United States and Canada.

### Using The Viewfinder

As with most astronomical telescopes, the ETX model telescopes present a fairly narrow field of view to the observer. As a result it is sometimes difficult to locate and center objects in the telescope's field of view. The viewfinder, by contrast, is a low-power, wide-field sighting scope with crosshairs that let you easily center objects in the eyepiece of the main telescope's field of view. The telescope viewfinder is a great help in locating faint astronomical objects before you begin observing through the telescope eyepiece.

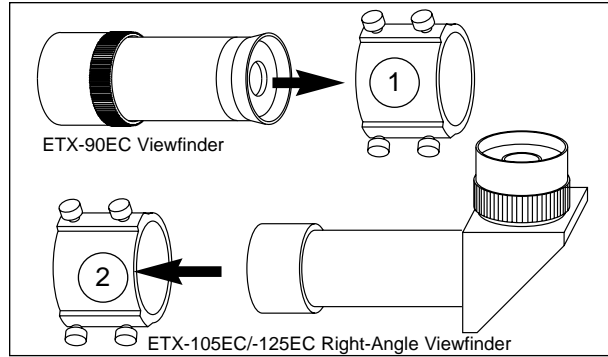

Fig. 5: Viewfinder Installation.

#### ETX-90EC 8 x 21mm Erect-Image Viewfinder:

Standard equipment with the ETX-90EC, the 8 x 21mm Erect-Image Viewfinder has 8-power magnification and an aperture of 21mm. **This viewfinder presents a correctly oriented image both up-and-down and left-to-right.**

#### ETX-105EC or ETX-125EC 8 x 25mm Right-Angle Viewfinder:

Standard equipment with the ETX-105EC and ETX-125EC, the 8 x 25mm Right-Angle Viewfinder has 8-power magnification and an aperture of 25mm. **This viewfinder presents a correctly oriented image up-and-down, but is reversed left-for-right.**

### Focusing the Viewfinder

The ETX model viewfinders are pre-focused at the factory. Individual eye variations may require that the viewfinder be re-focused. To check the focus, point the viewfinder at a distant terrestrial (land) object such as a telephone pole or light pole and look through the viewfinder. If the viewfinder image is not in sharp focus, follow the procedure below that applies to your telescope model.

#### ETX-90EC

1. Remove the viewfinder by slightly unthreading the six alignment screws (4 and 6, Fig. 6) and slipping it out of the bracket.
2. Loosen the knurled lock-ring (2, Fig. 6) located near the viewfinder's front lens cell (1, Fig. 6). Unthread this ring (*counterclockwise*, as seen from the eyepiece-end of the viewfinder) by several turns.
3. Look through the viewfinder and focus on a distant object. Slowly rotate the front lens cell in one direction or the other, until the object appears sharp. One or two rotations of the lens may have a significant effect on image focus.
4. Lock the focus in place by threading the knurled lock-ring *clockwise* up against the viewfinder's lens cell.
5. Replace the viewfinder into the viewfinder bracket. Gently tighten the six alignment screws. Proceed with **Aligning the Viewfinder.**

#### ETX-105EC or ETX-125EC

Turn the focus ring (2, Fig. 6) at the base of the viewfinder eyepiece (3, Fig. 6) in either direction until a sharp focus is reached.

### Aligning the Viewfinder

In order for the viewfinder to be useful, it must first be aligned with the main telescope, so that both the viewfinder and the main telescope are pointing at precisely the same location. To align the viewfinder:

1. Turn the three *rear* alignment screws of the viewfinder bracket (6, Fig. 6) so that the viewfinder tube is roughly centered within the viewfinder bracket.

**Tip:** Do not overtighten the alignment screws. When tightening one screw it may be necessary to loosen one or both of the two other alignment screws.

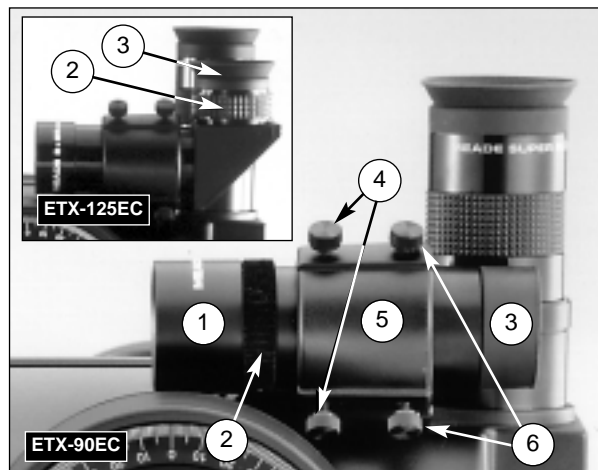
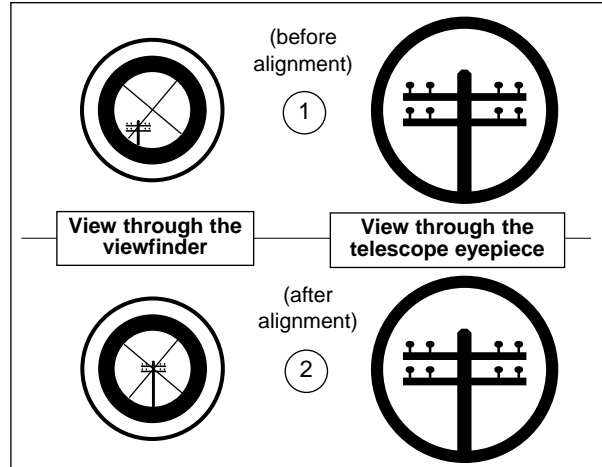

Fig. 6: The Viewfinder. (1) Front lens cell; (2) Knurled lock-ring (ETX-90EC) or focus ring (ETX-105EC and ETX-125EC); (3) Viewfinder eyepiece; (4) Front alignment screws (one not visible in photo); (5) Viewfinder bracket; (6) Rear alignment screws (one not visible).

- Point the main telescope at some easy-to-find, well-defined land object, such as the top of a telephone pole. Center the object, as precisely as possible, in the SP 26mm eyepiece's field of view, then tighten the vertical and horizontal locks (6 and 9, Fig. 1) so that the tube cannot move and the object remains centered (1, Fig. 7).
- While looking through the viewfinder, turn one or more of the three front viewfinder alignment screws (4, Fig. 6), until the crosshairs of the viewfinder point at precisely the same position as the view through the eyepiece of the main telescope (2, Fig. 7).



**Fig. 7:** Aligning the Viewfinder.

Check that the viewfinder's crosshairs and the main telescope are now pointing at precisely the same object. The viewfinder is now aligned to the main telescope. Unless the alignment screws are disturbed or the viewfinder jarred, the viewfinder should remain aligned indefinitely.

*Tip: If you plan on viewing using higher magnification eyepieces, first locate, center, and focus the object using a low-power eyepiece (e.g., SP 26mm eyepiece). Then remove the low-power eyepiece and replace it with a higher-power eyepiece; the object should still be centered in the field of view. Objects are much easier to locate and center at lower powers; higher powers are employed simply by changing eyepieces.*

## OBSERVATION TECHNIQUES

The ETX model telescopes can be used for immediate observation right out of the box. However, becoming familiar with the fundamentals of a telescope makes subsequent viewing easier and more rewarding.

### Choosing an Eyepiece

A telescope's eyepiece magnifies the image formed by the telescope's main optics. Each eyepiece has a focal length, expressed in millimeters, or "mm." The smaller the focal length, the higher the magnification. For example, an eyepiece with a focal length of 9mm has a higher magnification than an eyepiece with a focal length of 26mm.

The SP 26mm eyepiece, supplied with your telescope, gives a wide, comfortable field of view with high image resolution, while an optional SP 12.4mm eyepiece, for example, provides a smaller field of view but higher magnification when seeing conditions permit.

Low-power eyepieces offer a wide field of view, bright, high-contrast images, and less eyestrain during long observing sessions. To find an object with a telescope, always start with a low-power eyepiece such as the SP 26mm. When the object is located and centered in the eyepiece, you may wish to switch to a higher-power eyepiece to enlarge the image as much as practical for prevailing seeing conditions.

*Note: Seeing conditions vary widely from night-to-night and from site-to-site. Turbulence in the air, even on an apparently clear night, can distort images. If an image appears fuzzy and ill-defined, back off to a lower-power eyepiece for a more well-resolved image (Fig. 8a and 7b).*

TIPS FOR BEGINNERS

### Too Much Power?

Can you ever have too much power? If the type of power you're referring to is eyepiece magnification, yes, you can! The most common mistake of the beginning observer is to "overpower" his or her telescope by using high magnifications which the telescope's aperture and atmospheric conditions cannot reasonably support. Keep in mind that a smaller, but bright and well-resolved image is far superior to one that is larger, but dim and poorly resolved (see below). Powers above 300X should be employed only under the steadiest atmospheric conditions.

Most observers should have three or four additional eyepieces to achieve the full range of reasonable magnifications possible with the ETX telescopes. See **OPTIONAL ACCESSORIES**, page 20.

Fig. 8a & b: Jupiter; example of too much magnification.

## Understanding Magnification

The magnification, or power, at which a telescope is operating is determined by two factors: the *focal length of the telescope* and the *focal length of the eyepiece employed*.

**Telescope Focal Length** is the distance that light travels inside the telescope before reaching a focus. In the mirror-lens design of the ETX models, however, this focal length is, in effect, compressed by the telescope's secondary mirror, so that a long effective focal length is housed in the short ETX optical tube. For example, the ETX-90EC's focal length is 1250mm, or about 49". This means that if the ETX-90EC were a classical refracting-type of telescope, the optical tube would be more than four feet long instead of the ETX-90EC's compact 11" tube length.

**Eyepiece Focal Length** is the distance light travels inside the eyepiece before reaching focus. Focal length is usually printed on the side of the eyepiece. For instance, the Super Plössl (SP) 26mm eyepiece supplied with the three ETX models has a focal length of 26mm. "Super Plössl" refers to the optical design of the eyepiece, a design specifically intended for high-performance telescopes and one which yields a wide, comfortable field of view with extremely high image resolution.

**Technical note to the advanced amateur astronomer:** The SP 26mm eyepiece supplied with the Meade ETX-90EC, ETX-105EC, and ETX-125EC is a special low-profile version of the standard Meade SP 26mm eyepiece which is about 1/4" (6mm) shorter than the standard eyepiece. This low-profile SP 26mm is designed to work in harmony with the ultracompact scale of the ETX models and utilizes the exact same optics as the standard SP 26mm eyepiece. The SP 26mm low-profile eyepiece is not parfocal with other eyepieces in the SP series (i.e., the eyepiece requires re-focusing when it is interchanged with other SP eyepieces).

**Calculating Magnification:** On a telescope, such as the ETX, different eyepiece focal lengths are used to achieve different magnifications, from low to high. The standard-equipment SP 26mm eyepiece yields 48X ("48-power") on the ETX-90EC, 57X on the ETX-105EC, and 73X on the ETX-125EC. A variety of powers may be obtained with the addition of optional eyepieces as well as the #126 2X Barlow Lens which doubles the power of an eyepiece (see **OPTIONAL ACCESSORIES**, page 20).

$$\text{Power} = \frac{\text{Telescope Focal Length}}{\text{Eyepiece Focal Length}}$$

**Example:** To obtain the power of an ETX-125EC (which has a 1900mm focal length) using a SP 26mm eyepiece:

$$\text{Power} = \frac{1900\text{mm}}{26\text{mm}} = 73\text{X}$$

Use this formula to calculate the magnification obtained with a given eyepiece:

Most observers should have 3 or 4 eyepieces plus the #126 2X Barlow to achieve the full range of reasonable magnifications possible with ETX models.

## Terrestrial Observing

All three of the ETX models make excellent, high-resolution terrestrial (land) telescopes. When you set the telescope on its drive base, as shown below in **Fig. 9**, you may use it for an extremely wide range of observations. When you look through the eyepiece at a terrestrial object, you will notice that the image is right-side-up, but reversed left-for-right. Normally, such an image orientation is not bothersome, unless you are trying to read a distant sign, for example. If the telescope is to be used for extensive terrestrial observations, a fully correctly oriented image is provided with the #932 45° Erecting Prism (see **OPTIONAL ACCESSORIES**, page 20).

Viewing terrestrial objects requires looking along the Earth's surface through heat waves. Heat waves often degrade image quality. Low-power eyepieces, like the SP 26mm eyepiece, magnify these heat waves less than higher-power eyepieces. Therefore, low-power eyepieces provide a steadier, higher-quality image. If the image in an eyepiece is fuzzy or ill-defined, reduce to a lower power. Observing in the early

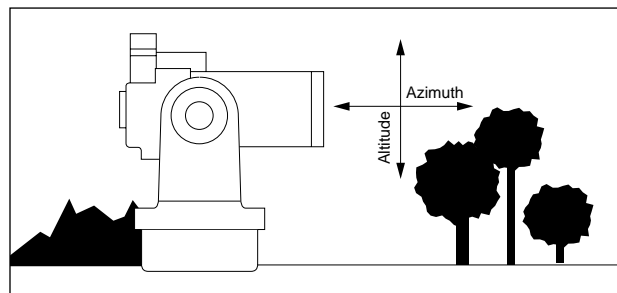

**Fig. 9:** Alt/Az mounting moves the telescope in vertical and horizontal directions.

### Note:

Throughout this manual, you will notice the term "Alt/Az." Alt/Az is frequently used to refer to altitude or vertical and azimuth or horizontal. Alt/Az is just one of many methods used by amateur astronomers to help locate stars in the night sky.

morning hours, before the ground has built up internal heat, results in better viewing conditions than during the late-afternoon hours.

If you wish to observe a distant land object, such as a mountain top or a bird, you can observe by merely pointing the telescope and looking through the eyepiece. Set the telescope on a table top or tripod, loosen the horizontal and vertical locks (6 and 9, Fig. 1), and turn the telescope towards the object you wish to observe. Look into the viewfinder and move the tube until you find the object. If the viewfinder is correctly aligned, the object now appears in the eyepiece. Center the object and focus the image using the by turning the focus knob (8, Fig. 1). Rotate the knob clockwise to focus on distant objects and counterclockwise to focus on nearby objects.

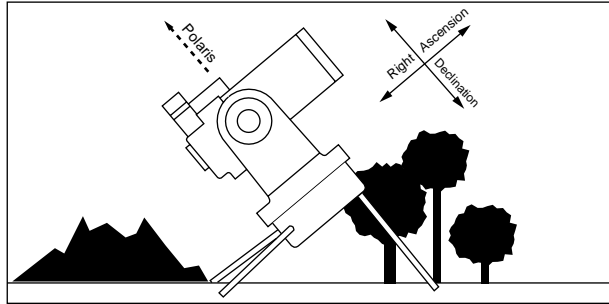

**Fig. 10:** Equatorial mounting aligns the telescope with the celestial sphere (table-top tripod legs optional).

### Astronomical Observing

As an astronomical instrument, your ETX telescope has many optical and electromechanical capabilities. It is in astronomical applications where the high level of optical performance is readily visible. The range of observable astronomical objects is, with minor qualification, limited only by the observer's motivation.

### Sidereal Rate

As the Earth rotates beneath the night sky, the stars appear to move from East to West. The speed at which the stars move across the sky is called the *sidereal rate*.

You can observe stars and objects in the night sky using the terrestrial viewing method, but note that objects begin to slowly drift across and out of the eyepiece field. This motion is caused by the rotation of the Earth.

You can counteract the drift by mounting the telescope to one of the optional tripods in the polar mode (see **POLAR ALIGNMENT PROCEDURE**, page 16). In this mode, the motor drive in each ETX model is designed to rotate the telescope at the sidereal rate so that it automatically follows, that is, "tracks" the stars. Tracking makes it easier to locate objects and to keep them centered in the telescope's eyepiece. The Electronic Controller supplied with your telescope assists with the tracking function.



**Fig. 11:** Electronic Controller.

### The Electronic Controller

Functions of the Electronic Controller include:

- Slewing (moving) the telescope's optical tube assembly to an object
- Turning on the telescope motor drive to automatically track celestial objects (when the telescope is polar aligned)
- Changing the hemisphere of operation, when required
- Changing tracking speed (see **APPENDIX A**, page 26)

### Slew Speeds

The Electronic Controller has four slew speeds that are directly proportional to the sidereal rate. Press the Speed key to change the slew speed. Note each slew speed corresponds to one of the four LED's of the Electronic Controller.

TIPS FOR BEGINNERS

- Try to pick an observing site away from street and house lights, and car headlights. While this is not always possible, the darker the site, the better.
- Give your eyes about ten minutes to adjust to the darkness before observing. Give your eyes a rest from observing every ten or fifteen minutes to relieve eyestrain.
- Try not to use a standard flashlight. Seasoned observers use red LED flashlights or tape red cellophane over their flashlights for setup and map reading so they don't have to continually readjust their eyes to the darkness. Be careful not to shine bright lights if there are other observers in the area. Never shine a flashlight into a telescope while someone is observing!
- Dress warmly. It gets chilly when you're sitting for prolonged periods, even on some summer nights.
- Practice setting up your equipment during the day or in a lighted area to become familiar with it before going to a dark site.
- Use your 26mm eyepiece to view terrestrial objects and wider areas of space, such as open star clusters. Use your higher power eyepieces when you wish to view something up close, such as craters on the Moon or the rings of Saturn.
- Know your observing site. If you're going to try out an unfamiliar site, check it out in the daylight for possible obstructions and pitfalls.

**Light 1 (top LED):** The fastest speed. Use to move the telescope quickly from one point in the sky to another.

**Light 2:** Best for centering an object in the viewfinder.

**Light 3:** Best for centering an object in the field of a low-to-moderate power eyepiece, such as the standard SP 26mm.

**Light 4:** The slowest speed. Use to center an object in the field of view of high-power eyepieces, such as the optional 6.7mm or 12.4mm.

The four available speeds are:

- Light 1 = 1200 x sidereal (300 arc-min/sec or 5°/sec)
- Light 2 = 180 x sidereal (45 arc-min/sec or 0.75°/sec)
- Light 3 = 32 x sidereal (8 arc-min/sec or 0.13°/sec)
- Light 4 = 8 x sidereal (2 arc-min/sec or 0.034°/sec)

The two slowest speeds (8x and 32x sidereal) can be used for pushbutton (manual) tracking of astronomical objects while observing through the eyepiece.

### Modes of Operation

The Electronic Controller can be set to operate in either of two primary modes: the **Alt/Az** mode (used when the telescope is operated in the altazimuth configuration; see below) and the **polar** mode (used when the telescope is polar- (or equatorial) aligned; see page 16).

- Choose the **Alt/Az** (altitude-azimuth, or vertical-horizontal) mode for all terrestrial operations of the telescope. In the Alt/Az mode, use the Arrow keys to slew the telescope to terrestrial or astronomical objects and, once you locate them, follow these objects if they move. However, in this mode astronomical tracking is *not* automatic and requires continuous pushes of the Arrow keys. *The Electronic Controller is factory pre-set to the Alt/Az mode.*
- Choose the **polar** mode when the telescope is equipped with either the optional #880 (ETX-90EC) or #881 (ETX-105EC or ETX-125EC) Table Tripod, or #883 Deluxe Field Tripod, for extensive astronomical observations. In this mode use the Arrow keys to slew the telescope to objects. In addition, the telescope's internal motor drive is turned on, enabling the telescope to automatically track celestial objects.

You can configure the two screws on the bottom rear of the Electronic Controller handbox to change the default mode of the Electronic Controller to Alt/Az or polar. When in polar mode, you may also set the alignment to the hemisphere in which you are located (not necessary in the Alt-Az mode).

**Caution:** Mode screws A and B are the outer screws in the recess directly under the letters A and B on the rear of the Electronic Controller. Do not remove either of the inner two screws in the recess.

- Remove mode screw A (1, Fig. 12) to make the *Northern hemisphere polar* mode the automatic default of the Electronic Controller when power is applied (*i.e.*, the motor drive is activated for operation in the Earth's Northern Hemisphere).
- Remove mode screw B (2, Fig. 12) to make the *Southern Hemisphere polar* mode the automatic default of the Electronic Controller when power is applied (*i.e.*, the motor drive is activated for operation in the Earth's Southern Hemisphere).
- Leave both the A and B screws in place (or remove both screws) to keep the telescope in the original factory default Alt/Az mode.

**Note:** Removing either A or B screw affects only the telescope's default mode; you may still make mode changes when desired using the MODE key (see, **APPENDIX A**, page 26).

### Telescope Mountings

A mount allows a telescope to move on its axes. The two basic types of mounting are Altazimuth (Alt/Az) and Polar (Equatorial).

#### Alt/Az Mode

**Altazimuth (Alt/Az) mounting** permits movement of the telescope tube in vertical (altitude) and horizontal (azimuth) directions. The ETX models incorporate an altazimuth mount (as shown in Fig. 9), ideal for terrestrial

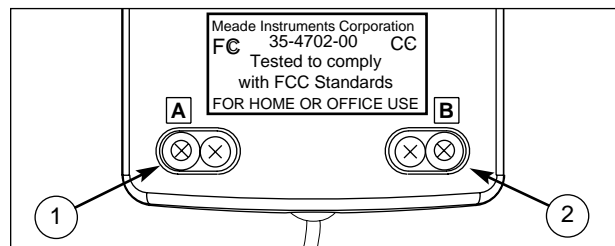

**Fig. 12:** Mode screws on rear of Electronic Controller. (1) Mode screw A; (2) Mode screw B.

applications and for casual astronomical observation. The telescope may be placed on a rigid tabletop or on the optional Meade #883 Deluxe Field Tripod (see **OPTIONAL ACCESSORIES**, page 20) to provide a secure, variable-height, altazimuth observing platform. To manually track objects with the telescope in the altazimuth configuration, press the Arrow keys of the Electronic Controller as necessary to keep an object centered.

**Note:** Automatic tracking of objects is not possible with the ETX-90 EC, ETX-105EC and the ETX-125EC in the Alt/Az mounting.

With the Electronic Controller in the factory pre-set "Alt/Az" (vertical-horizontal) mode, the Electronic Controller Arrow keys permit pushbutton movements (slewing) of the telescope.

#### To move the telescope using the Electronic Controller:

1. Set the telescope on a level and stable surface, or mount to the Meade #883 Deluxe Field Tripod (see **OPTIONAL ACCESSORIES**, page 20).
2. Insert a low-power eyepiece (e.g., SP 26mm) into the eyepiece holder (**4, Fig. 1**) and tighten the eyepiece thumbscrew (**3, Fig. 1**).
3. Tighten the vertical and horizontal locks (**6 and 9, Fig. 1**), if necessary.
4. Verify that the power switch (**10A, Fig. 1**) on the telescope's Computer Control panel is OFF.
5. Plug in the Electronic Controller coil cord (**4, Fig. 3**) to the HBX port (**10C, Fig. 1**) on the Computer Control panel.
6. Flip the power switch to ON. The power indicator (**10E, Fig. 1**) on the Computer Control panel lights and all four speed indicators (**2, Fig. 3**) blink rapidly.
7. Press any key on the Electronic Controller and the telescope slews momentarily in the vertical and horizontal directions to test the motors.
8. When the test is complete, light 1 remains on; lights 2, 3, and 4 turn off.
9. Use the four Arrow keys (**1, Fig. 3**) to slew the telescope to the desired object. To change the slew speed, press the SPEED key.
10. Fine-adjust the position of the object with the Electronic Controller Arrow keys so that it is centered in the viewfinder. The object is now ready to be viewed through the telescope's eyepiece.

#### Polar Mode

If you are to use your ETX-90EC, ETX-105EC, or ETX-125EC telescope for extensive astronomical applications, it is recommended you use **Polar or Equatorial mounting**. By tilting one of the telescope's mechanical axes (see **Fig. 10**) to point at the celestial pole (i.e., by pointing one axis of the telescope to the North Star, Polaris), you may follow (track) astronomical objects through the sky.

The telescope's optical tube turns on only one axis of the telescope instead of simultaneously turning on two axes, as required of the Altazimuth mount. *An Equatorial mount which has one of its axes (the polar axis) pointing to the celestial pole is said to be polar aligned.* The ETX models can be polar aligned either by using the optional #883 Deluxe Field Tripod or the table tripod specific to your model of ETX telescope (see **OPTIONAL ACCESSORIES**, page 20).

With the ETX polar aligned, the telescope's internal motor drive may be activated (see **APPENDIX A**, page 26) to enable fully automatic hands-off tracking of celestial objects. In this



**TIPS FOR BEGINNERS**

### Surf the Web

One of the most exciting resources for astronomy is the Internet. The Internet is full of websites with new images, discoveries, and the latest astronomical information. For example, when comet Hale-Bopp made its approach to our Sun in 1998, astronomers around the world posted new photos daily.

You can find websites for virtually any topic relating to astronomy on the internet. Try the following key word searches: NASA, Hubble, HST, astronomy, Messier, satellite, nebula, black hole, variable stars, extrasolar, Chandra, gamma burster, etc.

Check out Meade's website for the latest product and technical information. You can download the latest software revisions, links to other astronomical sites, coordinates of celestial objects and the latest satellite tracking information for the optional #497 Autostar handset. See page 20 for more information. You'll find our website at:

<http://www.meade.com/>

Here are some other sites you might find useful:

- *Sky & Telescope:*  
<http://www.skypub.com/>
- *Astronomy:*  
<http://www.astronomy.com/astro/>
- *The Starfield:*  
<http://users.nac.net/gburke/>
- *Astronomy Picture of the Day:*  
<http://antwrp.gsfc.nasa.gov/apod/>
- *Heavens Above (satellite observing information):*  
<http://www.heavens-above.com/>
- *Photographic Atlas of the Moon:*  
[http://www.lpi.ursa.edu/research/lunar\\_orbiter](http://www.lpi.ursa.edu/research/lunar_orbiter)
- *Hubble Space Telescope Public Pictures*

configuration the observer does not need to press the Arrow keys of the Electronic Controller in order to track celestial objects. However, the Arrow keys of the Electronic Controller are useful in this configuration to enable the centering of objects within the telescopic field or, for example, to move the telescope over the surface of the Moon or through a large star field.

### Celestial Coordinates

Before polar aligning your ETX model, it is helpful to understand how to locate celestial objects as they move across the sky.

A celestial coordinate system was created that maps an imaginary sphere surrounding the Earth upon which all stars appear to be placed. This mapping system is similar to the system of latitude and longitude on Earth surface maps.

In mapping the surface of the Earth, lines of longitude are drawn between the North and South Poles and lines of latitude are drawn in an East-West direction, parallel to the Earth's equator. Similarly, imaginary lines have been drawn to form a latitude and longitude grid for the celestial sphere. These lines are known as **Right Ascension** and **Declination**.

The celestial map also contains two poles and an equator just like a map of the Earth. The poles of this coordinate system are defined as those two points where the Earth's north and south poles (*i.e.*, the Earth's axis), if extended to infinity, would cross the celestial sphere. Thus, the North Celestial Pole (**1, Fig. 13**) is that point in the sky where an extension of the North Pole intersects the celestial sphere. The North Star, Polaris is located very near the North Celestial Pole (**1, Fig. 13**). The celestial equator (**2, Fig. 13**) is a projection of the Earth's equator onto the celestial sphere.

So just as an object's position on the Earth's surface can be located by its latitude and longitude, celestial objects may also be located using Right Ascension and Declination. For example, you could locate Los Angeles, California, by its latitude (+34°) and longitude (118°). Similarly, you could locate the Ring Nebula (M57) by its Right Ascension (18hr) and its Declination (+33°).

- **Right Ascension (R.A.):** This celestial version of longitude is measured in units of hours (hr), minutes (min), and seconds (sec) on a 24-hour "clock" (similar to how Earth's time zones are determined by longitude lines). The "zero" line was arbitrarily chosen to pass through the constellation Pegasus — a sort of cosmic Greenwich meridian. R.A. coordinates range from 0hr 0min 0sec to 23hr 59min 59sec. There are 24 primary lines of R.A., located at 15-degree intervals along the celestial equator. Objects located further and further East of the zero R.A. grid line (0hr 0min 0sec) carry higher R.A. coordinates.
- **Declination (Dec.):** This celestial version of latitude is measured in degrees, arc-minutes, and arc-seconds (*e.g.*, 15° 27' 33"). Dec. locations north of the celestial equator are indicated with a plus (+) sign (*e.g.*, the Dec. of the North celestial pole is +90°). Dec. locations south of the celestial equator are indicated with a minus (-) sign (*e.g.*, the Dec. of the South celestial pole is -90°). Any point on the celestial equator (such as the the constellations of Orion, Virgo, and Aquarius) is said to have a Declination of zero, shown as 0° 0' 0."

### Locating the Celestial Pole

To get basic bearings at an observing location, take note of where the sun rises (East) and sets (West) each day. After the site is dark, face North by pointing your left shoulder toward the direction where the sun set. To point at the pole, find Polaris by using the Big Dipper as a guide (**Fig. 14**).

### Polar Alignment Procedure

As the Earth rotates once on its axis every 24 hours, astronomical objects appear to move across the sky in an arc. This apparent motion (see **SIDEREAL RATE**, page 13) is not obvious to the unaided eye, but viewed through a telescope such as the ETX-90EC, ETX-105EC, or ETX-125EC, this motion is rapid indeed. If the motor drive has not been engaged, objects centered in the telescope's eyepiece move entirely out of the field of view in 30 to 160 seconds, depending on the magnification employed. For easy tracking of astronomical objects your ETX telescope should be *polar aligned*.

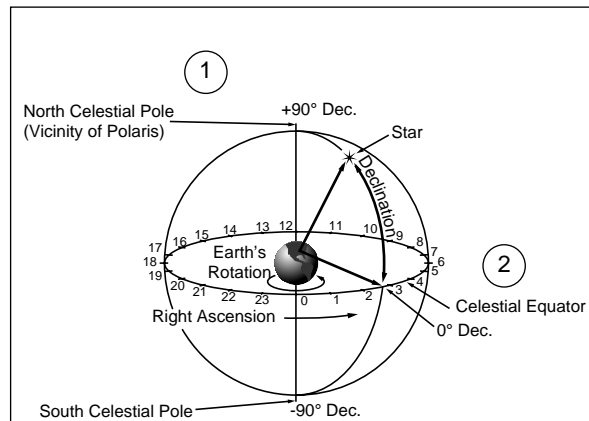

**Fig. 13: The Celestial Sphere.**



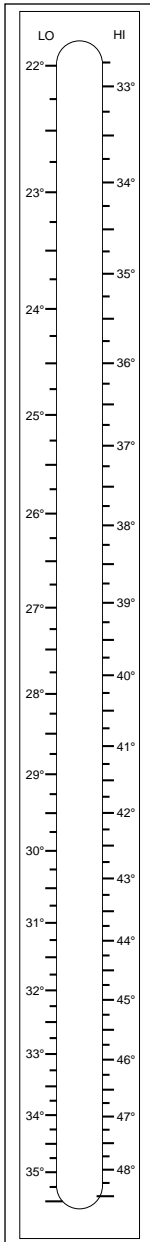

**Fig. 15:**  
Example of  
Standard Tripod  
Leg Latitude  
Scales.

There are two mounting methods available to polar align the telescope depending on whether you use the optional #883 Deluxe Field Tripod or a table tripod (specific to your model of ETX telescope).

To polar align using the #883 Deluxe Field Tripod (**Fig. 17**), follow the instructions provided with the tripod. To polar align using the #880 (ETX-90EC) or #881 Table Tripod (ETX-105EC or ETX-125EC, **Fig. 16**), use the following procedure.

1. Make sure the viewfinder is aligned with your ETX telescope (see **ALIGNING THE VIEWFINDER**, page 10).
2. Remove the two hole covers (**12, Fig. 1**) from the side of the drive base and thread the two identical fixed legs (**4, Fig. 16**) into these holes to a firm feel only.
3. Determine the latitude of the observing location from a road map, atlas, or the **Latitude Chart for Major Cities of the World**, page 27; determining the latitude within about one degree is sufficient.
4. Each table tripod is equipped with two adjustable tripod legs, only one of which will be used: The *standard tripod leg* is used at observing latitudes as shown in step 5 and has a dual latitude label attached (**Fig. 15**). The *high-latitude tripod leg* is shorter and is used at higher observing latitudes.
5. Locate the two mounting holes on the bottom of the telescope drive base. Mount the appropriate adjustable tripod leg to the drive base using the following latitudes:

**Standard Tripod Leg (ETX-90EC)**

32.5° to 48.5° uses *high-latitude* hole (**2, Fig. 16**). 22° to 35.5° uses *alternate* hole (**3, Fig. 16**).

**High-Latitude Tripod Leg (ETX-90EC)**

56° to 66° uses *high-latitude* hole. 44° to 55° uses *alternate* hole.

**Standard Tripod Leg (ETX-105EC, ETX-125EC)**

33.5° to 49.5° uses *high-latitude* hole. 23.25° to 36.5° uses *alternate* hole.

**High-Latitude Tripod Leg (ETX-105EC, ETX-125EC)**

56.6° to 67° uses *high-latitude* hole. 44.5° to 56.5° uses *alternate* hole.

Thread the appropriate leg into the required hole to a firm feel only. Set aside the tripod leg that is not to be used.

6. A small thumbscrew (**6, Fig. 16**) is attached to both the standard and high-latitude tripod legs. Loosening the thumbscrew allows the outer section of the leg to slide over the inner section, so that the leg can be extended. If using the standard tripod leg, extend the leg so that the center of the thumbscrew head aligns with the latitude of the observing location on the scale. Retighten the thumbscrew to a firm feel. (If using the high-latitude tripod leg, complete the adjustment of the leg extension in step 9.)

**Example:** The latitude of New York City is 41°. The tripod leg should be extended so that the center of the thumbscrew is set next to the 41° reading on the scale.

**Note:** With the standard tripod leg threaded into the appropriate hole in the drive base, the latitude scale may be at an inconvenient position for reading (e.g., the scale faces the drive base). This situation can be remedied by unthreading the leg, removing the thumbscrew, rotating the inner leg 180°, then reinserting the thumbscrew. The scale will now be readable when threaded back into the telescope base.

7. Loosen the vertical and horizontal locks (**6 and 9, Fig. 1**) and rotate the telescope so that it is oriented as shown in **Fig. 16**. Tighten the vertical

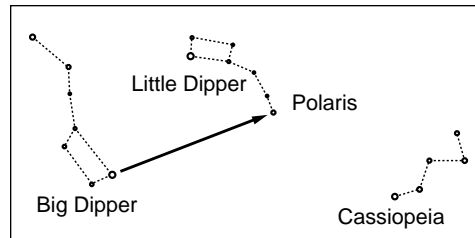

**Fig. 14:** Locating Polaris.

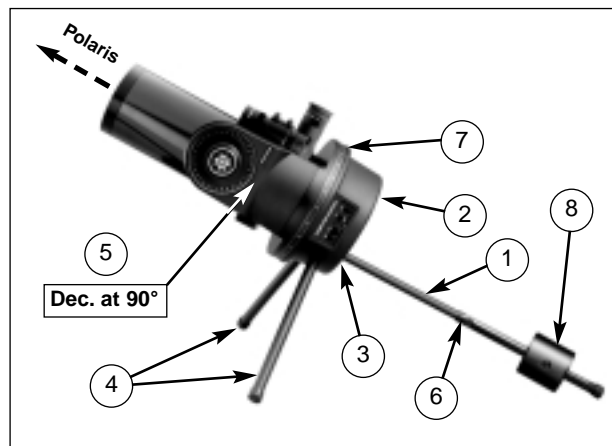

**Fig. 16:** Example of Polar Alignment Using the #880 Table Tripod and ETX-90EC. (1) Standard tripod leg with latitude scale; (2) High-latitude hole; (3) Alternate hole; (4) Fixed tripod legs; (5) Declination pointer; (6) Thumbscrew; (7) R.A. scale pointer; (8) #1422 low-latitude balance weight.

### CAUTION!

When using the #880 Table Tripod with the ETX-90EC, the optional #1422 Low-Latitude Balance Weight is recommended if the telescope is to be polar aligned below 30°, or if heavy accessories are attached to the eyepiece-end of the telescope. The low-latitude balance weight is recommended for the ETX-105EC or ETX-125EC at all observing latitudes and is included as standard equipment with the #881 Table Tripod.

and horizontal locks. In this orientation the telescope's optical tube is lined up parallel to the tripod's adjustable leg.

- Note the line and arrow extending from the telescope tube in Fig. 16. This line defines the telescope's polar axis. Lift the entire telescope, including tripod, and place the telescope on a firm and level surface so that this axis is pointing due North (i.e., if the location of Polaris, the North Star, is known, then point the telescope directly at Polaris).
- If using the high-latitude tripod leg in the Northern hemisphere, extend the leg until the telescope's polar axis points to Polaris, or due North, an alignment obtained by sighting along the telescope tube with the telescope oriented as shown in Fig. 16.

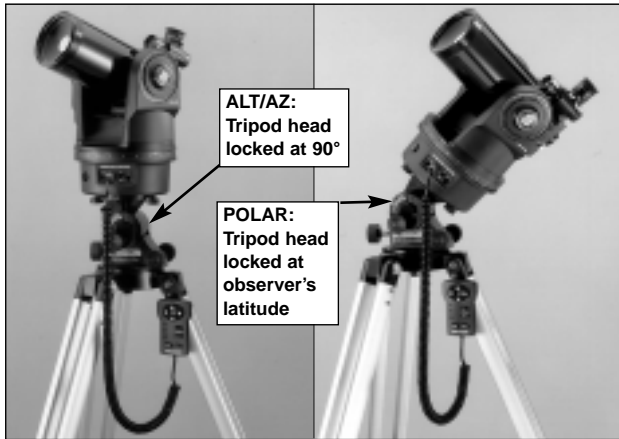

Fig. 17: Examples of Alt/Az and polar mounting of an ETX-90EC to the optional #883 Deluxe Field Tripod.

**Note:** Observers located in the earth's Southern Hemisphere must point the telescope's polar axis due South.

- With the telescope now polar-aligned, the table tripod should not be moved, or else polar alignment will be lost. Motions of the telescope (e.g., to locate and/or track objects) can be affected only by (a) loosening the locks (6 and 9, Fig. 1), which permits the optical tube to be moved freely within the telescope mounting, or (b) more generally, with the locks in their "locked" positions, by using the Arrow keys of the Electronic Controller.

**Note:** For almost all astronomical observing requirements, approximate settings of the telescope's polar axis are acceptable. Do not allow undue attention to precise polar alignment of the telescope to interfere with your enjoyment of the instrument. In those unusual cases where more precise polar alignment is desirable, refer to APPENDIX C, page 28.

## PHOTOGRAPHY

Photography through your ETX model requires the addition of the optional #64 T-Adapter (see **OPTIONAL ACCESSORIES**, page 20). With the #64 T-Adapter attached to the telescope (Fig. 18), through-the-telescope photography is possible with any 35mm camera body with a removable lens. In this way the telescope effectively becomes the lens of the camera.

For through-the-telescope photography, turn the flip-mirror control (5, Fig. 18) to the "down" position, allowing light to pass straight through the telescope and out the photo port (15, Fig. 1). With the flip-mirror control in the "down" position and the photo port's dust cover removed, you can see the front lens of the telescope when you look through the photo port. The #64 T-Adapter threads onto the photo port, followed by a T-mount for the particular brand of 35mm camera being used, followed by the camera body (with the camera lens removed).

The #64 T-Adapter consists of two sections (1 and 2, Fig. 18), which are threaded together in shipment. You may use either of the following photographic mounting formats to couple the camera body to the telescope's photo port thread.

- Format 1:** Camera Body + T-Mount + Section (1) of the #64 T-Adapter (7, Fig. 18).

ETX-90EC	1250mm at f/13.8
ETX-105EC	1640mm at f/15.6
ETX-125EC	1900mm at f/15

Format 1 utilizes only the short section of the #64 T-Adapter to permit close-coupling of a camera body to the telescope. In this format vignetting will occur: the photographic image will appear on film with a slight darkening at the corners of the 35mm frame (see Fig. 19).

- Format 2:** Camera Body + T-Mount + Sections (1) and (2) of the #64 T-Adapter (see Fig. 18).

ETX-90EC	1450mm at f/16
ETX-105EC	1830mm at f/17.4
ETX-125EC	2310mm at f/18

Format 2 utilizes both sections of the #64 T-Adapter threaded together to form a rigid unit. In this configuration there is no field vignetting: images are illuminated to the edges of a standard 35mm frame (see Fig. 20).

To frame an object in the viewfinder of the 35mm camera body, slightly loosen the knurled attachment ring (3, Fig. 18), which threads the #64 T-Adapter to the telescope's photo port; rotate the camera body to achieve proper framing of the object; then retighten the knurled ring.

Photography through a long lens, such as the ETX, requires special technique for good results. The photographer should expect to use a roll or two of film in acquiring this technique. Long-lens photography has its own rewards, however, which short-focus lenses cannot duplicate.

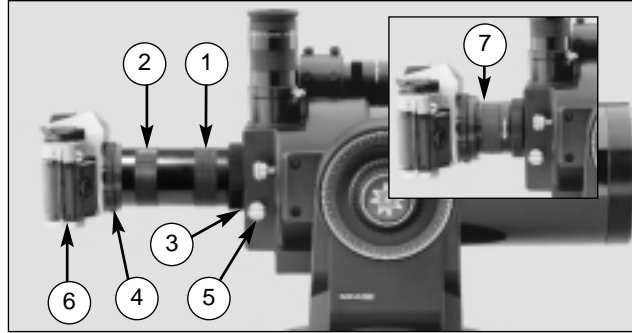

**Fig. 18:** Example of photography through the ETX using the #64 T-Adapter: (1) Short section of #64 T-Adapter; (2) Extension section of #64 T-Adapter; (3) Knurled attachment ring; (4) T-mount; (5) Flip-mirror control in "down" position; (6) 35mm camera body; (7) Format 1.

#### A Few Tips on Photography

1. Use the optional table tripod specific to your model of ETX, or the #883 Deluxe Field Tripod as a platform for the telescope. At effective focal lengths of 1250mm to 1450mm (ETX-90EC), 1640mm to 1830mm (ETX-105EC), or 1900mm to 2310mm (ETX-125EC), even small external vibrations can easily ruin an otherwise good photo.

**CAUTION:** With the #64 T-Adapter and a camera body mounted to the ETX photo port, the telescope can be rotated vertically only 45°. Moving past this point may damage the telescope and camera.

2. Use a cable-operated shutter release. Touching the camera body to operate the shutter will almost certainly introduce undesirable vibrations.
3. Focus the image with extreme care. While observing the subject through the camera's reflex viewfinder, turn the ETX's focus knob (8, Fig. 1) to achieve the sharpest possible focus. Note that some 35mm cameras may have an optional focusing screen (available from the manufacturer) for use with a long telephoto lens. This screen provides a brighter and clearer image to focus and is highly recommended.
4. Correct shutter speeds vary widely, depending on lighting conditions and film used. Trial-and-error is the best way to determine proper shutter speed in any given application.

**Note:** The camera used with an ETX model may have an **exposure meter** that is still active when the standard lens is removed and the body is connected to the telescope with the T-mount. If used for terrestrial photography, the camera meter should be acceptable. If used for astrophotography, the meter probably will not provide good results since camera meters are not made to compensate for a dark sky.

5. Terrestrial photography through an ETX model is sensitive to heat waves rising from the Earth's surface. Long distance photography is best accomplished in the early morning hours before the earth has had time to build up heat.
6. Photography of the Moon and planets through an ETX model can be especially gratifying, but points 1 through 4 should be particularly noted in this case. Lunar or planetary photography requires that the telescope be polar aligned (see **POLAR ALIGNMENT PROCEDURE**, page 16), and that the telescope's motor drive be in operation (see **APPENDIX A**, page 26).

**Note:** Long-exposure photography of deep-sky objects is not practical with an ETX model, since this type of photography requires special electronic and optical guiding devices not available for this telescope.



**Fig. 19:** Example of a format 1 photo.



**Fig. 20:** Example of a format 2 photo.

## OPTIONAL ACCESSORIES

A wide assortment of professional Meade accessories are available for the for ETX telescopes. Meade accessories greatly extend many important applications to the telescope, from low-power, wide-field terrestrial viewing to high-power lunar and planetary observing. The premium quality of these accessories is well-suited to the quality of the instrument itself.

Meade telescopes and accessories, including optional accessories for ETX telescopes, are available at more than 3,000 dealer locations in the U.S. and Canada and through Meade international distributors worldwide. Once you have identified the accessories you wish to order, contact your local Meade authorized dealer. To find a dealer near you call **(949) 451-1450** or visit the Meade website at **www.meade.com**.

**#497 Autostar™ Computer Controller:** One of the most important advances in telescope control in the past 25 years, the Meade #497 Autostar Computer Controller (**Fig. 21**) turns your ETX model into an automatic celestial object locating system. Just plug Autostar into the telescope's HBX port in place of the standard-equipment Electronic Controller, do a quick telescope alignment, and you are ready to observe any object in the Autostar's 14,000-object database.

Best of all, the Meade Autostar is easy to use. Even the most novice observer will locate dozens of fascinating celestial objects the very first night out — from commonly observed objects, such as the rings of Saturn, the satellites of Jupiter, and the Orion Nebula (M42), to more difficult objects, such as the Ring Nebula (M57) in Lyra, the Spiral Galaxy (M33) in Triangulum, and the Sombrero Galaxy (M104) in Virgo; to very obscure objects near the telescope's threshold of visibility, such as spiral galaxy NGC 3310 in Ursa Major.

Any of Autostar's database objects can be called up and entered on the hand controller display in seconds. The observer then simply presses the GO TO pushbutton and watches as the telescope automatically slews to the object and places it in the field of view. Autostar brings into easy access objects that were previously unreachable for all but the most dedicated of amateur astronomers.

**AstroFinder Software/#505 Cable Connector Kit:** With Meade AstroFinder software (**Fig. 22**) loaded into your PC, Autostar-equipped ETX-90EC, ETX-105EC, and ETX-125EC telescopes may be remotely controlled from the PC display. The **#505 Cable Connector Set**, permitting connection of ETX, Autostar, and PC, is included with each AstroFinder package.

**Eyepieces:** For higher and lower magnifications, Meade Super Plössl (SP) and Super Wide Angle (SWA) eyepieces (**Fig. 23**), as well as the Series 4000 8mm to 24mm Zoom eyepiece, yield high-resolution imaging with all ETX telescope models. A useful selection includes the SP 9.7mm, SP 12.4mm, and SWA 18mm. Under good seeing conditions, Meade Ultra Wide Angle 4.7mm and 6.7mm eyepieces present the widest obtainable fields of view at high powers and are well suited for observing the Moon and planets. Alternative optional eyepieces may be chosen from the Meade Series 3000 Plössl eyepieces. Powers obtained with each eyepiece are shown in the following table.

Eyepiece	ETX-90EC		ETX-105EC		ETX-125EC	
	Power	2x Barlow	Power	2x Barlow	Power	2x Barlow
SP 6.4mm	195X	390X	230	459	297X	594X**
SP 9.7mm	129X	258X	152	303	196X	392X
SP 12.4mm	101X	202X	119	237	153X	306X
SP 15mm	83X	166X	98	196	127X	253X
SP 20mm	63X	126X	74	147	95X	190X
SP 26mm *	48X	96X	57	113	73X	146X
SP 32mm	39X	78X	46	92	59X	119X
SP 40mm	31X	62X	37	74	48X	96X
SWA 13.8mm	91X	182X	107	213	138X	275X
SWA 18mm	69X	138X	82	163	106X	211X
SWA 24.5mm	51X	102X	60	120	78X	155X
UWA 4.7mm	266X	N/A	313	N/A	404X	N/A
UWA 6.7mm	187X	374X **	219	439**	284X	567X**

\* Included as standard-equipment with the ETX models.

\*\* Use these eyepieces only under extremely steady atmospheric conditions.



**Fig. 21:** #497 Autostar Computer Controller.

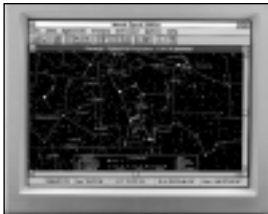

**Fig. 22:** AstroFinder software.



**Fig. 23:** Optional Eyepieces yield higher and lower magnifying powers.

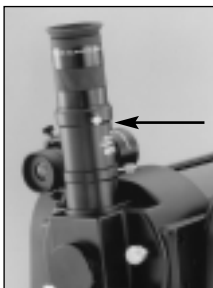

**Fig. 24:** Use the #126 2x Barlow Lens to double the magnification of the eyepiece employed.

**#126 2x Barlow Lens:** An amplifying lens, the multi-coated #126 2x Barlow (**Fig. 24**) doubles the power of all eyepieces with which it is used. Insert the #126 into the telescope's eyepiece holder first, followed by an eyepiece. **Example:** By itself, the SP 26mm eyepiece yields a power of 73X with the ETX-125EC; when used with the #126 2x Barlow Lens, this eyepiece yields 146X.



**Fig. 25:** #825 Right-Angle Viewfinder.



**Fig. 26:** The #932 45° Erecting Prism.



**Fig. 30a:** The #883 Deluxe Field Tripod shown with an ETX-90EC Astro Telescope, set up in the Alt/Az configuration (tripod head locked at 90°), for terrestrial applications.



**Fig. 30b:** The #883 Deluxe Field Tripod shown with tripod head tilted for polar alignment.

**#825 8 x 25mm Right-Angle Viewfinder:** Included as standard-equipment on ETX-105EC and ETX-125EC models, the 8x25mm Right-Angle Viewfinder (**Fig. 25**) permits a comfortable 90° viewing position with 90mm ETX models as well. The #825 fits into the same bracket as the 8x21mm viewfinder supplied with ETX-90EC telescopes. The viewfinder's wide-angle 7.5° actual field facilitates object location. Precise focusing of the image is accomplished with a helicoid mechanism.

**#64 T-Adapter:** The basic means of photography through any ETX Astro telescope, the #64 T-Adapter threads to the rear cell of the telescope, followed by a T-Mount appropriate to the user's brand of 35mm camera. In this way, the camera body is rigidly coupled to the telescope's optical system, which in effect becomes the camera's lens (see **PHOTOGRAPHY**, page 18).

**#932 45° Erecting Prism:** All ETX models include an internal optically-flat mirror to reflect light to the telescope's 90° astronomical observing position. In this position the telescope's image is upright, but reversed. For terrestrial observing with an ETX model, the #932 Erecting Prism (**Fig. 26**) results in a fully correctly oriented image and a convenient 45° observing angle.

**#774 Hard Carrying Case** (for the ETX-90EC), **#776 Hard Carrying Case** (for the ETX-105EC), and **#775 Hard Carrying Case** (for the ETX-125EC): For secure portability of ETX Astro Telescope models in the field, Meade hard carrying cases (**Fig. 27**) are fully lined with fitted foam inserts. They accept the complete ETX Astro Telescope plus optional accessories.

**#765 Soft Carry Bag:** The Meade soft-padded carry bag (**Fig. 28**) is well suited to travel with the ETX-90EC Astro Telescope. Each carry bag includes a shoulder strap and permits ready transport of the complete telescope, including accessories.

**Power Adapters and Cords:** In addition to their internal battery packs, ETX-90EC, ETX-105EC, and ETX-125EC telescopes may be powered from standard 115vAC home electricity with the **#541 AC Adapter**. The #541 plugs into any standard home outlet and includes a 25 ft. cord connecting to the telescope's control panel. Input voltage to the telescope is 12vDC. Alternately, an ETX telescope may be powered in the field from an automobile cigarette lighter plug by using the **#607 Power Cord**, a 25-ft. cord that plugs into the telescope's control panel and supplies 12vDC directly from the car battery.

**#1244 Electric Focuser (for the ETX-90EC and ETX-105EC) and #1247 Electric Focuser (ETX-125EC):** Meade-engineered for smooth, rapid focusing with any ETX model, each electric focuser (**Fig. 29**) includes coarse and micro-fine speeds. The standard-equipment hand controller accepts one (user-supplied) 9-volt battery and focuses the ETX telescope. On the ETX models, the focuser plugs into, and is powered by, the telescope's control panel, with operation effected through either the Electronic Controller or the optional #497 Autostar Computer Controller.

**#880 Table Tripod (for ETX-90EC) and #881 Table Tripod (for ETX-105EC and the ETX-125EC):** ETX-90EC, ETX-105EC, and ETX-125EC models permit pushbutton tracking of astronomical objects from their standard-equipment Electronic Controllers. For fully automatic tracking, a table tripod (**Fig. 16**), or the #883 Deluxe Field Tripod, may be added allowing for polar alignment of the telescope.

Each table tripod includes two fixed legs and two variable-length legs inscribed with a range of latitude settings for quick polar alignment. At observing latitudes below about 25°, the optional **#1422 Low-Latitude Balance Weight (8, Fig. 16)** is recommended for ETX-90 Astro Telescope models; the low-latitude balance weight is included with the table tripod for the ETX-105EC and the ETX-125EC Astro Telescopes.

**#883 Deluxe Field Tripod:** Provides a rigid mounting platform for the ETX-90EC, ETX-105EC, and ETX-125EC Astro Telescope models. The #883 tripod includes micrometric controls for precise equatorial alignment of the telescope at any observing latitude from 20° to 90°. The ETX telescope may be mounted in the altazimuth orientation (**Fig. 30a**) for terrestrial viewing or in the equatorial (or polar) mode (**Fig. 30b**) for automatic tracking of astronomical objects.

**#887 Advanced Field Tripod for the ETX-105EC or ETX-125EC:** For extra stability in sensitive applications of the ETX-105EC or the ETX-125EC even at the highest magnifications, the fixed height #887 Tripod permits either altazimuth or equatorial orientation of the telescope for astronomical or terrestrial observing. The #887 includes an equatorial wedge for polar alignment. The tripod's 2"-diameter steel legs collapse for easy transport in the field.



**Fig. 27:** #774 Hard Carrying Case shown with an ETX-90EC.



**Fig. 28:** The #765 Soft Carry Bag for the ETX-90EC.



**Fig. 29:** #1244 Electric Focuser.

## GENERAL MAINTENANCE

Your ETX model telescope is a precision optical instruments designed to yield a lifetime of rewarding observations. Given the care and respect due any precision instrument, the telescope will rarely require factory servicing or maintenance. Use the following guidelines:

1. Avoid cleaning the telescope's optics: a little dust on the front surface of the telescope's correcting lens causes virtually no degradation of image quality and should not be considered reason to clean the lens.
2. When absolutely necessary, remove dust from the front lens with gentle strokes of a camel-hair brush or blow it off with an ear syringe (available at any pharmacy). *Do not use a commercial photographic lens cleaner.*
3. You may remove organic materials (e.g., fingerprints) from the front lens with a solution of 3 parts distilled water to 1 part isopropyl alcohol. A single drop of biodegradable dishwashing soap may be added per pint of solution. Use soft, white facial tissues and make short, gentle strokes. Change tissues often.

**CAUTION:** *Do not use scented, colored, or lotioned tissues or damage could result to the optics.*

4. In the very rare situation where cleaning the inside surface of the corrector lens becomes necessary, unthread the lens cell located at the front of the main tube. The entire correcting lens and secondary mirror system are mounted in this cell. You may use the lens-cleaner solution described in step 3 to clean the inside surface of the lens.

**CAUTION:** *Do not touch the aluminized circular surface of the secondary mirror with a finger, a tissue, or any other object. This will almost certainly scratch the mirror surface.*

*Note: When cleaning the inside surface of the correcting lens, leave the lens mounted in its metal cell throughout the process. Do not remove the lens from its metal housing or optical alignment of the lens will be lost, necessitating a return of the telescope to the Meade factory.*

5. If your ETX model is used outdoors on a humid night, telescope surfaces may accumulate water condensation. While such condensation does not normally cause any damage to the telescope, it is recommended that the entire telescope be wiped down with a dry cloth before being packed away. *Do not, however, wipe any of the optical surfaces.* Rather, simply allow the telescope to sit for some time in warm indoor air, so that the wet optical surfaces can dry unattended. In addition, the dust cap should not be placed back on to the optical tube until the telescope is thoroughly dry.
6. If your ETX model is not to be used for an extended period, perhaps for one month or more, it is advisable to remove the eight AA-size batteries from inside the drive base. Batteries left installed for prolonged periods may leak, causing damage to the telescope's electronic circuitry (see **ASSEMBLY INSTRUCTIONS**, page 9).
7. The super-gloss anodized finish of any ETX model's deep-violet optical tube fades if left in direct sunlight for prolonged periods.
8. Do not leave your ETX model outdoors on a warm day or inside a sealed car for an extended period of time; excessive ambient temperatures can damage the telescope's internal lubrication and electronic circuitry.
9. A set of two (English-format) hex wrenches is provided with ETX models. These wrenches are used as follows:
  - Small wrench (.05"): Use the small wrench to tighten the set-screws of any knobs that may loosen (e.g., the focus knob or flip-mirror control knob).
  - Medium wrench (1/16"): This wrench is used to detach the viewfinder bracket from the telescope's rear cell.

## Storage and Transport

When the telescope is not in use, store it in a cool, dry place. Do not expose the instrument to excessive heat or moisture. It is best to store the telescope in its original box with the vertical and horizontal locks (**6 and 9, Fig. 1**) in the *unlocked* positions. If shipping the telescope, use the original box and packing material to protect the telescope during shipment.

When transporting the telescope, take care not to bump or drop the instrument; this type of abuse can damage the optical tube and/or the objective lens, and knock the optics out of alignment. It is highly recommended to use an optional carry case to transport the telescope (see **OPTIONAL ACCESSORIES**, page 21).

## Inspecting the Optics

A Note About the "Flashlight Test:" If a flashlight or other high-intensity light source is pointed down the main telescope tube, the view (depending upon the observer's line of sight and the angle of the light) may reveal what appear to be scratches, dark or bright spots, or uneven coatings, giving the appearance of poor quality optics. These effects are only seen when a high intensity light is transmitted through lenses or reflected off the mirrors, and can be seen on any high-quality optical system, including giant research telescopes.

The optical quality of a telescope cannot be judged by the "flashlight" test; the true test of optical quality can only be conducted through careful star testing.

## Troubleshooting

The following suggestions may be helpful with operation of the ETX-90EC, ETX-105EC, and ETX-125EC.

### ***The power indicator light on the telescope does not come on or there is no response when pressing the Electronic Controller Arrow keys:***

- Verify that the Computer Control panel power switch (**10A, Fig. 1**) is in the ON position.
- Verify that the Electronic Controller cord (**4, Fig. 3**) is firmly connected to the HBX port (**10C, Fig. 1**).
- If using internal power (batteries), verify that the batteries are installed correctly and that they have sufficient charge (see **ASSEMBLY INSTRUCTIONS**, page 9).

**Note:** *If the batteries are getting low on charge, there will be a marked difference in the slew speed. The speed indicator lights may also flash and the speed may change. If any of these symptoms occurs, turn the power off and replace the batteries.*

- If using an external power source, verify that it is properly connected between the 12-volt connector (**10D, Fig. 1**) and either a wall plug (AC source) or a car cigarette lighter (DC source).
- If the Electronic Controller does not respond to commands, move the power switch to OFF and then back to ON.
- If the telescope does not slew after power is applied or if the motor quits or stalls, verify that there are no physical obstructions that would impede telescope movement.
- If all physical obstacles are removed and the telescope still does not move properly, turn off the power and unplug the Electronic Controller. Plug the Electronic Controller back in and turn the power back on.

### ***Unable to see an image through the eyepiece:***

- Confirm that the lens cover has been removed from the telescope.
- Confirm that the flip-mirror control (**14, Fig. 1**) is in the "up" position if using the eyepiece holder (**4, Fig. 1**) so that light is directed to the eyepiece (**1, Fig. 1**). Confirm that the flip-mirror control is in the "down" position if using the #932 Erecting Prism or doing photography with an ETX model (see **TELESCOPE CONTROLS**, page 6 and **PHOTOGRAPHY**, page 18).

### ***Object appears in the viewfinder but not in the eyepiece:***

- The viewfinder is not properly aligned with the telescope (see **ALIGNING THE VIEWFINDER**, page 10).

### ***Slew speed does not change when you press the SPEED key, or the telescope moves slowly even though the fast slew speed is chosen:***

- Verify that only one light is illuminated on the Electronic Controller. If more than one light is on or blinking, the Mode function is active. Exit the Mode function by pressing and holding the MODE key until only one light is on (see **APPENDIX A**, page 26).
- The battery power may be low (see **ASSEMBLY INSTRUCTIONS**, page 9).

### ***Telescope does not track a celestial object:***

- The telescope tracks celestial objects automatically only if it is placed in the polar mode (see **APPENDIX A**, page 26) and the telescope is polar aligned (see **POLAR ALIGNMENT**, page 16) using the #880 (ETX-90EC), #881 (ETX-105EC or ETX-125EC) Table Tripod, or #883 Deluxe Field Tripod (see **OPTIONAL ACCESSORIES**, page 21). The more accurate the polar alignment, the longer the telescope's motor drive holds an object in the field of view of the eyepiece. If using the Alt/Az mode, track celestial objects by using the Arrow keys on the Electronic Controller. Automatic tracking of objects in the Alt/Az mode requires the optional #497 Autostar Computer Controller. Also the Horizontal and Vertical locks must be locked (page 6).

### ***Images through the eyepiece appear unfocused or distorted:***

- The magnification may be too high for the viewing conditions. Back off to a lower power eyepiece (see **UNDERSTANDING MAGNIFICATION**, page 12).

- If inside a warm house or building, move outside. Interior air conditions may distort terrestrial or celestial images, making it difficult, if not impossible, to obtain a sharp focus. For optimal viewing, use the telescope outside in the open air instead of observing through an open or closed window or screen.
- If viewing a land object on a warm day, heat waves will distort the image (see **TERRESTRIAL OBSERVING**, page 12).
- For clear viewing of objects, turn the focus knob (**8, Fig. 1**) slowly since the “in-focus” point of a telescope is precise. Turning the focus knob too quickly may cause the focus point to pass without notice.
- The optics within the telescope need time to adjust to the outside ambient temperature to provide the sharpest image. To cool down the optics, set the telescope outside for 10 to 15 minutes before observing begins.

***Telescope moves off a terrestrial object while observing:***

- The motor drive may be activated (see **CHANGING MODES**, page 26).
- Verify that the vertical and horizontal locks are tight (see **TELESCOPE CONTROLS**, page 8).

***Telescope does not move past a certain point:***

- The built-in vertical or horizontal rotational “stops” may have been reached (see **NOTE** with bullet **7**, page 6).

***Telescope pauses when changing slew direction:***

- This pause is normal (see **ARROW KEYS**, page 8).

***A terrestrial object appears reversed left-for-right:***

- An eyepiece in the standard 90° observing position (**4, Fig. 1**) reverses an object left-for-right: To view a correctly oriented image requires the optional #932 Erecting Prism (see **OPTIONAL ACCESSORIES**, page 21).

**Meade Customer Service**

If you have a question concerning your ETX model, call the Meade Instruments Customer Service Department at (949) 451-1450, or fax to (949) 451-1460. Customer Service hours are 8:30 AM to 4:30 PM, Pacific Time, Monday through Friday. In the unlikely event that the ETX requires factory servicing or repairs, *write or call the Meade Customer Service Department first, before returning the telescope to the factory*, giving full particulars as to the nature of the problem, as well as your name, address, and daytime telephone number. The great majority of servicing issues can be resolved by telephone, avoiding return of the telescope to the factory.



### Specifications: ETX-90EC Astro Telescope

Optical design . . . . . Maksutov-Cassegrain  
Primary mirror diameter . . . . . 96mm (3.78")  
Clear aperture . . . . . 90mm (3.5")  
Focal length . . . . . 1250mm  
Focal ratio (photographic speed) . . . . . f/13.8  
Near focus (approx) . . . . . 11.5 ft (3.5m)  
Resolving power . . . . . 1.3 arc secs  
Super multi-coatings (EMC) . . . . . standard  
Limiting visual stellar magnitude (approx.) . . . . . 11.7  
Image scale . . . . . 1.16°/inch  
Maximum practical visual power . . . . . 325X  
Optical tube dimensions  
(dia. x length) . . . . . 10.4cm x 27.9cm (4.1" x 11")  
Eyepiece . . . . . Super Plössl 26mm  
Viewfinder . . . . . 8 x 21mm  
Secondary mirror obstruction (dia.; %) . . . . . 27.9mm (1.1"); 9.6%  
Telescope mounting . . . . . fork type; double tine  
Setting circle diameters . . . . . Dec.: 3.5"; RA: 7"  
Input voltage . . . . . 12 volts DC  
Motor Drive System . . . . . DC servo motors with encoders, both axes  
Slow-Motion Controls . . . . . electric, 4 speed, both axes  
Optional Autostar Capability . . . . . yes  
Hemispheres of operation . . . . . North and South, switchable  
Bearings:  
Altitude . . . . . UHMW polyethylene  
Azimuth . . . . . PTFE  
Materials:  
Tube body . . . . . aluminum  
Mounting . . . . . high-impact ABS, aluminum-reinforced  
Primary mirror . . . . . Pyrex® glass  
Correcting lens . . . . . BK7 optical glass, Grade-A  
Telescope dimensions:  
. . . . . 38cm x 18cm x 22cm (15" x 7" x 9")  
Telescope net weight:  
(incl. Electronic Controller & batteries) . . . . . 3.5kg (7.8 lbs)  
Telescope shipping weight . . . . . 5.8kg (12.8 lbs)  
Battery Life (approx.):  
with Electronic Controller . . . . . 45 hrs  
with Autostar . . . . . 20 hrs

### Specifications: ETX-105EC Astro Telescope

Optical design . . . . . Maksutov-Cassegrain  
Primary mirror diameter . . . . . 116mm (4.56")  
Clear aperture . . . . . 105mm (4.13")  
Focal length . . . . . 1470mm (57.8")  
Focal ratio (photographic speed) . . . . . f/14  
Near focus (approx) . . . . . 4.6m (15 ft)  
Resolving power . . . . . 1.1 arc secs  
Super multi-coatings (EMC) . . . . . standard  
Limiting visual stellar magnitude (approx.) . . . . . 12.1  
Image scale . . . . . 0.99°/inch  
Maximum practical visual power . . . . . 420x  
Optical tube dimensions  
(dia. x length) . . . . . 12.4cm x 32.8cm (4.88" x 12.9")  
Eyepiece . . . . . Super Plössl 26mm  
Viewfinder . . . . . 8 x 25mm right-angle  
Secondary mirror obstruction (dia.; %) . . . . . 3.3cm (1.32"); 9.4%  
Telescope mounting . . . . . fork type; double tine  
Setting circle diameters . . . . . Dec.: 3.81"; RA: 7.8"  
Input voltage . . . . . 12 volts DC  
Motor Drive System . . . . . DC servo motors with encoders, both axes

Slow-Motion Controls . . . . . electric, 4 speed, both axes  
Optional Autostar Capability . . . . . yes  
Hemispheres of operation . . . . . North and South, switchable  
Bearings:  
Altitude . . . . . ball bearings  
Azimuth . . . . . PTFE thrust bearing and radial ball bearing  
Materials:  
Tube body . . . . . aluminum  
Mounting . . . . . ABS, with internal aluminum structure  
Primary mirror . . . . . Pyrex® glass  
Correcting lens . . . . . BK7 optical glass, Grade-A  
Telescope dimensions:  
. . . . . 43cm x 25cm x 20cm (17" x 10" x 8")  
Telescope net weight:  
(incl. Electronic Controller & batteries) . . . . . 6.1kg (13.5 lbs)  
Telescope shipping weight . . . . . 8.3kg (18.4 lbs)  
Battery Life (approx.):  
with Electronic Controller . . . . . 45 hrs  
with Autostar . . . . . 20 hrs

### Specifications: ETX-125EC Astro Telescope

Optical design . . . . . Maksutov-Cassegrain  
Primary mirror diameter . . . . . 138mm (5.43")  
Clear aperture . . . . . 127mm (5.0")  
Focal length . . . . . 1900mm (74.8")  
Focal ratio (photographic speed) . . . . . f/15  
Near focus (approx) . . . . . 5.5m (18 ft)  
Resolving power . . . . . 0.9 arc secs  
Super multi-coatings (EMC) . . . . . standard  
Limiting visual stellar magnitude (approx.) . . . . . 12.5  
Image scale . . . . . 0.76°/inch  
Maximum practical visual power . . . . . 500X  
Optical tube dimensions  
(dia. x length) . . . . . 14.6cm x 36cm (5.75" x 14.2")  
Eyepiece . . . . . Super Plössl 26mm  
Viewfinder . . . . . 8 x 25mm right-angle  
Secondary mirror obstruction (dia.; %) . . . . . 39.4mm (1.6"); 9.6%  
Telescope mounting . . . . . fork type; double tine  
Setting circle diameters . . . . . Dec.: 4.3"; RA: 9"  
Input voltage . . . . . 12 volts DC  
Motor Drive System . . . . . DC servo motors with encoders, both axes  
Slow-Motion Controls . . . . . electric, 4 speed, both axes  
Optional Autostar Capability . . . . . yes  
Hemispheres of operation . . . . . North and South, switchable  
Bearings:  
Altitude . . . . . ball bearings  
Azimuth . . . . . ball bearings  
Materials:  
Tube body . . . . . aluminum  
Mounting . . . . . ABS, with internal aluminum structure  
Primary mirror . . . . . Pyrex® glass  
Correcting lens . . . . . BK7 optical glass, Grade-A  
Telescope dimensions:  
. . . . . 48cm x 23cm x 27cm (19" x 8.9" x 10.8")  
Telescope net weight:  
(incl. Electronic Controller & batteries) . . . . . 6.9kg (15.2 lbs)  
Telescope shipping weight . . . . . 11.4kg (25.2 lbs)  
Battery Life (approx.):  
with Electronic Controller . . . . . 45 hrs  
with Autostar . . . . . 20 hrs

## Appendix A: ADVANCED ELECTRONIC CONTROLLER FUNCTIONS

### Tracking Motor Speeds

In the polar mode the Electronic Controller normally tracks objects at the sidereal rate (see **SIDEREAL RATE**, page 13). For most observing sessions (once the telescope has been polar aligned and the tracking motor activated), there is little need to change this speed.

For objects, like the Moon or a comet, that move at slightly different rates, the Electronic Controller Arrow keys (**1, Fig. 3**) are sufficient to move the telescope slightly as the object very slowly moves off-center through the eyepiece field.

To change the tracking rate, for extended observations of an object not moving at the sidereal rate, follow the procedure for the appropriate hemisphere:

#### Northern Hemisphere Polar:

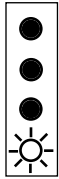

Step 2.

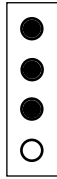

Step 4.

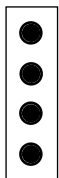

Step 3.



Step 5.

1. Press and hold the MODE key (**5, Fig. 3**) until the Mode function is active (*i.e.*, lights 1 and 2 are on steady; lights 3 and 4 signify whatever tracking mode was last chosen).
2. Press the SPEED key (**3, Fig. 3**) until lights 1, 2, and 3 are on steady with light 4 blinking. The telescope is now in the Northern Hemisphere polar mode.
3. Press the IN key (**7, Fig. 3**) and light 4 comes on steady. The tracking rate is now 0.5% *faster* than sidereal. If the object you're tracking is moving faster than the sidereal rate, look through the eyepiece and continue to press the IN key until the object remains centered with little or no drifting in the eyepiece.

**Note:** The tracking rate can be increased by up to 65% (127 presses of the IN key).

4. To use a rate slower than sidereal, press the OUT (**6, Fig. 3**) key until light 4 blinks again (sidereal rate). Press the OUT key again and light 4 goes out, signifying a tracking rate 0.5% *slower* than sidereal. If the object you're tracking is moving slower than the sidereal rate, look through the eyepiece and continue to press the OUT key until the object remains centered with little or no drifting in the eyepiece.

**Note:** The tracking rate can be decreased by up to 65% (127 presses of the OUT key).

5. Press and hold the MODE key until only a single light is on. This exits the Mode function. If Northern or Southern Hemisphere polar mode was chosen, the motor drive starts operating at the sidereal rate.
6. Use the four Arrow keys (**1, Fig. 3**) to slew the telescope to the desired object. To change the slew speed, press the SPEED key.

#### Southern Hemisphere Polar:

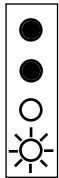

Step 2.

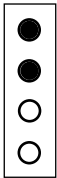

Step 4.

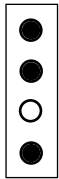

Step 3.

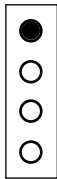

Step 5.

1. Press and hold the MODE key (**5, Fig. 3**) until the Mode function is active (*i.e.*, lights 1 and 2 are on steady; lights 3 and 4 signify the tracking mode last chosen).
2. Press the SPEED key (**3, Fig. 3**) until lights 1 and 2 are on steady, light 3 is off, and Light 4 is blinking.
3. Press the IN key (**7, Fig. 3**) and light 4 comes on steady. The tracking rate is now 0.5% *faster* than sidereal. If the object you're tracking is moving faster than the sidereal rate, look through the eyepiece and continue to press the IN key until the object remains centered with little or no drifting in the eyepiece.

**Note:** The tracking rate can be increased by up to 65% (127 presses of the IN key).

4. To use a rate slower than sidereal, press the OUT key (**6, Fig. 3**) until light 4 blinks again (sidereal rate). Press the OUT key again and light 4 goes out, signifying a tracking rate 0.5% *slower* than sidereal. If the object you're tracking is moving slower than the sidereal rate, look through the eyepiece and continue to press the OUT key until the object remains centered with little or no drifting in the eyepiece.

**Note:** The tracking rate can be decreased by up to 65% (127 presses of the OUT key).

5. Press and hold the MODE key until only a single light is on. This exits the Mode function. If Northern or Southern Hemisphere polar mode was chosen, the motor drive starts operating at the sidereal rate.
6. Use the four Arrow keys (**1, Fig. 3**) to slew the telescope to the desired object. To change the slew speed, press the SPEED key.

### Changing Modes Using the Electronic Controller

The Electronic Controller is in the Alt/Az mode when activated, unless a mode screw has been removed. To use the Electronic Controller to change to Northern or Southern Hemisphere polar mode, or to use Alt/Az mode with one of the mode screws removed, use the following procedure:

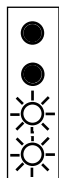

Step 3.

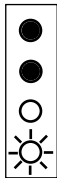

Step 4.

1. Complete the **POLAR ALIGNMENT PROCEDURE** on page 16.
2. Complete steps 2 through 8 as described in **TO MOVE THE TELESCOPE USING THE ELECTRONIC CONTROLLER**, page 15, to initialize the Electronic Controller.
3. Press and hold the MODE key (**5, Fig. 3**) until lights 1 and 2 are on steady and lights 3 and 4 start blinking.
4. Press the SPEED key (**3, Fig. 3**) once. This changes the system to polar mode for the Earth's Southern Hemisphere, with the motor drive set to operate at the sidereal rate.
5. Press the SPEED key a second time. This changes the system to polar mode for the Earth's Northern hemisphere, with the motor drive set to operate at the sidereal rate.
6. Press the SPEED key a third time and the system returns to the Alt/Az mode. *In the Alt/Az mode the motor drive does not activate when exiting from the Mode function.*
7. Use the SPEED key as described in the above steps to cycle among these three modes (Alt/Az, Southern Hemisphere polar, or Northern Hemisphere-polar) until the desired mode is shown by the appropriate light configuration.

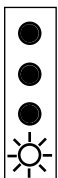

Step 5.



Step 6.

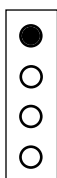

Step 8.

8. Press and hold the MODE key until just one light is on. This exits the Mode function. If you choose Northern or Southern Hemisphere polar mode, the motor drive starts operating at the sidereal rate.
9. Use the four Arrow keys (**1, Fig. 3**) to slew the telescope to the desired object. To change the slew speed, press the SPEED key.

## Appendix B: HELPFUL CHARTS

### Latitude Chart for Major Cities of the World

To aid in the polar alignment procedure (see page 16), latitudes of major cities around the world are listed below. To determine the latitude of an observing site not listed on the chart, locate the city closest to your site. Then follow the procedure below:

**Northern hemisphere observers (N):** If the site is over 70 miles (110 km) north of the listed city, add one degree for every 70 miles. If the site is over 70 miles South of the listed city, subtract one degree per 70 miles.

**Southern Hemisphere observers (S):** If the site is over 70 miles (110 km) north of the listed city, subtract one degree for every 70 miles. If the site is over 70 miles South of the listed city, add one degree per 70 miles.

NORTH AMERICA		
City	State/Prov./Country	Latitude
Albuquerque	New Mexico	35° N
Anchorage	Alaska	61° N
Atlanta	Georgia	34° N
Boston	Massachusetts	42° N
Calgary	Alberta	51° N
Chicago	Illinois	42° N
Cleveland	Ohio	41° N
Dallas	Texas	33° N
Denver	Colorado	40° N
Detroit	Michigan	42° N
Honolulu	Hawaii	21° N
Jackson	Mississippi	32° N
Kansas City	Missouri	39° N
Kenosha	Wisconsin	45° N
Las Vegas	Nevada	36° N
Little Rock	Arkansas	35° N
Los Angeles	California	34° N
Mexico City	Mexico	19° N
Miami	Florida	26° N
Minneapolis	Minnesota	45° N
Nashville	Tennessee	36° N
New Orleans	Louisiana	30° N
New York	New York	41° N
Oklahoma City	Oklahoma	35° N
Ottawa	Ontario	45° N
Philadelphia	Pennsylvania	40° N
Phoenix	Arizona	33° N
Portland	Oregon	46° N
Salt Lake City	Utah	41° N
San Antonio	Texas	29° N
San Diego	California	33° N
San Francisco	California	38° N
Seattle	Washington	47° N
Washington	District of Columbia	39° N
EUROPE		
City	Country	Latitude
Amsterdam	Netherlands	52° N
Athens	Greece	38° N
Bern	Switzerland	47° N
Copenhagen	Denmark	56° N
Dublin	Ireland	53° N
Frankfurt	Germany	50° N
Glasgow	Scotland	56° N
Helsinki	Finland	60° N
Lisbon	Portugal	39° N
London	England	51° N
Madrid	Spain	40° N
Oslo	Norway	60° N
Paris	France	49° N
Rome	Italy	42° N
Stockholm	Sweden	59° N
Vienna	Austria	48° N
Warsaw	Poland	52° N

### Star Locator

Following is a list of bright stars with their R.A. and Dec. coordinates, along with the Northern hemisphere season when these stars are prominent in the night sky. This list will aid the observer to find alignment stars at various times of the year. For example, if it is a midsummer evening in the Northern hemisphere, Deneb in the constellation Cygnus, would be an excellent alignment star, while Betelgeuse could not be used because it is in the winter constellation Orion and thus below the horizon.

Season	Star Name	Constellation	R.A.	Dec.
Spring	Arcturus	Boötes	14h16m	19° 11"
Spring	Regulus	Leo	10h09m	11° 58"
Spring	Spica	Virgo	13h25m	-11° 10"
Summer	Vega	Lyra	18h37m	38° 47"
Summer	Deneb	Cygnus	20h41m	45° 17"
Summer	Altair	Aquila	19h51m	08° 52"
Summer	Antares	Scorpius	16h30m	-26° 26"
Fall	Markab	Pegasus	23h05m	15° 12"
Fall	Fomalhaut	Piscis Austrinus	22h58m	-29° 38"
Fall	Mira	Cetus	02h19m	-02° 58"
Winter	Rigel	Orion	05h15m	-08° 12"
Winter	Betelgeuse	Orion	05h55m	07° 25"
Winter	Sirius	Canis Major	06h45m	-16° 43"
Winter	Aldebaran	Taurus	04h35m	16° 31"

### SOUTH AMERICA

City	Country	Latitude
Bogotá	Colombia	4° N
São Paulo	Brazil	23° S
Buenos Aires	Argentina	35° S
Montevideo	Uruguay	35° S
Santiago	Chile	34° S
Caracas	Venezuela	10° N

### ASIA

City	Country	Latitude
Beijing	China	40° N
Hong Kong	China	23° N
Seoul	South Korea	37° N
Taipei	Taiwan	25° N
Tokyo	Japan	36° N
Sapporo	Japan	43° N
Bombay	India	19° N
Calcutta	India	22° N
Hanoi	Vietnam	21° N
Jedda	Saudi Arabia	21° N

### AFRICA

City	Country	Latitude
Cairo	Egypt	30° N
Cape Town	South Africa	34° S
Rabat	Morocco	34° N
Tunis	Tunisia	37° N
Windhoek	Namibia	23° S

### AUSTRALIA AND OCEANIA

City	State/Country	Latitude
Adelaide	South Australia	35° S
Brisbane	Queensland	27° S
Canberra	New South Wales	35° S
Alice Springs	Northern Territory	24° S
Hobart	Tasmania	43° S
Perth	Western Australia	32° S
Sydney	New South Wales	34° S
Melbourne	Victoria	38° S
Auckland	New Zealand	37° S

## Appendix C: PRECISE POLAR ALIGNMENT; SETTING CIRCLES

If desired, you may obtain more precise polar alignment by first accomplishing basic polar alignment as detailed in **POLAR ALIGNMENT PROCEDURE**, page 16, then returning to this procedure:

### Important Note:

For almost all astronomical observing requirements, approximate settings of the telescope's latitude and polar axis are acceptable. Do not allow undue attention to precise polar alignment of the telescope to interfere with your enjoyment of the instrument.

**Note:** This procedure moves the telescope physically to line up precisely with the celestial pole. Do not use the Electronic Controller Arrow keys to move the telescope electronically or polar alignment will be lost.

1. Orient the entire telescope, including tripod or tripod legs, so that the polar axis is pointing toward Polaris (**Fig. 14**).
2. While observing through the SP 26mm eyepiece of the telescope, adjust the length of the adjustable tripod leg until Polaris is visible in the eyepiece. Use a combination of (a) *lifting and turning the entire telescope* (or nudging the position of one of the fixed tripod legs) and (b) *adjusting the length of the adjustable tripod leg to place Polaris in the center of the telescope's field*.
3. Repeat step 2 of this procedure in about 15 minutes to see how much drift has taken place and to make the alignment more precise.

Although the above procedure is somewhat tedious (since the field of view of the telescope with the SP 26mm eyepiece is only about 1°), it is a worthwhile effort if *precise* polar alignment is desired (e.g., if photography of the Moon or a planet is to be performed). With Polaris placed in the center of the telescope's eyepiece, the telescope is now polar aligned within about one or two degrees, a level of alignment precision more than sufficient for almost any observing application.

To provide the most stable platform from which to polar align the ETX models, it is recommended to purchase the #883 Deluxe Field Tripod. The tripod head tilts easily to the local latitude angle for quick polar alignment, and it locks in a 90° position to facilitate Alt/Az viewing (see **OPTIONAL ACCESSORIES**, page 20).

### Setting Circles

The ETX models are equipped with R.A. and Dec. setting circles (**13 and 16, Fig. 1**) to aid in locating faint celestial objects *when the telescope has been polar aligned*. Setting circles emulate the celestial coordinates found on star charts or in sky catalogs. Any charted object is easily located by coordinates in R.A. (in hours, minutes, and seconds, from 0h 0m 0s to 23h 59m 59s) and Dec. (in degrees from 0° to ±90°).

With an ETX model polar aligned, use the Electronic Controller Arrow keys (**1, Fig. 3**) to move the telescope in R.A. (left and right keys) and Dec. (up and down keys).

**Note:** The Dec. setting circle is located on the left arm of the telescope fork mount. The right arm of the mount contains a graduated circle (mounted behind the knurled knob of the vertical lock), without Dec. numbers.

- **Declination Setting Circle:** The Dec. setting circle (**Fig. 31**) has been factory set to read the correct Declination of celestial objects.

Because the smooth knob on this fork mount arm need never be loosened, the Dec. setting circle should always remain calibrated. If for some reason this knob becomes loose and the Dec. setting circle must be recalibrated, level the optical tube (**5, Fig. 1**) so that it is parallel to the drive base. Loosen the smooth knob covering the Dec. setting circle until the setting circle moves freely. Reposition the setting circle so that the 0 setting aligns with the Dec. pointer (**5, Fig. 16**). Retighten the Dec. knob.

- **Right Ascension Setting Circle:** Since celestial objects move in R.A., the R.A. setting circle (**Fig. 32**) must be reset as each object is located during an observing session. The R.A. pointer is located on the drive base 90° *counterclockwise* from the telescope's Computer Control panel (**10, Fig. 1**) immediately under the R.A. circle.

To use the setting circles to find astronomical objects, the ETX must first be polar aligned. It is advisable that the motor drive be turned on (see **APPENDIX A**, page 26) and that a low-power eyepiece (e.g., the SP 26mm eyepiece) be employed. Then use the following procedure:

1. Identify the celestial coordinates (R.A. and Dec.) of a bright, easy-to-find object, such as a bright star. (Avoid using Polaris or any object near Polaris.) Coordinates of bright stars are listed in the **STAR LOCATOR**, page 27, astronomy magazines, text books, or star charts. Center this object in the telescope's field of view.
2. Manually turn the R.A. circle (**13, Fig. 1**) to read the R.A. of the object at the R.A. pointer (**7, Fig. 16**).
3. The R.A. circle is now calibrated to read the correct R.A. of any object at which the telescope is pointed. The Dec. circle is already calibrated through polar alignment.
4. To find another object, again identify the R.A. and Dec. coordinates. Then, *without touching the setting circles*, move the telescope (manually, by unlocking the vertical and horizontal locks, or by slewing the telescope using the Electronic Controller Arrow keys) so that the R.A. and Dec. pointers read the coordinates of the second object.
5. If the above procedure has been followed carefully, the second object will now be in the telescope's field of view.

**Note:** Since the second object (i.e., the object to be located) is in constant motion, once the R.A. circle is calibrated (step 2, above) the telescope should be moved rapidly to read the coordinates of the second object. Otherwise the second object will no longer be in the position indicated by the R.A. circle.

Using setting circles requires a developed technique. When using the circles for the first time, try hopping from one bright star (the calibration star) to another bright star of known coordinates. Practice moving the telescope from one easy-to-find object to another. In this way the precision required for accurate object location becomes familiar.

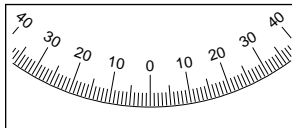

**Fig. 31:** Section of Declination setting circle.

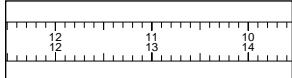

**Fig. 32:** Section of Right Ascension setting circle.

**Note:** The R.A. circle has two rows of numbers from 0 to 23, corresponding to the hours of a 24-hour clock. The upper row of numbers is used by observers in the Earth's Northern Hemisphere, the lower row by observers in the Earth's Southern Hemisphere.

## Appendix D: YOU AND THE UNIVERSE

### OBJECTS IN SPACE

In the early 17th century, Italian Scientist Galileo, using a crude telescope considerably smaller than the ETX-90EC, turned it to look towards the sky instead of distant trees and mountains. What he saw, and what he realized about what he saw, forever changed the way mankind thinks of the universe. Imagine what it must have been like being the first human to see moons revolve around the planet Jupiter or to see the changing phases of Venus! Because of his observations, Galileo correctly realized Earth's movement and position around the Sun, and in doing so, gave birth to modern astronomy. Yet Galileo's telescope was so crude, he could not clearly make out the rings of Saturn.

Galileo's discoveries laid the foundation for understanding the motion and nature of the planets, stars, and galaxies. Building on his foundation, Henrietta Leavitt determined how to measure the distance to stars; Edwin Hubble proposed a glimpse into the origin of the universe; Albert Einstein unraveled the relationship of time and light; and 21st-century astronomers are currently discovering planets around stars outside our solar system. Almost daily, using sophisticated successors to Galileo's crude telescope, such as the Hubble Space Telescope and the Chandra X-ray telescope, more and more mysteries of the universe are being solved and understood. We are living in the golden age of astronomy.

Unlike other sciences, astronomy welcomes contributions from amateurs. Much of the knowledge we have on subjects such as comets, meteor showers, variable stars, the Moon, and our solar system comes from observations made by amateur astronomers. So as you look through your Meade ETX telescope, keep in mind Galileo. To him, a telescope was not merely a machine made of glass and metal, but something far more—a window through which the beating heart of the universe might be observed.

### Autostar Glossary

If you're using the optional #497 Autostar handbox, be sure to make use of Autostar's Glossary feature. The Glossary menu provides an alphabetical listing of definitions and descriptions of common astronomical terms. Access directly through the Glossary menu or through hypertext words embedded in Autostar. See the Autostar manual for more information.

Listed below are some of the many astronomical objects that can be seen with your ETX telescope.

### The Moon

The Moon is, on average, a distance of 239,000 miles (380,000km) from Earth and is best observed during its crescent or half phase when Sunlight strikes the Moon's surface at an angle. It casts shadows and adds a sense of depth to the view (**Fig. 33**). No shadows are seen during a full Moon, causing the overly bright Moon to appear flat and rather uninteresting through the telescope. Be sure to use a neutral Moon filter when observing the Moon. Not only does it protect your eyes from the bright glare of the Moon, but it also helps enhance contrast, providing a more dramatic image.

Using your ETX model, brilliant detail can be observed on the Moon, including hundreds of lunar craters and maria, described below.

**Craters** are round meteor impact sites covering most of the Moon's surface. With no atmosphere on the Moon, no weather conditions exist, so the only erosive force is meteor strikes. Under these conditions, lunar craters can last for millions of years.

**Maria** (plural for *mare*, seas) are smooth, dark areas scattered across the lunar surface. These areas are ancient impact basins that were filled with lava from the interior of the Moon by the depth and force of the meteor or comet impact.

**12 Apollo astronauts** left their bootprints on the Moon in the late 1960's and early 1970's. However, no telescope on Earth can see these footprints or any other artifacts. In fact, the smallest lunar features that may be seen with the largest telescope on Earth are about one-half mile across.

**Note:** *Except during its early or late crescent phases, the Moon can be an exceptionally bright object to view through the telescope. To reduce the brightness and glare, use the #905 Variable Polarizing Filter (see the MEADE GENERAL CATALOG for more information).*

### Planets

Planets change positions in the sky as they orbit around the Sun. To locate the planets on a given day or month, consult a monthly astronomy magazine, such as *Sky and Telescope* or *Astronomy*. Listed below are the best planets for viewing through your ETX model telescope.

**Venus** is about nine-tenths the diameter of Earth. As Venus orbits the Sun, observers can see it go through phases (crescent, half, and full) much like those of the Moon. The disk of Venus appears white, as sunlight is reflected off the thick cloud cover that completely obscures any surface detail.

**Mars** is about half the diameter of Earth. Through the telescope it appears as a tiny reddish-orange disk. You may see a hint of white at one of the planet's polar ice caps. Approximately every two years, when Mars is closest to Earth, additional detail and coloring on the planet's surface may be visible.



**Fig. 33:** The Moon.  
Note the deep shadows in the craters.



**Fig. 34:** Jupiter and its four largest moons. The moons can be observed in a different position every night.



**Fig. 35:** Saturn has the most extensive ring structure in our Solar System.



**Fig. 36:** The Pleiades is one of the most beautiful open clusters.

**Jupiter (Fig. 34)** is the largest planet in our solar system, with a diameter 11 times that of Earth. Jupiter appears as a disk with dark lines stretching across the surface. These lines are cloud bands in the atmosphere. Four of Jupiter's 29 (and still counting!) moons (Io, Europa, Ganymede, and Callisto) can be seen as star-like points of light when you use even the lowest magnification. The number of moons visible on any given night changes as they circle around the giant planet.

**Saturn (Fig. 35)** is nine times the diameter of Earth and appears as a small, round disk with rings extending out from either side. In 1610, Galileo, the first person to observe Saturn through a telescope, did not understand that what he was seeing were rings. Instead, he believed that Saturn had "ears." Saturn's rings are composed of billions of ice particles. The major division in Saturn's rings, called the Cassini Division, is generally visible through all three ETX models. Titan, the largest of Saturn's moons, can also be seen as a bright, star-like object near the planet.

### Deep-Sky Objects

You can use star charts to locate constellations, individual stars, and deep-sky objects. Examples of various deep-sky objects are given below:

**Stars** are large gaseous objects that are illuminated by nuclear fusion in their core. Because of their vast distances from our solar system, all stars appear as pinpoints of light, regardless of the size of the telescope used.

**Nebulae** are vast interstellar clouds of gas and dust where stars are formed. Most impressive of these is the Great Nebula in Orion (M42), a diffuse nebula that appears as a faint wispy gray cloud. M42 is 1600 light years from Earth.

**Open Clusters** are loose groupings of young stars, all recently formed from the same diffuse nebula. The Pleiades (**Fig. 36**) is an open cluster 410 light years from Earth. Several hundred stars of the cluster are visible through the your telescope.

**Constellations** are large, imaginary patterns of stars believed by ancient civilizations to be the celestial equivalent of objects, animals, people, or gods. These patterns are too large to be seen through a telescope. To learn the constellations, start with an easy grouping of stars, such as the Big Dipper in Ursa Major. Then use a star chart to explore across the sky.

**Galaxies** are large assemblies of stars, nebulae, and star clusters that are bound by gravity. The most common shape is spiral (such as our own Milky Way), but galaxies can also be elliptical, or even irregular blobs. The Andromeda Galaxy (M31) is the closest spiral-type galaxy to our own. This galaxy appears fuzzy and cigar-shaped. It is 2.2 million light years away in the constellation Andromeda.

## TIPS FOR BEGINNERS

### Further Study...

This manual gives only the briefest introduction to astronomy. If you are interested in pursuing further studies in astronomy, a few topics are suggested below that are worth reading up on. Try looking up some of these in the optional Autostar glossary.

Also included below is a small sampling of books, magazines, and organizations that you might find helpful.

### Topics

1. How is a star born? How does a solar system form?
2. How is the distance to a star measured? What is a light year? What is red shift and blue shift?
3. How are the craters on our Moon formed? How old is the Moon and Earth? How old is the Sun?
4. What is a black hole? A neutron star?
5. What are stars made of? Why are stars different colors? What is a white dwarf? A red giant? Have we ever seen the surface of a star besides our own sun?
6. What is a nova? A supernova?
7. What are comets? Minor planets? Meteors? Meteor showers? Where do they come from?
8. What is a planetary nebula? A globular cluster?
9. What is the Big Bang? Is the universe expanding or contracting, or does it always remain the same? What is dark matter?
10. What is an extrasolar planet? What is an accretion (or protoplanetary) disk?
11. What is the difference between an elliptical, a spiral, and an irregular galaxy?

### Books

1. The Guide to Amateur Astronomy by Jack Newton and Philip Teece
2. The Sky: A User's Guide by David Levy
3. Turn Left at Orion by Guy Consolmagno & Dan Davis
4. Astrophotography for the Amateur by Michael Covington

### Magazines

1. *Sky & Telescope*  
Box 9111, Belmont, MA 02178
2. *Astronomy*  
Box 1612, Waukesha, WI 53187

### Organizations:

1. Astronomical League  
Executive Secretary  
5675 Real del Norte, Las Cruces, NM 88012
2. The Astronomical Society of the Pacific  
390 Ashton Ave, San Francisco, CA 94112
3. The Planetary Society  
65 North Catalina Ave, Pasadena, CA 91106

And watch Jack Horkheimer, *Star Gazer*, on your local PBS station.



## MEADE LIMITED WARRANTY

Every Meade telescope, spotting scope, and telescope accessory is warranted by Meade Instruments Corporation ("Meade") to be free of defects in materials and workmanship for a period of ONE YEAR from the date of original purchase in the U.S.A. and Canada. Meade will repair or replace a product, or part thereof, found by Meade to be defective, provided the defective part is returned to Meade, freight-prepaid, with proof of purchase. This warranty applies to the original purchaser only and is non-transferable. Meade products purchased outside North America are not included in this warranty, but are covered under separate warranties issued by Meade international distributors.

**RGA Number Required:** Prior to the return of any product or part, a Return Goods Authorization (RGA) number **must** be obtained from Meade by writing, or by calling (949) 451-1450. Each returned part or product must include a written statement detailing the nature of the claimed defect, as well as the owner's name, address, and phone number.

This warranty is not valid in cases where the product has been abused or mishandled, where unauthorized repairs have been attempted or performed, or where depreciation of the product is due to normal wear-and-tear. Meade specifically disclaims special, indirect, or consequential damages or lost profit which may result from a breach of this warranty. Any implied warranties which cannot be disclaimed are hereby limited to a term of one year from the date of original retail purchase.

This warranty gives you specific rights. You may have other rights, which vary from state to state.

Meade reserves the right to change product specifications or to discontinue products without notice.

This warranty supersedes all previous Meade product warranties.



### WARNING

This equipment has been tested and found to comply with the limits for a CLASS B digital device, pursuant to Part 15 of the FCC Rules. These limits are designed to provide reasonable protection against harmful interference in a residential installation. This equipment generates, uses, and can radiate radio frequency energy and, if not installed and used in accordance with the instructions contained in this manual, may cause harmful interference to radio and television communications. However, there is no guarantee that interference will not occur in a particular installation.

If this equipment does cause harmful interference to radio or television reception, which can be determined by turning the equipment off and on, the user is encouraged to try to correct the interference by one or more of the following measures:

- Reorient or relocate the receiving antenna.
- Increase the separation between the equipment and the receiver.
- Connect the equipment into an outlet on a circuit different from that of the receiver.
- Consult the dealer or an experienced audio/television technician.

Note: Connecting this device to peripheral devices that do not comply with CLASS B requirements or using an unshielded peripheral data cable could also result in harmful interference to radio or television reception.

The user is cautioned that any changes or modifications not expressly approved by the party responsible for compliance could void the user's authority to operate this equipment.

To ensure that the use of this product does not contribute to interference, it is necessary to use shielded I/O cables.



*ADVANCED PRODUCTS DIVISION*

**Meade Instruments Corporation**

*World's Leading Manufacturer of Astronomical Telescopes for the Serious Amateur*

6001 Oak Canyon, Irvine, California 92618 ■ (949) 451-1450

FAX: (949) 451-1460 ■ [www.meade.com](http://www.meade.com)

© 2001

Ver. 0501 Part no. 14-1010-20