

Panasonic®

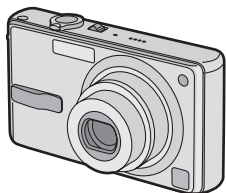

Operating Instructions Digital Camera

Model No. **DMC-FX7PP**

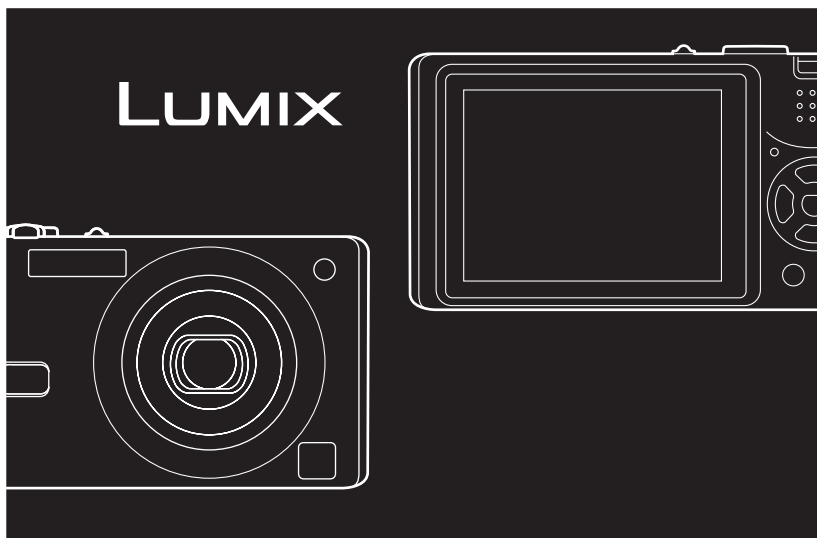

Before use, please read these
instructions completely.

LEICA
DC VARIO-ELMARIT

For USA assistance, please call: 1-800-272-7033 or send e-mail to : digitalstillcam@panasonic.com

For Canadian assistance, please call: 1-800-561-5505 or visit us at www.panasonic.ca

VQT0M16

Dear Customer,

We would like to take this opportunity to thank you for purchasing this Panasonic Digital Camera. Please read these Operating Instructions carefully and keep them handy for future reference.

Information for Your Safety

WARNING

TO REDUCE THE RISK OF FIRE OR SHOCK HAZARD AND ANNOYING INTERFERENCE, USE ONLY THE RECOMMENDED ACCESSORIES AND DO NOT EXPOSE THIS EQUIPMENT TO RAIN OR MOISTURE. DO NOT REMOVE THE COVER (OR BACK); THERE ARE NO USER SERVICEABLE PARTS INSIDE. REFER SERVICING TO QUALIFIED SERVICE PERSONNEL.

Notice:

This product has parts that contain a small amount of mercury. It also contains lead in some components. Disposal of these materials may be regulated in your community due to environmental considerations. For disposal or recycling information please contact your local authorities, or the Electronics Industries Alliance: <<http://www.eiae.org>.>

Carefully observe copyright laws. Recording of pre-recorded tapes or disks or other published or broadcast material for purposes other than your own private use may infringe copyright laws. Even for the purpose of private use, recording of certain material may be restricted.

- Please note that the actual controls and components, menu items, etc. of your Digital Camera may look somewhat different from those shown in the illustrations in these Operating Instructions.
- SD Logo is a trademark.
- Other names, company names, and product names printed in these instructions are trademarks or registered trademarks of the companies concerned.

THE SOCKET OUTLET SHALL BE INSTALLED NEAR THE EQUIPMENT AND SHALL BE EASILY ACCESSIBLE.

CAUTION

Danger of explosion if battery is incorrectly replaced. Replace only with the same or equivalent type recommended by the manufacturer. Dispose of used batteries according to the manufacturer's instructions.



A lithium ion/polymer battery that is recyclable powers the product you have purchased. Please call 1-800-8-BATTERY for information on how to recycle this battery.

FCC Note: (U.S. only)

This equipment has been tested and found to comply with the limits for a Class B digital device, pursuant to Part 15 of the FCC Rules. These limits are designed to provide reasonable protection against harmful interference in a residential installation. This equipment generates, uses, and can radiate radio frequency energy and, if not installed and used in accordance with the instructions, may cause harmful interference to radio communications. However, there is no guarantee that interference will not occur in a particular installation. If this equipment does cause harmful interference to radio or television reception, which can be determined by turning the equipment off and on, the user is encouraged to try to correct the interference by one or more of the following measures:

- Reorient or relocate the receiving antenna.
- Increase the separation between the equipment and receiver.
- Connect the equipment into an outlet on a circuit different from that to which the receiver is connected.
- Consult the dealer or an experienced radio/TV technician for help.

FCC Caution: To assure continued compliance, follow the attached installation instructions and use only shielded interface cables with ferrite core when connecting to computer or peripheral devices.

Any changes or modifications not expressly approved by the party responsible for compliance could void the user's authority to operate this equipment.

Trade Name: Panasonic
Model No.: DMC-FX7
Responsible party: Matsushita Electric Corporation of America
One Panasonic Way, Secaucus, NJ 07094
Support Contact: Panasonic Consumer Electronics Company
1-800-272-7033

This device complies with Part 15 of the FCC Rules. Operation is subject to the following two conditions: (1) This device may not cause harmful interference, and (2) this device must accept any interference received, including interference that may cause undesired operation.

This Class B digital apparatus complies with Canadian ICES-003

FC Panasonic
DMC-FX7

■ Care for the camera

- **Do not shake or cause impact to the camera.** The camera may not operate normally or recording of pictures may be disabled, or the lens may be damaged.
- **Sand or dust may cause a malfunction of the camera. When you use the camera on a beach etc., take care so that sand or dust does not get into the camera.**
- When you use the camera on a rainy day or on a beach, take care so that seawater does not get into the camera.
- **If seawater splashes onto the camera, wet a soft cloth with tap water, wring it well, and use it to wipe the camera body carefully. Then, wipe it again with a dry cloth.**

■ About the LCD monitor

- **Do not press the LCD monitor strongly. It may cause uneven colors on the LCD monitor or a malfunction of the LCD monitor.**
- In a place with drastic temperature changes, condensation may form on the LCD monitor. Wipe it with a soft, dry cloth.
- If the camera is extremely cold when you turn the camera on, the image on the LCD monitor is slightly darker than usual at first. However, as the internal temperature increases, it goes back to the normal brightness.

Extremely high precision technology is employed to produce the LCD monitor screen. The result is more than 99.99% effective pixels with a mere 0.01% of the pixels inactive or always lit. However, this will not be recorded on the pictures in the card.

■ About the Lens

- Do not direct the lens to the sun or strong light sources. It may cause not only a malfunction of the camera but irreversible damage to your eye.
- Do not press the lens strongly.

- Leaving the camera with the lens facing the sun may cause a malfunction. Be careful when you put the camera outside or near a window.

■ About Condensation

Condensation takes place when the ambient temperature or humidity is changed as follows:

Be careful of the condensation since it causes stains on the lens, fungus or malfunction. (P95)

- When the camera is brought inside from the cold to a warm room.
- When the camera is moved from outside of a car to an air-conditioned car.
- When cool wind from an air conditioner or other source is directly blown onto the camera.
- In humid places

■ If you will not be using the camera for a long time

- Store the battery in a cool and dry place with a relatively stable temperature. (Recommended temperature: 59°F–77°F (15°C–25°C), Recommended humidity: 40%–60%)
- Be sure to remove the battery and the card from the camera.
- When the battery is left inserted in the camera for a long time, discharge takes place even if the camera is turned off. If you leave the battery inserted for an extended period of time, it will be excessively discharged and it may become unusable even after it is charged.
- To store the battery for a long period of time, we recommend charging it once every year and storing it again after you completely use up the charged capacity.
- When you keep the camera in a closet or a cabinet, we recommend storing it with the desiccant (silica gel).

About These Operating Instructions

Please note that the description on this page is a sample and all pages are not described in this manner.



Modes indicated here allow you to use the functions or settings described on this page. Set the Mode dial to any of the modes to use the functions or settings.

Using the Optical Zoom



You can make people and subjects appear closer with the 3 times optical zoom, and landscapes can be recorded in wide angle.



- The picture may have some distortion (typical example: vertical straight line bent outwards).

Convenient or helpful information for use of this camera is described.

■ About pictures/illustrations in these operating instructions

Pictures in these operating instructions are composed from still photographs for explanation.

Please note that the appearance of the product, the illustration or the menu screen are a little different from those in actual use.

■ About illustrations of the cursor button

In those operating instructions, the operations on the cursor button are described as illustrated below.

e.g.: When you press the ▼ button

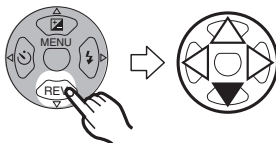

Contents

Before Use

Information for Your Safety	2
About These Operating Instructions	5

Preparation

Standard Accessories	8
Names of the Components	9
Quick Guide	11
Charging the Battery with the Charger ...	12
About the Battery	13
Inserting/Removing the Battery	14
Inserting/Removing the Card	15
About the Card	16
Approximate number of recordable pictures and the size	17
Setting Date/Time (Clock Set)	18
Setup Menu	20
About the LCD Monitor	24

Recording pictures (basic)

Taking Pictures	27
Taking Pictures in Simple Mode	32
Checking the Recorded Picture (Review)	35
Using the Optical Zoom	36
Taking Pictures using the Built-in Flash	37
Taking Pictures with the Self-timer	40
Compensating the Exposure	41
Taking Pictures using Auto Bracket	42
Optical Image Stabilizer [STABILIZER]	43
Taking Pictures using Burst Mode	44

Playback (basic)

Playing Back Pictures	45
9 Pictures Multi Playback	46
Using the Playback Zoom	47
Deleting Pictures	48

Recording pictures (advanced)

Using the Mode Dial	50
• Macro mode	50
• Motion image mode	51
• Scene mode	53
– Portrait mode	54
– Sports Mode	54
– Scenery mode	55
– Night scenery mode	55
– Night portrait mode	56
– Fireworks mode	56
– Party mode	57
– Snow mode	57
– Self portrait mode	58
Using the [REC] mode menu	59
• White Balance [W.BALANCE]	60
• ISO Sensitivity [SENSITIVITY]	62
• Picture Size [PICT.SIZE]	62
• Quality [QUALITY]	63
• Audio Recording [AUDIO REC.]	63
• AF Mode [AF MODE]	64
• AF Assist Lamp [AF ASSIST LAMP]	65
• Slow Shutter [SLOW SHUTTER]	65
• Digital Zoom [D.ZOOM]	66
• Color Effect [COL.EFFECT]	66
• Picture Adjustment [PICT.ADJ.]	66
• Flip Animation [FLIP ANIM.]	67

Playback (advanced)

Playing Back Pictures with Audio/Motion Images	70
Using the [PLAY] mode menu	71
• Rotating the Picture [ROTATE].....	71
• Setting the Picture to be Printed and the Number of Prints [DPOF PRINT].....	72
• Preventing Accidental Erasure of the Picture [PROTECT]	74
• Playing Back with Slide Show [SLIDE SHOW].....	75
• Adding Audio to Recorded Pictures [AUDIO DUB.]	77
• Resizing the Pictures [RESIZE]	78
• Trimming the Pictures [TRIMMING]	79
• Initializing the Card [FORMAT]	80
Playing Back Pictures with a TV Screen	82

Connecting to a PC or Printer

Before Connecting with USB Connection Cable [USB MODE].....	83
Connecting to a PC.....	85
Connecting to a PictBridge-compliant Printer.....	87

Others

Screen Display	91
Cautions for Use	94
Message Display	97
Troubleshooting	98
Specifications.....	101
Digital Camera Accessory System.....	103
Digital Camera Accessory Order Form (For USA Customers).....	104
Request for Service Notice (For USA Only).....	105
Limited Warranty (For USA Only)	106
Customer Services Directory (For USA Only).....	108
Index	109
Spanish Quick Use Guide/Guía española de uso rápido.....	111

Standard Accessories

Before using your camera, check the contents.

■ **SD Memory Card (16 MB)**

RP-SD016B

(In the text, it is indicated as “Card”)

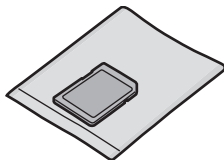

■ **USB Connection Cable**

K1HA08CD0001



■ **Battery Pack**

CGA-S004A

(In the text, it is indicated as “Battery”)

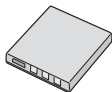

■ **CD-ROM**



■ **Battery Charger**

DE-991B

(In the text, it is indicated as “Charger”)

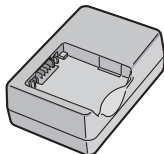

■ **Strap**

VFC4082

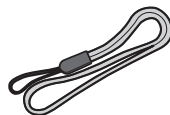

■ **AV Cable**

K1HA08CD0002



■ **Battery Carrying Case**

VYQ3211



Names of the Components

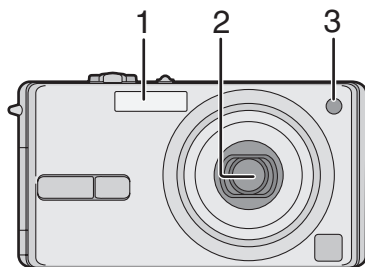

- 1 Flash (P37)
- 2 Lens part
- 3 Self-timer Indicator (P40)
AF Assist Lamp (P65)

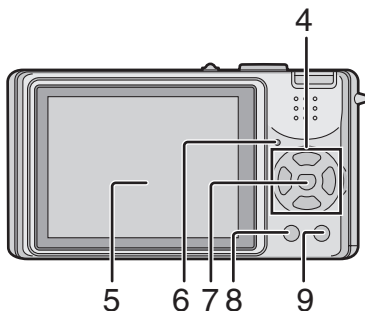

- 4 Cursor buttons
 - ◀/Self-timer Button (P40)
 - ▼/[REV] Button (P35)
 - ▶/Flash Mode Button (P37)
 - ▲/Backlight Compensation in Simple Mode (P34)/Exposure Compensation (P41)/Auto Bracket (P42)/White Balance Fine Adjustment (P61) Button
- 5 LCD Monitor Type 2.5 (P24, 91)
- 6 Status Indicator (P22)
- 7 [MENU] Button (P20)
- 8 [DISPLAY/PWR LCD] Button (P24)
- 9 Single/Burst Mode (P44)/Delete Button (P48)

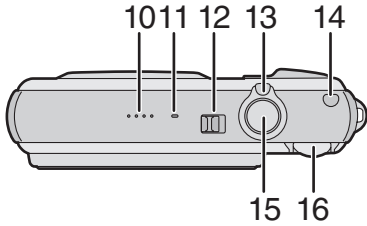

- 10 Speaker for Operational Sound
- 11 Microphone (P51)
- 12 Camera Switch (P20)
- 13 Zoom Lever (P36, 66)
- 14 Optical Image Stabilizer Button (P43)
- 15 Shutter Button (P28, 51)
- 16 Mode Dial (P27)

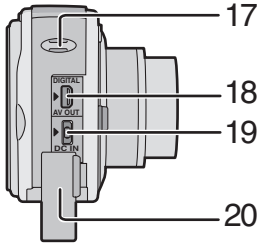

- 17 Strap Eyelet
- 18 [DIGITAL/AV OUT] Socket (P82, 85, 87)
- 19 [DC IN] Socket (P85, 87)
 - Please be sure to use genuine Panasonic AC adaptor (DMW-CAC2; optional).
- 20 Terminal Cover

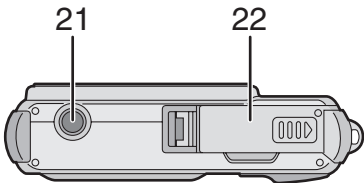

- 21 Tripod Receptacle
- 22 Card/Battery Door (P14, 15)

Quick Guide

This is the overview of the procedure to record pictures with this camera. For each operation, be sure to refer to the corresponding pages.

1 Charge the battery. (P12)

- When the camera is shipped, the battery is not charged. Charge the battery before use.

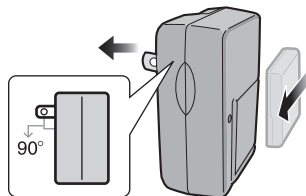

2 Insert the battery and the card. (P14, 15)

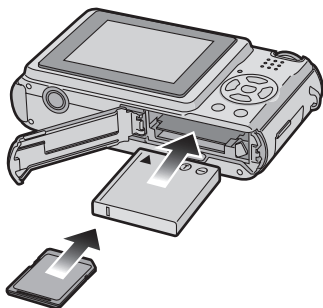

3 Turn the camera on to take pictures.

- Set the clock. (P18)

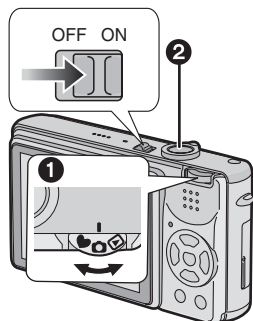

- 1 Set the mode dial to [📷].
- 2 Press the shutter button to take pictures. (P28)

4 Play back the pictures.

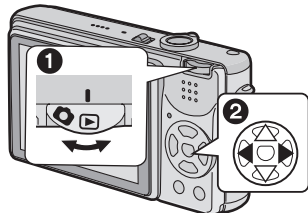

- 1 Set the mode dial to [▶].
- 2 Select the picture you want to view. (P45)

Charging the Battery with the Charger

When the camera is shipped, the battery is not charged. Charge the battery before use.

1 Attach the battery with attention to the direction of the battery.

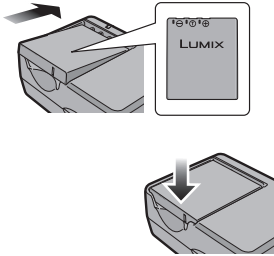

- After charging is completed, be sure to disconnect the charger from the electrical outlet.
- The battery becomes warm after use/charge or during charge. The camera also becomes warm during use. However, this is not a malfunction with the camera.
- **Use the dedicated charger and battery.**
- **Charge the battery with the charger indoors.**
- **Do not disassemble or modify the charger.**

2 Connect the charger to the electrical outlet.

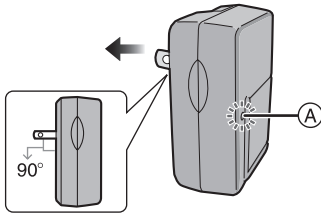

- When the [CHARGE] indicator (A) lights in green, charging starts.
- When the [CHARGE] indicator (A) turns off (in about 120 minutes), charging is completed.

3 Detach the battery.

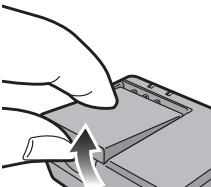

About the Battery

■ Battery indication

The remaining battery power appears on the screen. [It does not appear when you use the camera along with the AC adaptor (DMW-CAC2; optional).]

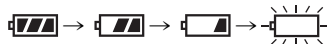

The indication turns red and blinks: Recharge or replace the battery.

When the LCD monitor is set to off by the economy mode, the status indicator blinks.

■ The lifetime of the battery

The number of recordable pictures by CIPA standards

- CIPA is an abbreviation of [Camera & Imaging Products Association].

Number of recordable pictures	Approx. 120 pictures (CIPA)
-------------------------------	-----------------------------

(Recording conditions by CIPA standards)

- Temperature: 73.4°F (23°C)/ Humidity: 50% when LCD monitor is on.
- Using SD Memory Card (supplied: 16MB).
- Using the supplied battery.
- Recording starts 30 seconds after the camera is turned on.
- Record once every 30 seconds, with full flash every other recording.
- Rotating the zoom lever towards Tele to Wide and vice versa in every recording.
- Turn the camera off every 10 recordings.

Note: When the Power LCD function (P25) is used, the number of recordable pictures decreases.

Playback time

Playback time	Approx. 100 min.
---------------	------------------

The number of recordable pictures and playback time will vary depending on the operating conditions and storing condition of the battery.

■ Charging

Charging time	Approx. 120 min.
---------------	------------------

Charging time and the number of recordable pictures with the optional battery pack (CGA-S004A) are the same as the above.

- When charging starts, the [CHARGE] indicator lights.

■ Charging error

- If the [CHARGE] indicator is blinking, this is a charging error. In this case, disconnect the charger from the electrical outlet, detach the battery and then make sure both room and battery temperature are not too low or high. If the room temperature is between 50°F–95°F (10°C–35°C), recharge the battery. If the [CHARGE] indicator does not turn off properly and still starts blinking after you completed recharging the battery, consult the dealer.
- When the operating time of the camera becomes extremely short even if the battery is properly charged, the life of the battery may have expired. Buy a new battery.

■ Charging conditions

- Charge the battery under temperature of 50°F–95°F (10°C–35°C). (Battery temperature should be the same also.)
- The performance of the battery may be temporarily deteriorated and the operating time may become shorter in low temperature conditions (e.g. skiing/snowboarding).

Inserting/Removing the Battery

- Check that the camera is turned off and that the lens is retracted.

1 Slide the card/battery door to open it.

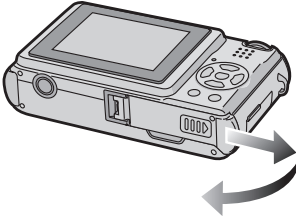

- Please be sure to use genuine Panasonic batteries (CGA-S004A).

2 Insert:
Insert the charged battery until it clicks paying attention to the direction of the battery.

Remove:
Slide the lock ① to remove the battery.

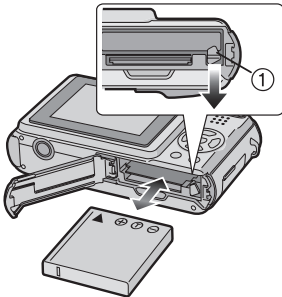

3 ① Close the card/battery door.
② Slide the card/battery door to the end and then close it firmly.

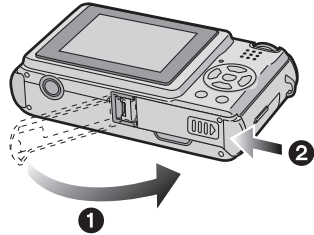

- If you will not be using the camera for a long time, remove the battery. Store the removed battery in the battery carrying case (supplied). (P95)
- When fully charged battery has been inserted for more than 24 hours, the clock setting is stored (in the camera) for at least 3 months even if the battery is removed. (The storing may be shorter if the battery is not charged sufficiently.) If more than 3 months has passed, the clock setting will be lost. In this case, set the clock again. (P18)
- Do not remove the card and the battery while the card is being accessed. The data on the card may be damaged.
- The supplied battery is designed only for use with this camera. Do not use it with any other equipment.

Inserting/Removing the Card

- Check that the camera is turned off and that the lens is retracted.

1 Slide the card/battery door to open it.

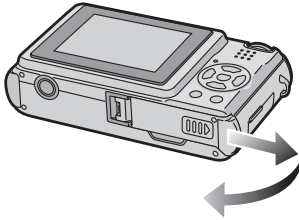

- The card and the data may be damaged if it is inserted or removed while the camera is on.
- We recommend using Panasonic's SD Memory Card. (Use only the genuine SD card with SD Logo.)

2 Insert:

Insert the card with the label side facing the back of the camera until it clicks.

Remove:

Push the card until it clicks, then pull the card out upright.

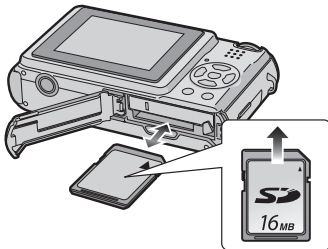

- Check the direction of the card.
- Do not touch the connection terminals on the back side of the card.
- The card may be damaged if it is not fully inserted.

3 ① Close the card/battery door.

② Slide the card/battery door to the end and then close it firmly.

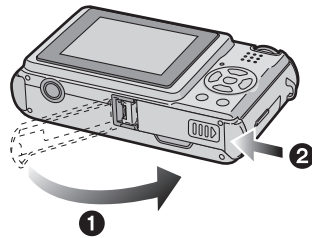

- If the card/battery door cannot be completely closed, remove the card and insert it again.

About the Card

■ Access to the card

While the card is being accessed (Recognizing/Recording/Reading/Deleting), the card access indication ① lights.

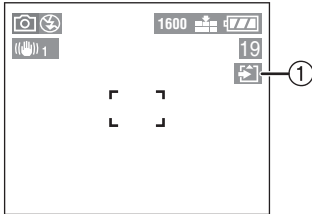

When the card access indication ① lights, do not:

- turn the camera off.
- remove the battery or the card.
- shake or impact the camera.

The card and the data may be damaged and the camera may not operate normally.

■ About handling a card

Store precious data to your PC (P85). The data on the card may be damaged or lost due to electromagnetic wave, static electricity, breakdown of this camera or a defective card.

■ SD Memory Card (supplied) and MultiMediaCard (optional)

The SD Memory Card and MultiMediaCard are small, lightweight, removable external memory cards. The reading/writing speed of an SD Memory Card is fast. The SD Memory Card is equipped with a Write-Protect switch ① that can inhibit writing and formatting a card. (When the switch is slid to the [LOCK] side, it is not possible to write or delete data on the card and format it. When the switch is unlocked, these functions become available.)

SD Memory Card

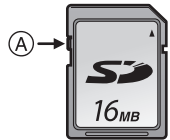













MultiMediaCard



- The reading/writing speed of a MultiMediaCard is slower than an SD Memory Card. When a MultiMediaCard is used, the performance of certain features may be slightly slower than advertised.
- After recording motion images using the MultiMediaCard, the card access indication may appear for a while, but this is not a malfunction.
- Keep the Memory Card out of reach of children to prevent swallowing.

Approximate number of recordable pictures and the size

Picture size	2560×1920		2048×1536		1600×1200	
Quality						
16 MB	5	11	9	17	14	28
32 MB	12	24	19	37	31	59
64 MB	25	49	39	75	63	121
128 MB	51	100	79	153	128	244
256 MB	102	200	157	306	255	487
512 MB	205	403	317	616	515	982
1 GB	395	775	610	1185	991	1889

Picture size	1280×960		640×480		1920×1080 (HDTV)	
Quality						
16 MB	22	41	69	113	13	25
32 MB	47	86	145	236	28	54
64 MB	96	176	298	484	58	110
128 MB	195	356	602	979	118	223
256 MB	390	709	1200	1950	236	445
512 MB	785	1429	2418	3929	476	898
1 GB	1511	2748	4650	7557	916	1727



- If you select a larger picture size, you can print pictures clearly. When you select a smaller picture size, you can store more pictures on a card though the picture quality is deteriorated.
- The numbers are approximations. (If you mix Fine and Standard quality, the number of recordable pictures changes.)
- The number of recordable pictures may vary depending on subjects.
- The remaining number of recordable pictures displayed on the screen is an approximation.

Setting Date/Time (Clock Set)

■ Initial setting

The clock is not set when the camera is shipped. When you turn the camera on, the following screen appears.

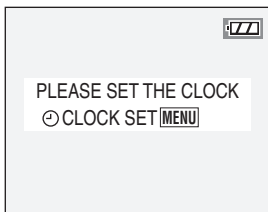

- Press the [MENU] button, the screen shown in step 2 appears.
- The screen disappears in about 5 seconds. To access clock set menu, start from step 1.

1 Select [CLOCK SET] from the [SETUP] menu. (P20)

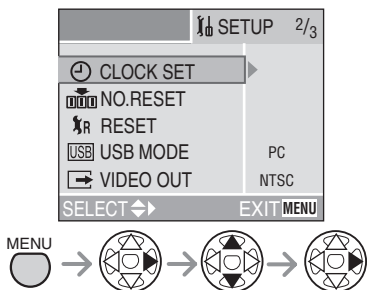

2 Set date and time.

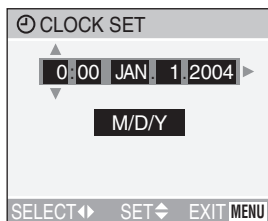

- ◀/▶: Select the desired item.
- ▲/▼: Set date and time.

3 Select [M/D/Y], [D/M/Y] or [Y/M/D].

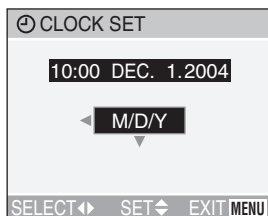

- Close the menu by pressing the [MENU] button 2 times after finishing the setting.
- Check if the clock setting is correct, after turning the camera off and on.



- When a fully charged battery has been inserted for more than 24 hours, the clock setting is stored (in the camera) for at least 3 months even if the battery is removed. (The storing time may be shorter if the battery is not charged sufficiently.)

If more than 3 months has passed, the clock setting will be lost. In this case, set the clock again.

- You can set the year from 2000 to 2099. The 24-hour system is used.
- If you do not set the date, the date cannot be printed when you go to a photo studio for digital printing.
- For the date print setting, refer to P73.

Setup Menu

1 Turn the camera on.

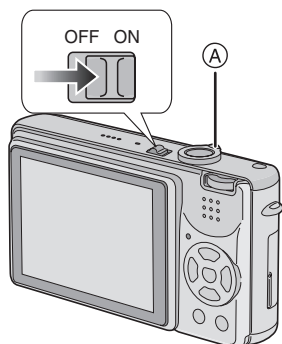

2 Press the [MENU] button.

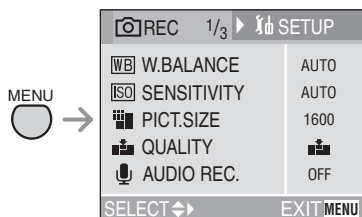

- The menu items depend on the mode selected with the mode dial. In this page, the items in normal picture mode [] are indicated.
- The menu screen in simple mode [] is different from the above screen. (P32)

3 Select the [SETUP] Menu.

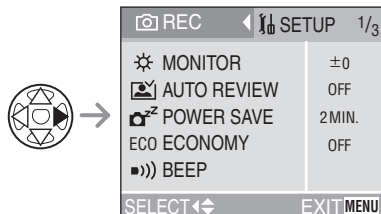

- When rotating the zoom lever (A) toward T, the page of the menu screen can be forwarded. (vice versa)

4 Select the desired item.

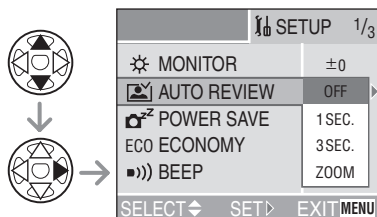



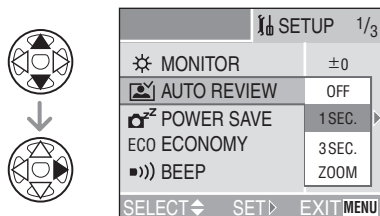

5 Set the desired value.









Be sure to press ▶ at the end to determine the setting.

- Close the menu by pressing the shutter button halfway or the [MENU] button after finishing the setting.

You can control the following items on [SETUP] Menu.

Menu	Functions
 MONITOR	Adjust the brightness of the LCD monitor in 7 steps.
 AUTO REVIEW	<p>[OFF]: The recorded picture does not automatically appear.</p> <p>[1SEC.]: The recorded picture automatically appears on the screen for about 1 second.</p> <p>[3SEC.]: The recorded picture automatically appears on the screen for about 3 seconds.</p> <p>[ZOOM]: The recorded picture automatically appears on the screen for about 1 second. Then it is enlarged 4 times and appears for about 1 second. This mode is useful for confirming focus. Pictures in burst mode, auto bracket, pictures with audio are not enlarged even if [ZOOM] is selected.</p> <ul style="list-style-type: none"> • In motion image mode [, auto review function is not activated. • When pictures are recorded in burst mode or auto bracket, the time for the auto review function is fixed to 1 second regardless of the setting on the [SETUP] menu. (The picture is not enlarged.) • When using pictures with audio, the auto review function works while recording the audio or the data into the card regardless of the setting on the auto review function. (The picture is not enlarged.)
 POWER SAVE	<p>The battery life is saved by turning the camera off automatically while the camera is not being used.</p> <p>[1MIN.]/[2MIN.]/[5MIN.]/[10MIN.]: The camera is automatically turned off if it has not been used for a predetermined amount of time. (Press the shutter button or turn the camera off and on to recover from the power save mode.)</p> <ul style="list-style-type: none"> • When connecting to a PC or a printer/recording motion images/playing back motion images/during Slide Show, the power save mode is not activated. • In the economy mode, the power save is set to [2MIN.].

Menu	Functions
ECONOMY (works in modes except playback mode and simple mode)	The battery life is saved by turning the LCD monitor off automatically. (Press any button to recover from the economy mode.) [OFF]: Economy mode cannot be activated. [LEVEL1]: The LCD monitor turns off and the status indicator turns on if you do not use the camera for about 15 seconds. [LEVEL2]: The LCD monitor turns off and the status indicator turns on if you do not use the camera for about 15 seconds or you leave it for about 5 seconds after taking pictures. <ul style="list-style-type: none"> • In the economy mode, the power save is set to [2MIN.]. • In the economy mode, the LCD monitor is off while the flash is being charged. • The economy mode is not activated while the menu screen is displayed or the self-timer is set. • The economy mode is not activated while the AC adaptor/DMW-CAC2 (optional) is used or recording motion images.
BEEP	[BEEP LEVEL]: [OFF]: No operational sound [L]: Soft operational sound [H]: Loud operational sound [BEEP TONE]: ① ② ③ [SHUTTER]: ① ② ③
CLOCK SET	Change date and time. (P18)
NO.RESET	Set this when you want to start the file number of the picture from 0001 on the next recording. (The folder number is updated, and the file number starts from 0001.) <ul style="list-style-type: none"> • The folder number can be assigned from 100 to 999. When the folder number reaches 999, it cannot be reset. We recommend formatting the card after saving the data on a PC or elsewhere. • When you insert a formatted card or a new card and select this item, the file number is reset and the confirmation screen for reset of folder number appears. If you select [YES] on the screen, the folder number is reset to 100.

Menu	Functions
 RESET	The settings on the recording or the [SETUP] menu are reset to the initial settings. However, the folder number and the clock setting are not changed.
 USB MODE	Set the USB communication system. Set before connecting to a PC or a printer. (P83)
 VIDEO OUT (Playback mode only)	[NTSC]: Video output is set to NTSC system. [PAL]: Video output is set to PAL system. (P82)
 SCENE MENU	[AUTO]: Scene menu appears automatically when setting the mode dial to scene mode. Select the desired scene mode. [OFF]: Scene menu does not appear when setting the mode dial to scene mode and the camera is operated in the scene mode currently selected. If you change the scene mode, press the [MENU] button to display the scene menu and then select the desired scene mode.
 LANGUAGE	Set to the language on the menu screen from the following 7 languages. Set to the desired language with ▲/▼ and determine it with ►. [ENGLISH]: English [DEUTSCH]: German [FRANÇAIS]: French [ESPAÑOL]: Spanish [ITALIANO]: Italian [中文]: Chinese (Simplified) [日本語]: Japanese • When you set to other language by mistake, select [ >] from the menu icons to set the desired language.

- The settings on [BEEP LEVEL], [BEEP TONE], [NO.RESET] and [LANGUAGE] are also reflected in simple mode [].

About the LCD Monitor

■ Selecting the screen to be used

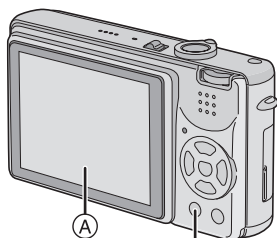

DISPLAY/PWR LCD

Ⓐ LCD monitor (LCD)

Press the [DISPLAY/PWR LCD] button to switch to the screen to be used.

- When the menu screen appears, the [DISPLAY/PWR LCD] button is not activated. During 9 pictures multi playback (P46) or playback zoom (P47), the indications on the screen can be turned on and off.

In simple mode [♥] (P32)

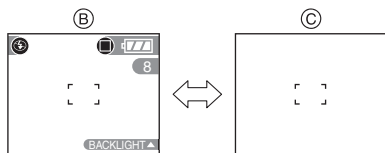

- Ⓑ Display
- Ⓒ Non-display

In recording mode (P27)

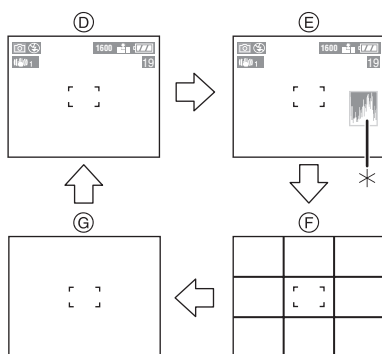

- Ⓓ Display
- Ⓔ Display with histogram
- Ⓕ Non-display (Recording guide line)
- Ⓖ Non-display
- *Histogram

In playback mode (P45)

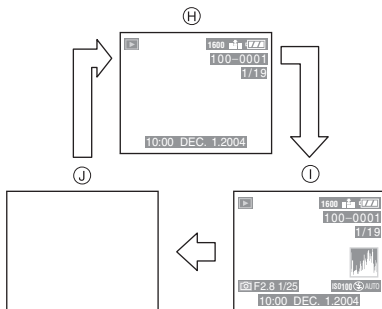

- Ⓕ Display
- Ⓖ Display with recording information and histogram
- Ⓙ Non-display

■ To view the LCD monitor outdoors on a bright sunny day (Power LCD function)

When you press and hold the [DISPLAY/PWR LCD] button for 1 second, the power LCD function is activated, the LCD monitor becomes brighter than usual and easier to see outdoors.

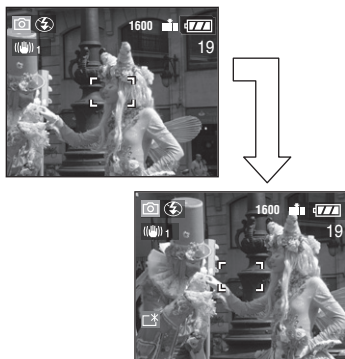

■ Recording guide line

When you align the subject on the horizontal and vertical guide lines or the cross point of these lines, you can take pictures with well-designed composition by viewing the size, the slope and the balance of the subject.

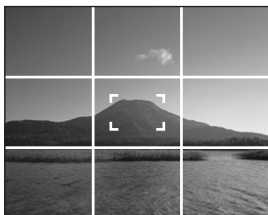

- This function does not affect recorded pictures.
- When you take pictures, the LCD monitor automatically reverts back to the normal brightness 30 seconds after the [DISPLAY/PWR LCD] button is pressed. If you press any button, the LCD monitor turns on brightly again.
- If you press and hold [DISPLAY/PWR LCD] button for 1 second again, the power LCD function is canceled and the LCD monitor reverts back to its usual brightness.

■ Histogram

- A histogram is a graph that displays brightness along the horizontal axis (black to white) and the number of pixels at each brightness level on the vertical axis.
 - It allows the camera user to easily check the way a picture is being exposed.
 - It is very useful if manual adjustments of the lens aperture and shutter speed are available, especially in those situations where automatic exposure may be difficult due to uneven lighting. Using the histogram feature will allow you to get the best performance from the camera.
 - When the values are concentrated to the left (A), the picture is under exposed.
 - When the values in the histogram are distributed evenly (B), the exposure is adequate and the brightness is well-balanced.
 - When the values are concentrated to the right (C), the picture is over exposed.
- **When you take pictures with the flash or in dark places, the histogram is displayed in orange because the recorded picture and the histogram do not match each other.**
 - The histogram does not appear when in motion image mode [MOV], during multi playback and playback zoom.
 - The histogram in the recording mode is an approximation.
 - The histogram in recording and playback may not match each other.
 - The histogram in this camera does not match the one displayed on image editing software used with a PC, etc.

Example of histogram

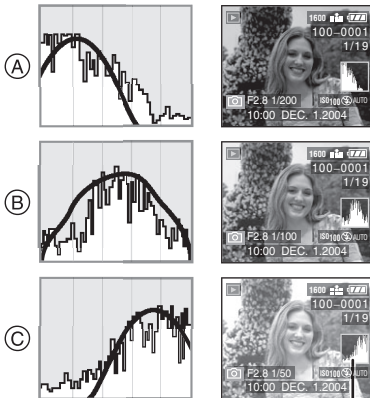

*

- (A) Under Exposed
- (B) Properly Exposed
- (C) Over Exposed
- *Histogram

Taking Pictures

■ The Mode Dial

This camera has a mode dial to suit for recording of many kinds of scenes.

Select the desired mode and enjoy the variety of recording.

Rotate the mode dial slowly and match icon with mode dial indicator ①.

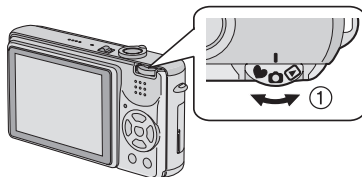

 : Normal picture mode (P28)

Use this mode for usual recording.

 : Simple mode (P32)

This is the recommended mode for beginners.

 : Macro mode (P50)

This mode allows you to take a picture extremely close to the subject.

 : Scene mode (P53)

This mode allows you to take pictures depending on the recording scenes.

 : Motion image mode (P51)

This mode allows you to record motion images.

 : Playback mode (P45)

This mode allows you to play back recorded pictures and motion images.

■ Taking pictures



The camera automatically sets the shutter speed and the aperture value according to the brightness of the subject.

- Insert the charged battery. (P14)
- Insert the card. (P15)

- 1 Turn the camera on.
- 2 Set the mode dial to Normal picture mode [📷].

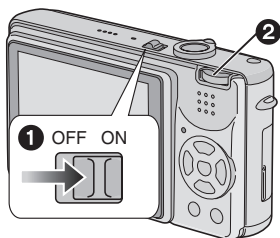

- 2 Aim the AF area ① to the point you want to focus and then press the shutter button halfway (A).

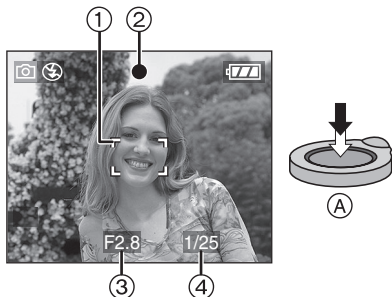

- The focus indication ② is lit and then the aperture value ③ and the shutter speed ④ are displayed.

3 Take a picture.

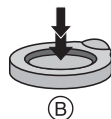
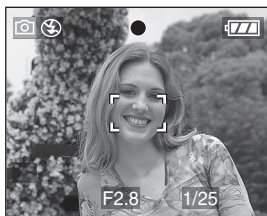

- (B): Press the shutter button fully to take the picture.

	When the subject is not focused	When the subject is focused
Focus indication	Blink (green)	On (green)
AF area	Turns from white to red	Turns from white to green
Sound	Beeps 4 times	Beeps 2 times

■ AF/AE Lock (AF: Auto Focus/ AE: Auto Exposure)



When recording a picture of people with a composition as the above picture, you cannot focus on the subject because it is out of AF area in usual operation.

In this case,

- 1 Aim the AF area at the subject.
- 2 Press the shutter button halfway to fix the focus and the exposure.
- 3 When the subject is focused, the focus indication lights.
- 4 Keeping the focus and the exposure fixed, move the camera as you compose the picture.
- 5 Press the shutter button fully.

- You can retry the AF/AE lock repeatedly before pressing the shutter button fully.

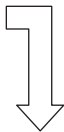

■ Correct posture for taking good pictures

To take pictures without blurring:

- Hold the camera gently with both hands, keep arms stationary at your side and stand with your feet slightly apart.
- Make sure that camera shake does not occur when pressing the shutter button halfway.
- After pressing the shutter button, keep the camera stationary until the picture appears on the screen.
- In the following cases, keep the camera stationary for a longer time.
 - Slow sync./Red-eye reduction [**⚡ S**] (P37)
 - When the shutter speed is slowed in the setting on the slow shutter speed (P65)
 - [NIGHT SCENERY] (P55), [NIGHT PORTRAIT] (P56), [FIREWORKS] (P56) and [PARTY] (P57) in scene mode (P53)

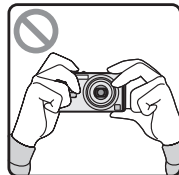
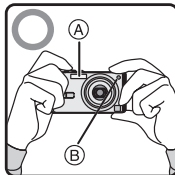

(A): Photo flash

(B): AF assist lamp

- Do not cover the photo flash or the AF assist lamp with your finger.
- Do not touch the lens part.

■ Focusing

- The focus range is 1.64 feet (50 cm) – ∞ (Wide), 1.64 feet (50 cm) – ∞ (Tele).
- If you press the shutter button fully without prefocusing, pictures may be blurry or unfocused.
- When the focus indication is blinking, the subject is not focused. Press the shutter button halfway and focus on the subject again.
- If the camera will not focus after a few tries, turn it off and on and try again.
- In the following cases, the camera cannot focus on subjects properly.
 - When including both near and distant subjects in a scene.
 - When there is dirt or dust on the glass between the lens and the subject.
 - When there are illuminated or glittering objects around the subject.
 - When taking a picture in a dark place.
 - When the subject is moving fast.
 - When the scene has low contrast.
 - When jitter occurs.
 - When recording a very bright subject.

We recommend taking pictures using AF/AE lock. In dark places, the AF assist lamp (P65) may turn on to focus on the subject.

Even if the focus indication appears and the subject is focused, it is canceled when you release the shutter button. Press the shutter button halfway again.

■ Jitter (camera shake)

- Be careful of jittering when pressing the shutter button.
- When jitter could occur, the jitter alert ① appears.

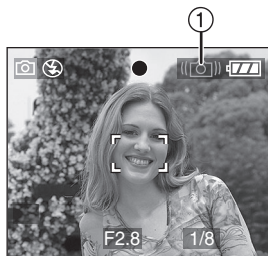

- When the jitter alert appears, we recommend using a tripod. If you cannot use a tripod, be careful of how you hold the camera. (P29)

■ Exposure

- If you press the shutter button halfway when the exposure is not adequate, the indication of the aperture value and the shutter speed turns red. (However, the aperture value and the shutter speed do not turn red when the flash is activated.)
- The brightness of the screen may differ from that of recorded pictures. In particular, when taking pictures in dark places with slow shutter speed, the subject looks dark on the screen, but the actual picture is bright.
- When most of the subjects in the screen are bright (e.g. blue sky on a clear day, snowy field, etc.), the recorded pictures may become dark. In this case, compensate the exposure value on the camera. (P41)



- When you press the shutter button, the screen may become bright for a moment. This function allows easy adjustment of focus and the recorded picture will not be affected.
- We recommend setting the clock again before taking pictures. (P18)
- When the time for power save is set (P21), the camera is automatically turned off if you do not operate it within the set time. When operating the camera again, press the shutter button or turn the camera off and on.
- In some cases, if the distance between the camera and the subject is beyond the recordable range when you use the camera, the picture may not be properly focused even if the focus indication is lit.

Taking Pictures in Simple Mode



This mode allows beginners to take pictures easily. Only the necessary menus appear to make the operations simple.

1 Select the desired item and set the desired value.

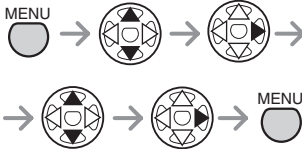
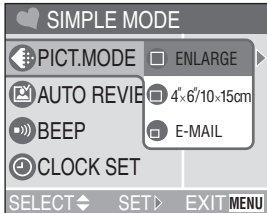

■ Settings in Simple mode

[PICT.MODE]

ENLARGE	This selection is intended for situations when large printing (8"×10", Letter etc.) is desired.
4"×6"/ 10×15cm	This selection offers an easy way to produce small "general purpose" prints.
E-MAIL	This selection favors a smaller file size, optimized for website and e-mail use.

[AUTO REVIEW]

ON	The recorded picture automatically appears on the screen for about 1 second.
OFF	The recorded picture does not automatically appear.

[BEEP]

OFF	No operational sound
LOW	Soft operational sound
HIGH	Loud operational sound

[CLOCK SET]

Change date and time. (P18)

■ Other Settings in Simple mode

In Simple mode, other settings are fixed as follows. For details, refer to the pages corresponding to each item.

Focus range	0.98 feet (30 cm) – ∞ (Tele) 0.16 feet (5 cm) – ∞ (Wide)	P30
MONITOR	[0] (standard)	P21
POWER SAVE	[2MIN.]	P21
ECONOMY	[OFF]	P22
Self-timer	10 seconds	P40
Optical Image Stabilizer	[MODE2]	P43
Burst speed	Low speed Number of recordable pictures in Burst mode • [ENLARGE]: max. 4 pictures • [4"×6"/10×15cm]: max. 7 pictures • [E-MAIL]: max. 7 pictures	P44
White balance	[AUTO]	P60
ISO sensitivity	[AUTO]	P62
Picture size and Quality	• [ENLARGE]: 2560×1920 pixels/Fine • [4"×6"/10×15cm]: 1600×1200 pixels/Standard • [E-MAIL]: 640×480 pixels/Standard	P62 P63
AF mode	[<input type="checkbox"/>] (1-area-focusing)	P64
AF assist lamp	[ON]	P65

■ The Backlight Compensation

Backlight is a situation where light comes from behind the subject. Subjects such as people become dark when pictures are recorded in the backlight. If you press **▲**, [**Ⓛ**] (compensating backlight ON indication) appears and the backlight compensation function is activated. This function compensates the backlight by brightening the whole of the picture.



- If you press **▲** while [**Ⓛ**] is displayed, [**Ⓛ**] disappears and the backlight compensation function is canceled.
- When you use the backlight compensation function, we recommend using the flash. (When you use the flash, the flash mode is set to Forced ON/Red-eye reduction.)



- You cannot set the following items in the Simple mode.
 - [NO.RESET]
 - [RESET]
 - [USB MODE]
 - [VIDEO OUT]
 - [LANGUAGE]
 - [ECONOMY]
- However, the setting for [NO.RESET] and [LANGUAGE] in the setup menu (P20) are applied to the Simple mode.
- Except for [CLOCK SET] and [BEEP], the settings on the simple mode are not applied to other recording modes.
- You cannot use the following functions in the simple mode.
 - White balance fine adjustment
 - Exposure compensation
 - Auto bracket
 - [PICT.SIZE]
 - [QUALITY]
 - [AUDIO REC.]
 - [D.ZOOM]
 - [SLOW SHUTTER]
 - [COL.EFFECT]
 - [PICT.ADJ.]
 - [FLIP ANIM.]
- However, the setting on [PICT.SIZE] and [QUALITY] corresponds to the setting on [PICT.MODE].

Checking the Recorded Picture (Review)



1 When the mode dial is in a recording mode, press \blacktriangledown .



- The last recorded picture appears for about 10 seconds.
- Press the shutter button halfway or \blacktriangledown to cancel the review.
- You can check the previous or following picture with $\blacktriangleleft/\blacktriangleright$.
- When the recorded pictures are too bright or dim, compensate the exposure. (P41)

2 Enlarge and shift the picture.

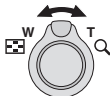

- Q : 1x \rightarrow 4x \rightarrow 8x
- W : 8x \rightarrow 4x \rightarrow 1x

- When you change the magnification or the position to be displayed, the zoom position indication A appears for about 1 second to identify the enlarged area.

Recorded pictures can be deleted during the review (Quick Deletion)

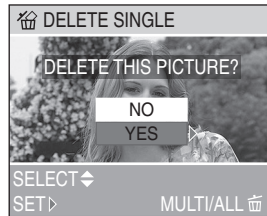

- Once deleted, pictures cannot be recovered.
- Multi pictures or all pictures can be deleted. Read P48 or P49 to operate them.

Using the Optical Zoom



You can make people and subjects appear closer with the 3 times optical zoom, and landscapes can be recorded in wide angle.

1X



2X



3X



■ To make subjects appear further away use (Wide)

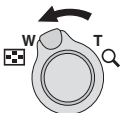

■ To make subjects appear closer use (Tele)

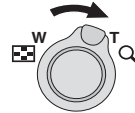
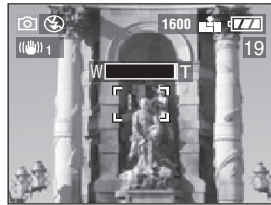

- The picture may have some distortion (typical example: vertical straight line bent outwards). This is due to the lens aberration, which is common to some extent with all photographic lenses. Distortion may be more visible when using a wider area of the zoom lens as you get closer to the subject.
- When using the zoom lens at high magnification, the quality of the picture can be enhanced if a tripod is used. At high magnification, even small movements can cause a slight decrease in picture sharpness.

Taking Pictures using the Built-in Flash



When you set the flash, you can take pictures using the built-in flash according to the recording condition.

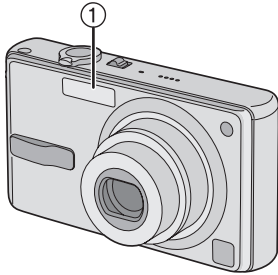
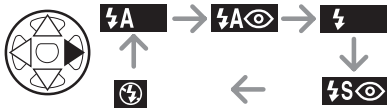

Photo flash ①

Do not cover it with your finger or any other items.

■ Switching to the appropriate flash setting

Set the flash setting of the built-in flash according to the scene to be recorded.



For the selectable flash settings, refer to “Available flash settings by recording mode” on P38.

⚡A : AUTO

The flash is automatically activated according to the recording condition.

⚡A👁️ : AUTO/Red-eye reduction

The flash is automatically activated according to the recording condition. It reduces the red-eye phenomenon (eyes of the subject appear red in photo flash) by triggering the flash at 1 second before actually recording the picture.

• **Use this when you take pictures of people in low lighting conditions.**

⚡ : Forced ON

The flash is activated every time regardless of the recording condition.

• **Use this when your subject is back-lit or under fluorescent light.**

⚡👁️ : Forced ON/Red-eye reduction

• In [PARTY] in scene mode (P53) or when you compensate the backlight in simple mode [♥], the flash mode is set to Forced ON/Red-eye reduction.

⚡S👁️ : Slow sync./Red-eye reduction

When you take a picture with a dark background landscape, this feature makes the shutter speed slow when the flash is activated, so that the dark background landscape will become bright. Simultaneously it reduces the red-eye phenomenon.

• **Use this when taking pictures of people in front of a dark background.**

🚫👁️ : Forced OFF

The flash is not activated in any recording condition.

• **Use this when taking pictures in places where the use of the flash is not permitted.**

■ Available flash settings by recording mode

The available flash settings depend on the recording mode.

(○: Available, —: Not available)

	○	○	—	○	○	—	—	—	—	—	○	○	—
	○	○	—	○	○	—	—	—	—	—	—	○	○
	○	○	—	○	○	—	—	—	—	—	○	○	○
	—	—	—	—	—	—	—	—	—	○	—	—	○*
	○	○	—	—	—	—	○	—	○	—	—	—	—
	○	○	○	○	○	○	○	○	○	○	○	○	○

*Available only in backlight compensation

■ The available flash range to take pictures

ISO sensitivity	Available flash control range
AUTO*	0.98 feet (30 cm) – 13.1 feet (4.0 m) (Wide) 0.98 feet (30 cm) – 7.22 feet (2.2 m) (Tele)
ISO80	0.98 feet (30 cm) – 5.91 feet (1.8 m) (Wide) 0.98 feet (30 cm) – 3.28 feet (1.0 m) (Tele)
ISO100	0.98 feet (30 cm) – 6.56 feet (2.0 m) (Wide) 0.98 feet (30 cm) – 3.61 feet (1.1 m) (Tele)
ISO200	1.31 feet (40 cm) – 9.19 feet (2.8 m) (Wide) 0.98 feet (30 cm) – 5.25 feet (1.6 m) (Tele)
ISO400	1.97 feet (60 cm) – 13.1 feet (4.0 m) (Wide) 1.31 feet (40 cm) – 7.22 feet (2.2 m) (Tele)







*Except when the flash mode is set to Slow sync./Red-eye reduction []

- The available flash range is an approximation.
- Refer to P30 for the focus range.



- If the ISO sensitivity is set to [AUTO] (P62), it is automatically adjusted from [ISO100] to [ISO400] when you use the flash (except when the flash mode is set to Slow sync./Red-eye reduction []). To avoid noise, decrease the ISO sensitivity.

■ Shutter speed for each flash mode

Flash mode	Shutter speed (sec.)
 : AUTO	1/60 – 1/2000
 : AUTO/Red-eye reduction	1/60 – 1/2000
 : Forced ON	1/60 – 1/2000
 : Forced ON/Red-eye reduction	
 : Slow sync./ Red-eye reduction	1/8 * – 1/2000
 : Forced OFF	1/8 * – 1/2000
	8 – 1/2000 [In [NIGHT SCENERY] in scene mode (P53)]

* The shutter speed changes depending on the slow shutter setting. (P65)

■ When using the photo flash

- **Do not stare at the photo flash from close proximity.**
- **If you bring the flash too close to the subjects, they may appear distorted or discolored by its heat and lighting.**
- **Do not cover the photo flash with your fingers or any other items.**
- When you take a picture beyond the flash control range, the exposure may not be adjusted properly and the picture may become bright or dark.
- When you repeat taking a picture, recording may be disabled even if the flash is activated. Take a picture after the card access lamp disappears.
- When the jitter alert appears, we recommend using the flash.
- When you set to burst mode or auto bracket, only 1 picture is recorded for every flash activated.
- The flash icon turns red when activating the flash and pressing the shutter button halfway.
- When the flash is being charged, the flash icon blinks red, and you cannot take a picture even when you press the shutter button fully.
- While the flash is being charged in economy mode, the LCD monitor is off.

- When taking a picture with the flash, the white balance will be automatically adjusted [except for  (Daylight)], but the white balance may not be properly adjusted if the photo flash is insufficient.
- When the shutter speed is fast, the flash effect may not be sufficient.
- To avoid picture noise, we recommend setting [PICT.ADJ.] to [NATURAL]. (P66)
- Refer to P62 for the ISO sensitivity.

Taking Pictures with the Self-timer



1 Switch the self-timer setting.



 : Self-timer set to 10 seconds

 : Self-timer set to 2 seconds

No display (canceled)

2 Focus on the subject to take the picture.



- If you press the [MENU] button when the self-timer is set, the self-timer setting is canceled.



- When using a tripod or in other cases, setting the self-timer to 2 seconds is a convenient way to stabilize the jitter caused by pressing the shutter button.
- The self-timer indicator ① blinks and the shutter is activated after 10 seconds (or 2 seconds).
- When you press the button fully with one stroke, the subject is automatically focused just before the recording. In dark places, the self-timer indicator blinks and then it may turn on brightly to work as the AF assist lamp (P65) for focusing on the subject.
- In simple mode [♥], the self-timer is fixed to 10 seconds. (P32)
- When you set the self-timer in the burst mode, the camera starts taking a picture 2 or 10 seconds after the shutter button is pressed. The number of pictures taken at a time is fixed to 3.
- We recommend using a tripod when setting the self-timer.

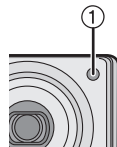

Compensating the Exposure



Use this function when you cannot achieve appropriate exposure due to the difference of brightness between the subject and the background.

Under exposed

Compensate the exposure toward positive.

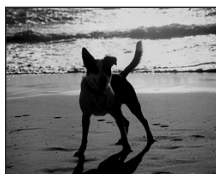

Properly Exposed



Over exposed

Compensate the exposure toward negative.



-2



0



+2

1 Press **▲** several times until **[EXPOSURE]** appears and then compensate the exposure.



- You can compensate from -2 EV to $+2$ EV in steps of $1/3$ EV.



- EV is an abbreviation of Exposure Value, and it is the amount of light given to the CCD by the aperture value and the shutter speed.
- The compensation range of the exposure will be limited depending on the brightness of the subject.
- The exposure compensation value appears on the lower left of the screen.
- The exposure value is memorized even if the camera is turned off.

Taking Pictures using Auto Bracket



In this mode, 3 pictures are automatically recorded by each press of the shutter button according to the compensation range of the exposure.

You can select the desired exposure among the 3 types of pictures.

1 Press ▲ several times until [ AUTO BRACKET] appears and then set the compensation range of the exposure.

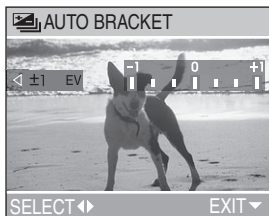

- You can select the exposure from -1 EV to +1 EV in steps of 1/3 EV.
- When you do not use auto bracket, select [OFF].



- When setting the auto bracket, the auto bracket icon appears on the lower left of the screen.
- When taking pictures using auto bracket after the exposure compensation, the pictures are based on the compensated exposure.
 - When the exposure is compensated, the compensated exposure value appears on the screen.
- When the flash is activated, you can take only 1 picture.
- When setting auto bracket, you cannot use the audio recording function.
- When setting auto bracket and the burst mode simultaneously, auto bracket will be performed.
- The exposure may not be compensated with auto bracket depending on the brightness of the subject.
- The setting of auto review function is fixed to [1SEC.]. (The picture is not enlarged.)

Optical Image Stabilizer [STABILIZER]





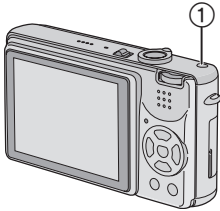

This mode recognizes and compensates jitters. You can reduce blurring caused by jitters when you hold the camera with one hand for taking a picture of yourself or when you take pictures indoors where the shutter speed is slowed down.



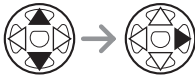
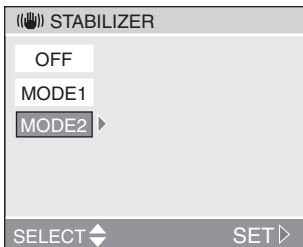

① Optical Image Stabilizer button

1 Keep pressing the stabilizer button until [STABILIZER] appears and then select the stabilizer function mode.



MODE1 ()	The stabilizer operates continuously and can assist during photocomposition.
MODE2 ()	The stabilizer function is in standby and activates at the moment the shutter captures the image. This mode offers a greater degree of stabilization. Usually, we recommend setting to [MODE2].
OFF ()	When image stabilization is not desired.



- The stabilizer function may not work sufficiently in the following cases.
 - When too much jitter occurs.
 - In digital zoom range.
 - When taking pictures while following subjects in motion.
 - When the shutter speed is extremely slow due to dark conditions or other reasons.
- For jitters, refer to P30.
- In simple mode [] or [SELF PORTRAIT] in scene mode (P53), the stabilizer function mode is fixed to [MODE2].
- In Motion image mode [, [MODE2] cannot be set, and the stabilizer function menu does not appear.

Taking Pictures using Burst Mode



1 Press the Single/Burst Mode Button to switch the burst mode setting and then take pictures.

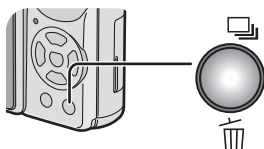

 : High speed



 : Low speed







 : No limit



No display (canceled)

■ Number of pictures recorded in burst mode

	Burst speed (pictures/second)*	Number of recordable pictures (pictures)	
			
	3	max. 4	max. 7
	2		
	2	Depends on the card capacity	Depends on the card capacity

*When the shutter speed is higher than 1/60 and the flash is not activated

- In simple mode [], the burst speed is fixed to Low. (P32)



- Keep pressing the shutter button fully to activate the burst mode.
- If the flash is activated, you can record only 1 picture.
- When the self-timer is used, the number of recordable pictures in burst mode is fixed to 3.
- When the burst mode is activated, the audio recording function cannot be used.
- When setting auto bracket and the burst mode simultaneously, auto bracket will be performed by default.
- When the burst mode setting is set to no limit, the speed of taking pictures becomes slow during a recording in burst mode.
- Burst mode will not perform as described if a MultiMediaCard is used in place of an SD Memory Card. The reading/writing speed of a MultiMediaCard is slower than that of an SD Memory Card.
- The setting of auto review function is fixed to [1SEC.]. (The picture is not enlarged.)

Playing Back Pictures



1 Select the picture.



- ◀: Play back the previous picture.
- ▶: Play back the next picture.
- The picture following the last one is the first picture.

■ Fast forwarding/Fast rewinding

When you keep pressing ◀/▶ during playback, the file number and the page number are updated. If you release ◀/▶ when the number of the desired picture appears, you can play back the picture.

▶: Fast forward

◀: Fast rewind

- The number of files forwarded/rewound at a time depends on how long you hold down ◀/▶. It also varies depending on the number of the recorded pictures.
- If you release ◀/▶ and press them again, the files will be forwarded/rewound one by one.
- In review playback in the recording mode or multi playback, the picture can only be forwarded or rewound one by one.

- When you forward or rewind a large number of pictures, release ◀/▶ once before reaching the picture to be played back, then press ◀/▶ to forward/rewind pictures little by little.



- This camera is based on the DCF standards (Design rule for Camera File system) which was established by the Japan Electronics and Information Technology Industries Association (JEITA).
- When changing the folder name or file name on a PC, the pictures will not be played back.
- The file format that can be played back with this camera is JPEG. (There are also pictures that on some occasions cannot be played back in JPEG format.)
- When playing back pictures that have been recorded with other equipment, the picture quality may be deteriorated and pictures may not be played back.
- When playing back a file out of standard, the folder/file number is indicated by [—] and the screen may turn black.
- An interference fringe may appear on the screen depending on the subject. This is called moire. This is not a malfunction.

9 Pictures Multi Playback



1 Switch to multi screen.

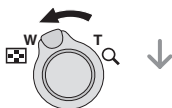

2 Select the pictures.



■ To return to the normal playback

Rotate the zoom lever towards [Q] or press the [MENU] button.

- The picture with the number colored in orange appears.

■ To delete a picture during a 9 pictures multi playback.

Press the [] button.

When the confirmation screen appears, press ▼ to select [YES], and press ►. (P48)



- Rotated pictures are displayed in the direction oriented when they are recorded. (P71)

Using the Playback Zoom



1 Enlarge the picture.

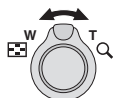

- **Q** : 1× → 2× → 4× → 8× → 16×
- **Q** : 16× → 8× → 4× → 2× → 1×
- When you rotate the zoom lever towards W after the picture is enlarged, the magnification becomes lower.
- When you change the magnification, the zoom position indication **A** appears for about 1 second to check the position of the section enlarged.
- When you press the [MENU] button, the magnification reverts to 1×.

2 Shift the picture.



- When you move the position to be displayed, the zoom position indication is displayed for about 1 second.

■ To delete a picture during the playback zoom

Press the **[MENU]** button.

When the confirmation screen appears, press **▼** to select [YES], and press **▶**. (P48)



- The more the picture is enlarged, the more its quality deteriorates.
- The playback zoom may not operate if pictures have been recorded with other equipment.
- Even if the indication on the LCD monitor are turned off in normal playback mode (P24), the magnification and enabled operations appear on the LCD monitor when the playback zoom is activated. You can switch whether you turn the indications on the LCD monitor on or off by pressing the [DISPLAY] button. When you set the magnification to 1×, the indication on the LCD monitor are displayed as in normal playback mode.
- Rotated pictures are displayed in the direction oriented when they are recorded. (P71)

Deleting Pictures



■ To delete a single picture

1 Select the picture to be deleted.



- ◀: Play back the previous picture.
- ▶: Play back the next picture.

2 Delete the picture.

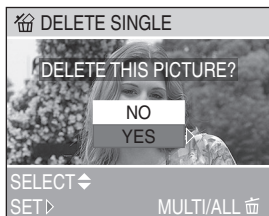

- While deleting the picture, [] appears on the screen.

■ To delete multiple pictures

1 Select [MULTI DELETE].

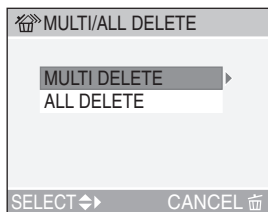

2 times

2 Select the pictures to be deleted.



- The selected pictures appear with []. When ▼ is pressed again, the setting is canceled.
- The icon [] blinks red if the selected picture cannot be deleted. Cancel the protect setting. (P74)



3 Delete the pictures.

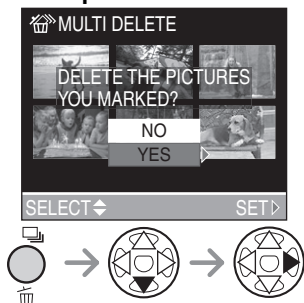

- It is possible to delete up to 50 pictures all at once.

- Once deleted, pictures cannot be recovered. Please double-check before deleting pictures.
- Do not turn off the camera while deleting.
- Pictures that are protected (P74) or that do not conform to DCF standards (P45) will not be deleted.
- When you delete pictures, use a battery with sufficient battery power (P13) or use with the AC adaptor (DMW-CAC2; optional).

■ To delete all pictures

1 Select [ALL DELETE].

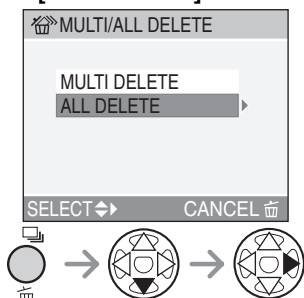

2 times

2 Delete all of the pictures.

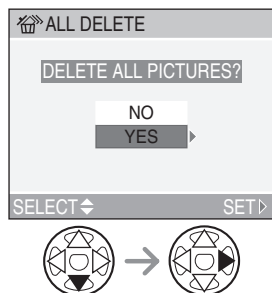

Using the Mode Dial

Macro mode



This mode allows you to take pictures closely focusing on the subject. (e.g. When taking pictures of flowers.)

You can take pictures with the lens at a distance of up to 0.16 feet (5 cm) (Wide) from the subject.



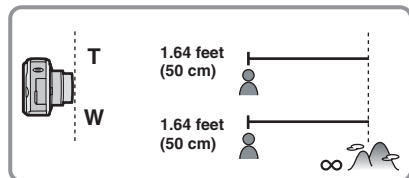

■ Focus range

• Normal

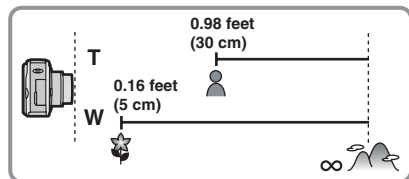

• Macro mode []



- We recommend using a tripod.
- When the camera lens is at a distance beyond the available range from the subject, the subject may not be focused even if the focus indication lights.
- The available flash range is about 0.98 feet (30 cm) – 13.1 feet (4.0 m). (This is applied when you set the ISO sensitivity to [AUTO] (Wide). However, the flash mode should be set to a mode except Slow sync./Red-eye Reduction [].)

Motion image mode



This mode allows you to record motion images.

1 Select [MOTION RATE].

[CAMERA] REC	
[WB] W.BALANCE	AUTO
fps MOTION RATE	10fps
[AF] AF MODE	30fps
AF* AF ASSIST LAMP	ON
[D.ZOOM]	OFF
SELECT ◀	SET ▶
EXIT	MENU

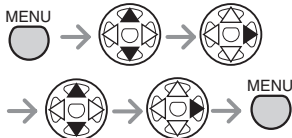

• [10fps]:

Recording motion images for a longer time is available though less smooth. The file size is smaller, so the files are suitable to be attached to e-mails.

• [30fps]:

The motion of the recorded image is smooth, but the file size is large.

- fps (frame per second); This refers to the number of frames used in 1 second.
- Close the menu by pressing the shutter button halfway or the [MENU] button after finishing the setting.

2 Press the shutter button halfway.

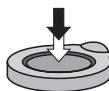
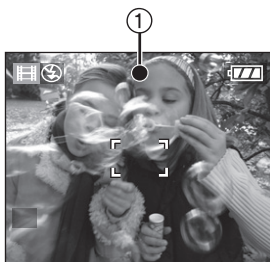

- When the subject is focused, the focus indication ① lights.
- The remaining recording time (approximation) appears on the screen.

3 Press the shutter button fully to start the recording.

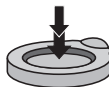

- The audio recording starts simultaneously from the built-in microphone of the camera.
- By pressing the shutter button fully again, the recording stops.
- If the memory card becomes full during recording, the camera stops automatically.

■ Available recording time (seconds)

SD Memory Card Capacity	Motion rate (sec.)	
	10fps	30fps
16 MB	75	25
32 MB	160	55
64 MB	350	120
128 MB	720	240
256 MB	1450	480
512 MB	2950	1020
1 GB	5700	1950

- The remaining recording time (approximation) appears on the screen.
- The recordable time is an approximation.



• You cannot play audio only with the camera. When you want to play audio, connect the camera to TV (P82) or PC (P85).

- The motion images cannot be recorded without audio.
- The picture size is fixed to 320×240 pixels.
- If using a MultiMediaCard, after recording motion images, the card access indication may appear for a while, but this is not a malfunction. The file is being loaded to the MultiMediaCard.
- The settings of auto focus/zoom/aperture values are fixed to what they are when recording starts (in the first frame).
- If you use a card with little capacity, recording may stop while you record motion images depending on the card type.
- When motion images recorded with this camera are played back on other equipment, the quality of pictures and sounds may be deteriorated or it may not be possible to play them back.
- The motion images recorded with setting [MOTION RATE] to [30fps] cannot be played back on a camera which does not support [30fps] of motion rate.
- The review function cannot be used.

- You cannot set [MODE2] on the Optical Image Stabilizer function.
- Keep the camera away from magnetised equipment or equipment which generates electromagnetic waves (e.g. a microwave oven, TV, cell phone or video game equipment, etc.) as far as possible. If not, pictures and sounds may be distorted due to electromagnetic wave radiation.

SCN Scene mode

Press the [MENU] button to display the scene menu. When [SCENE MENU] (P23) on the [SETUP] menu is set to [AUTO], set the mode dial to [SCN] to display the scene menu automatically.

Menu items

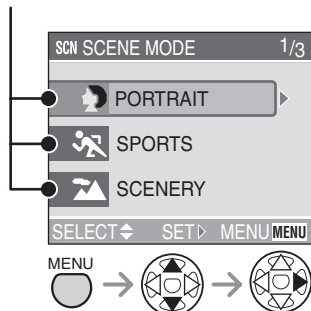

- Select a menu item with ▲/▼ and press ► to determine the setting.
- When rotating the zoom lever toward T, the page of the menu screen can be forwarded. (vice versa)
- If you press the [MENU] button while the scene menu is displayed, you can set the [SETUP] menu (P20) and the [REC] mode menu (P59).

: [PORTRAIT] (P54)

: [SPORTS] (P54)

: [SCENERY] (P55)

: [NIGHT SCENERY] (P55)

: [NIGHT PORTRAIT] (P56)

: [FIREWORKS] (P56)

: [PARTY] (P57)

: [SNOW] (P57)

: [SELF PORTRAIT] (P58)



- The following functions cannot be set in scene mode.
 - White balance (P60)
 - ISO sensitivity (P62)
 - Color effect (P66)
 - Picture adjustment (P66)

Portrait mode

This mode allows you to make the subject stand out from a background and adjust the exposure and the hue to achieve a healthy complexion on the subject.

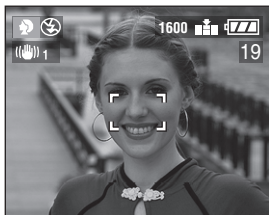

■ Technique for Portrait mode

To make this mode more effective:

- 1 Rotate the zoom lever to Tele as far as possible.
- 2 Be close to the subject.
- 3 Select a background which is far from the camera.



- This mode is suitable for outdoors in the daytime.
- White balance works best when recording outdoors in the daytime. When using indoors, the hue may change.
- When you want to change the exposure or the hue, compensate the exposure (P41).

Sports mode

This mode allows you to take pictures of a fast moving subject. (e.g. When taking pictures of outdoor sports.)



■ Technique for Sports mode

To record actions of the subject as if it were still, the shutter speed becomes faster than usual. This mode is more effective when taking pictures in the daytime on a clear day.



- This mode is suitable for outdoors in the daytime, keeping 16.4 feet (5 m) or more away from the subject.
- White balance works best when recording outdoors in the daytime. When using indoors, the hue may change.

Scenery mode

This mode allows you to take a picture of a wide landscape. This mode is suitable when the distance between the camera and the subject is 16.4 feet (5 m) or more in the open air. You can take pictures of a far landscape even through a windowpane.

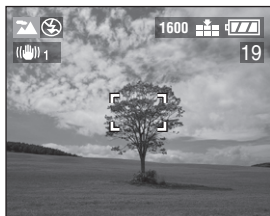

- The focus range is 16.4 feet (5 m) – ∞.
- The Flash setting is fixed to Forced OFF [].
- The setting on the AF assist lamp is disabled.

Night scenery mode

This mode allows you to take a picture of a nightscape. The landscape can be recorded vividly by using the slow shutter speed.

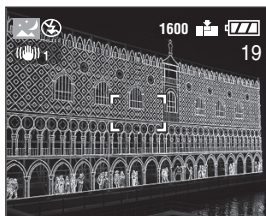

■ Technique for Night scenery mode

- Since the shutter speed becomes slow (max. about 8 sec.), use a tripod.



- The focus range is 16.4 feet (5 m) – ∞.
- The shutter may be kept closed (max. about 8 sec.) after taking a picture with slow shutter speed, but it is not a malfunction.
- When you take pictures in dark places, noise may become visible.
- The Flash setting is fixed to Forced OFF [].
- The setting on the AF assist lamp is disabled.

Night portrait mode



This mode allows you to take pictures against a night landscape. The subject can be recorded with brightness in real life by using the flash and the slow shutter speed.



■ Technique for Night portrait mode

- When you take pictures holding the camera in your hands, hold it firmly and use the stabilizer function (P43). The shutter speed becomes slow in this mode. We recommend using a tripod.
- Keep the subject still for about 1 second after taking a picture.
- Take a picture within the available flash range [max. 6.56 feet (2.0 m)] of the subject.
- We recommend rotating the zoom lever to Wide.





- The focus range is 3.94 feet (1.2 m)–9.84 feet (3 m).
- The shutter may be kept closed (max. about 1 sec.) after taking a picture with slow shutter speed, but this is not a malfunction.
- When you take pictures in dark places, noises may become visible.
- Flash setting is fixed to Slow sync./ Red-eye reduction [  ].

Fireworks mode

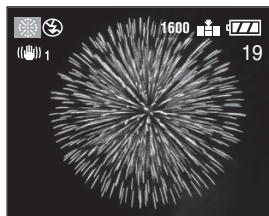
This mode allows you to take beautiful pictures of fireworks exploding in the night sky. The shutter speed or the exposure is automatically adjusted for taking pictures of fireworks.



■ Technique for Fireworks mode

- We recommend using a tripod.
- 
- The available recording range is 32.8 feet (10 m)–∞.
 - The setting on the AF assist lamp is disabled.
 - The Flash setting is fixed to Forced OFF [].

Party mode

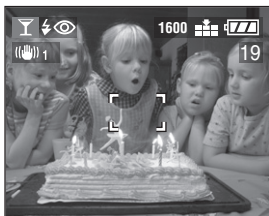

This mode allows you to take a picture in a dim room (e.g. a wedding reception, a party, a banquet in a bar, etc.) clearly. The shutter speed or the exposure is automatically adjusted according to the brightness of the room.



■ Technique for Party mode

- The shutter speed is slowed down. Hold the camera firmly to take a picture.



- The flash mode of the built-in flash can be set to Forced ON/Red-eye reduction [] or Slow sync./Red-eye reduction [].

Snow mode

This mode allows you to take a picture in locations such as skiing grounds and locations near snowy mountains. The exposure and the white balance are adjusted to make the white color of the snow stand out.



**Self portrait mode**

This mode allows you to take a picture of yourself.



- The self-timer can be set to [OFF] or [2SEC.]. (P40) When you set to [2SEC.], it is kept until the camera is turned [OFF] or you switch the mode.
- The stabilizer function is fixed to [MODE2]. (P43)
- The setting on the AF assist lamp is disabled.
- The AF mode is fixed to 9-area-focusing.

Technique for Self-portrait mode

- When you are focused by pressing the shutter button halfway, the self-timer indicator ① lights up. Fix the camera firmly and then press the shutter button fully.

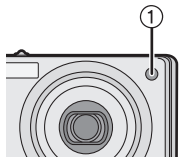

- The captured picture automatically appears on the LCD monitor for reviewing. Refer to P21 for operations on the review function.
- When the picture may be blurred by slow shutter speed, we recommend using the 2 seconds self-timer. (P40)



- The available focus range is 0.98 feet (30 cm) – 2.3 feet (70 cm). When the camera lens is at a distance over the range, the subject may not be focused even if the focus indication appears.
- You can take a picture of yourself with audio. In this time, the self-timer indicator lights up while recording the audio. (P63)
- When you select self-portrait mode [], the zoom lever is automatically moved to Wide.

Using the [REC] mode menu



Setting the hue, picture quality adjustment, etc. allows you to create wide variations on taking pictures.

- Set the mode dial to the desired recording mode.

Menu items

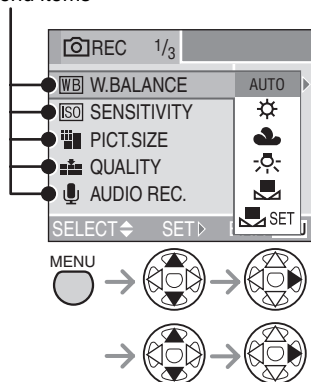

- When rotating the zoom lever toward T, the page of the menu screen can be forwarded. (vice versa)
- Close the menu by pressing the shutter button halfway or the [MENU] button after finishing the setting.

WB : [W.BALANCE] (P60)

ISO : [SENSITIVITY] (P62)

PICT.SIZE : [PICT.SIZE] (P62)

QUALITY : [QUALITY] (P63)

AUDIO REC. : [AUDIO REC.] (P63)

AF : [AF MODE] (P64)

AF* : [AF ASSIST LAMP] (P65)

SLOW : [SLOW SHUTTER] (P65)

D.ZOOM : [D.ZOOM] (P66)

COL.EFFECT : [COL.EFFECT] (P66)

PICT.ADJ. : [PICT.ADJ.] (P66)

FLIP ANIM. : [FLIP ANIM.] (P67)

WB White Balance [W.BALANCE]

This function allows you to reproduce a white color closer to the tone in real life on the pictures recorded under sunlight, halogen lighting, etc. in which the white color may appear reddish or bluish.

AUTO	for auto setting (auto white balance)
(Daylight)	for recording outdoors on a bright day
(Cloudy)	for recording under a cloudy or shaded area sky
(Halogen)	for recording under halogen lighting
(White set)	for using the preset white balance
(White set)	for setting the white balance again (P61)

- When setting the white balance to the mode except [AUTO], you can finely adjust the white balance.

Auto White Balance

Use of auto white balance adjustment in inappropriate lighting conditions may result in reddish or bluish pictures. Where the subject is surrounded by many light sources, auto white balance adjustment may not operate properly.

In this case, set the white balance to a mode except [AUTO] manually.

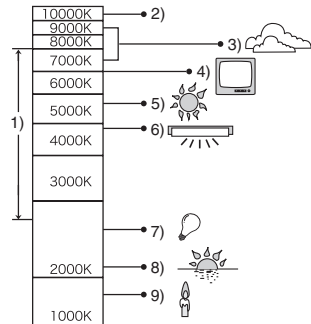

- 1 The range that is controlled by the auto white balance adjustment mode of this camera
- 2 Blue sky
- 3 Cloudy sky (Rain)
- 4 TV screen
- 5 Sunlight
- 6 White fluorescent light
- 7 Incandescent light bulb
- 8 Sunrise and sunset
- 9 Candlelight



K=Kelvin Color Temperature

■ Setting the White Balance manually (White set SET)



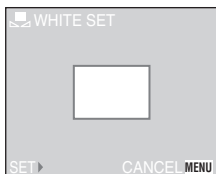

Use this mode when you want to set the white balance manually.

- 1 Set to [ SET] (White set) and then press .
- 2 Aim the camera at a sheet of white paper or a similar white object so that the frame on the center of the screen turns white and then press .





■ Finely Adjusting the White Balance (White Balance Fine Adjustment WB±)

When you cannot acquire the desired hue by setting the white balance, you can adjust the white balance finely.

- 1 Set the white balance to [] / [] / [] / []. (P60)
- 2 Press  several times until [WB ADJUST.] appears.





- 3 Finely adjust the white balance.

-  [BLUE]: Press when the hue is reddish.
-  [RED]: Press when the hue is bluish.



About the white balance

- In simple mode [, the white balance is fixed to [AUTO].
- When taking a picture with the flash, the white balance will be automatically adjusted [except for [] (Daylight)], but the white balance may not be properly adjusted when the photo flash is insufficient.

About the white balance fine adjustment

- The white balance icon on the screen turns red or blue.
- You can set the value independently for each of the modes in white balance.
- The setting on the fine adjustment of the white balance is reflected to the picture when taking a picture with the flash.
- When you set the white balance using the White set [ SET], the adjustment level is set to "0".
- When the color effect is set to any of [COOL], [WARM], [B/W] or [SEPIA] (P66), you cannot finely adjust the white balance.

 **ISO Sensitivity [SENSITIVITY]**

ISO sensitivity represents the sensitivity to light in values. If you set the ISO sensitivity higher, the camera becomes more suitable for recording in dark places.



- When setting to [AUTO], the ISO sensitivity is automatically adjusted in the range described below according to the brightness.

[ISO 80] – [ISO 200]

(It can be adjusted from [ISO100] to [ISO400] when using the flash. However, it is fixed to [ISO100] when the flash mode is set to Slow sync./Red-eye reduction [].)

ISO sensitivity	80 ←————→ 400	
Use in bright places (e.g. outdoors)	Suitable	Not suitable
Use in dark places	Not suitable	Suitable
Shutter speed	Slow	Fast
Noise	Less	Increased



- In simple mode [, motion image mode [] or scene mode (P53), ISO sensitivity is fixed to [AUTO].
- To avoid picture noise, we recommend decreasing the ISO sensitivity or setting [PICT.ADJ.] to [NATURAL]. (P66)

 **Picture Size [PICT.SIZE]**

If you select a larger picture size, you can print pictures clearly.

When you select a smaller picture size (640×480 pixels), you can store more pictures on a card though the picture quality is deteriorated. In addition, it is easy to attach the picture to an e-mail or post it on a website because the file size is small.

2560	2560×1920 pixels
2048	2048×1536 pixels
1600	1600×1200 pixels
1280	1280×960 pixels
640	640×480 pixels
HDTV	1920×1080 pixels



- For how to playback pictures recorded using [HDTV] mode on a High-Definition TV (HDTV has a 16:9 aspect), refer to P82.
- Both ends of the pictures recorded using [HDTV] mode may be cut off in printing. Check the picture before printing. (P96)



- In motion image mode [, the picture size is fixed to 320×240 pixels.
- Pictures may appear like a mosaic depending on the subject or the recording condition.
- The number of recordable pictures depends on the subject.
- The number of remaining pictures may not correspond with recorded frames.
- Refer to P17 for the number of recordable pictures.

 **Quality [QUALITY]**

You can select 2 types of quality (compression rate) according to the usage of the picture.

	Fine (Low compression): This type gives priority to picture quality. Picture quality will be high.
	Standard (High compression): This type gives priority to the number of recordable pictures and records standard quality pictures.





- Pictures may have a mosaic-like appearance depending on the subject or the recording condition.
- The number of recordable pictures depends on the subject.
- The number of remaining pictures may not correspond with recorded frames.
- Refer to P17 for the number of recordable pictures.

 **Audio Recording [AUDIO REC.]**

You can take a picture with audio.

- When you set [AUDIO REC.] to [ON],  appears on the screen.
- When you start recording by focusing on the subject and pressing the shutter button, the audio recording will be automatically stopped in 5 seconds. There is no need to keep pressing the shutter button.
- Audio is recorded from the built-in microphone of the camera.
- If you press the [MENU] button during the audio recording, the audio recording will be canceled. The audio cannot be recorded.
- You cannot record pictures with audio in auto bracket or burst mode.
- When audio is recorded with each picture, the total number of pictures that can be stored on each card will slightly decrease.

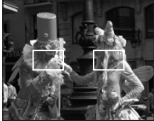
AF AF Mode [AF MODE]

	<p>9-area-focusing: The camera focuses on any of 9 focus areas. You can record a picture in free composition without limiting the position of the subject.</p> 
	<p>3-area-focusing: The camera focuses on any of the left, center and right of the screen.</p> 
	<p>1-area-focusing: The camera focuses on the subject in AF area on the center of the screen.</p> 
	<p>Spot-focusing: The camera focuses on the limited and narrow area in the screen.</p> 



- When setting to 3-area-focusing, pictures may become still while being focused on, however, this is not a malfunction.
- In the digital zoom or when you take pictures in dark places, the AF area is displayed on the center of the screen with a size wider than usual.



- When multiple AF areas (max. 9 areas) light at the same time, the camera is focusing on all the AF areas. The focus position is not predetermined because it is set to the position the camera automatically determines at the time of focusing. If you want to determine the focus position to take pictures, switch the AF mode to 1-area-focusing mode or spot-area-focusing mode.

AF* **AF Assist Lamp**
[AF ASSIST LAMP]

Illuminating the subject with the AF assist lamp allows the camera to focus on the subject in low light conditions. When you press the shutter button halfway in dark places or other situations, an AF area wider than usual appears and the AF assist lamp ① turns on.

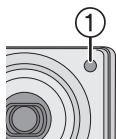

ON	The AF assist lamp turns on under low light conditions. At this time, the AF assist lamp icon [AF*] appears on the screen. The effective range of the AF assist lamp is 4.92 feet (1.5 m).
OFF	The AF assist lamp does not turn on.



- Be sure of the following points when the AF assist lamp is in use.
 - Do not look at the AF assist lamp closely.
 - Do not cover the AF assist lamp with your fingers.
- In simple mode [♥], the setting on the [AF ASSIST LAMP] is fixed to [ON].
- In [SCENERY], [NIGHT SCENERY], [FIREWORKS] and [SELF PORTRAIT] in scene mode (P53), the setting on the [AF ASSIST LAMP] is fixed to [OFF].
- When you do not want to use the AF assist lamp (e.g. when you take a picture of a subject in a dark place), set the [AF ASSIST LAMP] to [OFF]. In this case, it becomes difficult to focus on the subject.
- When the AF assist lamp turns on, the AF area is displayed with a size wider than usual and set only to a point on the center of the screen.

SLOW **Slow Shutter [SLOW SHUTTER]**

The shutter speed can be automatically adjusted. However, you can take pictures brighter than usual by changing the longest shutter speed. This mode is especially effective when you want to record both the background and the subject brightly. You can select the slow shutter from 1/8 second, 1/4 second, 1/2 second and 1 second.

Slow shutter setting	1/8 ←————→ 1
Brightness	Darker Brighter
Jitter	Less More



- Usually, set to [1/8–] to take pictures.
- When you set the shutter speed longer on [SLOW SHUTTER], we recommend using a tripod because jitters will easily occur.

 **Digital Zoom [D.ZOOM]**

It is possible to further magnify a subject already magnified 3 times with the optical zoom by 4 more times with the digital zoom, thereby reaching a maximum of 12 times.

■ Entering the digital zoom range

When you rotate the zoom lever to the extreme Tele position, the on-screen zoom indication may momentarily pause. This is not a malfunction.

You can enter the digital zoom range to continuously rotate the zoom lever to Tele or to release the zoom lever once and then rotate it to Tele again.

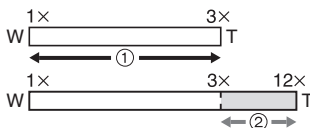

- ① Optical zoom
 ② Digital zoom
 (e.g. 4 times magnification)



- When using the digital zoom the picture quality deteriorates.
- In the digital zoom range, the stabilizer function may not be effective.
- We recommend using a tripod.
- The AF area is displayed with a size wider than usual and set only to a point on the center of the screen in the digital zoom range.

 **Color Effect [COL.EFFECT]**

You can use 4 types of color effects depending on the image of the picture.

COOL	The picture becomes bluish.
WARM	The picture becomes reddish.
B/W	The picture becomes black and white.
SEPIA	The picture becomes sepia.

 **Picture Adjustment [PICT.ADJ.]**

Use this function according to the recording situation and the atmosphere of the picture.

NATURAL	The picture becomes softer.
VIVID	The picture becomes sharper.



- When you take pictures in dark places, noises may become visible. To avoid noises, we recommend setting [PICT.ADJ.] to [NATURAL].

Flip Animation [FLIP ANIM.]



This camera allows you to create motion picture files up to 20 seconds long by connecting images recorded in flip animation mode.

Example:

When capturing images of the subject in sequence moving the camera little by little and aligning the images, the subject looks as if it is moving.



- You can play back created flip animations with the same method used to play back motion images. (P70)

1 Select [FLIP ANIM.].

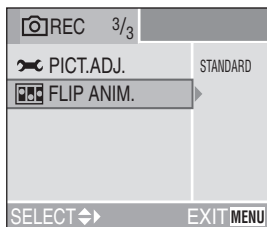

- A motion image file is created by putting images recorded in [IMAGE CAPTURE] together by [CREATE MOTION IMAGE].
- Audio cannot be recorded.
- You cannot use the audio dubbing with flip animations.

2 Select [IMAGE CAPTURE].

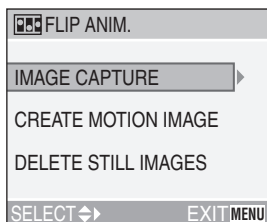

- The picture size is 320×240 pixels.

3 Capture images for flip animation.

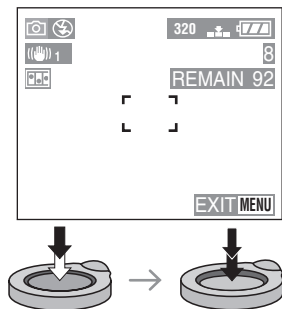

- You can check the recorded image with \blacktriangledown and the previous or following image with $\blacktriangleleft/\blacktriangleright$.
- Delete unnecessary images with $\left[\text{trash}\right]$ button.
- You can record up to 100 pictures. The number of recordable pictures displayed is an approximation.

4 Select [CREATE MOTION IMAGE].

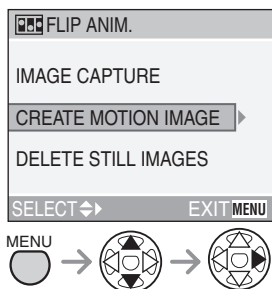

5 Select [FRAME RATE] and set the number of frames.

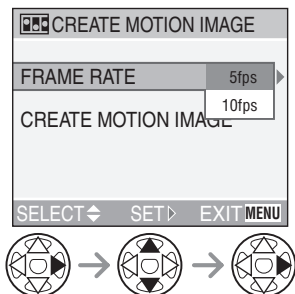

5fps	5 frames/sec.
10fps	10 frames/sec. (The motion images become smoother.)

6 Select [CREATE MOTION IMAGE] and create a flip animation.

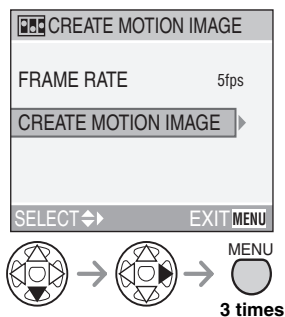

- The file number appears after creating a flip animation.

■ Deleting all still images used to create flip animation

When selecting [DELETE STILL IMAGES] in [FLIP ANIM.] menu, a confirmation screen appears. Select [YES] with ▼ and then press ►.



- You cannot use the audio recording function, burst mode and auto bracket.
- The images in each frame do not appear in normal review. (P35)
- If you execute [CREATE MOTION IMAGE], flip animation is made from all pictures recorded for flip animation. Delete unnecessary pictures.
- Flip animations may not be played back by other equipment.
- The audio is not recorded on flip animations, however, you may hear varying levels of noises when you play back flip animations with other equipment which does not have a mute function.

Playing Back Pictures with Audio/Motion Images



■ Pictures with audio

Select the picture with audio icon [] and play back the audio.



■ Motion images

Select the picture with the motion image icon [] and play back the motion images.



- The cursor displayed during playback corresponds to ▲/▼/◀/▶.
- Motion image playback stops and the normal playback is restored by pressing ▼.



■ Fast forwarding/Fast rewinding

During motion image playback, keep pressing ◀/▶.

▶: Fast forward

◀: Fast rewind

- When releasing the button, it turns to normal motion image playback.

■ To pause

Press ▲ during motion image playback.

- Press ▲ again to cancel pause.



- You cannot play audio only with the camera. When you want to play audio, connect the camera to TV (P82) or PC (P85).

- The picture with audio cannot be resized (P78) or trimmed (P79).
- You cannot use the zoom function while playing back or pausing motion images.
- The file format that can be played back with this camera is QuickTime Motion JPEG.
- Some QuickTime Motion JPEG files recorded by a PC or other equipment may not be played back with this camera.
- When playing back motion images that have been recorded with other equipment, the quality of images may be deteriorated or it may not be possible to play them back.
- When using a high capacity card, it is possible that fast rewinding may be slower than usual.

Using the [PLAY] mode menu

Rotating the Picture [ROTATE]



You can rotate and display the recorded pictures in increments of 90°. This is a convenient function to play back pictures on TV.

■ Example

When rotating clockwise (↻)

Original picture

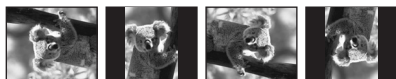

0°

90°

180°

270°

1 Select [ROTATE].



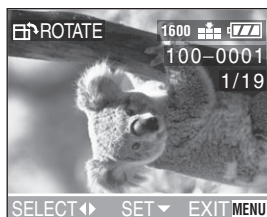

2 Select the picture to be rotated and set it.

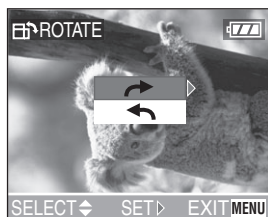

3 Select the direction to rotate the picture.



2 times

	The picture rotates clockwise in increments of 90°.
	The picture rotates counter-clockwise in increments of 90°.



- Still pictures can only be rotated in normal playback. When playing back rotated pictures in zoom playback or multi playback, pictures appear in original angle.
- Protected pictures cannot be rotated.
- When you play the picture on a PC, you cannot play rotated pictures without an OS or a software compatible with Exif.
- Exif is the file format for still pictures, to which recording information and other can be added, established by JEITA [Japan Electronics and Information Technology Industries Association].



Setting the Picture to be Printed and the Number of Prints [DPOF PRINT]



DPOF (Digital Print Order Format) is a system that allows the user to select which pictures are to be printed on compatible photo printers. DPOF also allows the user to set how many copies of each picture will be printed. Many commercial photo printing services now use DPOF. For more information please visit:

http://www.panasonic.jp/dc/dpof_110/white_e.htm

1 Select [DPOF PRINT], then select [SINGLE], [MULTI] or [CANCEL].

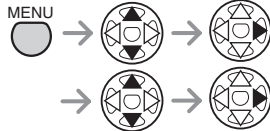
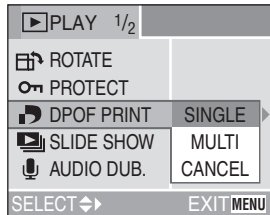

■ Single setting

Select the picture and set the number of prints.



2 times

- The number of prints can be set from 0 to 999.
- The number of prints icon [] appears.
- When the number of prints is set to "0", DPOF print setting is canceled.

■ Multi setting

Select the pictures and set the number of prints.



2 times

- Repeat the above procedure.
- The number of prints can be set from 0 to 999.
- The number of prints icon [] appears.
- When the number of prints is set to "0", DPOF print setting is canceled.

■ To cancel all settings

Select [YES] to cancel all settings.

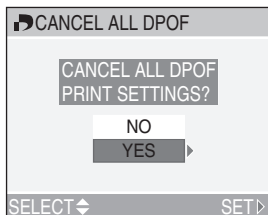

■ To print the date

You can set/cancel the printing with the recorded date each press of the [DISPLAY] button when setting the number of prints.



- The date print icon [] appears.
- When you go to a photo studio for digital printing, be sure to order the printing of the date additionally if required.
- The date may not be printed depending on photo studios or printers even if you set the date print. For further information, ask the photo studio for details or refer to the operating instructions of the printer.



- DPOF print setting is a convenient function when you print pictures with printers supporting DPOF printing. (P87)
- DPOF is the abbreviation for Digital Print Order Format. This feature allows you to write print information or other into the images on the card and to use such information on the DPOF-compliant system.
- The setting of DPOF print will not be applied to the DPOF setting of Slide Show.
- If the file is not based on the DCF standard, the DPOF print setting cannot be set. DCF is an abbreviation of [Design rule for Camera File system], stipulated by JEITA [Japan Electronics and Information Technology Industries Association].
- When setting the DPOF print, delete any previous DPOF print settings made by other equipment.

Preventing Accidental Erasure of the Picture [PROTECT]



You can set the protection to the pictures which you do not want to delete for preventing them from accidental erasure.

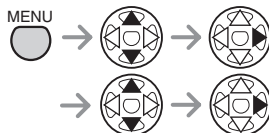
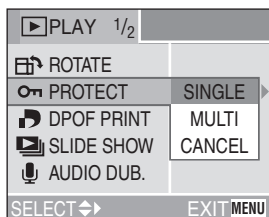

1 Select [PROTECT], then select [SINGLE], [MULTI] or [CANCEL].



■ Single setting

Select the picture and set/cancel the protection.



SET	The protect icon  appears.
CANCEL	The protect icon  disappears.

- Close the menu by pressing the [MENU] button 2 times after finishing the setting/ canceling.

■ Multi setting/To cancel all settings

Perform the same operation as in [Setting the Picture to be Printed and the Number of Prints [DPOF PRINT]]. (P72–73)



- If you want to delete protected pictures, cancel the protect setting first.
- While this feature protects the pictures from accidental erasure, formatting the card will permanently delete all data. (P80)
- The protect setting may not be effective in other equipment.
- Sliding the Card Write-Protect switch (A) to [LOCK] prevents the picture from deletion even if the protection is not set.

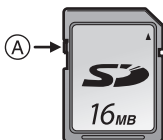

- You cannot use the audio dubbing with protected pictures. (P77)

▶ Playing Back with Slide Show [SLIDE SHOW]



1 Select [SLIDE SHOW], then select [ALL] or [DPOF].

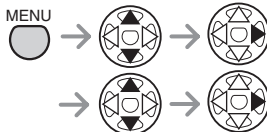
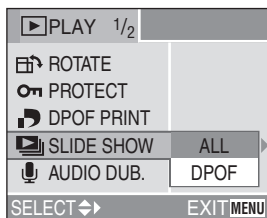

ALL	for playing back all pictures
DPOF	for playing back the pictures for which DPOF Slide Show was set

2 Set the items of the Slide Show.

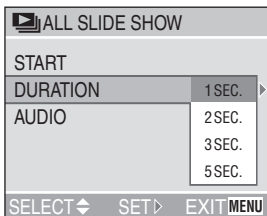

DURATION	It can be set among 1, 2, 3 and 5 seconds.
AUDIO	By setting it to [ON], the audio from pictures recorded with audio can be played back during Slide Show.
DPOF SET (Only when setting to [DPOF])	You can select the pictures you want to set to the Slide Show. DPOF icon ① appears on the selected pictures in green.
CANCEL ALL (Only when setting to [DPOF])	You can cancel the DPOF Slide Show setting.

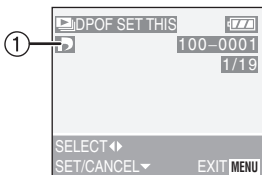

- When the camera is connected to TV, the audio of the pictures with audio can be played back during Slide Show.

3 Select [START].

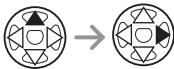
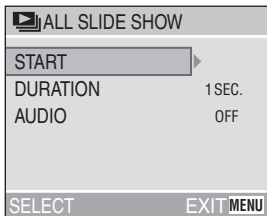

4 By pressing the [MENU] button, the Slide Show stops.

■ SD Slide Show

If you insert a card including the SD Slide Show edited with the [SD Viewer for DSC] which is in the supplied CD-ROM, and then turn the camera on in playback mode, the confirmation screen appears. Select [YES] and press ► to start the SD Slide Show. Select [NO] and press ► to start normal playback.

- Pictures set with the DPOF Slide Show by the [SD Viewer for DSC] cannot be played back as a Slide Show. Please set DPOF Slide Show with this camera again.



- In motion image playback, Slide Show is not available.
- The DPOF setting for the Slide Show will not be applied to DPOF printing.
- DPOF Slide Show cannot be performed without the DPOF setting for Slide Show.
- When setting the DPOF Slide Show to the picture with DPOF printing, both the DPOF icon and the number of prints appear on the picture in green.
- When only the DPOF printing is set on the picture, the DPOF icon and the number of prints appear in white. They do not appear on the DPOF Slide Show.
- When you set [AUDIO] to [ON] and then play back a picture with audio, the sound is played for 5 seconds in audio recording or for 10 seconds at the maximum in audio dubbing.
- When setting the DPOF Slide Show on the camera, delete any previous DPOF settings made by other equipment.

Adding Audio to Recorded Pictures [AUDIO DUB.]



You can record the audio after taking a picture.

1 Select [AUDIO DUB.].



3 Stop audio recording.

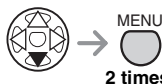

- Even if you do not press ▼, after about 10 seconds the audio recording stops automatically.

2 Select the picture and start audio recording.

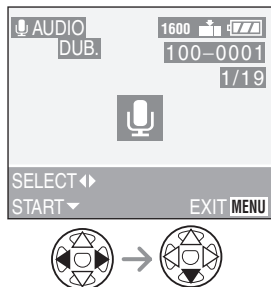

- When audio has already been recorded, the confirmation screen appears. Press ▼ to select [YES], and press ► to start audio recording. (The original audio is overwritten.)
- The audio dubbing cannot be used with motion images and protected images.

Resizing the Pictures [RESIZE]



This function is useful if you want to reduce the file size of the picture in cases when it needs to be attached to an e-mail or uploaded to a website.

1 Select [RESIZE].

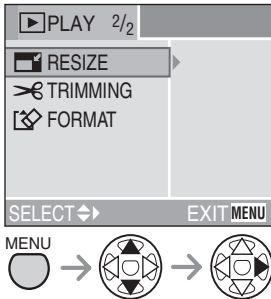

2 Select the picture and set it.



- The following pictures cannot be resized.
 - Pictures equal to or smaller than 640×480 pixels
 - Pictures recorded after setting the picture size to [HDTV]
 - Motion images
 - Flip animation
 - Pictures with audio
 - Rotated pictures (You can resize them if you rotate them back to their original position.)

3 Select the size and set it.



- Sizes smaller than the recorded picture are displayed.
- [2048]: 2048×1536 pixels
- [1600]: 1600×1200 pixels
- [1280]: 1280×960 pixels
- [640]: 640×480 pixels

4 Select [YES] or [NO] and set it.



2 times

- When you select [YES], the picture is overwritten.
- When the original picture is protected, you cannot overwrite the resized picture.



- It may not be possible to resize pictures recorded with other equipment.
- When resized pictures are overwritten, they cannot be restored.

Trimming the Pictures [TRIMMING]



Use this function when you trim unnecessary parts of the recorded picture.

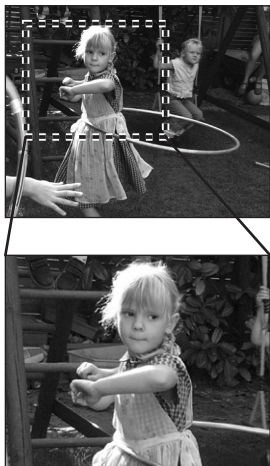

2 Select the picture to trim and set it.



- The following pictures cannot be trimmed.
 - Pictures smaller than 640×480 pixels
 - Pictures recorded after setting the picture size to [HDTV]
 - Motion images
 - Flip animation
 - Pictures with audio
 - Rotated pictures (You can trim them if you rotate them back.)

1 Select [TRIMMING].

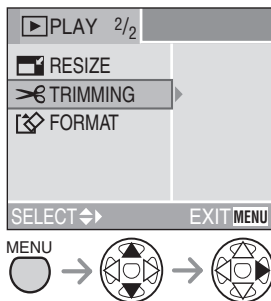

3 Enlarge or decrease the picture.

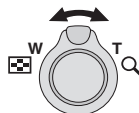

4 Shift the picture and press the shutter button fully to set.



5 Select [YES] or [NO] and set it.

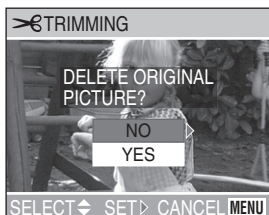

2 times

- When you select [YES], the picture is overwritten.
- When the original picture is protected, you cannot overwrite the resized picture.

Initializing the Card [FORMAT]



1 Select [FORMAT].

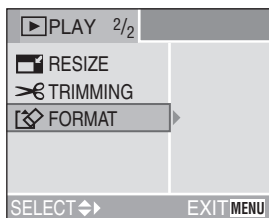

2 Select [YES] to format.

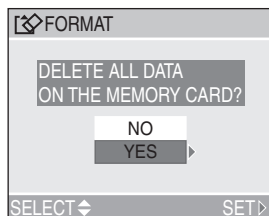

- It may not be possible to trim pictures recorded with other equipment.
- The picture size of the trimmed pictures may become smaller than that of the original one depending on the cut size.
- The picture quality of the trimmed picture may be deteriorated.
- When trimmed pictures are overwritten, they cannot be restored.



- Usually, it is not necessary to format the card. Format the card when the message [MEMORY CARD ERROR] appears.
- Do not format the card on a computer. Always format on the camera.
- **Once the card is formatted, all data including protected images are irretrievably erased. Please confirm that all data is transferred to your PC before proceeding with format function.**
- During formatting, do not turn the camera off.
- When you format the card, use a battery with sufficient battery power (P13) or AC adapter (DMW-CAC2; optional).
- When the SD Memory Card Write-Protect switch is slid to [LOCK], you cannot format the card.
- If the card cannot be formatted, consult your nearest servicenter.

For USA assistance, please call: 1-800-272-7033
or send e-mail to : digitalstillcam@panasonic.com

For Canadian assistance, please call:
1-800-561-5505 or visit us at www.panasonic.ca

Playing Back Pictures with a TV Screen

■ Playing back pictures with the supplied cable

- Turn the camera and the TV off.

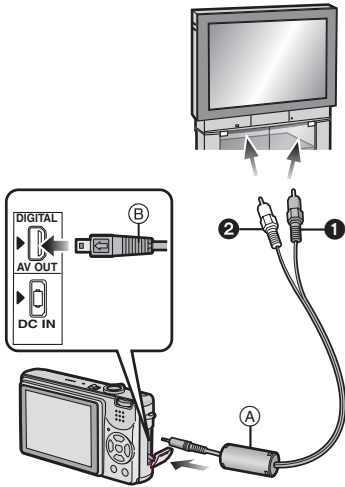

1 Connect the AV cable (A) (supplied) to the [AV OUT] socket of the camera.

- Connect the AV cable with the [➡] mark facing the [▶] mark on the [AV OUT] socket.
- Hold (B) and then insert or pull the AV cable straight.

2 Connect the AV cable to the video input and the audio input sockets of the TV.

- ① Yellow: to the video input socket
- ② White: to the audio input socket

3 Turn the TV on and select external input.

4 Turn the camera on and then set the mode dial to playback mode [▶].

■ Viewing pictures in other countries

When setting [VIDEO OUT] on the menu, you can view pictures on a TV in other countries (regions) which use the NTSC or PAL system.

- Even if you set menu selection for [VIDEO OUT] to [PAL], the output signal is still NTSC in the recording mode.

■ Playback pictures on TV with SD Memory Card slot

A recorded SD Memory Card can be played back on TVs with an SD Memory Card slot.

If you play back pictures recorded using [HDTV] mode on a High-Definition TV, (HDTV has 16:9 aspect) the picture quality will be better.



- Do not use any other AV cable except the supplied one.
- Read the TV operating instructions too.
- You can display pictures on a TV only when the mode dial is set to playback mode [▶].

Before Connecting with USB Connection Cable

[USB] : USB MODE

Select the USB communication system according to the OS of your PC or your printer before connecting them to the camera with the USB connection cable (supplied). Set the items on [USB MODE] in the [SETUP] menu. (P23)

1 Select [USB MODE].

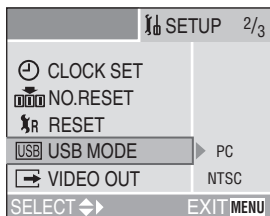

2 Select [PC] or [PictBridge (PTP)].

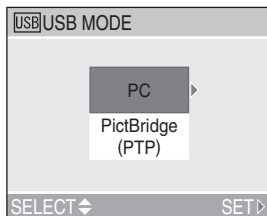

	Devices to be connected	Setting on the USB mode
PC/OS	Windows® 2000 Professional, Windows Me, Windows 98/98 SE or Mac OS X (10.1 or above), Mac OS 9.x	[PC]
	Windows XP Home Edition, Windows XP Professional or Mac OS X	[PC] or [PictBridge (PTP)]
Printer	Printers supporting PictBridge	[PictBridge (PTP)]



- When [PC] is selected, the camera is connected via USB Mass Storage communication system.
- When [PictBridge (PTP)] is selected, the camera is connected via PTP (Picture Transfer Protocol) communication system.

■ When using Windows 98/98 SE

When using Windows 98/98 SE, install the USB driver before connecting. (When using Windows Me/2000/XP, Mac OS 9.x and Mac OS X, you do not have to install the USB driver.)

■ When using Windows 2000 Professional, Windows Me, Windows 98/98 SE or Mac OS 9.x

Even if the [PictBridge (PTP)] is selected in [USB MODE], the camera cannot be connected by a PC with the following OS's: Windows 2000 Professional, Windows Me, Windows 98/98 SE or Mac OS 9.x.

- When connecting the camera to a PC, do not set [USB MODE] to [PictBridge (PTP)]. (When the camera is shipped, [PC] is selected.)
- When connecting to a PC which includes the above-mentioned OS and setting the [USB MODE] to [PictBridge (PTP)], the messages shown on the right appear on the LCD monitor of the camera.

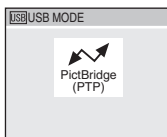

The following messages appear for each OS on the display of the PC. Select [Cancel] to close the window and disconnect the USB connection cable.

OS	Message
Windows 2000 Professional	[Welcome to the Found New Hardware Wizard]
Windows Me Windows 98/98 SE	[New Hardware Found]→ [Add New Hardware Wizard] (When you connect to the PC more than 2 times, only [Add New Hardware Wizard] appears.)
Mac OS 9.x	[Software needed for the USB device "DMC-FX7" is not available. Would you like to look for the software on the Internet?]

Connecting to a PC

- Refer to the separate operating instructions for details about PC connection.
- If you use Windows 98/98SE, install the USB driver and then connect it to the computer.
- When using Windows Me/2000/XP, Mac OS 9.x and Mac OS X, you do not have to install the USB driver.

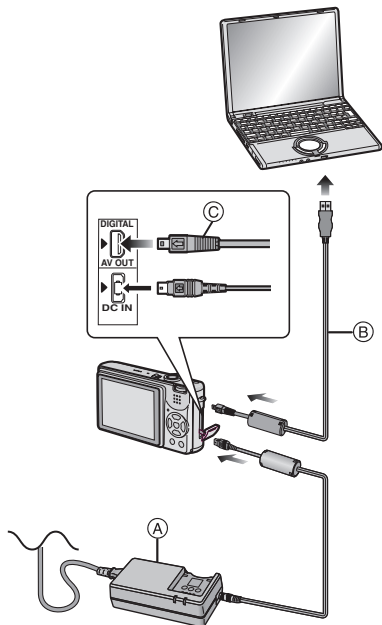

- (A): AC adaptor (DMW-CAC2; optional)
 (B): USB connection cable (supplied)

1 Turn the camera on and set the [USB MODE] according to the OS you use.

- Set to [PC] or [PictBridge (PTP)]. Refer to "Before Connecting with USB Connection Cable" on page 83.
- If [USB MODE] is set to [PictBridge (PTP)] while Windows XP or Mac OS X is used, it is connected as PTP.

2 Connect the camera to a PC via the USB connection cable (B) (supplied).

- Connect the USB connection cable with the [➡] mark facing the [▶] mark on the [DIGITAL] socket.
- Hold © and then insert or pull the USB connection cable straight.

Depending on the USB mode setting, the indications on the screen may vary. Refer to page P86.

■ PC

[Windows]

The drive appears on the [My Computer] folder.

- If it is the first time you are connecting the camera to a PC, the required driver is installed automatically so that the camera can be recognized by the Windows Plug and Play, then it appears on the [My Computer] folder.

[Macintosh]

The drive is shown on the screen.

■ PictBridge (PTP)

[Windows]

The camera icon appears on the [My Computer] folder.

- If it is the first time you are connecting the camera to a PC, the required driver is installed automatically so that the camera can be recognized by the Windows Plug and Play, then the camera icon appears on the [My Computer] folder.

[Macintosh]

You can read pictures with image capture or iPhoto.



- If the remaining battery power is exhausted during communication, the recorded data may be damaged. When you connect the camera to the PC, use a battery with sufficient battery power (P13) or the AC adaptor (DMW-CAC2; optional).
- If the remaining battery power becomes low during communication, the status indicator turns red, starts to blink (P13) and the alarm beeps. In this case, stop the communication immediately. Then turn the camera off and charge or replace the battery.
- Refer to P84 when connecting to the OS except for Windows XP and Mac OS X when setting [USB MODE] to [PictBridge (PTP)].

- While [ACCESS] is being displayed, do not disconnect the USB connection cable.
- Do not use any other USB connection cables except the supplied one.
- Refer to the operating instructions of the PC, too.

■ About PictBridge (PTP) setting

- It may take time to display the communication screen depending on the PC.
- You can only load pictures from the camera and cannot write them on the card or delete them.
- When there are 1000 or more pictures on a card, the pictures may not be imported.
- When the PC recovers from the standby mode while connecting it to a camera with USB connection cables, they may not properly communicate with each other.

Connecting to a PictBridge-compliant Printer

By connecting the camera directly to a printer supporting PictBridge via the USB connection cable (supplied), you can select the pictures to be printed or start printing.

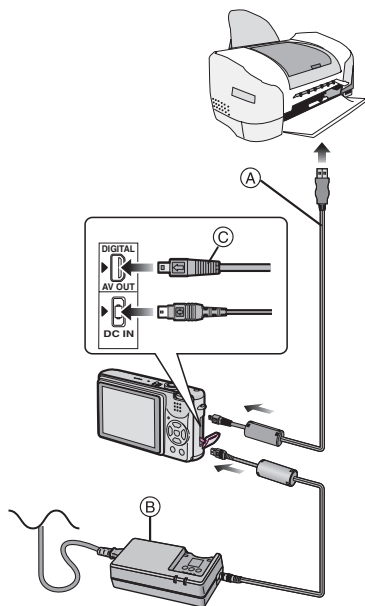

- (A): USB connection cable (supplied)
 (B): AC adaptor (DMW-CAC2; optional)

1 Turn the camera on and then set the USB mode to [PictBridge (PTP)]. (P83)

2 Turn on the printer.

3 Connect the camera to a printer via the USB connection cable (A) (supplied).

- Connect the USB connection cable with the [➡] mark facing the [▶] mark on the [DIGITAL] socket.
- Hold (C) and then insert or pull the AV cable straight.

When the DPOF Print is set. (P72)	Select [DPOF PICTURE]. (P89)
When the DPOF Print is not set.	Select [SINGLE PICTURE]. (P88)



- If the remaining battery power becomes low during communication, the status indicator turns red, starts to blink (P13) and the alarm beeps. In this case, stop the communication immediately. Then turn the camera off and replace the battery with a charged one or charge the battery. Or, use the AC adaptor (DMW-CAC2; optional).
- Set the print settings such as print quality on the printer beforehand. Ask the manufacturer of the printer about the corresponding models. (Read the printer operating instructions, too.)
- It may take time to print some pictures. Therefore, we recommend using a battery with sufficient power (P13) or the AC adaptor (DMW-CAC2; optional) when you connect to a printer.
- Disconnect the USB connection cable after printing.
- Do not use any other USB connection cables except the supplied one.

- Set the print settings such as paper size or print quality on the printer beforehand. (Read the printer operating instructions.)
- Connect the camera to a printer. (P87)

■ Single picture

1 Select a picture to be printed.

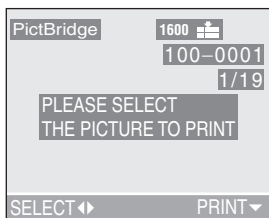

- A message displays for about 2 seconds.

2 Set the print settings.

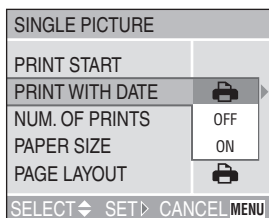

- The items which are not supported by the printer are displayed in gray and cannot be selected.
- When you want to print pictures in a paper size or a layout which is not supported by the camera, set [PAPER SIZE] and [PAGE LAYOUT] to [] and then set the paper size or the layout on the printer. (For details, refer to the operating instructions of the printer.)

■ [PRINT WITH DATE]

	Settings on the printer are prioritized.
OFF	Date is not printed.
ON	Date is printed.

- If the printer does not support date printing, the date cannot be printed on the picture.

■ [NUM. OF PRINTS]

Set the number of prints.

■ [PAPER SIZE]

(Possible paper sizes on the camera)

The items are listed on 1/2 and 2/2.





Press **▼** to select the desired item.

1/2	
	Settings on the printer are prioritized.
L/3.5"×5"	89 mm×127 mm
2L/5"×7"	127 mm×178 mm
POSTCARD	100 mm×148 mm
A4	210 mm×297 mm
2/2*	
CARD SIZE	54 mm×85.6 mm
10×15cm	100 mm×150 mm
4"×6"	101.6 mm×152.4 mm
8"×10"	203.2 mm×254 mm
LETTER	216 mm×279.4 mm

- * These items cannot be displayed when the printer does not support the paper sizes.

■ [PAGE LAYOUT]

(Possible layouts on the camera)

	Settings on the printer are prioritized.
	1 page with no frame print
	1 page with frame print
	2 pages print
	4 pages print

3 Select [PRINT START] and then print out the picture.

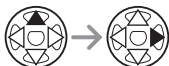
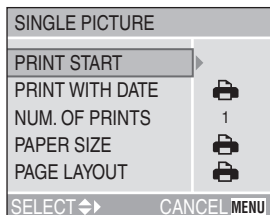

- Press the [MENU] button to cancel printing.

■ DPOF picture

- Set the DPOF print with this camera in advance. (P72)

1 Select [DPOF PICTURE].

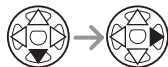
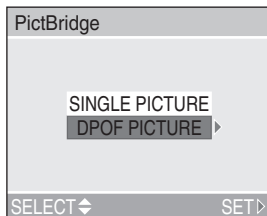

- When printing under the new settings, disconnect the USB connection cable and connect it to the printer again.
- You can change the DPOF print setting by pressing the [MENU] button. (P72)

2 Select [PRINT START] and then print out the picture.

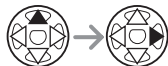
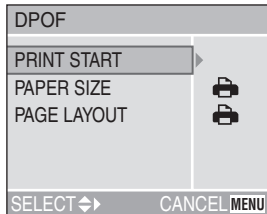

- Refer to P88 for print setting.
- Press the [MENU] button to cancel printing.

■ Setting the date printing with the DPOF print in advance

When the printer supports the date printing by DPOF setting, we recommend setting the date printing with the DPOF print in advance. (P73)

The recording date can be printed by selecting [DPOF PICTURE] to start printing.



- Do not disconnect the USB connection cable when the cable disconnection warning icon [⊗] is indicated.
- When the [●] indication lights in yellow during printing, make sure there is no malfunction on the printer.
- In DPOF print, if the total number of prints or the number of printed pictures is high, pictures are printed several times. (The indication of the remaining number of prints is different from the setting, however, this is not a malfunction.)
- The setting on the printer may have priority over the setting on the camera in the date print. Also check the date print setting on the printer.
- If the printer does not support date printing, the date cannot be printed on the picture.

■ Layout printing

• When printing a picture several times on 1 sheet of paper

For example, if you want to print a picture 4 times on 1 sheet of paper, set [PAGE LAYOUT] to [4x4] and then set the number of prints to 4 for the picture on [NUM. OF PRINTS].



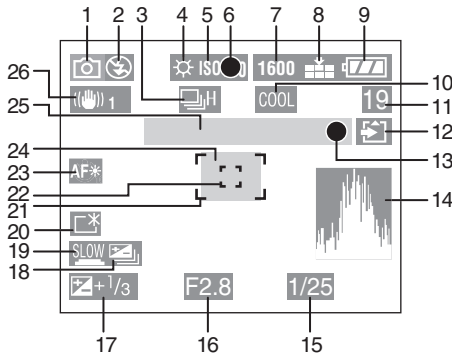

• When printing different pictures on 1 sheet of paper (only in DPOF printing)

For example, if you want to print 4 different pictures on 1 sheet of paper, set [PAGE LAYOUT] to [4x4] and then set the number of prints to 1 on [COUNT] in DPOF print setting (P72) for each of the 4 pictures.

Screen Display



■ In recording

- | | |
|--|--|
| 1 Recording mode | 19 Slow shutter (P65) |
| 2 Flash (P37) | 20 Power LCD indication (P25) |
| 3 Burst (P44) | 21 AF area (P28) |
|  : Audio recording (P51, 63) | 22 Spot AF area (P64) |
| 4 White balance (P60) | 23 AF assist lamp (P65) |
| 5 ISO sensitivity (P62) | 24 Self-timer (P40) |
| 6 Focus indication (P28) |  |
| 7 Picture size (P62) | 25 Zoom/Digital zoom (P36, 66) |
| 8 Quality (P63) |  |
|  : Jitter alert indication (P30) | 26 Optical image stabilizer (P43) |
| 9 Battery indication (P13) | • Current date and time is displayed on the bottom of the screen for about 5 seconds when turning the camera on, setting the clock and after switching from the playback mode to the recording mode. |
| 10 Color effect (P66) | |
| 11 Picture/Time remain | |
| In Motion image mode: e.g. 11S | |
| 12 Card access indication (P16) | |
| 13 Recording indication | |
| 14 Histogram (P26) | |
| 15 Shutter speed indication (P28) | |
| 16 Aperture value indication (P28) | |
| 17 Exposure compensation (P41) | |
| 18 Auto bracket (P42) | |

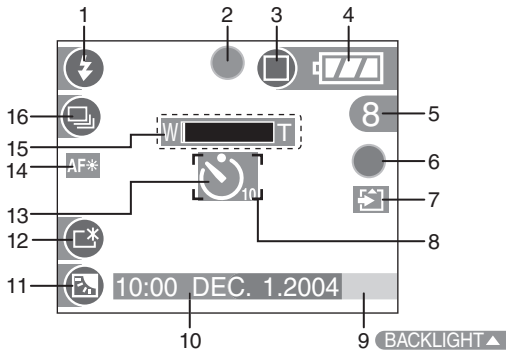

■ Recording in simple mode

- 1 Flash (P37)
- 2 Focus indication (P28)
- 3 Picture mode (P32)
-  : Jitter alert indication (P30)
- 4 Battery indication (P13)
- 5 Picture remain
- 6 Recording indication
- 7 Card access indication (P16)
- 8 AF area (P28)
- 9 Backlight compensation indication (P34)
- 10 Current date and time (P18)
 - This is displayed for about 5 seconds when turning the camera on, setting the clock and after switching from the playback mode to the simple mode.
- 11 Compensating backlight ON indication (P34)
- 12 Power LCD indication (P25)
- 13 Self-timer (P40)
- 14 AF assist lamp (P65)
- 15 Zoom (P36)
- 16 Burst (P44)

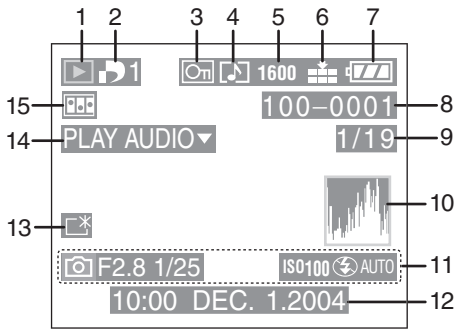

■ In playback

- | | |
|---|--|
| <p>1 Playback mode</p> <p>2 DPOF (P72)
 (White):
 DPOF setting for printing
 (Green):
 DPOF setting for Slide Show
 (Green with number of prints):
 DPOF setting for printing and Slide Show</p> <p>3 Protected picture (P74)</p> <p>4 Picture with audio (P70)</p> <p>5 Picture size (P62)
 : In Motion image mode (P70)</p> <p>6 Quality (P63)
 / : In Motion image mode (P51)
 Simple mode (P32):
 : ENLARGE
 : 4"×6"/10×15cm
 : E-MAIL</p> <p>7 Battery indication (P13)</p> <p>8 Folder/File number</p> <p>9 Page number/Total pictures</p> <p>10 Histogram (P26)</p> | <p>11 Recording information
 (Recording mode/Aperture value/
 Shutter speed/ISO sensitivity/Flash/
 White balance)
 • It will be displayed when the
 [DISPLAY] button is pressed.</p> <p>12 Recorded date and time</p> <p>13 Power LCD indication (P25)</p> <p>14 Audio playback (P70)
 : In Motion image mode</p> <p>15 Flip animation (P67)</p> |
|---|--|

Cautions for Use

■ Optimal Use of the Camera

When carrying this camera, take care not to drop or hit it.

- The outer case may be destroyed by the strong shock, and it may cause malfunction of this camera.

Keep the camera away from magnetized equipment (such as a microwave oven, TV, video game equipment, etc.).

- If you use the camera on or near a TV, pictures and sounds may be disrupted due to electromagnetic wave radiation.
- Do not use the camera near a cell phone because doing so may cause noise to adversely affect the pictures and sounds.
- Recorded data may be damaged, or pictures may be distorted by strong magnetic fields created by speakers or large motors.
- Electromagnetic wave radiation generated by a microprocessor may adversely affect the camera, causing the disturbance of pictures and sounds.
- If the camera is affected by magnetically charged equipment and does not function properly, turn the camera off and remove the battery or disconnect AC adaptor (DMW-CAC2; optional) and then insert the battery or connect AC adaptor again. Thereafter, turn the camera on.

Do not use the camera near radio transmitters or high-voltage lines.

- If you record near radio transmitters or high-voltage lines, recorded pictures or sounds may be adversely affected.

Make sure to use the supplied cords and cables.

If you use optional accessories, use the cords and the cables supplied with them.

Do not extend the cords and the cables.

Do not spray insecticides or volatile chemicals onto the camera.

- If the camera is sprayed with such chemicals, the camera body may be damaged and the surface finish may peel off.
- Do not keep rubber or plastic products in contact with the camera for a long period of time.

Do not use benzine, thinner or alcohol for cleaning the camera.

- Before cleaning the camera, remove the battery or disconnect the charger from the electrical outlet.
- The camera body may be deformed and the surface finish may peel off.
- Wipe the camera with a soft, dry cloth. To remove stubborn stains, wipe with a cloth that is soaked in a detergent diluted with water and afterward finish wiping with a dry cloth.
- When you use chemical cloth, follow the instructions that come with the cloth.
- In case rain or other sources of water splash onto the camera, wet a soft cloth with tap water, wring it well, and use it to wipe the camera body carefully. Then wipe it again with a dry cloth.

■ Battery

The battery is a rechargeable lithium ion battery. Its ability to generate power is based upon the chemical reaction that takes place inside it. This reaction is susceptible to the surrounding temperature and humidity, and, if the temperature is too high or too low, the operating time of the battery will be shorter.

Be sure to remove the battery after use.

Store the removed battery in the battery carrying case.

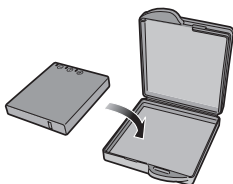

When you go out, bring charged spare batteries.

- Be aware that the operating time of the battery becomes shorter under low temperature such as skiing grounds.
- When you travel, be sure to prepare the supplied charger to charge the battery on the spot.

If you drop the battery accidentally, check to see if the battery body and terminals are damaged.

- Inserting damaged battery in the camera may damage the camera.

After use, be sure to remove the card and the battery or disconnect the plug from the electrical outlet.

- Extremely high or low temperatures will shorten the life of the battery.
- If the battery is kept in smoky or dusty places, the terminals may rust and cause malfunctions.

Dispose of an unusable battery.

- The battery has a limited life.

- Do not throw the battery into fire because it may cause an explosion.
- An unusable battery should be discarded in accordance with battery recycling laws. For information you can call the RBRC hotline at 1-800-822-8837.

Do not allow the battery terminals to come in contact with metal objects (such as necklaces, hairpins, etc.).

- This can result in a short circuit or heat generation and, if you touch the battery in this condition, you may be badly burned.

■ Charger

- If you use the charger near a radio, radio reception may be disturbed. Keep the charger 3.28 feet (1 m) or more away from radio.
- When the charger is in use, it may generate whirring sounds. However, this is not a malfunction.
- After use, be sure to disconnect the charger from the electrical outlet. (If it is left connected, a minute amount of current is consumed.)
- Keep the terminal of the charger and battery clean.

■ Condensation (When the lens is fogged up)

When condensation has taken place:

- Turn the camera off and leave the camera in this condition for about 2 hours. When the camera becomes close to the ambient temperature, the condensation disappears naturally.
- When you move the camera from a cold place to a hot place, put the camera into plastic bag and then take it out after the temperature of the camera becomes close to the ambient temperature to avoid condensation.

If condensation has taken place, it causes a malfunction.

Be careful to avoid condensation and take proper measures when condensation occurs.

■ Card

While the card access indication appears (the card is accessed), do not open the Card/Battery Door to remove the card, do not turn the camera off or do not shake or cause impact to the camera.

Do not leave the card in places where there is high temperature or direct sunlight, or where electromagnetic waves or static electricity are easily generated.

Do not bend or drop the card.

- The card may be damaged or the recorded content may be damaged or erased.

After use, be sure to remove the card from the camera and then store it.

- For storing or transporting the camera, place it in a bag.
- Do not allow dirt, dust or water to enter the terminals on the back of the card and do not touch it with your fingers.

■ Folder Composition

When a Memory Card with data recorded on it is inserted into a PC, the folders shown below will appear.

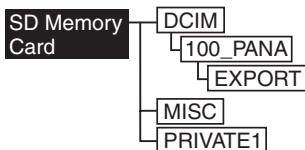

- In the [100_PANA] folder it is possible to record up to 999 pictures.
- In the [MISC] folder it is possible to record the files that have been set with DPOF settings.
- The files recorded in flip animation function are stored in [PRIVATE1] folder.
- The motion images created by flip animation function are stored in [100_PANA] or another folder.

■ Printing pictures recorded with HDTV mode

When you print pictures recorded after setting the picture size to [HDTV] (1920×1080 pixels), both ends of the pictures may be cut out.

When using the printer with a trimming feature and [Non-edge] printing function, cancel these features and then try printing. (Refer to the operating instructions of the printer.)

Message Display

[NO MEMORY CARD]

Insert the card.

[THIS MEMORY CARD IS PROTECTED]

Cancel the card lock.

[NO VALID IMAGE TO PLAY]

Play back after recording or after inserting a card with a recorded picture.

**[MEMORY CARD FULL/
NOT ENOUGH MEMORY IN THE CARD]**

Insert a new card or delete the unnecessary data.

**[MODE DIAL IS NOT IN THE PROPER
POSITION]**

This message appears when you turn the camera on with the mode dial in the wrong position.

Rotate the mode dial to the proper position.

[PLEASE SET THE CLOCK]

This message appears when you use the camera for the first time or you do not use the camera for a long time. Set the clock.

[THIS PICTURE IS PROTECTED]

After canceling the protect setting, you can delete or overwrite the picture.

**[THIS PICTURE CAN'T BE DELETED/
SOME PICTURES CAN'T BE DELETED]**

The pictures not based on the DCF standard cannot be deleted.

**[CAN'T BE SET ON THIS PICTURE /
CAN'T BE SET ON SOME PICTURES]**

If the pictures are not based on the DCF standard, the DPOF print cannot be set.

**[NO ADDITIONAL DELETE SELECTIONS
CAN BE MADE]**

You have exceeded the number of pictures that can be set at once with multi-delete setting.

**[MEMORY CARD ERROR FORMAT THIS
CARD?]**

The format of the card cannot be recognized by this camera. Format the card again with this camera.

**[PLEASE TURN CAMERA OFF AND
THEN ON AGAIN]**

This message appears when the camera does not operate properly. Turn the camera off and on. If the message persists, contact the dealer or your nearest servicerenter.

[MEMORY CARD ERROR]

Failed access to the card.

Insert the card again.

[READ ERROR]

Data reading error.

Play it back again.

[WRITE ERROR]

Data writing error.

Turn the camera off and remove the card.

Then insert the card and turn the camera on again. Be sure that the camera is turned off before removing or inserting the card to avoid damage.

Troubleshooting

If you put the menu back to the settings at the time of purchase, the conditions may be improved. **Carry out the [RESET] in the setup menu. (P23)**

Conditions	Causes
The camera will not turn on.	Is the battery inserted correctly? Check the direction of the battery.
	Is the battery sufficiently charged? Use a battery that has been sufficiently charged.
The picture is not displayed on the LCD monitor.	Is the power save mode (P21) or economy mode (P22) activated? Press the shutter button halfway to deactivate these modes.
	Is the battery charge insufficient to operate the camera? Use a battery that has been sufficiently charged.
	Is the built-in flash charging? While the flash is being charged in economy mode, the LCD monitor is off.
The brightness of the screen becomes dark or bright for a moment.	This phenomenon appears when pressing the shutter button halfway to set the aperture value and does not affect the recorded pictures.
The picture cannot be recorded.	Is the card inserted?
	Is the mode dial correctly set?
	Is there any memory capacity left on the card?
	Before recording, delete some pictures.
The screen is too bright or dark.	Adjust the brightness of the screen. (P21)
	Is the Power LCD function activated? (P25)
Flash is not activated	Is the flash mode set to Forced OFF? Change the flash mode. (P37)
	The flash is not activated when [SCENERY], [NIGHT SCENERY], or [FIREWORKS] in scene mode is selected.
The flash is activated 2 times.	The first flash is activated for red-eye prevention on the subject (red-eye phenomenon). 1 second after, the flash is activated again for recording.
Unreadable language was selected by mistake.	Select [] icon on the [SETUP] menu to set the desired language.
The subject is not focused properly.	The focus range varies depending on the recording mode. Rotate the mode dial to set to the proper mode for the distance to the subject.
	Is the subject out of the focus range? (P30)
	When you cannot focus on the subject even if you tried many times, turn the camera off once and turn it on again.

Conditions	Causes
The recorded picture is blurred.	When taking a picture in shaded areas or indoors, the shutter speed becomes slow and the optical Image Stabilizer function may not work properly. In this case, we recommend holding the camera with both hands firmly to take pictures (P27). When the slow shutter (P65) is set, we recommend using a tripod.
When the shutter button is pressed halfway, a red lamp turns on sometimes.	In dark places, the AF assist lamp (P65) lights red to make it easier to focus on a subject.
The AF assist lamp does not turn on.	Is [AF ASSIST LAMP] on the [REC] mode menu set to [ON]?
	Are you taking pictures in bright places? The AF assist lamp does not turn on in bright places.
	The AF assist lamp does not turn on when [SCENERY], [NIGHT SCENERY], and [FIREWORKS] in scene mode is selected.
The picture is not played back.	Is the card inserted?
	Is there a picture in the card?
	Is the mode dial set to playback [
The picture does not appear on the television. The TV screen is disturbed or displayed in monochrome.	Is the camera connected to the TV correctly? Check it.
	Set the TV to video input mode.
When connecting to a PC, pictures cannot be transferred.	Is the camera connected to the PC correctly? Check it.
	Is the camera recognized by the PC correctly?
	Is the USB mode set correctly?
The clock setting is reset.	If you do not use the camera for a long time, the clock setting may be reset. When the message [PLEASE SET THE CLOCK] appears, set the clock again.
	When you take a picture before setting the clock, [0:00 0. 0. 0] is recorded.
The lens clicks.	When brightness has changed due to the zoom or the movement of the camera or other, the lens may click and the picture on the screen may be drastically changed, however, the pictures are not affected. The sound is caused by automatic adjustment of the aperture. It is not a malfunction.

Conditions	Causes
Some pixels are inactive or always lit on the LCD monitor.	This is not a malfunction. These pixels do not affect the recorded pictures.
Noise appears on the LCD monitor.	In dark places, noise may appear to maintain the brightness of the LCD monitor. This does not affect the pictures you are recording.
A vertical red spectrum appears on the LCD monitor.	This is called smear. It is specific to CCD, not a malfunction. It appears when the subject has a bright part. It is recorded on motion images, but not recorded on still pictures.
The pictures cannot be printed with printers.	Does the printer support PictBridge? (P87) Set the USB mode to [PictBridge (PTP)].
Both ends of the picture recorded by setting the picture size to [HDTV] (1920×1080 pixels) are cut out.	When you order photo studios to print pictures, ask the photo studio if the pictures can be printed with both ends. <ul style="list-style-type: none"> • When using the printer with a trimming feature or other feature which cuts out both edges of the pictures, cancel the feature for printing. The feature depends on the printer used. • Refer to the operating instructions of the printer for details.

Specifications

Digital Camera:	Information for your safety
Power Source:	DC 4.7 V
Power Consumption:	2.3 W (When recording) 1.4 W (When playing back)
Camera Effective pixels:	5,000,000 pixels
Image sensor:	1/2.5" CCD, total pixel number 5,360,000 pixels Primary color filter
Lens:	Optical 3× zoom, f=5.8–17.4 mm (35 mm film camera equivalent: 35–105 mm)/F2.8
Digital zoom:	Max. 4×
Focus:	Normal/Macro/ 9-area-focusing/3-area-focusing/1-area-focusing/ Spot-focusing
Focus range:	1.64 feet (50 cm)–∞, Macro/Simple: 0.16 feet (5 cm) (Wide)/ 0.98 feet (30 cm) (Tele)–∞
Shutter system:	Electronic shutter+Mechanical shutter
Shutter speed:	8–1/2,000th Motion image mode: 1/30th–1/2,000th
Burst recording	
Burst speed (max.):	3 frames/second (high speed), 2 frames/second (low speed)
Number of recordable pictures (max.):	7 frames (standard), 4 frames (fine), Depends on the capacity of the card. (no limit) (Performance in burst recording is only with SD Memory Card. MultiMediaCard performance will be less.)
Motion image recording:	320×240 pixels (30 or 10 frames/second with audio. The maximum recording time depends on the capacity of the card.)
ISO sensitivity:	AUTO/80/100/200/400
White balance:	AUTO/Daylight/Cloudy/Halogen/White set
Exposure (AE):	Program AE Exposure compensation (1/3 EV Step, –2–+2 EV)
Metering mode:	Multiple
LCD monitor:	2.5" low-temperature polycrystalline TFT LCD (114,000 pixels) (field of view ratio about 100%)
Flash:	Flash range: (ISO AUTO) Approx. 0.98 feet (30 cm)–13.1 feet (4.0 m) AUTO, AUTO/Red-eye reduction, Forced ON (Forced ON/ Red-eye reduction), Slow sync./Red-eye reduction, Forced OFF
Microphone:	Monaural
Recording media:	SD Memory Card/MultiMediaCard





Picture size:	Still picture: 2560×1920 pixels, 2048×1536 pixels, 1600×1200 pixels, 1280×960 pixels, 640×480 pixels, 1920×1080 pixels
	Motion image: 320×240 pixels Fine/Standard
Quality:	
Recording file format	
Still Picture:	JPEG (Design rule for Camera File system, based on Exif 2.2 standard)/DPOF corresponding
Picture with audio:	JPEG (Design rule for Camera File system, based on Exif 2.2 standard)+640×480 pixels QuickTime (picture with audio) QuickTime Motion JPEG
Motion images:	
Interface	
Digital:	USB 2.0 (Full Speed)
Analog video/audio:	NTSC/PAL Composite (Switched by menu), Audio line output (monaural)
Terminal	
DIGITAL/AV OUT:	Dedicated jack (8 pin)
DC IN:	Dedicated jack
Dimensions:	3 11/16" (W)×1 15/16" (H)×15/16" (D) (94.1 mm (W)×50.0 mm (H)×24.2 mm (D)) (excluding the projection part)
Weight:	Approx. 4.76 oz/135 g (excluding Memory Card and battery) Approx. 5.40 oz/153 g (with Memory Card and battery)
Operating Temperature:	32°F – 104°F (0°C – 40°C)
Operating Humidity:	10% – 80%
Battery Charger	
(Panasonic DE-991B):	Information for your safety

Input:	110–240 V ~ 50/60 Hz, 0.1 A
Output:	CHARGE 4.2 V --- 0.43 A

Equipment mobility:	Movable
Battery Pack (lithium-ion)	
(Panasonic CGA-S004A):	Information for your safety

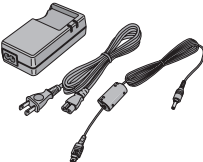
Voltage/capacity:	3.7 V, 710 mAh
--------------------------	----------------

Digital Camera Accessory System

Accessory#	Figure	Description
CGA-S004A		Lithium Ion Battery
DMW-CAC2		Battery Charger/ AC Adaptor
RP-SDH01GU1A RP-SDH512U1A RP-SDH256U1A RP-SD128BU1A RP-SD064BPPA RP-SD032BPPA		1 GB SD Memory Card 512 MB SD Memory Card 256 MB SD Memory Card 128 MB SD Memory Card 64 MB SD Memory Card 32 MB SD Memory Card
BN-SDCAPU/1B		SD USB Reader/Writer (compatible with MultiMediaCard)
BN-SDABPU/1B		SD PC Card Adaptor (compatible with MultiMediaCard)

* Please refer to page 13, for details on the battery charging time and available recording time.

* NOTE: Accessories and/or model numbers may vary by country. Please consult your local dealer.

Digital Camera Accessory Order Form

(For USA Customers)

Please photocopy this form when placing an order.

1. Digital Camera Model # _____

2. Items Ordered

Accessory #	Description	Price Each	Quantity	Total Price
Subtotal				
Your State & Local Sales Tax				
Shipping & Handling				6.95
Total Enclosed				

3. Method of payment (check one)

- Check of Money Order enclosed (NO C.O.D.SHIPMENTS)
- VISA Credit Card # _____
- MasterCard Expiration Date _____
- Discover Customer Signature _____

Make Check or Money Order to: PANASONIC ACCESSORIES

(Please do not send cash)

4. Shipping information (UPS delivery requires complete street address)

Ship To:

Mr.

Mrs.

Ms.

First _____ Last _____

Phone#:

Day () _____

Street Address _____

Night () _____

City _____ State _____ Zip _____

TO OBTAIN ANY OF OUR DIGITAL CAMERA ACCESSORIES YOU CAN DO ANY OF THE FOLLOWING:

VISIT YOUR LOCAL PANASONIC DEALER

OR

CALL PANASONIC'S ACCESSORY ORDER LINE AT 1-800-332-5368

[6 AM-5 PM M-F, 6 AM-10:30 AM SAT, PACIFIC TIME]

OR

MAIL THIS ORDER TO: PANASONIC SERVICES COMPANY ACCESSORY ORDER OFFICE

20421 84th Avenue South Kent, WA. 98032

In CANADA, please contact your local Dealer for more information on Accessories.

Request for Service Notice (For USA Only)

Please photocopy this form when making a request for service notice.

In the unlikely event this product needs service.

Request for Service Notice: (USA Only)

- Please include your **proof of purchase.**
(Failure to do so will delay your repair.)
 - To further speed your repair, please provide an explanation of what wrong with the unit and any symptom it is exhibiting.
-
-
-
-

Mail this completed form and your Proof of Purchase along with your unit to:

Panasonic Services Company
1705 N. Randall Road
Elgin, IL. 60123-7847
Attn: Digital Camera Repair

Limited Warranty (For USA Only)

PANASONIC CONSUMER
ELECTRONICS COMPANY,
DIVISION OF MATSUSHITA
ELECTRIC CORPORATION OF
AMERICA, One Panasonic Way
Secaucus, New Jersey 07094

PANASONIC SALES COMPANY,
DIVISION OF MATSUSHITA
ELECTRIC OF PUERTO RICO, INC.
Ave. 65 de Infanteria, Km. 9.5, San
Gabriel Industrial Park, Carolina,
Puerto Rico 00985

Panasonic Digital Still Camera Limited Warranty

Limited Warranty Coverage

If your product does not work properly because of a defect in materials or workmanship, Panasonic Consumer Electronics Company or Panasonic Sales Company (collectively referred to as "the warrantor") will, for the length of the period indicated on the chart below, which starts with the date of original purchase ("warranty period"), at its option either (a) repair your product with new or refurbished parts, or (b) replace it with a new or refurbished product. The decision to repair or replace will be made by the warrantor.

PRODUCT OR PART NAME	PARTS	LABOR
DIGITAL STILL CAMERA (EXCEPT ITEMS LISTED BELOW)	1 (ONE) YEAR	90 (NINETY) DAYS
CCD	6 (SIX) MONTHS	90 (NINETY) DAYS
RECHARGEABLE BATTERY PACK (IN EXCHANGE FOR DEFECTIVE BATTERY PACK)	90 (NINETY) DAYS	NOT APPLICABLE
SD MEMORY CARD (IN EXCHANGE FOR DEFECTIVE SD CARD)	90 (NINETY) DAYS	NOT APPLICABLE

During the "Labor" warranty period there will be no charge for labor. During the "Parts" warranty period, there will be no charge for parts. You must carry-in or mail-in your product during the warranty period. If non-rechargeable batteries are included, they are not warranted. This warranty only applies to products purchased and serviced in the United States or Puerto Rico. This warranty is extended only to the original purchaser of a new product which was not sold "as is". A purchase receipt or other proof of the original purchase date is required for warranty service.

Carry-In or Mail-In Service

For Carry-In or Mail-In Service in the United States call
1-800-272-7033.

For assistance in Puerto Rico call Panasonic Sales Company
(787)-750-4300 or fax (787)-768-2910.

This warranty ONLY COVERS failures due to defects in materials or workmanship, and DOES NOT COVER normal wear and tear or cosmetic damage. The warranty ALSO DOES NOT COVER damages which occurred in shipment, or failures which are caused by products not supplied by the warrantor, or failures which result from accidents, misuse, abuse, neglect, mishandling, misapplication, alteration, faulty installation, set-up adjustments, misadjustment of consumer controls, improper maintenance, power line surge, lightning damage, modification, or commercial use (such as in a hotel, office, restaurant, or other business), rental use of the product, service by anyone other than a Factory Servicenter or other Authorized Servicer, or damage that is attributable to acts of God.

THERE ARE NO EXPRESS WARRANTIES EXCEPT AS LISTED UNDER "LIMITED WARRANTY COVERAGE". THE WARRANTOR IS NOT LIABLE FOR INCIDENTAL OR CONSEQUENTIAL DAMAGES RESULTING FROM THE USE OF THIS PRODUCT, OR ARISING OUT OF ANY BREACH OF THIS WARRANTY. (As examples, this excludes damages for lost time, travel to and from the servicer, loss of media or images, data or other memory content. The items listed are not exclusive, but are for illustration only.) **ALL EXPRESS AND IMPLIED WARRANTIES, INCLUDING THE WARRANTY OF MERCHANTABILITY, ARE LIMITED TO THE PERIOD OF THE LIMITED WARRANTY.**

Some states do not allow the exclusion or limitation of incidental or consequential damages, or limitations on how long an implied warranty lasts, so the exclusions may not apply to you.

This warranty gives you specific legal rights and you may also have other rights which vary from state to state. If a problem with this product develops during or after the warranty period, you may contact your dealer or Servicenter. If the problem is not handled to your satisfaction, then write to the warrantor's Consumer Affairs Department at the addresses listed for the warrantor.

PARTS AND SERVICE WHICH ARE NOT COVERED BY THIS LIMITED WARRANTY ARE YOUR RESPONSIBILITY.

Customer Services Directory (For USA Only)

For Product Information, Operating Assistance, Literature Request, Dealer Locations, and all Customer Service inquiries please contact:

1-800-272-7033, Monday-Friday 8:30am-8pm EST.

Web Site: <http://www.panasonic.com/support>

You can purchase parts, accessories or locate your nearest servicer by visiting our Web Site.

Accessory Purchases:

Purchase Parts, Accessories and Instruction Books online for all Panasonic Products by visiting our Web Site at:

<http://www.pasc.panasonic.com>

or, send your request by E-mail to:

npcparts@panasonic.com

You may also contact us directly at:

1-800-332-5368 (Customer Orders Only)

Panasonic Services Company 20421 84th Avenue South, Kent, WA 98032

(6 am to 5 pm Monday - Friday; 6 am to 10:30 am Saturday; PST)

(Visa, MasterCard, Discover Card, American Express, Check)

Product Repairs

Centralized Factory Servicer

Panasonic Services Company

1705 N. Randall Road,

Elgin, IL 60123-7847

Attention: Digital Camera Repair

MAIL TO :

Please carefully pack and ship, prepaid and insured, to the Elgin Centralized Factory Servicer.

Customer's in Puerto Rico, please ship or carry in to location below ("Service in Puerto Rico").

Service in Puerto Rico

Matsushita Electric of Puerto Rico, Inc. Panasonic Sales Company/ Factory Servicer:

Ave. 65 de Infanteria, Km. 9.5, San Gabriel Industrial Park, Carolina, Puerto Rico 00985

Phone (787) 750-4300 Fax (787) 768-2910

As of November 2003

Index

A		F	
AF Assist Lamp	65	Fine	63
AF Mode	64	Fireworks Mode	56
AF/AE Lock	29	Flip Animation	67
Audio Dubbing	77	Focus	30
Audio Recording	63	Formatting	80
Auto Bracket	42	H	
Auto Review	21	HDTV	62, 82
Auto White Balance	60	Histogram	26
B		I	
Backlight Compensation	34	ISO Sensitivity	62
Brightness of the LCD Monitor	21	J	
Built-in Flash	37	Jitter	30
Burst Mode	44	L	
C		Language setting	23
Card	16	LCD Monitor	24, 91
Card Access Indication	16	M	
Charger	95	Macro Mode	50
Clock Set	18, 22	Motion Image Mode	51
Color Effect	66	Motion Rate	51
Condensation	95	Multi Playback	46
D		N	
Date Printing	73, 90	Night Portrait Mode	56
Deleting Pictures	48, 49	Night Scenery Mode	55
Digital Zoom	66	NO.RESET	22
DPOF Print Setting	72	NTSC	23
E		Number of recordable pictures	17
Economy Mode	22	O	
Exposure	30	Operational sound	22
Exposure Compensation	41	Optical Image Stabilizer	43
		Optical Zoom	36

<hr/> P <hr/>		<hr/> U <hr/>	
PAL	23	USB Connection Cable	83
Party Mode	57	USB Mode	23, 83
PC	85, 86	<hr/> V <hr/>	
PictBridge	86, 87	Video output	23
Picture Adjustment	66	<hr/> W <hr/>	
Picture Size	17, 62	White Balance	60
Playback	45	White Balance Fine Adjustment	61
Playback Pictures on TV	82	<hr/> Numerics <hr/>	
Playback Zoom	47	1-area-focusing	64
Playing Back Motion Images	70	3-area-focusing	64
Playing Back Pictures with Audio	70	9-area-focusing	64
Portrait Mode	54	<hr/>	
Power Save	21	<hr/>	
Protect	74	<hr/>	
<hr/> Q <hr/>		<hr/>	
Quality	63	<hr/>	
<hr/> R <hr/>		<hr/>	
Recording Guide Line	25	<hr/>	
Reset of setting	23	<hr/>	
Resizing	78	<hr/>	
Review	35	<hr/>	
Rotate	71	<hr/>	
<hr/> S <hr/>		<hr/>	
Scene Menu	23	<hr/>	
Scene Mode	53	<hr/>	
Scenery Mode	55	<hr/>	
SD Slide Show	76	<hr/>	
Setup Menu	20	<hr/>	
Simple Mode	32	<hr/>	
Slide Show	75	<hr/>	
Slow Shutter	65	<hr/>	
Snow Mode	57	<hr/>	
Sports Mode	54	<hr/>	
Spot-focusing	64	<hr/>	
Standard	63	<hr/>	
<hr/> T <hr/>		<hr/>	
Trimming	79	<hr/>	

Spanish Quick Use Guide/Guía española de uso rápido

Ésta es una visión de conjunto que trata del procedimiento para grabar las imágenes con esta cámara. Por lo que atañe a cada única operación, remitimos a las páginas correspondientes.

1 Cargue la batería.

- Cuando se envía la cámara, la batería no tiene carga alguna. Cárreguela antes del uso.

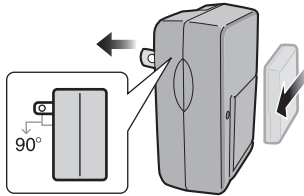

2 Inserte la batería y la tarjeta.

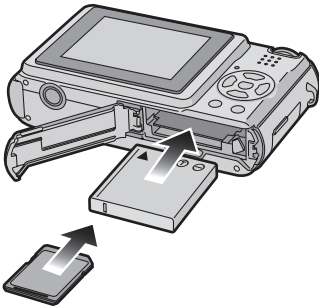

3 Encienda la cámara para sacar las imágenes.

- Ajuste el reloj.

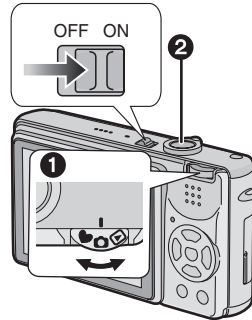

- 1 Ajuste el disco del modo a [📷].
- 2 Pulse el botón del obturador para sacar las imágenes.

4 Reproduzca las imágenes.

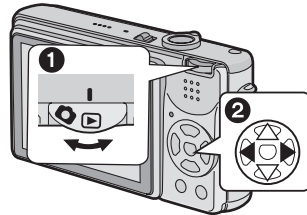

- 1 Ajuste el disco del modo a [▶].
- 2 Elija la imagen que quiere ver.

**Panasonic Consumer Electronics Company,
Division of Matsushita Electric Corporation of America**

One Panasonic Way, Secaucus, NJ 07094

**Panasonic Sales Company ("PSC")
Division of Matsushita Electric of Puerto Rico, Inc.**

Ave. 65 de Infanteria, Km. 9.5, San Gabriel Industrial Park, Carolina, Puerto Rico 00985

Panasonic Canada Inc.

5770 Ambler Drive, Mississauga, Ontario, L4W 2T3

© 2004 Matsushita Electric Industrial Co., Ltd.



VQT0M16
F0804Mk(3000 (A))

