

PalmCorder®
PalmSight™

Panasonic®



Camcorder
Operating Instructions

Models No. **PV-L501**
PV-L551
PV-L601
PV-L651

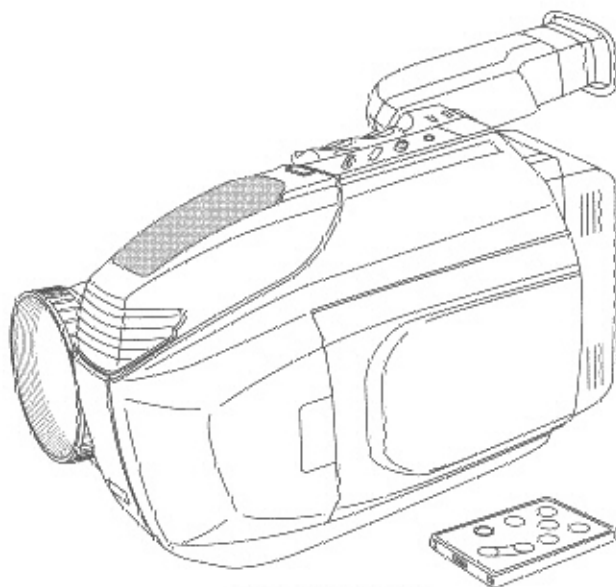

(PV-L651 shown)

Please read these instructions carefully before attempting to operate this product.
Please save this manual.

Guía para rápida consulta en español está incluida.

For assistance, please call : 1-800-211-PANA(7262) or
send e-mail to : consumerproducts@panasonic.com

LSQT0381A

Getting Started

Basic Operation

Special Features

For Your Information

Things You Should Know

Thank you for choosing Panasonic!

You have purchased one of the most sophisticated and reliable products on the market today. Used properly, it will bring you years of enjoyment. Please take time to fill in the information at the right.

The serial number is on the tag located on the rear side of your Camcorder. Be sure to **retain this manual** as your convenient Camcorder information source.

Date of Purchase

Dealer Purchased From

Dealer Address

Dealer Phone No.

Model No.

Serial No.

Unpack your Camcorder

These accessories are provided in order to set up or use your Camcorder.

1 pc. AC Adaptor (PV-A19) with DC Power Cable (page 10)

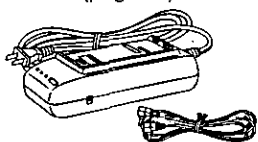

1 pc. VHS PlayPak (PV-P1/VYMW0009) and one "AA" battery (page 21)

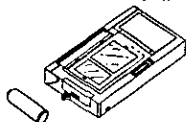

1 pc. CR2025 Clock Battery (VSBW0004) (installed in Camcorder) (page 35)



1 pc. Audio/Video Cable (LSJA0283) (pages 21, 22)



1 pc. Shoulder Strap (LSFC0012) (page 34)



1 pc. 8-Function Remote (VSQW0038) with one CR2025 Battery. (page 19) (PV-L651 only)

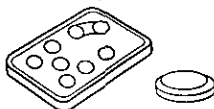

Remote has been loaded with battery. (page 35) (PV-L651 only)

1 pc. Battery Pack (pages 9, 10) (PV-BP18) (PV-L551/PV-L601/PV-651 only)



(PV-BP15) (PV-L501 only)



Battery Charging Confirmation Marker (PV-L501 only)



Use this marker as a reminder to yourself when the battery is fully charged or in need of a charge. This marker performs no function and is for your reference only.

This operating instruction book is designed for use with models **PV-L501, PV-L551, PV-L601, and PV-L651**. Illustrations in this manual show the **PV-L651**. Features may vary, so please read carefully.

Differences between models

Model Number	LCD Monitor	8-Function Remote Control	Built-in Auto Light	Battery Pack	Electronic Viewfinder
PV-L501	63.5 mm (2.5 inch) Liquid Crystal Display	Not supplied	Not supplied	PV-BP15	10.2 mm (0.4 inch) Electronic Viewfinder
PV-L551	63.5 mm (2.5 inch) Liquid Crystal Display	Not supplied	Supplied	PV-BP18	11 mm (0.45 inch)/14 mm (0.55 inch) Liqui Crystal Color Electronic Viewfinder
PV-L601	76.2 mm (3.0 inch) Liquid Crystal Display	Not supplied	Supplied	PV-BP18	11 mm (0.45 inch)/14 mm (0.55 inch) Liqui Crystal Color Electronic Viewfinder
PV-L651	101.6 mm (4.0 inch) Liquid Crystal Display	Supplied	Supplied	PV-BP18	11 mm (0.45 inch)/14 mm (0.55 inch) Liqui Crystal Color Electronic Viewfinder

Things You Should Know





Safety Precautions

WARNING : TO PREVENT FIRE OR SHOCK HAZARD, DO NOT EXPOSE THIS EQUIPMENT TO RAIN OR MOISTURE.

Your Compact VHS Camcorder is designed to record and play back in Standard Play (SP) and Super Long Play (SLP) modes. You can also play a Compact VHS Camcorder recording on your VHS VCR using the VHS PlayPak supplied.

This Camcorder is equipped with the **HQ** System to provide excellent video pictures, and is compatible with standard VHS equipment.

It is recommended that only cassette tapes that have been tested and inspected for use in VCR machines with the **VHS** and/or **VHS** mark be used.

	CAUTION RISK OF ELECTRIC SHOCK DO NOT OPEN			This symbol warns the user that uninsulated voltage within the unit may have sufficient magnitude to cause electric shock. Therefore, it is dangerous to make any kind of contact with any inside part of this unit.
CAUTION: TO REDUCE THE RISK OF ELECTRIC SHOCK, DO NOT REMOVE COVER (OR BACK) NO USER-SERVICEABLE PARTS INSIDE REFER SERVICING TO QUALIFIED SERVICE PERSONNEL.				This symbol alerts the user that important literature concerning the operation and maintenance of this unit has been included. Therefore, it should be read carefully in order to avoid any problems.

The above markings are located on the appliance's bottom cover.

FCC Warning: Any unauthorized changes or modifications to this equipment would void the user's authority to operate.

This device complies with Part 15 of the FCC Rules. Operation is subject to the following two conditions: (1) This device may not cause harmful interference, and (2) this device must accept any interference received, including interference that may cause undesired operation.

Note: This equipment has been tested and found to comply with Part 15 and part 18 of the FCC Rules. These limits are designed to provide reasonable protection against harmful interference when operated in a residential environment.

If this equipment does cause interference to radio or television reception, which can be determined by turning the equipment off and on, use the equipment in another location and/or utilize an electrical outlet different from that used by the receiver.

If necessary, consult the dealer or an experienced radio/TV technician for help. You may find the booklet, 'Something About Interference' available from FCC local regional offices helpful.

This product may cause interference to radio equipment and should not be installed near maritime safety communications equipment or other critical navigation or communication equipment operating between 0.45-30 MHz.

Important Safeguards

- 1. Read Instructions** – All the safety and operating instructions should be read before the unit is operated.
- 2. Retain Instructions** – The safety and operating instructions should be retained for future reference.
- 3. Heed Warnings** – All warnings on the unit and in the operating instructions should be adhered to.
- 4. Follow Instructions** – All operating and maintenance instructions should be followed.
- 5. Cleaning** – Unplug this video unit from the wall outlet before cleaning. Do not use liquid or aerosol cleaners. Use a dry cloth for cleaning.
- 6. Attachments** – Do not use attachments not recommended by the video product manufacturer as they may be hazardous.
- 7. Water and Moisture** – Do not use this video unit near water – for example near a bath tub, wash bowl, kitchen sink, or laundry tub, in a wet basement, or near a swimming pool, and the like.
- 8. Accessories** – Do not place this video unit on an unstable cart, stand, tripod, bracket, or table. The video unit may fall, causing serious injury to a child or adult, and serious damage to the unit. Use only with a cart, stand, tripod, bracket, or table recommended by the manufacturer, or sold with the video unit. Any mounting of the unit should follow the manufacturer's instructions and should use a mounting accessory recommended by the manufacturer. An appliance and cart combination should be moved with care. Quick stops, excessive force, and uneven surfaces may cause the appliance and cart combination to overturn.
- 9. Ventilation** – Slots and openings in the cabinet are provided for ventilation and to ensure reliable operation of the video unit and to protect it from overheating. These openings must not be blocked or covered. Never place the video unit on a bed, sofa, rug, or other similar surface, or near or over a radiator or heat register. This video unit should not be placed in a built-in installation such as a bookcase or rack unless proper ventilation is provided or the manufacturer's instructions have been adhered to.
- 10. Power Sources** – This video unit should be operated only from the type of power source indicated on the marking label. If you are not sure of the type of power supply to your home, consult your appliance dealer or local power company. For video units intended to be operated from battery power, or other sources, refer to the operating instructions.
- 11. Grounding or Polarization** – This video unit may be equipped with either a polarized 2-wire AC (Alternating Current) line plug (a plug having one blade wider than the other) or 3-wire grounding type plug, a plug having a third (grounding) pin.

The 2-wire polarized plug will fit into the power outlet only one way. This is a safety feature. If you are unable to insert the plug fully into the outlet, try reversing the plug. If the plug still fails to fit, contact your electrician to replace your obsolete outlet. Do not defeat the safety purpose of the polarized plug.

The 3-wire grounding type plug will fit into a grounding type power outlet. This is a safety feature. If you are unable to insert the plug into the outlet, contact your electrician to replace your obsolete outlet. Do not defeat the safety purpose of the grounding type plug.
- 12. Power-Cord Protection** – Power-supply cords should be routed so that they are not likely to be walked on or pinched by items placed upon or against them. Paying particular attention to cords of plugs, convenience receptacles, and the point where they exit from the unit.
- 13. Outdoor Antenna Grounding** – If an outside antenna or cable system is connected to the video unit, be sure the antenna or cable system is grounded so as to provide some protection against voltage surges and built-up static charges. Part 1 of the Canadian Electrical Code, in USA Section 810 of the National Electrical Code, provides information with respect to proper grounding of the mast and supporting structure, grounding of the lead-in wire to an antenna discharge unit, size of grounding conductors, location of antenna discharge unit, connection to grounding electrodes, and requirements for the grounding electrode.

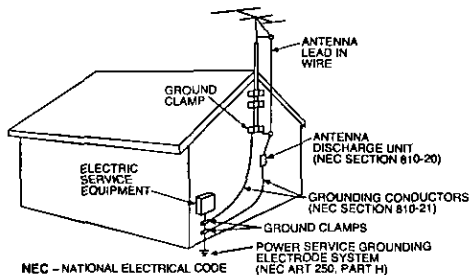

- 14. Lightning** – For added protection of this video unit receiver during a lightning storm, or when it is left unattended and unused for long periods of time, unplug it from the wall outlet and disconnect the antenna or cable system. This will prevent damage to the video unit due to lightning and power-line surges.

Important Safeguards

15. **Power Lines** – An outside antenna system should not be located in the vicinity of overhead power lines or other electric light or power circuits, or where it can fall into such power lines or circuits. When installing an outside antenna system, extreme care should be taken to keep from touching such power lines or circuits as contact with them might be fatal.
16. **Overloading** – Do not overload wall outlets and extension cords as this can result in a risk of fire or electric shock.
17. **Objects and Liquids** – Never push objects of any kind into this video unit through openings as they may touch dangerous voltage points or short out parts that could result in a fire or electric shock. Never spill liquid of any kind onto the video unit.
18. **Servicing** – Do not attempt to service this video unit yourself as opening or removing covers may expose you to dangerous voltage or other hazards. Refer all servicing to qualified service personnel.
19. **Damage Requiring Service** – Unplug this video unit from the wall outlet and refer servicing to qualified service personnel under the following conditions:
 - a. When the power-supply cord or plug is damaged.
 - b. If any liquid has been spilled into, or objects have fallen onto, the video unit.
 - c. If the video unit has been exposed to rain or water.
 - d. If the video unit does not operate normally by following the operating instructions. Adjust only those controls that are covered by the operating instructions, as an improper adjustment of other controls may result in damage and will often require extensive work by a qualified technician to restore the video unit to its normal operation.
 - e. If the video unit has been dropped or the cabinet has been damaged.
 - f. When the video unit exhibits a distinct change in performance – this indicates a need for service.
20. **Replacement Parts** – When replacement parts are required, be sure the service technician has used replacement parts specified by the manufacturer or have the same characteristics as the original part. Unauthorized substitutions may result in fire, electric shock or other hazards.
21. **Safety Check** – Upon completion of any service or repairs to this video unit, ask the service technician to perform safety checks to determine that the video unit is in safe operating order.

Precautions

USE & LOCATION

- **TO AVOID SHOCK HAZARD ...** Your Camcorder and power supply should not be exposed to rain or moisture. Do not connect the power supply or operate your Camcorder if it gets wet. Your Camcorder has been designed for outdoor use, however it is not designed to sustain direct exposure to water, rain, sleet, snow, sand, dust, or a direct splashing from a pool or even a cup of coffee. This action could permanently damage the internal parts of your Camcorder. Do not attempt to disassemble this unit. There are no user serviceable parts inside. Unplug your Camcorder from the power supply before cleaning.
- **DO NOT AIM YOUR CAMCORDER AT THE SUN OR OTHER BRIGHT OBJECTS.**
- **DO NOT LEAVE THE CAMCORDER WITH THE EVF AIMED DIRECTLY AT THE SUN AS THIS MAY CAUSE DAMAGE TO THE INTERNAL PARTS OF THE EVF.**
- **DO NOT EXPOSE YOUR CAMCORDER TO EXTENDED HIGH TEMPERATURE ...** Such as, in direct sunlight, inside a closed car, next to a heater, etc... This action could permanently damage the internal parts of your Camcorder.
- **AVOID SUDDEN CHANGES IN TEMPERATURE ...** If the unit is suddenly moved from a cold place to a warm place, moisture may form on the tape and inside the unit.
- **DO NOT LEAVE YOUR CAMCORDER OR THE POWER SUPPLY TURNED ON WHEN NOT IN USE.**
- **STORAGE OF YOUR CAMCORDER ...** Store and handle your Camcorder in a manner that will not subject it to unnecessary movement (avoid shaking and striking). Your Camcorder contains a sensitive pick-up device which could be damaged by improper handling or storage.

CARE

- **TO CLEAN YOUR CAMCORDER ...** Do not use strong or abrasive detergents when cleaning your Camcorder body.
- **TO PROTECT THE LENS ...** Do not touch the surface of the lens with your hand. Use a commercial camcorder lens solution and lens paper when cleaning the lens. Improper cleaning can scratch the lens coating.
- **TO PROTECT THE FINISH OF YOUR CAMCORDER ...** Before handling your Camcorder, make sure your hands and face are free from any chemical products, such as suntan lotion, as it may damage the finish.

Table of Contents

Getting Started

Things You Should Know	2~3
Important Safeguards	4~5
Precautions	5
Self Demo Mode	7
Quick Operation Guide	8
Supplying Power (Battery Charge/Use/Refresh/Care, AC Adaptor, Car Battery Cord) ...	9~10
Cassette Information	11
Using MENU Mode	12
Setting the Clock (Time Zone, Auto Daylight Saving Time)	13~14
Built-in Auto Light (PV-L551/PV-L601/PV-L651 only) (Using the Light)	15

Basic Operation

Camera Recording (Basic, Stand-by, Programmed Recording)	16~18
8-Function Remote Control (PV-L651 only)	19
Playing Back Recordings (Basic Playback, Visual Search, Still Picture, Tracking, TV/VCR Playback)	20~21
Copying your Tapes (dubbing)	22

Special Features

Four-Speed Power Zoom	23
Backlight	23
Focus (Auto/Manual Focus)	24
High Speed Shutter (Auto/Manual Shutter)	25
Auto Fade	26
Color Digital Fade	27
Digital Zoom	28
Digital Electronic Image Stabilization (EIS)	28
Security Mode	29
Intelligent Titler (Auto/Manual Title, Phrase Title)	30~31

For Your Information

Viewfinder/LCD Monitor Indications	32~33
Operation Notes (Using the Shoulder and Hand Straps, Cleaning EVF)	34
Replacing Clock/Remote Battery	35
Palmcorder Accessory System	36
Palmcorder Accessory Order Form	37
Specifications	38
Before Requesting Service (Video Head Cleaning)	39
Request for Service Notice	40
Limited Warranty	41
Servicenter List	42
Spanish Quick Use Guide/Guía Para Uso Rápido	43
Index	44

Self Demo Mode

Self Demo mode is on when the screen below appears. To turn it off, follow steps 1-4 below.

EVF or LCD Monitor

Panasonic

ITS TAPES PLAY
IN YOUR VCR
YES, IT'S VHS!

20x LENS / 150x D.ZOOM
DIGITAL STABILIZATION
FULL-SIZE HEAD SYSTEM
AUTO/PHRASE TITLER

Before you begin...

- Connect Camcorder to power source.

1 Set **POWER** to **CAMERA**.

2 Press **MENU** for **MENU** mode.
Press **UP ▲** or **DOWN ▼** to select **SELF DEMO**.

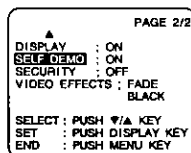

3 Press **DISPLAY** to select OFF.

4 Press **MENU** to exit.

Note:

- Self Demo stops automatically if battery is attached (page 9) and cassette tape is inserted (page 11).
- Inserting a tape alone (or attaching a partially charged battery) only temporarily stops Self Demo.
- Self Demo stops for 30 seconds when a function key other than Light, Play, Rewind Search, Fast Forward Search, Stop, and Still is pressed.

To turn Self Demo back on:

- Set to SELF DEMO : ON in MENU screen.

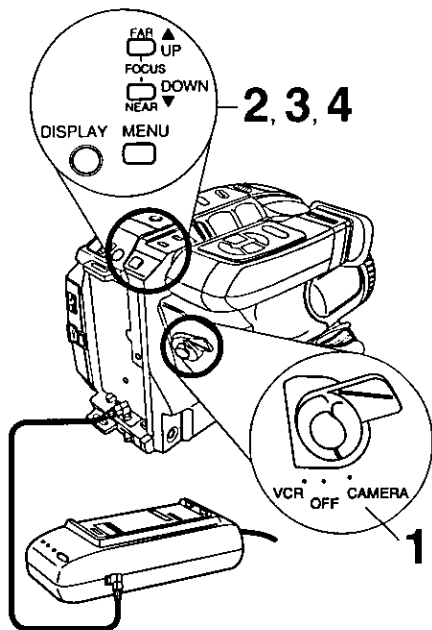

Quick Operation Guide

Charging the Battery Pack

Charge Battery Pack fully before operation (page 9).

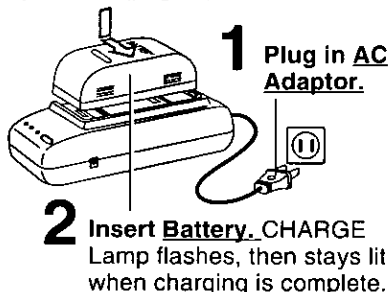

Insert Cassette

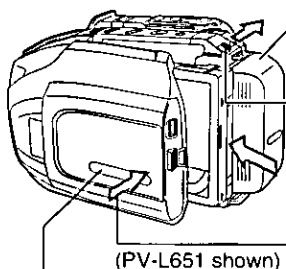

Protection Film

Note:

- Remove the Protection Film before use.

- 1** Attach fully charged **Battery** (page 9).
- 2** Slide **TAPE EJECT** to open door.
- 3** Insert **cassette** (page 11).
- 4** Press here to close door.

Camera Recording

When the LCD monitor is open, the EVF automatically turns OFF (page 16).

- 1** Press **LCD-OPEN** to unlock the LCD monitor. Swing it fully open and adjust the angle.

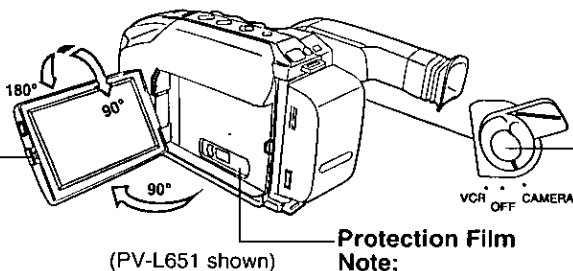

Playback using the LCD Monitor

When the LCD monitor is open, the EVF automatically turns OFF (page 20).

- 1** Press **LCD-OPEN** to unlock the LCD monitor. Swing it fully open and adjust the angle (see above).



- 2** Set **POWER** to **VCR**.

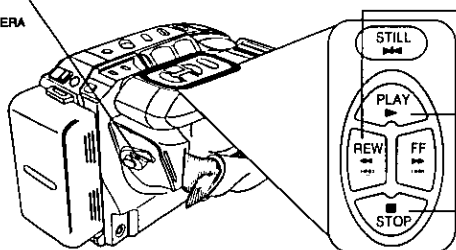

- 3** Press **REWIND/SEARCH** to rewind tape.
- 4** Press **PLAY** to start playback.
- 5** Press **STOP** to stop playback.

Supplying Power

Charging the Battery Pack

Charge Battery Pack fully before use.

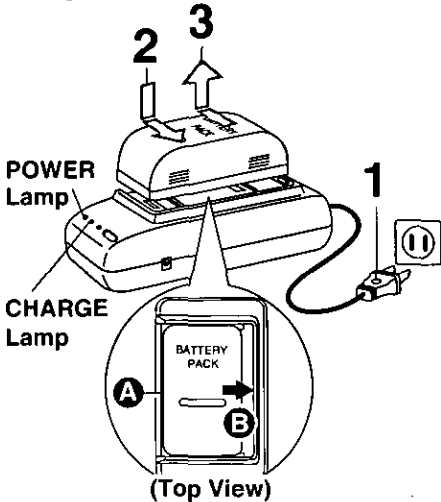

1 Plug in **AC Adaptor**.
POWER Lamp lights.

2 Insert **Battery**.
A Align left side of Battery with left edge of AC Adaptor.
B Press Battery down and slide in direction of arrow.
The CHARGE Lamp flashes, then stays lit when charging is complete.

3 Remove **Battery**.
Slide Battery to the left and lift off.

Note:

- Charging takes about 1 hour (PV-L501) or 1 and 1/2 hours (PV-L551/PV-L601/PV-L651).
- While the DC Power Cable (supplied) is connected to the AC Adaptor, the Battery cannot be charged.
- After charging 5 times, use Battery Refresh feature as explained below.
- Battery life gradually decreases after repeated use and recharging. If operation time becomes very short even after a sufficient charge, discard Battery properly (page 10).

Using the Battery Pack

A fully charged Battery provides a maximum of about 1 hour 10 minutes (PV-L501) or 2 hours (PV-L551/PV-L601/PV-L651) of continuous use (LCD monitor off) or about 55 minutes (PV-L501) or 1.5 hours (PV-L551/PV-L601/PV-L651) (LCD monitor on). Actual time may vary due to operating conditions. Using the Built-in Light decreases operating time (PV-L551/PV-L601/PV-L651 only).

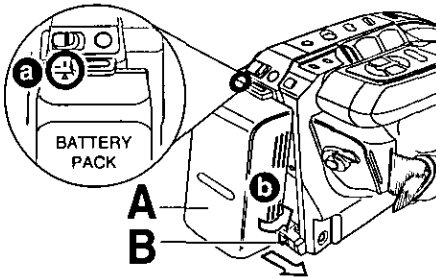

A Attach **Battery**.
a Insert top of Battery into top of mounting surface.
b Press and snap into place.

B Remove **Battery**.
Slide **BATTERY RELEASE** and remove Battery.

Battery Refresh

This feature completely discharges Battery before recharging begins. Use after every 5 charges for optimum Battery performance.

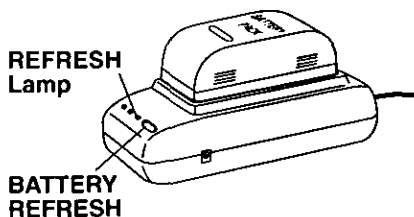

To use battery refresh, insert Battery on AC Adaptor (see steps 1-2 above), then press **BATTERY REFRESH**.

The REFRESH Lamp lights, then goes out when discharge is complete. Battery charging will then start automatically.

If **BATTERY REFRESH** is pressed by mistake, remove Battery from AC Adaptor and reinsert it for normal charging.

Note:

- Charging takes about 5 hours (PV-L501) or 7 and 1/2 hours (PV-L551/PV-L601/PV-L651) when Battery Refresh is used.
- Battery will not operate in extremely high temperatures.

Supplying Power

Battery Care

Caution:

- Charge only with specified charger.
- Battery can be charged within a temperature range of 10 °C (50 °F) and 35 °C (95 °F).
- Battery is normally warm after charging or just after use.
- Do not use an insufficiently charged or worn-out Battery.

Safety precautions:

- Do not get Battery near, or dispose of in fire.
- Do not directly connect (short circuit) the positive (+) and negative (-) terminals.
- Never attempt to disassemble or reassemble Battery.

To avoid Battery damage:

- Do not drop or jar Battery.
- Use Battery with specified units only.
- If Battery is used in extremely high temperatures, a safety device will automatically prevent operation.

To prolong Battery life:

- While not in use, remove Battery from the Camcorder and AC Adaptor and store in a cool, dark, dry place.
- Keep Battery terminals clean.

U.S.A. CONSUMERS: ATTENTION:



The product you have purchased is powered by a nickel cadmium battery which is recyclable. At the end of its useful life, under various state and local laws, it is illegal to dispose of this battery into your municipal waste stream. Please call 1-800-8-BATTERY for information on how to recycle this battery.

AC Adaptor

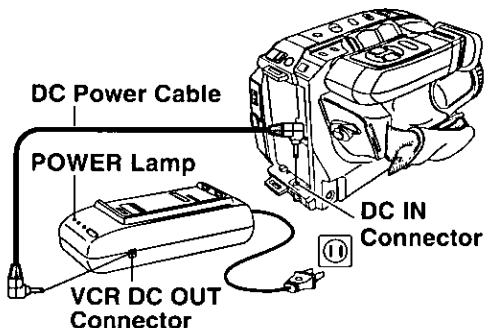

1 Connect **AC Adaptor VCR DC OUT** to **Camcorder DC IN** with supplied DC Power Cable.

2 Plug in AC Adaptor. POWER Lamp lights.

Note:

- While the DC Power Cable (supplied) is connected to the AC Adaptor, the Battery cannot be charged.
- When not in use, unplug AC Adaptor from AC outlet. (Adaptor uses 1.2 W of electricity while plugged in.)

CAUTION:

This unit will operate on 110/120/220/240 V AC. An AC plug adaptor may be required for voltages other than 120 V AC. Please contact either a local or foreign electrical parts distributor for assistance in selecting an alternate AC plug. We recommend using the accessory power plug adaptor (VJSS0070) in an area which has special AC outlets.

Car Battery Cord (Optional)

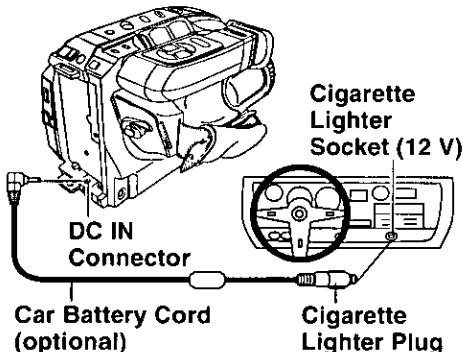

1 Connect **PV-C16 Car Battery Cord (optional)** to **Camcorder DC IN**.

2 **A** Start engine first.
B Plug Car Battery Cord into Cigarette lighter socket.

- If Car Battery cord fuse needs replacing, use exact current rating (in amps).

Note:

- This cord only works in vehicles equipped with **DC 12 V (negative ground)** battery. Check with your car/truck dealer. Use only specified car battery cord.
- To avoid blowing the car battery cord fuse, do step 2 in the proper order.
- Running vehicles must be well ventilated.
- When not in use, disconnect cigarette lighter plug.

Cassette Information

Cassette Insertion/Removal

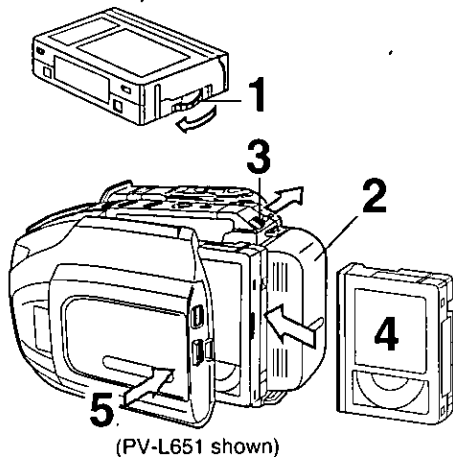

- 1 Turn **Tape Wheel** in direction of arrow until there is no slack.
- 2 Attach **Battery** (page 9).
- 3 Slide **TAPE EJECT** to open door.
- 4 Insert **cassette** as shown.
- 5 Press here to close door.

- To remove the cassette, slide the **TAPE EJECT** switch.

Record/Playback Time

Use tapes with the **VHS** mark in this unit.

Tape Speed Selector Position	Cassette type		
	TC-20	TC-30	TC-40
SP (Standard Play)	20 minutes	30 minutes	40 minutes
SLP (Super Long Play)	1 hour	1 hour 30 minutes	2 hours

- SLP playback may contain more picture noise.

Erase Protection Tab

Protects tapes from being accidentally erased.

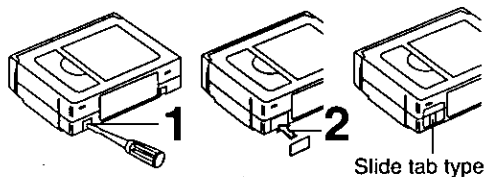

- 1 To prevent accidental erasing, break off tab with screwdriver.
(Or, slide tab open.)
- 2 To record again, cover hole with adhesive tape.
(Or, slide tab closed.)

Using MENU Mode

Before you begin...

- Connect Camcorder to power source.
- Set POWER to CAMERA or VCR.

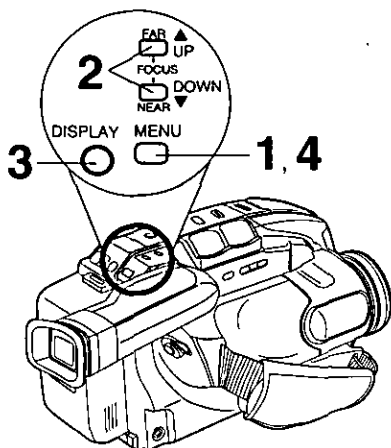

- 1** Press **MENU** for MENU mode.
The CAMERA or VCR MENU screen (see below left) appears when Menu mode is entered.
- 2** Press **UP ▲** or **DOWN ▼** to highlight the desired menu item.
- 3** Press **DISPLAY** to set selection.
- 4** Press **MENU** to exit.

Note:

- The Menu mode is canceled if **UP/DOWN(▲/▼)**, **DISPLAY**, or **MENU** are not pressed within 5 minutes when Self Demo mode is off.
- The Menu mode is canceled if **UP/DOWN(▲/▼)**, **DISPLAY**, or **MENU** are not pressed within 30 seconds when Self Demo mode is on.

MENU Mode (CAMERA) Screen

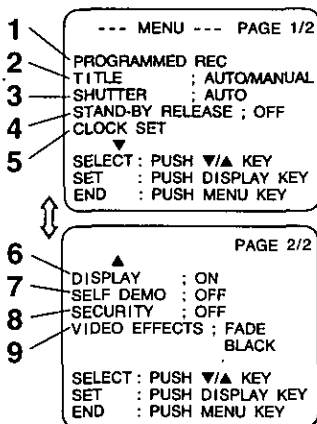

- 1 PROGRAMMED REC** (page 18).
Camcorder starts and stops recording at a preset time.
- 2 TITLE** (pages 30, 31).
AUTO/MANUAL : 16 items
PHRASE : 10 items
- 3 SHUTTER** (page 25).
Select desired shutter speed.
- 4 STAND-BY RELEASE** (page 17).
ON: Enables quick resumption of recording from Stand-by mode.
- 5 CLOCK SET** (pages 13, 14).
Select to set clock.
- 6 DISPLAY** (page 32).
ON: On-screen Display (OSD) screens are displayed.

MENU Mode (VCR) Screen

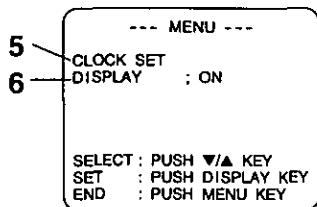

- 7 SELF DEMO** (page 7).
ON: SELF DEMO screen is displayed.
- 8 SECURITY** (page 29).
ON: Enables Motion Security recording.
- 9 VIDEO EFFECTS** (pages 26, 27).
AUTO FADE : BLACK or WHITE
DIGITAL FADE : TYPE → 7 types
COLOR → 8 colors

Setting the Clock

Set the following items in order: Time Zone, Daylight Saving Time, Date, and Time.

Before you begin...

- Connect Camcorder to power source.
- Set POWER to CAMERA or VCR.

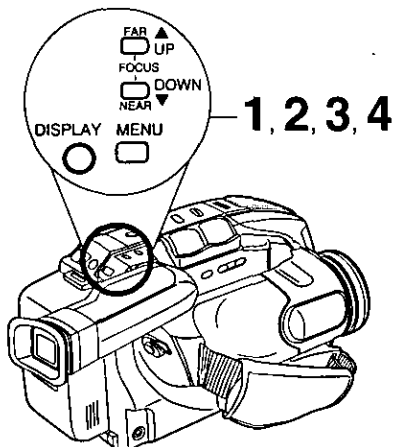

- 1** Press **MENU** for MENU mode.
Press **UP ▲** or **DOWN ▼** to select **CLOCK SET**.

```
--- MENU --- PAGE 1/2
PROGRAMMED REC
TITLE      : AUTOMANUAL
SHUTTER    : AUTO
STAND-BY RELEASE : OFF
CLOCK SET
▼
SELECT : PUSH ▼/▲ KEY
SET     : PUSH DISPLAY KEY
END     : PUSH MENU KEY
```

[CAMERA MODE]

```
--- MENU ---
CLOCK SET
DISPLAY : ON
▼
SELECT : PUSH ▼/▲ KEY
SET     : PUSH DISPLAY KEY
END     : PUSH MENU KEY
```

[VCR MODE]

- 2** Press **DISPLAY** for **CLOCK SET** menu.
Press **UP ▲** or **DOWN ▼** to select **TIME ZONE**, **DST**, or **DATE/TIME**.

```
--- CLOCK SET ---
TIME ZONE : EASTERN
D.S.T.     : AUTO
DATE/TIME  : 12:00:00AM
              JAN 1 2001
▼
SELECT : PUSH ▼/▲ KEY
SET     : PUSH DISPLAY KEY
END     : PUSH MENU KEY
```

- 3** Press **DISPLAY** for menu of item selected in step 2.

To change the setting:

TIME ZONE → Go to step 3a on page 14.

D.S.T. → Go to step 3b on page 14.

DATE/TIME → Go to step 3c on page 14.

- 4** Press **MENU** twice to exit.

(continued on next page)

Setting the Clock (continued)

3a Setting the Time Zone

The Camcorder is preset to Eastern time.

[Time Zone chart]

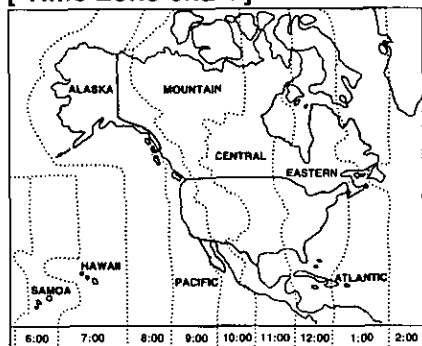

Press **UP ▲** or **DOWN ▼** to select local time zone.
Press **DISPLAY** to confirm entry.

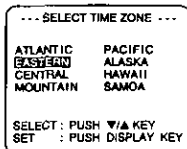

- When traveling, repeat this operation and select one of the 8 listed time zones to set the clock to local time.

Note :

- Clock may lose or gain up to 2 minutes per month.
- When traveling outside the listed time zones, set clock to local time manually.
- To adjust or set clock, see "Setting Date and Time" bottom of page.

3b Auto Daylight Saving Time

Clock will auto-adjust to daylight saving time (DST).

DST: AUTO

Spring (First Sunday in April) :
ahead one hour.

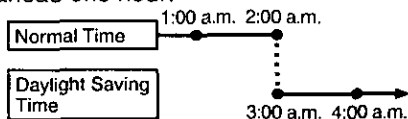

Autumn (Last Sunday in October) :
back one hour.

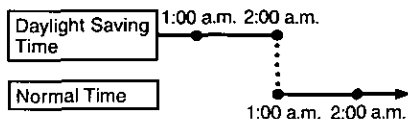

The Camcorder is preset to DST: **AUTO**.
If DST is not observed in your area, set to **OFF** by doing the following.

Press **UP ▲** or **DOWN ▼** to select OFF or AUTO.
Press **DISPLAY** to confirm entry.

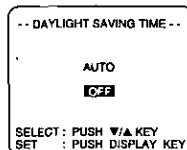

Note:

- Auto DST does not function if time zone is set to Hawaii or Samoa (see "Setting the Time Zone" above).

3c Setting Date and Time

Date and time including leap year are calculated up to DEC 31, 2099.

EXAMPLE :

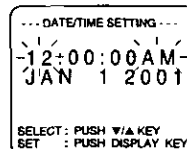
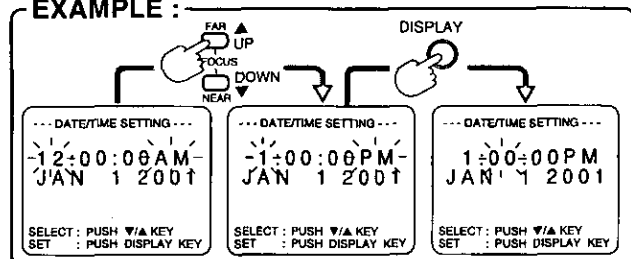

Press or hold down **UP ▲** or **DOWN ▼** to select hour, then press **DISPLAY** to fix.

Repeat for minute, month, day, and year.

Clock starts when year is entered and **DISPLAY** is pressed.

Built-in Auto Light (PV-L551/PV-L601/PV-L651 only)

Using the Light

For recording in dim lighting.

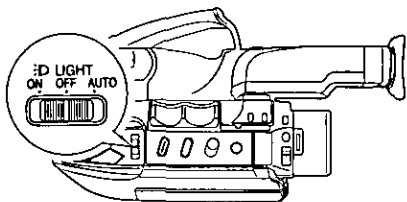

Note:

- Using Light reduces battery operating time.
- Provide proper ventilation when using Light extensively in a hot environment.
- Using Light when the Camcorder is powered by a car battery may shorten bulb life.
- Set Light to OFF when not in use.

Before you begin...

- Connect Camcorder to power source.
- Set POWER to CAMERA.

Set LIGHT to AUTO.

Light turns on/off automatically according to lighting conditions.

Or, set LIGHT to ON/OFF manually.

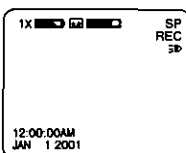

ID appears in EVF or LCD monitor when Light is on.

Caution:

Light becomes hot. Never cover Light while on.

Replacing the Bulb

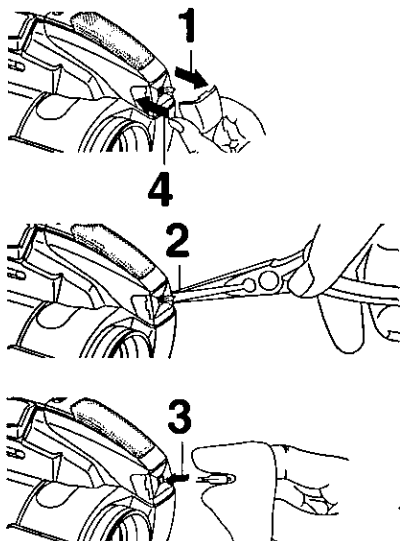

Before you begin...

- Order Part No. VULL0001 (VLLW0015 and cushions) for replacement bulb unit.
- Set POWER to OFF.

- 1 Press in on both sides of lens cover and pull straight out and off.
- 2 Using Tweezers or needle-nose pliers, carefully remove bulb.
 - Take unit to service center if you need assistance.
- 3 Replace bulb using a clean cloth or tissue. (Do not touch with fingers.)
- 4 Replace lens cover.

Note:

- Handle bulb gently. Excessive force may cause bulb to crack.

DANGER:

Use only replacement bulb (PART NO. VLLW0015) supplied by Panasonic to reduce risk of fire.

Handle new bulb with cloth or tissue as skin oils will decrease bulb life.

Remove lens cover and allow bulb to cool before replacing to avoid possible burn hazard.

Camera Recording

Recording via EVF or LCD Monitor

View recording scene on EVF (Electronic Viewfinder) or LCD (Liquid Crystal Display) monitor.

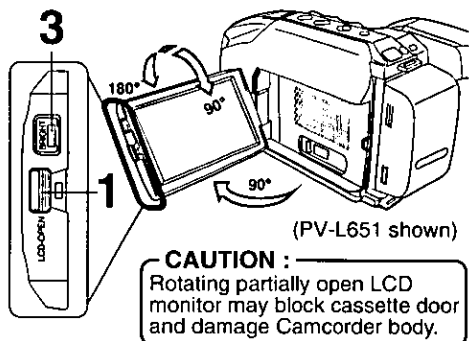

3 VISION ADJUSTMENT

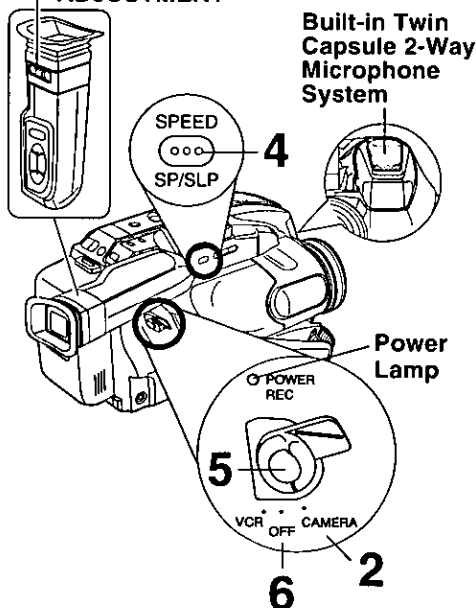

Note:

- When Camcorder is aimed at excessively bright objects, or bright lights, a vertical bar may appear in the picture. This is normal for the CCD pick-up. Try to avoid this when possible.
- Using LCD monitor reduces battery operation time. Return LCD monitor to locked position when not in use.

Before you begin...

- Connect Camcorder to power source.
- Insert cassette with record tab (page 11).

1 Press **LCD-OPEN** to unlock the LCD monitor. **Swing LCD monitor fully open and adjust viewing angle.**

- If you want to record using EVF, close and lock LCD monitor.

2 Set **POWER** to **CAMERA**.

Lens Cover opens.
Power Lamp lights.

- Be sure **POWER** is fully turned to **CAMERA** position.
- EVF or LCD monitor turns on/off by the **POWER** switch.
- EVF shuts off when LCD monitor is opened and turns back on when LCD is closed.
- Both EVF and LCD monitor turn on when LCD is at 180° (see above left). This allows both you and the subject to view the recording.

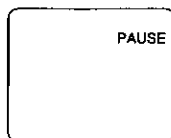

EVF or LCD Monitor
(Record/Pause mode)

3 **LCD** : Turn **BRIGHT** control to **monitor** adjust LCD monitor brightness level.

EVF : Look into **EVF** and adjust **VISION ADJUSTMENT** to your eyesight.

4 Hold down **TAPE SPEED** for about 1 second to change tape speed to **SP/SLP** (page 11).

5 Press **RECORD/PAUSE** to start or pause recording.

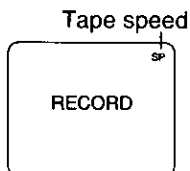

6 Set **POWER** to **OFF** when finished. **EVF or LCD Monitor** (Record mode)

- To remove the cassette, slide the **TAPE EJECT** switch (page 11).

WARNING (PV-L551/PV-L601/PV-L651 only):

- Do not leave the camcorder with the EVF aimed directly at the sun. This may cause damage to the internal parts of the EVF.

Camera Recording

Before you begin...

- Connect Camcorder to power source.
- Insert cassette with record tab (page 11).

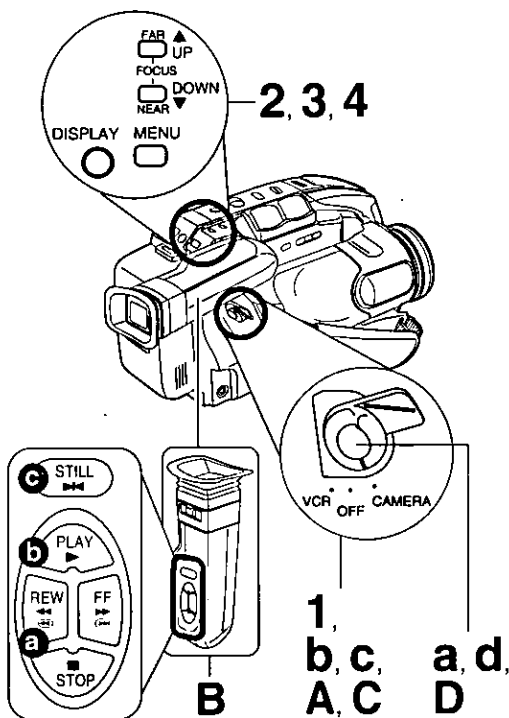

Stand-by Quick Release

If left in RECORD/PAUSE mode for 5 minutes, Camcorder switches to Stand-by mode to conserve battery. When set to ON, Stand-by Quick Release lets you resume recording by pressing RECORD/PAUSE two times. Stand-By Quick Release is set to OFF at the factory.

1 Set POWER to CAMERA.

2 Press MENU for MENU mode.

Press UP ▲ or DOWN ▼ to select

STAND-BY RELEASE.

--- MENU --- PAGE 1/2
PROGRAMMED REC
TITLE : AUTOMANUAL
SHUTTER : AUTO
STAND-BY RELEASE : OFF
CLOCK SET
▼
SELECT : PUSH ▲/▼ KEY
SET : PUSH DISPLAY KEY
END : PUSH MENU KEY

3 Press DISPLAY to select ON/OFF.

ON : From Stand-by mode, press RECORD/PAUSE two times to resume recording.

OFF : From Stand-by mode, set POWER to OFF, then to CAMERA. Press RECORD/PAUSE to record.

4 Press MENU to exit.

Basic Operation

Manual Easy Editing

For proper continuity when taping from Stop mode or after attaching a new Battery.

A Set POWER to VCR.

B **a** Press REWIND/SEARCH to rewind a few seconds of tape.

b Press PLAY to review recording.

c Press STILL where you want to continue recording.

C Set POWER to CAMERA.

D Press RECORD/PAUSE to resume recording.

Easy Edit Stand-by

For a smooth transition between scenes if recording is stopped, and then started within 24 hours.

a Press RECORD/PAUSE to stop recording.

b Set POWER to OFF and leave cassette in Camcorder.

C To resume recording, set POWER to CAMERA.

d Press RECORD/PAUSE to resume recording.

Note:

- Use Manual Easy Edit (left) if more than 24 hours before recording is resumed.

Camera Recording

Programmed Recording

Set a recording start and stop time. Or, set a 5 or 10 second interval recording to be done each minute.

Before you begin...

- Connect Camcorder to power source.
Use AC Adaptor for longer recordings.
- Insert cassette with record tab (page 11).
- Set POWER to CAMERA.

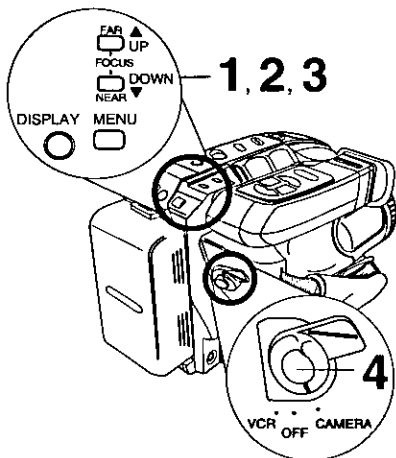

REC TIME : _____

→ 10MIN. → 20MIN. → 30MIN. →
INTERVAL*2 ← INTERVAL*1 ← TO TAPE →
10 SEC./MIN. ← 5 SEC./MIN. ← END

- *1 Record 5 seconds each minute.
- *2 Record 10 seconds each minute.

1 Press **MENU** for **MENU** mode. Press **UP ▲** or **DOWN ▼** to select **PROGRAMMED REC.**

```
--- MENU --- PAGE 1/2
PROGRAMMED REC
TITLE      : AUTOMANUAL
SHUTTER    : AUTO
STAND-BY RELEASE : OFF
CLOCK SET
SELECT : PUSH ▼/▲ KEY
SET     : PUSH DISPLAY KEY
END     : PUSH MENU KEY
```

2 Press **DISPLAY**.
(Current time is displayed.)
Each additional press of **DISPLAY** increases start time by 30 minutes.

```
START : 10:20PM
REC TIME : 10MIN.
SELECT : PUSH ▼/▲ KEY
SET     : PUSH DISPLAY KEY
START  : PUSH RECORD KEY
CANCEL: PUSH MENU KEY
10:20:00PM
```

3 Press **DOWN ▼** to select **REC TIME**. Press **DISPLAY** repeatedly to select one of the options shown at left.

```
START : 10:20PM
REC TIME : 10MIN.
SELECT : PUSH ▼/▲ KEY
SET     : PUSH DISPLAY KEY
START  : PUSH RECORD KEY
CANCEL: PUSH MENU KEY
10:20:00PM
```

To cancel the setup, press **MENU** twice.

4 Press **RECORD/PAUSE** to place Camcorder in stand-by mode.

```
STAND-BY
START: 10:20PM
REC TIME: 10MIN.
10:20:00PM
JUN 1 2001
```

Recording will be done as scheduled.

Note:

- Start time may not be set over 24 hours from current time.
- Camcorder shuts off at tape end, or 12 hours after Interval Recording starts.
- To cancel, set **POWER** to **OFF**.

8-Function Remote Control (PV-L651 only)

Remote Control Operation

Operate Camcorder's main functions up to about 5 m (16 feet) away.
Aim remote at sensor on Camcorder.

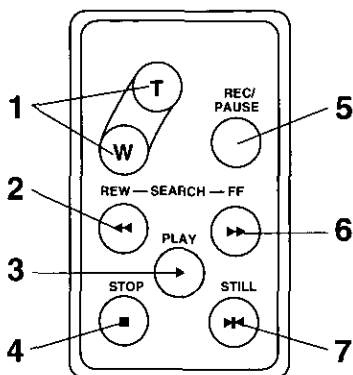

Controlled Functions

- 1 POWER ZOOM**
page 23.
- 2 REWIND/SEARCH**
page 20.
- 3 PLAY**
page 20.
- 4 STOP**
page 20.
- 5 RECORD/PAUSE**
page 16.
- 6 FAST FORWARD/SEARCH**
page 20.
- 7 STILL**
page 20.

Note:

- If you press **REC/PAUSE** on the remote control with the LCD monitor rotated 180° to face the same direction as the lens/subject, "RECORD" or "PAUSE" is displayed on-screen in extra large characters for confirmation.

Important Note:

- After 5 minutes in Record/Pause mode, the camcorder will shut off to conserve battery power. If recording is resumed within 30 minutes, press **REC/PAUSE** once.
If over 30 minutes, set **POWER** to **OFF**, then **CAMERA**, then press **REC/PAUSE**.

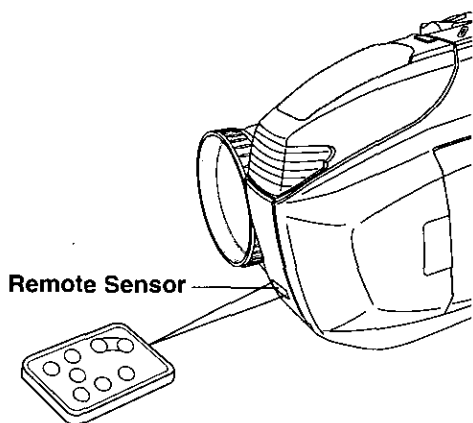

Playing Back Recordings

Before you begin...

- Connect Camcorder to power source.
- Insert recorded tape.

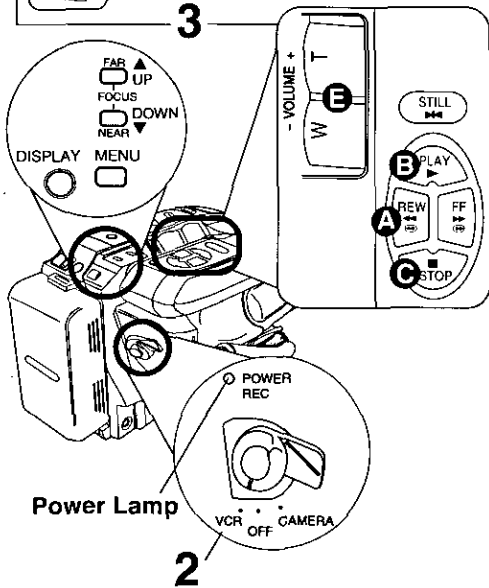
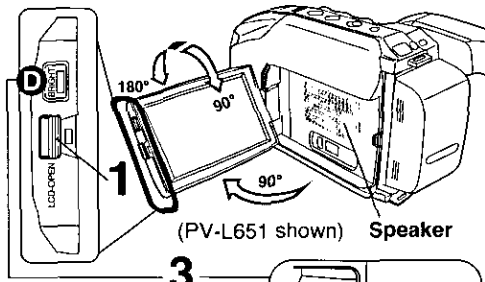

Playback on EVF or LCD Monitor

- 1 Press LCD-OPEN** and swing LCD monitor fully open.
 - If you want to playback on EVF, close and lock LCD monitor.
- 2 Set POWER to VCR.** Power Lamp lights.
 - If tape has no record tab, auto playback begins.
 - EVF or LCD monitor turns on/off by the POWER switch.
 - EVF shuts off when LCD monitor is opened and turns back on when LCD is closed.
- 3 Playback function buttons.**
 - A REW** : Rewind tape.
 - B PLAY** : Play tape.
 - C STOP** : Stop tape.
 - D BRIGHT** : Adjust LCD monitor brightness.
 - E VOLUME** : Adjust volume of speaker.
 - Press "T" : Volume up (+).
 - Press "W" : Volume down (-).

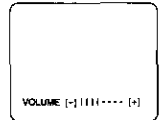

Note:

- Using LCD monitor reduces battery operating time.
- Return LCD monitor to locked position when not in use.

Special Effects

Quick Visual Search

Search Speed

- SP (Standard Play) : 3 times normal.
- SLP (Super Long Play) : 9 times normal.

During playback, press:

- **FF** : fast forward search
 - **REW** : rewind search
- Press again or press **PLAY** for normal play.

Still Picture

Press **STILL** to freeze picture.

Press again for normal play.

This feature works best in SLP mode (page 11).

Note:

- During search, horizontal noise bars will appear. Audio is muted.
- To protect video heads and tape, operating modes will revert as follows after 5 minutes:
 - Still → Stand-by
 - Stand-by → Power off (when Battery Pack is used).
- Tape auto-rewinds if played or fast forwarded to end.

Tracking Control

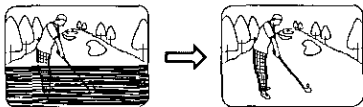

Auto Tracking

Continuously analyzes each recording for optimum picture quality.

Manual Tracking

Some recordings require manual adjustment to reduce noise.

Press **UP ▲** or **DOWN ▼** until Playback picture clears up.

Press **DISPLAY** to return to Auto Tracking.

Playing Back Recordings

TV Playback or Viewing

Connect Camcorder to a TV to view playback or recordings in progress.

Connections

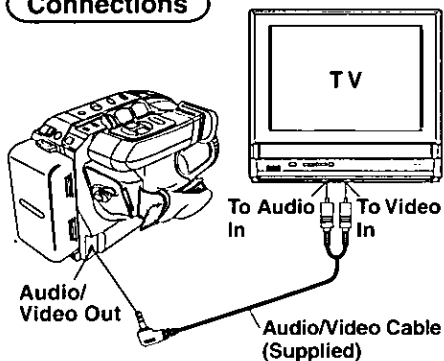

Before you begin...

- Connect Camcorder to power source.
- Make all TV-Camcorder connections.

- 1** Set **POWER** to:
VCR → view playback.
CAMERA → view picture as it is recorded.
- 2** Turn **TV ON** and set to **LINE INPUT**. See TV owner's manual.
- 3** Begin playback or recording.

CATV System Installer

This reminder is provided to call the CATV system installer's attention to Article 820-40 of the NEC in USA (and to the Canadian Electrical Code in Canada) that provides guidelines for proper grounding and, in particular, specifies that the cable ground shall be connected to the grounding system of the building, as close to the point of cable entry as practical.

VCR Playback using PlayPak

1 Load Battery in PlayPak

Remove Battery lid and insert AA battery.

- Do not reverse polarity.
- Replace battery when tape loading/unloading takes longer than usual.

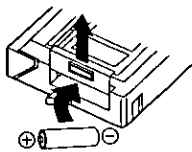

2 Insert VHS Cassette in PlayPak

- a** Turn **VHS** cassette **Tape Wheel** in direction of arrow to take up any slack.
- b** Slide **RELEASE** to open cassette lid.
- c** Insert the **VHS** cassette with the window up and on the left, then snap lid shut.

- Do not obstruct cassette reel while loading.
- Allow PlayPak Load Detector to fully retract before using in VHS VCR.

3 Remove VHS Cassette

- a** Slide **RELEASE** and wait for lid to open.
- b** Push cassette out through hole in bottom of PlayPak with your finger.

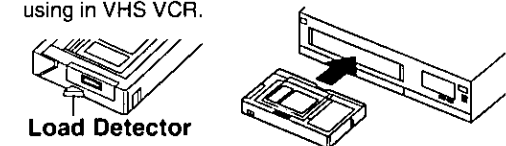

Copying your Tapes (dubbing)

Connections

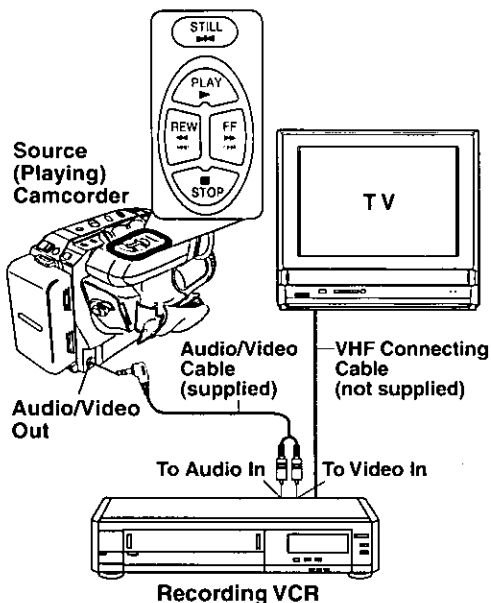

Before you begin...

- Make Camcorder-VCR connections (see left).
- Turn both units on.
- Set VCR input signal to LINE.
Please see VCR owner's manual.
- Set Camcorder POWER to VCR.

- 1** Insert a pre-recorded tape into Camcorder and a blank tape with record tab into VCR.
- 2** Press PLAY on Camcorder, then press STILL at starting point.
- 3** Press REC, then STILL/PAUSE on VCR.
- 4** Press STILL on Camcorder and STILL/PAUSE on VCR to start copying.
- 5** Press STOP on both units to stop copying.

Note:

- Camcorder will only playback tapes recorded in SP or SLP mode.
- Dubbing may reduce picture quality.

Monitor with your TV

- Turn TV on and tune to VCR channel (CH3 or CH4).
- Set TV/VCR Selector on VCR to VCR.

CAUTION:

Unauthorized exchanging and/or copying of copyrighted recordings may be copyright infringement.

Four-Speed Power Zoom

Zoom in (close up) and out (wide angle) in one of four speeds ranging from slow (16 seconds) to fast (2 seconds).

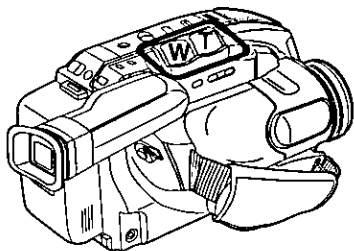

Before you begin...

- Connect Camcorder to power source.
- Set POWER to CAMERA.

Zoom In ("T")



Zoom Out ("W")

• Zoom slowly:

Lightly press "T" (telephoto) or "W" (wide angle) POWER ZOOM button.

• Zoom quickly:

Apply more pressure to the button.

Backlight

Use when subject is darker than surroundings, in shadowed area, or in front of the light source.

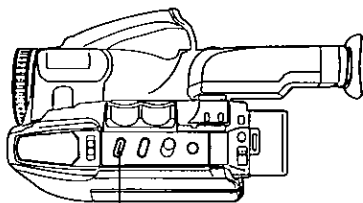

BACKLIGHT

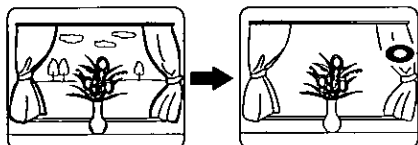

Press BACKLIGHT.

Before you begin...

- Connect Camcorder to power source.
- Set POWER to CAMERA.

Press **BACKLIGHT** while recording to select the level of backlight compensation.

In normal lighting, press **BACKLIGHT** repeatedly until no indicator is displayed.

EVF or LCD Monitor

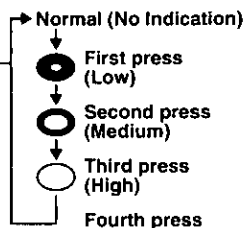

Focus

Before you begin...

- Connect Camcorder to power source.
- Set POWER to CAMERA.

Auto Focus

Camcorder automatically focuses on subject even during zooming.

Auto Focus is on when "MF" is not displayed in EVF or LCD monitor.

Press **MANUAL FOCUS** to remove "MF" in EVF or LCD monitor if necessary.

Manual Focus

Use Manual Focus (MF) when :

- recording through glass.
- lighting is poor.
- subject is far away with objects in foreground.
- subject has distinct horizontal lines.
- subject is not centered in EVF or LCD monitor.
- subject has a shiny surface.
- subject is slanted.
- subject is bright and flat, like a white wall.
- subject has fast motion, like a golf swing.

EVF or LCD Monitor

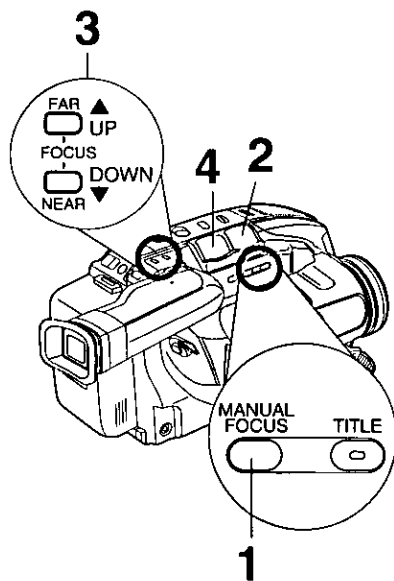
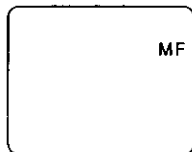

1 Press **MANUAL FOCUS** so "MF" (Manual Focus) appears in EVF or LCD monitor.

2 Hold down "**T**" (telephoto) on **POWER ZOOM** to maximum zoom in.

3 Press **UP ▲ (FAR)** or **DOWN ▼ (NEAR)** until subject is in focus.
• Back away from subject if necessary.

4 Hold down "**W**" (wide angle) on **POWER ZOOM** as desired.

• Refocus as needed when aiming at new scenes.

Macro Focus (close-ups)

Auto Focus functions up to 12.7 mm (1/2 inch) from subject.

Hold down "**W**" on **POWER ZOOM** to maximum wide angle.

Bring Camcorder up close to the subject.

High Speed Shutter

Improves Still or Slow Motion playback picture of high speed subjects (e.g. a tennis stroke), when viewed on Camcorder or 3 or 4 head VCR.

Before you begin...

- Connect Camcorder to power source.
- Insert cassette with record tab (page 11).
- Set POWER to CAMERA.

Auto Shutter

In AUTO mode (no indication in EVF or LCD Monitor), shutter speed is auto-adjusted from 1/60 to 1/350 according to subject brightness.

- AUTO mode is selected each time POWER is set to CAMERA.

Manual Selection

The faster the shutter speed, the more light is needed for proper picture and color quality. High Speed Shutter indication flashes if light is inadequate. Provide additional light.

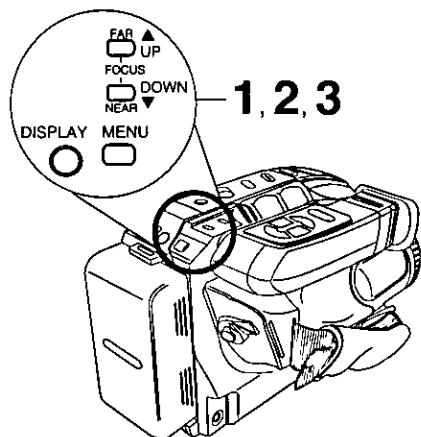

1 Press **MENU** for MENU mode. Press **UP ▲** or **DOWN ▼** to select **SHUTTER**.

2 Press **DISPLAY** repeatedly to select shutter speed.

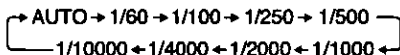
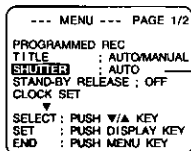

3 Press **MENU** to exit.

Note:

- Provide additional halogen or tungsten light for use indoors or in poor light. Fluorescent light degrades picture.
- Auto Focus may not function properly if high speed shutter is used in inadequate light.
- Setting reverts to AUTO each time POWER is set to CAMERA.

Auto Fade

An interesting way to open and close scenes.

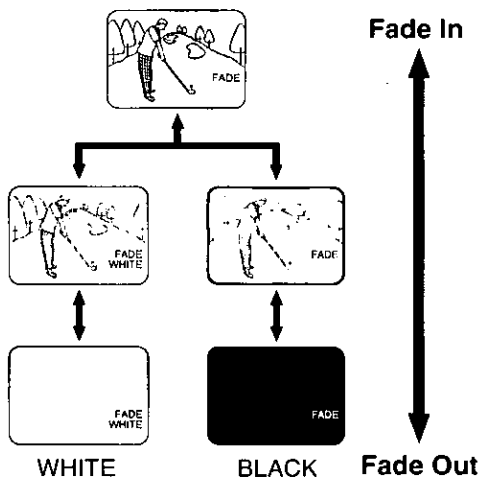
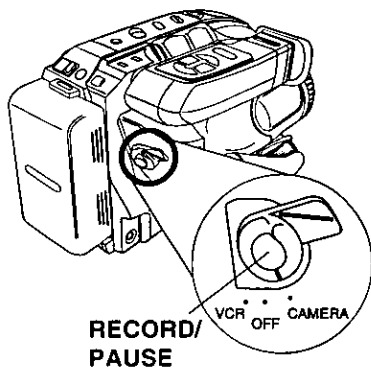
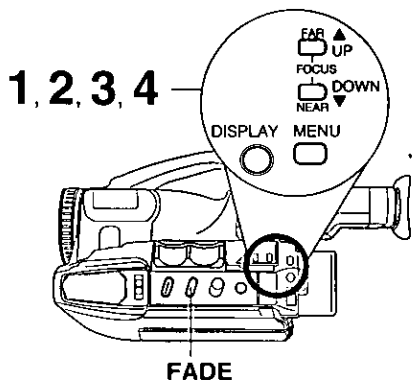

Before you begin...

- Connect Camcorder to power source.
- Set POWER to CAMERA.

1 Press **MENU** for MENU mode.
Press **UP ▲** or **DOWN ▼** to select **VIDEO EFFECTS**.

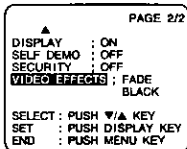

2 Press **DISPLAY** for VIDEO EFFECTS menu.
Press **UP ▲** or **DOWN ▼** to select **AUTO FADE**.

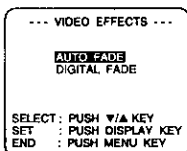

3 Press **DISPLAY** for AUTO FADE ; COLOR menu.
Press **UP ▲** or **DOWN ▼** to select BLACK or WHITE.

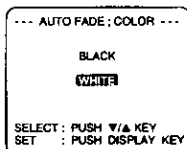

4 Press **DISPLAY** to confirm entry.
Press **MENU** to exit.

Fade In:

In **RECORD/PAUSE** mode, press **FADE** so "FADE" flashes in EVF or LCD monitor.
Press **RECORD/PAUSE**.
Recording starts as picture and sound gradually fade in.

Fade Out:

While recording, press **FADE** so "FADE" flashes in EVF or LCD monitor.
Press **RECORD/PAUSE**.
Picture and sound gradually fade out, and recording is paused.

If **FADE** is pressed accidentally, press again so "FADE" disappears in EVF or LCD monitor.

Color Digital Fade

Choose from 7 fade effects in 8 different colors.

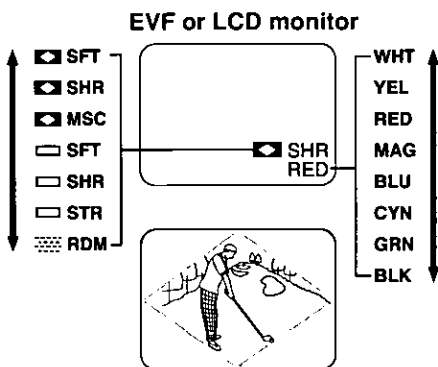
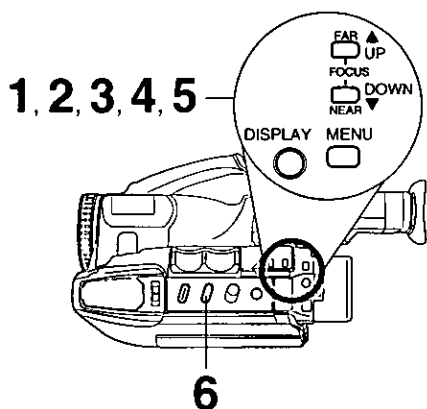

■ For more effects, stop fade in or fade out at any time (except RANDOM mode) by pressing **FADE**. Then, press **FADE** to resume fade.

Note:

- Audio is not affected by fade.
- To cancel Digital Fade, do steps 1, 2, and 5. In step 2, select AUTO FADE.

Before you begin...

- Connect Camcorder to power source.
- Set **POWER** to **CAMERA**.

1 Press **MENU** for **MENU** mode.

Press **UP ▲** or **DOWN ▼** to select **VIDEO EFFECTS**.

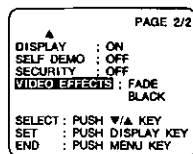

2 Press **DISPLAY** for **VIDEO EFFECTS** menu. Press **DOWN ▼** to select **DIGITAL FADE**.

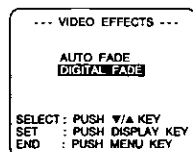

3 Press **DISPLAY** for **DIGITAL FADE** menu. Press **UP ▲** or **DOWN ▼** to select **TYPE**. Press **DISPLAY** for **TYPE** menu. Press **UP ▲** or **DOWN ▼** to select from 7 different types of fades.

- A preview of each fade type is displayed as it is selected.

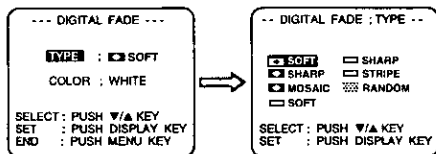

4 Press **DISPLAY** for **DIGITAL FADE** menu. Press **DOWN ▼** to select **COLOR**. Press **DISPLAY** for **COLOR** menu. Press **UP ▲** or **DOWN ▼** to select from 8 colors.

- A preview of each color is displayed as it is selected.



5 Press **DISPLAY** to confirm entry. Press **MENU** twice to exit.

6 Press **FADE** for about 2 seconds to fade out during recording (selected fade type flashes). Press **FADE** again to fade in.

Digital Zoom

Power Zoom magnification is digitally increased.

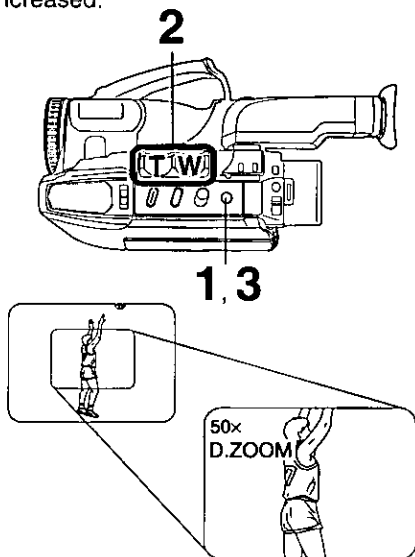

Before you begin...

- Connect Camcorder to power source.
- Set POWER to CAMERA.

1

Press **D. ZOOM**.

Digital Zoom mode (150x maximum).

The Higher digital magnification levels may cause picture distortion.

2

Hold down **"T" on POWER ZOOM**.

Digital Zoom starts when normal zoom reaches maximum (20x).

- Zoom level appears in EVF or LCD monitor.
- POWER ZOOM switch controls digital zoom level.
- Normal zoom resumes when level falls to 20x.

3

Press **D. ZOOM** to turn off Digital Zoom so no indication appears.



Digital Electronic Image Stabilization (EIS)

Helps stabilize picture when recording in unstable situations.

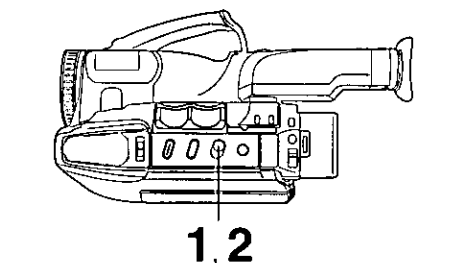

Before you begin...

- Connect Camcorder to power source.
- Set POWER to CAMERA.

1

Press **EIS** to display "EIS" in the EVF or LCD monitor.

- Image becomes slightly enlarged and shutter speed auto-adjusts from 1/80 to 1/350 according to brightness.
- Use High Speed Shutter (page 25) if needed. Shutter speed setting remains after EIS is canceled.

2

Press **EIS** again to cancel when not in use.

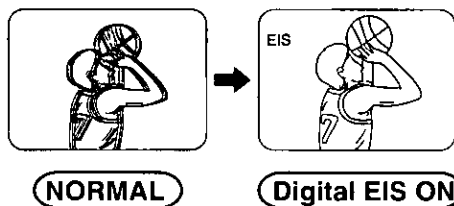

EIS may not function during...

- extreme Camcorder movement.
- recording of subjects with distinct horizontal or vertical stripes.
- low light situations (EIS indicator flashes).
- intense fluorescent lighting situations.
- recording of very fast motion.

Security Mode

Recording starts automatically if motion is detected.

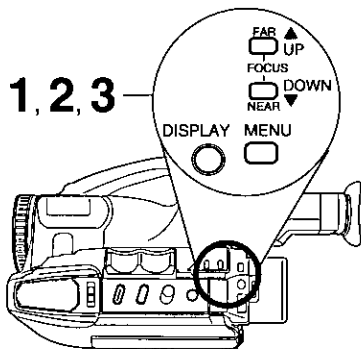

Before you begin...

- Connect Camcorder to power source.
Use AC Adaptor for longer recordings.
- Insert cassette with record tab (page 11).
- Set POWER to CAMERA.
- Securely position and aim Camcorder.

- 1 Press **MENU** for **MENU mode**.
Press **UP ▲** or **DOWN ▼** to select **SECURITY**.

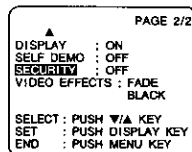

- 2 Press **DISPLAY** to select ON.

- 3 Press **MENU** for Motion Security stand-by mode. (If cassette is not inserted, "📀" will flash.)

Motion Security may mistakenly start when:

- background is plain, like a white wall, or has distinct vertical, horizontal, or slanted stripes, like a venetian blind.
- brightness suddenly changes.

Motion Security may not start when:

- motion is very slow or fast.
- moving object is very small.
- motion occurs only in 1 corner of viewing area.
- in poor lighting (in this case, MOTION SECURITY flashes).
- background is plain, like a white wall, or has distinct horizontal or vertical stripes.

Note:

- Security recording starts if Camcorder is bumped or repositioned.
- This feature is not available during normal recording.
- While in Motion Security stand-by, the following functions are not available: Record/Pause, Stand-by mode, Digital EIS, Video Effects (Auto/Digital Fade).

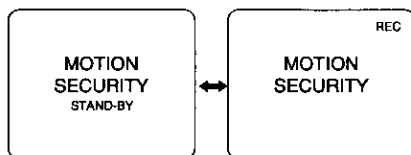

- Recording will start about 3 seconds after motion is detected.
- Date and time are recorded if displayed in EVF or LCD monitor (page 16).
- Recording stops about 30 seconds after motion ceases.

To cancel Security Mode, set **POWER to OFF**.

Intelligent Titler

Automatic Title

Camcorder auto-displays title greeting on selected holidays when power is first turned on. See title list below.

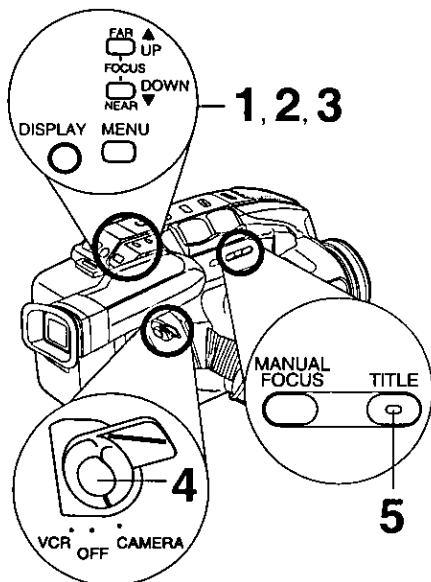

Before you begin...

- Connect Camcorder to power source.
- Insert cassette with record tab (page 11).
- Set POWER to CAMERA.

- 1 Press **MENU** for MENU mode.
Press **UP ▲** or **DOWN ▼** to select **TITLE**.

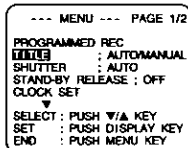

- 2 Press **DISPLAY** to select AUTO/MANUAL.
- 3 Press **MENU** to exit.
- 4 To record the title, press **RECORD/PAUSE**.
- 5 Press **TITLE** while recording to remove title.

Note:

- Once removed, title will not be auto-displayed. To redisplay, or select from other titles, use Manual Title (see below).

Automatic/Manual Title Display List

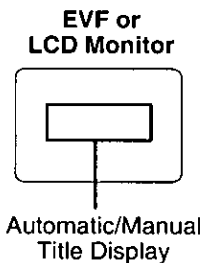

Dec. 31–Jan. 1	HAPPY NEW YEAR! / CHEERS!
Feb. 14	VALENTINE'S DAY / BE MY VALENTINE
2nd Sunday in May	HAPPY MOTHER'S DAY / WE LOVE YOU!
Last Monday in May	MEMORIAL DAY
3rd Sunday in Jun.	HAPPY FATHER'S DAY / WE LOVE YOU!
Jul. 4	INDEPENDENCE DAY
1st Monday in Sep.	LABOR DAY
Oct. 31	HAPPY HALLOWEEN
4th Thursday in Nov.	HAPPY THANKSGIVING
Dec. 24–25	MERRY CHRISTMAS / HO! HO! HO!
These Titles must be displayed manually.	HAPPY EASTER HAPPY ANNIVERSARY HAPPY BIRTHDAY VACATION WEDDING DAY A SPECIAL DAY

Before you begin...

- Connect Camcorder to power source.
- Insert cassette with record tab (page 11).
- Set POWER to CAMERA.

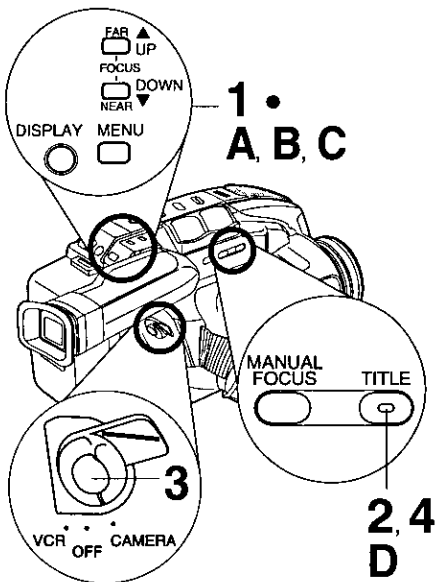

Manual Title

- 1 Confirm that TITLE: AUTO/MANUAL is set in Menu mode (steps 1-3, page 30).

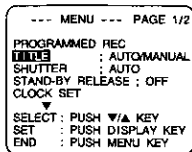

- 2 In Record/Pause mode, press **TITLE** repeatedly to display titles from list on page 30.
- 3 To record the title, Press **RECORD/PAUSE**.
- 4 Press **TITLE** while recording to remove title.

Note:

- To redisplay title, press **TITLE** in Record/Pause mode.

Phrase Title

- A Press **MENU** for MENU mode. Press **UP \blacktriangle** or **DOWN ∇** to select **TITLE**.

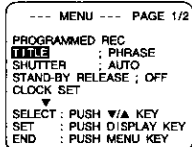

- B Press **DISPLAY** to select PHRASE.
- C Press **MENU** to exit.
- D In Record/Pause mode, press **TITLE** repeatedly to display phrases from the list at left.
- E Do steps 3, 4 above to record and remove phrase.

Note:

- To redisplay phrase, press **TITLE** in Record/Pause mode.

Phrase Title Display

EVF or LCD Monitor

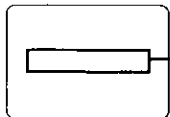

(no indication)
 BEAUTIFUL
 BRAVO!
 CHEERS!
 CONGRATULATIONS
 GIMME A BREAK!
 GOOD LUCK
 I LOVE YOU
 OOPS!
 OUR LITTLE ANGEL
 WAY TO GO

Special Features

Viewfinder/LCD Monitor Indications

Tape remaining and battery charge level can be displayed.

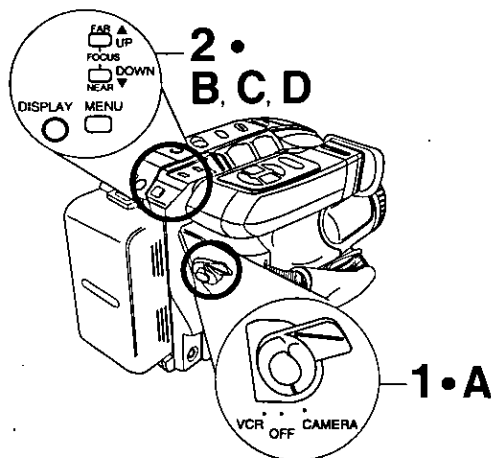

Battery Remaining: **Tape Remaining:**

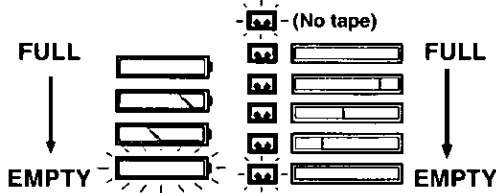

Before you begin...

- Connect Camcorder to power source.

- 1** Set POWER to CAMERA.
- 2** Press DISPLAY repeatedly to select the following displays.

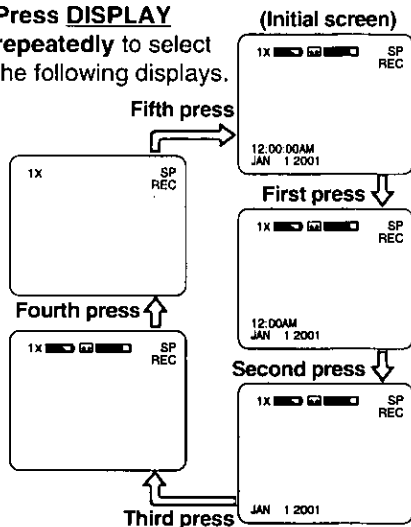

- Tape remaining indicator operates a few seconds after tape starts moving.

Recording the Date and Time

- 1** Do steps 1 and 2 above to select time/date, date only, or no display.
- 2** Start a recording (page 16).
• Only the Date and/or Time are recorded.

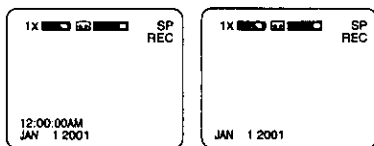

Display-Off Mode

No Indication, except Intelligent Titler (pages 30, 31), will be displayed.

- Set POWER to CAMERA or VCR.
- Press MENU for MENU mode.
Press UP ▲ or DOWN ▼ to select **DISPLAY**.
- Press DISPLAY to select OFF.
Press MENU to exit.
- Press DISPLAY repeatedly to remove time/date.

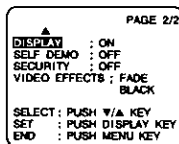

[CAMERA MODE]

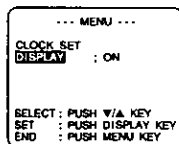

[VCR MODE]

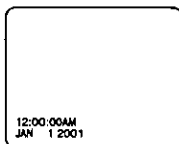

Indications are restored the next time Camcorder is turned on.

Viewfinder/LCD Monitor Indications

CAMERA/VCR mode

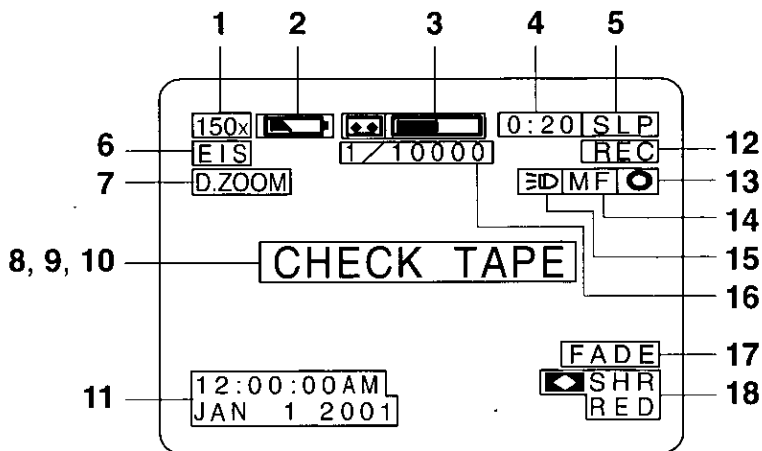

- 1 **Zoom Magnification level** (pages 23, 28).
- 2 **Battery Remaining** (page 32).
"WARNING LOW BATTERY" appears and Power Lamp starts flashing 15 seconds before Camcorder shuts off.
- 3 **Tape Remaining** (page 32).
"" flashes and "TAPE END" appears for 5 seconds when:
 - End of tape is reached.
 "" flashes 1 minute and "CHECK TAPE" appears for 5 seconds when:
 - RECORD/PAUSE is pressed with no cassette, or cassette has no record tab in Camera (RECORD) mode.
 - PLAY, FF or REW is pressed with no cassette inserted in VCR mode.
- 4 **10-Second Reminder**
Each time a recording is started, a 10 second incremental display (up to 59:50) lets you monitor how long one scene is recorded.
 0:00 0:10 0:20 59:50

 (return to 0:00 and continue)
- 5 **TAPE SPEED** (pages 11, 16).
(SP=standard play, SLP=super long play).
- 6 **Digital EIS** (page 28).
- 7 **Digital Zoom** (page 28).
- 8 **VCR-MODE**
"VCR-MODE" appears for 1 minute when POWER is set to VCR or if RECORD/PAUSE is pressed in VCR mode.
- 9 **DEW**
If moisture condensation occurs in unit, "WARNING DEW DETECTED" appears, Power Lamp flashes, and Camcorder will shut off in 15 seconds. Wait until lamp no longer flashes when Camcorder is turned on to use.
- 10 **Security Mode** (page 29).
- 11 **Date and Time** (pages 13, 14).
- 12 **Operating Mode**
 - REC (record)
 - PAUSE
 - FF (fast forward)
 - PLAY
 - REW (rewind)
- 13 **Backlight** (page 23).
- 14 **Manual Focus** (page 24).
- 15 **Light ON/OFF** (PV-L551/PV-L601/PV-L651 only) (page 15).
- 16 **High Speed Shutter** (page 25).
- 17 **Fade** (page 26).
- 18 **Color Digital Fade** (page 27).

For Your Information

Operation Notes

Attaching Shoulder Strap

Remove Battery Pack before doing steps.

- 1 Undo strap ends from buckles.

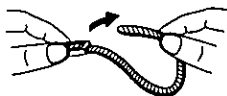

- 2 Thread strap ends through Strap Rings on Camcorder.

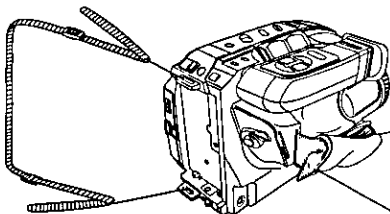

- 3 Re-insert the strap ends into buckles.



min. 25.4 mm (1 inch)

Adjust the Length of the Shoulder Strap

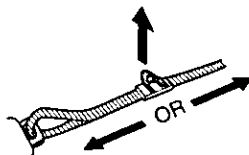

Pull a loop of strap from buckle, then pull strap tight to shorten or lengthen.

Hand Strap

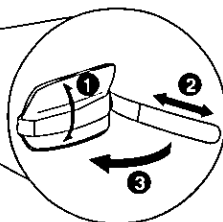

Adjust Hand Strap length to fit your hand as shown.

Cleaning EVF (Electronic Viewfinder)

To Remove

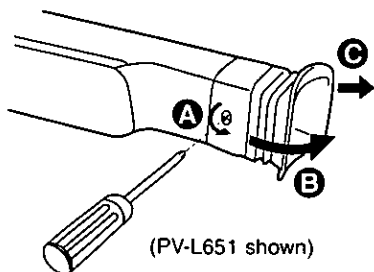

- 1 **A** Remove the screw with a Phillips screwdriver.
Turn counterclockwise.
B Turn the EVF Eyepiece.
C Pull the EVF Eyepiece.
- 2 Remove any lint or dust particles with a soft clean cloth being careful not to scratch the glass surfaces.
- 3 Replace the EVF Eyepiece and the screw.

Replacing Clock/Remote Battery

The clock and remote batteries are pre-installed. Follow the steps below if replacement becomes necessary.

WARNING:

Replace battery with Panasonic PART NO. VSBW0004 (CR2025) only. Use of another battery may present a risk of fire or explosion.

Caution: Battery may explode if mistreated. Dispose of used battery promptly. Keep away from children. Do not recharge, disassemble or dispose of in fire.

Clock Battery

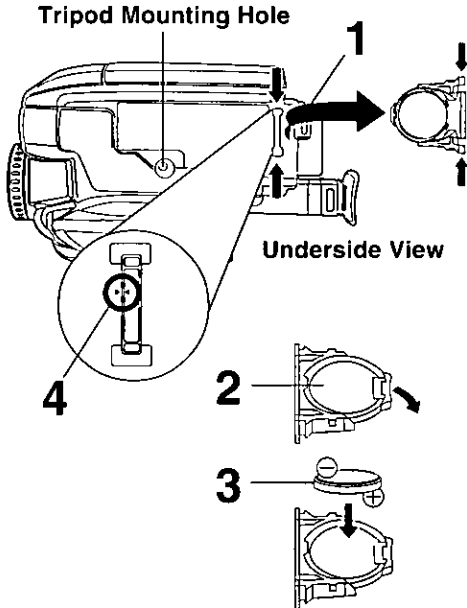

- 1** While pinching 2 tabs, pull Battery Tray out.
- 2** Bend middle tab out and remove Battery.
- 3** Snap new Battery (⊕ mark down) into Battery Tray.
 - Do not reverse the polarity.
- 4** Insert Battery Tray so the triangle marks meet.

Note:

- Keep Battery out of children's reach. Swallowing it may be harmful.
- Improperly installed, discharged, or missing battery causes "CLOCK BATTERY" to appear when DISPLAY is pressed.
- Battery life is approximately 5 years.

Remote Battery (PV-L651 only)

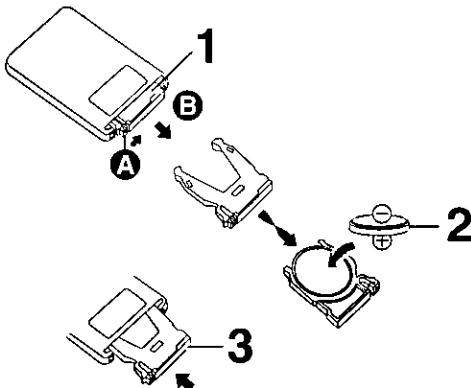

- 1** **A** While pressing stopper tab, **B** pull Battery Tray out.
- 2** Insert battery into tray with ⊕ mark down.
 - Do not reverse the polarity.
- 3** Replace Battery Tray.

Palmcorder Accessory System

For ordering instructions, see the Accessory Order Form page.

- The listed standard battery use times are based on continuous recording using this Palmcorder.

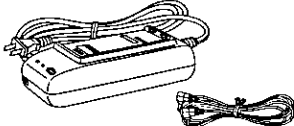
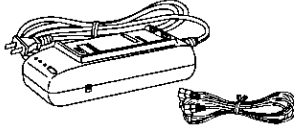
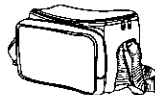
Accessory #	Figure	Description	Price
PV-A17		AC Adaptor with DC Power Cable (Charging of the Nickel Cadmium Battery)	\$139.95
PV-A19		AC Adaptor with DC Power Cable (Charging of the Nickel Cadmium Battery or Nickel Metal Hydride Battery)	Call For Pricing
HHR-V60A/1B		Up to 6 hr Battery Pack (Rechargeable Nickel Metal Hydride Battery)	\$119.95
HHR-V40A/1B		Up to 4 hr Battery Pack (Rechargeable Nickel Metal Hydride Battery)	\$69.95
HHR-V20A/1B		Up to 2 hr Battery Pack (Rechargeable Nickel Metal Hydride Battery)	\$59.95
PV-AA6		"AA" Battery Case	\$20.00
PV-C16		Car Battery Cord	\$70.00
PV-P1		VHS PlayPak	\$39.95
PV-H18A		Soft Sided Carrying Case	\$49.95

Note:

- Prices subject to change without notice.

Palmcorder Accessory Order Form

Please photocopy this form when placing an order.

1. Palmcorder Model # _____

2. Items Ordered

Accessory #	Description	Price Each	Quantity	Total Price
Subtotal				
Your State & Local Sales Tax				
Shipping & Handling				6.95
Total Enclosed				

3. Method of payment (check one)

- Check or Money Order enclosed (NO C.O.D.SHIPMENTS)
- VISA Credit Card # _____
- MasterCard Expiration Date _____
- Discover Customer Signature _____

Make Check or Money Order to: PANASONIC ACCESSORIES

(Please do not send cash)

4. Shipping information (UPS delivery requires complete street address)

Ship To:

Mr.

Mrs.

Ms. _____

First

Last

Phone #:

Day () _____

Street Address _____

Night () _____

City

State

Zip

TO OBTAIN ANY OF OUR PALMCORDER ACCESSORIES YOU CAN DO ANY OF THE FOLLOWING:

VISIT YOUR LOCAL PANASONIC DEALER

OR

CALL PANASONIC'S ACCESSORY ORDER LINE AT 1-800-332-5368

[6 AM-5 PM M-F, 6 AM-10:30 AM SAT, PACIFIC TIME]

OR

MAIL THIS ORDER TO: PANASONIC SERVICES COMPANY ACCESSORY

ORDER OFFICE

20421 84th Avenue South Kent, WA. 98032

For Your Information

Specifications

Power Source:	Compact VHS Camcorder: DC 6 V AC Adaptor: 110/120/220/240 V AC, 50/60 Hz Battery: Nickel-Cadmium Type DC 6 V
Power Consumption:	Compact VHS Camcorder: 6V DC 8.5 W (Max. 11.5 W) AC Adaptor: 19 W 1.2 W (when not in use.)
Video Signal:	EIA Standard (525 lines, 60 fields) NTSC color signal
Video Recording System:	2 rotary heads plus flying erase head Helical scanning system
Audio:	1 track
Pick-Up System:	Sequential color difference field reverse system
Pick-Up Device:	One integral color filter Charge Coupled Device (CCD)
Lens:	20:1 zoom lens, F1:1.6 with auto iris control Focal length: 3.6 mm - 72 mm 4 speed power zoom function
Viewfinder:	10.2 mm (0.4 inch) Electronic Viewfinder (PV-L501) 11 mm (0.45 inch)/14 mm (0.55 inch) Liquid Crystal Color Electronic Viewfinder (PV-L551/PV-L601/PV-L651)
LCD Monitor:	63.5 mm (2.5 inch) Liquid Crystal Display (PV-L501/PV-L551) 76.2 mm (3.0 inch) Liquid Crystal Display (PV-L601) 101.6 mm (4.0 inch) Liquid Crystal Display (PV-L651)
Minimum Illumination Required:	0.8 lx (F1:1.6) 0.08 footcandles 7 lx (F1:1.6) 0.7 footcandles (EIA Standard)
Operating Temperature:	0 °C~40 °C (32 °F~104 °F)
Operating Humidity:	10 %~75 %
Weight:	Compact VHS Camcorder: 0.98 kg 2.16 lbs. (PV-L501/PV-L551/PV-L601) 0.99 kg 2.18 lbs. (PV-L651) AC Adaptor: 0.3 kg 0.66 lbs.
Dimensions:	Compact VHS Camcorder: 120 (W) × 122 (H) × 186.5 (D) mm 4-3/4 (W) × 4-3/4 (H) × 7-3/8 (D) inch AC Adaptor: 68 (W) × 41 (H) × 140 (D) mm 2-11/16 (W) × 1-5/8 (H) × 5-1/2 (D) inch

Weight and dimensions shown are approximate.

Designs and specifications are subject to change without notice.

Before Requesting Service

If a problem arises, you may be able to correct it yourself.

See Symptom and Correction list below.

Symptom	Correction
No picture in EVF or LCD monitor ...	<ul style="list-style-type: none">• Connect Power Source. (pp. 9, 10)• Set POWER to VCR or CAMERA. (pp. 16, 20)• Check for Dew Indication. (p. 33)• Use fully charged Battery. (p. 9)• Firmly connect all needed cables. (p. 10)
Video cassette cannot be inserted ...	<ul style="list-style-type: none">• Connect Power Source. (pp. 9, 10)• Insert cassette, window side facing out. (p. 11)
Video cassette cannot be removed ...	<ul style="list-style-type: none">• Connect Power Source. (pp. 9, 10)
Operation buttons do not work ...	<ul style="list-style-type: none">• Check for Dew Indication. (p. 33)
Recording cannot be done ...	<ul style="list-style-type: none">• Make sure record tab is intact. (p. 11)• Check Battery Indicator. (p. 32)• Check for Dew Indication. (p. 33)
Auto Focus does not operate ...	<ul style="list-style-type: none">• Set FOCUS to AUTO. (p. 24)• Set POWER to CAMERA. (p. 16)
Sound from microphone can't be monitored ...	<ul style="list-style-type: none">• Set unit to REC or Record/Pause mode.
Camera picture is too dark ...	<ul style="list-style-type: none">• Set HIGH SPEED SHUTTER to AUTO. (p. 25)
No playback picture, or the playback picture is noisy or contains streaks ...	<ul style="list-style-type: none">• Press UP ▲/DOWN ▼ button during playback (Tracking Control). (p. 20)
"Panasonic ITS TAPES PLAY IN YOUR VCR ..." appears in EVF or LCD Monitor ...	<ul style="list-style-type: none">• Set POWER to CAMERA, then set SELF DEMO : OFF in MENU screen to cancel Demo mode. (p. 7)
Top of playback picture waves back and forth excessively ...	<ul style="list-style-type: none">• A playback signal is not as stable as an off the air TV signal, so the top of your TV screen may appear bent or unstable during playback. This is called, "Horizontal AFC time constant change." To correct, slowly turn the TV horizontal hold control. If your TV does not have this control, or adjusting it does not help, contact your TV service center. (Some nominal service charges may be required.)

Video Head Cleaning



Clogged Video Head

While head cleaning is normally not needed, playing old or damaged tapes may clog the heads. When playback picture resembles example at the left, head cleaning is required.

Ideally, head cleaning should be performed by a qualified service technician. When this is not possible, purchase a head cleaning cassette. Be sure to follow cleaning cassette instructions exactly and only use when symptoms occur.

Request for Service Notice

Please photocopy this form when making a request for service notice.

Request for Service Notice:

In the unlikely event this product needs service.

- Please include your **proof of purchase**.
(Failure to do so will delay your repair.)
 - To further speed your repair please provide an explanation of what is wrong with the unit and any symptom it is exhibiting.
-
-
-

Mail this completed form and your Proof of Purchase along with your unit to:
Panasonic Services Company
1705 N. Randall Road
Elgin, IL. 60123-7847
Attn: Camcorder Repair

Limited Warranty

Panasonic Consumer Electronics Company,
Division of Matsushita Electric Corporation of
America, One Panasonic Way Secaucus,
New Jersey 07094

Panasonic Sales Company,
Division of Matsushita Electric of Puerto Rico, Inc.
AVE. 65 de Infantería, Km. 9.5 San Gabriel
Industrial Park Carolina, Puerto Rico 00985

PANASONIC Video Products Limited Warranty

Panasonic Consumer Electronics Company or Panasonic Sales Company (collectively referred to as "the Warrantor") will repair this product with new or refurbished parts, free of charge, in the USA or Puerto Rico, in the event of a defect in materials or workmanship as follows (all time periods commence from the date of the original purchase):

PRODUCT	PARTS	LABOR	SERVICE	CONTACT NUMBER
CAMCORDER	ONE (1) YEAR, EXCEPT CCD IMAGE SENSOR CCD IMAGE SENSOR - SIX (6) MONTHS	NINETY (90) DAYS NINETY (90) DAYS	Carry-In or Mail In	1-800-211-PANA(7262)
VCR	ONE (1) YEAR	NINETY (90) DAYS	Carry-In or Mail In	1-800-211-PANA(7262)
A/V MIXER	ONE (1) YEAR	NINETY (90) DAYS	Carry-In or Mail In	1-800-211-PANA(7262)
MONITOR- VCR Combination	ONE (1) YEAR, EXCEPT CRT CRT - TWO (2) YEARS	NINETY (90) DAYS CRT - NINETY (90) DAYS	Carry-In: 21" CRT and Smaller In-home or carry-in: 22" CRT and Larger	1-800-211-PANA(7262)

Batteries (if included) - New rechargeable batteries in exchange for defective rechargeable batteries for ten (10) days. Non-rechargeable batteries are not warranted.

Tape (if included) - New video cassette tape in exchange for a defective video cassette tape for five (5) days. In-home, carry-in or mail-in service, as applicable, in the USA can be obtained during the warranty period by contacting a Panasonic Services Company (PASC) Factory Servicenter listed in the Service Directory. Or call toll free contact number listed above, to locate an authorized PASC Servicenter. Carry-in or mail-in service in Puerto Rico can be obtained during the warranty period by calling the Panasonic Sales Company telephone number listed in the Servicenter Directory.

This warranty is extended only to the original purchaser. A purchase receipt or other proof of the date of the original purchase is required before warranty service is rendered.

This warranty only covers failures due to defects in materials and workmanship which occur during normal use and does not cover normal maintenance, including, but not limited to, video and audio head cleaning. The warranty does not cover damage which occurs in shipment, or failures which are caused by products not supplied by the warrantor, or failures which result from accident, misuse, abuse, neglect, mishandling, misapplication, alteration, modification, faulty installation, set-up adjustments, improper antenna, inadequate signal pickup, maladjustment of consumer controls, improper operation, power line surge, improper voltage supply, lightning damage, commercial use such as hotel, office, restaurant, or other business or rental use of the product, or service by anyone other than a PASC Factory Servicenter or a PASC authorized Servicenter, or damage that is attributable to acts of God.

LIMITS AND EXCLUSIONS

There are no express warranties except as listed above.

THE WARRANTOR SHALL NOT BE LIABLE FOR INCIDENTAL OR CONSEQUENTIAL DAMAGES (INCLUDING, WITHOUT LIMITATION, DAMAGE TO RECORDING MEDIA) RESULTING FROM THE USE OF THIS PRODUCTS, OR ARISING OUT OF ANY BREACH OF THE WARRANTY. ALL EXPRESS AND IMPLIED WARRANTIES, INCLUDING THE WARRANTIES OF MERCHANTABILITY AND FITNESS FOR PARTICULAR PURPOSE, ARE LIMITED TO THE APPLICABLE WARRANTY PERIOD SET FORTH ABOVE. Some states do not allow the exclusion or limitation of incidental or consequential damages, or limitations on how long an implied warranty lasts, so the above exclusions or limitations may not apply to you.

This warranty gives you specific legal rights and you may also have other rights which vary from state to state. If a problem with this product develops during or after the warranty period, you may contact your dealer or Servicenter. If the problem is not handled to your satisfaction, then write to the Consumer Affairs Department at the Panasonic Consumer Electronics Company address above.

SERVICE CALLS WHICH DO NOT INVOLVE DEFECTIVE MATERIALS OR WORKMANSHIP AS DETERMINED BY THE WARRANTOR, IN ITS SOLE DISCRETION, ARE NOT COVERED. COSTS OF SUCH SERVICE CALLS ARE THE RESPONSIBILITY OF THE PURCHASER.

warvid 8/8/2000

For Your Information

Servicenter List

For Product Information, Operating Assistance, Literature Request, Dealer Locations, and all Customer Service Inquiries please contact:

1-800-211-PANA(7262), Monday-Friday 9am-9pm Saturday-Sunday 9am-7am, EST.
or send e-mail to : consumerproducts@panasonic.com

Web Site: <http://www.panasonic.com>

You can purchase parts, accessories or locate your nearest servicenter by visiting our Web Site.

Accessory Purchases:

1-800-332-5368 (Customer Orders Only)

Panasonic Services Company 20421 84th Avenue South, Kent, WA 98032

(6 am to 5 pm Monday - Friday; 6 am to 10:30 am Saturday; PST)

(Visa, MasterCard, Discover Card, American Express, Check)

Product Repairs

Centralized Factory Servicenter

MAIL TO :

Panasonic Services Company
1705 N. Randall Road,
Elgin, IL 60123-7847

Attention: Camcorder Repair

Please carefully pack and ship, prepaid and insured, to the Elgin centralized repair Factory Servicenter. While there will be added handling delays, you may bring your unit to one of the following locations who will then forward the unit to Elgin for repair.

Customer's in Puerto Rico, please ship or carry in to location below ("Service in Puerto Rico").

Factory Servicenters Locations

CALIFORNIA

6550 Katella Avenue
Cypress, CA 90630

800 Dubuque Avenue
S. San Francisco
CA 94080

3878 Ruffin Road
Suite A
San Diego, CA 92123

COLORADO

1640 South Abilene
Street Suite D
Aurora, CO 80012

FLORIDA

3700 North 29th Avenue
Suite 102
Hollywood, FL 33020

GEORGIA

8655 Roswell Road
Suite 100
Atlanta, GA 30350

ILLINOIS

9060 Golf Road
Niles, IL 60714

1703 North Randall Road
Elgin, IL 60123
(Pick-up/drop-off only)

MARYLAND

62 Mountain Road
Glen Burnie, MD 21061

MASSACHUSETTS

60 Glacier Drive
Suite G
Westwood, MA 02090

MINNESOTA

7850-12th Avenue South
Airport Business Center
Bloomington, MN 55425

OHIO

2236 Waycross Road
Civic Center Plaza
ForestPark, OH 45240

PENNSYLVANIA

2221 Cabot Blvd. West
Suite B
Langhorne, PA 19047

TENNESSEE

3800 Ezell Road
Suite 806
Nashville, TN 37211

TEXAS

13615 Welch Road
Suite 101
Farmers Branch, TX
75244

WASHINGTON

20425-84th Avenue
South
Kent, WA 98032

HAWAII

99-859 Iwaiwa Street
Aiea, Hawaii 96701
Phone (808) 488-1996
Fax (808) 486-4369

Service in Puerto Rico

Matsushita Electric of Puerto Rico, Inc. Panasonic Sales Company/ Factory Servicenter:
Ave. 65 de Infantería, Km. 9.5 San Gabriel Industrial Park Carolina, Puerto Rico 00985
Phone (787) 750-4300 Fax (787) 768-2910

As of January 2001

Spanish Quick Use Guide/Guía Para Uso Rápido

Antes de comenzar...

- Inserte un casete con lengüeta para prevención del grabado.

Cargue la batería

Cargue completamente la batería antes de usarla.

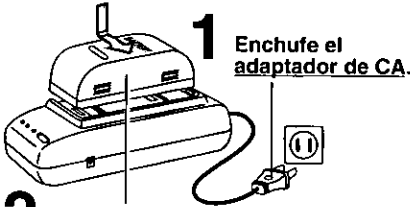

1 Enchufe el adaptador de CA.

2 Instale la batería. El indicador de carga (CHARGE) parpadea, luego queda encendido si ha terminado la carga. **Desmonte la batería.**

Inserte el casete

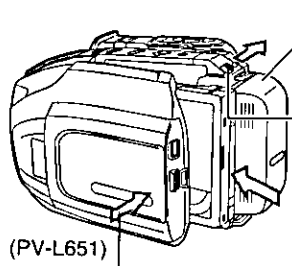

(PV-L651)

1 Coloque la **batería** cargada.

2 Deslice **TAPE EJECT** para abrir la compuerta.

3 Inserte el **casete**.

4 Presione aquí para cerrar la compuerta.

Grabación con la videocámara

Cuando el monitor LCD está completamente abierto, el visor se desconecta automáticamente.

1 Presione **LCD-OPEN** para abrir el monitor LCD. **Abralo completamente y ajuste el ángulo.**

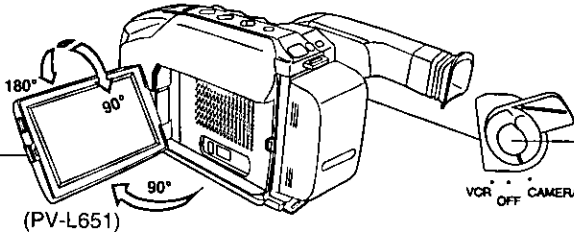

(PV-L651)

2 Ajuste **POWER** a **CAMERA**.

3 Presione **RECORD/PAUSE** para comenzar la grabación. Presione **RECORD/PAUSE** otra vez para hacer una pausa en la grabación.

Reproduzca usando el monitor LCD

Cuando el monitor LCD está completamente abierto, el visor se desconecta automáticamente.

1 Presione **LCD-OPEN** para abrir el monitor LCD. **Abralo completamente y ajuste el ángulo (vea arriba).**



2 Ajuste **POWER** a **VCR**.

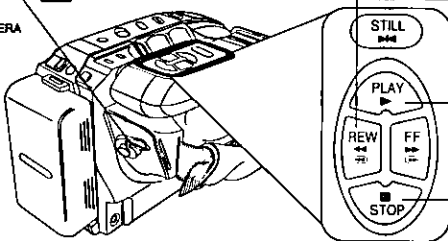

3 Presione **REWIND/SEARCH** para rebobinar la cinta.

4 Presione **PLAY** para comenzar la reproducción.

5 Presione **STOP** para finalizar la reproducción.

Reproducción con efectos especiales

Para localizar rápidamente una escena específica

- Oprimir el botón de localización (SEARCH).

Para congelar una imagen

- Oprimir el botón de pausa/imagen fija (PAUSE/STILL).
- Oprimir nuevamente el botón cuando se desea continuar reproduciendo.

For Your Information

Index

A		F		S	
AC Adaptor.....	10	Fade	26, 27	Safety Precautions	3
Accessories (Optional) ...	36	FADE Button	26, 27	Security Mode	29
Accessories (Supplied)	2	FAST FORWARD/ SEARCH Button	20	Self Demo Mode	7
Audio/Video Cable ...	21, 22	Focus	24	Servicenter List	42
Audio/Video Out	21, 22	H		Shoulder Strap	34
Auto Daylight Saving Time	14	Hand Strap	34	Speaker	20
B		High Speed Shutter	25	Specifications	38
Backlight	23	L		STILL Button	20
BACKLIGHT Button	23	LCD Monitor	16, 20	Still Picture	20
Battery Pack	9, 10	LCD-OPEN Button ...	16, 20	STOP Button	20
BATTERY RELEASE Button	9	Lens Cover	16	T	
BRIGHT Control	16, 20	Light	15	Tab	11
Built-in Twin Capsule 2-Way Microphone System	16	LIGHT Switch	15	TAPE EJECT Switch	11, 16
C		Limited Warranty	41	TAPE SPEED Button	16
Camera Recording ...	16-18	M		TITLE Button	30, 31
Car Battery Cord	10	MANUAL FOCUS Button	24	Titler	30, 31
Charging Battery	9	MENU Button	12	Tracking Control	20
Cleaning EVF	34	MENU Mode	12	Tripod Mounting Hole	35
Clock Battery	35	P		U	
Clock Set	13, 14	PLAY Button	20	UP ▲ (FAR) / DOWN ▼ (NEAR) Button	12, 20, 24
Copying your Tapes	22	Playback	20, 21	V	
D		PlayPak	21	VHF Connecting Cable ..	22
DC IN	10	Power Lamp	16, 20	Video Cassettes (tapes) .	11
DC Power Cable	10	Power Supply	9, 10	Video Head Cleaning	39
Digital EIS	28	POWER Switch	7, 16, 20	Viewfinder/LCD Monitor Indications	32, 33
Digital Zoom	28	POWER ZOOM Button	23, 24, 28	Viewing (TV/VCR)	21
D.ZOOM Button	28	Programmed Recording .	18	VISION ADJUSTMENT ..	16
DISPLAY Button .	12, 20, 32	R		VOLUME Control	20
Display-off Mode	32	RECORD/PAUSE Button	16	Z	
E		Remote Control	19	Zoom	23, 28
EIS Button	28	Replacing Clock/Remote Battery	35		
		Request for Service Notice	40		
		REWIND/SEARCH Button	20		

Panasonic Consumer Electronics
Company, Division of Matsushita
Electric Corporation of America
One Panasonic Way Secaucus,
New Jersey 07094

Panasonic Sales Company ("PSC"),
Division of Matsushita Electric of
Puerto Rico, Inc.
Ave. 65 de Infanteria, Km. 9.5
San Gabriel Industrial Park
Carolina, Puerto Rico 00985



Printed in Indonesia
LSQT0381A
S1200-0