



Omnivision VHS

Panasonic®

TV/DVD/VCR Combination Operating Instructions

Model No. PV-DM2093/PV-DM2793



- Initial Setup and Connection Procedures are on pages 14 to 15.



MULTI FORMAT PLAYBACK



*Ability to play back may depend on recording conditions.



As an ENERGY STAR® Partner, Matsushita Electric Corporation of America has determined that this product or product model meets the ENERGY STAR® guidelines for energy efficiency.

Please read these instructions carefully before attempting to connect, operate or adjust this product. Please save this manual. Spanish Quick Use Guide is included.

(Guía para rápida consulta en español está incluida.)

This operating instruction book is designed for use with models PV-DM2093 and PV-DM2793. Illustrations in this manual show the PV-DM2093. Features may vary, so please read carefully.



LSQT0667C

For assistance, please call : 1-800-211-PANA(7262) or send e-mail to : consumerproducts@panasonic.com

Initial Setup

Basic Operation

TV Operation

Timer Operation

Advanced Operation

For Your Information

Important Safeguards and Precautions

READ AND RETAIN ALL SAFETY AND OPERATING INSTRUCTIONS. HEED ALL WARNINGS IN THE MANUAL AND ON UNIT

INSTALLATION

1 POWER SOURCE CAUTION

Operate only from power source indicated on unit or in this manual. If uncertain, have your Electric Utility Service Company or Video Products Dealer verify your home power source.

2 POWER CORD PLUG

For safety, this unit has a polarized type plug (one wide blade), or a three-wire grounding type plug. Always hold the plug firmly and make sure your hands are dry when plugging in or unplugging the AC power cord.

Regularly remove dust, dirt, etc. on the plug.

POLARIZED PLUG CAUTION:

The plug fits into outlet only one way. If it cannot be fully inserted, try reversing it. If it still will not fit, have an electrician install the proper wall outlet. Do not tamper with the plug.

GROUNDING PLUG CAUTION:

The plug requires a three-hole grounding outlet. If necessary, have an electrician install the proper outlet. Do not tamper with the plug.

3 POWER CORD

To avoid unit malfunction, and to protect against electrical shock, fire or personal injury:

- Keep power cord away from heating appliances and walking traffic. Do not rest heavy objects on, or roll such objects over the power cord.
- Do not tamper with the cord in any way.
- An extension cord should have the same type plug (polarized or grounding) and must be securely connected.
- Overloaded wall outlets or extension cords are fire hazards.
- Frayed cords, damaged plugs, and damaged or cracked wire insulation are hazardous and should be replaced by a qualified electrician.

4 DO NOT BLOCK VENTILATION HOLES

Ventilation openings in the cabinet release heat generated during operation. If blocked, heat build-up may result in a fire hazard or heat damage to cassettes or discs.

For your protection:

- a. Never cover ventilation slots while unit is ON, or operate unit while placed on a bed, sofa, rug, or other soft surface.
- b. Avoid built-in installation, such as a book case or rack, unless properly ventilated.

5 AVOID EXTREMELY HOT LOCATIONS OR SUDDEN TEMPERATURE CHANGES

Do not place unit over or near a heater or radiator, in direct sunlight, inside closed vehicles, in high temperature [over 95 °F (35 °C)], or in over 75% humidity. If unit is suddenly moved from a cold place to a warm one, moisture may condense in unit and on the tape causing damage. Never subject unit to vibration, impact, or place it so that the surface is tilted as internal parts may be seriously damaged.

6 TO AVOID PERSONAL INJURY

- Never place unit on support or stand that is not firm, level, and adequately strong. The unit could fall causing serious injury to a child or adult and damage to the unit.
- Move any appliance and cart combination with care. Quick stops, excessive force, and uneven surfaces may cause objects to overturn.
- Carefully follow all operating instructions.



OUTDOOR ANTENNA INSTALLATION

1 SAFE ANTENNA AND CABLE CONNECTION

An outside antenna or cable system must be properly grounded to provide some protection against built up static charges and voltage. Section 810 of the National Electrical Code, ANSI/NFPA 70 (in Canada, part 1 of the Canadian Electrical Code) provides information regarding proper grounding of the mast and supporting structure, grounding of the lead-in wire to an antenna discharge unit, size of grounding conductors, location of antenna discharge unit, connection to grounding electrodes, and requirements for the grounding electrode.

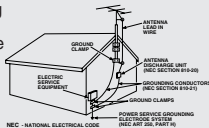

2 KEEP ANTENNA CLEAR OF HIGH VOLTAGE POWER LINES OR CIRCUITS

Locate an outside antenna system well away from power lines and electric light or power circuits so it will never touch these power sources should it ever fall. When installing antenna, absolutely never touch power lines, circuits or other power sources as this could be fatal.

USING THE UNIT

Before unit is brought out of storage or moved to a new location, refer again to the INSTALLATION section of these safeguards.

1 KEEP UNIT WELL AWAY FROM WATER OR MOISTURE,

such as vases, sinks, tubs, etc.

2 IF EXPOSED TO RAIN, MOISTURE, OR STRONG IMPACT,

unplug unit and have it inspected by a qualified service technician before use.

3 ELECTRICAL STORMS

During a lightning storm, or before leaving unit unused for extended periods of time, disconnect all equipment from the power source as well as the antenna and cable system.

4 WHEN UNIT IS PLUGGED IN

• DO NOT OPERATE IF:

- liquid has spilled into unit.
 - unit was dropped or otherwise damaged.
 - unit emits smoke, odours, or noises.
- Immediately unplug unit, and have it inspected by a service technician to avoid potential fire and shock hazards.

- Never drop or push any object through openings in unit. Touching internal parts may cause electric shock or fire hazard. Do not put any foreign object on the tray.

- Keep magnetic objects, such as speakers, away from unit to avoid electrical interference.

5 USING ACCESSORIES

Use only accessories recommended by the manufacturer to avoid risk of fire, shock, or other hazards.

6 CLEANING UNIT

Unplug unit. Use a clean, dry, chemically untreated cloth to gently remove dust or debris. DO NOT USE cleaning fluids, aerosols, or forced air that could over-spray, or seep into unit and cause electrical shock. Any substance, such as wax, adhesive tape, etc. may mar the cabinet surface. Exposure to greasy, humid, or dusty areas may adversely affect internal parts.

SERVICE

1 DO NOT SERVICE PRODUCT YOURSELF

If, after carefully following detailed operating instructions, the unit does not operate properly, do not attempt to open or remove covers, or make any adjustments not described in the manual. Unplug unit and contact a qualified service technician.

2 REPLACEMENT OF PARTS

Make sure the service technician uses only parts specified by the manufacturer, or have equal safety characteristics as original parts. The use of unauthorized substitutes may result in fire, electric shock, or other hazards.

3 SAFETY CHECK AFTER SERVICING

After unit is serviced or repaired, request that a thorough safety check be done as described in the manufacturer's service literature to ensure video unit is in safe operating condition.

Safety Precautions/Mesures de sécurité

- Warning :** To prevent fire or shock hazard, do not expose this equipment to rain or moisture.
- Caution :** To prevent electric shock, match wide blade of plug to wide slot, fully insert.
- Avertissement :** Afin de prévenir tout risque d'incendie ou de chocs électriques, ne pas exposer cet appareil à la pluie ou à une humidité excessive.
- Attention :** Pour éviter les chocs électriques, introduire la lame la plus large de la fiche dans la borne correspondante de la prise et pousser jusqu'au fond.
- FCC WARNING :** Any unauthorized changes or modifications to this equipment would void the user's authority to operate.

This video recorder, equipped with the HQ (High Quality) System, is compatible with existing VHS equipment. Only use those tapes with the **VHS** mark. It is recommended that only cassette tapes that have been tested and inspected for use in 2, 4, 6, and 8 hour VCR machines be used. This television receiver provides display of television closed captioning in accordance with §15.119 of the FCC rules.

CAUTION:

UNIT IS A CLASS I LASER PRODUCT.
HOWEVER THIS UNIT USES A VISIBLE LASER BEAM WHICH COULD CAUSE HAZARDOUS RADIATION EXPOSURE IF DIRECTED. BE SURE TO OPERATE THE UNIT CORRECTLY AS INSTRUCTED. WHEN THIS UNIT IS PLUGGED TO THE WALL OUTLET, DO NOT PLACE YOUR EYES CLOSE TO THE OPENING OF THE DISC TRAY AND OTHER OPENINGS TO LOOK INTO THE INSIDE OF THIS UNIT. USE OF CONTROLS OR ADJUSTMENTS OR PERFORMANCE OF PROCEDURES OTHER THAN THOSE SPECIFIED HEREIN MAY RESULT IN HAZARDOUS RADIATION EXPOSURE. DO NOT OPEN COVERS AND DO NOT ATTEMPT TO REPAIR THE UNIT YOURSELF. REFER SERVICING TO QUALIFIED PERSONNEL.

CAUTION:

LASER RADIATION
WHEN OPEN. DO NOT
STARE INTO BEAM.

ATTENTION:

RAYONNEMENT LASER
EN CAS D'OUVERTURE.
NE PAS REGARDER
DANS LE FAISCEAU.

(Inside of product)

FCC NOTICE:

This equipment has been tested and found to comply with part 15 of the FCC Rules. These limits are designed to provide reasonable protection against harmful interference when operated in a residential environment. If this equipment does cause interference to radio or television reception, which can be determined by turning the equipment off and on, use the equipment in another location and/or utilize an electrical outlet different from that used by the receiver. If necessary, consult the dealer or an experienced radio/TV technician for help. You may find the booklet, "Something About Interference" available from FCC local regional offices helpful.

This product utilizes both a Cathode Ray Tube (CRT) and other components that contain lead. Disposal of these materials may be regulated in your community due to environmental considerations. For disposal or recycling information please contact your local authorities, or the Electronics Industries Alliance: <<http://www.eiae.org>>

	CAUTION RISK OF ELECTRIC SHOCK DO NOT OPEN	
CAUTION: TO REDUCE THE RISK OF ELECTRIC SHOCK, DO NOT REMOVE COVER (OR BACK) NO USER-SERVICEABLE PARTS INSIDE REFER SERVICING TO QUALIFIED SERVICE PERSONNEL		



This symbol warns the user that uninsulated voltage within the unit may have sufficient magnitude to cause electric shock. Therefore, it is dangerous to make any kind of contact with any inside part of this unit.

This symbol alerts the user that important literature concerning the operation and maintenance of this unit has been included. Therefore, it should be read carefully in order to avoid any problems.

Region Management Information

This unit is designed and manufactured to respond to the Region Management Information that is recorded on a DVD disc. If the Region number described on the DVD disc does not correspond to the Region number of this unit, this unit cannot play this disc.

- The region number of this player is "1."
- The player will play DVD-Video marked with labels containing "1" or "ALL."

Example:



Table of Contents

TV / VCR	Important Safeguards and Precautions	2
	Safety Precautions/Mesures de sécurité.....	3
	Before Using	4
	Information (Unit, Cassette, Disc).....	6
	Location of Controls	8
	Connections.....	11
	Initial Setup (Ready to Play)	14
	Reset Language, Channels, Clock, Time Zone Adjust.....	16

TV / VCR	Playback a Tape.....	18
	Record On a Tape.....	18
	Copy Your Tapes (Dubbing).....	19
DVD	Basic DVD Operation	20

TV / VCR	TV Operation	22
	MTS Broadcast/TV Stereo System.....	23
	Closed Caption System	24
	TV Timer Features	26
	On-Screen Display (OSD)	27
	FM Radio	28

TV / VCR	Timer Recording	30
-----------------	-----------------------	----

TV / VCR	Tape Operation	32
	Special VCR Features	36
	V-Chip Control Feature	38
	Audio Features	42
	Video/Audio Menu	44
	Video/Audio Adjustment.....	45
DVD	Disc Operation	46
	DVD Operation using On-Screen Displays	51
	MP3/WMA/JPEG Playback Operation	54
	DVD Lock Feature.....	57

DVD	Settings for DVD Operation	58
	Language Code List	61
TV / VCR	Before Requesting Service.....	62
	Warning and Instruction Displays	64
	Spanish Quick Use Guide/Guía para rápida consulta.....	65
	Limited Warranty	72
	Customer Services Directory	73
	Index	74

Initial Setup

Basic Operation

TV Operation

Timer Operation

Advanced Operation

For Your Information

Information (Unit, Cassette, Disc)

Head Cleaning

Playing older or damaged tapes may eventually cause video heads to become clogged.

Head Clog Sensor

During playback this screen appears if clogging is detected. To clear message from screen, press **PLAY** on the remote or unit.

V VIDEO HEADS MAY
NEED CLEANING
PLEASE INSERT HEAD
CLEANING CASSETTE
OR REFER TO MANUAL

END:PLAY

- Use "dry" type head cleaning cassette only. (Part No. NV-TCL30PT is recommended.)
- Follow cleaning tape directions carefully. Excessive use of head cleaning tape can shorten the video head life.

DST (Daylight Saving Time)

Unit auto adjusts clock for DST (Daylight Saving Time.)

■ Spring (First Sunday in April)

DST: ON → Sets clock ahead one hour.

■ Autumn (Last Sunday in October)

DST: OFF → Turns clock back one hour.

- If your area does not observe Daylight Saving Time, select DST : OFF (see "Clock" on pages 16 and 17).
- Keep these time changes in mind when programming the unit for timer recordings.

Features for a Quality Picture

Digital Auto Tracking

Continuously analyzes the signal and adjusts for optimum picture quality.

Manual Tracking Control (to reduce picture noise)

Use during Playback and Slow Motion mode to reduce picture noise. Press the 3 or 6 NUMBER keys on the remote control or CH ▲▼ on the unit until the picture clears up. To return to Auto Tracking, press **POWER** off, then on again a few seconds later.

V-Lock Control

In Still mode, the 3 or 6 NUMBER keys on the remote control or CH ▲▼ on the unit operate as a V-Lock control to reduce jitter.

PanaBlack™ Picture Tube (PV-DM2793 only)

This unit uses a PanaBlack™ picture tube for better color reproduction and picture contrast.

Apparatus Claims of U.S. Patent Nos. 4,631,603, 4,577,216, 4,819,098, and 4,907,093, licensed for limited viewing uses only.

This product incorporates copyright protection technology that is protected by method claims of certain U.S. Patents and other intellectual property rights owned by Macrovision Corporation and other rights owners. Use of this copyright protection technology must be authorized by Macrovision Corporation, and is intended for home and other limited viewing uses only unless otherwise authorized by Macrovision Corporation. Reverse engineering or disassembly is prohibited.







Specifications

Display		
Picture Tube	20 inch measured diagonal 90° deflection Picture Tube (PV-DM2093) 27 inch measured diagonal 100° deflection Picture Tube (PV-DM2793)	
VCR		
Video Recording System	4 rotary heads helical scanning system	
Audio Track	1 track (Normal) 2 channel (Hi-Fi Audio Sound)	
Tuner		
Broadcast Channels	VHF 2 ~ 13, UHF 14 ~ 69	
CABLE Channels	Midband A through I (14 ~ 22) Superband J through W (23 ~ 36) Hyperband AA ~ EEE (37 ~ 64) Lowband A-5 ~ A-1 (95 ~ 99) Special CABLE channel 5A (01) Ultraband 65 ~ 94, 100 ~ 125	
FM Radio		
Band Range	87.5 MHz ~ 108.1 MHz	
General		
Power Source	120 V AC, 60 Hz	
Power Consumption	Power On	Approx. 134 W (PV-DM2093) Approx. 170 W (PV-DM2793)
	Power Off	Approx. 3.5 W
Television System	EIA Standard NTSC color	
Speaker	2 pieces 3 W (PV-DM2093) 2 pieces 5 W (PV-DM2793)	
Operating Temperature	5 °C ~ 35 °C (41 °F ~ 95 °F)	
Operating Humidity	10 % ~ 75 %	
Weight	27 kg (59.4 lbs.) (PV-DM2093) 42 kg (92.5 lbs.) (PV-DM2793)	
Dimensions (W x H x D)	604 mm (23-13/16") x 523 mm (20-9/16") x 508 mm (20") (PV-DM2093) 772 mm (30-3/8") x 654 mm (25-3/4") x 533 mm (21") (PV-DM2793)	
Discs played		
DVD disc (DVD-Video, DVD-R)	12 cm (5") single-sided, single-layer 12 cm (5") single-sided, double-layer 12 cm (5") double-sided, double-layer (one layer per side) 8 cm (3") single-sided, single-layer 8 cm (3") single-sided, double-layer 8 cm (3") double-sided, double-layer (one layer per side)	
Compact disc (CD-DA, VIDEO CD, CD-R, CD-RW)	5" (12 cm) disc 3" (8 cm) disc	
MP3, WMA, JPEG		
Digital audio output		
Optical digital output	Optical connector	
Pickup		
Wavelength	655 nm (DVD) 790 nm (Video CD/CD) Laser power: CLASS II	

Note

- Designs and specifications are subject to change without notice.

Discs that can be played

Disc type	Disc Logo	Disc formats supported by this unit
DVD-Video	 	<ul style="list-style-type: none"> DVD-Video format
DVD-R		<ul style="list-style-type: none"> DVD-Video formatted discs (finalized*) It may not be possible to play these discs in all cases due to the type of disc or condition of the recording.
Video CD		<ul style="list-style-type: none"> Video-CD format
CD-DA		<ul style="list-style-type: none"> CD-DA format
CD-R		<ul style="list-style-type: none"> CD-DA format Video-CD format
CD-RW		<ul style="list-style-type: none"> MP3/WMA/JPEG file and finalized*.

- Discs played 8 cm (3") or 12 cm (5")
- * A process that allows play on compatible equipment.

Discs which cannot be played with this unit

- DVD with Region No. other than "1" or "ALL"
- DVD of PAL system
- DVD-ROM
- DVD-AUDIO
- DVD-RW
- DVD+RW
- CD-ROM
- CDV
- CVD
- CD-G
- CD-TEXT
- SACD
- Photo-CD

Definition of Terms

Angle

Some DVD discs feature scenes simultaneously shot from different angles. The ANGLE button can be used to view the scene from different angles. (ANGLE Indicator lights up on the unit when a scene recorded at different angles is detected.)

Chapter Number

Titles are subdivided into numbered sections. You can quickly search for a favorite scene using these numbers.

DVD

A high-density optical disc on which high-quality pictures and sound have been digitally recorded. DVD incorporates new video compression technology (MPEG II) and high-density recording technology which allow entire movies to be recorded with incredible playback quality.

Playback Control

With Video CD (version 2.0), scenes or information may be selected for viewing or listening from an interactive menu that appears on the TV screen.

Subtitles

Written dialogue which appears at the bottom of the screen.

Time Number

The elapsed play time from the start of a disc or title. Use to quickly find scenes. (May not work with some discs.)

Title Number

For DVD discs with two or more titles, the title is numbered as title 1, title 2, etc.

Track Number

Numbers assigned to tracks on Video CDs and CDs to allow specific tracks to be quickly located.

Video CD

CD containing picture and sound with same quality level as video tape. This unit also supports Video CDs with playback control (version 2.0).

Disc Handling

Handling precautions

- Sticking a label on the disc may impair DVD-R playback.
- Do not attach sticker to discs. (Do not use discs with exposed adhesive from tape or left over peeled-off stickers.)
- Only hold disc by edges as shown. Fingerprints, dirt, and scratches can cause skipping and distortion.
- Do not write on label side of disc.
- Never use record cleaning sprays, benzine, thinner, static electricity prevention liquids, or any other solvent.
- Be careful not to drop or bend disc.
- Do not place more than 1 disc on disc tray.
- Do not try to close disc tray when disc is not properly placed.
- Always store discs in their proper cases when not in use.

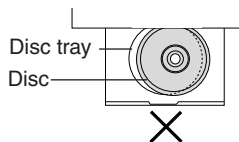

To clean disc surface

With a soft, damp (water only) cloth, gently wipe from the center hole to the outer edge as shown below. (Wiping in a circular pattern will scratch the surface.)

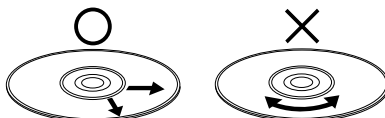

If disc is brought from a cold to a warm environment, moisture may form on the disc

Wipe away moisture with a soft, dry, lint-free cloth before using disc. (See above.)

Improper disc storage

Discs could be damaged if stored or left in areas:

- exposed to direct sunlight.
- that are humid or dusty.
- near heat (i.e. heater, radiator, etc.).

Location of Controls

Remote Control Buttons

EJECT/OPEN/CLOSE

See next page.

POWER

Turns the unit on or off.

DISPLAY

Displays the TV status and clock. In DVD mode, displays disc and unit information.

RAPID TUNE

Displays the last channel you were watching.

MUTE

Mutes the sound instantly.

FM

Receives FM radio signal.

ACTION

Displays Main Menu.

CHANNEL UP/DOWN

Selects a channel.

REW/SLOW-

Rewinds tape and searches reverse scene. Decreases slow motion speed in Still mode.

STOP

Stops recording or playback.

STILL/PAUSE

Pauses picture in Playback mode and frame advance picture in Still mode.

SKIP- |◀◀/SEARCH

Skips back one chapter or track. Goes to previous menu screen. Goes directly to the desired recording.

AUDIO

Selects the desired audio mode.

PROGRAM

Displays SET PROGRAM screen. You can set Timer Program and On-Timer.

REC

Records a program.

ANGLE

Selects the desired angle in DVD mode.

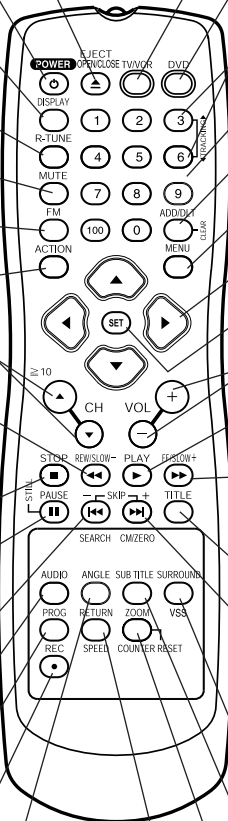

TV/VCR

Sets to TV/VCR mode.

DVD

Sets to DVD mode.

TRACKING UP/DOWN

Reduces picture noise during Playback and Slow Motion.

NUMBER Keys

Selects a channel directly.

ADD/DELETE/CLEAR

Adds or deletes a channel. Cancels an item on the screen.

MENU

Displays DVD menu.

SELECT ▲▼◀▶

Controls navigation around on-screen menu.

SET

Sets a selected menu.

VOLUME UP/DOWN

Adjusts volume.

PLAY

Begins playback.

FF/SLOW+

Fast forwards tape and forward visual search. Increases slow motion speed in Still mode.

TITLE

Selects the desired title by number on some DVDs.

SKIP+ ▶▶ | /CM SKIP/ZERO SEARCH

Skips one chapter or track. Goes to next screen. In Stop mode, goes to the counter "0:00:00." In Playback mode, skips over 1 to 3 minutes of tape.

SURROUND/V.S.S.

Creates a deeper, 3-D sound effect.

SUB TITLE

Selects a different subtitle language.

ZOOM/COUNTER RESET

Enlarges specific portions of DVD picture. Resets to "0:00:00" at desired portion of tape.

RETURN/SPEED

Returns to DVD menu screen. Selects recording speed of tape.

EJECT/OPEN/CLOSE button:

When this button is pressed in TV-VCR mode, the tape is ejected.
This button is inoperative if pressed during recording.
If pressed in DVD mode, the disc tray opens or closes.

Indicators on the Front Panel

<Model PV-DM2093 unit shown>

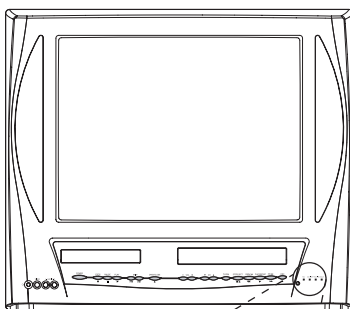
**REC Indicator (RED)**

Lights during recording.
In Rec Pause or OTR
Pause mode, the indicator
flashes.
Pg 18.

Remote Sensor**ON TIMER Indicator (ORANGE)**

Lights when the On Timer is set.
Pg 26.

ANGLE Indicator (RED)

Lights when a scene
recorded at a different angles
is detected. (DVD only).
Pg 47.

PROG TIMER Indicator (GREEN)

Lights when the unit is set for
Timer Recording. It flashes
when a Timer Recording
has been set with no tape
inserted, the clock is not set,
or the tape is in motion.
Pg 30.

Location of Controls (continued)

Front View of the unit

<Model PV-DM2093 unit shown>

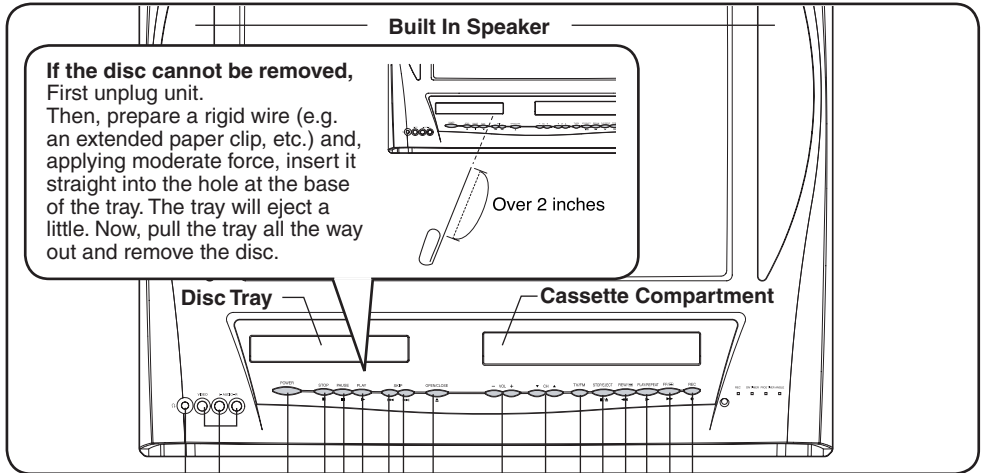

Phones Jack

Connect an earphone or headphones.

Audio/Video Input Connector

Connect from other component.

POWER

Turns the unit on or off.

Disc Operation

STOP

Stops playback.

PAUSE

Pauses picture in Playback mode and frame advance picture in Still mode.

PLAY

Begins playback.

SKIP ◀◀

Skips back one chapter or track. Goes to previous menu screen.

SKIP ▶▶

Skips one chapter or track. Goes to next screen.

OPEN/CLOSE

Opens or closes the disc tray.

Tape Operation

REC

Records a program.

FAST FORWARD/SEARCH

Fast forwards tape and forward visual search. Increases slow motion speed in Still mode.

PLAY

Begins playback.

REPEAT

Set to see a recording over and over.

REWIND/SEARCH

Rewinds tape and searches reverse scene. Decreases slow motion speed in Still mode.

STOP

Stops playback.

EJECT

Eject the tape.

TV/FM

Sets to TV/FM mode.

CHANNEL UP/DOWN

Selects a channel.

TRACKING UP/DOWN

Reduces picture noise during Playback and Slow Motion.

VOLUME UP/DOWN

Adjusts volume.

Rear View of the unit

<Model PV-DM2093 unit shown>

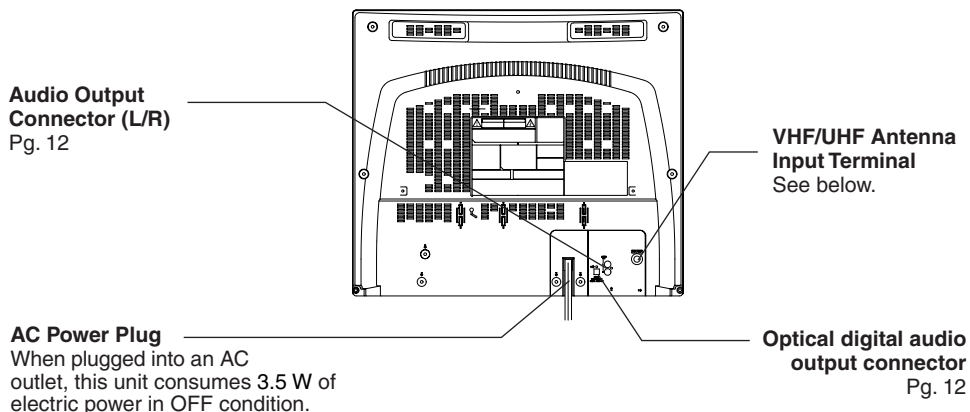

Connections

For ANT./Cable

Connect the cable from Antenna/Cable to the VHF/UHF terminal on the unit.

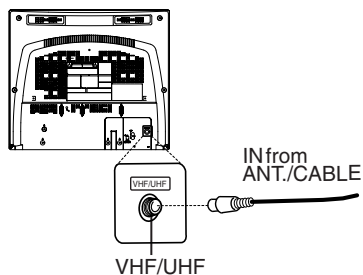

For DSS/Cable Box

Connect the OUT jack on your cable box to the VHF/UHF terminal on the unit with a RF cable.

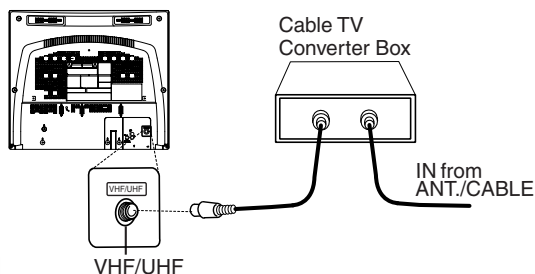

WARNING

Overtightening "Nut type" RF coaxial cables may damage jacks. Finger tighten only.

Connections (continued)

Audio connections

Enjoy the powerful movie theater and hall-like sound available with multiple channel audio found on DVDs by connecting an amplifier and speakers. There are two types of connection, digital and analog.

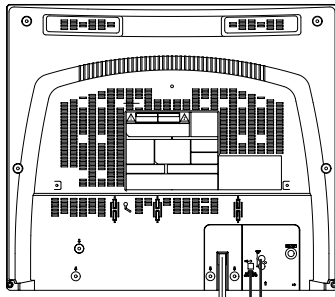

■ Digital connection

Connect an amplifier with Dolby Digital and DTS decoders to enjoy surround sound. You can also enjoy stereo sound with sampling frequencies of 48 kHz if the material isn't copy-protected and the equipment you connect is compatible with these signals.

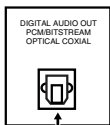

Firmly connect the cable to the connector.

OPTICAL

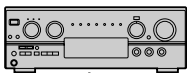

Speakers (example)

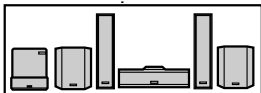

Connect three or more speakers for surround sound.

■ Analog connection

Connect an amplifier to enjoy high-quality stereo sound with sampling frequencies of 96 kHz.

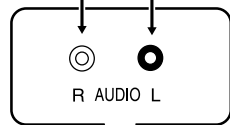

R AUDIO L

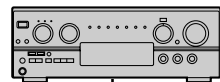

Speakers (example)

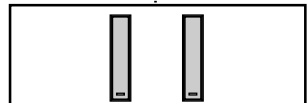

✓ Check List

- Turn down the volume, then turn this unit, as well as other equipment to be connected, off before proceeding with connection.
- Do not block ventilation holes of any equipment and arrange them so that air can circulate freely.
- Read through the instructions before connecting other equipment.
- Ensure that you observe the color coding when connecting audio and video cables.

Enjoying digital audio output from the digital audio output connector

Notes on audio output from the optical digital audio output connector

Disc	Sound recording format	Optical digital audio output from connector
DVD	Dolby Digital	Dolby Digital bitstream (1-5.1 ch) or PCM (48 kHz sampling/16 bit only)*1
	Linear PCM (48/96 kHz 16/20/24 bit)	Linear PCM (2ch) (48 kHz sampling/16 bit only)*2
	dts	Bitstream or PCM (48 kHz sampling/16 bit only)*1
Video CD	MPEG 1	PCM (44.1 kHz sampling)
CD	Linear PCM	Linear PCM (44.1 kHz sampling)
MP3	MP3	Linear PCM (It depends on the MP3 file)
WMA	WMA	Linear PCM (It depends on the WMA file)

*1 The type of audio output from the connector can be selected by the Settings for DVD Operation. (See page 59.)

*2 Sound having 96 kHz sampling is converted into 48 kHz sampling when it is output from the unit's optical digital audio output connector.

For your reference:

- Dolby Digital is a digital sound compression technique developed by the Dolby Laboratories Licensing Corporation. Supporting 5.1-channel surround sound, as well as stereo (2-channel) sound, this technique enables a large quantity of sound data to be efficiently recorded on a disc.
- Linear PCM is a signal recording format used in CDs. While CDs are recorded in 44.1 kHz/16 bit, DVDs are recorded in 48 kHz/16 bit up to 96 kHz/24 bit.
- If you have a Dolby Pro Logic Surround decoder, you will obtain the full benefit of Pro Logic from the same DVD movies that provide full 5.1 channel Dolby Digital soundtracks, as well as from titles with the Dolby Surround mark. For information on Panasonic or Technics Dolby Pro Logic Surround Sound Decoders please contact your local dealer.

IMPORTANT NOTE:

Caution for optical digital audio output connector:

- When connecting an amplifier (with an Optical digital input connector) which does not contain the Dolby Digital or dts decoder, be sure to select "PCM" at "Dolby Digital" and "PCM" at "dts" of the Settings for DVD Operation "AUDIO OUTPUT" (see page 59). Otherwise, any attempt to play DVDs may cause such a high level of noise that it may be harmful to your ears and damage your speakers.
- When a dts decoder is connected, please select "Bitstream" at "dts" of the Settings for DVD Operation "AUDIO OUTPUT." If "PCM" is selected, there will be stereo sound. (See page 59).
- Video CDs and CDs can be played as usual.

Note

- Some dts decoders which do not support DVD-dts Interface may not work properly with the unit.

Manufactured under license from Digital Theater Systems, Inc. US Pat. No. 5,451,942, 5,956,674, 5,974,380, 5,978,762 and other world-wide patents issued and pending. "DTS" is a registered trademark of Digital Theater Systems, Inc. Copyright 1996, 2000 Digital Theater Systems, Inc. All rights reserved.

Manufactured under license from Dolby Laboratories. "Dolby" and the double-D symbol are trademarks of Dolby Laboratories.

Initial Setup (Ready to Play)

Please make all cable or antenna connections before powering on.

Initial Setup (Ready to Play)

Press TV/VCR on the remote for TV-VCR mode.

1 Plug the unit power cord into an AC wall outlet.

2 Press **POWER*** on the remote or unit. The unit comes on and auto channel and clock set starts.

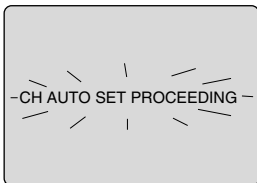

- If you use a cable box, turn it on and set it to the Public Broadcasting Service (PBS) channel in your time zone. If you use a DSS receiver, it must be turned off.

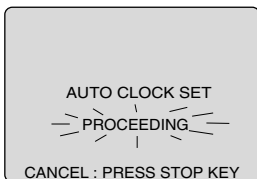

3 Settings are made automatically. When setup is done, this screen appears.

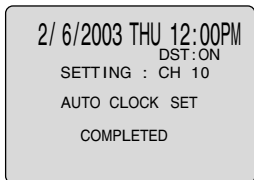

If AUTO CLOCK SET IS INCOMPLETE screen appears, set the clock using MANUAL CLOCK SET procedure on next page.

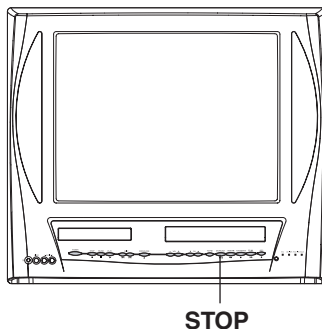
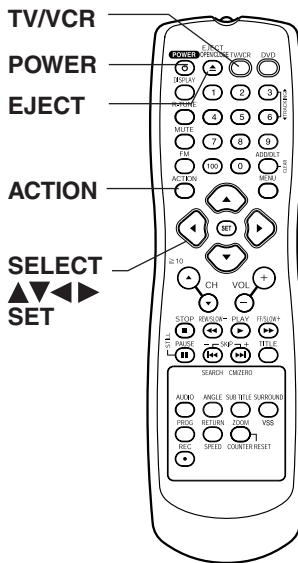
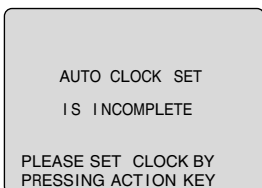

Notes

- Function buttons are inoperative during Initial Setup.
- To remove a cassette during Auto Set, press EJECT twice on the remote or STOP twice on the unit. In this case, settings must be made manually. (See pages 16-17.)
- Depending on conditions, Auto Clock Set may take longer than 30 minutes. If so, press STOP to stop setup and perform settings manually. (See pages 16-17.)

*Important: If a remote control button does not work when pressed, press the TV/VCR button on the remote and try the button again.

Manual Clock Set

If AUTO CLOCK SET was incomplete, manually set the clock as follows.

- 1 Press **ACTION** on the remote to display SET CLOCK Menu screen.

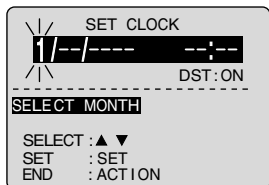

- 2 Press **▲▼** to select the month and press **SET** to set. In the same manner, select and set the date, year, time, and DST (Daylight Saving Time).

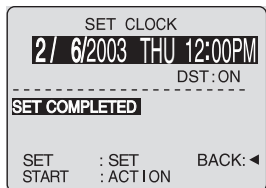

- 3 Press **ACTION** twice to start CLOCK and exit.

Reset all unit Memory Functions

When moving unit to a new location, or if a mistake was made in the Initial Setup section.

- Make sure a tape is not inserted in the unit.

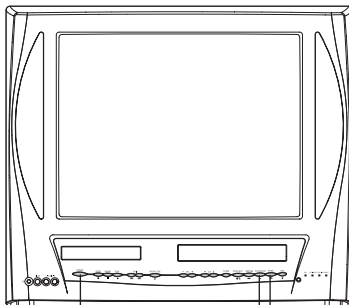

- 1 Turn the unit Power on.
- 2 Press and hold both **PLAY** and **FF** on the unit for more than 5 seconds.
 - The power will shut off.
 - Please ignore "NO CASSETTE" warning.
- 3 Perform "Initial Setup" on page 14.

Note to CABLE system installer:

This reminder is provided to call the CABLE (Cable TV) System Installers attention to Article 820-40 of the NEC that provides guidelines for proper grounding and, in particular, specifies that the cable ground shall be connected to the grounding system of the building, as close to the point of cable entry as practical.

Reset Language, Channels, Clock,

1

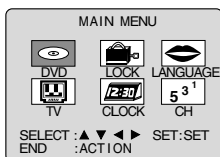

Press **ACTION***
to display MAIN MENU.

2

Language

- 1) Press **▲▼◀▶** to select language icon.

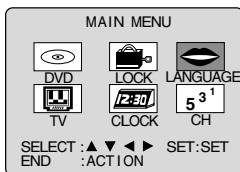

- 2) Press **SET** repeatedly.

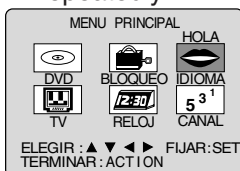

For Spanish

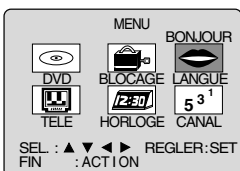

For French

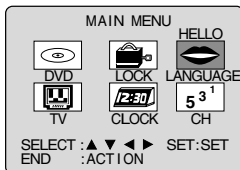

For English

- 3) Press **ACTION** to exit.

Channels

- 1) Press **▲▼◀▶** to select "CH."

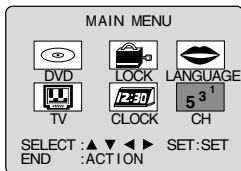

- 2) Press **SET**.

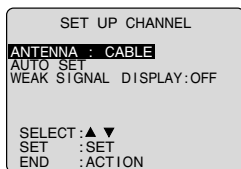

- 3) Press **▲▼** to select "ANTENNA," then press **SET** to set your antenna system ("TV" or "CABLE").

- 4) Press **▲▼** to select "AUTO SET," then press **SET**.

- After Channel Auto Set is finished, Clock Auto Set will be performed. (If clock is set manually, Clock Auto Set will not be performed.)

Clock

- 1) Press **▲▼◀▶** to select "CLOCK."

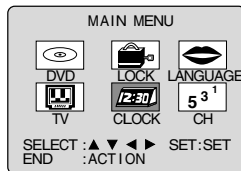

- 2) Press **SET**.

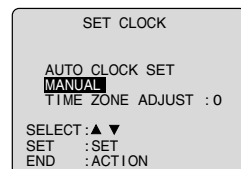

("TIME ZONE ADJUST" appears only when auto clock is set.)

- 3) Press **▲▼** to select "MANUAL," then press **SET**.

(For Auto Clock Set, select "AUTO CLOCK SET," and press **SET**.)



<Example MANUAL CLOCK SET screen>

Continued on
the next page.

Time Zone Adjust

*Important:

If a remote control button does not work when pressed, press the TV/VCR button on the remote and try the button again.

- 4) Press **▲▼** and press **SET** to select and set the month, date, year, time, and DST (Daylight Saving Time).

To Make Corrections, repeatedly press **◀▶** to move to error, then correct.

- 5) Press **ACTION** twice to start the clock and exit this mode.

Time Zone Adjust

(Only when Auto Clock is set.)

- 1) Press **▲▼◀▶** to select "CLOCK."

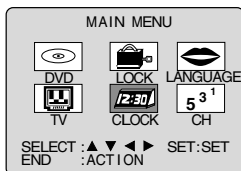

- 2) Press **SET**.

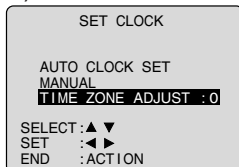

- 3) Press **▲▼** to select "TIME_ZONE_ADJUST" and press **◀▶** to subtract or add hour(s) as necessary.

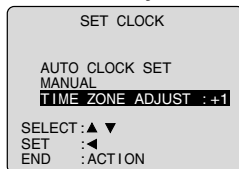

- 4) Press **ACTION** twice to exit.

- "TIME_ZONE_ADJUST" returns to "0" if clock is set manually.

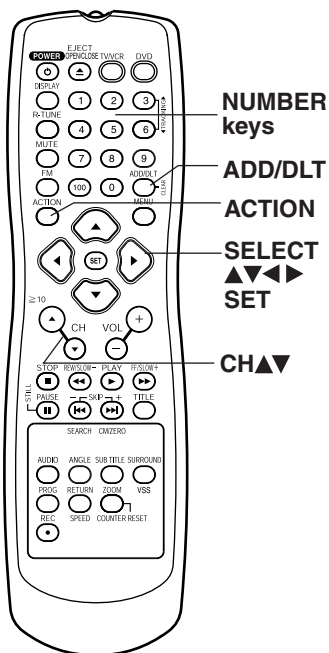

Add or Delete a Channel

To add channel:
Select channel with **NUMBER** keys and press **ADD/DLT**.

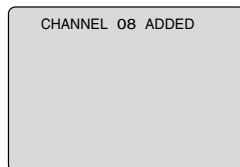

To delete channel:
Select channel with **CH ▲▼** or **NUMBER** keys and press **ADD/DLT**.

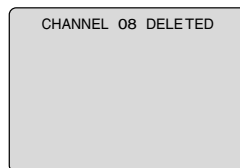

Playback a Tape

Record On a Tape

✓ Check List

- Cable or antenna is connected.
- Power cord is plugged in.

1 Insert a cassette.

- The unit power comes on automatically.

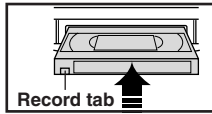

To prevent tape jam, remove loose or peeling labels from tapes.

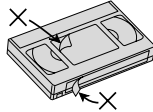

2 Press PLAY* to play a tape.

- If tape has no record tab (see page 4), auto play begins.

■ Forward/Reverse scene search

- Press FF/SLOW+ or REW/SLOW-.
- Press again or PLAY to release.

■ Still (Freeze) picture

- Press STILL/PAUSE.
- Press PLAY to release.

■ Slow Motion picture

- Press FF/SLOW+ (increases speed) or REW/SLOW- (decreases speed) in Still mode.
- Press PLAY to release.

■ Frame by Frame picture

- Press STILL/PAUSE in Still mode.
- Press PLAY to release.

Notes

- These features work best in SP or SLP mode.
- After the unit is in Still or Slow mode for 3 minutes, it will switch to Stop mode automatically to protect the tape and the video head.

■ Stop → Press STOP

■ Rewind tape → Press REW/SLOW- in Stop mode

■ Fast forward tape → Press FF/SLOW+ in Stop mode

■ Eject tape → Press EJECT on the remote or STOP/EJECT on the unit

Operation using unit buttons

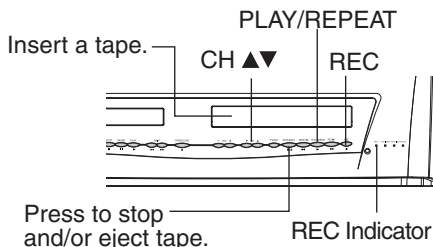

1 Insert a tape with record tab.

- The unit power comes on automatically.

2 Press CH ▲▼ or NUMBER keys to select a channel.

- For "LINE" input, see bottom of next page.

3 Press SPEED to select recording speed (see page 4).

SP = Standard Play

LP = Long Play

SLP = Super Long Play

- Selected speed is displayed.

4 Press REC to start recording.

- To edit out unwanted portions, press STILL/PAUSE to pause and resume recording.
- You cannot view another channel during recording.

■ Stop → Press STOP

■ One Touch Recording (OTR)

[recording in progress]

Press REC

repeatedly to set the recording

length (30 min - 4 hours.)

- The unit stops recording at a preset time.
- PROG TIMER Indicator lights on the unit.

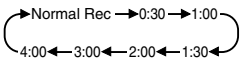

Notes

- It is not possible to record from DVD/Video CD/CD to VHS tape using this unit.

- After the unit has been in Rec Pause mode for 5 minutes, it will stop automatically to protect the tape and the video head.
- The remaining recording time of an OTR can be displayed by pressing DISPLAY.

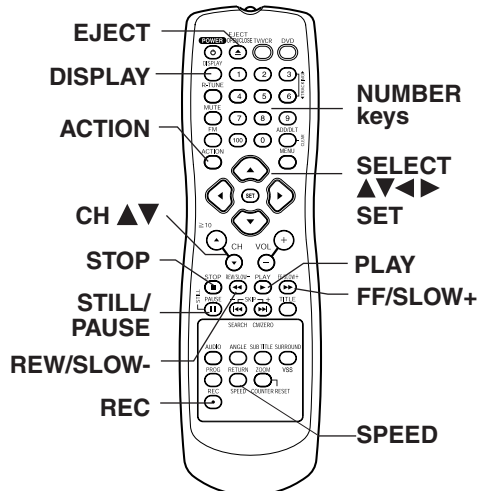

Copy Your Tapes (Dubbing)

*Important: If a remote control button does not work when pressed, press the TV/VCR button on the remote and try the button again.

Connections you'll need to make

Playing (Source) VCR



Recording (Editing) unit

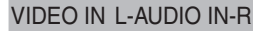

Basic Operation

Playback (Source)

1 Insert pre-recorded tape.

Recording (Editing) unit

Insert blank tape with record tab.
 • Dubbing tapes protected with Copy Guard will have poor quality results.

2 _____ Select "LINE" mode.
See "Selecting Input Mode" below.

3 Press **PLAY** then press **PAUSE** at starting point to put in Standby mode.

Press **REC**, then press **STILL/PAUSE** immediately to put in Standby mode.

(Perform operation of steps 4 and 5 on both units at same time.)

4 Press **PLAY** to start dubbing.

Press **STILL/PAUSE** to start dubbing.

5 Press **STOP** to stop dubbing.

Press **STOP** to stop dubbing.

Selecting Input Mode

Method 1:
Press **CH ▲▼**. The display will change as follows.

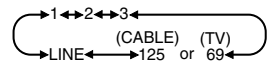

- Method 2:**
- Press **ACTION** for MAIN MENU.
 - Press **▲▼◀▶** to select "TV," then press **SET** for SET UP TV screen.
 - Press **▲▼** to select "INPUT SELECT," and then press **SET** to select "TUNER" or "LINE."
 - Press **ACTION** twice to exit this mode.

Caution

- Unauthorized exchanging and/or copying of copyrighted recordings may be copyright infringement.
- Please note that some tapes cannot be dubbed on this unit. Also, it is not possible to dub DVD/Video CD/CD to VHS tape using this unit.

Basic DVD Operation

✓ Check List

- Cable or antenna is connected.
- Power cord is plugged in.
- If unit is connected to an audio amplifier, turn the stereo system's power on.

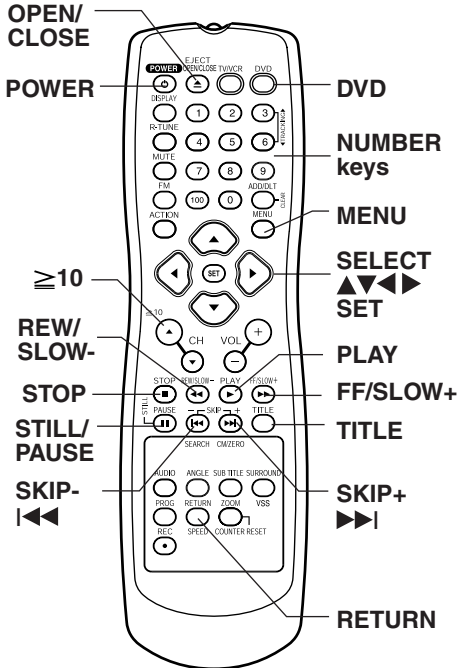

Operation using unit buttons

3 Press PLAY.

2 Insert disc.

2-6 Press OPEN/CLOSE.

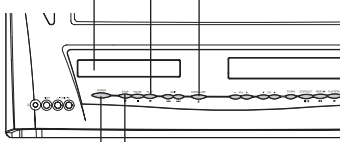

1 Press POWER.

5 Press STOP.

*1 Interactive DVD...
May include multiple camera angles, stories, etc.

*2 Video CD with playback control...
Particular scenes or information can be interactively selected from a menu that appears on the screen.

1 Press POWER* on the remote or unit.

2 Insert a disc.

- If a disc is already inserted, go to step 3.
(Depending on the disc, playback may start automatically.)

1) Press OPEN/CLOSE.

2) Place disc into disc tray.

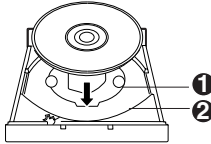

- Hold disc by its edges only (page 7) with printed side up and use guides to place into tray. Use **1** 3" (8 cm) or **2** 5" (12 cm) disc.

3 Press PLAY to start play. Disc tray closes automatically.

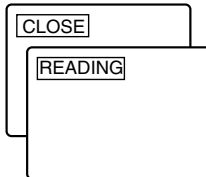

- You may also close the tray by pressing OPEN/CLOSE.
- Data reading time differs with each disc.

<Example 1>

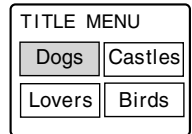

If an interactive DVD*1 or a Video CD with playback control*2 is used and a TITLE MENU appears, go to step 4.

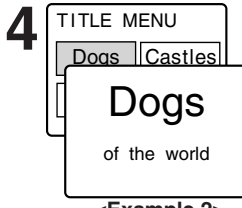

Press **▲▼◀▶** or **NUMBER** key(s) (see below) to select title, and press **SET** or **PLAY** to start playing.
• "Pressing SET or PLAY" is not necessary when using **NUMBER** keys.

Using **NUMBER** key(s) starts play automatically. The number of available titles varies with each disc.

<Input Example>

1 digit number 1...1

2 digit number 12...≥10→1→2

3 digit number 123...100→1→2→3

Press **SKIP+ ▶▶|** or **SKIP- |◀◀** to go to next or previous menu screen.

- SKIP function not available with all discs.

Please refer to disc jacket for operation information.

To return to MENU (play stops)

Press **TITLE**, **MENU**, or **RETURN**. (DVD)

Press **RETURN**. (Video CD)

5 Press STOP to stop play.

6 Press OPEN/CLOSE to eject the disc.

*Important: If a remote control button does not work when pressed, press the DVD button on the remote and try the button again.

■ Forward/Reverse rapid scene search

- Press **FF/SLOW+** or **REW/SLOW-** during play.
- Press **PLAY** to release.

- Starting forward/reverse search during play started from menu on Video CDs may recall menu.
- Search speed, slow at first, increases with each additional press of the button up to 5 levels.

■ Forward/Reverse Chapter/Track Skip

- Press **SKIP+ ►►►** or **SKIP- ◄◄◄** during play.

Each **press skips** a chapter (DVD) or track (Video CD/CD).

Pressing SKIP- ◄◄◄ once midway through a chapter/track returns to start of that chapter/track. Each additional press skips back one chapter/track.

- **Pressing SKIP+ ►►►** or **SKIP- ◄◄◄** during play started from menu on Video CDs may recall menu.

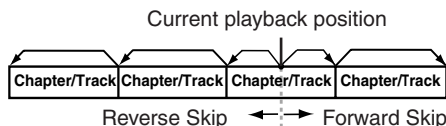

■ Still (Pause) Picture

- Press **STILL/PAUSE** during play.
- Press **PLAY** to release.

- **DVD/Video CD** : The unit will enter Still picture mode.
- **CD** : The unit will enter Pause mode.

■ Frame by Frame picture (DVD/Video CD)

- Press **STILL/PAUSE** in Still mode.
- Press **PLAY** to release.

- Each press advances picture one frame.
- Hold down for consecutive frame advance.
- Whether pictures are advanced by "FRAME" or "FIELD" is selected automatically (see page 60).

■ Slow Motion picture (DVD/Video CD)

- Press **FF/SLOW+** or **REW/SLOW-** (DVD only) in Still mode.
- Press **PLAY** to release.

- Slow motion speed, slow at first, is increased with each additional press of the button up to 5 levels.
- Reverse slow motion is not available for video CDs.

- When  appears on the screen while a button is being pressed, it means that the corresponding operation is prohibited by the unit or the disc.

RESUME function

The unit memorizes the point where **STOP** is pressed (**STOP ►** display on the screen).

Press PLAY to resume play from this point.

Pressing STOP again or opening the tray cancels **RESUME**, however, **RESUME** is not canceled when power is turned off and on.

- **RESUME** works only with discs for which elapsed play time is displayed during play.

Auto-Power Off function

Power turns off after unit has been in Stop mode (DVD) for about 5 minutes.

Enjoy Video CDs featuring playback control without using menus (Video CDs only)

1. Do steps 1-3 (previous page).
When menu appears, **press STOP**.
2. **Press NUMBER key(s)** to select desired track (play begins).
 - Check disc for track numbers.
 - Press "1" to start at beginning of disc.

To Resume Menu use, **Press STOP**, and **press PLAY**, then the menu appears. Now, go to step 4 (previous page).

Notes

- Please read the disc jacket for operation information.
- If a single sided disc is placed in upside down, "THIS TYPE OF DISC CANNOT BE PLAYED. PLEASE INSERT A DIFFERENT DISC" is displayed.
- Remove disc and press unit **POWER** off when not in use.
- Disc continues to rotate with menu displayed even after play is done. Press **STOP** to clear menu display when finished with menu.

TV Operation

***Important:** If a remote control button does not work when pressed, press the TV/VCR button on the remote and try the button again.

1 Press **POWER*** on the remote or unit.

2  Use **CH ▲▼** or **NUMBER** keys to select a channel.

3  Press **VOL +** or **VOL -** to adjust volume.

Check List

- Cable or antenna is connected.
- Power cord is plugged in.

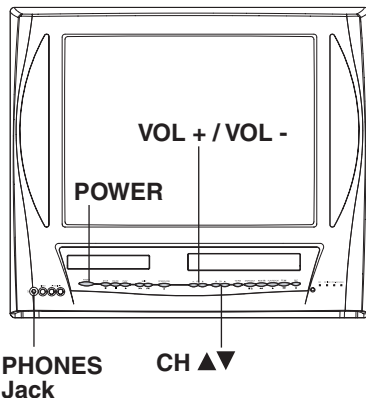

■ Using the 100 key

When selecting **CABLE** channels 100 to 125 with the **NUMBER** keys, first press the 100 key, and then enter the remaining two digits.

■ Rapid Tune

Press **R-TUNE** to display the last channel you were watching.

■ Audio Mute

Press **MUTE** to instantly mute the sound. Press again to restore the previous sound level.

■ Phones

Connect an earphone (not supplied) or headphones (not supplied) to the Phones Jack.

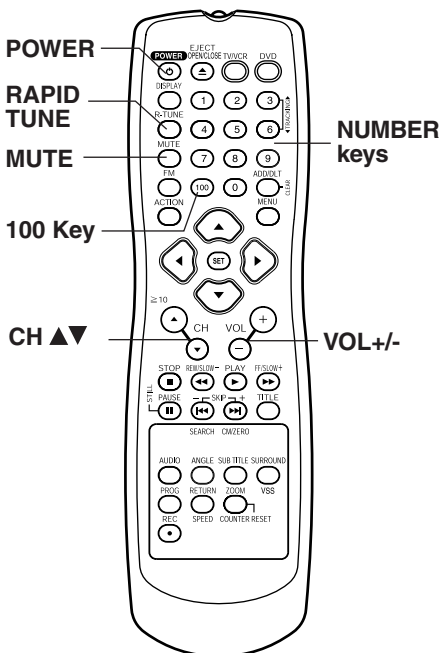

MTS Broadcast/TV Stereo System

Equipped with **dbx**[®]-TV Noise Reduction for true MTS reproduction. **dbx**[®]-TV Noise Reduction is required for good stereo separation and audio fidelity. **dbx**[®] is a registered trademark, and is licensed by **dbx**[®] Technology Licensing.

Receivable Broadcast Types

The following are possible audio broadcast types and on-screen displays. The signal being received is indicated with an "Ⓢ" mark while the selected audio mode is indicated with an arrow. To change the audio mode for these broadcasts, see the "Audio Mode for TV Viewing" section below.

Press DISPLAY to display the broadcast signal being received.

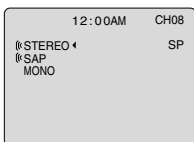
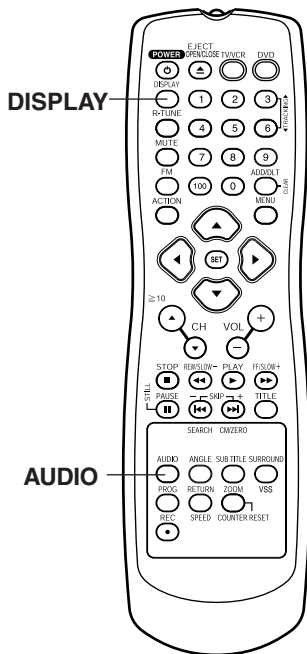

MTS Stereo and SAP broadcast

Multi-channel Television Sound Stereo (main language) and Secondary Audio Program (sub language) broadcasts are being received simultaneously. Select the STEREO or SAP audio mode.

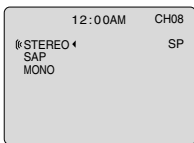

MTS Stereo broadcast

Multi-channel Television Sound Stereo broadcast. Select STEREO audio mode.

- If stereo broadcast is weak and the display flickers, select MONO audio mode for possible improvement.

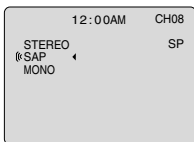

SAP broadcast

Secondary Audio Program (sub language). Select SAP audio mode for the sub language.

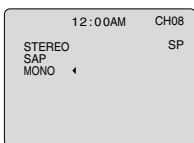

MONO broadcast

Normal monaural sound broadcast.

Audio Mode for TV Viewing

Press AUDIO to select the desired audio mode as described above. (Arrow shows selection.)

- Each press of AUDIO will change the audio mode as shown below.
- "SAP" is selected with first press of AUDIO.

< Example >

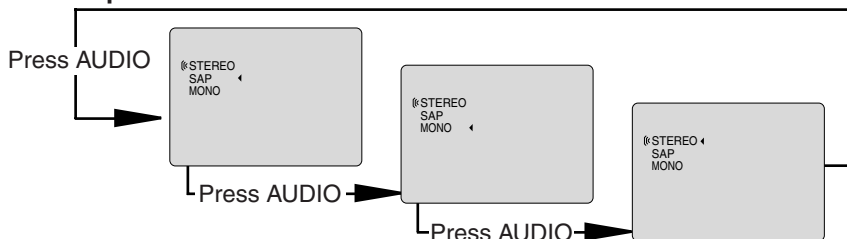

Closed Caption System

Closed Caption is ...

This multi-use system not only allows the hearing impaired to enjoy selected programs, but also makes useful information from TV stations available to everyone.

Closed Caption Mode Feature

1 Press **ACTION*** to display MAIN MENU.

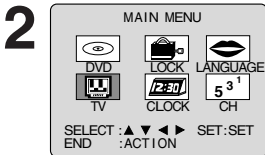

- 1) Press **▲▼◀▶** to select "TV."
- 2) Press **SET** to display SET UP TV screen.

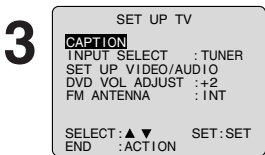

- 1) Press **▲▼** to select "CAPTION."
- 2) Press **SET** to display CAPTION screen.

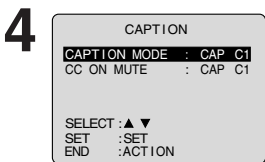

- 1) Press **▲▼** to select CAPTION MODE.
- 2) Press **SET** repeatedly to select mode. (See left.)



5 Press **ACTION** three times to return to the normal screen.

Closed Caption Mode Selections

Caption Mode: CAP C1 or C2

A narration of selected TV programs is displayed. Check TV program listings for CC (Closed Caption) broadcasts.

Caption Mode: TEXT C1 or C2

Most of the screen will be blocked out. When the TV station broadcasts information, such as program listings, it will appear in this space.

Caption Mode: OFF

Closed Caption/Text narration will not be displayed.

Notes

- The closed caption or text signal may be broadcast over C1, C2, or both. Also, text contents can vary so you may wish to try different settings.
- While recording one station and watching another, Captioning will not be displayed.

Recording and Playing Back a Closed Caption/Text Program

Record : Record normally. Closed Caption/Text signal, if present, is recorded automatically.

Playback : Start playback. Perform above steps to select desired caption mode.

*Important: If a remote control button does not work when pressed, press the TV/VCR button on the remote and try the button again.

Caption On Mute Feature

Closed Caption narration, if available, is displayed when MUTE button is pressed for silence.

1 Press ACTION to display MAIN MENU.

2

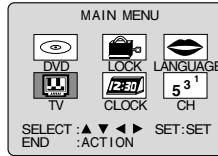

- 1) Press ▲▼◀▶ to select "TV."
- 2) Press SET to display SET UP TV screen.

3

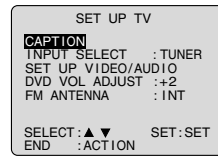

- 1) Press ▲▼ to select "CAPTION."
- 2) Press SET to display CAPTION screen.

4

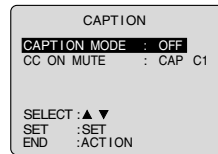

- 1) Press ▲▼ to select CAPTION MODE.
- 2) Press SET repeatedly to select "OFF."

5

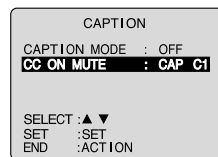

- 1) Press ▲▼ to select CC ON MUTE.
- 2) Press SET repeatedly to select desired mode.
 - Each press of SET will change the display as shown left.
 - The caption may be broadcast over CAP C1 or C2.

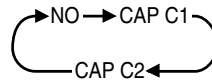

6

Press ACTION three times to return to the normal screen.

7

Press MUTE to mute the sound and display closed captioning.

- To cancel, press MUTE again.

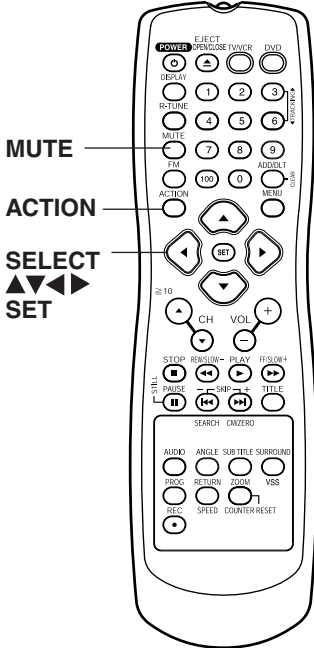

MUTE

ACTION

SELECT
▲▼◀▶

SET

Note

- When a disc supporting closed caption is used, the subtitle and the closed caption may overlap. In this case, turn the subtitle or caption on mute mode off. (See page 46.)

TV Timer Features

ON-TIMER with Alarm

This unit can be set to automatically power on in one of 4 modes (TV, VCR Playback, FM radio, or DVD/Video CD/CD.) You can also combine the On-Timer with a one minute alarm that gradually increases in volume.

1 Press **PROG*** to display SET PROGRAM screen.

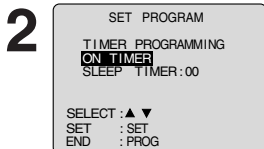

- 1) Press **▲▼** to select "ON TIMER."
- 2) Press **SET** to display ON TIMER screen.

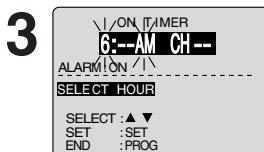

- 1) Press **▲▼** to select desired settings.
- 2) Press **SET** to set the ON-TIMER time or ON-TIMER mode.

- ON-TIMER mode selection order

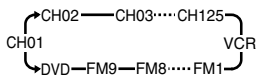

- Make sure a tape is inserted if Playback mode is selected.
- Make sure a disc is inserted if DVD (DVD/Video CD/CD) mode is selected.
- See "FM Radio" on pages 28 and 29 for instructions on how to preset FM stations.

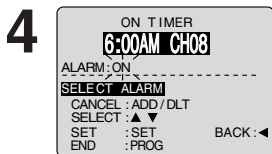

Press **▲▼** to select ALARM "ON" or "OFF."

When "ON" is selected, an alarm will gradually increase in volume for one minute or until canceled by pressing any button (including VOL + -).

To Make Corrections, use **▲▼** and **◀▶** to move back and correct.

5 Press **PROG** to set ON TIMER.

- "ON TIMER SET" is displayed.
- ON-TIMER Indicator lights up on the unit.

To Cancel ON-TIMER,

Repeat steps 1 and 2. Then, press **ADD/DLT** to clear the time in step 3. Now, press **PROG** to end. "ON TIMER END" briefly appears on-screen.

✓ Check List

- The clock is set to the correct time.

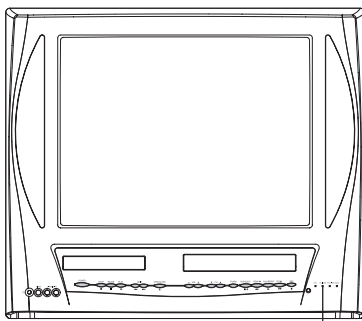

ON-TIMER Indicator

Sleep Timer

This unit can be set for auto power off.

1 Press **PROG** to display SET PROGRAM screen.

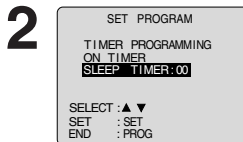

- 1) Press **▲▼** to select SLEEP TIMER.
- 2) Press **SET** repeatedly to select the desired time.

SLEEP TIMER 30 → 60 → 90 → 00

To cancel, press **SET** repeatedly until 00 appears.

3 Press **PROG** to return to the normal screen.

- Pressing **DISPLAY** with sleep timer set displays remaining time.

Note

- If no button on the remote or unit (including a button used to turn off the alarm) is pressed within 60 minutes after unit turns itself on, it will turn itself back off.

On-Screen Display (OSD)

*Important: If a remote control button does not work when pressed, press the TV/VCR button on the remote and try the button again.

TV/VCR Status & Clock Display

Press **DISPLAY** to display or remove the overlay.

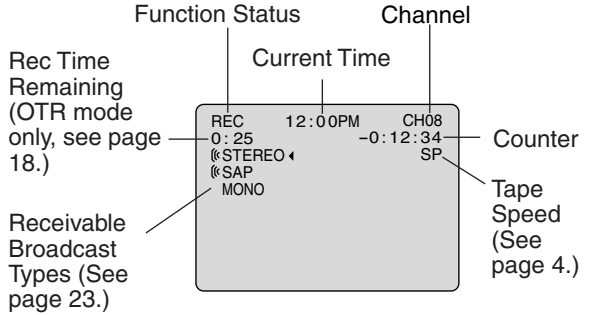
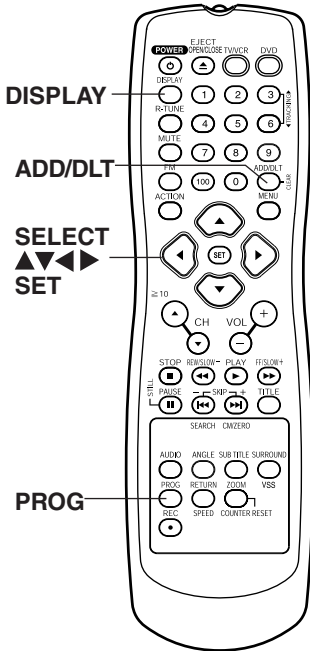

Blue Screen Display

Whenever a blank section of a tape comes up in Playback mode, or when the selected channel has no broadcast signal with the Weak Signal Display Feature set to "OFF" (see page 36), the screen will turn solid blue.

Channel & Function Display

When a function button is pressed (PLAY, FF, etc.) or you change channels, the unit mode or channel number will be displayed.

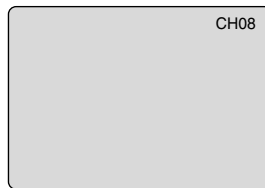

FM Radio

FM Radio is ...

This unit has an FM radio with built-in antenna, 9 station preset, and a band range of 87.5 ~ 108.1 MHz. You can set the On-Timer (page 26) to wake up to your favorite radio station.

FM Radio Setup

- 1 Press **FM*** on the remote or **TV/FM** on the unit to display FM radio mode.

2

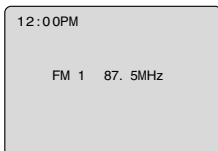

Press a **NUMBER** key (1~9) to select the FM preset number.

3

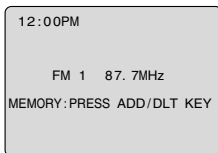

1) Press **CH ▲▼** to select the desired radio station. (Each press changes frequency by 200 kHz.)

2) Press **ADD/HLT** to set the radio station.

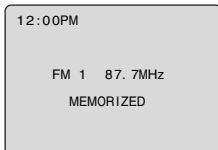

Hold down **CH ▲** or **▼** for a few seconds, then release to quickly scan for FM stations in your area.

- To cancel, press **CH ▲** or **▼** while in search mode.

To Make Corrections, select station with a **NUMBER** keys, then do step 3 again.

To exit FM mode, press **TV/VCR** or **DVD** on the remote or **TV/FM** on the unit.

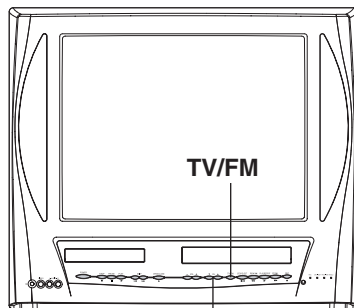

FM Antenna Setup

Make sure FM tuning is done correctly (see FM Radio Setup).

- 1 Press **ACTION** to display MAIN MENU.

2

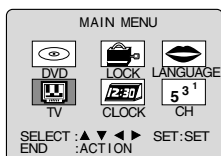

- 1) Press **▲▼◀▶** to select "TV."
- 2) Press **SET** to display SET UP TV screen.

Continued on next page.

*Important: If a remote control button does not work when pressed, press the FM button on the remote and try the button again.

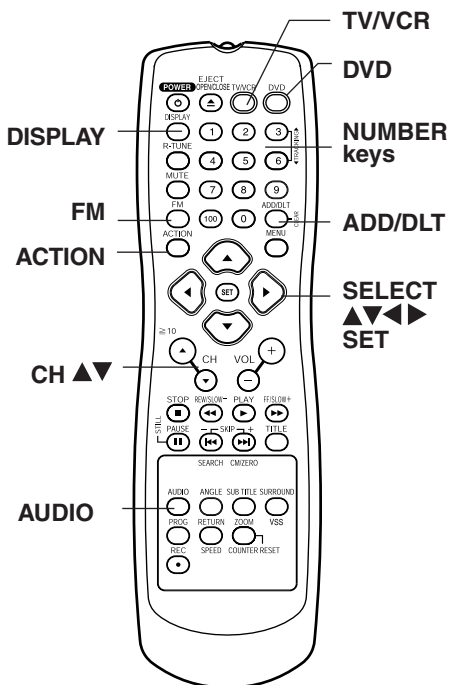

3

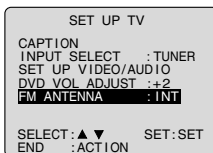

- 1) Press ▲▼ to select FM ANTENNA.
- 2) Press SET to select "INT (INTERNAL)" or "EXT (EXTERNAL)" to determine which one sounds best.

- For cable TV users → "INT"
- For antenna users → "EXT"

4

Press ACTION twice to end setup.

Using FM Radio

1

Press FM on the remote or TV/FM on the unit to display FM radio mode.

2

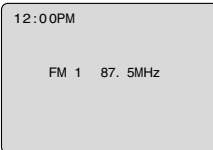

Press a NUMBER key (1~9) to select a preset FM number (see FM Radio Setup on page 28).

To exit FM mode, press TV/VCR or DVD on the remote or TV/FM on the unit.

Notes

- FM radio cannot be recorded on a Video cassette.
- You may get better reception by repositioning the unit.
- You cannot select FM Radio mode during playback or record, or while a blue back screen (PROG, ACTION, MENU) is displayed.
- Once stations are set, the selected station and current time are displayed when FM Radio mode is entered. To remove time, press DISPLAY. If DISPLAY is pressed again, the unit status screen appears.

Audio Mode for FM Radio

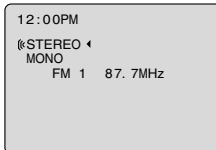

Press AUDIO repeatedly to select "STEREO" or "MONO" in FM Radio mode.

Timer Recording

You can set up to 8 programs to be recorded while you are away.

1 Press **PROG*** to display SET PROGRAM screen.

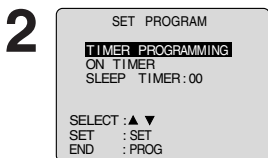

1) Press **▲▼** to select **TIMER PROGRAMMING**.
2) Press **SET** to display screen.

- If a program is already in memory, press **▲▼**, and **SET** to select an unused program number.

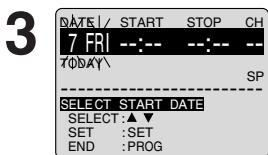

Press **▲▼** to select and **SET** or **◀▶** to set the recording DATE.
 • 1~31 = One time
 • DAILY = MON~FRI
 • WEEKLY SUN~SAT = Same time once a week

Example

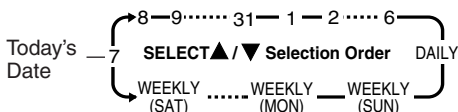

Repeat step 3 to set:

- Start time, Stop time
- Channel (or LINE for outside source)
- Speed (SP, LP, SLP)

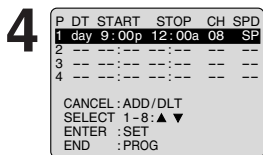

Press **PROG** to end the program.

To Enter More Programs, press **▲▼** to select and **SET** to set a blank program number, and then repeat step 3.

5 Press **PROG** twice to exit this mode.
 • If you're using a cable box, make sure that it is tuned to the desired channel and the power is left on for timer recording.
 • PROG TIMER Indicator lights up on the unit.

✓ Check List

- Cable or antenna is connected.
- Power cord is plugged in.
- The clock is set to correct time.
- The tape is long enough.
- The record tab is in place.

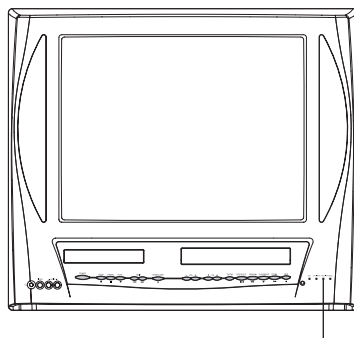

PROG TIMER Indicator

*Important: If a remote control button does not work when pressed, press the TV/VCR button on the remote and try the button again.

Cancel a Timer Recording: (Recording is in progress)

Hold down **STOP** for a few seconds to cancel the Timer Recording.

- Any future daily or weekly recordings will be performed as programmed.

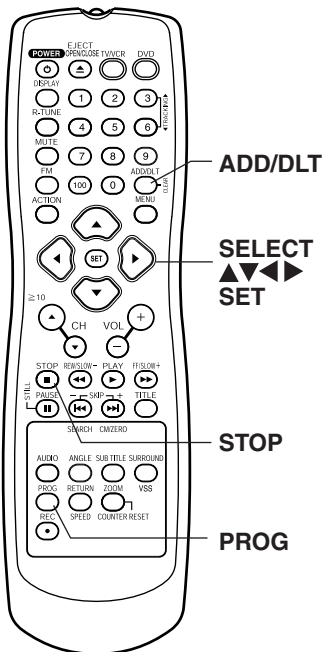

Review, Replace or Clear Program Contents : (Recording is not in progress)

1 Repeat steps 1 and 2 on page 30.

2

P	DT	START	STOP	CH	SPD
1	cdv	9:00a	12:00a	03	SP
2	8	10:00a	12:00p	125	SP
3	10	8:00p	9:00p	10	SP
4	SU	9:00p	10:00p	L	LP

CANCEL : ADD/HLT
SELECT 1-8: ▲▼
ENTER : SET
END : PROG

Press **▲▼** to select the desired program.

3

To Replace program...

DATE	START	STOP	CH
8 SAT	9:00P	12:00A	03
SLP			

SELECT: ▲▼	START	DATE	
SET : SET			BACK: ◀
END : PROG			

- 1) Press **SET** to display.
- 2) Press **▲▼** to select and press **SET** or **◀▶** to set new program contents.
- 3) Press **PROG**.

To Clear program...

P	DT	START	STOP	CH	SPD
1	--	--	--	--	--
2	8	10:00p	12:00a	125	SP
3	10	8:00p	9:00p	10	SP
4	SU	9:00p	10:00p	L	LP

SELECT 1-8: ▲▼
ENTER : SET
END : PROG

Press **ADD/HLT**.

4 Press **PROG** twice to exit this mode.

Notes

- 2 minutes before Timer recording is performed, "PLEASE PREPARE FOR TIMER REC" appears and/or the PROG TIMER Indicator flashes. Be sure a cassette with record tab is loaded and the unit is in Stop mode.
- If the start times of two programs overlap, the lower numbered program will have priority.
- If the start time for a Timer Recording comes up during a normal recording or One Touch Recording (page 18), the Timer Recording will not be performed.
- If there is a power interruption of more than one minute, the recording may not be performed or continued.
- If "INCOMPLETE" appears after all items have been set, check all entries and make necessary corrections.

*Important: If a remote control button does not work when pressed, press the TV/VCR button on the remote and try the button again.

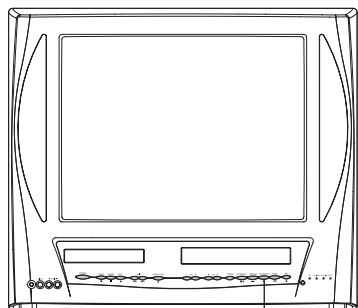

PLAY/REPEAT

Repeat Play

Set to see a recording over and over.

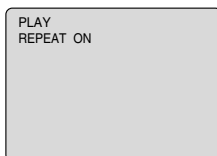

To turn “ON,”
press **PLAY/REPEAT** on the unit repeatedly in Playback mode to select “REPEAT ON.”

To turn “OFF,”
repeat above to select “REPEAT OFF.”

- Playback repeats when tape end is reached or an unrecorded portion longer than 30 seconds is detected.

Note

- For repeat play in DVD mode, see page 53.

Tape Operation (continued)

Zero Search

To quickly return to a specific tape counter location.

- 1 Press **DISPLAY*** during playback to display the Counter.

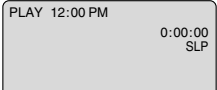
- 2  Press **COUNTER RESET** at the desired position to reset to "0:00:00."

- 3 Continue playback, rewind, or fast forward.

- 4 Press **STOP**.

- 5 Press **CM/ZERO** in stop mode to start ZERO SEARCH.

- Unit goes into FF or REW mode and stops at the last point the Counter was set to 0:00:00.

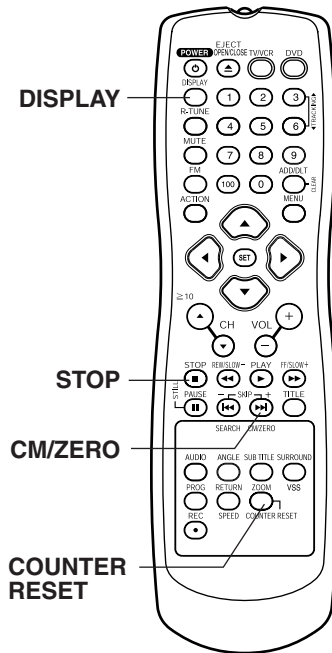

*Important: If a remote control button does not work when pressed, press the TV/VCR button on the remote and try the button again.

Auto Operation Functions

■ Auto Shut Off

No broadcast signal in TV mode (Only when Weak Signal Display is set to OFF.), DVD stops, or blank tape is played for 5 minutes.

→ Power turns off

- This feature is canceled if any button is pressed during above conditions.

■ Auto Playback

Insert a tape in Power off mode

→ Power turns on

- Playback begins if tape has no record tab.

■ Auto Rewind (except for Recording)

Tape reaches its end

→ Rewind, → Stop

■ Playback Auto Eject (Repeat Play is "OFF")

Tape with no record tab reaches its end

→ Rewind, → Stop, → Eject

Commercial Skip

By pressing the CM/ZERO button in Playback mode you can skip over 1 to 3 minutes of recorded tape in just a few seconds.

Press CM/ZERO repeatedly to select skip time in Playback mode.

- No indication appears.

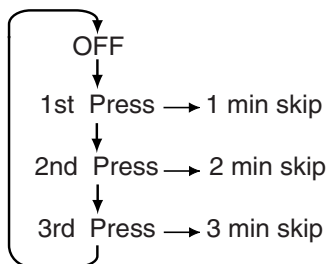

Special VCR Features

Weak Signal Display Feature

When "ON" is selected, the picture is displayed even when a broadcast signal is weak or non-existent.

1 Press **ACTION*** to display MAIN MENU.

2

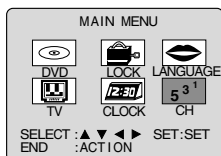

- 1) Press **▲▼◀▶** to select "CH."
- 2) Press **SET** to display SET UP CHANNEL screen.

3

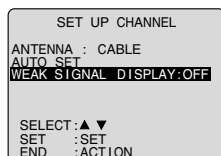

- 1) Press **▲▼** to select WEAK SIGNAL DISPLAY.
- 2) Press **SET** to set "ON" or "OFF."

Notes

- "ON" = Picture is displayed regardless of signal condition, and may not always be clearly visible.
- "OFF" = Screen turns solid blue when signal is absent or weak.
- If unit is connected to equipment which has blue back feature, selecting "ON" will have no effect on the other equipment.

4 Press **ACTION** twice to return to the normal screen.

Check List

- It is necessary to enter TV mode by pressing TV/VCR before selecting "CH" on the MAIN MENU.

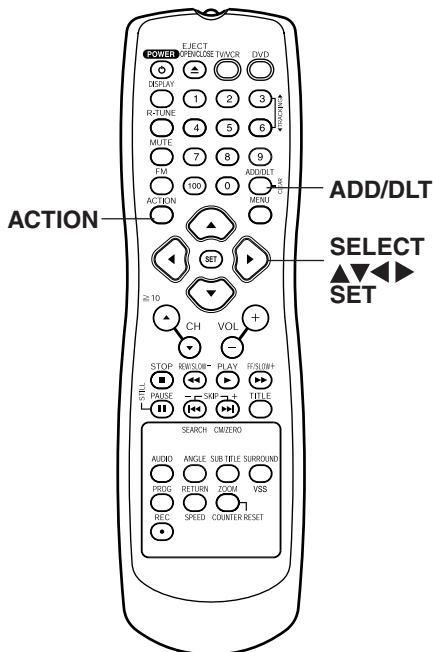

*Important: If a remote control button does not work when pressed, press the TV/VCR button on the remote and try the button again.

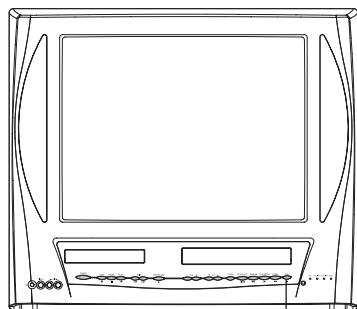

REC

VCR Lock

All operations are prohibited except Timer recording and tape eject. Useful for families with small children.

VCR LOCK ACTIVATED

VCR LOCK OFF

In Stop mode, **hold down REC** on the unit without a cassette inserted for 7 seconds to turn "ON." (Please ignore "NO CASSETTE" warning.) Repeat above with or without cassette to turn "OFF."

- VCR Lock is canceled automatically after about 24 hours if clock is set.

V-Chip Control Feature

V-Chip Control Feature is...

This unit has a built-in V-Chip Control which allows you to block unwanted TV usage based on US MOVIES and US TV PROGRAMS Ratings.

Process of V-Chip Control Feature

Enter Code → **Setup** → **Blocking**

Enter Secret Code

A 4-digit code must be entered to view a blocked program or change rating settings.

1 Press **ACTION*** to display MAIN MENU.

2

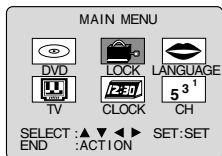

- 1) Press **▲▼◀▶** to select "LOCK."
- 2) Press **SET** to display LOCK screen.

3

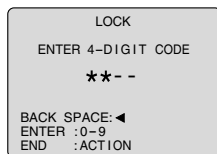

- 1) Press **NUMBER** keys to enter your secret code.
- 2) Enter same code again for confirmation.

- Step 2) not necessary when changing rating or secret code.
- Take care that you are not observed entering the secret code.

To Make Corrections

Press **◀** repeatedly to move the cursor.

Press **NUMBER** keys to make the correction.

4

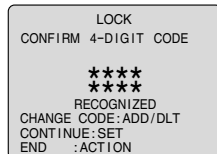

Press **SET** to display US Ratings menu (see pages 39-40).
Or
Press **ACTION** twice to exit.

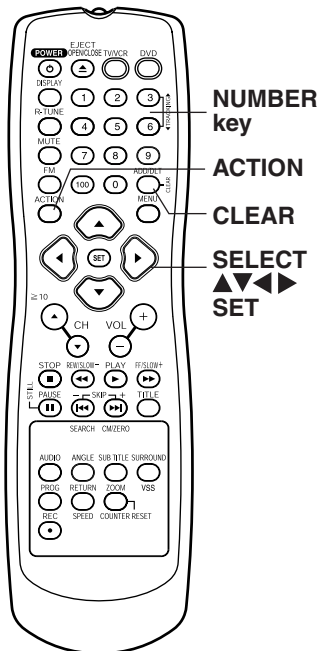

Changing your secret code

- You will need your current code.

Do steps 1 ~ 3. In step 4, press **CLEAR** to clear current code.

Repeat steps 3 and 4 to enter new code.

Notes

- Some rental movies do not include V-Chip data.
- DO NOT forget your secret code.
- Once ratings are set, restricted tapes or programs cannot be accessed unless the secret code is entered.

*Important: If a remote control button does not work when pressed, press the TV/VCR button on the remote and try the button again.

If LOCK menu is not displayed, perform “Enter Secret Code” steps on page 38.

Process of V-Chip Control Feature

Enter Code → Setup → Blocking

US MOVIES Ratings

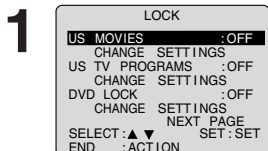

- 1) Press ▲▼ to select US MOVIES.
- 2) Press SET to set “ON” or “OFF.”

- “ON” → V-Chip Control is activated.
- “OFF” → V-Chip Control is deactivated.

Note

- “NEXT PAGE” displays CANADIAN V-Chip setting menu. Not necessary except when viewing Canadian tapes or broadcasts.

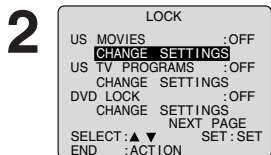

- 1) Press ▲▼ to select CHANGE SETTINGS.
- 2) Press SET to display screen.

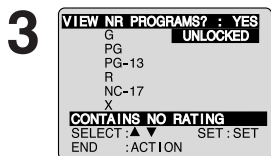

- 1) Press ▲▼ to select VIEW NR PROGRAMS?.
- 2) Press SET to set “YES” or “NO.”

NR (Not Rated) PROGRAMS

Some movies, such as old movies or foreign movies usually have no ratings.

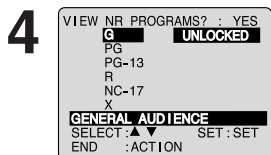

- Press ▲▼ to select and SET to set ratings to be blocked. (See ratings chart on this page.)

- 5 Press ACTION to redisplay LOCK menu and continue with US TV PROGRAMS Ratings Setup (page 40).
Or,
press ACTION three times to exit.

US MOVIES RATINGS

G	GENERAL AUDIENCE: All ages admitted.
PG	PARENTAL GUIDANCE: Some material may not be suitable for children.
PG-13	PARENTS CAUTIONED: Some material may be inappropriate for children under 13.
R	RESTRICTED: Children under 17 must be accompanied by a parent or adult.
NC-17	OVER AGE 17 ONLY: No one 17 and under admitted.
X	ADULTS ONLY:

V-Chip Control Feature (continued)

If LOCK menu is not displayed, do "Enter Secret Code" steps on page 38.

Process of V-Chip Control Feature

Enter Code ⇨ Setup ⇨ Blocking

US TV PROGRAMS Ratings

1

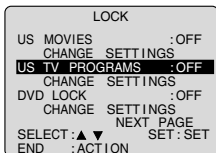

- 1) Press ▲▼* to select US TV PROGRAMS.
- 2) Press SET to set "ON" or "OFF."

- "ON" → V-Chip Control is activated.
- "OFF" → V-Chip Control is deactivated.

Note

- "NEXT PAGE" displays CANADIAN V-Chip setting menu. Not necessary except when viewing Canadian tapes or broadcasts.

2

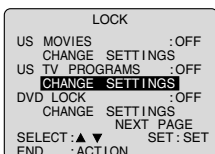

- 1) Press ▲▼ to select CHANGE SETTINGS.
- 2) Press SET to display screen.

3

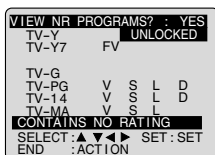

- 1) Press ▲▼ to select VIEW NR PROGRAMS?.
- 2) Press SET to set "YES" or "NO."

NR (Not Rated) PROGRAMS

Some TV shows, such as news, sports, weather, bulletins, emergency information usually have no ratings.

4

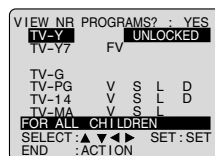

Press ▲▼ to select and SET to set ratings to be blocked. (See ratings charts on this page.)

- Ratings highlighted in green will be blocked. Ratings in white letters will not be blocked.

Note

- You may select from standard TV ratings (chart 1), or customize to a specific content rating (chart 2).

5

Press ACTION three times to exit this mode.

US TV PROGRAMS RATINGS: Chart 1

TV-Y	FOR ALL CHILDREN: Content specifically geared to young viewers ages 2-6.
TV-Y7	FOR AGE 7 AND OLDER: May contain mild physical or comedic violence which may frighten children under 7.
TV-G	GENERAL AUDIENCE: Contains little or no violence, strong language, or sexual dialogue or situations.
TV-PG	PARENTAL GUIDANCE: May contain infrequent coarse language, limited violence, some suggestive sexual dialogue and situations.
TV-14	PARENTS CAUTIONED: May contain sophisticated themes, sexual situations, strong language, and more intense violence.
TV-MA	MATURE AUDIENCE: May contain mature themes, profane language, graphic violence, and sexual situations.

US TV PROGRAMS RATINGS: Chart 2

FV	Fantasy Violence
V	Violence
S	Sexual Situations
L	Adult Language
D	Sexually Suggestive Dialogue

*Important: If a remote control button does not work when pressed, press the TV/CR button on the remote and try the button again.

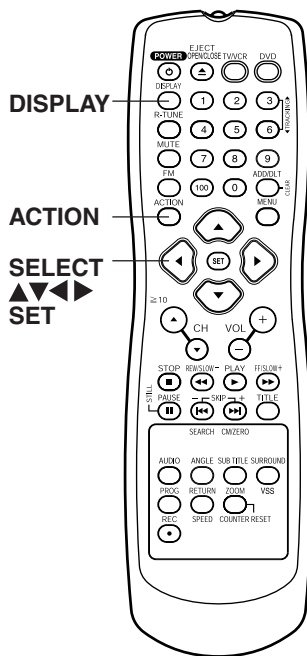

Process of V-Chip Control Feature

Enter Code → Setup → Blocking

Blocking Message

<When V-Chip Control is activated>

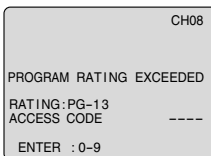

- If a program or movie exceeds the ratings you have set, a message will appear on a black background and sound is muted.

To View a Blocked Program/Movie [Temporarily Deactivate V-Chip Control]

Enter your secret code (ACCESS CODE) in the Blocking Message screen.

- V-Chip Control is reactivated when power is turned off or power failure occurs.

[Deactivate V-Chip Control]

Enter your secret code (steps 1-3 page 38). Then, set US MOVIES and/or US TV PROGRAMS to "OFF" using ▲▼ and SET. (Ratings set on pages 39 and 40 is retained and will be in effect when V-Chip Control is activated again.)

Audio Features

Audio Mode for Playback

Choose the type of sound track for playback.

- 1 See the **“Playback a Tape”** section on page 18 to playback the tape.

2

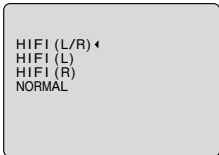

HIFI (L/R) ◀
HIFI (L)
HIFI (R)
NORMAL

Press **AUDIO*** repeatedly (each press within 5 seconds) to select desired mode.

- Select “HIFI (L/R),” “HIFI (L)” or “HIFI (R)” to listen to stereo recordings in stereo sound. Select “NORMAL” for monaural sound.

- This screen appears when you **press AUDIO** during playback.

Audio Mode for Recording

Choose audio mode to match recording type.

- 1 Press **AUDIO** repeatedly to select the audio mode according to the type of broadcast to be recorded.

- The Audio mode selected stays in effect until it is changed.

- 2 See the **“Record On a Tape”** section on page 18 to do a recording.

Notes

- Only tapes recorded in Hi-Fi stereo will playback with true stereo sound. Standard stereo tapes will playback with monaural sound.
- To listen to Hi-Fi stereo playback, the unit AUDIO (L/R) jacks must be connected to a stereo amp and speakers.
- There may be a difference in audio level between Hi-Fi and normal audio playback.

With the proper audio mode setting, your unit can:

- Record and playback MTS stereo broadcast (main language) in stereo Hi-Fi. Stereo sound is recorded on the left and right audio tracks and on the video portion of a tape.
- Record and playback a monaural broadcast (main language) or SAP (Secondary Audio Program, usually in a second language) on the Hi-Fi tracks for better quality monaural sound.
- Playback non-Hi-Fi tapes in monaural.

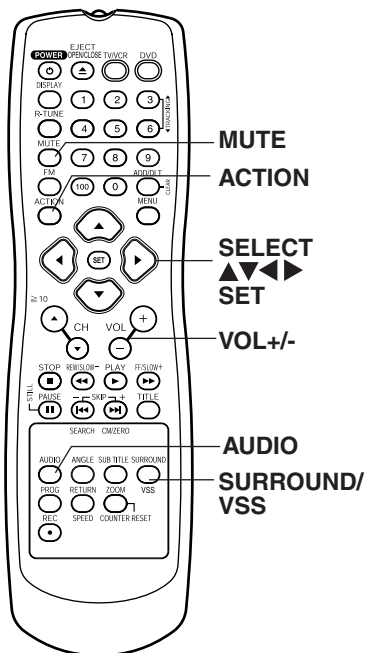

*Important: If a remote control button does not work when pressed, press the TV/VCR button on the remote and try the button again.

DVD Volume Adjust

Some DVDs are recorded in lower average volume level. For these DVDs, this unit can be set so that the average volume is increased automatically.

1 Press **ACTION*** to display MAIN MENU.

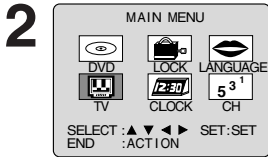

1) Press **▲▼◀▶** to select "TV."
2) Press **SET** to display SET UP TV screen.

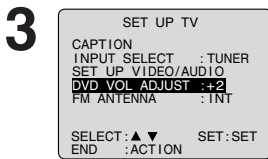

1) Press **▲▼** to select DVD VOL ADJUST.
2) Press **SET** to set the level (0, +1, or +2).

4 Press **ACTION** twice to return to the normal screen.

Surround Sound System

You can hear a deeper, 3-D sound effect using just the unit's two front speakers.

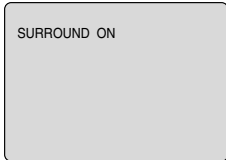

Press SURROUND.
• "SURROUND ON" is displayed.

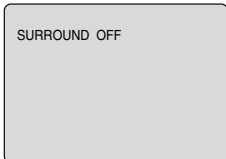

To Cancel, press SURROUND.

Notes

- Surround sound effect is not available for normal (mono) broadcasts.
- The surround effect (TV, VCR mode only) is not output to Audio Output L/R Connector.

V.S.S. (Virtual Surround Sound) [DVD only]

Enjoy a surround-like effect if you are using two front speakers only. The effect is broadened and sound seems to come from virtual speakers on either side if the disc has surround signals recorded on it.

Press VSS in DVD mode.

- The Surround sound effects can be changed by pressing VSS repeatedly as shown by the figure below.

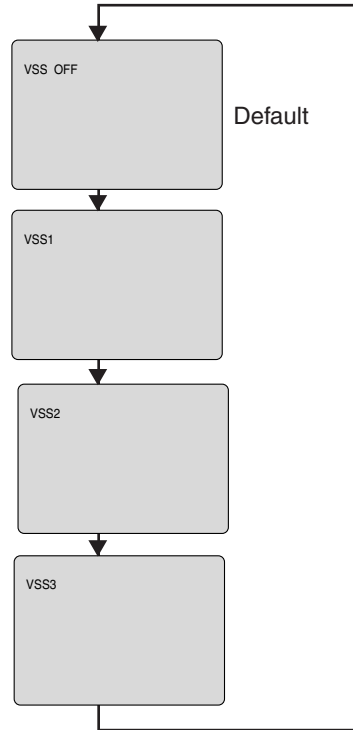

Notes

- V.S.S. effects is available in DVD mode only.
- Turn off the surround effects on the other equipment.
- V.S.S. will not work, or will have less effect, with some discs.
- Turn V.S.S. off if it causes distortion.

Video/Audio Menu

This feature allows easy setting of picture and sound suitable for each program source.

Video Menu

1 Press **ACTION*** to display MAIN MENU.

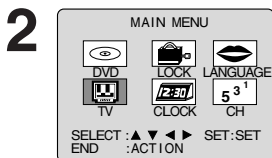

1) Press **▲▼◀▶** to select "TV."
2) Press **SET** to display SET UP TV screen.

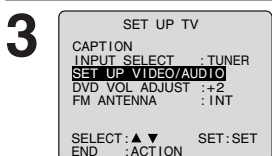

1) Press **▲▼** to select "SET UP VIDEO/AUDIO."
2) Press **SET** to display.

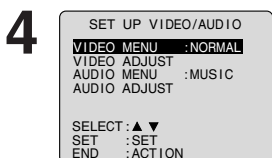

1) Press **▲▼** to select "VIDEO MENU."
2) Press **SET** repeatedly to select desired mode. (See below.)

5 Press **ACTION** three times to end setup.

[Video Menu]

■ NORMAL

Factory setting.

■ MOVIE

Picture is adjusted for a movie-like feel.

■ NIGHT

Color and picture intensity are adjusted to be easier on the eyes for night viewing.

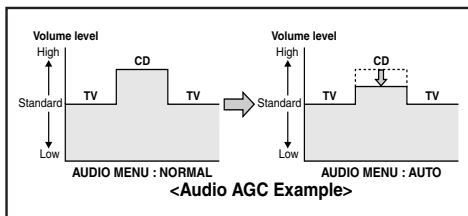

Audio Menu

a Do steps 1-3 left.

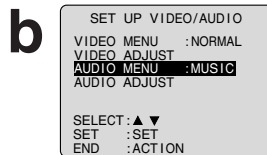

1) Press **▲▼** to select "AUDIO MENU."
2) Press **SET** to select desired mode. (See below.)

c Press **ACTION** three times to end setup.

[Audio Menu]

■ NORMAL

■ AUTO

[Audio AGC (Auto Gain Control)]

The sound level is automatically adjusted to suit the program source (see below left).

■ MOVIE

Sound suited to movies.

■ MUSIC

Sound suited to music. (Factory setting)

■ SPEECH

Sound suited to dialogue.

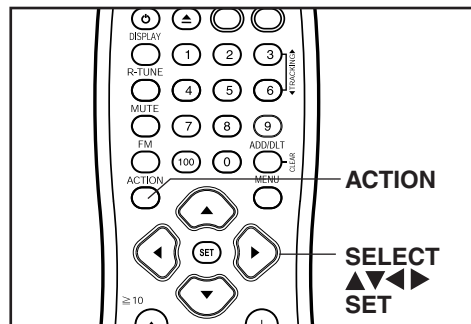

Notes

- The effects of this feature on the signal is not output to the Audio/Video Output Connector.
- When AUDIO MENU mode is "AUTO," the AUDIO ADJUST setting will be "STANDARD."
- AUDIO MENU settings remain in memory.
- VIDEO MENU settings do not remain in memory.

Video/Audio Adjustment

***Important:** If a remote control button does not work when pressed, press the TV/VCR button on the remote and try the button again.

Video Adjustment

1 Press **ACTION** to display MAIN MENU.

2

1) Press **▲▼◀▶** to select "TV."
2) Press **SET** to display SET UP TV screen.

3

1) Press **▲▼** to select "SET UP VIDEO/AUDIO."
2) Press **SET** to display.

4

1) Press **▲▼** to select "VIDEO ADJUST."
2) Press **SET** to display.

5

1) Press **▲▼** to select an item. (See below.)
2) Press **◀▶** to adjust.

To Reset VIDEO Controls, press **▲▼** and **SET** to select and set "STANDARD." All controls return to their factory settings.

6 Press **ACTION** four times to end setup.

[VIDEO Adjustment]

- **COLOR Control**
Adjust color intensity.
- **TINT Control**
Adjust for natural flesh tones.
- **BRIGHTNESS Control**
Adjust picture brightness.
- **PICTURE Control**
Adjust picture intensity by adjusting both contrast and color level in the proper balance.
- **SHARPNESS Control**
Adjust picture sharpness.

Audio Adjustment

a Press **ACTION** to display MAIN MENU.

b

1) Press **▲▼◀▶** to select "TV."
2) Press **SET** to display SET UP TV screen.

c

1) Press **▲▼** to select "SET UP VIDEO/AUDIO."
2) Press **SET** to display.

d

1) Press **▲▼** to select "AUDIO ADJUST."
2) Press **SET** to display.

e

1) Press **▲▼** to select an item. (See below.)
2) Press **◀▶** to adjust.

To Reset AUDIO Controls, press **▲▼** and **SET** to select and set "STANDARD." All controls return to their factory settings.

f Press **ACTION** four times to end setup.

[AUDIO Adjustment]

- **BASS Control**
To adjust the intensity of low frequency sound.
- **TREBLE Control**
To adjust the intensity of high frequency sound.
- **BALANCE Control**
To adjust the (L/R) unit speaker output level.
 - The levels set here do not affect other audio equipment when connected to the Audio Output L/R Connector.

Disc Operation

Subtitle Language (DVD only)

You can select a different subtitle language (if offered) than the one set at the Settings for DVD Operation. (See page 58.)

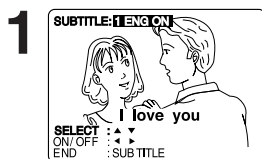

1 Press **SUB TITLE*** in Play mode to display the subtitle selection on-screen.

- Display disappears after 5 seconds.
- When no subtitles are offered, “-” will be displayed instead of the language number.

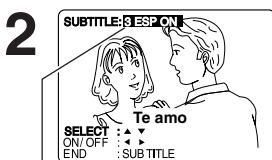

1) Press $\blacktriangle \blacktriangledown$ to select desired language.

2) Press \blacktriangleleft (or \blacktriangleright) to select “ON” or “OFF.”

Number of subtitle language being played back.

Notes

- When closed captioning is used along with subtitles, they may overlap. If so, turn one function off. (See pages 24 and 25.)
- If after several presses of the button the language does not change, language selection is not offered on the disc.
- Subtitles may not change to the selected language immediately.
- When disc is removed, subtitles revert to initial setting language. If the initial language is not recorded on the disc, the disc’s priority language will appear.

Audio Soundtrack Language (DVD only)

You can change the audio soundtrack language, selected at the Settings for DVD Operation, to a different language if available. (See page 58.) (This operation works only with discs on which multiple audio soundtrack languages are recorded.)



a Press **AUDIO** in Play mode to display the audio selection on-screen.

- Display disappears after 5 seconds.

Audio attribute 1 type, sampling frequency, bit No. of the disc.



b Press **$\blacktriangle \blacktriangledown$** to select desired language.

Audio soundtrack language being played back.

Check List

- Please read “Basic DVD Operation” on page 20.

[Subtitle language] [Audio soundtrack language]

ENG	English
FRA	French
DEU	German
ITA	Italian
ESP	Spanish
NLD	Dutch
SVE	Swedish
NOR	Norwegian
DAN	Danish
POR	Portuguese
RUS	Russian
JPN	Japanese
CHI	Chinese
KOR	Korean
MAL	Malay
VIE	Vietnamese
THA	Thai
*	Other

- Change the No. by **pressing $\blacktriangle \blacktriangledown$** , and **press SET**.

[Audio attribute 1 type, sampling frequency, bit No. of the disc (see page 59)]

LPCM	96 kHz	16 bit	Linear PCM disc
	or	20 bit	
	48 kHz	24 bit	
Dolby Digital	1 ch - 5.1 ch	Dolby Digital disc	
dts	1 ch - 5.1 ch	dts disc	

Notes

- If, after several presses of the AUDIO button the language does not change, language selection is not offered on the disc.
- When disc is removed, language reverts to initial setting. If this language is not recorded on the disc, the language recorded will be heard.

*Important: If a remote control button does not work when pressed, press the DVD button on the remote and try the button again.

When  appears on the screen while a button is being pressed, it means that the corresponding operation is prohibited by the unit or the disc.

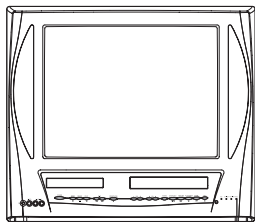

ANGLE Indicator

Notes

- ANGLE Indicator lights up on the unit when a scene recorded at different angles is detected.
- The angle number can be set beforehand so that the angle is switched whenever ANGLE Indicator lights up.

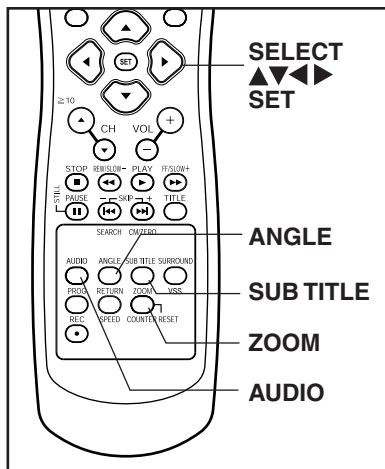

Notes

- Closed captioning will not be displayed while Picture Zoom is used. To see subtitles, set the subtitle feature to ON (see page 46).
- The subtitle cannot be enlarged nor can it's position be changed.
- The picture zoom feature does not work with a Video CD.
- During picture zoom, "ZOOM1" or "ZOOM2" appears on-screen for 5 second.
- Zooming, on some discs, may result in poor picture quality, or may not operate at all.

Multiple Angle Viewing (DVD only)

DVDs may contain scenes shot from multiple camera angles allowing the same scene to be viewed at different angles. You can view these angles, if available, using the ANGLE button.

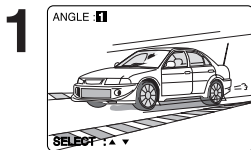

Press ANGLE in Play mode to display the angle selection on-screen.

- Display disappears after 5 seconds.

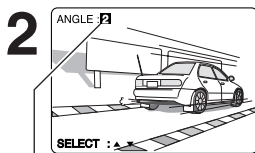

Press ▲▼ to select the desired angle.

Number of angle being played back.

Vocal selection for Karaoke discs (DVD/Video CD)

Press AUDIO in Play mode to display the audio screen.

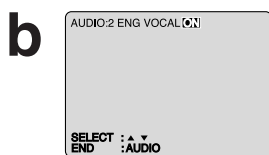

- 1) **Press ▲▼** (or **◀▶**) to select as shown below.
- 2) **Press ▶** (or **◀**) to set. (DVD only)

- DVD Karaoke (1 vocal) VOCAL ON → VOCAL OFF
- DVD Karaoke (2 vocals) VOCAL V1 → VOCAL V2 → VOCAL V1 + V2 → VOCAL OFF
- Video CD LR → L → R

Picture Zoom (DVD only)

You can enlarge specific portions of a picture and select the zoom ratio using the ZOOM button on the remote during DVD playback.

Set Zoom size.

Press ZOOM repeatedly to change display as follows.

- You can enlarge the center portion of the image to one of 2 magnifications.

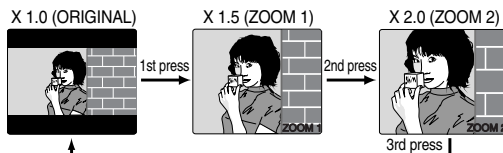

■ Use the **▲, ▼, ◀** and **▶** buttons to move the position up, down, left and right.

Advanced Operation

Disc Operation (continued)

Title menu (DVD only)

Some DVDs have more than one title, e.g. movies. If the disc offers a title menu, you can select the desired title number. (Operation may vary according to the disc.)

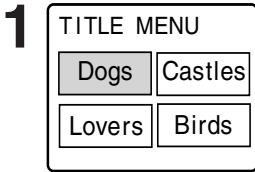

<Example>

Press **TITLE*** in Play mode to display title screen.

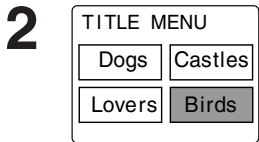

<Example>

- 1) Press **▲▼◀▶** or **NUMBER key(s)** to select a title.
- 2) Press **SET** or **PLAY** to start play.

• Step 2) not necessary when using **NUMBER** key(s).

DVD menu (DVD only)

DVDs may offer a special menu. This menu may include guides to unique contents, audio/subtitle languages, etc. Although contents and operation may vary, the following steps show basic steps for using the menu.

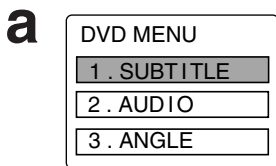

<Example>

Press **MENU** in Play mode to display DVD menu.

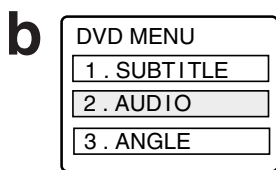

<Example>

- 1) Press **▲▼◀▶** or **NUMBER key(s)** to select an item.
- 2) Press **SET** or **PLAY** to access.

• Step 2) not necessary when using **NUMBER** key(s).

Repeat step “b” if there is more than one menu.

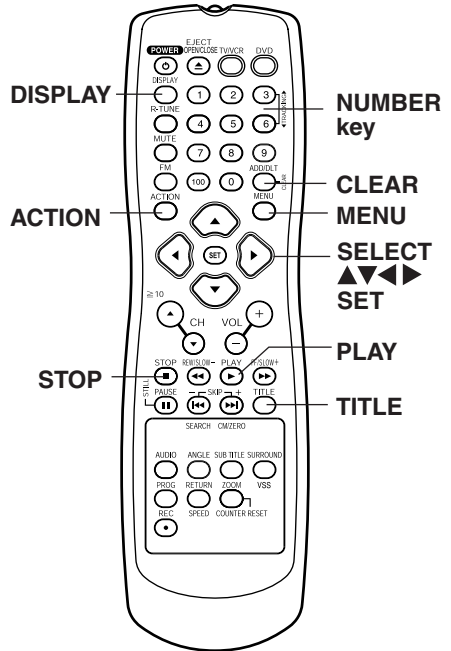

*Important: If a remote control button does not work when pressed, press the TV/VCR, DVD button on the remote and try the button again.

Program Play (Video CD/CD)

You can program specific tracks and order of play.

1 Press **ACTION** in Stop mode to display MAIN MENU.



- 1) Press **▲▼◀▶** to select "DVD."
- 2) Press **SET** to display screen.



- 1) Press **▲▼** to select "PLAY MODE."
- 2) Press **SET** to display screen.



- 1) Press **▲▼** to select "PROGRAM PLAY."
- 2) Press **SET** to display screen.

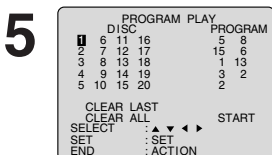

- 1) Press **▲▼◀▶** to select a track number. (Track numbers on disc are displayed.)
- 2) Press **SET** to set.

- Repeat step 5 to select another track.
- The selected track is added on the right side.

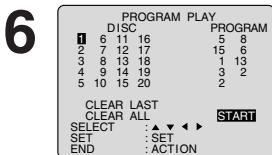

- 1) Press **▲▼◀▶** to select "START."
- 2) Press **SET** to start play of programs in the sequence selected.

- To cancel, press **STOP** during play, then press **CLEAR**.

Notes

- Up to 15 tracks can be programmed.
- "◀" or "▶" (depending on disc) indicates additional PROGRAM PLAY screen. Press **▲▼◀▶** for next or previous screen.
- To clear the last program one by one, Press **▲▼◀▶** to move to "CLEAR LAST" and press **SET**. (Pressing **CLEAR** also clears last program.)
- To clear all programs, Press **▲▼◀▶** to move to "CLEAR ALL" and press **SET**. (Programs are also cleared when the power is turned off or the disc is removed.)

✓ Check List

- Unit is in TV-VCR mode, press TV/VCR.
- Video CD or CD is inserted.

Program Repeat Play (Video CD/CD)

a Do steps 1 through 6 on this page.

b Press **DISPLAY** to display Disc Information screen.

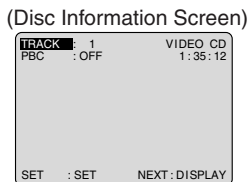

c Press **DISPLAY** again to display Unit Information screen.

d Press **SET** to enter Select mode. Cursor move to "OFF."

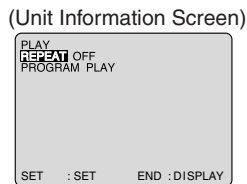

e Press **▲▼** to select "DISC."

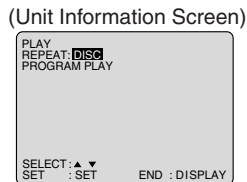

f Press **SET** to set mode. Cursor move to "REPEAT." To cancel, select "REPEAT: OFF" in step e, then press **SET**.

Disc Operation (continued)

Random Play (Video CD/CD)

Tracks are played in a random order.

- 1 Press **ACTION*** in Stop mode to display MAIN MENU.

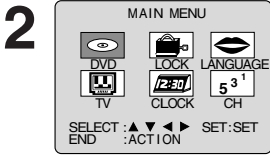

- 1) Press **▲▼◀▶** to select "DVD."
- 2) Press **SET** to display screen.



- 1) Press **▲▼** to select "PLAY MODE."
- 2) Press **SET** to display screen.



- 1) Press **▲▼** to select "RANDOM PLAY."
- 2) Press **SET** to begin random play.

• To cancel, press **STOP** during play, then press **CLEAR**.

*Important: If a remote control button does not work when pressed, press the TV/VCR, DVD button on the remote and try the button again.

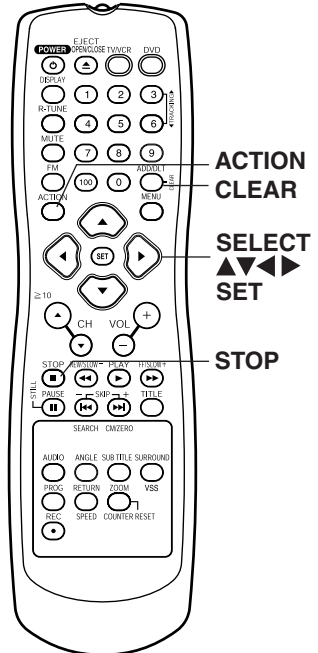

DVD Operation using On-Screen Displays

When DISPLAY is pressed, On-Screen Displays show disc information (title/chapter/track number, elapsed playing time) and unit information (Repeat Play, Play mode).

1 Press DISPLAY in Play or Stop mode to display "On-Screen Display."

- Each **press** of DISPLAY changes the on-screen display as follows. (Please refer to page 52 or 53.)

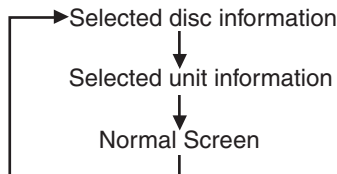

Note

- DISPLAY button does not function while DVD TITLE MENU is displayed.

2 1) Press ▲▼ (or ◀▶) to select an item. 2) Press SET to set.

3 1) Press ▲▼ to select the setting. 2) Press SET to set.

<Example of DVD>

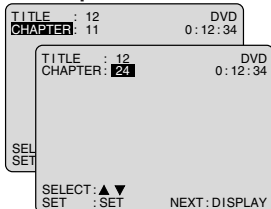

- When numbers are displayed (e.g. title number), the **NUMBER keys** are also available.
- If the number entered is not on the disc, the entry will have no effect. Re-enter the correct number.
- For more details, refer to the disc operation information.

<Example of Video CD>

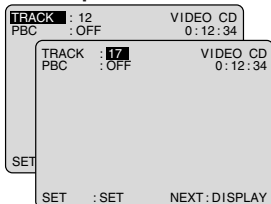

To return to the normal screen, press **CLEAR** or **DISPLAY** repeatedly.

✓ Check List

- Unit is in DVD mode, press DVD.

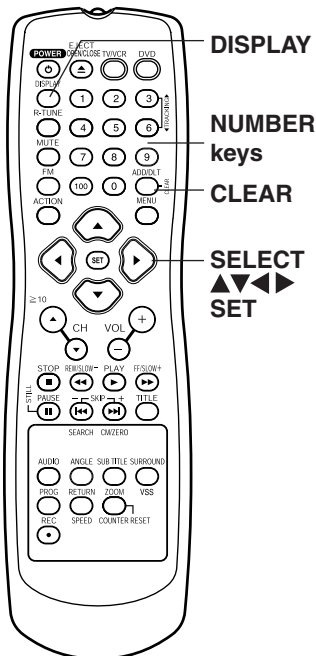

Notes

- When **DISPLAY** is pressed during play of a Video CD with play control, the **NUMBER keys** are not available on the displayed screen. In this case, **press DISPLAY** again to remove the displayed screen.
- When **⊘** appears on the screen while a button is being pressed, it means that the corresponding operation is prohibited by the unit or the disc.

Advanced Operation

DVD Operation using On-Screen Displays (continued)

Detailed Descriptions of Each On-Screen Display

Disc information screen (for DVD)

1. TITLE No.

- Select "TITLE," and **press SET**.*
- Change the No. by **pressing ▲▼** or **NUMBER** keys, and **press SET**.

2. Chapter No.

- Select "CHAPTER," and **press SET**.
- Change the No. by **pressing ▲▼** or **NUMBER** keys, and **press SET**.

3. Disc currently being played

4. Elapsed playing time

The screen can be changed by selecting the elapsed time.

- Select the elapsed playing time ("xx:xx:xx"), and **press SET**.
- Change the elapsed time by **pressing NUMBER** keys.
Hours → Minutes → Seconds are entered in order.
If the time entered is not on the disc, the entry will have no effect.
Re-enter the correct time.
e.g., press 0 - 1 - 2 - 3 - 4 - 5 for 01 : 23 : 45.

Hour Minutes Seconds

- This function does not work with some discs.

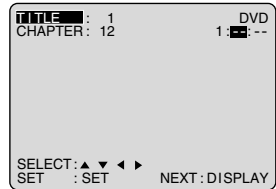
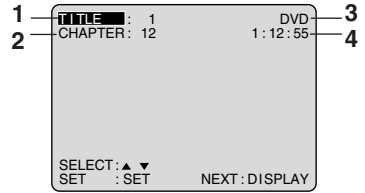

If SET is pressed while making entries, unit returns to the condition before entries were made.

Disc information screen (for Video CD/ CD)

A. Track No.

- Select "TRACK," and **press SET**.
- Change the No. by **pressing ▲▼** or **NUMBER** keys, and **press SET**.

B. Playback control ON/OFF

[Video CD with playback control only]

ON	Video CD menu play is displayed.
OFF	Video CD menu play is not displayed.

C. Disc currently being played

Video CD	CD
----------	----

D. Elapsed playing time

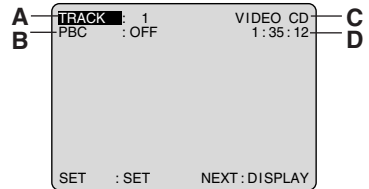

Notes

- Track No. and elapsed playing time are not displayed during play started from menu of Video CDs with playback control.
- When \emptyset appears on the screen while a button is being pressed, it means that the corresponding operation is prohibited by the unit or the disc.

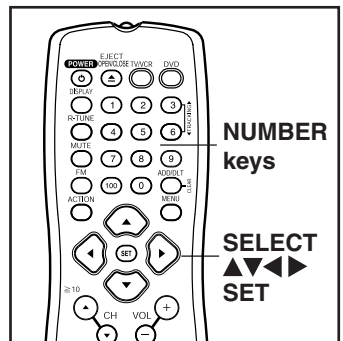

✧Important: If a remote control button does not work when pressed, press the DVD button on the remote and try the button again.

Unit information screen

- Select “REPEAT”, and **press SET**.
- Change the desired mode during play by **pressing ▲▼**, and **press SET**.

a. Repeat Play

DVD	CHAPTER REPEAT	TITLE REPEAT	REPEAT OFF
Video CD/CD	TRACK REPEAT	DISC REPEAT	REPEAT OFF

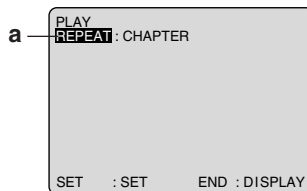

b. Play mode [Video CD/ CD only] (See page 49 or 50.)

PROGRAM PLAY	program play
RANDOM PLAY	random play
----	normal play



For your reference

• CHAPTER/TITLE REPEAT PLAY (DVD)

CURRENT PLAYBACK POSITION

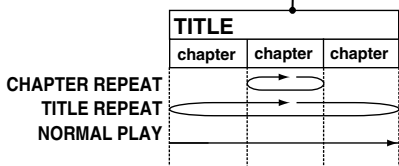

• TRACK/DISC REPEAT PLAY (Video CD/CD)

CURRENT PLAYBACK POSITION

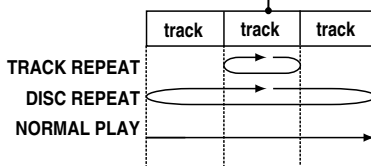

- For repeat play in VCR mode, see page 33.

MP3/WMA/JPEG Playback Operation

This unit can play MP3/WMA/JPEG format CD-R or CD-RW recorded for personal use on a PC, etc. Some discs may not play due to recording condition.

1 Press POWER* on the remote or unit.

2 Press OPEN/CLOSE, and then place an MP3/WMA/JPEG disc into the disc tray. **Press OPEN/CLOSE** to close.

3

- MP3/WMA/JPEG menu is displayed.
- Playback starts automatically (except JPEG files).
- CD directory is displayed.

4 Press ◀▶ to move cursor to File area or PLAY MODE. (In STOP mode)

■ File area Operation (In STOP mode)

Press ▲▼ to select items and **SET** or **PLAY** to start.

Press SKIP+ ▶▶| (next) or **SKIP- |◀◀** (previous) to skip a file/folder page (7files) in the File area.

Select an MP3/WMA file (🎵/🎵). MP3/WMA Playback (See next page)

Select an JPEG file (📷). JPEG Playback (See next page)

Select a folder (📁).

Display files/folders contained in the folder.

Select a Parent folder (📁).

Make changes to the previous directory display.

■ Play mode Operation (In STOP mode)

Press ▲▼ to select the desired PLAY MODE.

5 Press ACTION to return to the DVD MAIN MENU. (**Press ACTION** again to return to the MP3/WMA/JPEG MENU.)

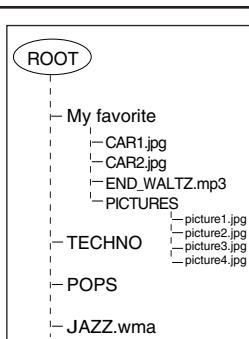

Example: If the CD-R/CD-RW file hierarchy is displayed on the PC as shown in diagram at left, MP3/WMA/JPEG Menu Screen, like the one below is displayed.

Note

- File names are displayed in ascending order (1, 2, 3...9, A, B, C...Y, Z) in the MP3/WMA/JPEG MENU Screen ROOT.

MP3/WMA/JPEG MENU SCREEN

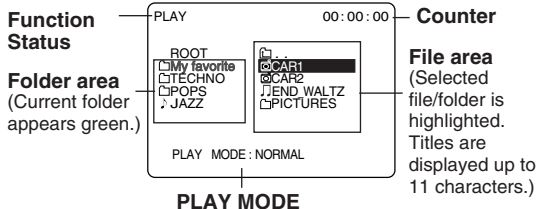

Explanation of Icons



PLAY MODE selection

PLAY MODE:	MP3/WMA Playback	JPEG Playback - Slide-show -
NORMAL	All MP3/WMA files are selected and played back one time only.	All JPEG files are selected and played back one time only.
SINGLE REPEAT	The selected MP3/WMA file is played back repeatedly.	The selected JPEG file is played back repeatedly.
FOLDER REPEAT	The MP3/WMA files contained in the selected folder are played back repeatedly. However, folders below the selected folder are not played back.	The JPEG files contained in the selected folder are played back repeatedly. However, folders below the selected folder are not played back.
DISC REPEAT	All MP3/WMA files are played back repeatedly.	All JPEG files are played back repeatedly.

MPEG Layer-3 audio decoding technology licensed from Fraunhofer IIS and Thomson multimedia.



Windows Media, and the Windows logo are trademarks, or registered trademarks of Microsoft Corporation in the United States and/or other countries. WMA is a compression format developed by Microsoft Corporation. It achieves the same sound quality as MP3 with a file size that is smaller than that of MP3.



MP3/WMA Playback

- Do steps 1~3 on page 54.
Press **▲▼** to select an MP3/WMA file (🎵) in STOP mode.

- Press **SET** or **PLAY** to start playback.

Forward/Reverse Search

Press **FF/SLOW+** or **REW/SLOW-** during play. Press **PLAY** to release.

- Search speed, slow at first, increases with each additional press of the button up to 5 levels.

Forward/Reverse Track Skip

Press **SKIP+ ▶▶▶** or **SKIP- ◀◀◀** during play. Each press skips a track.

- If pressed within first 3 seconds of playback, skips to the previous track. If over 3 seconds, returns to top of track. (**SKIP- ◀◀◀** only.)
- Put unit in Stop mode before performing folder/file selection (see step 4 on previous page.)

Pause

Press **PAUSE** during play.
Press **PLAY** to release.

- Press **STOP** to stop play.

- Press **OPEN/CLOSE** to eject the disc. The MP3 MENU is closed automatically.

Note

- Copyright protected files and files containing errors cannot be played back. The unit skips to the next file.

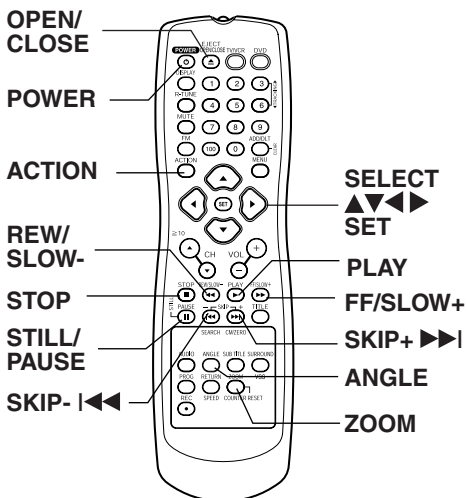

JPEG Playback

You can play JPEG images.

Displayable Image Size: 32x32~7680x7680 pixels

Note

- Some JPEG format may not be played back.

- Do steps 1~3 on page 54.

Press **▲▼** to select an JPEG file (🖼️).

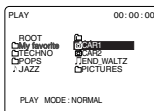

- Press **SET** or **PLAY**. Selected file is displayed.

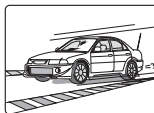

JPEG Playback Screen
<Example: CAR1>

Next/Previous Search

Press **SKIP+ ▶▶▶** or **SKIP- ◀◀◀**

<Example>

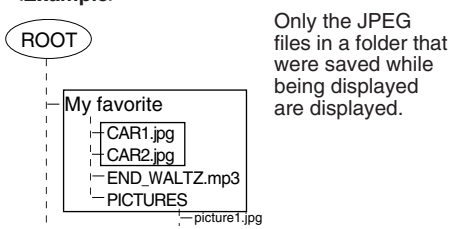

<Example: CAR1>

<Example: CAR2>

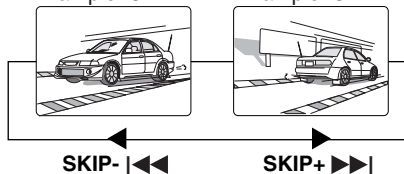

Start Slide-show

Press **FF/SLOW+** or **REW/SLOW-**. (see next page)

Enlarging an image

Press **ZOOM**. (see next page)

Rotating an image

Press **ANGLE**. (see next page)

Returned on the MP3/WMA/JPEG MENU

Press **STOP**. (see previous page)

- Press **ACTION** to return to the DVD MAIN MENU.

MP3/WMA/JPEG Playback Operation (continued)

JPEG Playback - Zoom -

(During JPEG Playback.)

You can enlarge specific portions of a JPEG picture and select the zoom ratio using the ZOOM button on the remote during JPEG Playback.

Set Zoom size.

Press ZOOM repeatedly to change display as follows.

Press STOP to return to the MP3/WMA/JPEG MENU.

- You can enlarge the center portion of the image to one of 2 magnifications.
- Operation can be done during Rotation (below).

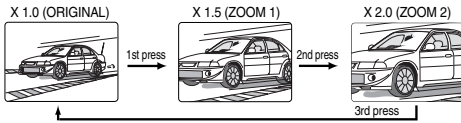

- Use the ▲, ▼, ◀ and ▶ buttons to move the position up, down, left and right.

Note

- Position cannot be changed on X1.0 ORIGINAL images.

JPEG Playback - Rotation -

(During JPEG Playback.)

You can rotate a JPEG picture using the ANGLE button on the remote during JPEG Playback. (The JPEG picture will be rotated 90° clockwise.)

Set rotation.

Press ANGLE repeatedly to change display as below. (During JPEG Playback screen)

Press STOP to return to the MP3/WMA/JPEG MENU.

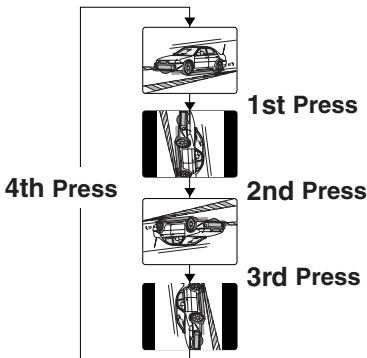

Notes

- Operation can be done during ZOOM (above).
- The vertical/horizontal ratio of rotated JPEG images may vary when they are displayed.

JPEG Playback - Slide-show -

(During JPEG Playback.)

JPEG files are displayed automatically (about every 3 seconds) as a slide-show.

1 Press FF/SLOW+ or REW/SLOW-.

Only the JPEG files in a folder that were saved while being displayed are displayed.

<Example>

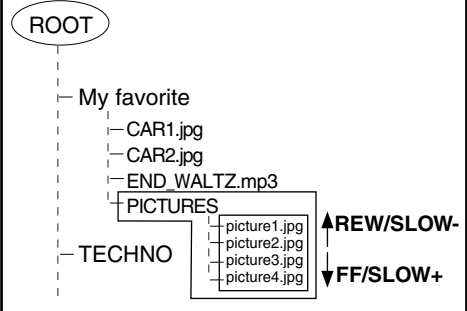

<Example>

If FF/SLOW is pressed while picture 1 is displayed.

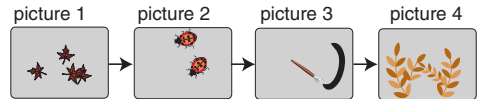

Image changes every 3 seconds.

If REW/SLOW- is pressed while picture 3 is displayed.



Image changes every 3 seconds.

- Still picture**
Press PAUSE (only SLIDE)
- Forward/Reverse Track Skip**
Press SKIP+ ►► or SKIP- ◀◀. Each press skips a file.
- Cancel slide show**
Press STOP to return to the MP3/WMA/JPEG MENU.

2 Press ACTION to return to the DVD MAIN MENU.

DVD Lock Feature

Important: If a remote control button does not work when pressed, press the TV/VCR, DVD button on the remote and try the button again.

You can prevent playback of DVDs with a specific rating level which may be unsuitable for children.

- Some DVDs are encoded with a rating level. If the disc rating is higher (stricter) than the one you preset, playback will be prohibited.

Caution

Discs not encoded with a rating level will play even if the jacket states it is for mature audiences. For these discs, the DVD Lock Ratings will not work.

DVD Lock Ratings (DVD only)

Perform DVD Lock setting in TV mode.
Enter your secret code to display LOCK menu.
(Perform "Enter Secret Code" steps on page 38.)

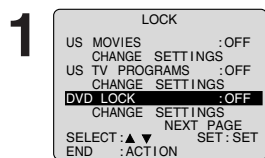

- 1) Press **▲▼*** to select "DVD LOCK."
- 2) Press **SET** to set "ON" or "OFF."

- "ON" → DVD Lock is activated.
- "OFF" → DVD Lock is deactivated.

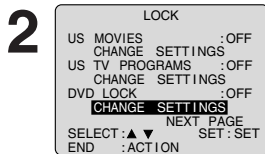

- 1) Press **▲▼** to select "CHANGE SETTINGS."
- 2) Press **SET** to display screen.

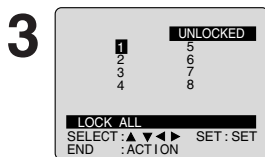

- 1) Press **▲▼◀▶** to select rating level.
- 2) Press **SET** to select "LOCKED" or "UNLOCKED."

- LEVEL 1:** LOCK ALL: Playback of all DVDs, CDs and Video CDs is prohibited. (Use to prohibit play of mature theme DVDs not encoded with a rating level.)
- LEVEL 2:** DVDs expressly for children can be played back.
- LEVEL 3 to 7:** DVDs for general audiences/children can be played back. (DVDs with mature content are prohibited.)
- LEVEL 8:** NO LIMIT: (Factory preset) All DVDs can be played back.

- Ratings which are highlighted in Green will be blocked; those not highlighted (white letters) will not be blocked.

4 Press **ACTION** three times to exit.

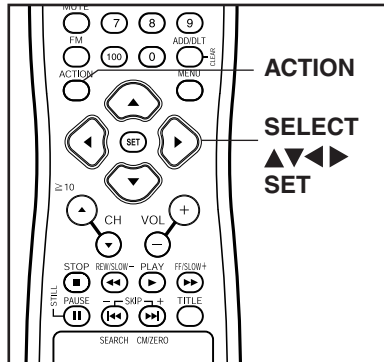

<When DVD Lock is activated>

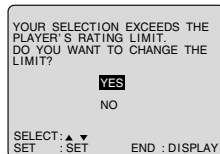

After DVD Lock is set and a blocked DVD is played, this message will appear. The message may differ depending on the disc.

To continue viewing a blocked program for now, Press **▲▼** to select "YES" and **SET**. Then, enter your 4-digit secret code. When "NO" is selected, blocked programs cannot be viewed.

<When blocked programs>

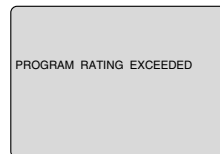

To change DVD LOCK settings
After entering your secret code in step 3 on page 38, select "OFF" to deactivate DVD Lock or change the rating level.

Settings for DVD Operation

- 1** Press **ACTION*** in Stop mode to display MAIN MENU.

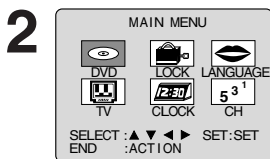

- 1) Press **▲▼◀▶** to select "DVD."
2) Press **SET** to display screen.

Once initial settings are done, they remain in memory (even after the power is off) until changed. This means the unit will always operate under the same conditions (especially DVDs) each time.

Check List

- Unit is in TV-VCR mode, press TV/VCR.



- 1) Press **▲▼** to select an item.
2) Press **SET** to set.

DISC LANGUAGES (See below.)

Any languages offered on the disc can be set. If a language not offered is set, the original disc language will be selected.

AUDIO OUTPUT (See page 59.)

You can set the audio output that comes from the digital audio output terminal.

STILL MODE (See page 60.)

To select "FIELD" or "FRAME" to prevent jitter or to make small text or fine patterns clearly visible in a still picture. When "AUTO" is set, "FIELD" or "FRAME" is selected automatically.

TV MODE (See page 60.)

To select whether the video material for a wide-screen will be played back in Pan & Scan style or in Letterbox style.

DISC LANGUAGES (DVD only)

To select and set the language of the audio soundtrack, subtitles, or title/DVD menus for all discs to be played.



- 1) Press **▲▼** to select "DISC LANGUAGES."
2) Press **SET** to display screen.

"AUDIO" selections

To select the audio soundtrack language. (Factory preset: English)

English/Spanish/French/Japanese

Original: Original disc language

OTHER **:** Other language selection*¹

"SUBTITLE" selections

To select the subtitle language. (Factory preset: AUTO)

AUTO: Same language selected for "AUDIO"

- If language set for "AUDIO" is used in playback, subtitles will not appear.
- If another language is used during playback, the subtitles will appear in the language selected at "AUDIO" setup.

English/Spanish/French/Japanese

OTHER **:** Other language selection*¹

"MENU" selections

(Factory preset: English)

To select the language used in title menus or DVD menus.

English/Spanish/French/Japanese

OTHER **:** Other language selection*¹

To enter **OTHER ****** code number, Press **NUMBER** keys (Please refer to language codes on page 61).

To make corrections, press **◀** repeatedly to delete language code number, and correct.

*¹ If the selected language is not offered, the original disc language is selected.



- 1) Press **▲▼** to select an item.
2) Press **SET** repeatedly for desired language. (Please refer right.)

- 6** Press **ACTION** to redisplay DVD MAIN MENU and go to step 3 to setup another item. Or, press **ACTION** three times to exit.

*Important: If a remote control button does not work when pressed, press the TV/VCR , DVD button on the remote and try the button again.

AUDIO OUTPUT

Select the digital output to be output from the optical digital audio output connector of the unit.

1 Do steps 1 and 2 on page 58.



- 1) Press ▲▼ to select "AUDIO OUTPUT."
- 2) Press SET to display screen.

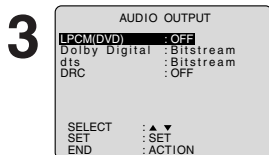

- 1) Press ▲▼ to select an item.
- 2) Press SET repeatedly for output. (See below.)

■ "LPCM (DVD)" selections

- OFF:** Linear PCM of less than 48 kHz/16 bit is output. When playing DVDs recorded in linear PCM of over 48 kHz/20 bit, no digital audio is output. (Factory preset)
- PCM:** When playing DVDs recorded in linear PCM of 48 kHz/20 bit/24 bit or more, digital audio converted to 44.1 kHz/16 bit or 48 kHz/16 bit is output. (Digital output of PCM audio is restricted to 48 kHz/16 bit or below for copyright protection.)

■ "Dolby Digital" selections

- Bitstream:** Dolby Digital bitstream (1ch-5.1ch) is output. (Factory preset)
- PCM:** When you have connected an amplifier that doesn't have a built-in Dolby Digital decoder.

■ "dts" selections

- Bitstream:** dts bitstream is output. (Factory preset)
- PCM:** When you have connected an amplifier that doesn't have a built-in dts decoder.

■ "DRC (Dynamic Range Compression)" selections

- OFF:** Normal audio range is selected. (Factory preset)
- ON:** For dynamic sound even at low volume, this is useful for late-night listening. [Dolby Digital DVDs only].

4 Press ACTION to redisplay DVD MAIN MENU and go to step 2 to setup another item. Or, press ACTION three times to exit.

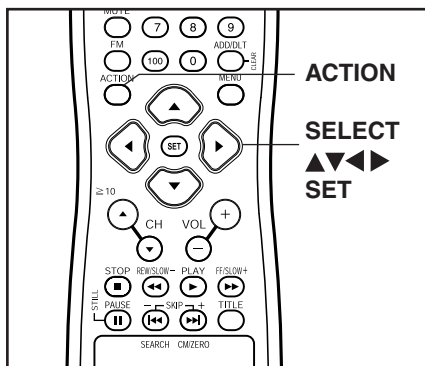

Type of amplifier to be connected	Recommended setting		
	LPCM (DVD)	Dolby Digital	dts
No amplifier is connected			
AV amplifier without Dolby Digital/dts decoder	PCM	PCM*1	PCM*1
AV amplifier including Dolby Digital decoder	PCM	Bitstream	PCM
AV amplifier including Dolby Digital/dts decoder	PCM	Bitstream	Bitstream*2

- Make settings according to amplifier connected to optical audio output as shown in above table.

*1 When connecting an amplifier (with an optical digital input connector) which does not contain the Dolby Digital or dts decoder, be sure to select "PCM." If "Bitstream" is selected, starting DVD play may cause such a high level of noise as to be harmful to your ears and damage the speakers.

*2 When a dts decoder is connected, please select "Bitstream" in "dts." If "PCM" is selected, there will be stereo sound.

Settings for DVD Operation (continued)

STILL MODE

Set to reduce jitter in a displayed still picture or a motion picture.

1 Do steps 1 and 2 on page 58.

2

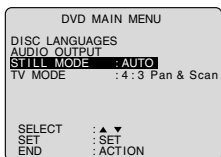

- 1) Press ▲▼* to select "STILL MODE."
- 2) Press SET repeatedly for mode. (See below)

AUTO: "FIELD" (Field still) or "FRAME" (Frame still) is automatically selected during the still mode. (Factory preset)

FIELD: "FIELD" (Field still) is always selected. This setting will reduce jitter when compared with "AUTO" on some discs.

FRAME: "FRAME" (Frame still) is always selected. Some texts and fine patterns will be seen clearly when compared with "AUTO" on some discs.

3 Press ACTION twice to exit this mode.

Selecting TV MODE

Set the screen display style for widescreen video material playback.

a Do steps 1 and 2 on page 58.

b

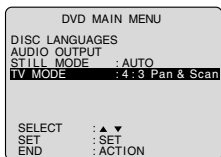

- 1) Press ▲▼ to select "TV MODE."
- 2) Press SET repeatedly for mode. (See below.)

4:3 Pan & Scan : Widescreen video data is played in Pan & Scan style (left and right of screen is trimmed.)

- Video data not formatted in Pan & Scan will play in letterbox style.

4:3 Letterbox : Widescreen video data is played in Letterbox style (top and bottom of screen has black margin).

c Press ACTION twice to exit this mode.

*Important:

If a remote control button does not work when pressed, press the DVD button on the remote and try the button again.

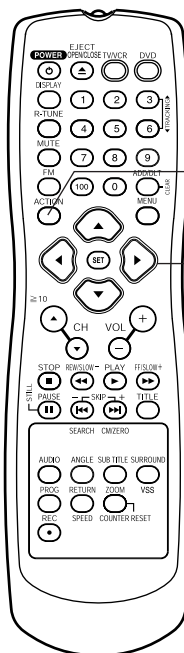

Example

4:3 Pan & Scan (Factory preset)

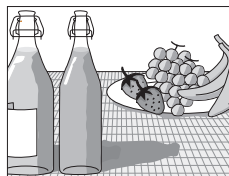

4:3 Letterbox

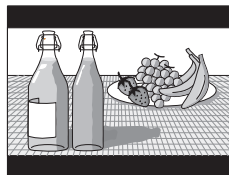

Language Code List

Enter the appropriate code number for the initial settings "AUDIO," "SUBTITLE" and/or "MENUS" (see page 58).

Code	Language
6565	Afar
6566	Abkhazian
6570	Afrikaans
6577	Ameharic
6582	Arabic
6583	Assamese
6588	Aymara
6590	Azerbaijani
6665	Bashkir
6669	Byelorussian
6671	Bulgarian
6672	Bihari
6678	Bengali; Bangla
6679	Tibetan
6682	Breton
6765	Catalan
6779	Corsican
6783	Czech
6789	Welsh
6865	Danish
6869	German
6890	Bhutani
6976	Greek
6978	English
6979	Esperanto
6983	Spanish
6984	Estonian
6985	Basque
7065	Persian
7073	Finnish
7074	Fiji

Code	Language
7079	Faroese
7082	French
7089	Frisian
7165	Irish
7168	Scots Gaelic
7176	Galician
7178	Guarani
7185	Gujarati
7265	Hausa
7273	Hindi
7282	Croatian
7285	Hungarian
7289	Armenian
7365	Interlingua
7378	Indonesian
7383	Icelandic
7384	Italian
7387	Hebrew
7465	Japanese
7473	Yiddish
7487	Javanese
7565	Georgian
7575	Kazakh
7576	Greenlandic
7577	Cambodian
7578	Kannada
7579	Korean
7583	Kashmiri
7585	Kurdish
7589	Kirghiz
7665	Latin

Code	Language
7678	Lingala
7679	Laothian
7684	Lithuanian
7686	Latvian, Lettish
7771	Malagasy
7773	Maori
7775	Macedonian
7776	Malayalam
7778	Mongolian
7779	Moldavian
7782	Marathi
7783	Malay
7784	Maltese
7789	Burmese
7865	Nauru
7869	Nepali
7876	Dutch
7879	Norwegian
7982	Oriya
8065	Panjabi
8076	Polish
8083	Pashto, Pushto
8084	Portuguese
8185	Quechua
8277	Rhaeto-Romance
8279	Romanian
8285	Russian
8365	Sanskrit
8368	Sindhi
8372	Serbo-Croatian
8373	Singhalese

Code	Language
8375	Slovak
8376	Slovenian
8377	Samoan
8378	Shona
8379	Somali
8381	Albanian
8382	Serbian
8385	Sundanese
8386	Swedish
8387	Swahili
8465	Tamil
8469	Telugu
8471	Tajik
8472	Thai
8473	Tigrinya
8475	Turkmen
8476	Tagalog
8479	Tonga
8482	Turkish
8484	Tatar
8487	Twi
8575	Ukrainian
8582	Urdu
8590	Uzbek
8673	Vietnamese
8679	Volapük
8779	Wolof
8872	Xhosa
8979	Yoruba
9072	Chinese
9085	Zulu

Before Requesting Service

Check the following points once again if you are having trouble with your unit.

Power	Correction
No power...	<ul style="list-style-type: none"> • Completely insert Power Plug into an AC outlet. • Set POWER button to ON.
Power turns itself off...	<ul style="list-style-type: none"> • Auto power-off (shut off) occurs after about 5 min. in DVD mode with no operation, or if there is no broadcast signal in TV or Playback mode. Turn the power back on.(P. 21, 35)
Monitor	Correction
No picture or sound...	<ul style="list-style-type: none"> • Make sure your antenna system (TV or CABLE), is correctly set. (P. 11) • Completely insert Power Plug into an AC outlet. • Set POWER button to ON.
Poor picture with normal sound...	<ul style="list-style-type: none"> • Adjust BRIGHTNESS, SHARPNESS, and PICTURE controls in the SET UP Video Adjustment. (P. 45)
Poor sound with normal picture...	<ul style="list-style-type: none"> • Adjust VOLUME control. (P. 22)
Poor TV reception...	<ul style="list-style-type: none"> • Adjust SHARPNESS and PICTURE controls in the SET UP Video Adjustment. (P. 45)
No color or poor color...	<ul style="list-style-type: none"> • Adjust TINT and COLOR controls in the SET UP Video Adjustment. (P. 45)
Ghost (multiple) images...	<ul style="list-style-type: none"> • Install a directional antenna.
TV programs cannot be watched...	<ul style="list-style-type: none"> • Make sure the selected channel is in unit's memory. (P. 16)
Channel cannot be selected...	<ul style="list-style-type: none"> • Only the channel being recorded can be viewed on this unit.
VCR	Correction
TV program cannot be recorded...	<ul style="list-style-type: none"> • Make sure your antenna system (TV or CABLE), is correctly set. (P. 11) • Make sure cassette record tab is intact. (P. 4)
Timer recording cannot be performed...	<ul style="list-style-type: none"> • Check that clock is set to current time and date. • Make sure DSS/CABLE box (if used) is left on and tuned to channel to be recorded. • Set recording Start/Stop times correctly. (P. 30-31) • Timer recording may not be performed or continued if a power interruption of more than 1 minute occurs before or during a Timer Recording, even after power is restored.
No playback picture, or the playback picture is noisy or contains streaks...	<ul style="list-style-type: none"> • Adjust TRACKING control in either direction. (P. 6) • Try Head Cleaning. (P. 6)
VCR cannot be controlled...	<ul style="list-style-type: none"> • Make sure VCR LOCK is set to off. (P. 37)
Remote Control	Correction
Unit cannot be controlled...	<ul style="list-style-type: none"> • Aim Remote directly at the remote sensor on the unit. (P. 9) • Avoid any object blocking signal path. • Inspect the remote batteries. (P. 4) • Make sure VCR LOCK is set to off. (P. 37) • Exposing unit remote sensor to direct fluorescent or outdoor light may cause signal interference.
ACTION, PLAY, SELECT, SET POWER, etc. buttons cannot be selected...	<ul style="list-style-type: none"> • Press TV/VCR for TV-VCR mode. (P. 22) • Press DVD for DVD mode. (P. 20) • Press FM for FM mode. (P. 28) • Check remote batteries.

DVD/Video CD/CD	Correction
Play fails to start even when PLAY is pressed...	<ul style="list-style-type: none"> This unit cannot play discs other than DVDs, Video CDs and CDs. The disc may be dirty and require cleaning.
Play starts but then stops immediately...	<ul style="list-style-type: none"> Be sure disc is installed with label side up.
Picture is distorted during rapid advance or rapid reverse...	<ul style="list-style-type: none"> The picture will be somewhat distorted at times: this is normal.
No Forward/Reverse search play...	<ul style="list-style-type: none"> Some discs may have sections which prohibit Forward/Reverse search. (P. 21)
Play does not start even when title is selected...	<ul style="list-style-type: none"> Confirm the "DVD LOCK" setting. (P. 57)
Audio soundtrack and/or subtitle language is not the one selected at the initial settings...	<ul style="list-style-type: none"> If the audio soundtrack and/or subtitle language selected at DVD initial settings does not exist on the disc, it will not be accessible.
No subtitles...	<ul style="list-style-type: none"> Subtitles appear only when available on disc. Select "ON" at the "Subtitle language" section (P. 46) to display subtitles.
Alternative audio soundtrack (or subtitle) language cannot be selected...	<ul style="list-style-type: none"> Alternative language cannot be selected with discs which do not contain more than one language. For some discs, alternative language cannot be selected with the AUDIO or SUB TITLE button. Try selecting it from the DVD MAIN MENU if available.
Angle cannot be changed...	<ul style="list-style-type: none"> This function is dependent on software availability. Even if disc has multiple angles, they may be recorded for specific scenes only (ANGLE Indicator on unit lights up). (P. 47)
Miscellaneous	Correction
Video cassette cannot be inserted...	<ul style="list-style-type: none"> Insert the cassette window side up; record tab facing you.
Video cassette cannot be removed...	<ul style="list-style-type: none"> Completely insert Power Plug into an AC outlet.
Eject does not function or insertion cannot be done...	<ul style="list-style-type: none"> Turn the POWER off and then on, and try ejecting or inserting the tape again.
Video cassette ejects when a recording is started, or the power is turned off for timer recording...	<ul style="list-style-type: none"> Make sure cassette record tab is intact. (P. 4)
The disc cannot be removed...	<ul style="list-style-type: none"> First, unplug unit. Then, prepare a rigid wire (e.g. an extended paper clip, etc.) and, applying moderate force, insert it straight into the hole at the base of the tray. The tray will eject a little. Now, pull the tray all the way out and remove the disc. (P. 10)
In Stop mode, the VCR motor (CYLINDER) continues to rotate..	<ul style="list-style-type: none"> To enable Quick Play mechanism, the VCR cylinder will rotate for about 3 minutes. This reduces response time from Stop to Play mode and from Play to Rewind Search mode.

If you cannot resolve the problem, please call the Customer Satisfaction Center for product assistance at 1-800-211-PANA(7262).
 To locate an authorized servicer call toll free 1-800-211-PANA(7262)
 or send e-mail to : consumerproducts@panasonic.com.

Warning and Instruction Displays

These displays will alert you of a missed operation or provide further instructions.

OSD	Caution
PLEASE SET CLOCK BEFORE PROGRAMMING	If you attempt to set or review a Timer Recording or set the On-Timer and the Clock is not set... (P.16-17)
CHECK CASSETTE RECORD TAB	If you press REC, and a cassette is inserted with no record tab... (P.4, 18)
TO CANCEL TIMER REC HOLD DOWN STOP KEY FOR APPROX 3 SEC	If you press STOP during a Timer Recording... (P.31)
NO CASSETTE PLEASE INSERT A CASSETTE	If you press PLAY, FF, REW, or REC without a cassette inserted... (P.18)
PLEASE PREPARE FOR TIMER REC	If the unit is not in Stop mode or a cassette with record tab is not inserted two minutes before a Timer Recording is about to begin... (P.30-31)
VIDEO HEADS MAY NEED CLEANING PLEASE INSERT HEAD CLEANING CASSETTE OR REFER TO MANUAL END: PLAY	If head cleaning becomes necessary while playing back a tape... (P.6)
VCR LOCK ACTIVATED	If you press a function button other than STOP/EJECT or POWER while the unit is in VCR Lock mode... (P.37)
PLEASE CHECK THE DISC, AND FOR STAINS OR SCRATCHES ON DISC	If you press PLAY, or the unit reads data from a stained or scratched disc in DVD mode. Also, if the type of disc is other than DVD, Video CD or CD... (P.7)
THIS DISC MAY NOT BE PLAYED IN YOUR REGION	Playback of a disc with different region number was attempted. Only discs marked region "1," "ALL," or those that include "1" are playable on this unit. (P.3)
THIS TYPE OF DISC CANNOT BE PLAYED. PLEASE INSERT A DIFFERENT DISC	An unusable disc is inserted in the unit. (P.7)
CANNOT PLAY THIS FILE	This file format cannot be played. (Appears during MP3/WMA/JPEG file playback)(P.54)
THIS FILE IS PROTECTED	This file is copyright protected and cannot be played back. (Playback is prohibited.)(P.54)
IT IS PROHIBITED TO COPY DVD/ VIDEO CD/CD TO VHS	If you press REC in DVD mode... (P.18-19)

Spanish Quick Use Guide/Guía para rápida consulta

■ Conexión para Ant./Cable

Conecte Ant./Cable a la entrada de antena de la TV (VHF/UHF).

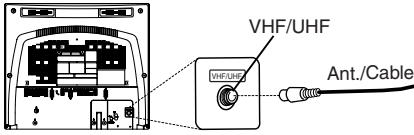

■ Conexión para Sistema Digital de Satelite (DSS)/Convertidor de cable

Conecte la salida del convertidor de cable la entrada "VHF/UHF" con el RF cable.

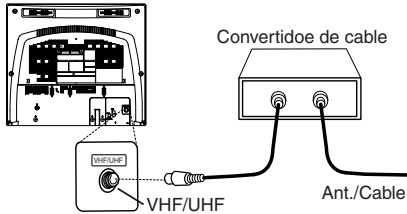

Conecte por favor todas las conexiones del cable o de la antena antes de energizar los aparatos.

Realizando Configuración Inicial

Presione TV/VCR para la modalidad TV-VCR.

1 Conecte el cable electrico de la unidad en el enchufe de pared de la CA.

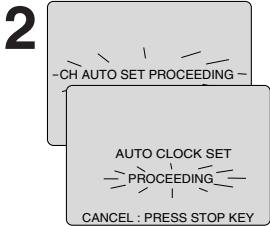

Encienda la TV mediante el control o directamente en la unidad. La unidad inicia la busqueda de canales y ajusta el tiempo automaticamente.

• Si usa convertidor de cable, enciendala y seleccione el Servicio Publico de Canales de Television (PBS) en su horario de uso o tiempo de su zona. Si utiliza receptor DSS este debe de estar apagado.

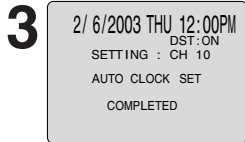

Selecciones se realizaran automaticamente, cuando la configuracion termine la pantalla siguiente aparecera.

• Si "AUTO CLOCK SET IS INCOMPLETE" aparece en pantalla, colóque el tiempo usando el procedimiento manual (MANUAL CLOCK SET), vealo enseguida.

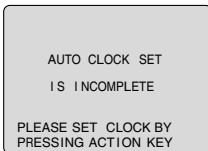

Continúa...

Nota

- Los botones de funciones son inoperantes durante la Configuración inicial.
- Para retirar un cassette durante el Ajuste automático, pulse EJECT dos veces en el control remoto o STOP dos veces en el VCR. En este caso, los ajustes se deben realizar manualmente. (Vea la p.16-17 de Libro de operaciones avanzadas).
- Dependiendo de las condiciones, puede que el Ajuste automático del reloj tarde más de 30 minutos. En ese caso, pulse STOP para detener la configuración y realice los ajustes manualmente. (Vea la p.16-17 de Libro de operaciones avanzadas).

Ajuste Manual del Reloj

Si el ajuste automático del reloj no se ha completado, ajuste el reloj manualmente de la siguiente manera.

1 Presione **ACTION** en el control remoto para visualizar la pantalla del menú **RELOJ**.

2 Presione **▲▼** para seleccionarlo el mes y **SET** para colocarlo. De la misma forma, seleccione y ajuste la fecha, año, hora y DST (Hora de Verano).

3 Presione dos veces la tecla **ACTION** para poner el **RELOJ** en marcha y salir.

Ajustar de nuevo el reloj

1 Presione **ACTION** para visualizar el menú.

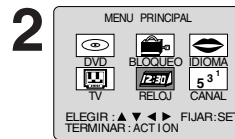

Presione **▲▼▶◀** para seleccionar "RELOJ," y luego Presione **SET**.

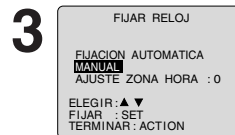

Presione **▲▼** para seleccionar "MANUAL" y luego presione **SET**.



Presione **▲▼** y **SET** para seleccionar y ajustar la hora y la fecha.

5 Presione **ACTION** dos veces para que el reloj comience a funcionar y salir de este modo.

Operaciones básicas para la reproducción (VCR)

- 1 Inserte un cassette.**
 - El videograbador combinado se enciende automáticamente.
 - 2 Presione PLAY.**
 - La reproducción comienza automáticamente si el cassette no tiene la lengüeta para prevención de grabación.
- Para encontrar una escena en particular
 - Búsqueda hacia adelante → **Presione FF/SLOW+**
 - Búsqueda hacia atrás → **Presione REW/SLOW-**
 - Para ver una imagen fija (congelada) → **Presione STILL/PAUSE**
 - Para ver en cámara lenta → **Presione FF/SLOW+** o **REW/SLOW-** en el modo de imagen fija
 - Para ver imágenes cuadro a cuadro → **Presione STILL/PAUSE** en el modo de imagen fija
 - Para parar → **Presione STOP**
 - Para rebobinar la cinta → **Presione REW/SLOW-**
 - Para hacer avanzar la cinta rápidamente → **Presione FF/SLOW+**
 - Para expulsar el cassette → **Presione EJECT** en el control remoto o **STOP/EJECT** en el videograbador combinado

Operaciones básicas para la grabación

- 1 Inserte un cassette con la lengüeta para prevención de grabado.**
 - El videograbador combinado se enciende automáticamente.
- 2 Presione CH ▲▼ o las teclas numéricas para seleccionar el canal.**
- 3 Presione SPEED para seleccionar la velocidad de grabación.**
 - SP = reproducción normal
 - LP = reproducción larga
 - SLP = reproducción super larga
 - La velocidad seleccionada debe aparecer en la pantalla.
- 4 Presione REC para comenzar la grabación.**
 - Para no editar ó grabar partes de una grabación, presione STILL/PAUSE para hacer una pausa durante la grabación.
 - No podrá ver otro canal durante la grabación.
- Para parar → **Presione STOP.**
- Si se desea que el videograbador deje de grabar a una hora prefijada.** (Grabación de un toque)
 - Presione REC** repetidamente para ajustar la hora de grabación (30 min - 4 horas.)

Grabación con temporizador

- 1 Presione PROG** para visualizar "FIJAR PROGRAMACION."

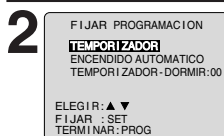

- 1) Presione ▲▼** para seleccionar "TEMPORIZADOR."
- 2) Presione SET** para visualizar.

• Si ya existe un programa en la memoria, **presione ▲▼** y **SET** para seleccionar un número de programa sin usar.



- Presione ▲▼** para seleccionar y **presione SET** o ◀▶ para colocar.
- 1-31 = Grabación única
 - DIARIO = a la misma hora de lunes a viernes
 - SEMANTAL = a la misma hora una vez a la semana

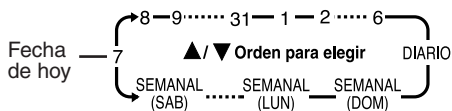

Repita el paso 3 para ajustar: hora de comienzo, hora de parada, canal (o LINEA para una fuente exterior), velocidad (SP, LP, SLP)

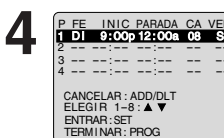

- Presione PROG** para terminar el programa. **Para introducir más programas, presione ▲▼** y **SET** para seleccionar el número de programa en blanco, y luego repita los pasos 3.

- 5 Presione PROG dos veces** para salir de este modo.

- Si está usando un decodificador de TV cable, asegúrese que se encuentra en el canal deseado y que la alimentación queda conectada para grabar con temporizador.
- El indicador PROG TIMER se enciende en el videograbador combinado.

Operaciones básicas del DVD

1 Presione **POWER** en el control remoto o el aparato y luego el boton DVD.

2 Introducir un disco.

- 1) Presione **OPEN/CLOSE**.
- 2) Ponga un disco en la bandeja de disco.
 - Sujete el disco sin tocar ninguna de sus superficies, póngalo con el lado donde esté impreso el título hacia arriba, alinéelo con las guías y póngalo en su posición apropiada.
Disco de 3" (8 cm) Disco de 5" (12 cm)

3 Presione **PLAY** para iniciar la reproducción. La bandeja del disco se cierra automáticamente.

- Si está usando un DVD interactivo (Interactive DVD) o un Vídeo CD con control de reproducción (playback control) y aparece un menú de títulos (TITLE MENU) en la pantalla, siga al paso 4.

4 1) Presione **▲▼◀▶** o las teclas numéricas para seleccionar el artículo deseado.
2) Presione **SET** para la reproducción. Si usa las teclas numéricas, la reproducción comienza automáticamente.

5 Presione **STOP** para parar la reproducción.

6 Presione **OPEN/CLOSE** para expulsar el disco.

■ Para buscar una escena en particular **Búsqueda hacia adelante**
Presione **FF/SLOW+** en el modo de reproducción.
Búsqueda hacia atrás →
Presione **FF/SLOW-** en el modo de reproducción. (Para liberar, presione **PLAY**)

■ Para saltar un capítulo o una pista **Salto hacia adelante**
Presione **SKIP+ ▶▶** en el modo de reproducción. Un capítulo (DVD) o una pista (Vídeo CD/CD) se salta cada vez que se oprime la tecla.
Salto hacia atrás →
Presione **SKIP- ◀◀** en el modo de reproducción.

■ Para ver una imagen fija
Presione **PAUSE** durante la reproducción. (Para liberar, presione **PLAY**)

■ Para ver imágenes cuadro a cuadro (DVD/Vídeo CD)
Presione **STILL/PAUSE** en el modo de imagen fija. La imagen avanza un cuadro cada vez que presiona la tecla. (Para volver a la reproducción normal, presione **PLAY**.)

■ Para ver en cámara lenta (DVD/Vídeo CD)
Presione **FF/SLOW+** o **FF/SLOW-** en el modo de imagen fija. (Para liberar, presione **PLAY**)

Cambio del idioma de subtítulos [DVD solamente]

El idioma de los subtítulos seleccionado al hacer las fijaciones iniciales se puede cambiar por otro idioma diferente, si éste se encuentra disponible.



Presione **SUBTITLE** durante la reproducción.

- Cuando no haya subtítulos grabados, " " se visualizará en lugar del número de idioma.



- 1) Presione **▲▼** para seleccionar el idioma deseado.
- 2) Presione **▶** (o **◀**) para seleccionar "ACTIVO" o "INACTIVO."

Cambio del idioma de la pista de sonido [DVD solamente]

El idioma de la pista de sonido seleccionado al hacer las fijaciones iniciales se puede cambiar por otro idioma diferente, si éste se encuentra disponible.



Presione **AUDIO** durante la reproducción para visualizar la pantalla **AUDIO**.



Presione **▲▼** para seleccion el idioma deseado.

Visión desde otro ángulo [DVD solamente]

Algunos discos DVD tienen escenas que han sido filmadas simultáneamente desde un número de ángulos diferentes. Con estos discos, la misma escena podrá verse desde cada uno de estos ángulos diferentes utilizando el botón ANGLE.

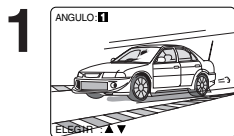

Presione ANGLE durante la reproducción para visualizar la pantalla de ángulo.

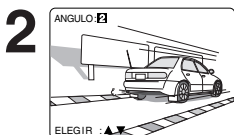

Presione ▲▼ para seleccionar el ángulo deseado.

Selección de vocal para los discos de Karaoke [DVD/Video CD]

1 Presione **AUDIO** durante la reproducción para visualizar la pantalla AUDIO.

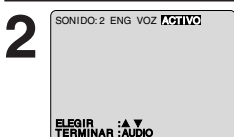

- 1) Presione ▲▼ (o ◀▶) para seleccionar el ajuste deseado.
- 2) Presione ▶◀ (o ◀▶) para ajustar. (DVD solamente)

- DVD Karaoke (1 vocal)
VOCAL ON→VOCAL OFF
- DVD Karaoke (2 vocales)
VOCAL V1→VOCAL V2→VOCAL V1+V2→VOCAL OFF
- Video CD
LR→L→R

Ampliación de la imagen [DVD solamente]

Durante la reproducción de un DVD, puede ampliar a imagen seleccionando la relación de zoom usando el botón ZOOM mediante control remoto.

Selección el tamaño de la imagen.

Presione **ZOOM** repetidamente para cambiar el tamaño de la imagen como se indica a continuación:

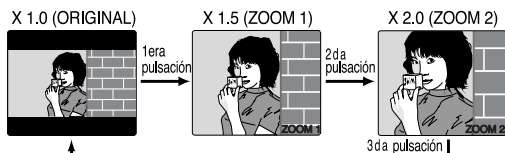

■ Use los botones ▲, ▼, ◀ y ▶ para desplazar la posición hacia arriba, hacia abajo, hacia la izquierda o hacia la derecha.

Utilización de un menú de títulos [DVD solamente]

Algunos discos con películas, por ejemplo, vienen con dos o más títulos. Si el disco tiene un menú de títulos grabados, el botón TITLE podrá utilizarse para seleccionar el título de la película.

1 Presione **TITLE** durante la reproducción. Ahora se visualiza una lista de los títulos del disco.

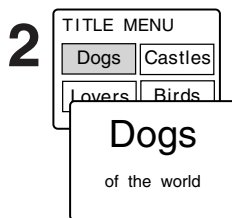

- 1) Presione ▲▼ ◀▶ o las teclas numéricas para seleccionar el título deseado.
- 2) Presione **SET** o **PLAY**.

Utilización de un menu de DVD [DVD solamente]

Algunos discos DVD tienen estructuras únicas de menús llamadas menús DVD. Por ejemplo, los DVDs programados con un contenido complejo proporcionan menús guía, y los grabados con varios idiomas proporcionan menús para audio e idiomas de subtítulos. Aunque los contenidos de los menús DVD y la operación cambian de disco a disco, a continuación se explica la operación básica cuando se utiliza esta característica.

1 Presione **MENU** durante la reproducción. El menú de DVD introducido en el disco se visualiza ahora.

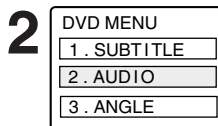

- 1) Presione ▲▼◀▶ o las teclas numéricas para seleccionar el artículo deseado.
- 2) Presione **SET** o **PLAY**.

Reproducción programada [Vídeo CD/CD]

Puede usted programar pistas específicas y el orden de reproducción.

- 1 Presione **ACTION** en el modo paro (STOP) para visualizar MAIN MENU.

2

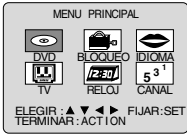

- 1) Presione **▲▼◀▶** para seleccionar "DVD."
- 2) Presione **SET** para visualizar.

3

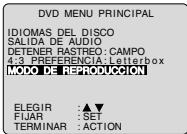

- 1) Presione **▲▼** para seleccionar "MODO DE REPRODUCCION."
- 2) Presione **SET** para visualizar.

4



- 1) Presione **▲▼** para seleccionar "REPRODUCCION DE PROGRAMAS."
- 2) Presione **SET** para visualizar.

5

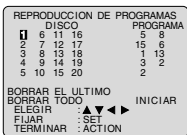

- 1) Presione **▲▼◀▶** para seleccionar el número de la pista deseada. (Se visualizan los números de la pista del disco).
- 2) Presione **SET** para seleccionar.
 - Repita el paso 5 para seleccionar otra pista.
 - La pista seleccionada se añade a la parte derecha.

6



- 1) Presione **▲▼◀▶** para seleccionar "INICIAR."
- 2) Presione **SET**.
 - La reproducción comienza en la secuencia programada.
 - Para cancelar, presione STOP durante la reproducción y luego presione CLEAR.

Reproducción arbitraria [Vídeo CD/CD]

Las pistas se reproducen de forma arbitraria.

- 1 Repita los pasos 1-3 de la "Reproducción programada".

2

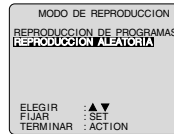

- 1) Presione **▲▼** para seleccionar "REPRODUCCION ALEATORIA."
- 2) Presione **SET**.
 - Comienza la reproducción arbitraria.
 - Para cancelar, presione STOP durante la reproducción y luego presione CLEAR.

Funcionamiento del DVD utilizando visualizaciones en pantalla

Cuando se presiona DISPLAY, la visualización en pantalla muestra la información del disco (título / capítulo / número de lista, tiempo transcurrido de reproducción, audio / idioma del subtítulo, y ángulo) e información (repetir la reproducción, modo reproducción, Karaoke vocal encendido / apagado, etc.).

1 Presione **DISPLAY** en el modo reproducción o parada para visualizar en pantalla.

- Cada vez que se presione **DISPLAY**, la visualización en pantalla cambia como se muestra a continuación.

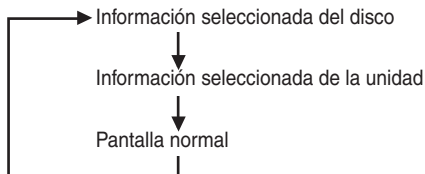

2 1) Presione **▲▼** (o **◀▶**) para seleccionar el artículo deseado.
2) Presione **SET** para colocar.

3 <Ejemplo de DVD>



- 1) Presione **▲▼** para seleccionar el ajuste deseado.
2) Presione **SET** para colocar.

<Ejemplo de Vídeo CD>

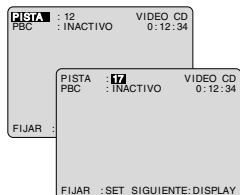

Para volver a la pantalla normal, presione repetidamente **CLEAR** o **DISPLAY**.

Fijaciones iniciales

1 Presione **ACTION** en el modo de paro (STOP) para visualizar MAIN MENU.

2 1) Presione **▲▼◀▶** para seleccionar "DVD."
2) Presione **SET** para visualizar.

3 1) Presione **st** para seleccionar el artículo deseado.
2) Presione **SET**.

IDIOMAS DEL DISCO

Todos los idiomas ofrecidos en el disco pueden ser ajustados. Si el idioma ajustado no es ofrecido en el disco, se seleccionará el idioma original del disco.

SALIDA DE AUDIO

Puede usted ajustar la salida audio procedente de la terminal de salida audio digital.

DETENER RASTREO

Para seleccionar "CAMPO" o "CUADRO" para prevenir inestabilidad o para permitir ver textos pequeños o patrones finos claramente en el modo de imagen fija.

4 : 3 PREFERENCIA

Para seleccionar si el material del vídeo para pantalla ancha será vuelto a reproducir en el estilo Pan&Scan o en el estilo Letterbox en la pantalla.

4 1) Presione **st** para seleccionar el artículo deseado.
2) Presione **SET**.

5 Volver a visualizar el menú de DVD para continuar el ajuste. Presione **ACTION** y pase al paso 3 para ajustar otro artículo o, para salir, presione **ACTION** tres veces.

Selección de IDIOMAS DEL DISCO [DVD solamente]

Seleccione "AUDIO"

Inglés/Español/Francés/Japones: (Fijación de fábrica : inglés)
Original : Se seleccionará el idioma original de cada disco.

OTRO ** :** Se puede seleccionar el otro idioma.

Seleccione "SUBTITULO"

AUTO : Se seleccionará el mismo que fue seleccionado en la preparación de "AUDIO". (Fijación de fábrica)

- Si el idioma seleccionado en la preparación de "AUDIO" se utiliza durante la reproducción, los subtítulos no aparecerán.
- Si se utiliza otro idioma durante la reproducción, los subtítulos aparecerán en el idioma seleccionado en la preparación de "AUDIO"

Inglés/Español/Francés/Japones

OTRO ** :** Se puede seleccionar el otro idioma.

Seleccione "MENU"

Inglés/Español/Francés/Japones: (Fijación de fábrica : inglés)
OTRO ** :** Se puede seleccionar el otro idioma.

Selección de DETENER RASTREO

- AUTO :** Durante el modo de imagen fija se seleccionarán automáticamente "Campo fijo" o "Cuadro fijo" (Fijacion de fabrica)
- CAMPO :** Seleccione este ajuste cuando ocurra "distorsión" en las imagenes, incluso cuando se haya seleccionado "AUTO".
- CUADRO :** "Cuadro fijo" esta siempre seleccionado. Se utiliza cuando no se puedan ver claramente textos pequeño o patrones finos incluso cuando esté seleccionado "AUTO".

Selección de 4 : 3 PREFERENCIA

- 4:3 Pan&Scan :** Datos de la pantalla ancha de vídeo son reproducidos en el estilo Pan & Scan (la parte derecha e izquierda de la pantalla son recortadas). (Fijacion de fábrica)
- Datos de vídeo no formateados en Pan & Scan serán reproducidos en el estilo letterbox.
- 4:3 Letterbox :** Datos de la pantalla ancha de vídeo son reproducidos en el estilo Letterbox (la parte de arriba y abajo de la pantalla tienen un margen negro).

Funcionamiento de la ejecución de MP3/WMA/JPEG

Puede utilizar esta unidad para reproducir audio de formato MP3/WMA/JPEG, grabado para uso personal con una computadora, etc., en un CD-ROM o CD-RW.

La ejecución puede no tener lugar en algunos casos, debido a las condiciones de la grabación.

- 1 Presione POWER** en el control remoto o unidad.
- 2 Presione OPEN/CLOSE** y a continuacion coloque un disco MP3/WMA/JPEG en la bandeja de discos.
Presione OPEN/CLOSE para cerrarla.
- 3** Se visualizará el MENU MP3/WMA/JPEG y la ejecución se iniciará automáticamente.
(Se visualizará el directorio del CD.)

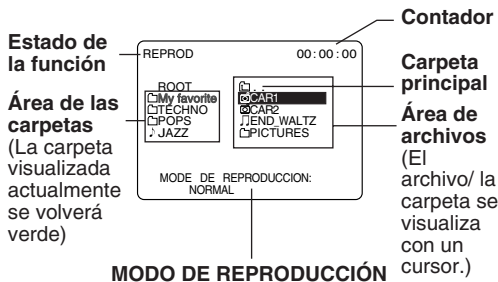

■Ejecución MP3/WMA/JPEG (Durante el modo STOP)

Presione ▲▼ para seleccionar un archivo MP3/WMA (🎵/🎵) o un archivo JPEG (🖼️), y presione SET o PLAY.

• MP3/WMA

Búsqueda hacia adelante/hacia atrás

→Presione FF/SLOW+ o REW/SLOW- durante la ejecución.

Salto de Pista hacia adelante/hacia atrás

→Presione SKIP+ ▶▶ | o SKIP- ◀◀ durante la ejecución.

• JPEG

Búsqueda siguiente/anterior

→Presione SKIP+ ▶▶ | o SKIP- ◀◀.

Inicie la muestra-diapositiva

→Presione FF/SLOW+ o REW/SLOW-.

Ampliando una imagen →Presione ZOOM.

Rotando una imagen →Presione ANGLE.

Presione STOP para detener la operacion descrita arriba.

■Seleccione MODO DE REPRODUCCION

(Durante el modo STOP)

Presione ◀▶ para mover el cursor a MODO DE REPRODUCCION, y Presione ▲▼ para seleccionar el MODO DE REPRODUCCIÓN deseado.

[MODO DE REPRODUCCIÓN]

NORMAL: Todos los archivos se reproducen sólo una vez

REPETICION DE UNA MUSIC:

El archivo seleccionado se reproduce repetidamente.

REPETICION DE UN ARCHIVO:

Los archivos que se encuentran en la carpeta seleccionada se reproducen repetidamente.

REPETICION DEL DISCO:

Todos los archivos se reproducen repetidamente.

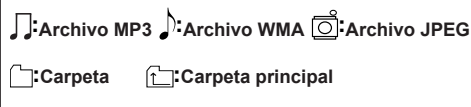

- 4 Presione ACTION** para regresar al DVD MAIN PRINCIPAL.

Limited Warranty

PANASONIC CONSUMER ELECTRONICS COMPANY, DIVISION OF MATSUSHITA ELECTRIC CORPORATION OF AMERICA
One Panasonic Way Secaucus, New Jersey 07094

PANASONIC SALES COMPANY, DIVISION OF MATSUSHITA ELECTRIC OF PUERTO RICO, INC., AVE. 65 de Infantería, Km. 9.5 San Gabriel Industrial Park, Carolina, Puerto Rico 00985

Panasonic/Quasar Video Products Limited Warranty

Limited Warranty Coverage

If your product does not work properly because of a defect in materials or workmanship, Panasonic Consumer Electronics Company or Panasonic Sales Company (collectively referred to as "the warrantor") will, for the length of the period indicated on the chart below, which starts with the date of original purchase ("warranty period"), at its option either (a) repair your product with new or refurbished parts, or (b) replace it with a new or a refurbished product. The decision to repair or replace will be made by the warrantor.

Product	Parts	Labor	Service	Contact Number
Camcorder	One (1) Year (except CCD Image Sensor)	Ninety (90) Days	Carry-In or Mail-In	1-800-211-PANA(7262)
	CCD Image Sensor - 6 (Six) Months	Ninety (90) Days		
DVD/VCR Deck, A/V Mixer	One (1) Year	Ninety (90) Days	Carry-In or Mail-In	1-800-211-PANA(7262)
TV/VCR, TV/DVD, TV/DVD/VCR Combination	One (1) Year (except CRT) CRT - Two (2) Years	Ninety (90) Days Ninety (90) Days	Carry-In: 21" CRT and Smaller In-Home or Carry-In: 22" CRT and Larger	1-800-211-PANA(7262)
TV/HDR Combination	One (1) Year (except CRT) CRT - Two (2) Years	Ninety (90) Days Ninety (90) Days	In-Home or Carry-In	1-888-843-9788
Rechargeable Batteries (in exchange for defective item)	Ten (10) Days	Not Applicable	Carry-In or Mail-In	1-800-211-PANA(7262)
Tape (in exchange for defective item)	Five (5) Days	Not Applicable	Carry-In or Mail-In	1-800-211-PANA(7262)
Memory Cards (in exchange for defective item)	Ninety (90) Days	Not Applicable	Carry-In or Mail-In	1-800-211-PANA(7262)

During the "Labor" warranty period there will be no charge for labor. During the "Parts" warranty period, there will be no charge for parts. You must carry-in or mail-in your product or arrange for in-home service, as applicable, during the warranty period.

If non-rechargeable batteries are included, they are not warranted. This warranty only applies to products purchased and serviced in the United States or Puerto Rico. This warranty is extended only to the original purchaser of a new product which was not sold "as is". A purchase receipt or other proof of the original purchase date is required for warranty service.

Carry-In, Mail-in or In-Home Service

For Carry-In, Mail-In or In-Home Service (as applicable) in the United States call toll free contact number listed above or visit Panasonic Web Site: <http://www.panasonic.com>

For assistance in Puerto Rico call Panasonic Sales Company (787)-750-4300 or fax (787)-768-2910.

In-Home service, if applicable, requires clear, complete and easy access to the product by the authorized servicer and does not include removal or re-installation of an installed product. It is possible that certain in-home repairs will not be completed in-home, but will require that the product, or parts of the product, be removed for shop diagnosis and/or repair and then returned.

Limited Warranty Limits And Exclusions

This warranty ONLY COVERS failures due to defects in materials or workmanship, and DOES NOT COVER normal wear and tear or cosmetic damage, nor does it cover markings or retained images on the picture tube resulting from viewing fixed images (including, among other things, letterbox pictures on standard 4:3 screen TV's, or non-expanded standard 4:3 pictures on wide screen TV's, or onscreen data in a stationary and fixed location). The warranty ALSO DOES NOT COVER damages which occurred in shipment, or failures which are caused by products not supplied by the warrantor, or failures which result from accidents, misuse, abuse, neglect, mishandling, misapplication, alteration, faulty installation, set-up adjustments, misadjustment of consumer controls, improper maintenance, power line surge, lightning damage, modification, or commercial use (such as in a hotel, office, restaurant, or other business), rental use of the product, service by anyone other than a Factory Servicenter or other Authorized Servicer, or damage that is attributable to acts of God.

THERE ARE NO EXPRESS WARRANTIES EXCEPT AS LISTED UNDER "LIMITED WARRANTY COVERAGE". THE WARRANTOR IS NOT LIABLE FOR INCIDENTAL OR CONSEQUENTIAL DAMAGES RESULTING FROM THE USE OF THIS PRODUCT, OR ARISING OUT OF ANY BREACH OF THIS WARRANTY. (As examples, this excludes damages for lost time, cost of having someone remove or re-install an installed unit if applicable, or travel to and from the servicer, loss of media or images, data or other memory or recorded content. The items listed are not exclusive, but are for illustration only.)

ALL EXPRESS AND IMPLIED WARRANTIES, INCLUDING THE WARRANTY OF MERCHANTABILITY, ARE LIMITED TO THE PERIOD OF THE LIMITED WARRANTY.

Some states do not allow the exclusion or limitation of incidental or consequential damages, or limitations on how long an implied warranty lasts, so the exclusions may not apply to you.

This warranty gives you specific legal rights and you may also have other rights which vary from state to state. If a problem with this product develops during or after the warranty period, you may contact your dealer or Servicenter. If the problem is not handled to your satisfaction, then write to the warrantor's Consumer Affairs Department at the addresses listed for the warrantor.

PARTS AND SERVICE (INCLUDING COST OF AN IN-HOME SERVICE CALL, WHERE APPLICABLE) WHICH ARE NOT COVERED BY THIS LIMITED WARRANTY ARE YOUR RESPONSIBILITY.

Customer Services Directory

*For Product Information, Operating Assistance, Literature Request, Dealer Locations, and all Customer Service inquiries please contact:
1-800-211-PANA (7262), Monday-Friday 9 am-9 pm; Saturday-Sunday 10 am-7 pm, EST. or send e-mail : consumerproducts@panasonic.com
For hearing or speech impaired TTY users, TTY : 1-877-833-8855*

*Web Site: <http://www.panasonic.com>
You can purchase parts, accessories or locate your nearest servicenter by visiting our Web Site.*

Accessory Purchases:

1-800-332-5368 (Customer Orders Only)
For hearing or speech impaired TTY users, TTY : 1-866-605-1277
Panasonic Services Company 20421 84th Avenue South, Kent, WA 98032
(Monday-Friday 6 am-5 pm; Saturday 6 am-10:30 am, PST)
(Visa, MasterCard, Discover Card, American Express, Check)

Service in Puerto Rico

**Matsushita Electric of Puerto Rico, Inc. Panasonic Sales Company/
Factory Servicenter:**

**Ave. 65 de Infantería, Km. 9.5, San Gabriel Industrial Park,
Carolina, Puerto Rico 00985**

Phone (787)750-4300 Fax (787)768-2910

As of August 2002

Index

TV / VCR

- A** Accessories 4
- AC Power Plug..... 11
- ACTION button 8, 16
- ADD/DLT/CLEAR button 8, 17
- Audio Adjustment 45
- Audio Auto Gain Control (AGC) 44
- AUDIO button 8, 23, 42
- Audio Connections 12
- Audio Features 42-43
- Audio Menu 44
- Audio Mode for FM Radio 29
- Audio Mode for Playback 42
- Audio Mode for Recording 42
- Audio Mode for TV Viewing 23
- Audio Mute 22
- Audio/Video Input
connector (LINE) 10, 19
- Audio Output Connector (L/R) 11-12
- Auto Operation Functions 35
- B** Batteries 4
- Before Requesting Service 62-63
- Before Using 4
- Blocking Message 41
- Blue Screen Display 27
- Broadcast Types 23
- C** Cassette Compartment 10
- Caption On Mute 25
- Channel 16-17, 27
- CHANNEL UP / DOWN button 8, 22
- Clock 16-17
- Closed Caption 24-25
- CM SKIP/ZERO SEARCH button 8, 34-35
- Commercial Skip 35
- Connections 11
- Connections, Audio 12
- Connections, DSS / Cable Box 11
- Connections, Antenna / Cable 11
- Copy Your Tapes (Dubbing) 19
- COUNTER RESET button 8, 34
- Customer Services Directory 73
- D** DISPLAY button 8, 27
- DST (Daylight Saving Time) 6
- E** EJECT button 8-9
- Eject tape 18
- F** Fast Forward 18
- FF/SLOW+ button 8, 18
- FM button 8, 28-29
- FM Radio 28-29
- Forward Search 18
- Frame by Frame Advance 18
- Front Panel Indicators 9
- Function Display 27
- H** Head Cleaning 6
- I** Important Safeguards and Precautions 2
- Information (Unit, Cassette, Disc) 6-7
- Initial Setup 14
- Index Search 32
- Indicators on the Front Panel 9
- Input Mode 19
- L** Language 16
- Limited Warranty 72-73
- Location of Controls 8-11
- M** MTS Broadcast / TV Stereo System 23
- MUTE button 8, 22
- N** NUMBER keys 8, 22
- O** 100 Key 22
- One Touch Recording (OTR) 18
- On-Screen Display (OSD) 27
- ON-TIMER Indicator 9, 26
- ON-TIMER with Alarm 26
- P** Phones 22
- Playback 18
- PLAY button 8, 18
- POWER button 8, 14
- PROG button 8, 26, 30
- PROG TIMER Indicator 9, 30
- Q** Quality Picture 6
- R** Rapid Tune 22
- R-TUNE button 8, 22
- REC button 8, 18
- REC Indicator 9, 18
- Rec(ord) 18
- Record / Playback Speed Settings 4
- Remote Control Buttons 8
- Remote Sensor 9
- Repeat Play 33
- Reset Language, Channels, Clock 16-17
- Reset unit 15
- Reverse Search 18
- REW/SLOW- button 8, 18
- Rewind 18
- S** Safety Precautions 3
- SEARCH button 8, 32-33
- Secret Code 38
- Selecting Input Mode 19
- SELECT / SET button 8, 16
- Sleep Timer 26
- Slow Motion 18
- Spanish Quick Use Guide 65-71
- Special VCR Features 36-37
- Specifications 6
- SPEED button 8, 18
- Still Picture 18
- STILL/PAUSE button 8, 18
- STOP button 8, 18
- SURROUND button 8, 43
- Surround Sound 43

TV / VCR

T Table of Contents.....	5
Tape Erasure Prevention	4
Tape Operation	32-35
Timer Program Review, Replace, Clear	31
Timer Recording	30
Timer Recording Cancellation	31
Time Zone Adjust.....	17
TRACKING / V-LOCK buttons.....	6, 8
TV Operation	22
TV Timer Features	26
TV/VCR button.....	8
TV/VCR Status & Clock Display	27
U Unit, Front/Rear View.....	10-11
US MOVIES Ratings.....	39
US TV PROGRAMS Ratings	40

V VCR Lock	37
Video Adjustment.....	45
Video Menu.....	44
V-Chip Control Feature	38-41
VHF / UHF Antenna Input Terminal	11
VOLUME UP / DOWN button	8, 22
W Warning and Instruction Displays	64
Weak Signal Display Feature.....	36
Z Zero Search.....	34

DVD

A ANGLE button	8, 47, 56
ANGLE Indicator.....	9, 47
Auto-Power Off function.....	21
AUDIO button	8, 46, 47
AUDIO OUTPUT.....	59
Audio soundtrack language (DVD)	46
B Basic DVD Operation.....	20
C CLEAR button.....	8, 49-51
D Definition of terms	7
Disc Audio attribute 1 type, sampling frequency, bit No.	46
Disc format	7
Disc handling	7
Disc information screen.....	52
DISC LANGUAGES (DVD)	58
Disc Operation.....	46-50
Disc Tray	7, 10, 20
DISPLAY button.....	8, 51
DVD button	8, 20
DVD Lock Feature (DVD).....	57
DVD Lock Ratings (DVD).....	57
DVD menu (DVD)	48
DVD Operation using On-Screen Displays	51
DVD Volume Adjust	43
F Forward / Reverse Chapter / Track skip	21
Forward / Reverse rapid scene search	21
Frame by Frame picture (DVD/Video CD)	21
J JPEG Playback.....	55-56
K Karaoke (DVD/Video CD)	47

L Language Code List	61
M MENU button	8, 48
MP3 Playback.....	55
Multiple angle viewing (DVD).....	47
O OPEN / CLOSE button	8, 20
Optical digital audio output connector	11-13
P Picture Zoom (DVD)	47
Play.....	20
Playback control (Video CDs).....	21
PLAY button.....	8, 20
Program Play (Video CD/CD).....	49
Program Repeat Play (Video CD/CD)	49
R Random Play (Video CD/CD).....	50
Region number	3
Repeat Play	53
RESUME function	21
RETURN button	8, 20
REW/FF/SLOW +/- button.....	8, 20-21, 55-56
S Settings for DVD Operation	58-60
SKIP+ ►►►I/SKIP- I◄◄.....	8, 20-21, 54-56
Slow Motion (DVD/Video CD).....	21
STILL MODE	60
Still (Pause) Picture	21
STILL / PAUSE button	8, 21
Subtitle language (DVD).....	46
SURROUND/VSS button.....	8, 43
T TV MODE	60
Title menu (DVD)	48
U Unit information screen (Unit).....	53
V V.S.S. (Virtual Surround Sound)	43
W WMA Playback	55
Z ZOOM button.....	8, 47

LSQT0667C

Panasonic Consumer Electronics Company,
Division of Matsushita Electric Corporation of America
One Panasonic Way Secaucus, New Jersey 07094

Panasonic Sales Company ("PSC"),
Division of Matsushita Electric of Puerto Rico, Inc.
Ave. 65 de Infantería, Km. 9.5
San Gabriel Industrial Park, Carolina, Puerto Rico 00985



Printed in Indonesia
LSQT0667C
S0203-2033