

Panasonic®

Operating Instructions

LCD TV

Model No. **TC-22LH30**



For assistance, please call : 1-800-211-PANA (7262)
or send e-mail to : consumerproducts@panasonic.com
or visit us at www.panasonic.com (U.S.A.)

For assistance, please call : 787-750-4300
or visit us at www.panasonic.com (Puerto Rico)

For assistance, please call : 1-800-561-5505
or visit us at www.panasonic.ca (Canada)

Before connecting, operating or adjusting this product, please read these instructions completely.
Please keep this manual for future reference.

English

Español [Resumen]

TQBC0874

Important Safety Instructions

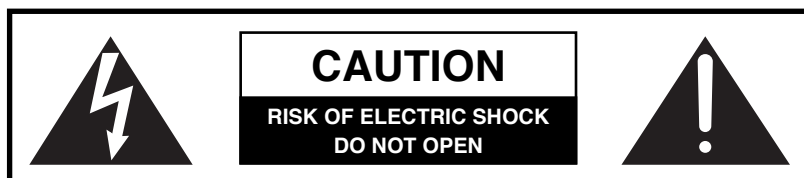

The lightning flash with arrow head within a triangle is intended to tell the user that parts inside the product are a risk of electric shock to persons.



The exclamation point within a triangle is intended to tell the user that important operating and servicing instructions are in the papers with the appliance.

■ **Note to CATV System Installer:** This reminder is provided to direct the CATV system installer's attention to Article 820-40 of the NEC that provides guidelines for proper grounding and, in particular, specifies that the cable ground shall be connected to the grounding system of the building, as close to the point of cable entry as practical.

■ Important Safety Instructions for LCD TV

- 1) Read these instructions. All the safety and operating instructions should be read before the appliance is operated.
- 2) Keep these instructions.
- 3) Heed all warnings.
- 4) Follow all instructions.
- 5) Do not use this apparatus near water. For example: Avoid placing it near a bathtub, washbowl, kitchen sink, or laundry tub, in a wet basement, or near a swimming pool, etc.
- 6) Clean only with dry cloth. Unplug this LCD TV from the wall outlet before cleaning. Do not use liquid or aerosol cleaners.
- 7) Do not block any ventilation openings. Install in accordance with the manufacturer's instructions. Slots and openings in the cabinet and the back or bottom are provided for ventilation, and to ensure reliable operation of the LCD TV and to protect it from overheating. These openings must not be blocked or covered. There should be at least 10 cm of space from these openings. The openings should never be blocked by placing the LCD TV on a bed, sofa, rug or other similar surface. This LCD TV should not be placed in a built-in installation such as a bookcase unless proper ventilation is provided.
- 8) Do not install near any heat sources such as radiators, heat registers, stoves, or other apparatus (including amplifiers) that produce heat.
- 9) Do not defeat the safety purpose of the polarized or grounding-type plug. A polarized plug has two blades with one wider than the other. A grounding type plug has two blades and a third grounding prong. The wide blade or the third prong are provided for your safety. If the provided plug does not fit into your outlet, consult an electrician for replacement of the obsolete outlet.
- 10) Protect the power cord from being walked on or pinched particularly at plugs, convenience receptacles, and the point where they exit from the apparatus.
- 11) Only use attachments/accessories specified by the manufacturer. Otherwise it may cause hazards.
- 12) Use only with the cart, stand, tripod, bracket, or table specified by the manufacturer, or sold with the apparatus. When a cart is used, use caution when moving the cart/apparatus combination to avoid injury from tip-over. 
- 13) Unplug this apparatus during lightning storms or when unused for long periods of time. This will prevent damage to the receiver due to lightning and power-line surges.
- 14) Refer all servicing to qualified service personnel. Servicing is required when the apparatus has been damaged in any way, such as power-supply cord or plug is damaged, liquid has been spilled or objects have fallen into the apparatus, the apparatus has been exposed to rain or moisture, does not operate normally, or has been dropped.
Upon completion of any service or repairs to this LCD TV, ask the service technician to perform routine safety checks to determine that the television is in safe operating condition.
- 15) Operate only from the type of power source indicated on the marking label. If you are not sure of the type of power supplied to your home consult your television dealer or local power company.
- 16) Follow all warnings and instructions marked on the LCD TV.
- 17) Never push objects of any kind into this LCD TV through cabinet slots as they may touch dangerous voltage points or short out parts that could result in a fire or electric shock. Never spill liquid of any kind on the LCD TV.

Important Safety Instructions

18) If an outside antenna is connected to the television equipment, be sure the antenna system is grounded so as to provide some protection against voltage surges and built up static charges. In the U.S. Selection 810-21 of the National Electrical Code provides information with respect to proper grounding of the mast and supporting structure, grounding of the lead-in wire to an antenna discharge unit, size of grounding conductors, location of antenna discharge unit, connection to grounding electrodes, and requirements for the grounding electrode.

19) An outside antenna system should not be located in the vicinity of overhead power lines or other electric light or power circuits, or where it can fall into such power lines or circuits. When installing an outside antenna system extreme care should be taken to keep from touching such power lines or circuits as contact with them might be fatal.

20) Unplug this LCD TV from the wall outlet, and refer servicing to qualified service personnel under the following conditions:

- a. When the power cord or plug is damaged or frayed.
- b. If liquid has been spilled into the LCD TV.
- c. If the LCD TV has been exposed to rain or water.
- d. If the LCD TV does not operate normally by following the operating instructions.

Adjust only those controls that are covered by the operating instructions as improper adjustment of other controls may result in damage and will often require extensive work by a qualified technician to restore the LCD TV to normal operation.

- e. If the LCD TV has been dropped or the cabinet has been damaged.
- f. When the LCD TV exhibits a distinct change in performance - this indicates a need for service.

21) When replacement parts are required, be sure the service technician uses replacement parts specified by the manufacturer that have the same characteristics as the original part. Unauthorized substitutions may result in fire, electric shock, or other hazards.

22) **WARNING : TO REDUCE THE RISK OF FIRE OR ELECTRIC SHOCK, DO NOT EXPOSE THIS APPARATUS TO RAIN OR MOISTURE. DO NOT PLACE LIQUID CONTAINERS (FLOWER VASES, CUPS, COSMETICS, ETC.) ABOVE THE SET. (INCLUDING ON SHELVES ABOVE, ETC.)**

23) **CAUTION :** TO PREVENT ELECTRIC SHOCK DO NOT USE THIS PLUG WITH A RECEPTACLE OR OTHER OUTLET UNLESS THE BLADES CAN BE FULLY INSERTED TO PREVENT BLADE EXPOSURE.

24) **CAUTION :** USE WITH OTHER STAND MAY RESULT IN INSTABILITY CAUSING POSSIBLE INJURY.

25) **CAUTION :** DANGER OF EXPLOSION IF BATTERY IS INCORRECTLY REPLACED. REPLACE ONLY WITH THE SAME OR EQUIVALENT TYPE.

EXAMPLE OF ANTENNA GROUNDING AS PER (NEC) NATIONAL ELECTRICAL CODE

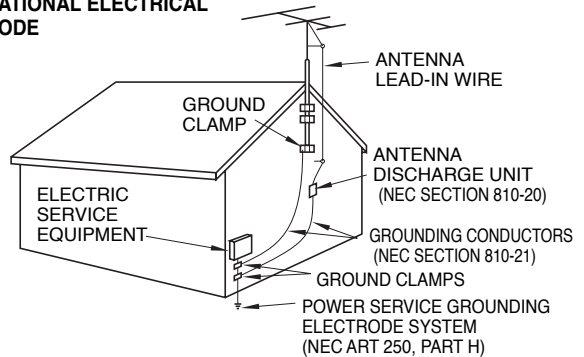

- NOTE :**
- This equipment is designed to operate in North America and other countries where the broadcasting system and AC house current is exactly the same as in North America.
 - The marking or retained image on the LCD panel resulting from fixed image use is not an operating defect and as such is not covered by Warranty. This product is not designed to display fixed image patterns for extended periods of time.

■ Important Information Regarding Use of Video Games, Computers, Captions or Other Fixed Image Displays.

The extended use of fixed image program material can cause a permanent "shadow image" on the LCD panel. This background image is viewable on normal programs in the form of a stationary fixed image. This type of irreversible LCD panel deterioration can be limited by observing the following steps:

- A. Reduce the brightness/contrast setting to a minimum viewing level.
- B. Do not display the fixed image for extended periods of time.
- C. Turn the power off when not in actual use.

■ This product utilizes tin-lead solder, and has a fluorescent lamp containing a small amount of mercury. Disposal of these materials may be regulated in your community due to environmental considerations. For disposal or recycling information please contact your local authorities, or the Electronics Industries Alliance: www.eiae.org.

Dear Panasonic Customer

Welcome to the Panasonic family of customers.

We hope that you will have many years of enjoyment from your new LCD TV.

To obtain maximum benefit from your set, please read these instructions before making any adjustments, and retain them for future reference.

Retain your purchase receipt, and record the model number and serial number of your set in the space provided on the rear cover of these instructions.

For assistance, please call : 1-800-211-PANA (7262) or send e-mail to : consumerproducts@panasonic.com or visit us at www.panasonic.com (U.S.A.)
For assistance, please call : 787-750-4300 or visit us at www.panasonic.com (Puerto Rico)
For assistance, please call : 1-800-561-5505 or visit us at www.panasonic.ca (Canada)

Federal Communication Commission Information

This equipment has been tested and found to comply with the limits for a TV Broadcast Receiver, pursuant to Part 15 of the FCC Rules. These limits are designed to provide reasonable protection against harmful interference in a residential installation. This equipment generates, uses and can radiate radio frequency energy and, if not installed and used in accordance with the instructions, may cause harmful interference to radio communications. However, there is no guarantee that interference will not occur in a particular installation. If this equipment does cause or receive interference, which can be determined by turning equipment off and on, the user is encouraged to try to correct the interference by one or more of the following measures:

- Reorient or relocate the TV antenna.
- Increase the separation between TV and other equipment.
- Connect TV into separate outlet from other equipment.
- Consult the dealer or an experienced radio / TV technician for help.

FCC Caution: Pursuant to 47CFR, Part 15.21 of the FCC rules, any changes or modifications not expressly approved by Matsushita Electric Corporation of America could result in harmful interference and would void the user's authority to operate this equipment.



The ENERGY STAR® label, a symbol for energy efficiency, was created by the U.S. Environmental Protection Agency (EPA) and the U.S. Department of Energy (DOE) to help customers identify products that can save them money and protect the environment by saving energy. ENERGY STAR® compliant products generally consume less energy than similar standard products.



HDMI, the HDMI logo and High-Definition Multimedia Interface are trademarks or registered trademarks of HDMI Licensing LLC.

Table of Contents

Important Safety Instructions	2	ASPECT Controls	25
SUPPLIED ACCESSORIES	5	Operating peripheral equipment using	
Maintenance	5	the remote control	26
Installation	6	Programming the remote control code	26
Remote control battery installation	6	Infrared Code Index	27
Connections	7	Mode Operational Key Chart	29
Antenna Connection	7		
Cable Box Connection	7		
Connecting Other Equipment	8		
HDMI Connection	9		
Connecting Headphones / Earphones	10		
Power ON / OFF	10		
Basic Controls	11		
Menu Operations	12		
Tuning Channels	14		
LOCK	15		
CLOSED CAPTION	19		
INPUT LABEL	20		
OTHER ADJUST	20		
PICTURE ADJUST	21		
POSITION/SIZE	23		
AUDIO ADJUST	24		
		Manuel de instrucciones [Resumen]	
		Ajuste el soporte con el ángulo deseado ...	30
		Instalación de las pilas del mando a distancia ...	30
		Conexión	31
		Conexión de antena	31
		Conexión del receptor de TV por cable	31
		Conexión de otro equipo	32
		Conexión de auriculares	33
		Conexión / desconexión de la alimentación ...	33
		Operaciones con menús	34
		Controles básicos	36
		Sintonización de canales	37
		Troubleshooting	38
		Specifications	39

SUPPLIED ACCESSORIES

Check the accessories before installations.

- Operating Instruction book

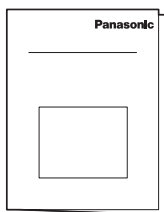

- Remote Control Transmitter (EUR7613Z90)



- Batteries for the Remote Control Transmitter (2 x AA size)



- Warranty Card



- Service Center List, Customer Card and Customer Care Plan Card (For U.S.A.)

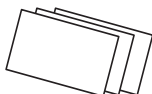

- F-Type Antenna Connector (for 4C-2V) (x 1)

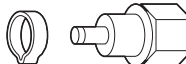

Maintenance

To clean this unit, wipe with a soft, dry cloth.

If the surfaces are extremely dirty, use a soft cloth dipped in a soap and water solution or a weak detergent solution.

- Use eyeglass cleaner to remove stubborn dirt from the LCD.
- Never use alcohol, paint thinner or benzine to clean this unit.
- Before using a chemically treated cloth, read the instructions that came with the cloth carefully.

CAUTION :

If water or other liquid enters the monitor through the display panel surface, a malfunction may occur.

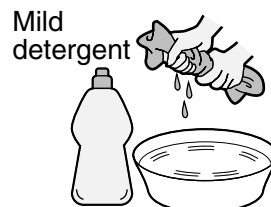

Installation

Receiver Location

Locate at a comfortable distance for viewing. Avoid placing where sunlight or other bright light (including reflections) will fall on the screen.

Use of some types of fluorescent lighting can reduce remote control transmitter range.

Adequate ventilation is essential to prevent internal component failure. Keep away from areas of excessive heat or moisture.

Optional External Equipment

The Video / Audio connection between components can be made with shielded video and audio cables. For best performance, antenna cables should utilize 75 ohm coaxial shielded wire. Cables are available from your dealer or electronic supply store.

Before you purchase any cables, be sure you know what type of output and input connectors your various components require. Also determine the length of cable you'll need.

For optimum quality picture

When the LCD is exposed to light from outdoors or lighting fixtures, high-contrast pictures may not be displayed clearly. Turn off florescent lamps near the LCD and place in a location not exposed to outdoor light.

How to hang the LCD TV on the wall

This LCD TV is for use only with the following optional accessory. Use with any other type of optional accessories may cause instability which could result in the possibility of injury.

- Wall-hanging bracket TY-WK22LR1W

Always be sure to ask a qualified technician to carry out set-up.

How to use the LCD stand

Adjust the stand to your desired angle. The stand angle can be adjusted between 5 ° forward to 10 ° back, and rotated 20 ° to the right / left.

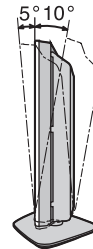
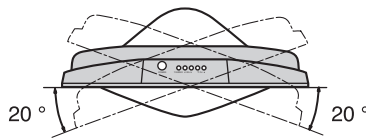
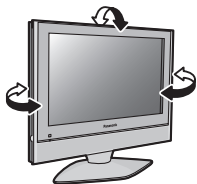

Remote control battery installation

Requires two AA batteries.

1. Open the battery cover.

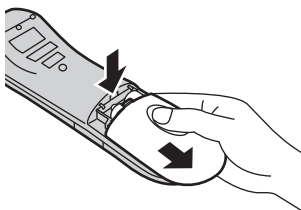

2. Install the batteries.

Note the correct polarity (+ and -).

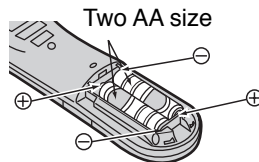

3. Replace the cover.

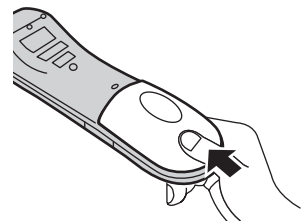

⚠ Precaution on battery use

Incorrect installation can cause battery leakage and corrosion that will damage the remote control transmitter.

1. Always use new batteries when replacing the old set.

2. Do not attempt to charge, short-circuit, disassemble, heat or burn used batteries.

3. Battery replacement is necessary when remote control acts sporadically or fails to operate this unit.

Notes:

• Do not drop, apply shock to or step on the remote control.

• Do not spill water on the remote control.

• Do not place objects between the remote control and remote control receiver.

• Do not use remote controls for other equipment at the same time.

• If the TV does not operate even when using the remote control from a close range, it is time to replace the batteries.

Connections

Note:

Cables and connectors are not supplied with this set.

Antenna Connection

For proper reception of VHF/UHF channels, an external antenna is required. For best reception, an outdoor antenna is recommended. The antenna mode must be set to TV (see page 14, Mode selection).

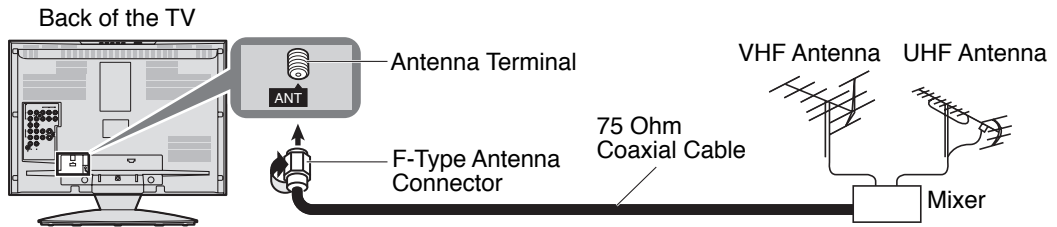

Cable Box Connection

- For reception of cable channels (01 - 125), connect the cable supplied by your local cable company. The antenna mode must be set to CABLE (see page 14, Mode selection).
- Certain cable systems offset some channels to reduce interference or view Premium (scrambled) channels. A cable converter box is required for proper reception. Check with your local cable company for its compatibility requirements.
- Set the TV channel to CH3 or CH4 when using this connection.

Cable Box

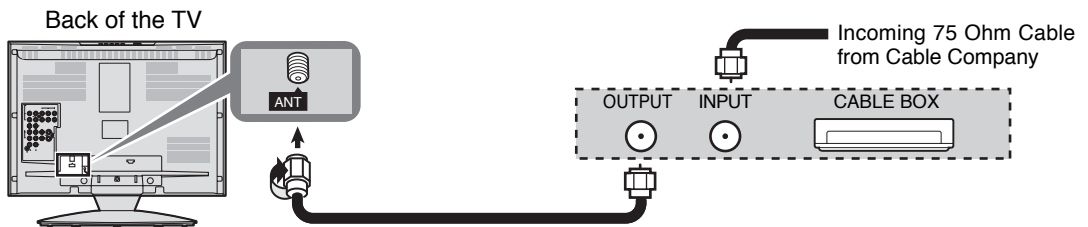

Cable Box and VCR

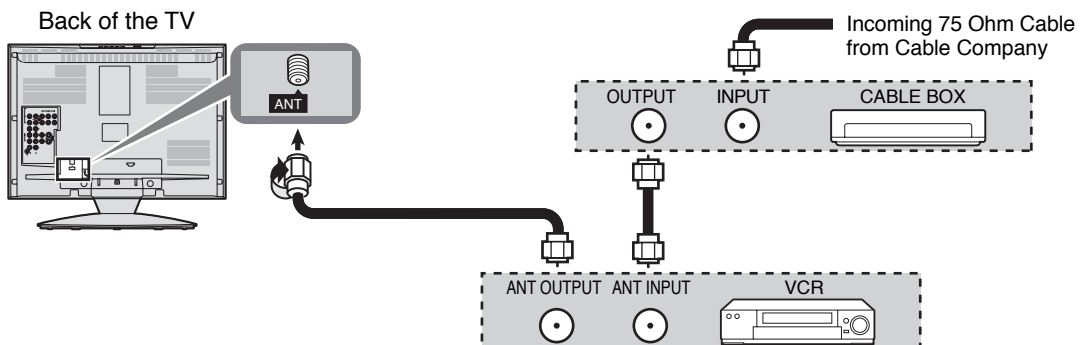

Connecting Other Equipment

Rear Input Terminals

To bundle the cables with the clumper

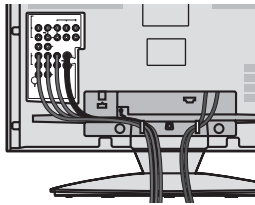

1. Pull upward.
2. Put the cables and close.

Note: Do not put the antenna cable and the power cord together to avoid noise.

Back of the TV

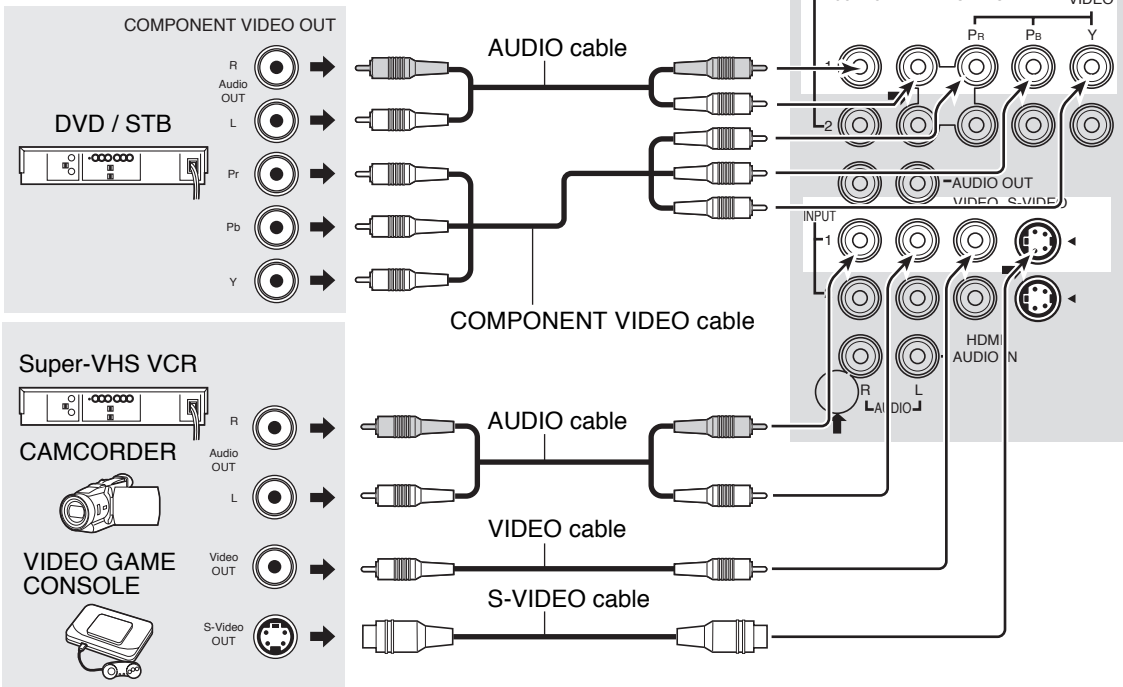
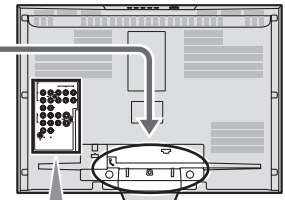

Notes:

- When connecting video cables, priority is given to the S-Video cable when both the S-VIDEO input terminal and the VIDEO input terminal are connected.
- Please make inquiries to video game manufacturers concerning component cables to connect with video game console.

Rear Output Terminals

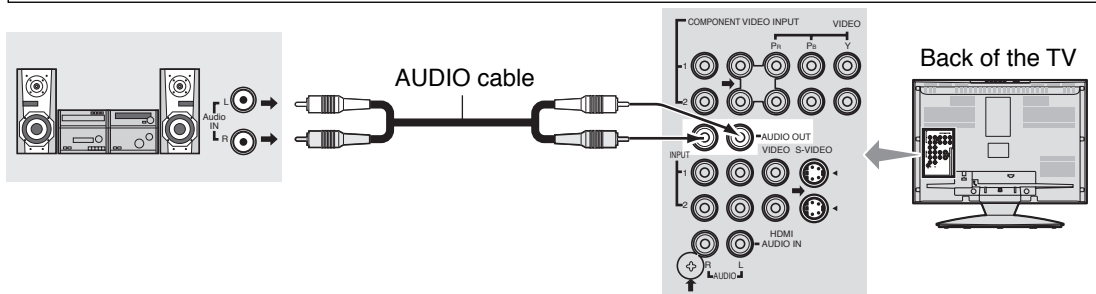

Back of the TV

HDMI Connection

HDMI*1 (High Definition Multimedia Interface) is the first all digital consumer electronics A/V interface that supports uncompressed standard. The HDMI terminal supports both video and audio information. You can connect an EIA / CEA-861 / 861B*2 compliant consumer electronic device, such as a Set Top Box or DVD player with HDMI or DVI output terminal to the HDMI*1 input terminal.

Input a High-bandwidth Digital Content Protection (HDCP) high-definition picture source to this HDMI terminal, so you can display high-definition pictures on this TV in the digital form.

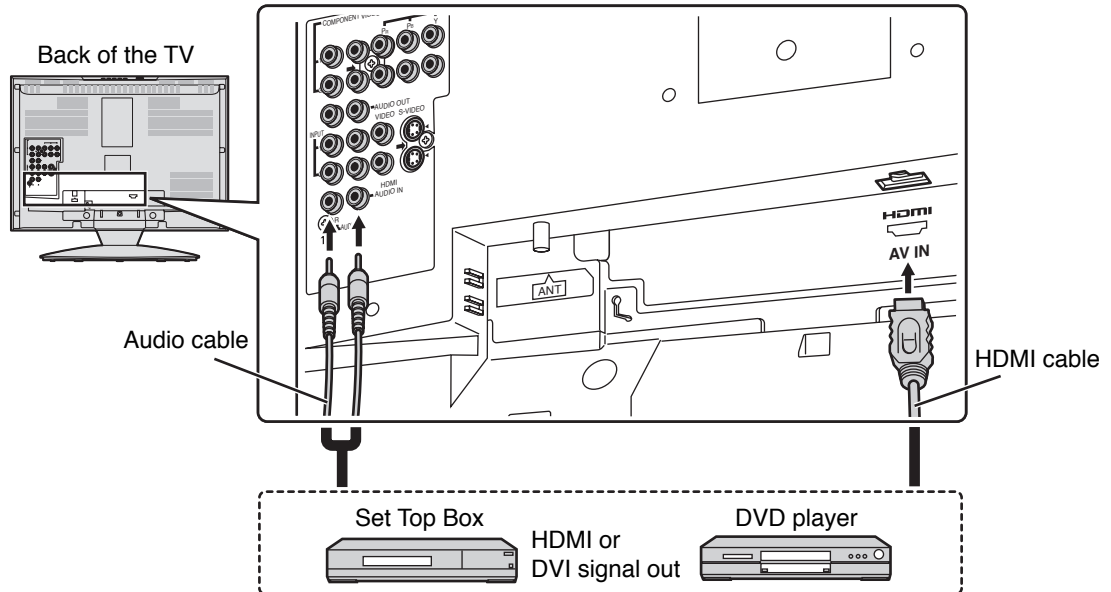

Notes:

- If the external device has DVI output only, use a DVI to HDMI adapter cable*3 to connect to the HDMI terminal.
- Connect the audio cables to the AUDIO IN terminals for HDMI.
- Select the audio setting in HDMI IN (see page 24).

Compatible VIDEO Signal

	No. of dots (H × V)	Vertical scanning frequency (Hz)
1080i	1,920 × 1,080i	59.94 / 60
720p	1,280 × 720p	59.94 / 60
480p	720 × 480p	59.94 / 60
	640 × 480p	59.94 / 60
480i	720(1,440) × 480i	59.94 / 60

This input terminal is not intended for use with computers.

Compatible sampling frequency of AUDIO signal (L.PCM) : 48 kHz / 44.1 kHz / 32 kHz

Notes:

- This HDMI connector is Type A.
- If you connect equipment without a digital output terminal, connect to the COMPONENT VIDEO, S VIDEO or VIDEO input terminal on the TV so you can enjoy an analog signal.

*1. HDMI, the HDMI logo and High-Definition Multimedia Interface are trademarks or registered trademarks of HDMI Licensing LLC.
 *2. EIA / CEA-861 / 861B profiles compliance covers profiles for transmission of uncompressed digital video including high bandwidth digital content protection.
 *3. Consult your consumer electronics dealer for availability details.
 [for USA]
 HDMI-DVI conversion cable (TY-SCHO3DH): available on Panasonic website (www.panasonic.com).

Connecting Headphones / Earphones

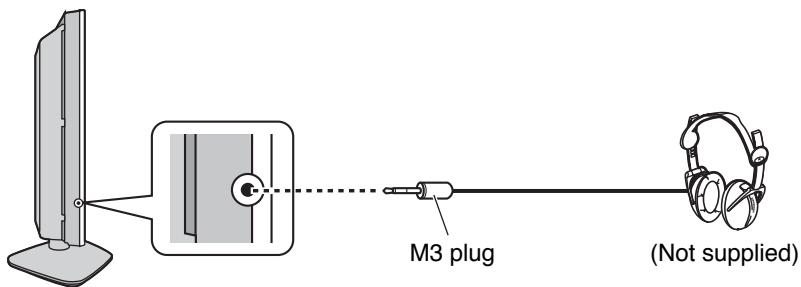

Power ON / OFF

Preparation

Connect the plug to the wall outlet.

Note:

The TV consumes some power as long as the power cord is inserted into the wall outlet.

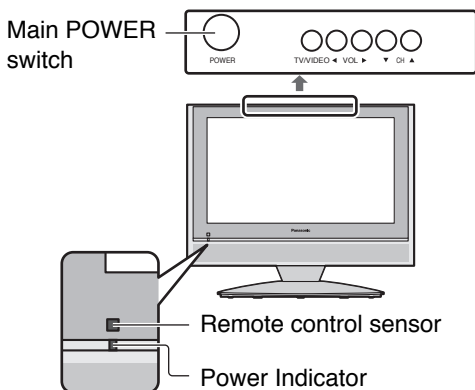
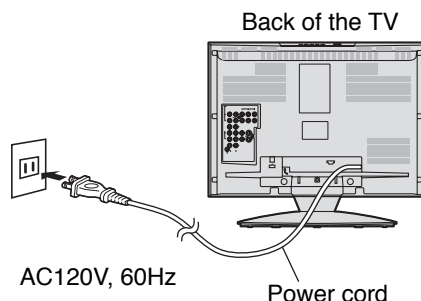

On the main unit



Press to turn the TV's main power on / off.

- Power indicator
- Main power ON: Green
- Main power OFF: No light

On the remote control



Press to turn the TV on / off.

- Power indicator
- Power ON : Green
- Power OFF (Standby): Red
- This does not work when the main power is off (No light) (see above).

Note:

The screen below is displayed for a few moments when the TV is turned on.

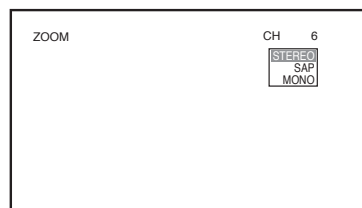

Note:

Select the menu language before operating the TV (see pages 12, 13, LANGUAGE).

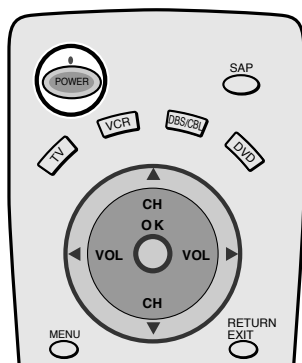

Basic Controls

< Top Side Controls >

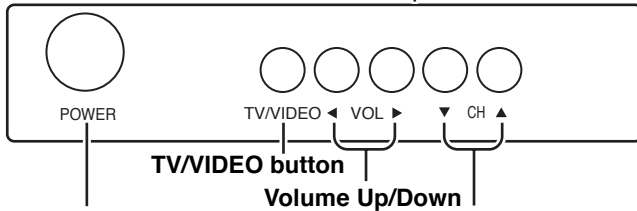

Main POWER switch **Volume Up/Down** **Channel Up/Down**

Press to turn the TV's main power on/off. (see page 10)

Power button

Press to turn the TV ON or OFF.

Note:

The TV's power cord must first be plugged into the wall outlet and then turned on at the POWER switch.

Mode Selection buttons

Digital Broadcasting Satellite for Remote Control / Cable TV Mode Selection for Remote Control

VCR Mode Selection for Remote Control

Digital Video Disc Mode Selection for Remote Control

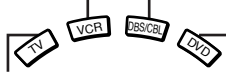

TV Mode Selection for Remote Control

Direct program number selection buttons

R-TUNE



R-TUNE button

Switches to previously viewed channel or video mode.

SLEEP PROG



PROG dash button / SLEEP TIMER button
Program dash channel numbers for DTV and DBS.

Sleep timer (MINUTES)
→ 0 → 30 → 60 → 90

ASPECT TV/VCR



ASPECT button

Change of screen size (See page 25).

→ JUST → ZOOM → FULL → NORMAL

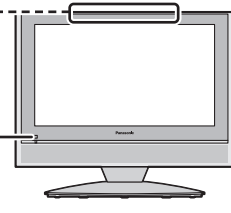

Remote control sensor

Within about 23 feet (7 meters) in front of the TV set.

SAP button

Selects Audio mode (See page 24).

→ STEREO → SAP → MONO

Changes to the next channel up

Moves cursor upward during menu mode.

Reduces volume
Moves cursor to the left during menu mode.

Increases volume
Moves cursor to the right during menu mode.

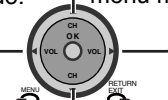

Displays menu

Press to access TV, DTV, DBS or DVD menus.

Press to Return
to previous MENU or EXIT from menu.

Changes to the next channel down
Moves cursor downward during menu mode.

The input mode changes each time this button is pressed.

Press this button to mute the sound, press again to cancel the mute.

TV/VIDEO RECALL MUTE GUIDE GUIDE button for DBS.

Press to display the current system status, for example, Aspect mode, Channel number, Stereo mode, TV/VIDEO and Off timer.

Operation of other Device

Buttons	REW / FF	PLAY	PAUSE	STOP
Device				
VCR	VCR REW/FF	PLAY	Pause	STOP
CABLE/DBS	—	—	—	—
DVD	Skip Search REW/FF	PLAY	Pause	STOP

Buttons	REC	ASPECT TV/VCR	VCR/DBS CH
Device			
VCR	VCR RECORD	TV/VCR Switch	VCR CH up/down
CABLE/DBS	—	STB—ASPECT	PAGE up/down
DVD	—	Open / Close	Slow +/-

Menu Operations

1

Press to display MENU screen.

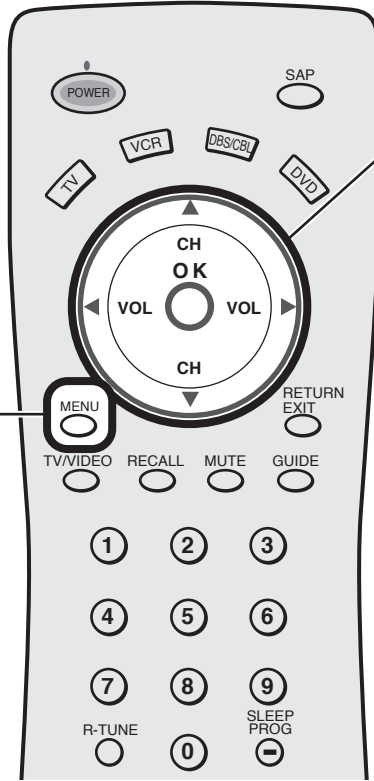
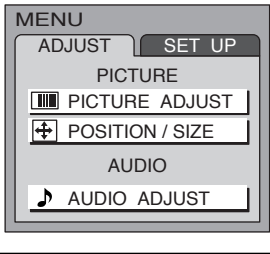

2

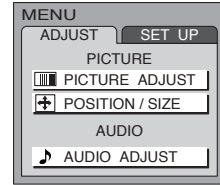

or

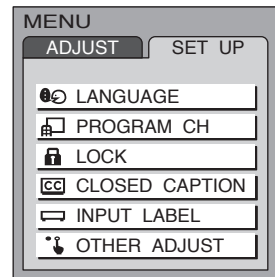
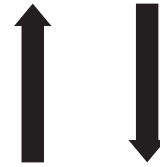
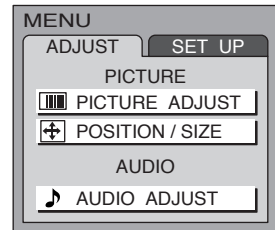
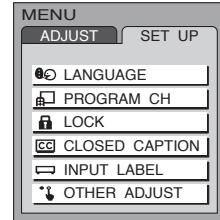

ON SCREEN HELP 'Instruction' box

An On Screen Help box is displayed when a menu is displayed on the TV. This Help box indicates which keys on the remote control are used to navigate the menu shown.

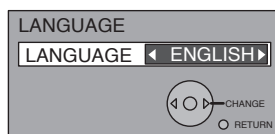

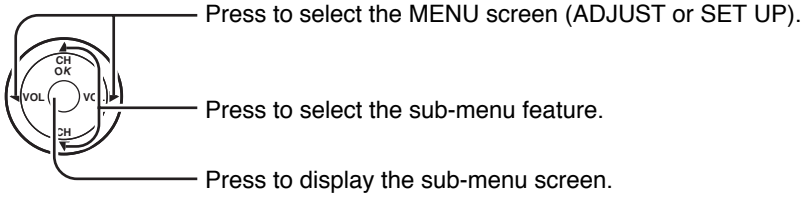

- To return to the previous screen : RETURN EXIT
- To exit the MENU screen: MENU This returns TV to normal viewing.

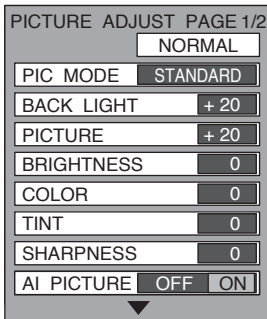

(See page 21)

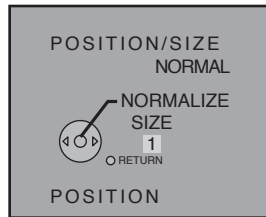

(See page 23)

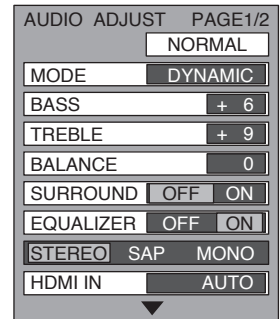

(See page 24)



Select the menu language.

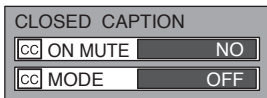
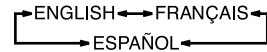

(See page 19)

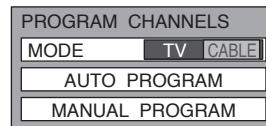

(See page 14)

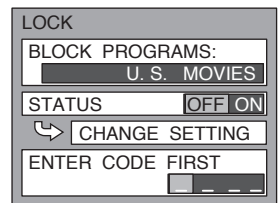

(See pages 15-18)

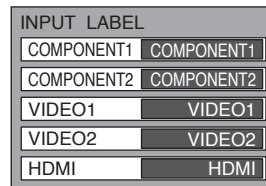

(See page 20)

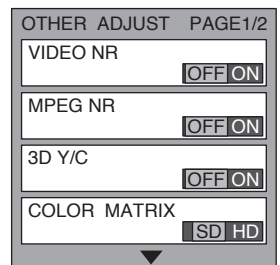

(See page 20)

Tuning Channels

1 Press the TV/VIDEO button to display the TV channel.

2 Press the MENU button to display the MENU screen and select SET UP.

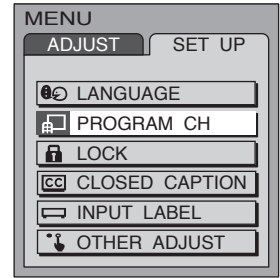
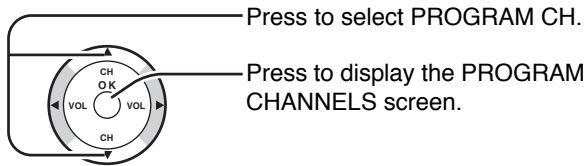

Mode selection

3 Press to select MODE.

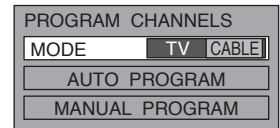
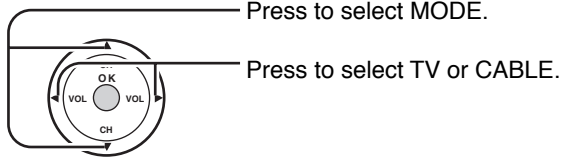

Automatic channel programming

Automatically scans and stores all the TV channels.

4 Press to select AUTO PROGRAM.
Press to display the AUTO PROGRAM screen.

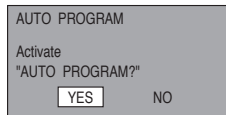
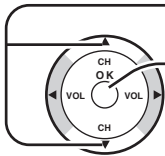

5 Press to select YES.

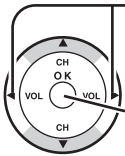

Press to start AUTO PROGRAM.

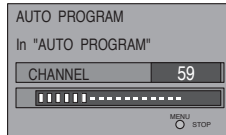

Channels will automatically advance until all channels have been scanned. Channel numbers with video signal received will be stored in the Channel Memory.

Notes:

- When any button is pressed during AUTO PROGRAM, the TV will return to normal viewing. (Channels searched up to the point are added.)
- After AUTO PROGRAM finishes, the lowest channel number added will be displayed.
- When there are no receivable channels, channel 69 (for TV) or channel 125 (for cable TV) is displayed.

Manual channel programming

Add or delete a channel manually.

4 Press to select MANUAL PROGRAM.
Press to display the MANUAL PROGRAM screen.

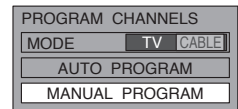
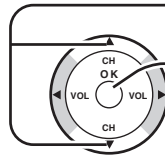

5 Press to select the channel.

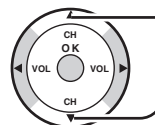

- You can also use the numbered buttons.



6 Press to add the channel to the Channel Memory (the channel number turns blue).

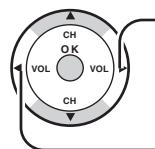

Press to delete the channel from the Channel Memory (the channel number turns yellow).

- Repeat steps 5 and 6 for other channels.

LOCK

V-Chip technology allows parents to use the TV rating codes to block programs that they feel are inappropriate for their children to watch.

- 1 Press the MENU button to display the MENU screen and select SET UP.

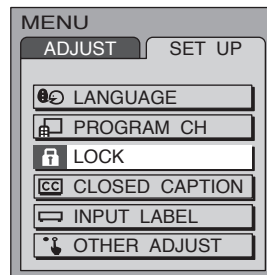
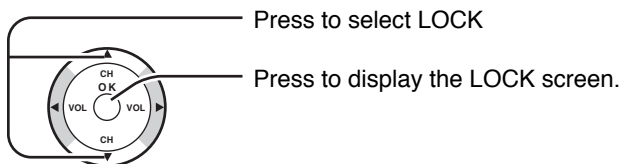

2

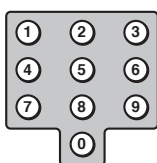

Input 4-digit code.

- To clear the numbers while entering the code, press Up or Down .
- You will need the code to enter the LOCK menu.
- After entering your password for the first time, ENTER CODE FIRST will change to CHANGE CODE.

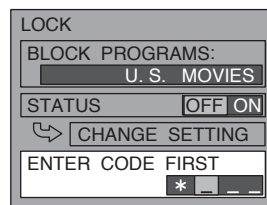

Note:

Use a code that is easy to remember and record it in a safe place.

3

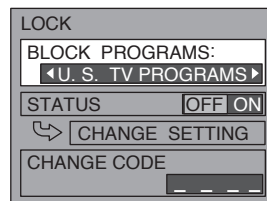
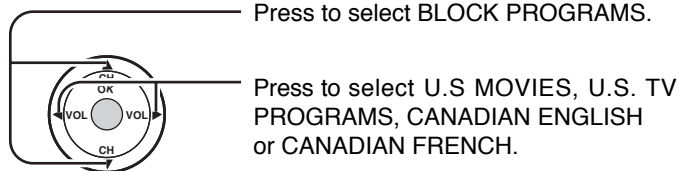

4

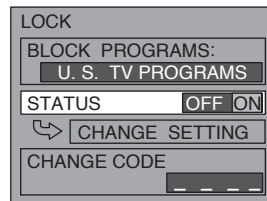
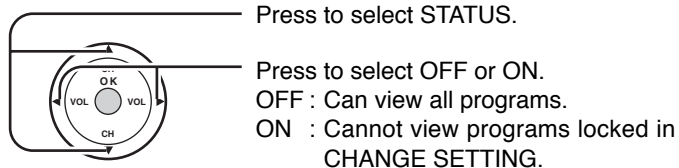

5

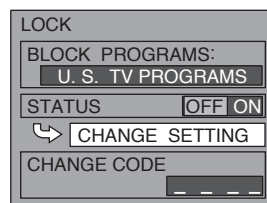
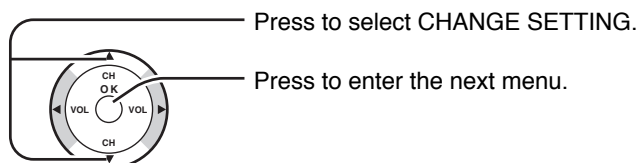

U.S. TV PROGRAMS

This TV features the “V-Chip technology” which allows you to use U.S. TV PROGRAMS Guide ratings to block various types of TV programs.

6

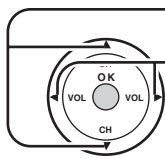

Press to select VIEW NR PROGRAMS?

Press to select NO or YES.

NO : Cannot view programs with NR signals.

YES : Can view programs with NR signals.

7

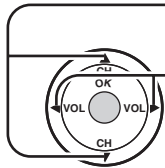

Press to select SETTING.

Press to select BASIC or DETAILED.

BASIC : You can select the titles.

DETAILED : You can select the titles and options.

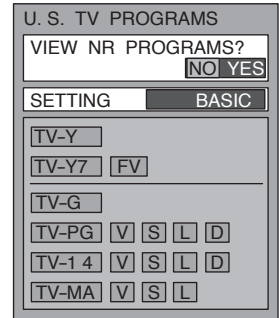

Title Option

8

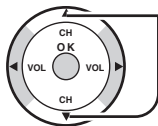

Press to select the rating.

- When a title field is selected, all ratings below this rating are selected.

- When options within an option field are selected, ratings below this rating within the same field are selected.

9

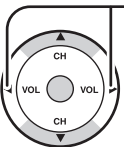

Press to lock or unlock the rating.

Lock : Red

Unlock : Green

NR	Not Rated. See Customer Caution on page 18.
TV-Y	All children. The themes and elements in this program are specifically designed for a very young audience, including children from ages 2-6.
TV-Y7	Directed to older children. Themes and elements in this program may include mild physical or comedic violence, or may frighten children under the age of 7.
TV-G	General audience. It contains little or no violence, no strong language, and little or no sexual dialogue or situations.
TV-PG	Parental guidance suggested. The program may contain infrequent coarse language, limited violence, some suggestive sexual dialogue and situations.
TV-14	Parents strongly cautioned. This program may contain sophisticated themes, sexual content, strong language and more intense violence.
TV-MA	Mature audiences only. This program may contain mature themes, profane language, graphic violence, and explicit sexual content.
FV	FANTASY/CARTOON VIOLENCE
V	VIOLENCE
S	SEX
L	OFFENSIVE LANGUAGE
D	DIALOGUE WITH SEXUAL CONTENT

U.S. MOVIES

This TV features the “V-Chip technology” which allows you to use Motion Picture Ratings when viewing movies or video tapes. This innovation allows parents to block various types of movies and video tapes at their discretion.

6

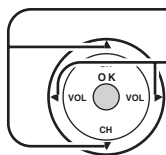

Press to select VIEW NR PROGRAMS?.

Press to select NO or YES.

NO : Cannot view programs with NR signals.

YES : Can view programs with NR signals.

7

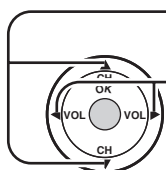

Press to select the rating.

Press to lock or unlock the rating.

Lock : Red

Unlock: Green

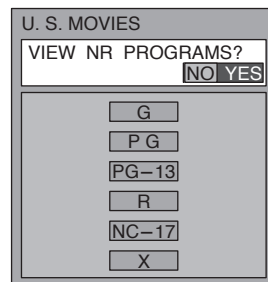

NR	CONTAINS NO RATING (NOT RATED) AND NA (NOT APPLICABLE) PROGRAMS. Movie has not been rated or rating does not apply.
G	GENERAL AUDIENCES. All ages admitted.
PG	PARENTAL GUIDANCE SUGGESTED. Some material may not be suitable for children.
PG-13	PARENTS STRONGLY CAUTIONED. Some material may be inappropriate for children under 13.
R	RESTRICTED. Under 17 requires accompanying parent or adult guardian.
NC-17	NO ONE 17 AND UNDER ADMITTED.
X	ADULTS ONLY.

CANADIAN ENGLISH / CANADIAN FRENCH

The V-CHIP used in this TV allows you to block various types of movies and television programs based on the two rating systems used in Canada. It also lets you block or unblock Canadian French programs according to various ratings categories.

6

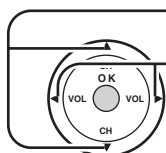

Press to select VIEW E PROGRAMS?.

Press to select NO or YES.

NO : Cannot view programs with E signals.

YES : Can view programs with E signals.

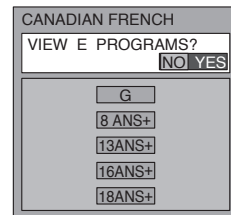
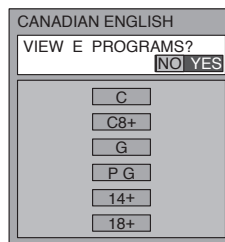

7

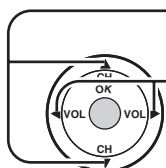

Press to select the rating.

Press to lock or unlock the rating.

Lock : Red

Unlock: Green

CANADIAN ENGLISH RATINGS CHART

E	Exempt - Exempt programming includes: news, sports, documentaries and other information programming, talk shows, music videos, and variety programming.
C	Programming intended for children under age 8. No offensive language, nudity or sexual content.
C8+	Programming generally considered acceptable for children 8 years and over. No profanity, nudity or sexual content.
G	General programming, suitable for all audiences.
PG	Parental Guidance suggested. Some material may not be suitable for children.
14+	Programming contains themes or content which may not be suitable for viewers under the age of 14. Parents are strongly cautioned to exercise discretion in permitting viewing by pre-teens and early teens.
18+	18+ years old. Programming restricted to adults. Contains constant violence or scenes of extreme violence.

CANADIAN FRENCH RATINGS CHART

E	Exempt - Exempt programming.
G	General - Programming intended for audience of all ages. Contains no violence, or the violence content is minimal or is depicted appropriately.
8 ANS+	8+ General - Not recommended for young children. Programming intended for a broad audience but contains light or occasional violence. Adult supervision recommended.
13ANS+	Programming may not be suitable for children under the age of 13 - Contains either a few violent scenes or one or more sufficiently violent scenes to affect them. Adult supervision strongly suggested.
16ANS+	Programming may not be suitable for children under the age of 16 - Contains frequent scenes of violence or intense violence.
18ANS+	Programming restricted to adults. Contains constant violence or scenes of extreme violence.

Customer Caution

The V-Chip system that is used in this set is capable of blocking "NR" programs (non rated, not applicable and none) per FCC Rules Section 15.120(e)(2). If the option of blocking "NR" programs is chosen "unexpected and possibly confusing results may occur, and you may not receive emergency bulletins or any of the following types of programming:"

- Emergency Bulletins (Such as EAS messages, weather warnings and others)
- Locally originated programming • News • Political • Public Service Announcements • Religious • Sports
- Weather

CLOSED CAPTION

This unit has a built in decoder that provides a visual depiction of the audio portion of a television program in the form of written words across the screen (white or colored letters on a black background). It allows you to read the dialogue of a television program or other information.

Notes:

- This feature is available only with the 480i input signal and with the programs including the closed caption.
- The closed caption is not displayed when using HDMI connection (see page 9) or when you set the aspect to "ZOOM" (see page 25).

- 1** Press the MENU button to display the MENU screen and select SET UP.

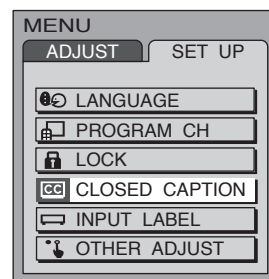
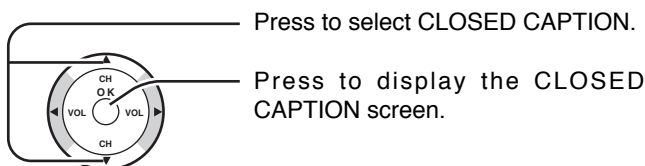

CC ON MUTE

Displays the On-Screen Closed Caption when the MUTE button is pressed. To delete the closed caption, press the MUTE button again.

2 - 1

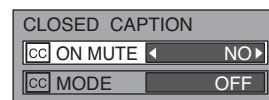
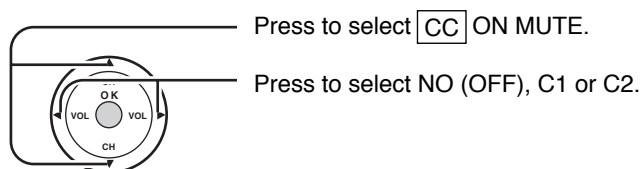

Notes:

- To activate this feature, set **CC MODE** to OFF .
- The program must have Closed Caption.

CC MODE

Displays the On-Screen Closed Caption.

2 - 2

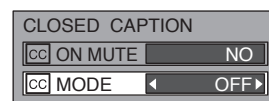
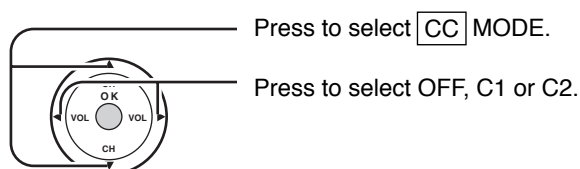

- **OFF (NO)**: Recommended mode when Closed Caption is not being used.
- **C1**: For video related information that can be displayed (up to 4 lines of script strategically placed on the television screen so that it does not obstruct relevant parts of the picture).
- **C2**: Another mode used for video related information.

INPUT LABEL

You can change the video input labels displayed on the screen to match the connected device (VCR, DVD player etc.).

1 Press the MENU button to display the MENU screen and select SET UP.

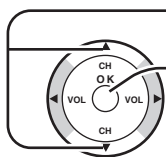

Press to select INPUT LABEL.

Press to display the INPUT LABEL screen.

2

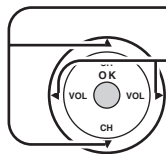

Press to select the video input.

Press to select the INPUT LABEL.
(COMPONENT1 / COMPONENT2 / VIDEO1 / VIDEO2 / HDMI, VCR, LD, GAME, DVD, DTV, [BLANK] and SKIP*)
* Select to skip unused video input when pressing TV/VIDEO button.

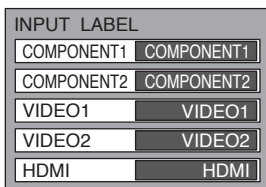
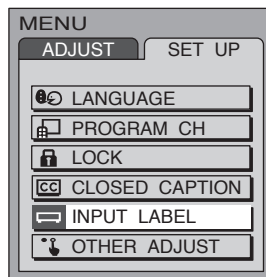

OTHER ADJUST

1 Press the MENU button to display the MENU screen and select SET UP.

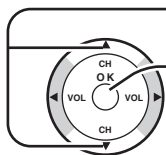

Press to select OTHER ADJUST.

Press to display the OTHER ADJUST screen.

2

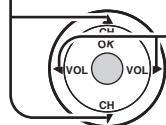

Press to select the item.

Press to select the setting.

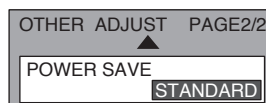
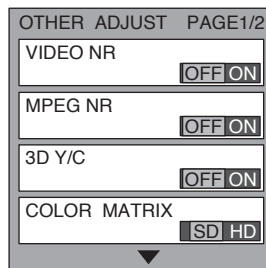
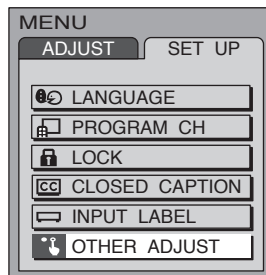

VIDEO NR

Reduce video noise in the picture.

OFF ↔ ON

MPEG NR

Noise unique to DVD, STB etc will be reduced.

OFF ↔ ON

3D Y/C

Minimizes noise and cross color in the picture. Not available for COMPONENT VIDEO INPUT and HDMI input.

OFF ↔ ON

COLOR MATRIX

Displays input signals (480p signals) in a natural color. Automatically adjusts color parameters for HD (high definition) and SD (standard definition).

SD ↔ HD

POWER SAVE

Reduces screen brightness to lower power consumption. Eye-friendly for viewing in a dark room.

STANDARD ↔ SAVING

PICTURE ADJUST

1 Press the MENU button to display the MENU screen and select ADJUST.

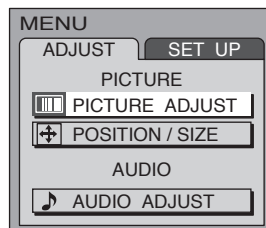
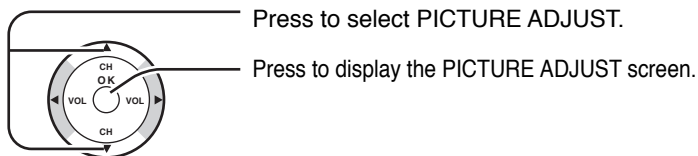

2

Press to select the sub-menu.

Adjust the setting watching the picture behind the menu.

Press to activate the setting if necessary.

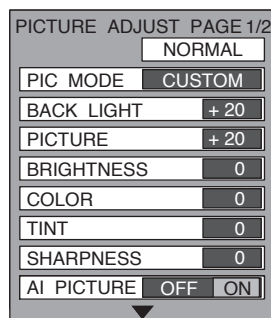
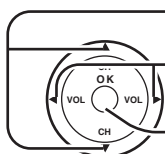

3 **ADVANCED ADJUST**

Press to select ADVANCED ADJUST.

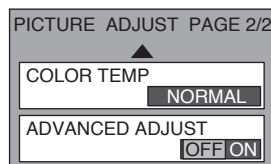
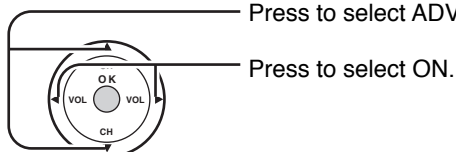

4

Press to display the sub-menu.

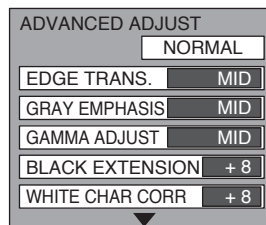
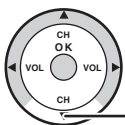

NORMAL / NORMALIZE

Select "NORMALIZE" and press "OK" to return each PIC MODE to the factory default setting.

Notes:

- "NORMAL" means the PIC MODE is in the factory default setting. "NORMAL" changes to "NORMALIZE" when you change the setting of BACK LIGHT, PICTURE, BRIGHTNESS, COLOR, TINT, SHARPNESS, AI PICTURE, COLOR TEMP or ADVANCED ADJUST.
- You can normalize each PIC MODE separately.

PICTURE MODE

MODE	Function
STANDARD	Displays a standard image.
CINEMA	Ideal for watching movies in a dark room.
VIVID	Displays a clear image with high contrast.
CUSTOM	You can customize the picture settings to suit your preference (see page 22, ADVANCED ADJUST).

PICTURE MODE is stored for TV, VIDEO1, VIDEO2, COMPONENT1, COMPONENT2 and HDMI individually. The CUSTOM setting is stored for TV, VIDEO1, VIDEO2, COMPONENT1, COMPONENT2 and HDMI individually.

PICTURE ADJUST

BACK LIGHT, PICTURE, BRIGHTNESS, COLOR, TINT, SHARPNESS, AI PICTURE, COLOR TEMP

You can change the level of each Item (BACK LIGHT, PICTURE, BRIGHTNESS, COLOR, TINT, SHARPNESS, AI PICTURE and COLOR TEMP) for each MENU (STANDARD, CINEMA, VIVID and CUSTOM) according to your personal preference.

Sub-menu	Function
BACK LIGHT	Luminance of the back light is adjusted.
PICTURE	Selects proper brightness and density for the room.
BRIGHTNESS	Adjusts for easier viewing of dark pictures such as night scenes.
COLOR	Adjusts the level of color.
TINT	Adjusts for flesh tone color.
SHARPNESS	Adjusts the degree of sharpness.
AI PICTURE	Controls dark areas without affecting the black level or brightness in the overall picture.
COLOR TEMP (Color temperature)	Increases or decreases WARM (red) and COOL (blue) colors to suit personal preference.

ADVANCED ADJUST

(Only when you selected CUSTOM in PIC MODE)

Item	Function
EDGE TRANS.	Improves edges in the background to reduce overshooting and improve the sense of depth.
GRAY EMPHASIS	Emphasizes the sharpness in density of many color differences.
GAMMA ADJUST	Increases the brightness of the center ranges to improve detail and contrast in dark scenes.
BLACK EXTENTION	Contrast level will be improved.
WHITE CHAR CORR	It makes white characters brighter.

POSITION/SIZE

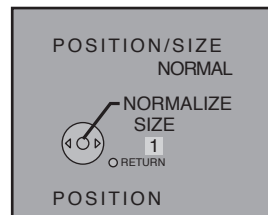
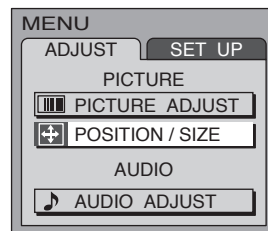
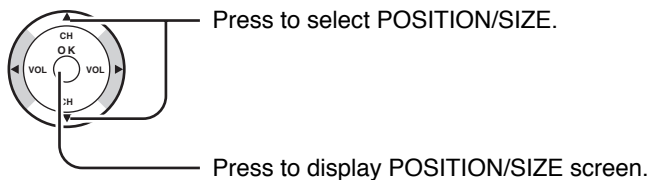

For “ZOOM” mode (see page 25)

• POSITION

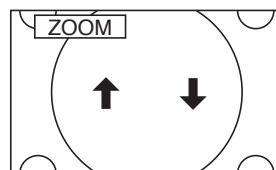
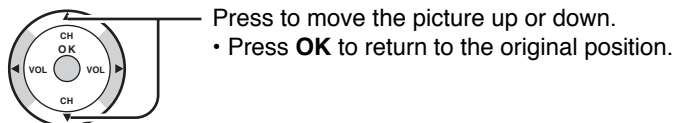

• SIZE

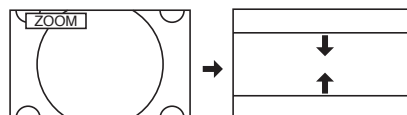
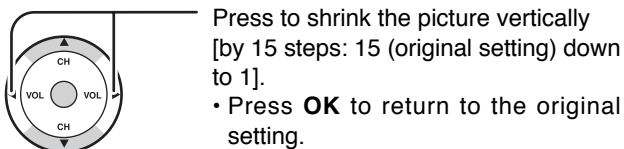

For “NORMAL” and “JUST” mode (see page 25)

• SIZE

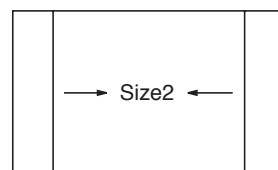
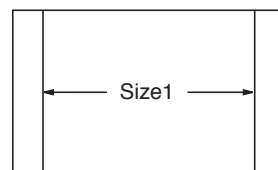
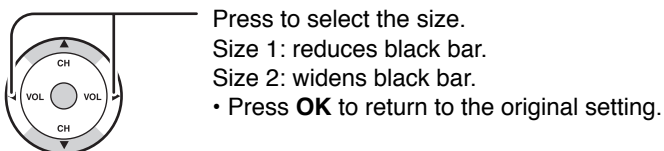

AUDIO ADJUST

- 1** Press the MENU button to display the MENU screen and select ADJUST.

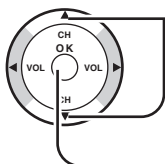

Press to select AUDIO ADJUST.

Press to display the AUDIO ADJUST screen.

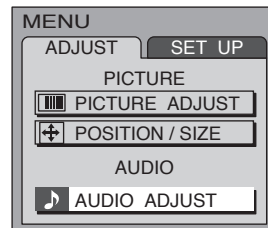

- 2** Press to select the sub-menu.

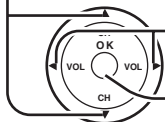

Select the setting while listening to the sound.

Press to activate the setting if necessary.

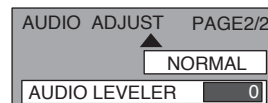
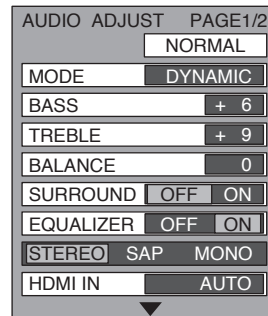

NORMAL / NORMALIZE

Select "NORMALIZE" and press "OK" to return each MODE to the factory default setting.

Notes:

- "NORMAL" means the MODE is in the factory default setting. "NORMAL" changes to "NORMALIZE" when you change the setting of BASS, TREBLE, BALANCE, SURROUND, EQUALIZER or AUDIO LEVELER.
- You can normalize each MODE separately.

MODE

AUTO	Automatically adjusts for a wide Dynamic Range.
STANDARD	Emits the original sound.
DYNAMIC	Gives contrast to sound.

BASS, TREBLE, BALANCE, SURROUND, EQUALIZER

You can change the level of each sub-menu (BASS, TREBLE, BALANCE, SURROUND, EQUALIZER) for each MODE (AUTO, STANDARD and DYNAMIC) according to your personal preference.

BASS	Adjusts low frequencies.
TREBLE	Adjusts high frequencies.
BALANCE	Adjusts left and right volume.
SURROUND	To enjoy a concert hall effect, select ON when stereo is playing.
EQUALIZER	Makes voice sound clear. Normally set to ON.

STEREO / SAP / MONO

- Red display : With signal
- White display : No signal
- White display (All modes) : MONO
- To change the mode using SAP button (see page 11).

STEREO	Two channel Audio reception.
SAP	Second Audio Programming (typically used for bilingual audio).
MONO	Select when stereo signal is weak.

HDMI IN

When using HDMI connection (see page 9), this feature will let you switch between Analog Input and Digital Input.

AUTO	Automatically selects Analog / Digital signal.
DIGITAL	Digital Input only.
ANALOG	Analog Input only.

AUDIO LEVELER

You can adjust the volume level for each of the input mode (TV, VIDEO1, VIDEO2, COMPONENT1, COMPONENT2 and HDMI).

ASPECT Controls

This feature allows you to enjoy viewing the picture at its maximum size, including wide screen cinema format picture.

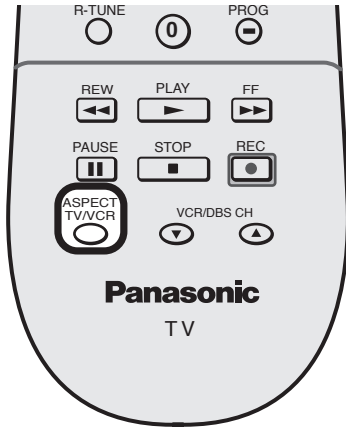

Each time you press the button:

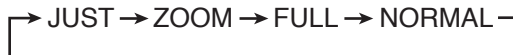

Notes:

- This feature does not work for 1080i and 720p input signals.
- The aspect setting is stored separately for TV, VIDEO1, VIDEO2, COMPONENT1, COMPONENT2 and HDMI.

Mode	Picture	Explanation
NORMAL		NORMAL mode will display a 4:3 picture at its standard 4:3 size without any stretching.
JUST		JUST mode will display a 4:3 picture at its maximum size but with aspect correction applied to the sides of the screen so that elongation is only apparent at the left and right edges of the screen. The size of the picture will depend on the original signal.
ZOOM		ZOOM mode magnifies the central section of the picture.
FULL		FULL will display the picture at its maximum size but with slight elongation.

Operating peripheral equipment using the remote control

Programming the remote control code

You can operate other manufacturers' components using this TV's remote control.

Preparations:

- Connect the plug of the external component to the wall outlet.
- Make sure the component is turned off.

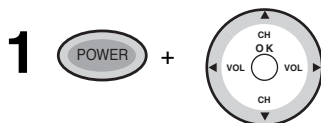
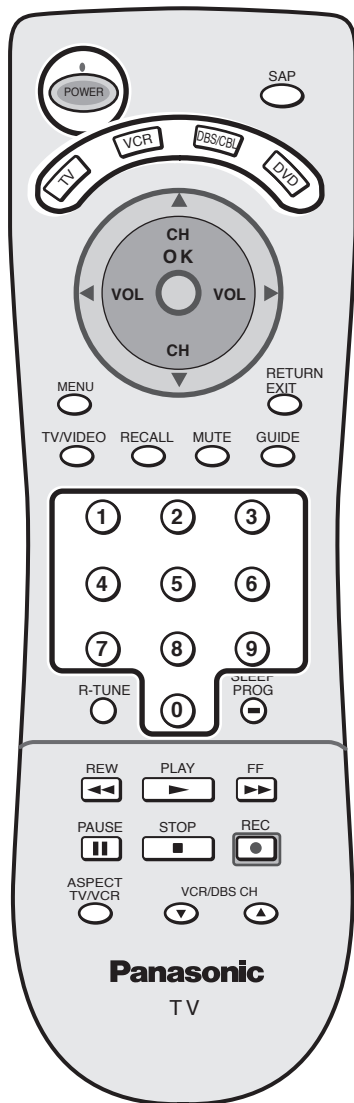

1 Press and hold **POWER** and **OK** together, for at least **5 seconds**.

- The mode selection buttons flashes, and then release the **POWER** and **OK**.



2 Select the type of the component.

- The selected button light and all others go out.

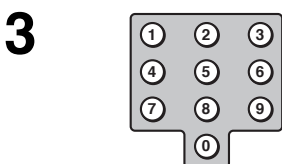

3 Enter the 3-digit infrared code (see pages 27, 28).

- Factory default setting : **Panasonic**
- Press **POWER** to test the operation.

Notes:

- If the component does not operate with the remote control, repeat the procedure using another code. (Some brands have multiple codes).
- If an incorrect code is entered, or if the procedure takes longer than 30 seconds, the programming will fail.

To find the code not listed in the index

After step 2 above,

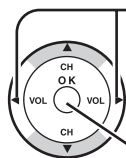

Press to select the code.

- The code starts from the current device.
 - Press **POWER** button to test the operation.
 - Repeat the steps until the component code is found. It may take many attempts before the correct code is found.
- Press to store the code.

Operating peripheral equipment using the remote control

Infrared Code Index

The Universal Remote Control is capable of operating many component brands after entering a code. Some components may not operate because the codes are not available due to limited memory. The Universal Remote Control does not control all features found in each model.

Write the code numbers from tables in this space. This will serve as a reference if you need to program your Remote Control.

VCR	DVD	CABLE	DBS
<input type="text"/> <input type="text"/> <input type="text"/>	<input type="text"/> <input type="text"/> <input type="text"/>	<input type="text"/> <input type="text"/> <input type="text"/>	<input type="text"/> <input type="text"/> <input type="text"/>

VCR

Codes for VCR

Brand	Code
Admiral	335
Aiwa	332
Akai	314, 315, 316, 329
Audio Dynamic	311, 339
Bell & Howell	305, 313
Broksonic	320, 326
Canon	323, 325
Citizen	306
Craig	305, 306, 329
Curtis Mathes	324, 345
Daewoo	301, 324, 343
DBX	310, 311, 339
Dimensia	345
Emerson	303, 319, 320, 325, 326, 343
Fisher	305, 307, 308, 309, 313
Funai	320, 326, 334
GE	324, 333, 345
Goldstar	306
Gradiente	334
Hitachi	300, 323, 345
Instant Replay	323, 324
Jensen	339
JVC	310, 311, 334, 339
Kenwood	306, 310, 311, 339
LXI	300, 305, 306, 307, 308, 309
Magnavox	323, 324, 331
Marantz	310, 311, 339
Marta	306
Memorex	309, 324
MGA	338, 340, 341, 347, 348
Minolta	300, 345
Mitsubishi	338, 340, 341, 347, 348
Multitech	304, 347
NEC	310, 311, 334, 339
Olympic	323, 324
Optimus	306, 321, 328, 335

Brand	Code
Orion	320, 326
Panasonic	321, 322, 323, 324
J.C.Penney	300, 305, 310, 311, 324, 339, 345
Pentax	300, 311, 345
Philco	320, 323, 324, 326, 331, 343
Philips	323, 324, 331
Pioneer	323
Proscan	300, 301, 302, 323, 324, 331, 333, 345, 346
Quasar	321, 322, 323, 324
Radio Shack	305, 309, 324, 333, 336, 340
RCA	300, 301, 302, 323, 324, 331, 333, 345, 346
Realistic	305, 309, 324, 336, 340
Samsung	302, 304, 333
Sansui	320, 326, 339, 352
Sanyo	305, 309, 313
Scott	301, 302, 304, 309, 320, 326, 338, 340, 347, 348
Sears	300, 305, 306, 307, 308
Sharp	335, 336
Shintom	317
Signature 2000	335
Singer	317
Sony	328, 329, 330
Sylvania	323, 324, 331
Tashiro	306
Tatung	310, 311, 339
Teac	310, 311, 339
Technics	321, 322, 323, 324
Teknika	324
Toshiba	301, 346
Vector Research	311
Wards	306, 309, 335, 336, 344
Yamaha	305, 310, 311, 339
Zenith	306, 344

VCR

Codes for Personal Video Recorders

Brand	Code
Panasonic Replay	100
Philips Tivo	101
Sony Tivo	102

Operating peripheral equipment using the remote control



Codes for DVD

Brand	Code
Denon	100
Ferguson	101
JVC	109
Mitsubishi	105
Nordmende	101
Panasonic	100
Philips	103
Pioneer	102
RCA	101

Brand	Code
Saba	101
Samsung	110
Sharp	108
Sony	104
Technics	100
Thomson	101
Toshiba	103
Yamaha	100
Zenith	107



Codes for Cable Box

Brand	Code
ABC	124
Archer	125, 132
Cableview	105, 132
Citizen	105, 122
Curtis	112, 113
Diamond	124, 125, 132
Eagle	129
Eastern	134
GC Brand	105, 132
Gemini	122
General Instrument/ Jerrold	111, 119, 120, 121, 122, 123, 124, 125, 126, 127
Hamlin	112, 118, 140, 141, 142, 145
Hitachi	103, 124
Macom	103, 104, 105
Magnavox	133
Memorex	130
Movietime	105, 132
Oak	102, 137, 139
Panasonic	109, 110, 114
Philips	106, 107, 128, 129, 130
Pioneer	101, 116
Pulsar	105, 132

Brand	Code
Puser	132
RCA	115
Realistic	132
Regal	112, 118, 140, 141, 142, 145
Regency	134
Rembrandt	105, 132, 137
Samsung	105
Scientific Atlanta	111, 112, 113
Slmark	101, 105
Sprucer	105, 110
Stargate	105, 132
Tel eview	101, 105
Texscan	144
Tocom	135
Toshiba	104
Unika	125, 132
Universal	122, 132
Videoway	106
Viewstar	129, 130
Zenith	100, 117
Zenith /Drae Satellite	100



Codes for DBS















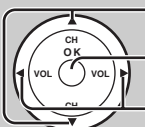



Brand	Code
Dish Network	105, 115, 116
Echo Star (Echostar)	105
Express VU	105, 115
G.E.	106
G.I. (General Instrument)	108
Gradiente	114
Hitachi	103, 111, 112
HNS (Hughes)	103

Brand	Code
Magnavox	101, 102
Panasonic	104
Philips	101, 102
Primestar	108
Proscan	106, 109, 110, 113
RCA	106, 109, 110, 113
Sony	107
Star Choice	103, 108
Toshiba	100
Uniden	101, 102

Operating peripheral equipment using the remote control

Mode Operational Key Chart

This chart defines which keys are operational after programming (if needed), while in the selected remote control mode DTV, CABLE, DBS, VCR, DVD ...etc.

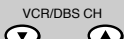
KEY NAME	TV MODE	CABLE MODE	DBS MODE	VCR MODE	DVD MODE (DVD)
	POWER	POWER	POWER	POWER	POWER
	SAP ON/OFF	–	STB AUDIO TRACK	–	–
	MUTE	TV MUTE	STB MUTE	TV MUTE	TV MUTE
	TV INPUT SW	TV INPUT SW	TV INPUT SW	TV INPUT SW	TV INPUT SW
	CHANNEL UP/DOWN	CABLE CHANNEL UP/DOWN	STB NAVIGATION UP/DOWN	TV CHANNEL UP/DOWN	NEXT/PREVIOUS CHAPTER
	ACTION	ENTER	STB ACTION	TV ACTION	–
	VOL + / –	CABLE VOL +/-	STB NAVIGATION RIGHT/LEFT	TV VOLUME +/-	TV VOLUME +/-
	MENU	–	STB MENU	–	–
	DISPLAY	–	–	ONSCREEN VCR DISPLAY	–
	EXIT	–	STB EXIT	–	–
	–	–	STB GUIDE	–	–
	Select Channel	Select Channel	Select Channel	Select Channel	–
	PREVIOUS CHANNEL OR VIDEO MODE	CABLE PREVIOUS	STB PREVIOUS	–	–
	SLEEP	–	STB PROGRAM/DASH	–	–
	–	–	–	VCR REW/FF	SKIP SEARCH <<REW/>>FF
	–	–	–	PLAY	PLAY
	–	–	–	PAUSE	PAUSE
	–	–	–	STOP	STOP
	–	–	–	VCR RECORD	–
	ASPECT	–	STB ASPECT	TV/VCR SWITCH	OPEN/CLOSE
	–	–	PAGE UP/DOWN	VCR CHANNEL UP/DOWN	SLOW +/-

Manuel de instrucciones [Resumen]

Estimado cliente de Panasonic

Bienvenido a la familia de clientes de Panasonic.

Esperamos sinceramente que disfrute durante muchos años de su nuevo televisor LCD.

Para obtener el máximo beneficio de su aparato, lea estas instrucciones antes de hacer cualquier ajuste, y guárdelas para poder utilizarlas como referencia en el futuro.

Guarde también el recibo de su compra, y anote el número del modelo y el número de serie de su aparato en el espacio provisto en la cubierta posterior de estas instrucciones.

Ajuste el soporte con el ángulo deseado

El ángulo del soporte se puede ajustar entre 5° hacia delante y 10° hacia atrás, y se puede girar 20° hacia la derecha/izquierda.

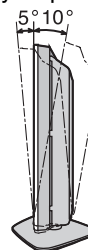
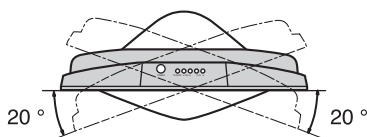
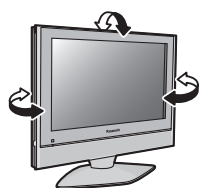

Instalación de las pilas del mando a distancia

Se necesitan dos pilas AA.

1. Abra la cubierta de las pilas.
2. Instale las pilas. Tenga en cuenta las polaridades (+ y -) al instalar las pilas.
3. Vuelva a colocar la cubierta.

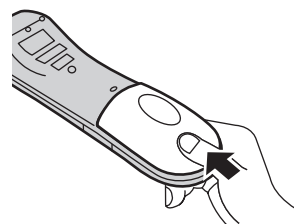
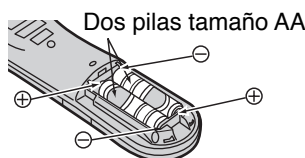
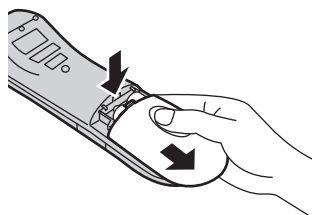

⚠ Precauciones relacionadas con la utilización de las pilas

La instalación incorrecta de las pilas puede causar fugas en las mismas que podrían estropear el transmisor de mando a distancia.

1. Utilice siempre pilas nuevas cuando reemplace las viejas.
2. No intente cargar, cortocircuitar, desarmar, calentar o quemar las pilas usadas.
3. El cambio de las pilas resulta necesario cuando el mando a distancia funciona esporádicamente o no puede controlar esta unidad.

Conexión

Nota:

Con este aparato no se suministran cables ni conectores.

Conexión de antena

Para recibir correctamente los canales de VHF/UHF se requiere una antena externa. Para obtener la mejor recepción se recomienda utilizar una antena para exteriores. El modo de antena debe ajustarse a TV (consulte la página 37, Selección del mode).

La parte posterior del televisor

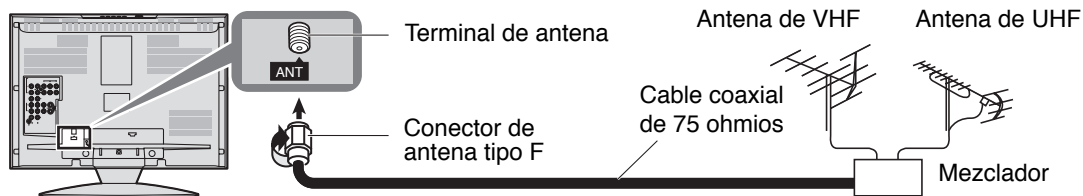

Conexión del receptor de TV por cable

- Para recibir los canales de televisión por cable (01 - 125) conecte el cable suministrado por su compañía de televisión por cable. El modo de antena debe ajustarse a CABLE (consulte la página 37, Selección del mode).
- Ciertos sistemas de televisión por cable neutralizan algunos canales para reducir interferencias o tienen canales especiales (codificados). Para recibir correctamente estos canales se necesita un sintonizador de conversión de televisión por cable. Póngase en contacto con su compañía de televisión por cable para conocer los requerimientos de compatibilidad.
- Ponga el canal del televisor en CH3 o CH4 utilice esta conexión.

Receptor de TV por cable

La parte posterior del televisor

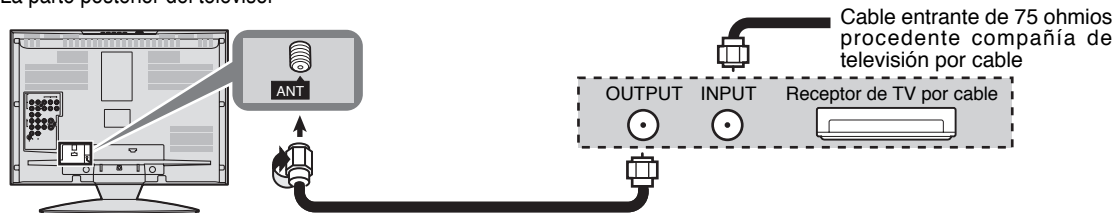

Receptor de TV por cable y Videgrabadora

La parte posterior del televisor

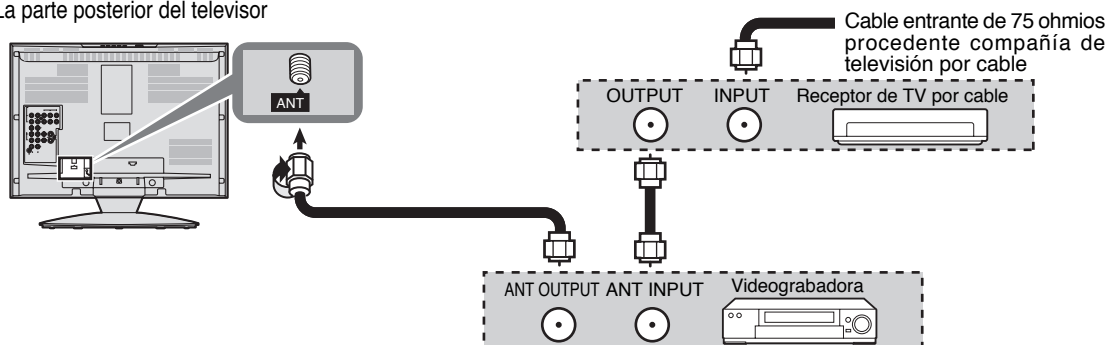

Conexión de otro equipo

Terminales de entrada traseros

Para liar los cables con la abrazadera

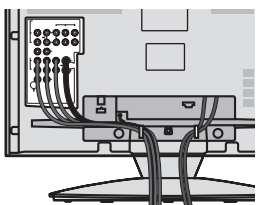

1. Tire hacia arriba.
2. Ponga los cables y cierre.

Nota:

Para evitar ruidos, no ponga juntos el cable de la antena y el de la alimentación.

La parte posterior del televisor

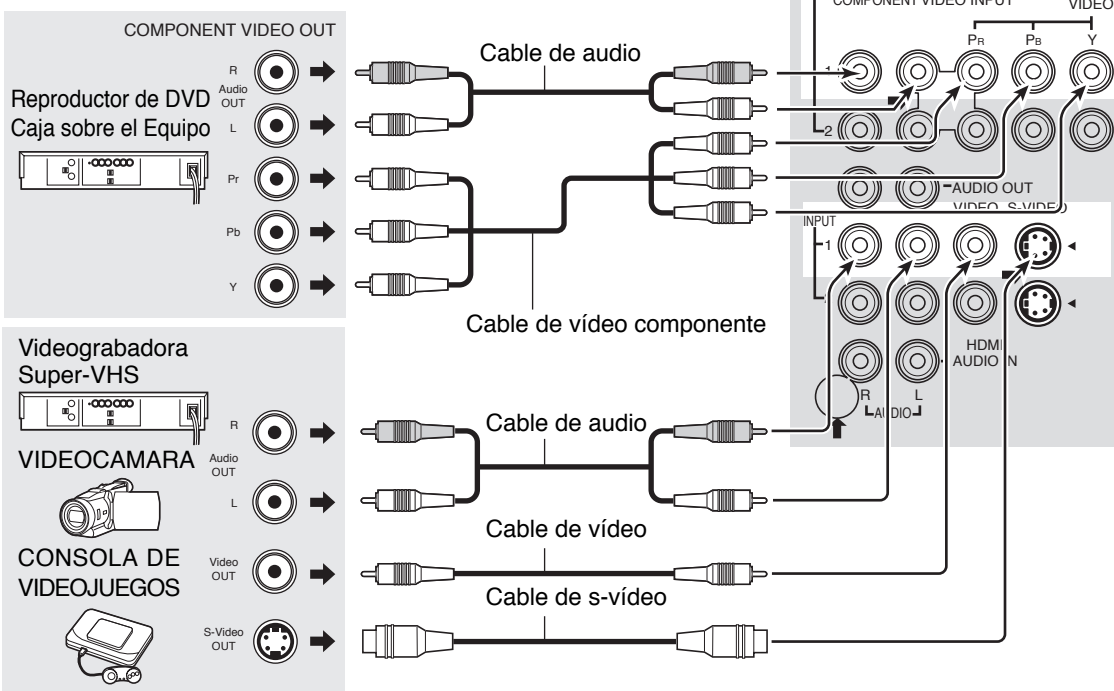
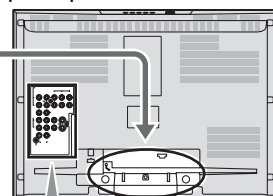

Notas:

- Al conectar cables de vídeo se da prioridad al cable de S-vídeo cuando están conectados el terminal de entrada S-VIDEO y el terminal de entrada VIDEO.
- Consulte a los fabricantes de los videojuegos acerca de los cables necesarios para conectar la consola de videojuegos.

Terminales de salida traseros

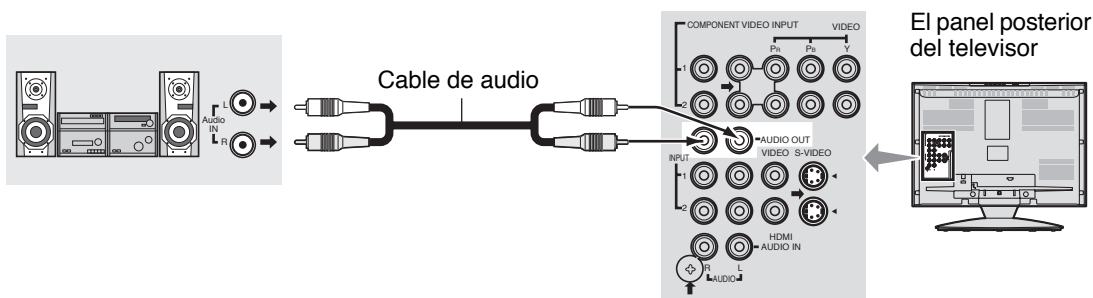

El panel posterior del televisor

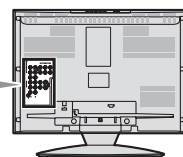

Conexión de auriculares

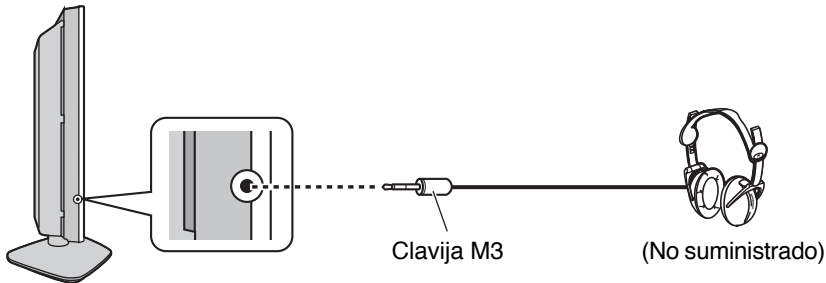

Conexión / desconexión de la alimentación

Preparación

Conecte el enchufe al tomacorriente.

Nota:

El televisor consumirá algo de corriente siempre que el enchufe del cable de alimentación esté introducido en la toma de corriente.

La parte posterior del televisor

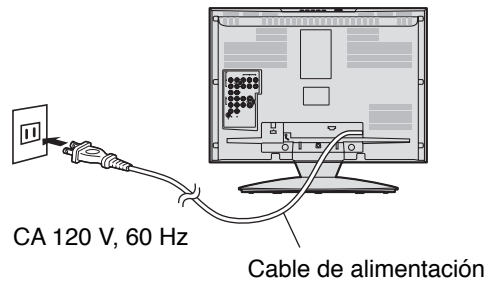

Interruptor
POWER
principal

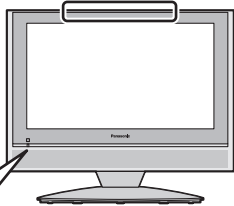

Sensor de mando a distancia

Indicador de la alimentación

En el aparato principal



POWER

Púlselo para conectar / desconectar la alimentación principal del televisor.

- Indicador de la alimentación
Conectada : Verde
Desconectada : Apagado

En el mando a distancia



POWER

Púlselo para encender / apagar el televisor.

- Indicador de la alimentación
Encendido : Verde
Apagado (En espera) : Rojo
- Esto no funciona cuando la alimentación principal está desconectada (apagado) (consulte arriba).

Nota:

La pantalla de abajo se visualiza durante unos momentos cuando se enciende el televisor.

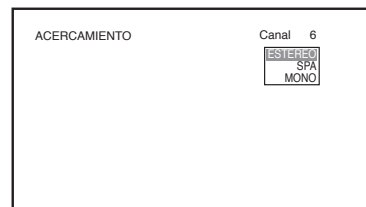
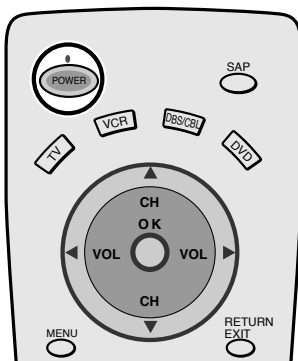

Nota:

Seleccione el idioma de menú antes de utilizar el televisor (consulte la página 35, Idioma).

Operaciones con menús

1

Púlselo para visualizar la pantalla MENU.

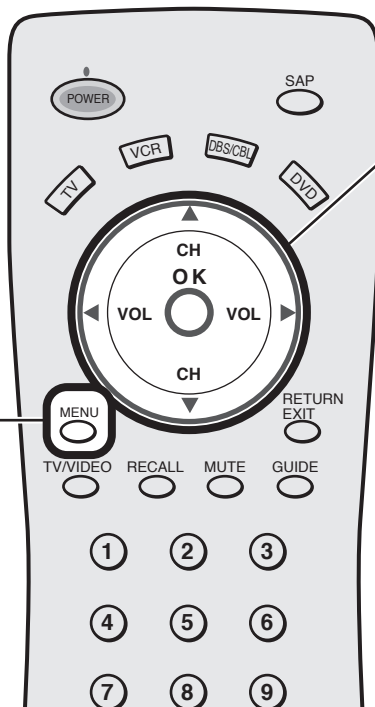
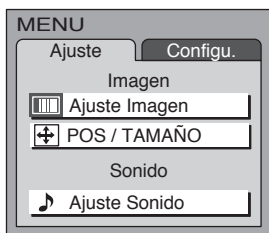

2

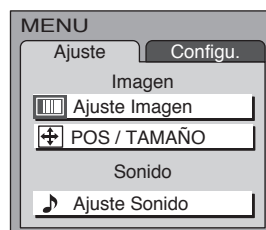
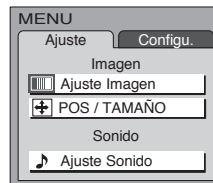

Cuadro de instrucciones de ayuda en pantalla

Cuando se visualiza un menú en el televisor aparece un cuadro de ayuda en la pantalla. Este cuadro de ayuda indica qué teclas del mando a distancia se utilizan para navegar por el menú mostrado.



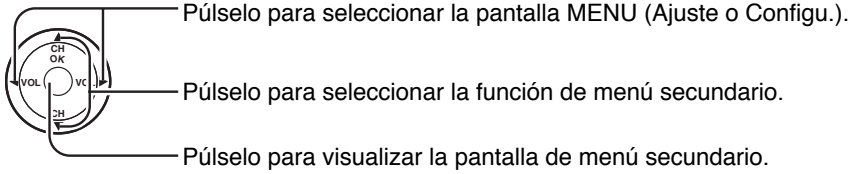

• Para volver a la pantalla anterior : RETURN
EXIT

• Para salir de la pantalla MENU : MENU Con esto se retorna a la visión normal.

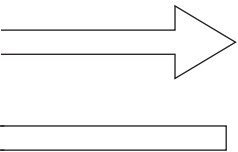

Ajuste Imagen PAJINA 1/2

Normal

Imagen

Luz de Atras

CONTRASTE

BRILLO

COLOR

TINTE

NITIDEZ

Imagen IA

POS / TAMAÑO

Normal

Normalizar TAMAÑO

1

POSITION

Ajuste Sonido PAJINA 1/2

Normal

Sonido

BAJOS

ALTOS

BALANCE

SON. ENVOL

EQUALIZ.

ESTEREO SPA MONO

Entr. HDMI

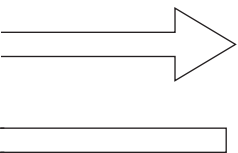

Idioma

Idioma

Seleccione el idioma del menú.

ENGLISH ← → FRANÇAIS

→ ESPAÑOL ←

Prog. Canales

MODO

PROGRAMA AUTO

PROGRAMA MANUAL

Bloqueo

Programas:

Activado

Modificar

INGRESAR CLAVE

Subtítulos

EN MUDO

MODO

Ponga Títulos

Componente1

Componente2

Video1

Video2

HDMI

Otro Ajuste PAJINA 1/2

REDUC DE RUIDO

REDUC DE RUIDO MPEG

Filtro 3D

Matriz Color

Controles básicos

< Controles del lado superior >



Botón TV/VIDEO
Subida/bajada del volumen

Interruptor POWER principal

Púlselo para conectar/desconectar la alimentación principal del televisor (consulte la página 33)

Botón de la alimentación

Púlselo para encender o apagar el televisor.

Nota:

El cable de la alimentación del televisor deberá enchufarse primero al tomacorriente, y el televisor encenderse luego con el interruptor POWER (modo de espera).

Botones de selección de modo

Satélite de emisión digital para el control remoto

Selección del modo de televisión por cable para el control remoto

Selección del modo de videograbadora para el control remoto

Selección del modo de disco de vídeo digital para el control remoto

Selección del modo de televisor para el control remoto

Botones de selección directa de números de programas

Botón R-TUNE

Cambia al canal o modo de vídeo anterior.

R-TUNE

SLEEP PROG

Botón PROG raya / Botón Temporizador de cancelado

Programa números de canales para DTV y DBS.

→ 0 → 30 → 60 → 90

Botón ASPECT

Cambia el tamaño de la pantalla.

→ JUSTIFICADO → ACERCAMIENTO → COMPLETO → NORMAL



Sensor de mando a distancia

Dentro de unos 7 metros enfrente del televisor.

Botón SAP

Selecciona el modo de audio.

→ ESTEREO → SPA → MONO

Cambia al siguiente canal superior

Mueve el cursor hacia arriba durante el modo del menú.

Reduce el volumen
Mueve el cursor hacia la izquierda durante el modo del menú.

Aumenta el volumen
Mueve el cursor hacia la derecha durante el modo del menú.

Visualiza el menú
Presione para acceder a los menús DTV, DBS o DVD.

Presione para volver MENU anterior o salir de MENU.

Cambia al siguiente canal inferior

Mueve el cursor hacia abajo durante el modo del menú.

El modo de entrada cambia cada vez que se pulsa este botón.

Pulse este botón para silenciar el sonido, y púlselo de nuevo para cancelar el silenciamiento.

Botón GUIDE para DBS

Púlselo para visualizar el estado actual del sistema como, por ejemplo, el modo de aspecto, el número del canal, el modo estéreo, TV/VIDEO y el temporizador de apagado.

Funcionamiento de otro dispositivo

Botones	REW / FF	PLAY	PAUSE	STOP
Aparato				
Videograbadora	Rebobinado / avance rápido de videograbadora	Reproducción	Pausa	Parada
CABLE/DBS	-	-	-	-
DVD	Búsqueda con salto en rebobinado / avance rápido	Reproducción	Pausa	Parada
Botones	REC	ASPECT TV/VCR	VCR/DBS CH	
Aparato				
Videograbadora	Grabación de videograbadora	Conmutación de televisor / videograbadora	Subida / bajada de canal para videograbadora	
CABLE/DBS	-	ASPECTO de STB	UP / DOWN de Página	
DVD	-	Abertura/cierre	Lentamente / + / -	

Sintonización de canales

1 Pulse el botón TV/VIDEO para visualizar el canal de TV.

2 Pulse el botón MENU para visualizar la pantalla MENU y seleccione Configu.

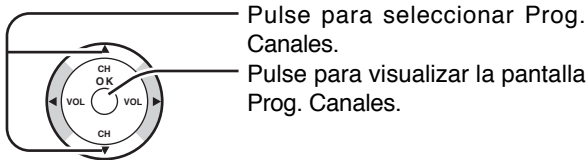

Pulse para seleccionar Prog. Canales.
Pulse para visualizar la pantalla Prog. Canales.



Selección del mode

3 Pulse para seleccionar MODO.

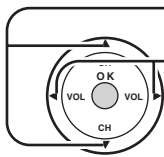

Pulse para seleccionar TV o CABLE.

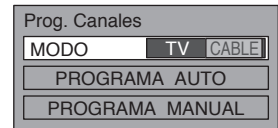

Programación automática de canales

Explora y guarda automáticamente todos los canales de TV.

4 Pulse para seleccionar PROGRAMA AUTO. Púselo para visualizar la pantalla PROGRAMA AUTO.

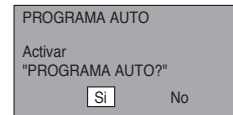
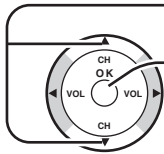

5 Pulse para seleccionar Si. Púselo para iniciar PROGRAMA AUTO.

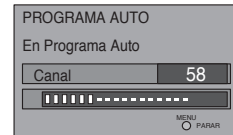
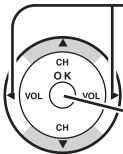

Programación automática de canales

Añada o borre un canal manualmente.

4 Pulse para seleccionar PROGRAMA MANUAL. Pulse para visualizar la pantalla PROGRAMA MANUAL.

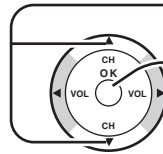

5 Pulse para seleccionar canal. • También puede utilizar los botones numerados.

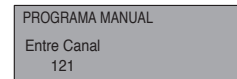
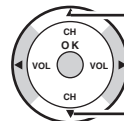

6 Púselo para añadir el canal a la memoria de canales (el número del canal se pone de color azul).

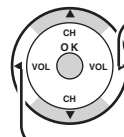

Púselo para borrar el canal de la memoria de canales (el número del canal se pone amarillo).

Los canales avanzarán automáticamente hasta que todos ellos hayan sido explorados. Los números de los canales con señal de vídeo recibida se guardarán en la memoria de canales.

















Notas:

- Cuando se pulse cualquier botón durante PROGRAMA AUTO, el televisor volverá a mostrar la imagen normal. (Los canales encontrados hasta ese punto se añaden.)
- Después de terminar PROGRAMA AUTO se visualizará el número del canal más bajo añadido.
- Cuando no haya canales que puedan recibirse, se visualizará el canal 69 (para TV) o el canal 125 (para TV por cable).

- Repita los pasos 5 y 6 para otros canales.

Troubleshooting

If there is a problem with your TV please refer to the table below to determine the symptoms, then carry out the suggested check. If this does not solve the problem, please contact your local Panasonic dealer, quoting the model number and serial number (both found on the rear of the TV).

Symptoms		Checks
Picture	Sound	
 Snowy Picture	 Noisy Sound	Antenna location, direction or connection.
 Multiple Image	 Normal Sound	Aerial location, direction or connection.
 Interference	 Noisy Sound	Electrical appliances. Cars / Motorcycles. Fluorescent lights.
 Normal Picture	 No Sound	Volume level. Sound mute switched on.
 No Picture	 No Sound	TV set to AV mode. Not plugged into AC outlet. Not switched on. Picture / Sound controls set at minimum levels. Check if in Standby mode. Make sure that a PC is not connected to HDMI input. The TV may not display video in HDMI input from devices with HDMI or DVI output due to bad communication between the TV and the devices. Should this happen, unplug the HDMI/DVI device and plug it back on.
 No Colour	 Normal Sound	Color controls set at minimum levels. Weak signal.
 Poor or Distorted Picture	 Weak or No Sound	Retune Channel (s).
 Normal Picture	 Weak Wrong or No Sound	Sound reception may have deteriorated. Switch STEREO mode (AUDIO ADJUST menu) to Off until reception improves. Change the audio of the HDMI device to Linear PCM. Check the audio setting for HDMI. If there is functional problem with Digital Audio, use Analog audio.
Cannot operate with the remote control.		The battery is exhausted. The battery's polarity is wrong. The remote control sensor is exposed to strong light of a fluorescent lamp, etc.
The main unit is hot.		The main unit radiates heat and some of the parts may become hot. This is not a problem for performance or quality. Set up at a location with good ventilation. Do not cover the ventilation holes of the TV with a tablecloth etc., and do not place on top of other equipment.
There may be red spots, blue spots, green spots and black spots on the screen.		This is a characteristic of liquid crystal panels and is not a problem. The liquid crystal panel is built with very high precision technology giving you fine picture details. Occasionally, a few non-active pixels may appear on the screen as a fixed point of red, blue, green, or black. Please note this does not affect the performance of your LCD.
H D M I	Poor Video. (Snow noise, no picture, picture runs, etc.)	HDMI cable is not connected securely. Turn the power supply of the TV set and connected equipment OFF then turn on. Check compatibility of input signal from the connected equipment. The connected equipment must be EIA/CEA-861/861B compliant.
	Poor Audio.	Change the audio setting of the connected equipment to L.PCM. Check the setting of HDMI INPUT. If the problem is due to the digital audio connection, change to the analog audio connection.

Specifications

TC-22LH30	
Power Source	AC 120 V, 60 Hz
Power Consumption	Average use : 84 W (Maximum Current 1.1 A) Stand-by condition : 0.6 W
LCD	1280 × 720 pixels widescreen LCD panel. 559mm (22-inch) diagonal.
Screen Size (W × H × diagonal)	19.20 " × 10.80 " × 22.03 " (487.7 mm × 274.3 mm × 559.5 mm)
Channel Capability	VHF-12 : UHF-56 : Cable-125
Sound	
Speakers	12 cm × 4 cm × 2 pcs, 16 Ω
Audio Output	8 W [4 W + 4 W] (10%THD)
Headphones	M3 (3.5 mm) Jack × 1
FEATURES	3D Y/C Digital Comb Filter, CLOSED CAPTION, V-Chip, HDMI
Operating Conditions	Temperature : 41 °F - 95 °F (5 °C - 35 °C) Humidity : 5 % - 90 % RH (non-condensing)
Connection Terminals	
INPUT	VIDEO (RCA PIN Type × 1) × 2 1.0 Vp-p (75 Ω)
	S-VIDEO (MINI DIN 4pin × 1) × 2 Y : 1.0 Vp-p (75 Ω), C : 0.286 Vp-p (75 Ω)
	AUDIO L-R (RCA PIN Type × 2) × 2 0.5 Vrms
COMPONENT VIDEO INPUT	Y × 2 1.0 Vp-p (including synchronization)
	P _B / P _R × 2 ±0.35 Vp-p
OUTPUT	AUDIO L-R (RCA PIN Type × 2) × 2 0.5 Vrms
HDMI	HDMI TYPE A Connector × 1
	AUDIO L-R (RCA PIN Type × 2) × 1 0.5 Vrms
Dimensions (W × H × D)	
Including TV Stand	23.31 " × 19.81 " × 10.24 " (592 mm × 503.1 mm × 260 mm)
TV Set Only	23.31 " × 16.54 " × 3.90 " (592 mm × 420 mm × 99 mm)
Mass (Weight)	11.0 kg (24.2 lb.) NET

Note:

Design and Specifications are subject to change without notice. Weight and Dimensions shown are approximate.

Customer's Record

The model number and serial number of this product can be found on its rear panel. You should note this serial number in the space provided below and retain this book, plus your purchase receipt, as a permanent record of your purchase to aid in identification in the event of theft or loss, and for Warranty Service purposes.

Model Number _____

Serial Number _____

**Panasonic Consumer Electronics
Company, Division of Matsushita
Electric Corporation of America**
One Panasonic Way Secaucus
New Jersey 07094

**Panasonic Sales Company,
Division of Matsushita Electric
of Puerto Rico Inc. ("PSC")**
Ave. 65 de Infanteria, Km 9.5
San Gabriel Industrial Park,
Carolina, Puerto Rico 00985

Panasonic Canada Inc.
5770 Ambler Drive
Mississauga, Ontario
L4W 2T3