

Digital Video Camcorder

Mini DV Digital
Video
Cassette

SC-D351/D352/D353/D354/D355

- AF** Auto Focus
CCD Charge Coupled Device
LCD Liquid Crystal Display

Owner's Instruction Book

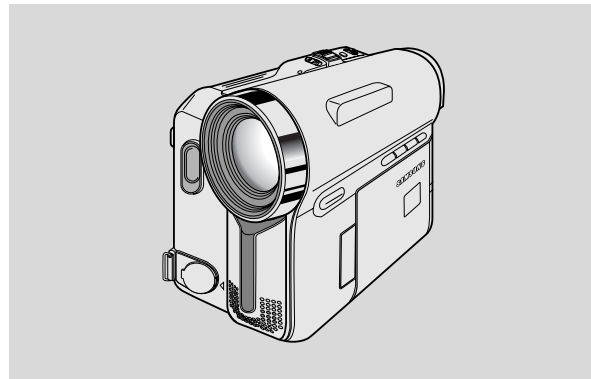

Before operating the unit, please read this Instruction Book thoroughly, and retain it for future reference.



US PATENT 4415844

Notices and Safety Instructions

Safety Instructions

	CAUTION RISK OF ELECTRIC SHOCK DO NOT OPEN	
CAUTION: TO REDUCE THE RISK OF ELECTRIC SHOCK, DO NOT REMOVE COVER(OR BACK). NO USER SERVICEABLE PARTS INSIDE, REFER SERVICING TO QUALIFIED SERVICE PERSONNEL.		

To prevent electric shock, match wide blade of plug to wide slot and fully insert.



This symbol is intended to alert the user to the presence of uninsulated dangerous voltage within the product's enclosure that may be of sufficient magnitude to constitute a risk of fire or electric shock.



This symbol is intended to alert the user to the presence of important operating and maintenance instructions in the literature accompanying this product.

1. READ INSTRUCTIONS:

All the safety and operating instructions should be read before the CAMCORDER is operated.

2. RETAIN INSTRUCTIONS:

The safety and operating instructions should be retained for future reference.

3. HEED WARNINGS:

All warnings on the CAMCORDER and in the operating instructions should be adhered to.

4. FOLLOW INSTRUCTIONS:

All operating and maintenance instructions should be followed.

5. CLEANING:

Unplug this CAMCORDER from the wall outlet before cleaning.
Do not use liquid or aerosol cleaners.
Use a dry cloth used for dusting cabinets.

6. ATTACHMENTS:

Do not use attachments not recommended by the CAMCORDER product manufacturer as they may be hazardous.

7. WATER AND MOISTURE:

Do not use this CAMCORDER near water; for example, near a bathtub, wash bowl, kitchen sink, laundry tub, in a wet basement, near a swimming pool or lake.

8. ACCESSORIES:

Do not place this CAMCORDER on an unstable cart, stand, tripod, bracket or table. The CAMCORDER may fall, causing serious injury to a child or adult, and serious damage to the unit.
Use only with a cart, stand, tripod, bracket, or table recommended by the manufacturer or sold with the CAMCORDER. Any mounting of the unit should follow the manufacturer's instructions and should use a mounting accessory recommended by the manufacturer.

A. An appliance and cart combination should be moved with care. Quick stops, excessive force and uneven surfaces may cause the appliance and cart combination to overturn.

PORTABLE CART WARNING
(Symbol provided by RETAC)



Notices and Safety Instructions

9. VENTILATION:

Slots and openings in the cabinet are provided for ventilation to ensure reliable operation of the CAMCORDER and to protect it from overheating. These openings must not be blocked or covered. Never place your CAMCORDER on a bed, sofa, rug, or other similar surface: on or near a radiator or heat register. This CAMCORDER should not be placed in a built-in installation such as a bookcase or rack unless proper ventilation is provided or the manufacturer's instructions have been adhered to.

10. POWER SOURCES:

The CAMCORDER should be operated only from the type of power source indicated on the label.

If you are not sure of the type of power supply at your home, consult your appliance dealer or local power company. A CAMCORDER is intended to be operated from battery power, or other sources, refer to the operating instructions.

11. GROUNDING OR POLARIZATION:

This CAMCORDER may be equipped with either a polarized 2-wire AC line plug (a plug having one blade wider than the other) or a 3-wire grounding type plug, a plug having a third (grounding) pin.

If you are unable to insert the plug fully into the outlet, try reversing the plug. If the plug still fails to fit, contact your electrician to replace your outlet. Do not defeat the safety purpose of the polarized plug.

12. POWER-CORD PROTECTION:

Power-supply cords should be routed so that they are not likely to be walked on or pinched by items placed upon or against them, paying particular attention to cords or plugs, convenient receptacles, and the point where they exit from the unit.

13. OUTDOOR ANTENNA GROUNDING:

If an outside antenna or cable system is connected to the CAMCORDER, be sure the antenna or cable system is grounded to provide some protection against voltage surges and built-up static charges. Section 810 of the National Electrical Code, ANSI/NFPA No. 70-1984, provides information with respect to proper grounding of the mast and supporting structure, grounding of the lead-in wire and supporting structure, grounding of the mast and supporting structure, grounding of the lead-in wire to an antenna discharge unit, size of grounding to conductors, location of antenna-discharge unit, connection to grounding electrodes and requirements for the grounding electrode.

See figure below.

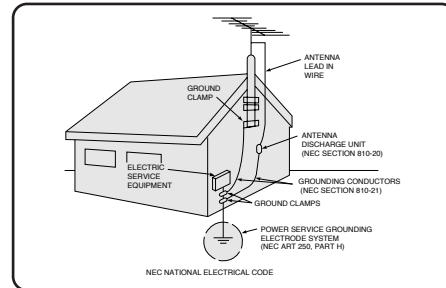

Notices and Safety Instructions

14. LIGHTNING:

For added protection of this CAMCORDER during a lightning storm or when it is left unattended and unused for long periods of time, unplug it from the wall outlet and disconnect the antenna or cable system.

This will prevent damage to the CAMCORDER due to lightning and power-line surges.

15. POWER LINES:

An outside antenna system should not be located in the vicinity of overhead power lines or other electric light or power circuits where it can fall into such power lines or circuits. When installing an outside antenna system, extreme care should be taken to keep from touching such power lines or circuits as contact with them might be fatal.

16. OVERLOADING:

Do not overload wall outlets and extension cords as this can result in a risk of fire or electric shock.

17. OBJECTS AND LIQUIDS:

Never push objects of any kind into this CAMCORDER through openings as they may touch dangerous voltage points or short out a part that could result in a fire or electric shock.

Never spill liquids of any kind onto the CAMCORDER. Should spillage occur, unplug unit and have it checked by a technician before use.

18. SERVICING:

Do not attempt to service this CAMCORDER yourself. Opening or removing covers may expose you to dangerous voltage or other hazards.

Refer all servicing to qualified service personnel.

19. DAMAGE REQUIRING SERVICE:

Unplug this CAMCORDER from the wall outlet and refer servicing to qualified service personnel under the following conditions:

- a. When the power-supply cord or plug is damaged.
- b. If any liquid has been spilled onto, or objects have fallen into the CAMCORDER.
- c. If the CAMCORDER has been exposed to rain or water.
- d. If the CAMCORDER does not operate normally by following the operating instructions, adjust only those controls that are covered by the operating instructions. Improper adjustment of other controls may result in damage and will often require extensive work by a qualified technician to restore the CAMCORDER to its normal operation.
- e. If the CAMCORDER has been dropped or the cabinet has been damaged.
- f. When the CAMCORDER exhibits a distinct change in performance, this indicates a need for service.

20. REPLACEMENT PARTS:

When replacement parts are required, be sure the service technician has used replacement parts specified by the manufacturer and having the same characteristics as the original part.

Unauthorized substitutions may result in fire, electric shock or other hazards.

21. SAFETY CHECK:

Upon completion of any service or repairs to this CAMCORDER, ask the service technician to perform safety checks to determine that the CAMCORDER is in safe operating order.

Notices and Safety Instructions

22. To prevent damage which may result in fire or shock hazard, do not expose this appliance to rain or moisture.
23. If this power supply is used at 240V ac, a suitable plug adapter should be used.

NOTE TO CATV SYSTEM INSTALLER:

This reminder is provided to call the CATV system installer's attention to Article 820-40 of the NEC that provides guidelines for proper grounding and, in particular, specifies that the cable ground shall be connected to the grounding system of the building as close to the point of cable entry as practical.

USER INSTALLER CAUTION:

Your authority to operate this FCC certified equipment could be voided if you make changes or modifications not expressly approved by this party responsible for compliance to part 15 FCC rules.

NOTE:

(Hg) LAMP(S) INSIDE THIS PRODUCT CONTAIN MERCURY AND MUST BE RECYCLED OR DISPOSED OF ACCORDING TO LOCAL, STATE OR FEDERAL LAWS For details see lamprecycle.org, eiae.org, or call 1-800-Samsung

NOTE: This equipment has been tested and found to comply with the limits for a Class B digital device, pursuant to part 15 of the FCC Rules. These limits are designed to provide reasonable protection against harmful interference in a residential installation. This equipment generates, uses and can radiate radio frequency energy and, if not installed and used in accordance with the instructions, may cause harmful interference to radio communications. However, there is no guarantee that interference will not occur in a particular installation. If this equipment does cause harmful interference to radio or television reception, which can be determined by turning the equipment off and on, the user is encouraged to try to correct the interference by one or more of the following measures:

- Reorient or relocate the receiving antenna.
- Increase the separation between the equipment and receiver.
- Connect the equipment into an outlet on a circuit different from that to which the receiver is connected.
- Consult the dealer or an experienced radio/TV technician for help and for additional suggestions.

The user may find the following booklet prepared by the Federal Communications Commission helpful : "How to Identify and Resolve Radio-TV Interference Problems."

This Booklet is available from the U.S. Government Printing Office, Washington, D.C. 20402, Stock No. 004-000-00345-4.

FCC Warning

The user is cautioned that changes or modifications not expressly approved by the manufacturer could void the user's authority to operate the equipment.

FCC ID : A3L05DRAGON

This device complies with Part 15 of FCC Rules.

Operation is subject to the following two conditions;

- (1) This device may not cause harmful interference, and
- (2) This device must accept any interference received, including interference that may cause undesired operation.

Contents

Notes and Safety Instructions	6
Getting to Know Your Camcorder	11
Features	11
Accessories Supplied with Camcorder	12
Front & Left View	13
Left Side View	14
Right & Top View	15
Rear & Bottom View	16
Remote Control (SC-D354/D355 only)	17
Preparation	18
Adjusting the Hand Strap	18
Hand Strap	18
When You carry Your Camcorder	18
Attaching the Lens Cover	18
Lithium Battery Installation	19
Battery Installation for the Internal Clock	19
Battery Installation for the Remote Control (SC-D354/D355 only)	19
Connecting a Power Source	20
To use the AC Power Adapter and DC Cable	20
To select the Camcorder Mode (SC-D353/D354/D355 only)	20
Using the Lithium Ion Battery Pack	21
Charging the Lithium Ion Battery Pack	21
Table of continuous Recording Time based on Model and Battery Type	22
Battery Level Display	23
OSD (On Screen Display in Camera/Player Modes)	24
OSD (On Screen Display in M.Cam/M.Player Modes) (SC-D353/D354/D355 only)	25
Turning the OSD (On Screen Display) On/Off	25
System Menu Setting	26
Selecting the OSD Language	26
Setting the Clock	27
Setting the Wireless Remote Control Acceptance (Remote) (SC-D354/D355 only)	28
Setting the Beep Sound	29
Setting the Shutter Sound (SC-D353/D354/D355 only)	30
Viewing the Demonstration	31
Display Menu Setting.....	32
Adjusting the LCD Screen.....	32
Displaying the Date/Time	33
Setting the TV Display.....	34

Contents

Basic Recording	35
Using the Viewfinder	35
Adjusting the Focus	35
Inserting and Ejecting a Cassette	36
Hints for Stable Image Recording	37
Recording with the LCD Screen	37
Recording with the Viewfinder	37
Various Recording Techniques	38
Making your First Recording	39
Using EASY.Q Mode (for Beginners)	40
Record Search (REC SEARCH)	41
Setting the Zero Memory (SC-D354/D355 only)	42
Self Record using the Remote Control (SC-D354/D355 only)	43
Zooming In and Out	44
Using the Tele Macro	44
Using the Fade In and Out	45
To Start Recording	45
To Stop Recording (use Fade In/Fade Out)	45
Using Back Light Compensation Mode (BLC)	46
Using the Color Nite Shutter	47
Using the Color Nite Shutter with LED Light (SC-D352/D354/D355 only)	48
Nite Pix (0 lux recording) (SC-D352/D354/D355 only)	49
Power Nite Pix (SC-D352/D354/D355 only)	50
Advanced Recording	51
Use of various Functions	51
Setting Menu Items	51
Function availability in each Mode	53
Selecting the Record Mode	54
Selecting Audio Mode	55
Cutting Off Wind Noise (Wind Cut)	56
Setting the Shutter Speed & Exposure	57
Recommended Shutter Speeds when Recording	57
Auto Focus/Manual Focus	58
Auto Focusing	58
Manual Focusing	58
Setting the White Balance	59
Using Quick Menu: White Balance	60
Setting the Digital Image Stabilizer (DIS)	61
Using Quick Menu: Digital Image Stabilizer (DIS)	62
Programmed Automatic Exposure Modes (Program AE)	63
Setting the Program AE	64
Using Quick Menu: Program AE	64

Contents

Applying Digital Effects.....	65
Selecting the Digital Effects	66
Zooming In and Out with Digital Zoom	67
Setting the Digital Zoom	67
Photo Image Recording	68
Searching for a Photo Image	68
Playback	69
Playing Back a Tape You have recorded on the LCD Screen	69
Adjusting the LCD Bright/Color during Playback	69
Controlling Sound from the Speaker.....	70
Tape Playback.....	71
Playback on the LCD Screen	71
Playback on a TV Monitor.....	71
Connecting to a TV which has Audio/Video Input Jacks.....	71
Connecting to a TV which has no Audio and Video Input Jacks	72
Playback	72
Various Functions while in Player Mode.....	73
Playback Pause.....	73
Picture Search (Forward/Reverse)	73
Slow Playback (Forward/Reverse) (SC-D354/D355 only)	73
Frame Advance (To play back frame by frame) (SC-D354/D355 only)	74
X2 Playback (Forward/Reverse) (SC-D354/D355 only).....	74
Reverse Playback (SC-D354/D355 only)	74
Zooming during Playback (PB ZOOM).....	75
AV In/Out (SC-D355 only).....	76
Audio Dubbing (SC-D354/D355 only).....	77
Dubbing Sound.....	77
Dubbed Audio Playback.....	78
IEEE 1394 Data Transfer	79
USB Interface (SC-D352/D353/D354/D355 only).....	81
Digital Still Camera Mode (SC-D353/D354/D355 only).....	87
Memory Stick (Optional Accessory).....	87
Memory Stick Functions	87
Inserting and Ejecting the Memory Card.....	88
Structure of Folders and Files on the Memory Card	89
Image Format	89
Selecting the Camcorder Mode	89
Selecting the Built-in Memory (SC-D354/D355 only)	90
Using Quick Menu: Memory Type.....	90

Contents

Selecting the Image Quality	91
Select the Image Quality	91
Number of Images on the Memory Card	91
Using Quick Menu: Photo Quality	92
Memory File Number	93
Taking Photos	94
Viewing Still Images	95
To view a Single Image	95
To view a Slide Show	95
To view the Multi Display	96
Protection from accidental Erasure	97
Using Quick Menu: Protect	98
Deleting Still Images and Moving Images	99
Using Quick Menu: Delete	100
Formatting the Memory Card	101
MPEG Recording	102
Saving Moving Picture Files onto a Memory Card	102
MPEG Playback	103
Using Quick Menu: M.Play Select	104
Recording an Image from a Cassette as a Still Image	105
Copying Still Images from a Cassette to Memory Card	106
Copy to (Copies Files from the Memory Card to the Built-in Memory) (SC-D354/D355 only)	107
Marking Images for Printing	108
Using Quick Menu: Print Mark	109
<i>PictBridge™ (SC-D353/D354/D355 only)</i>	110
<i>Maintenance</i>	112
After Finishing a Recording	112
Cleaning and Maintaining the Camcorder	113
Using Your Camcorder Abroad	114
<i>Troubleshooting</i>	115
<i>Specifications</i>	118
<i>Index</i>	119
<i>Warranty(SEA users only)</i>	120

Notes and Safety Instructions

Notes regarding the Rotation of the LCD Screen

Please rotate the LCD screen carefully as illustrated.

Over rotation may cause damage to the inside of the hinge that connects the LCD screen to the Camcorder.

1. LCD screen closed.
2. Standard recording using the LCD screen.
 - Open the LCD screen with your finger.
3. Recording when looking at the LCD screen from the top.
4. Recording when looking at the LCD screen from the front.
5. Recording when looking at the LCD screen from the left.
6. Recording with the LCD screen closed.

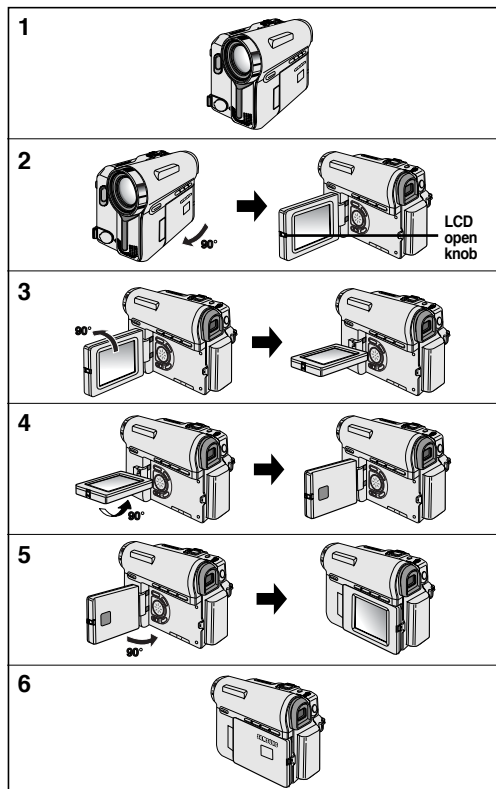

Notes and Safety Instructions

Notices regarding Copyright

Television programs, video tapes, DVD titles, films, and other program materials may be copyrighted.

Unauthorized copying of copyrighted material may be against the law.

All the trade names and registered trademarks mentioned in this manual or other documentation provided with your Samsung product are trademarks or registered trademarks of their respective holders.

Notes regarding Moisture Condensation

1. A sudden rise in atmospheric temperature may cause condensation to form inside the Camcorder.

for example:

- When you move the Camcorder from a cold location to a warm location (e.g. from outside to inside during winter.)
- When you move the Camcorder from a cool location to a hot location (e.g. from inside to outside during the summer.)

2. If the  (DEW) protection feature is activated, leave the Camcorder for at least two hours in a dry, warm room with the cassette compartment opened and the Battery pack removed.

Notes regarding Camcorder

1. Do not leave the Camcorder exposed to high temperatures (above 60°C or 140°F).
For example, in a parked car in the sun or exposed to direct sunlight.

2. Do not let the Camcorder get wet.

Keep the Camcorder away from rain, sea water, and any other form of moisture.

If the Camcorder gets wet, it may get damaged.

Sometimes a malfunction due to exposure to liquids cannot be repaired.

Notes and Safety Instructions

Notes regarding the Battery Pack

- It is recommended to use original battery pack that is available at SAMSUNG service center.
- Make sure that the Battery pack is fully charged before starting to record.
- To preserve battery power, keep your Camcorder turned off when you are not operating it.
- If your Camcorder is in CAMERA mode, and it is left in STBY mode without being operated for more than 5 minutes with a tape inserted, it will automatically turn itself off to protect against unnecessary battery discharge.
- Make sure that the Battery pack is fitted firmly into place.
Do not drop the Battery pack. Dropping the Battery pack may damage it.
- A brand new Battery pack is not charged.
Before using the Battery pack, you need to charge it completely.
- Fully discharging a Lithium-Ion battery damages the internal cells. The Battery pack may be prone to leakage when fully discharged.

When the battery reaches the end of its life, please contact your local dealer.
The batteries have to be dealt with as chemical waste.

Notes regarding the Video Head Cleaning

- To ensure normal recording and a clear picture, clean the video heads regularly.
If a square block-shape distorts playback, or only a blue screen is displayed, the video heads may be dirty.
If this happens, clean the video heads with a dry type cleaning cassette.
- Do not use a wet-type cleaning cassette. It may damage the video heads.

Notes and Safety Instructions

Note regarding the Lens

Do not film with the camera lens pointing directly at the sun.
Direct sunlight can damage the CCD (Charge Coupled Device).

Notes regarding electronic Viewfinder

1. Do not position the Camcorder such that the Viewfinder is pointing towards the sun.
Direct sunlight can damage the inside of the Viewfinder. Be careful when placing the Camcorder under sunlight or near a window exposed to sunlight.
2. Do not pick up the Camcorder by holding the Viewfinder.
3. Applying excessive force to the Viewfinder may damage it.

Notes regarding 'Record' or 'Playback' Using the LCD Screen

1. The LCD screen has been manufactured using high precision technology. However, there may be tiny dots (red, blue or green in color) that appear on the LCD screen. These dots are normal and do not affect the recorded picture in any way.
2. When you use the LCD screen under direct sunlight or outdoors, it may be difficult to see the picture clearly.
If this occurs, we recommend using the Viewfinder.
3. Direct sunlight can damage the LCD screen.

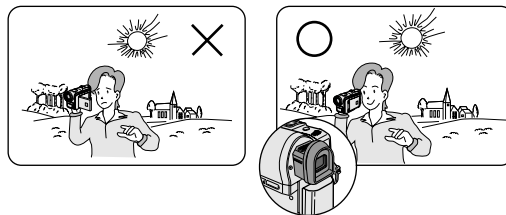

Notes regarding the Hand Strap

- To ensure a steady picture while filming, check that the hand strap is properly adjusted.
- Do not force your hand into the hand strap as you could damage it.

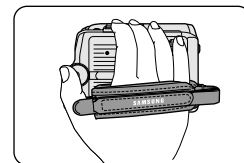

Notes and Safety Instructions

Precaution regarding the Lithium Battery

1. The Lithium battery maintains the clock function and user settings; even if the Battery pack or AC adapter is removed.
2. The Lithium battery for the Camcorder lasts about 6 months under normal operation from time of installation.
3. When the Lithium battery becomes weak or dead, the date/time indicator will display **12:00 AM JAN.1,2005** when you set the Date/Time to on.
When this occurs, replace the Lithium battery with a new one(type CR2025).
4. There is a danger of explosion if battery is incorrectly replaced.
Replace only with the same or equivalent type.

Warning: Keep the Lithium battery out of reach of children. Should a battery be swallowed, consult a doctor immediately.

Servicing

Do not attempt to service this Camcorder yourself.
Opening or removing covers may expose you to dangerous voltage or other hazards.
Refer all servicing to qualified service personnel.

Replacement Parts

When replacement parts are required, be sure the service technician has used replacement parts specified by the manufacturer and having the same characteristics as the original part.
Unauthorized substitutions may result in fire, electric shock or other hazards.

Getting to Know Your Camcorder

Features

- **Multi OSD Language**
You can select the desired OSD language among English, French, Spanish, German, Italian, Portuguese, Polish and Dutch.
- **Digital Data Transfer Function with IEEE1394**
By incorporating the IEEE 1394 (i.LINK™: i.LINK is a serial data transfer protocol and interconnectivity system, used to transmit DV data) high speed data transport port, both moving and still images can be transferred to a PC, making it possible to produce or edit various images.
- **USB Interface for Digital Image Data Transfer (SC-D352/D353/D354/D355 only)**
You can transfer images to a PC using the USB interface without an add-on card.
- **PHOTO**
The photo function lets you capture an object as a still along with sound, while in camera mode.
- **900x Digital Zoom**
Allows you to magnify an image up to 900 times its original size.
- **Color TFT LCD**
A high-resolution color TFT LCD gives you clean, sharp images as well as the ability to review your recordings immediately.
- **Digital Image Stabilizer (DIS)**
The DIS compensates for any handshake, reducing unstable images particularly at high magnification.
- **Various Digital Effects**
The digital effects allows you to give your films a special look by adding various special effects.
- **Back Light Compensation (BLC)**
The BLC function compensates for the bright background behind a subject you're recording.
- **Program AE**
The program AE enables you to alter the shutter speed and aperture to suit the type of scene/action to be filmed.
- **NITE PIX (SC-D352/D354/D355 only)**
The NITE PIX function enables you to record a subject in a dark place.
- **Digital Still Camera Function (SC-D353/D354/D355 only)**
 - Using Memory card, you can easily record and playback standard still images.
 - You can transfer standard still images on the Memory card to your PC using the USB interface.
- **MPEG Recording (SC-D353/D354/D355 only)**
MPEG recording makes it possible to record video onto a Memory card.
- **Multi Memory Card Slot (SC-D355 only)**
Multi Memory card slot is able to use Memory Stick, Memory Stick PRO, MMC and SD.
- **Built-in Memory (SC-D354/D355 only)**
You can use digital still camera functions without a separate external Memory card, using the built-in memory installed in your Camcorder. (SC-D354: 32MB/SC-D355: 64MB)

Getting to Know Your Camcorder

Accessories Supplied with Camcorder











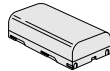

Make sure that the following basic accessories are supplied with your digital video camera.

Basic Accessories

1. Lithium Ion Battery Pack
2. AC Power Adapter (AA-E8 TYPE)
3. AC Cord
4. Audio/Video Cable
5. Instruction Book
6. Lithium Battery for Remote Control (SC-D354/D355 only) or Clock. (TYPE: CR2025)
7. Remote Control (SC-D354/D355 only)
8. USB Cable (SC-D352/D353/D354/D355 only)
9. Software CD (SC-D352/D353/D354/D355 only)
10. Lens Cover
11. Lens Cover Strap

Optional Accessories

12. S-Video Cable
13. Memory Stick (SC-D353/D354/D355 only)

<p>1. Lithium Ion Battery Pack</p>  <p>AD43-00136A</p>	<p>2. AC Power Adapter (AA-E8 TYPE)</p>  <p>AD44-00090A</p>	<p>3. AC Cord</p>  <p>AD39-00076A</p>
<p>4. Audio/Video Cable</p>  <p>AD39-00001A</p>	<p>5. Instruction Book</p> 	<p>6. Lithium Battery (CR2025)</p>  <p>AD43-10130H</p>
<p>7. Remote Control</p>  <p>AD59-00085A</p>	<p>8. USB Cable</p>  <p>AD39-00073A</p>	<p>9. Software CD</p> 
<p>10. Lens Cover</p>  <p>AD97-07354B</p>	<p>11. Lens Cover Strap</p>  <p>AD72-00049A</p>	
<p>12. S-Video Cable</p>  <p>AC39-42001Z</p>	<p>13. Memory Stick</p>  <p>1109-001221</p>	

Getting to Know Your Camcorder

Front & Left View

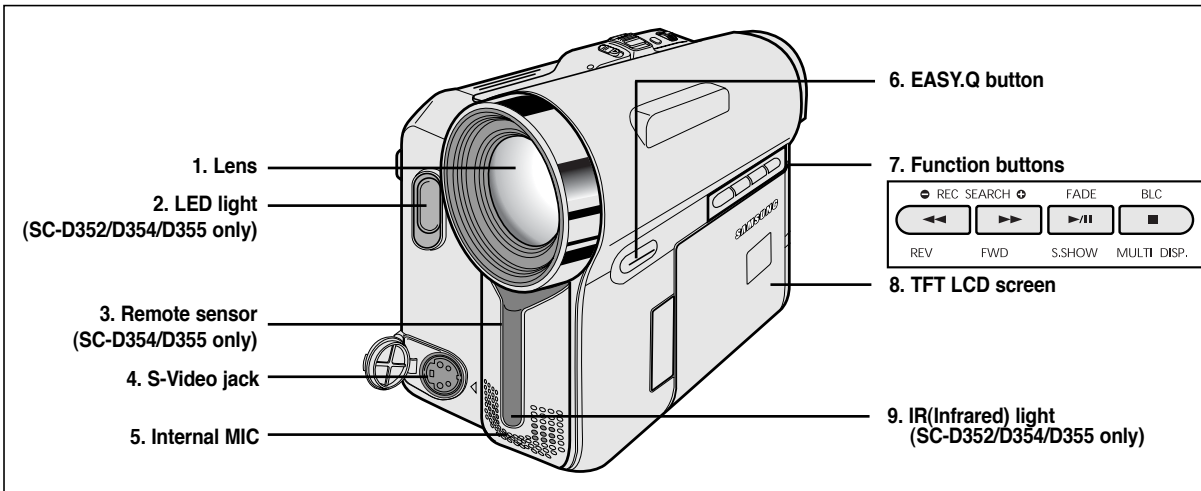

- 1. Lens
- 2. LED light (see page 48)
(SC-D352/D354/D355 only)
- 3. Remote sensor
(SC-D354/D355 only)
- 4. S-Video jack
- 5. Internal MIC

- 6. EASY.Q button
(see page 40)
- 7. Function buttons

- 8. TFT LCD screen
- 9. IR(Infrared) light
(SC-D352/D354/D355 only)

PLAYER	CAMERA	M.Player (SC-D353/D354/D355 only)
-	EASY.Q	-
◀◀ : REW	REC SEARCH -	REV
▶▶ : FF	REC SEARCH +	FWD
▶ : PLAY/STILL	FADE	S.SHOW(SLIDE SHOW)
■ : STOP	BLC	MULTI DISP.

Getting to Know Your Camcorder

Left Side View

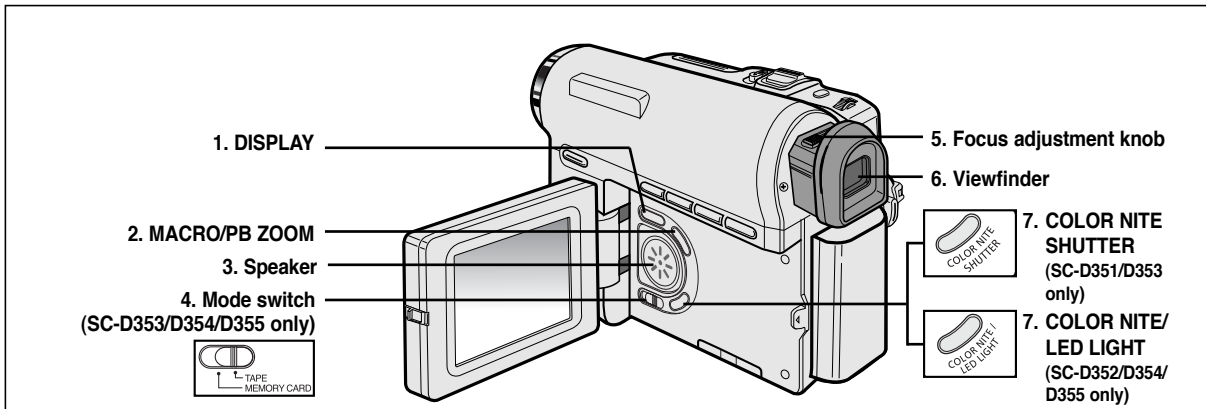

1. DISPLAY (see page 25)

2. MACRO/PB ZOOM (see page 44/see page 75)

3. Speaker

4. Mode switch (MEMORY CARD/TAPE)
(SC-D353/D354/D355 only)

5. Focus adjustment knob

6. Viewfinder

7. COLOR NITE SHUTTER (see page 47)
(SC-D351/D353 only)

7. COLOR NITE/LED LIGHT (see page 48)
(SC-D352/D354/D355 only)

Getting to Know Your Camcorder

Right & Top View

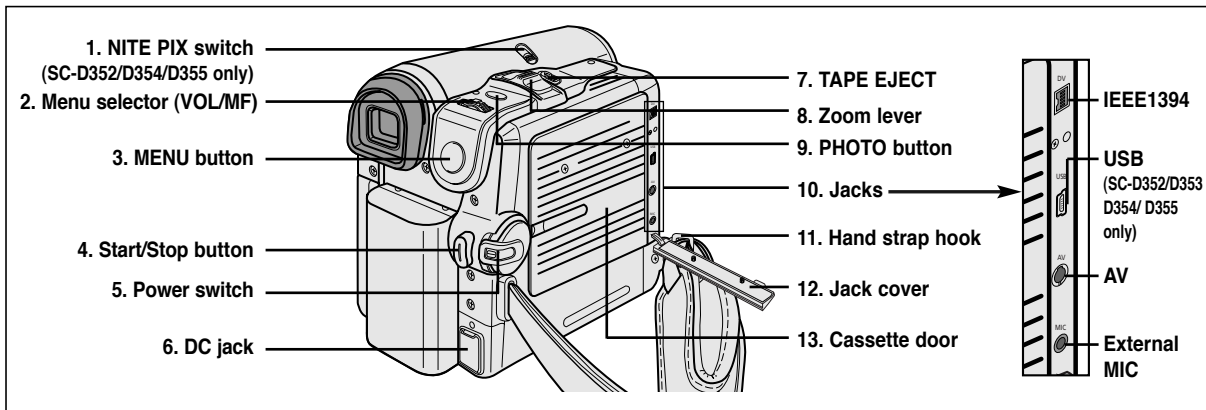

1. NITE PIX switch
(SC-D352/D354/D355 only)

2. Menu selector (VOL/MF)

3. MENU button

4. Start/Stop button

5. Power switch (CAMERA or PLAYER)

6. DC jack

7. TAPE EJECT

8. Zoom lever

9. PHOTO button
(see page 68)

10. Jacks

11. Hand strap hook

12. Jack cover

13. Cassette door

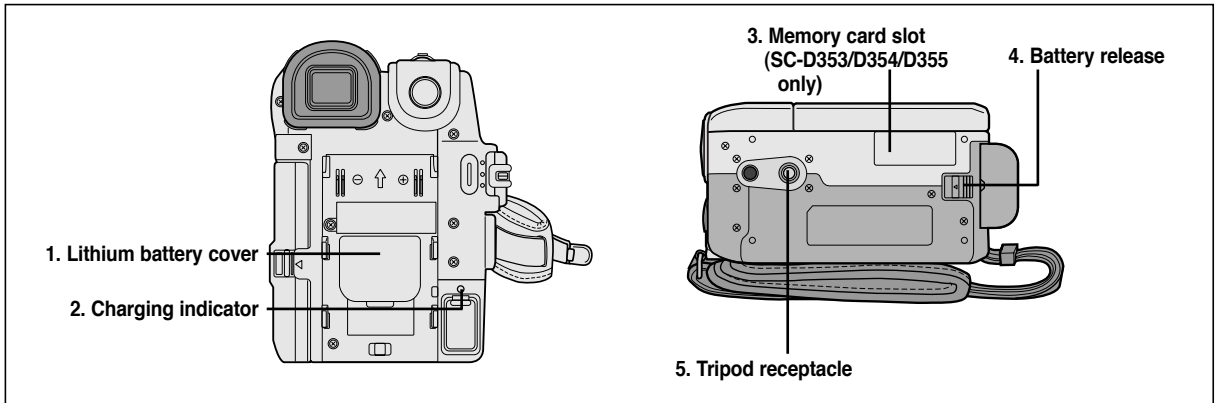

Getting to Know Your Camcorder

Rear & Bottom View



1. Lithium battery cover
2. Charging indicator
3. Memory card slot (SC-D353/D354/D355 only)
4. Battery release
5. Tripod receptacle

Memory Card Slot (Usable Memory Card)

SC-D353/D354 only	SC-D355 only
 <p>Memory Stick Memory Stick PRO</p>	 <p>Memory Stick Memory Stick PRO</p>
	 <p>SD/MMC</p>

Getting to Know Your Camcorder

Remote Control (SC-D354/D355 only)

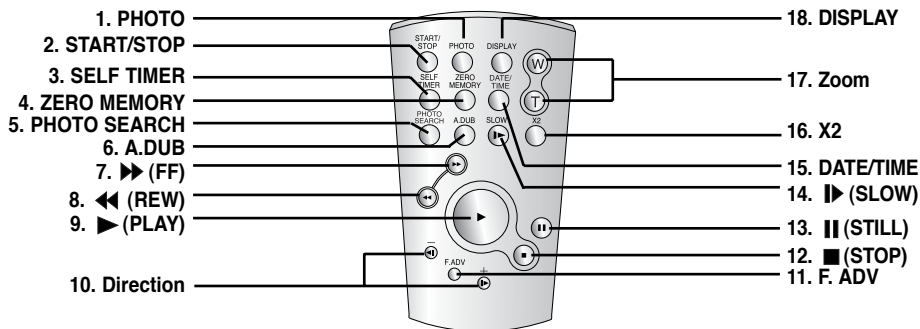

1. PHOTO (see page 68)

2. START/STOP

3. SELF TIMER (see page 43)

4. ZERO MEMORY (see page 42)

5. PHOTO SEARCH

6. A.DUB (see page 77)

7. ►► (FF)

8. ◀◀ (REW)

9. ► (PLAY)

10. Direction (◀||/||►) (see page 73)

11. F. ADV (see page 74)

12. ■ (STOP)

13. || (STILL)

14. ► (SLOW)

15. DATE/TIME

16. X2 (see page 74)

17. Zoom

18. DISPLAY

Preparation

Adjusting the Hand Strap

It is very important to ensure that the Hand strap has been correctly adjusted before you begin your recording.

The Hand strap enables you to:

- Hold the Camcorder in a stable, comfortable position.
- Press the **ZOOM** and **Start/Stop** button without having to change the position of your hand.

Hand Strap

1. Insert the Hand strap into the Hand strap hook on the front side of the Camcorder and pull its end through the hook.
2. Insert your hand into the hand strap and adjust its length for your convenience.
3. Close the Hand strap.

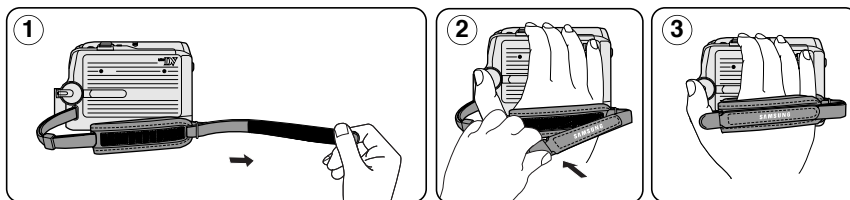

When You carry Your Camcorder

1. Pull and open the Hand strap cover to release the Hand strap.
2. Remove it from the ring and adjust its length.
3. Put your hand through the Hand Strap and close the cover of Hand Strap.

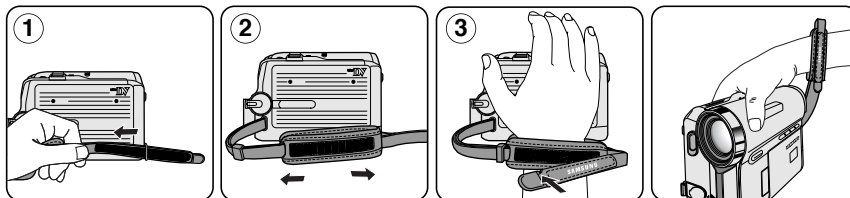

Attaching the Lens Cover

1. Hook up the Lens cover with the Lens cover strap as illustrated.
2. Hook up the Lens cover strap to the Hand strap, and adjust it following the steps as described for the Hand strap
3. Close the Hand strap.

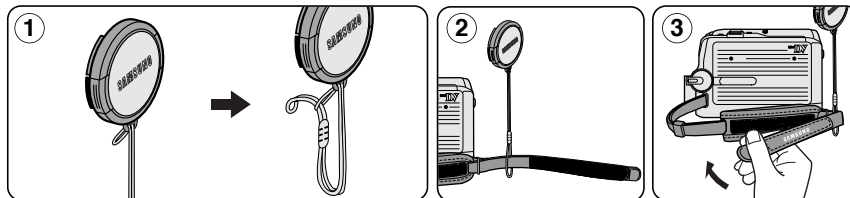

Preparation

Lithium Battery Installation

Battery Installation for the Internal Clock

- ❖ The Lithium battery maintains the clock function and preset contents of the memory; even if the Battery pack or AC Power adapter is removed.
 - ❖ The Lithium battery for the Camcorder lasts about 6 months under normal operation from the time of installation.
 - ❖ When the Lithium battery becomes weak or dead, the date/time indicator will display **12:00 AM JAN.1,2005** when you set the Date/Time to on.
When this occurs, replace the Lithium battery with CR2025 type.
1. Remove the Lithium-ion battery from the rear of the Camcorder.
 2. Open the Lithium battery cover on the rear of the Camcorder.
 3. Position the Lithium battery in the Lithium battery holder, with the positive (⊕) terminal face up.
 4. Close the Lithium battery cover.

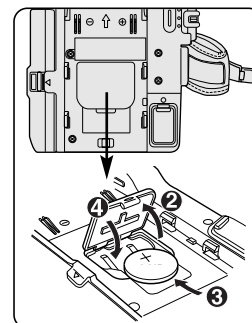

Battery Installation for the Remote Control (SC-D354/D355 only)

- ❖ You need to insert or replace the Lithium battery when:
 - You purchase the Camcorder.
 - The remote control doesn't work.
- ❖ Position the Lithium battery in the Lithium battery holder, with the positive (⊕) terminal face up.
- ❖ Be careful not to reverse the polarity of the battery.

[Note]

The Lithium battery must be inserted in the correct direction.

Warning: Keep the Lithium battery out of the reach of the children.
Should any battery be swallowed, consult a doctor immediately.

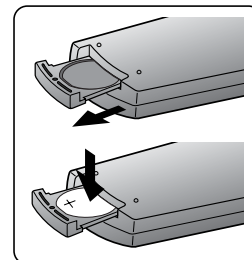

Preparation

Connecting a Power Source

There are two types of power source that can be connected to your Camcorder.

- The AC Power adapter and AC Cord: used for indoor recording.
- The Battery pack: used for outdoor recording.

To use the AC Power Adapter and DC Cable

1. Connect the AC Power adapter to the AC Cord.
2. Connect the AC Cord to a wall socket.

[Notes]

- You must use an AA-E8 TYPE AC Power adapter.
- The plug and wall socket type may differ according to your resident country.

3. Connect the DC cable to the DC jack socket of the Camcorder.
4. Set the Camcorder to each mode by holding down the tab on the **Power** switch and turning it to the **CAMERA** or **PLAYER** mode.

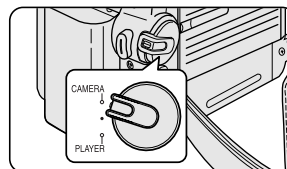
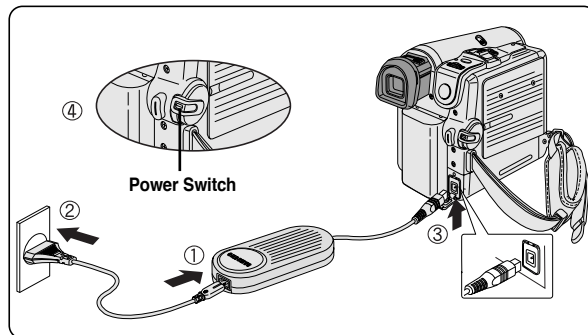

<CAMERA mode>

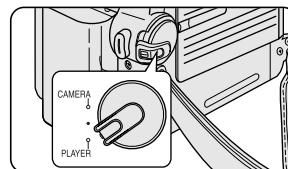

<PLAYER mode>

To Select the Camcorder Mode (SC-D353/D354/D355 only)

- ✦ If you want to use this unit as a Camcorder, set the **Mode** switch to **TAPE**.
- ✦ If you want to use this unit as a DSC (Digital Still Camera), Set the **Mode** switch to **MEMORY CARD**.

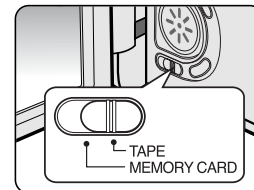

Preparation

Using the Lithium Ion Battery Pack

- ❖ The amount of continuous recording time available depends on
 - The type and capacity of the Battery pack you are using.
 - How often the zoom function is used.
 It is recommended that you have several batteries available.

Charging the Lithium Ion Battery Pack

1. Attach the Battery pack to the Camcorder.
2. Connect the AC Power adapter to an AC Cord and connect the AC Cord to a wall socket.
3. Connect the DC cable to the DC jack socket on the Camcorder.
4. Turn the **Power** switch to **Off**, and the charging indicator will start to flash, showing that the battery is charging.

Blinking time	Charging rate
Once per second	Less than 50%
Twice per second	50% ~ 75%
Three times per second	75% ~ 90%
Blinking stops and stays on	90% ~ 100%
On for a second and off for a second	Error - Reset the Battery pack and the DC cable

5. When the battery is fully charged, disconnect the Battery pack and the AC Power adapter from the Camcorder.
Even with the **Power** switched **Off**, the Battery pack will still discharge.

[Notes]

- The Battery pack may be charged a little at the time of purchase.
- To prevent reduction in the life and capacity of the Battery pack, always remove it from the Camcorder after it is fully charged.
- The amount of continuous recording time available depends on:
 - The type and capacity of the Battery pack you are using.
 - How often the zoom is used.
 - Type of use (Camcorder/Camera/With LCD screen etc.).
 - Ambient temperature.
 It is recommended to have additional battery packs available.
- Even when the Power switched Off, the Battery pack will still discharge if it is left attached to the device.

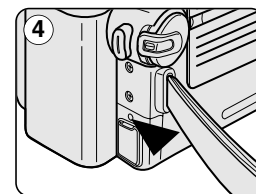
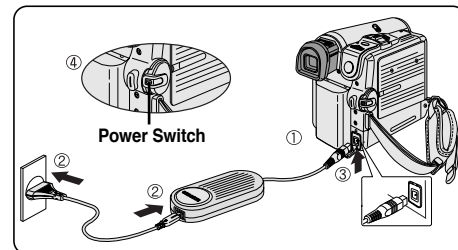

<Charging indicator>

Preparation

Table of continuous Recording Time based on Model and Battery Type.

- ❖ If you close the LCD screen, it switches off and the Viewfinder switches on automatically.
- ❖ The continuous recording times given in the table below are approximations.
Actual recording time depends on usage.

Battery \ Time	Charging time	Continuous recording time	
		LCD ON	VIEWFINDER ON
SB-LSM80	Approx. 1hr 20min	Approx. 1hr 20min	Approx. 1hr 30min
SB-LSM160 (AD43-00148A)	Approx. 3hr	Approx. 2hr 40min	Approx. 3hr

[Notes]

- The Battery pack should be recharged in an environment between 32 °F (0 °C) and 104 °F (40 °C).
- The Battery pack should never be charged in a room with a temperature that is below 32 °F (0 °C).
- The life and capacity of the Battery pack will be reduced if it is used in temperatures below 32 °F (0 °C) or left in temperatures above 104 °F (40 °C) for a long period of time, even when it is fully recharged.
- Do not put the Battery pack near any heat source (i.e. fire or a heater).
- Do not disassemble, apply pressure to or heat the Battery pack.
- Do not allow the + and – terminals of the Battery pack to be short-circuited.
It may cause leakage, heat generation, induce overheating or fire.
- Use SB-LSM80 or SB-LSM160 Battery pack only.
- It is recommended to use original battery pack that is available at SAMSUNG service center.

Preparation

Battery Level Display

The battery level display indicates the amount of power remaining in the Battery pack.

- a. Fully charged
- b. 20~40% used
- c. 40~80% used
- d. 80~95% used
- e. Completely used (Blinking)
(The Camcorder will turn off soon, change the battery as soon as possible)

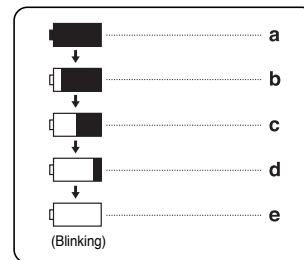

[Notes]

- Please refer to the Table on page 22 for approximate continuous recording time.
- The recording time is affected by temperature and environmental conditions.
- The recording time shortens dramatically in a cold environment.
The continuous recording times in the operating instructions are measured using a fully charged Battery pack at 77 °F (25 °C). As the environmental temperature and conditions vary. The remaining battery time may differ from the approximate continuous recording times given in the instructions.

Preparation

OSD (On Screen Display in Camera/Player Modes)

- | | |
|--|---|
| 1. Battery level (see page 23) | 21. Tape counter |
| 2. Digital effects mode (see page 65) | 22. Zero memory (SC-D354/D355 only) (see page 42) |
| 3. EASY.Q (see page 40) | 23. Record speed mode |
| 4. DIS (see page 61) | 24. Operating mode |
| 5. Program AE (see page 63) | 25. Self timer (SC-D354/D355 only) |
| 6. White balance mode (see page 59) | 26. Photo image |
| 7. Shutter speed (see page 57) | 27. Tele MACRO (see page 44) |
| 8. Exposure (see page 57) | 28. Audio playback |
| 9. Manual focus (see page 58) | 29. Volume control (see page 70) |
| 10. Date/Time (see page 33) | 30. DV IN (DV data transfer mode) (see page 80) |
| 11. Zoom position (see page 44) | 31. AV IN (SC-D355 only) |
| 12. NITE PIX (see page 49) (SC-D352/D354/D355 only) | 32. Audio dubbing (SC-D354/D355 only) (see page 77) |
| 13. Color Nite (see page 47) | 33. DEW (see page 7) |
| 14. USB (SC-D352/D353/D354/D355 only) | 34. Warning Indicator (see page 115) |
| 15. Remote (see page 28) (SC-D354/D355 only) | 35. Message line (see page 115) |
| 16. Wind cut (see page 56) | |
| 17. BLC (Back Light Compensation) (see page 46) | |
| 18. LED LIGHT (SC-D352/D354/D355 only) (see page 48) | |
| 19. Audio recording mode (see page 55) | |
| 20. Remaining tape (measured in minutes) | |

OSD in Camera Mode

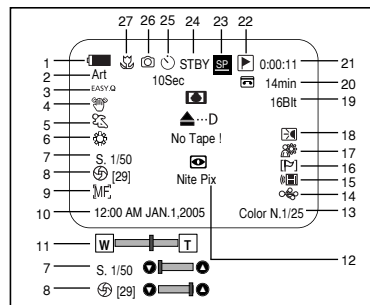

OSD in Player Mode

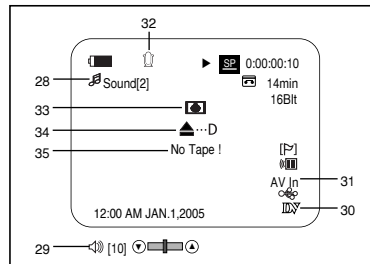

Preparation

OSD (On Screen Display in M.Cam/M.Player Modes) (SC-D353/D354/D355 only)

1. Photo quality
2. CARD (Memory Card) indicator
3. Image counter
Total number of recordable still images.
4. Image recording and loading indicator
5. Erase protection indicator (see page 97)
6. Print mark (see page 108)
7. Folder number-file number (see page 89)
8. JPEG image size
9. Slide show

OSD in M.Cam Mode

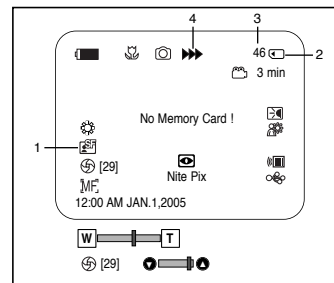

Turning the OSD (On Screen Display) On/Off

■ Turning OSD on/off

Press the **DISPLAY** button on the left side control panel.

- Each press of the button toggles the OSD function on and off.
- When you turn the OSD off,

In CAMERA Mode: The STBY, REC modes are always displayed on the OSD, even when the OSD is turned off and the key input is displayed for 3 seconds then turned off.

In PLAYER Mode: When you press any function button, the function is displayed on the OSD for 3 seconds before it turns off.

■ Turning the Date/Time on/off

To turn the Date/Time on or off, access the menu and change the Date/Time mode. (see page 33)

OSD in M.Player Mode

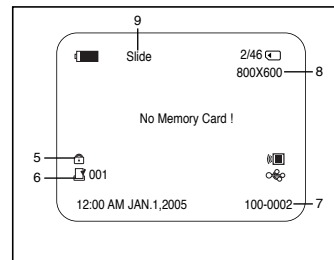

System Menu Setting

Selecting the OSD Language

- ✦ The Language function works in Camera/Player/M.Cam/M.Player modes.
- ✦ Select the appropriate OSD Language among English, French, Spanish, German, Italian, Portuguese, Polish and Dutch.

1. Set the **Power** switch to **CAMERA** or **PLAYER**.
2. Set the **Mode** switch to **TAPE** or **MEMORY CARD**. (SC-D353/D354/355 only)
3. Press the **MENU** button.
 - The menu list will appear.
4. Move the **Menu selector** to the left or right to select **System**, then press the **Menu selector**.
5. Move the **Menu selector** to the left or right to select **Language**, then press the **Menu selector**.
 - The available language options are listed.
6. Move the **Menu selector** to the left or right to select desired OSD language, then press the **Menu selector**.
 - The OSD language is refreshed in selected language.
7. To exit, press the **MENU** button.

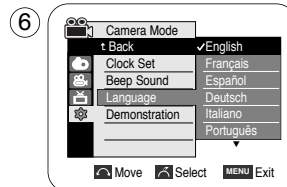
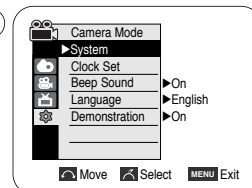
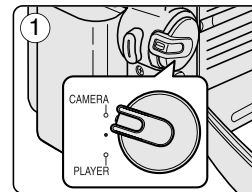

[Note]

The word "Language" in the menu is always indicated in English.

System Menu Setting

Setting the Clock

- ❖ Clock setup works in Camera/Player/M.Cam/M.Player modes.
 - ❖ The Date/Time is automatically recorded onto a tape.
Before recording, please set the Date/Time.
1. Set the **Power** switch to **CAMERA** or **PLAYER**.
 2. Set the **Mode** switch to **TAPE** or **MEMORY CARD**. (SC-D353/D354/D355 only)
 3. Press the **MENU** button.
 - The menu list will appear.
 4. Move the **Menu selector** to the left or right to select **System**, then press the **Menu selector**.
 5. Move the **Menu selector** to the left or right to select **Clock Set**, then press the **Menu selector**.
 - The year will highlight first.
 6. Move the **Menu selector** to the left or right to set current Year, then press the **Menu selector**.
 - The month will be highlighted.
 7. You can set the month, day, hour and minute following the same procedure for setting the year.
 8. Press the **Menu selector** after setting the minutes.
 - The message **Complete!** will be displayed.
 - To adjust the clock, select the Year, Month, Day, Hour or Min by pressing the **Menu selector**, then move the **Menu selector** to the left or right to set respective values.
 9. To exit, press the **MENU** button.

[Notes]

- After the Lithium battery loses its charge (after about 6 months), the date/time appears on the screen as 12:00 AM JAN.1,2005.
- You can set the year up to 2037.
- If the Lithium battery is not installed, any input data will not be backed up.

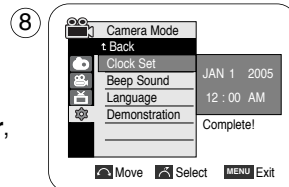
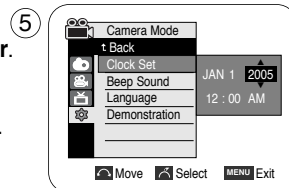
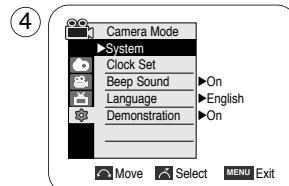

System Menu Setting

Setting the Wireless Remote Control Acceptance (Remote) (SC-D354/D355 only)

- ❖ The Remote function works in Camera/Player/M.Cam/M.Player modes.
- ❖ The Remote option allows you to enable or disable the remote control for use with the Camcorder.

1. Set the **Power** switch to **CAMERA** or **PLAYER**.
2. Set the **Mode** switch to **TAPE** or **MEMORY CARD**.
3. Press the **MENU** button.
 - The menu list will appear.
4. Move the **Menu selector** to the left or right to select **System**, then press the **Menu selector**.
5. Move the **Menu selector** to the left or right to select **Remote**, then press the **Menu selector**.
6. Move the **Menu selector** to the left or right to select **On** or **Off**, then press the **Menu selector**.
7. To exit, press the **MENU** button.

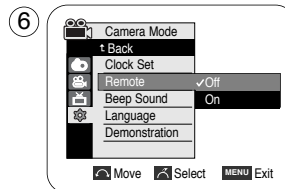
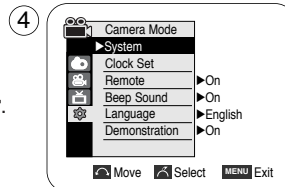
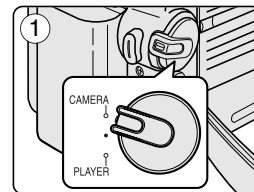

[Note]

If you set the Remote to Off in the menu and try to use it, the remote control icon (📡) will blink for 3 seconds on the LCD screen and then disappear.

System Menu Setting

Setting the Beep Sound

- ❖ The Beep Sound function works in Camera/Player/M.Cam/M.Player modes.
- ❖ You can turn the Beep Sound on or off, when on, each press of a button sounds a beep.

1. Set the **Power** switch to **CAMERA** or **PLAYER**.
2. Set the **Mode** switch to **TAPE** or **MEMORY CARD**. (SC-D353/D354/D355 only)
3. Press the **MENU** button.
 - The menu list will appear.
4. Move the **Menu selector** to the left or right to select **System**, then press the **Menu selector**.
5. Move the **Menu selector** to the left or right to select **Beep Sound**, then press the **Menu selector**.
6. Move the **Menu selector** to the left or right to select **On** or **Off**, then press the **Menu selector**.
7. To exit, press the **MENU** button.

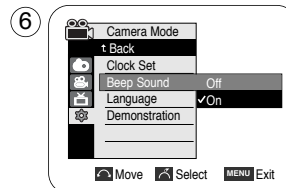
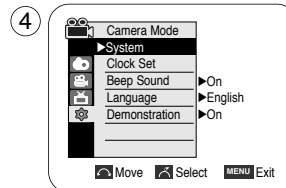
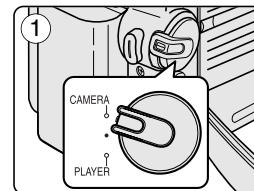

System Menu Setting

Setting the Shutter Sound (SC-D353/D354/D355 only)

- ❖ The Shutter Sound function works in both Player and M.Cam modes.
- ❖ You can turn the Shutter Sound on or off, when on, with each press of the PHOTO button the Shutter will Sound.

1. Set the **Power** switch to **CAMERA** or **PLAYER**.
2. If the **Power** switch is set to **CAMERA** mode, set the **MODE** switch to **MEMORY CARD**.
If the **Power** switch is set to **PLAYER** mode, set the **MODE** switch to **TAPE**.
3. Press the **MENU** button.
 - The menu list will appear.
4. Move the **Menu selector** to the left or right to select **System**, then press the **Menu selector**.
5. Move the **Menu selector** to the left or right to select **Shutter Sound**, then press the **Menu selector**.
6. Move the **Menu selector** to the left or right to select **On** or **Off**, then press the **Menu selector**.
7. To exit, press the **MENU** button.

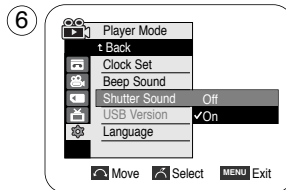
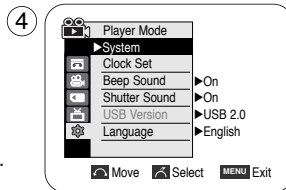
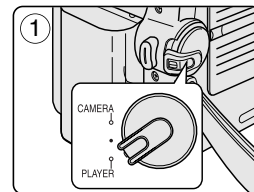

System Menu Setting

Viewing the Demonstration

- ❖ Before you begin: Make Sure that there is no tape inserted in the Camcorder. (see page 36)
- ❖ Demonstration automatically shows you the major functions that are included with your Camcorder so that you may use them more easily.
- ❖ The Demonstration function may only be used in the Camera mode without a tape inserted in the Camcorder.
- ❖ The Demonstration operates repeatedly until the Demonstration mode switched Off.

1. Set the **Power** switch to **CAMERA**.
2. Set the **Mode** switch to **TAPE**. (SC-D353/D354/D355 only)
3. Press the **MENU** button.
 - The menu list will appear.
4. Move the **Menu selector** to the left or right to select **System**, then press the **Menu selector**.
5. Move the **Menu selector** to the left or right to select **Demonstration**, then press the **Menu selector**.
6. Move the **Menu selector** to the left or right to select **On**, then press the **MENU** button.
 - The Demonstration will begin.
7. To quit the Demonstration, press the **MENU** button.

[Notes]

- The Demonstration mode is automatically activated when the Camcorder is left idle for more than 10 minutes after switching to the Camera mode (no tape is inserted in the Camcorder).
- If you press other buttons (FADE, BLC, PHOTO, EASY.Q) during the Demonstration mode, the demonstration stops temporarily and resumes 10 minutes later if you do not operate any other functions.
- While setting the NITE PIX to ON, the Demonstration function does not work. (SC-D352/D354/D355 only)

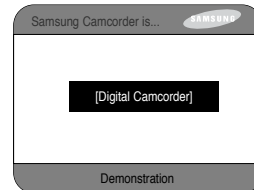
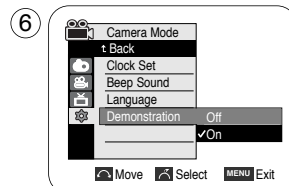
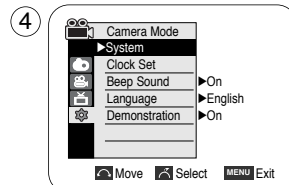
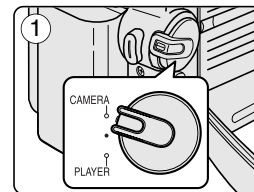

Display Menu Setting

Adjusting the LCD Screen

- This function works in Camera/Player/M.Cam/M.Player modes.
- Your Camcorder is equipped with a 2.36 inch color Liquid Crystal Display(LCD) screen, which enables you to view what you are recording or playing back directly.
- Depending on the conditions under which you are using the Camcorder (indoors or outdoors for example), you can adjust;
 - LCD Bright
 - LCD Color

1. Set the **Power** switch to **CAMERA** or **PLAYER**.
2. Set the **Mode** switch to **TAPE** or **MEMORY CARD**. (SC-D353/D354/D355 only)
3. Press the **MENU** button.
 - The menu list will appear.
4. Move the **Menu selector** to the left or right to select **Display**, then press the **Menu selector**.
5. Move the **Menu selector** to the left or right to select the item you want to adjust (**LCD Bright** or **LCD Color**), then press the **Menu selector**.
 - You can set values for **LCD Bright** and **LCD Color** between 0~35.
6. To exit, press the **MENU** button.
 - LCD Bright & LCD Color functions do not affect the brightness and color of the image to be recorded.

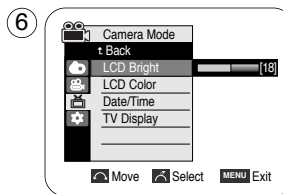
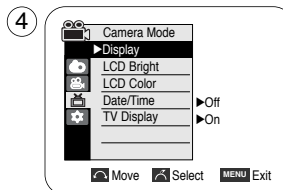
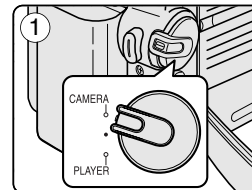

Display Menu Setting

Displaying the Date/Time

- ❖ The Date/Time function works in Camera/Player/M.Cam/M.Player modes.
- ❖ The date and time are automatically recorded on a special data area of the tape.

1. Set the **Power** switch to **CAMERA** or **PLAYER**.
2. Set the **Mode** switch to **TAPE** or **MEMORY CARD**. (SC-D353/D354/D355 only)
3. Press the **MENU** button.
 - The menu list will appear.
4. Move the **Menu selector** to the left or right to select **Display**, then press the **Menu selector**.
5. Move the **Menu selector** to the left or right to select **Date/Time**, then press the **Menu selector**.
6. Move the **Menu selector** to the left or right to select the display type of the Date/Time, then press the **Menu selector**.
 - Display type of the Date/Time: Off, Date, Time, Date&Time.
7. To exit, press the **MENU** button.

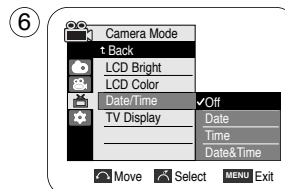
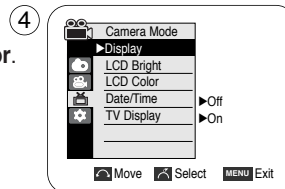
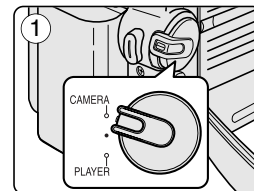

[Notes]

- The Date/Time will read **12:00 AM JAN.1,2005** in the following conditions.
 - During playback of a blank section of a tape.
 - If the tape was recorded before setting the Date/Time in the Camcorder.
 - When the Lithium battery becomes weak or dead.
- Before you use the Date/Time function, you must set the clock. See Setting the Clock on page 27.

Display Menu Setting

Setting the TV Display

- ❖ The TV Display function works in Camera/Player/M.Cam/M.Player modes.
- ❖ You can select the output path of the OSD (On Screen Display).
 - Off: The OSD appears in the LCD screen and Viewfinder only.
 - On: The OSD appears in the LCD screen, Viewfinder and TV.
 - Use the DISPLAY button located at the left side of the Camcorder to turn the OSD on/off on the LCD screen /Viewfinder/TV.

1. Set the **Power** switch to **CAMERA** or **PLAYER**.
2. Set the **Mode** switch to **TAPE** or **MEMORY CARD**. (SC-D353/D354/D355 only)
3. Press the **MENU** button.
 - The menu list will appear.
4. Move the **Menu selector** to the left or right to select **Display**, then press the **Menu selector**.
5. Move the **Menu selector** to the left or right to select **TV Display**, then press the **Menu selector**.
6. To activate TV Display function, move the **Menu selector** to the left or right to select **On** or **Off**, then press the **Menu selector**.
7. To exit, press the **MENU** button.

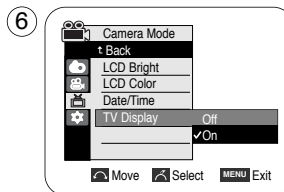
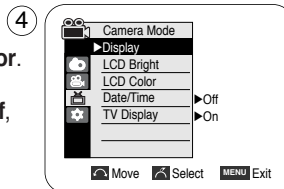
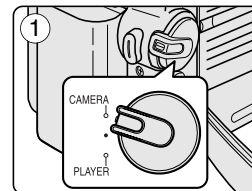

Basic Recording

Using the Viewfinder

- ❖ In the PLAYER mode, the Viewfinder will work when the LCD screen is closed.
- ❖ In the CAMERA mode, the Viewfinder will work when the LCD screen is closed or rotated counterclockwise 180°.

Adjusting the Focus

The focus adjustment knob of the Viewfinder enables individuals with vision problems to see clearer images.

1. Close the LCD screen and pull out the Viewfinder.
2. Use the focus adjustment knob of the Viewfinder to focus the picture.

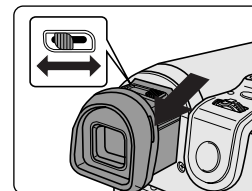

[Notes]

- Viewing the sun or any strong light source through the Viewfinder for a prolonged period may be harmful, or cause temporary impairment.
- The Viewfinder will work either in PLAYER mode with LCD screen closed or in CAMERA mode with LCD screen closed or facing the front.

Basic Recording

Inserting and Ejecting a Cassette

- ❖ When inserting a tape or closing the cassette compartment, do not apply excessive force. As it may cause a malfunction.
- ❖ Do not use any tape other than Mini DV cassettes.

1. Connect a power source and slide the **TAPE EJECT** switch.
 - The cassette door opens automatically.
2. Insert a tape into the cassette compartment with the tape window facing outward and the protection tab toward the top. (Inserting a Cassette)
 - Remove the cassette tape, which is automatically ejected by pulling the cassette out. (Ejecting a Cassette)
3. Press the area marked **PUSH** on the cassette door until it clicks into place.
 - Be careful to keep the hand strap away from the cassette door when closing it. Closing the cassette door with the hand strap inside may cause a damage to the set.
 - The cassette is loaded automatically.

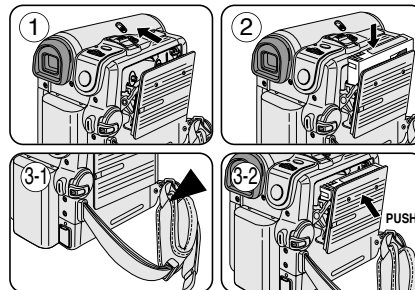

[Note]

When you have recorded something that you wish to keep, you can protect it so that it will not be accidentally erased.

a. Protecting a tape:

Push the safety tab on the cassette so that the hole is uncovered.

b. Removing the tape protection:

If you no longer wish to keep the recording on the cassette, push the safety tab back so that it covers the hole.

How to store a tape

- a. Avoid places with magnets or magnetic interference.
- b. Avoid humidity and dust prone places.
- c. Keep the tape in an upright position and avoid storing it in direct sunlight.
- d. Avoid dropping or knocking your tapes.

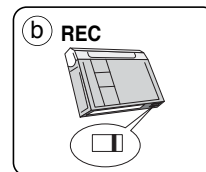

Basic Recording

Hints for Stable Image Recording

- ❖ While recording, it is very important to hold the Camcorder correctly.
- ❖ Fix the lens cover firmly by clipping it to the hand strap. (see page 18)

Recording with the LCD Screen

1. Hold the Camcorder firmly using the hand strap.
2. Place your right elbow against your side.
3. Place your left hand under or beside the LCD screen to support and adjust it.
Do not touch the built-in microphone.
4. Choose a comfortable, stable position for the shots that you are taking.
You can lean against a wall or on a table for greater stability.
Do not forget to breathe gently.
5. Use the LCD frame as a guide to determine the horizontal plane.
6. Whenever possible, use a tripod.

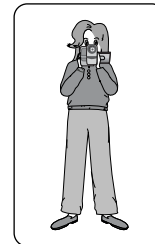

Recording with the Viewfinder

1. Hold the Camcorder firmly using the hand strap.
2. Place your right elbow against your side.
3. Place your left hand under the Camcorder to support it.
Be sure not to touch the built-in microphone.
4. Choose a comfortable, stable position for the shots that you are taking.
You can lean against a wall or on a table for greater stability.
5. To view an object through the Viewfinder, pull it out until you hear the click sound.
Excessive force may cause damage to the Viewfinder.
6. Place your eye firmly against the Viewfinder eyecup.
7. Use the Viewfinder frame as a guide to determine the horizontal plane.
8. Whenever possible, use a tripod.



Basic Recording

Various Recording Techniques

❖ In some situations different recording techniques may be required for more dramatic results.

1. General recording.

2. Downward recording.

Making a recording with a top view of the LCD screen.

3. Upward recording.

Making a recording viewing the LCD screen from below.

4. Self recording.

Making a recording viewing the LCD screen from the front.

5. Recording with the Viewfinder.

In circumstances where it is difficult to use the LCD screen, the Viewfinder can be used as a convenient alternative.

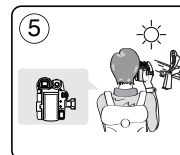
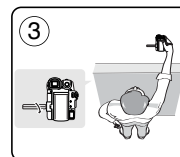
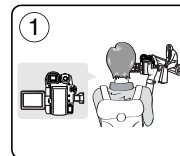

[Note]

Please rotate the LCD screen carefully as excessive rotation may cause damage to the inside of the hinge that connects the LCD screen to the Camcorder.

Basic Recording

Making your First Recording

1. Connect a power source to the Camcorder. (see page 20)
(A Battery pack or a AC Power adapter)
Insert a cassette. (see page 36)
2. Remove the Lens cover.
3. Set the **Power** switch to **CAMERA**.
 - Open the LCD screen.
 - Set the **Mode** switch to **TAPE**.
(SC-D353/D354/D355 only)
Make sure that **STBY** is displayed.
 - If the write protection tab of the cassette is open(set to save),
STOP and **Protection!** will be displayed.
Release the write protection tab to record.
 - Make sure the image you want to record appears on the LCD screen or Viewfinder.
 - Make sure the battery level indicates that there is enough remaining power for your expected recording time.
4. To start recording, press the **Start/Stop** button.
 - **REC ●** is displayed on the LCD screen.

To stop recording, press the **Start/Stop** button again.

 - **STBY** is displayed on the LCD screen.

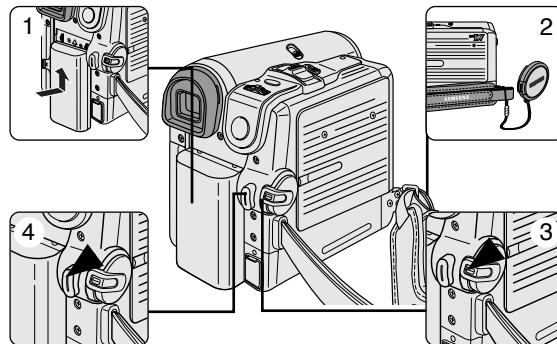

[Note]

Detach the Battery pack when you are finished recording to prevent unnecessary battery power consumption.

Basic Recording

Using EASY.Q Mode (for Beginners)

- ❖ The EASY.Q mode works only in Camera mode.
- ❖ The EASY.Q mode allows a beginner to easily make good recordings.

1. Set the **Power** switch to **CAMERA**.
2. Set the **Mode** switch to **TAPE**. (SC-D353/D354/D355 only)
3. By pressing the **EASY.Q** button, all functions on the Camcorder will be set to off and the recording settings will be set to the following basic modes:
 - Battery level, recording mode, counter, date/time, and DIS (📷) will be displayed.
 - The word **EASY.Q** will appear on the LCD screen at the same time.
 However, the Date/Time will only be seen if it has been previously set. (see page 33)
4. Press the **Start/Stop** button to start recording.
Recording will begin using the basic automatic settings.
5. Press the **EASY.Q** button again in the **STBY** mode and then turn the EASY.Q mode off.
 - The EASY.Q function will not turn off while you are recording.
 - The camcorder will return to the settings that were set prior to activating EASY.Q mode.

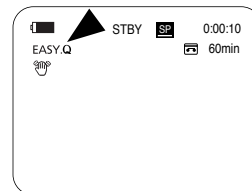
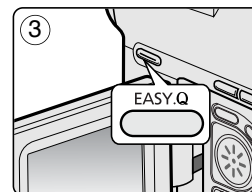
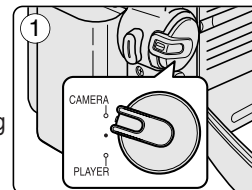

[Notes]

- In EASY.Q mode, certain functions are not available, such as Menu, BLC, Manual focus.
If you want to use these functions, you must first turn the EASY.Q mode off.
- The EASY.Q mode settings are deleted when the Battery pack is removed from the Camcorder and must be reset when the Battery pack is replaced.
- EASY.Q mode will not turn off during a recording.
- Taking a photo image using the PHOTO button while EASY.Q is set releases DIS function.
- Digital Zoom, COLOR NITE SHUTTER or Digital Effect is not available in the EASY.Q mode.

Basic Recording

When a cassette is loaded and the Camcorder is left in the STBY mode for more than 5 minutes without being used, it will switch off automatically.

To use it again, press the Start/Stop button or set the Power switch to Off and then back to CAMERA. This auto power off feature is designed to save battery power.

Record Search (REC SEARCH)

- You can view a recording using the **REC SEARCH +, -** function in **STBY** mode.
REC SEARCH - enables you to play the recording backwards and
REC SEARCH + enables you to play it forwards, for as long as you keep each button pressed down.
- If you press the **REC SEARCH -** button in **STBY** mode, your Camcorder will play in reverse for 3 seconds and return to the original position automatically.

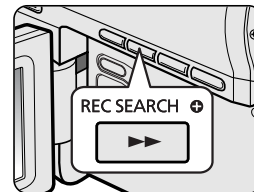
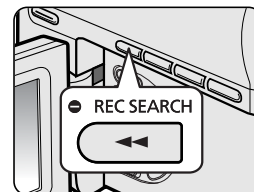

[Note]

Mosaic shaped distortion may appear on the screen while in Record Search mode.



Basic Recording

Setting the Zero Memory (SC-D354/D355 only)

- ❖ The ZERO MEMORY function works in both Camera and Player modes.
 - ❖ You can mark a point on a tape that you want to return to following playback.
1. Set the **Power** switch to **CAMERA** or **PLAYER**.
 2. Set the **Mode** switch to **TAPE**.
 3. Press the **ZERO MEMORY** button on the remote control before the recording or during playback at the point where you wish to return.
 - The time code is changed to a tape counter that is set to ZERO MEMORY with the  **0:00:00** (ZERO MEMORY indicator).
 - If you want to cancel the ZERO MEMORY function, press the **ZERO MEMORY** button again.
 4. Finding the zero position.
 - When you have finished playback, fast forward or rewind the tape in stop mode. The tape stops automatically when it reaches the zero position.
 - When you have finished recording, set the **Power** switch to **PLAYER** and press the **◀◀ (REW)** button. The tape stops automatically when it reaches the zero position.
 5. The tape counter with the  (ZERO MEMORY indicator) disappears from the display and the tape counter is changed to the time code.

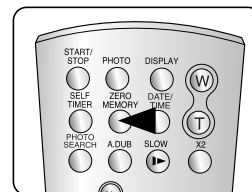
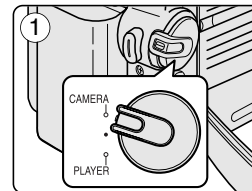

[Notes]

- In the following situations, ZERO MEMORY mode may be canceled automatically:
 - At the end of the section marked with the ZERO MEMORY function.
 - When the tape is ejected.
 - When you remove the Battery pack or power supply.
- The ZERO MEMORY may not function correctly where there is a break between recordings on the tape.

Basic Recording

Self Record using the Remote Control (SC-D354/D355 only)

- ❖ The SELF TIMER function works only in Camera mode.
- ❖ When you use the Self Timer function on the remote control, the recording begins automatically in 10 seconds.

1. Set the **Power** switch to **CAMERA**.
2. Set the **Mode** switch to **TAPE**.
3. Press the **SELF TIMER** button until the appropriate indicator is displayed in the LCD screen.
4. Press the **Start/Stop** button to start the timer.
 - Self Timer starts counting down from 10 with a beep sound.
 - In the last one second of the countdown, the beep sound gets faster, then recording starts automatically.
 - If you want to cancel the Self Timer function before recording, press the **SELF TIMER** button.
5. Press the **Start/Stop** button again when you wish to stop recording.

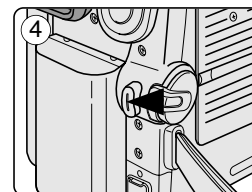
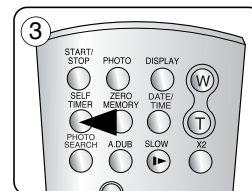
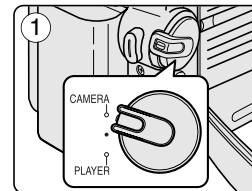

[Notes]

- Do not obstruct the remote control sensor by putting obstacles between the remote control and Camcorder.
- The remote control range is 4 ~5m (13 ~17 ft).
- The effective remote control angle is up to 30 degrees left /right from the center line.
- Using a tripod is recommended for delayed recording.

Basic Recording

Zooming In and Out

- ❖ The Zoom lever works in both Camera and M.Cam modes.
 - ❖ Zooming is a recording technique that lets you change the size of the subject in a scene.
 - ❖ You can zoom using variable zoom speeds.
 - ❖ Use these features for different shots. Please note that over-use of the Zoom feature can lead to unprofessional looking results and a reduction of battery usage time.
1. Move the Zoom lever slightly for a gradual zoom, move it further for a high-speed zoom.
 - Your zooming is monitored on the OSD.
 2. T(Telephoto) side: Subject appears closer.
 3. W(Wide angle) side: Subject appears farther away.
 - You can record a subject that is about 10mm (about 0.5 inch) away from the lens surface in the Wide position.

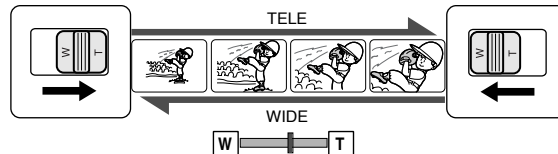

Using the Tele Macro

- ❖ Tele Macro Function works in both Camera and M.Cam mode.
 - ❖ Effective focal distance in tele macro mode is 50 Cm (19.7 inches) ~ 100 Cm (39.4 inches).
1. Press the **MACRO** button.
 - Tele Macro Icon (👁) will be displayed.
 2. If you want to cancel the Tele Macro function, press the **MACRO** button again.

[Notes]

- When recording in Tele Macro mode, the focus speed may be slow.
- When you operate the Zoom function in the Tele Macro mode, the recording subject may be out of focus.
- Use a tripod to prevent hand shake in the Tele Macro mode.
- Avoid shadows when recording in the Tele Macro mode.
- As the distance to the subject decreases, focusing area narrows.
- When you can not get proper focus, use the Zoom lever.

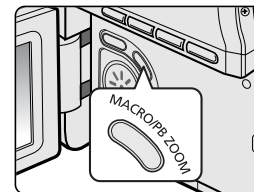

Basic Recording

Using the Fade In and Out

- ❖ The FADE function works only in Camera mode.
- ❖ You can give your recording a professional look by using special effects such as fade in at the beginning of a sequence or fade out at the end of a sequence.

To Start Recording

1. Set the **Power** switch to **CAMERA**.
2. Set the **Mode** switch to **TAPE**. (SC-D353/D354/D355 only)
3. Before recording, hold down the **FADE** button.
 - The picture and sound gradually disappear (fade out).
4. Press the **Start/Stop** button and at the same time release the **FADE** button.
 - Recording starts and the picture and sound gradually appear (fade in).

To Stop Recording (use Fade In/Fade Out)

5. When you wish to stop recording, hold down the **FADE** button.
 - The picture and sound gradually disappear (fade out).
6. When the picture has disappeared, press the **Start/Stop** button to stop recording.

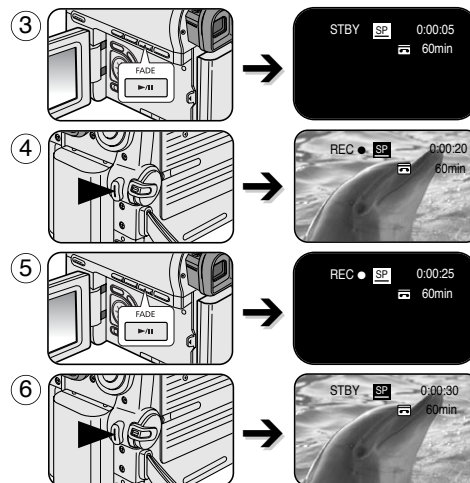

a. Fade Out

(Approx. 4 seconds)

b. Fade In

(Approx. 4 seconds)

Hold down the FADE button

a. Fade Out

Gradual disappearance

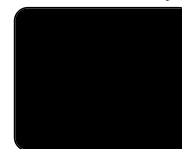

Gradual appearance

b. Fade In

Release the FADE button

Basic Recording

Using Back Light Compensation Mode (BLC)

- ❖ BLC works in both Camera and M.Cam modes.
- ❖ Back lighting exists when the subject is darker than the background:
 - The subject is in front of a window.
 - The person to be recorded is wearing white or shiny clothes and is placed against a bright background; the person's face is too dark to distinguish his/her features.
 - The subject is outdoors and the background is overcast.
 - The light sources are too bright.
 - The subject is against a snowy background.

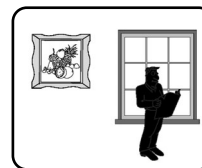

<BLC off>

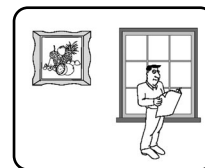

<BLC on>

1. Set the **Power** switch to **CAMERA**.
2. Set the **Mode** switch to **TAPE** or **MEMORY CARD**. (SC-D353/D354/D355 only)
3. Press the **BLC** button.
 - BLC icon (🌞) will be displayed.
4. To exit BLC mode, press the **BLC** button again.
 - Each press of the **BLC** button toggles: Normal → BLC → Normal.

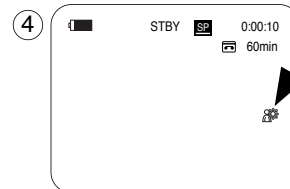
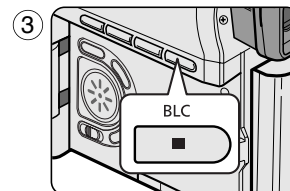

[Notes]

- When NITE PIX to set to ON, the BLC function does not work. (SC-D352/D354/D355 only)
- The BLC function will not operate in EASY.Q mode.

Basic Recording

Using the Color Nite Shutter

- ❖ COLOR NITE SHUTTER function works only in Camera mode.
 - ❖ Shutter speed can be controlled, allowing you to record slow moving objects.
 - ❖ COLOR NITE SHUTTER function may produce a brighter image.
1. Set the **Power** switch to **CAMERA**.
 2. Set the **Mode** switch to **TAPE**. (SC-D353/D354/D355 only)
 3. Press the **COLOR NITE SHUTTER** button.
 4. Each time you press the **COLOR NITE SHUTTER** button, shutter speed is changed to;
 - ▶ **Color N. 1/30**, **Color N. 1/15** and off. (SC-D351/D353 only)
 - ▶ **Color N. 1/30**, **Color N. 1/15**, **Color N. 1/15** (☒) and off. (SC-D352/D354/D355 only)

[Notes]

- The COLOR NITE SHUTTER will not turn ON or OFF while you are recording.
- When using COLOR NITE SHUTTER the image takes on a slow motion like effect.
- When using the COLOR NITE SHUTTER function, the focus adjusts slowly and the white dots may appear on the screen, this is not a defect.
- COLOR NITE SHUTTER is not available while DIS, Photo image recording or EASY.Q is in use.
- Digital Zoom, Photo image recording, 16:9 Wide, Emboss2, Pastel2, Mirror or Mosaic is not available in the COLOR NITE SHUTTER mode.
- If DIS or EASY.Q is set, COLOR NITE SHUTTER mode will be released.

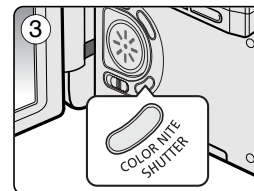
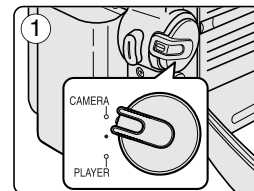

Basic Recording

Using the Color Nite Shutter with LED Light (SC-D352/D354/D355 only)

- ❖ COLOR NITE SHUTTER function works only in Camera mode.
- ❖ The LED light enables you to record a subject in dark places without sacrificing color.
- ❖ The LED light can be used with COLOR NITE SHUTTER function only.

1. Set the **Power** switch to **CAMERA**.
2. Set the **Mode** switch to **TAPE**.
3. Press the **COLOR NITE/LED LIGHT** button until **Color N. 1/15** (📷) appears on the display.

[Notes]

- The COLOR NITE/LED LIGHT will not turn ON or OFF while you are recording.
- The range of the LED light is limited. (up to 6.6ft (2m))

Danger

- The LED light can become extremely hot.
- Do not touch it while in operation or soon after turning it off, otherwise serious injury may result.
- Do not place the Camcorder into the carrying case immediately after using the LED light, since it remains extremely hot for some time.
- Do not use near flammable or explosive materials.

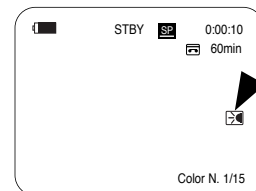
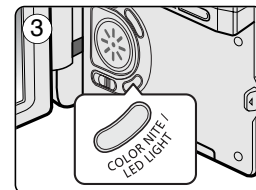
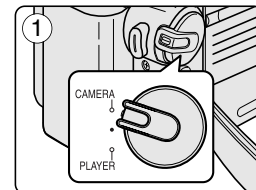

Basic Recording

Nite Pix (0 lux recording) (SC-D352/D354/D355 only)

- ❖ The Nite Pix function works in both Camera and M.Cam modes.
- ❖ The Nite Pix function enables you to record a subject in darkness.

1. Set the **Power** switch to **CAMERA**.
2. Set the **Mode** switch to **TAPE** or **MEMORY CARD**. (SC-D354/D355 only)
3. Slide the **NITE PIX** switch to **ON**.
 - Nite Pix indicator (📷) appears on the LCD screen.
 - The infrared light is turned on automatically.
4. To cancel the Nite Pix function, slide the **NITE PIX** switch to **OFF**.

[Notes]

- The maximum recording distance using the infrared light is about 3 m (about 10 feet).
- If you use the Nite Pix function in normal recording situations (ex. outdoors by day), the recorded picture may be tinted green.
- Nite Pix is not available while taking a photo image.
- In the Nite Pix mode, certain functions are not available, such as Exposure, White Balance, Program AE, Digital Effect and BLC.
- If focusing is difficult in the auto focus mode when using the Nite Pix function, focus manually.
- Do not cover the Infrared Light with your hand.
- Do not set the NITE PIX to ON in bright lighting. It might damage the CCD (Charge Coupled Device).

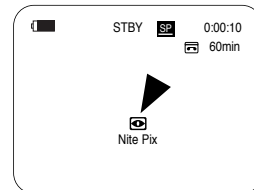
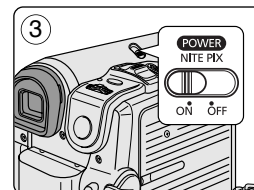
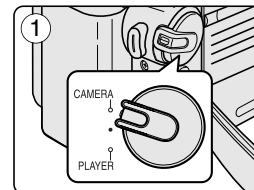

Basic Recording

Power Nite Pix (SC-D352/D354/D355 only)

- ❖ The Power Nite Pix function works only in Camera mode.
- ❖ The Power Nite Pix can record a subject more brightly in darkness than the Nite Pix function.
- ❖ When you work in Power Nite Pix mode, the Power Nite Pix icon remains on the LCD screen.
- ❖ Power Nite Pix is not available while taking a photo image or with EASY.Q is in use.

1. Set the **Power** switch to **CAMERA**.
2. Set the **Mode** switch to **TAPE**. (SC-D354/D355 only)
3. Turn on the **NITE PIX** switch, and then press the **COLOR NITE/LED LIGHT** button.
4. Press the **COLOR NITE/LED LIGHT** button to set shutter speed.
 - When using Power Nite Pix, the image takes on a slow motion like effect.
 - The slow shutter function enables you to record a subject more brightly.
5. Each time you press the **COLOR NITE/LED LIGHT** button, the shutter speed changes to Color N. 1/30, Color N. 1/15, Color N. 1/15 (⊞) and off in order.
6. To cancel the Power Nite Pix function, press the **COLOR NITE/LED LIGHT** button to set to off and then turn off the **NITE PIX** switch.

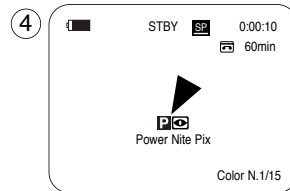
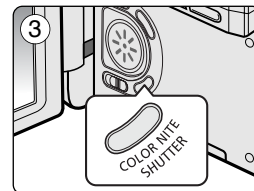
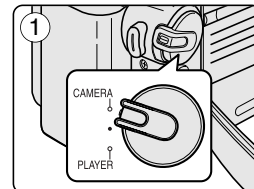

[Notes]

- The Power Nite Pix function will not turn ON or OFF while you are recording.
- The maximum recording distance using the infrared light is about 3 m (about 10 feet).
- If you use the Power Nite Pix function in normal recording situations (ex. outdoors by day), the recorded picture may contain unnatural colors.
- In the Power Nite Pix mode, certain functions are not available, such as Exposure, White Balance, Program AE, Digital Effect, BLC, Digital Zoom and Manual Focus.

Advanced Recording

Use of various Functions

Setting menu items

Main Menu	Sub Menu	Functions	Available mode				Page
			Camera	Player	M-Cam ①	M-Player ①	
Camera	Program AE	Selecting the Program AE Function	✓				63, 64
	White Balance	Setting White Balance	✓		✓		59
	Digital Effect	Setting the Digital special effect	✓				65, 66
	DIS	Selecting the Digital Image Stabilizing	✓				61
	Digital Zoom	Selecting Digital Zoom	✓				67
Tape	Photo Search	Searching pictures recorded in Tape		✓			68
	Photo Copy	Copying still images from a cassette to Memory card		✓			105
	Audio Select	Selecting the Audio playback channel		✓			78
Record	Rec Mode	Selecting the recording speed	✓	✓			54
	Audio Mode	Selecting Sound Quality for recording	✓	✓			55
	Wind Cut	Minimizing wind noise	✓	✓			56
	AV In/Out ②	Selecting the AV input/output		✓			76
Memory ①	Memory Type ③	Selecting the memory type		✓	✓	✓	90
	Photo Quality	Selecting Image Quality			✓		91, 92
	M.Play Select	Selecting Storage Media (Photo, Movie) to playback				✓	103, 104
	Delete	Deleting Files				✓	99, 100
	Delete All	Deleting All files				✓	99
	Protect	Preventing Accidental Erasure				✓	97, 98
	Print Mark	Print images recorded on a Memory Card				✓	108, 109
	Copy To ③	Copying the image of Memory card to int. memory				✓	107
	Format	Formatting the Memory Card				✓	101
File No.	File Naming Options			✓		93	

①): SC-D353/D354/D355 only

②): SC-D355 only

③): SC-D354/D355 only

Advanced Recording

Main Menu	Sub Menu	Functions	Available mode				Page
			Camera	Player	M-Cam ①	M-Player ①	
Display	LCD Bright	Setting the Brightness tone of the LCD screen	✓	✓	✓	✓	32
	LCD Color	Setting the Color tones of the LCD screen	✓	✓	✓	✓	32
	Date/Time	Setting the Date and Time	✓	✓	✓	✓	33
	TV Display	Selecting OSD on/off of TV	✓	✓	✓	✓	34
System	Clock Set	Setting the time	✓	✓	✓	✓	27
	Remote ③	Using the remote control	✓	✓	✓	✓	28
	Beep Sound	Setting the Beep sound	✓	✓	✓	✓	29
	Shutter Sound ①	Setting the Shutter sound		✓	✓		30
	USB Version ④	Setting the USB Version			✓	✓	83
	USB Connect ④	Setting the USB				✓	82
	Language	Selecting the OSD language	✓	✓	✓	✓	26
	Demonstration	Demonstration	✓				31

①): SC-D353/D354/D355 only

③): SC-D354/D355 only

④): SC-D352/D353/D354/D355 only

Advanced Recording

Function availability in each Mode

Operating Mode \ Requested Mode	Digital functions				Digital Effects			Nite Pix ①
	DIS	Digital Zoom	PHOTO (TAPE)	Color Nite Shutter	16:9 Wide	Emboss2, Pastel2, Mirror, Mosaic	the other Digital Effect	
DIS		×	☆	×	×	×	○	○
Digital Zoom	△		☆	☆	☆	☆	○	○
PHOTO(TAPE)	×	×		×	×	×	×	×
Color Nite Shutter	△	×	×		×	×	○	○
Digital Effects	16:9 Wide	△	×	×	△			△
	Emboss2, Pastel2, Mirror, Mosaic	△	×	○	△			△
	the other Digital Effect	○	○	○	○			△
Nite Pix ①	○	○	○	○	×	×	×	

○ : The requested mode will work in this operating mode.

×

△ : The requested mode will work.

☆ : The requested mode will work.

(operating mode data will be backed up.)

① : This Function works on models SC-D352/D354/D355 only.

[Note]

When you select an item that cannot be changed, an error message will be displayed.

Advanced Recording

Selecting the Record Mode

- ❖ The Record Mode function works in both Camera and Player (DV IN) modes.
- ❖ This Camcorder records and plays back in SP (standard play) mode and in LP (long play) mode.
 - SP (standard play): This mode permits 60 minutes of recording time with a DVM60 tape.
 - LP (long play): This mode permits 90 minutes of recording time with a DVM60 tape.

1. Set the **Power** switch to **CAMERA** or **PLAYER**.
2. Set the **Mode** switch to **TAPE**. (SC-D353/D354/D355 only)
3. Press the **MENU** button.
 - The menu list will appear.
4. Move the **Menu selector** to the left or right to select **Record**, then press the **Menu selector**.
5. Move the **Menu selector** to the left or right to select **Rec Mode**, then press the **Menu selector**.
6. Move the **Menu selector** to the left or right to select desired record mode(**SP** or **LP**), then press the **Menu selector**.
7. To exit, press the **MENU** button.
 - The selected icon will be displayed.

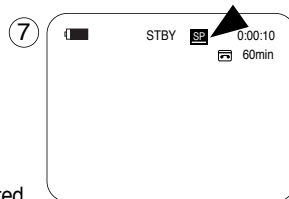
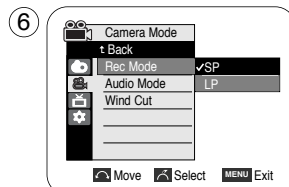
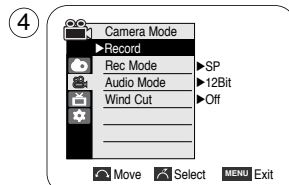

[Notes]

- We recommend that you use this Camcorder to play back any tapes recorded on this Camcorder. Playing back a tape recorded in other equipment may produce mosaic shaped distortion.
- When you record a tape in SP and LP modes, or LP mode only, the playback picture may be distorted or the time code may not be written properly if there is a gap between scenes.
- Record using SP mode for best picture and sound quality.

Advanced Recording

Selecting Audio Mode

- ❖ The Audio Mode function works in both Camera and Player modes.
- ❖ This Camcorder records sound in two ways. (12Bit, 16Bit)
 - 12Bit: You can record two 12Bit stereo sound tracks.
The original stereo sound can be recorded onto the Main (Sound1) track.
Additional stereo sound can be dubbed onto the Sub (Sound2) track.
 - 16Bit: You can record one high quality stereo sound using the 16Bit recording mode.
Audio dubbing is not possible when using this mode.

1. Set the **Power** switch to **CAMERA** or **PLAYER**.
2. Set the **Mode** switch to **TAPE**. (SC-D353/D354/D355 only)
3. Press the **MENU** button.
 - The menu list will appear.
4. Move the **Menu selector** to the left or right to select **Record**, then press the **Menu selector**.
5. Move the **Menu selector** to the left or right to select **Audio Mode**, then press the **Menu selector**.
6. Move the **Menu selector** to the left or right to select desired audio mode(12Bit or 16Bit), then press the **Menu selector**.
7. To exit, press the **MENU** button.

[Note]

When 12Bit is selected, no 12Bit indication will be displayed on the screen.

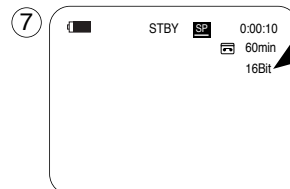
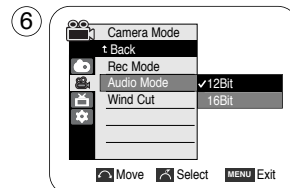
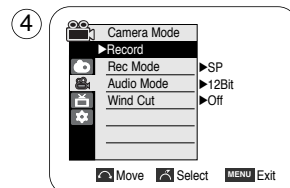

Advanced Recording

Cutting Off Wind Noise (Wind Cut)

- ❖ The Wind Cut function works in both Camera and Player (Audio dubbing) modes. Use the Wind Cut when recording in windy places such as the beach or near buildings.
- ❖ The Wind Cut function minimizes wind noise or other noise while recording.
 - When the wind cut is on, some low pitched tones are eliminated along with the sound of the wind.

1. Set the **Power** switch to **CAMERA** or **PLAYER**.
2. Set the **Mode** switch to **TAPE**. (SC-D353/D354/D355 only)
3. Press the **MENU** button.
4. Move the **Menu selector** to the left or right to select **Record**, then press the **Menu selector**.
5. Move the **Menu selector** to the left or right to select **Wind Cut**, then press the **Menu selector**.
6. To activate the **Wind Cut** function, move the **Menu selector** to the left or right to select **On**, then press the **Menu selector**.
7. To exit, press the **MENU** button.
 - Wind Cut (IP1) icon will be displayed on the LCD screen when you turn the Wind Cut On.

[Note]

Make sure Wind Cut is set to off when you want the microphone to be as sensitive as possible.

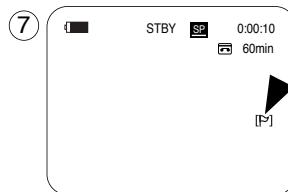
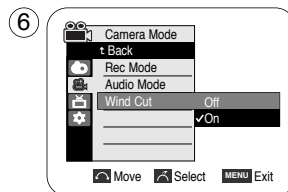
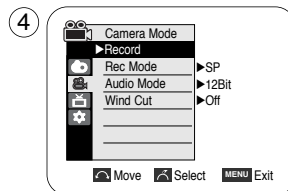

Advanced Recording

Setting the Shutter Speed & Exposure

- ❖ You can set Shutter Speed only in Camera mode.
- ❖ The Exposure function works in both Camera and M.Cam modes.
- ❖ Quick menu is used to access Camcorder functions by simply using the Menu selector.

1. Set the **Power** switch to **CAMERA**.
2. Set the **Mode** switch to **TAPE**. (SC-D353/D354/D355 only)
3. Press the **Menu selector**.
 - Quick menu list will appear.
4. Move the **Menu selector** to the left or right to select **Shutter** or **Exposure**, then press the **Menu selector**.
5. Move the **Menu selector** to the left or right to select **Manual**, then press the **Menu selector**.
6. Move the **Menu selector** to the left or right to select desired shutter speed or exposure, then press the **Menu selector**.
 - Shutter speed can be set to **1/60**, **1/100**, **1/250**, **1/500**, **1/1000**, **1/2000**, **1/4000** or **1/10000**.
 - Exposure value can be set between **00** and **29**.
7. To exit, press the **MENU** button.
 - Selected settings are displayed on the screen.

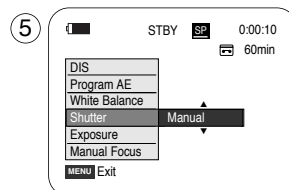
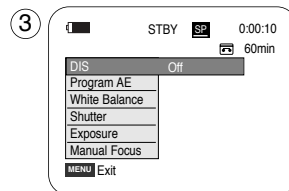

Recommended Shutter Speeds when Recording

- ❖ Outdoor sports such as golf or tennis: 1/2000 or 1/4000
- ❖ Moving cars or trains or other rapidly moving vehicles such as roller coasters: 1/1000, 1/500 or 1/250
- ❖ Indoor sports such as basketball: 1/100

[Notes]

- If you manually change the Shutter Speed and the Exposure value when Program AE option is selected, manual changes are applied first.
- The image may not seem as smooth when a high Shutter Speed is set.
- The Camcorder returns to the auto shutter and auto exposure settings when you set the NITE PIX to ON, or change to the EASY.Q mode. (SC-D352/D354/D355 only)
- When recording with a Shutter Speed of 1/1000 or higher, make sure the sun is not shining into the lens.

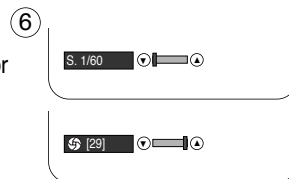

Advanced Recording

Auto Focus/Manual Focus

- The Auto Focus/Manual Focus function works in both Camera and M.Cam modes.
- In most situations, it is better to use the automatic focus feature, as it enables you to concentrate on the creative side of your recording.
- Manual focusing may be necessary under certain conditions that make automatic focusing difficult and/or unreliable. Manual Focus can be set in the Quick Menu.

Auto Focusing

- If you are inexperienced in the use of Camcorders, we recommend that you make use of Auto Focus.

Manual Focusing

- In the following situations, you may obtain better results by adjusting the focus manually.

- A picture containing several objects, some close to the Camcorder, others further away.
- A person enveloped in fog or surrounded by snow.
- Very shiny or glossy surfaces like a car.
- People or objects moving constantly or quickly like an athlete or a crowd.

1. Set the **Power** switch to **CAMERA**.
2. Set the **Mode** switch to **TAPE** or **MEMORY CARD**. (SC-D353/D354/D355 only)
3. Press the **Menu selector**.
4. Move the **Menu selector** to the left or right to select **Manual Focus**, then press the **Menu selector**.
5. Move the **Menu selector** to the left or right to select **On**, then press the **Menu selector**.
 - M.Focus(MF) icon will blink.
6. Move the **Menu selector** to the left or right until the object is in focus.

[Note]

Manual Focus is not available in the EASY.Q mode.

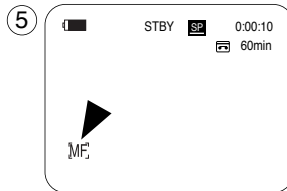
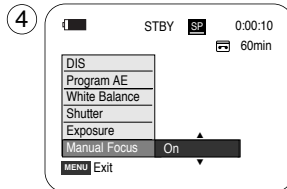
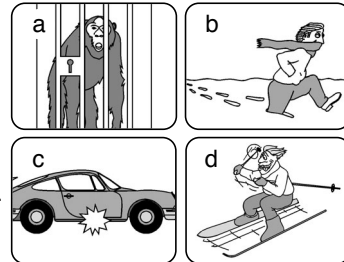

Advanced Recording

Setting the White Balance

- ❖ The White Balance function works in both Camera and M.Cam modes.
- ❖ The White Balance is a recording function that preserves the unique image color of the object in any recording condition.
- ❖ You may select the appropriate White Balance mode to obtain good quality image color.
 - Auto (☐): This mode is generally used to control the White Balance automatically.
 - Hold (⊕): This holds the current White Balance value.
 - Indoor (🏠): This controls the White Balance according to the indoor ambience.
 - Under halogen or studio/video lighting
 - Subject is of one dominant color
 - Close up
 - Outdoor (🌳): This controls the White Balance according to the outdoor ambience.
 - In daylight, especially for close up and where the subject is of one dominant color.

1. Set the **Power** switch to **CAMERA**.
2. Set the **Mode** switch to **TAPE** or **MEMORY CARD**. (SC-D353/D354/D355 only)
3. Press the **MENU** button.
 - The menu list will appear.
4. Move the **Menu selector** to the left or right to select **Camera**, then press the **Menu selector**.
5. Move the **Menu selector** to the left or right to select **White Balance**, then press the **Menu selector**.
6. Move the **Menu selector** to the left or right to select desired mode(**Auto**, **Hold**, **Indoor** or **Outdoor**), then press the **Menu selector**.
7. To exit, press the **MENU** button.
 - When the Auto mode is selected, no icon will be displayed on the screen.

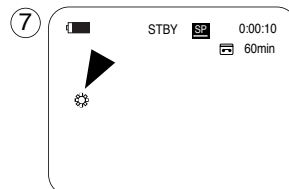
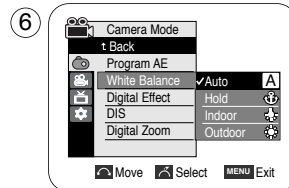
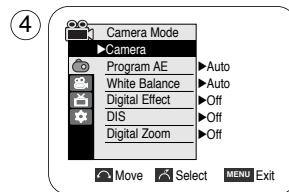

<When the Outdoor option was selected>

Advanced Recording

Using Quick Menu: White Balance

- ❖ Quick menu is used to access Camcorder functions by using the Menu selector.
- ❖ Quick menu provides easier access to frequently used menus without using the MENU button.

1. Press the **Menu selector**.
2. Move the **Menu selector** to the left or right to select **White Balance**, then press the **Menu selector**.
3. Move the **Menu selector** to the left or right to select desired mode(**Auto, Hold, Indoor or Outdoor**), then press the **Menu selector**.
4. To exit, press the **MENU** button.

[Notes]

- When NITE PIX is set to ON, the White Balance function does not work. (SC-D352/D354/D355 only)
- The White Balance function will not operate in EASY.Q mode.
- Turn the Digital Zoom off (if necessary) to set a more accurate white balance.
- Reset the white balance if lighting conditions change.
- During normal outdoor recording, setting to Auto may provide better results.

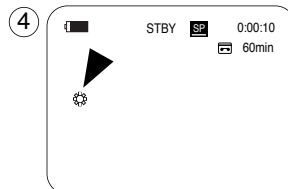
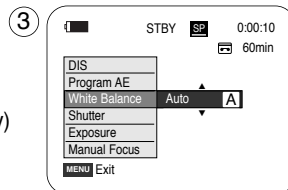
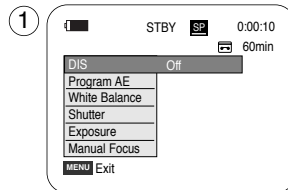

<When the Outdoor option was selected>

Advanced Recording

Setting the Digital Image Stabilizer (DIS)

- ❖ The DIS function works only in Camera mode.
- ❖ DIS (Digital Image Stabilizer) is a function that compensates for any shaking or hand movement while holding the Camcorder (within reasonable limits).
- ❖ It provides more stable pictures when:
 - Recording with the zoom (DIS is not available in Digital Zoom mode.)
 - Recording a small object close-up
 - Recording and walking at the same time
 - Recording through the window of a vehicle

1. Set the **Power** switch to **CAMERA**.
2. Set the **Mode** switch to **TAPE**. (SC-D353/D354/D355 only)
3. Press the **MENU** button.
 - The menu list will appear.
4. Move the **Menu selector** to the left or right to select **Camera**, then press the **Menu selector**.
5. Move the **Menu selector** to the left or right to select **DIS**, then press the **Menu selector**.
6. To activate the DIS function, move the **Menu selector** to the left or right to select **On**, then press the **Menu selector**.
 - If you do not want to use the DIS function, set the DIS menu to **Off**.
7. To exit, press the **MENU** button.
 - DIS() icon is displayed on the LCD screen.

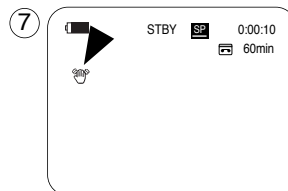
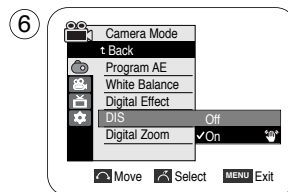
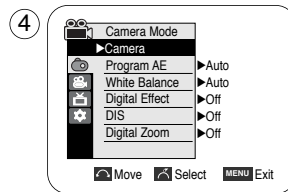

[Notes]

- Digital Zoom, COLOR NITE SHUTTER, 16:9 Wide, Emboss2, Pastel2, Mirror or Mosaic is not available in the DIS mode.
- When you press the PHOTO button while the DIS function is enabled, the DIS will be released shortly and resume automatically after the photo recording.

Advanced Recording

Using Quick Menu: Digital Image Stabilizer(DIS)

- ❖ Quick menu is used to access Camcorder functions by simply using the Menu selector.
- ❖ Quick menu provides easier access to the frequently used menus without using the MENU button.

1. Press the **Menu selector** twice.
2. Move the **Menu selector** to the left or right to select **On** or **Off**, then press the **Menu selector**.
3. To exit, press the **MENU** button.

[Notes]

- It is recommended that you deactivate the DIS function when using a tripod.
- If you use the DIS function, the picture quality may deteriorate.
- EASY.Q mode automatically sets the DIS to On.

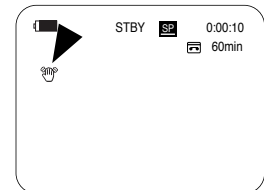
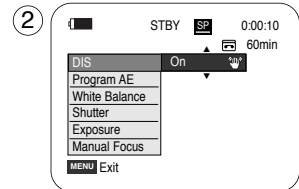
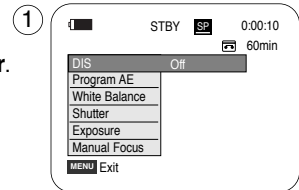

Advanced Recording

Programmed Automatic Exposure Modes (Program AE)

- ❖ The Program AE function works only in Camera mode.
- ❖ The Program AE mode allows you to adjust shutter speeds and apertures to suit different recording conditions.
- ❖ They give you creative control over the depth of field.

- **Auto mode (A)**

- Auto balance between the subject and the background.
- To be used in normal conditions.
- The shutter speed automatically varies from 1/60 to 1/250 per second, depending on the scene.

- **Sports mode (S)**

For recording people or objects moving quickly.

- **Portrait mode (P)**

- For focusing on the background of the subject, when the background is out of focus.
- The Portrait mode is most effective when used outdoors.
- The shutter speed automatically varies from 1/60 to 1/1000 per second.

- **Spotlight mode (S)**

For recording correctly when there is only light on the subject and not the rest of the picture.

- **Sand/Snow mode (S)**

For recording when people or objects are darker than the background because of reflected light from sand or snow.

- **High Speed(High Shutter Speed) mode (S)**

For recording fast-moving subjects such as players in golf or tennis games.

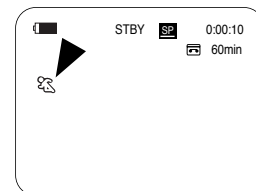

[Notes]

- While setting the NITE PIX to ON, the Program AE function does not work. (SC-D352/D354/D355 only)
- The Program AE function will not operate in EASY.Q mode.

Advanced Recording

Setting the Program AE

1. Set the **Power** switch to **CAMERA**.
2. Set the **Mode** switch to **TAPE**. (SC-D353/D354/D355 only)
3. Press the **MENU** button.
 - The menu list will appear.
4. Move the **Menu selector** to the left or right to select **Camera**, then press the **Menu selector**.
5. Move the **Menu selector** to the left or right to select **Program AE**, then press the **Menu selector**.
 - The available options are listed.
6. Move the **Menu selector** to the left or right to select desired program AE option, then press the **Menu selector**.
7. To exit, press the **MENU** button.
 - The icon of the selected mode will be displayed on the LCD screen.
 - When the Auto mode is selected, no icon will be displayed on the screen.

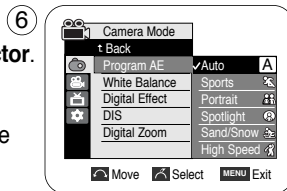
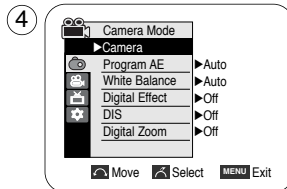

Using Quick Menu: Program AE

1. Press the **Menu selector**.
2. Move the **Menu selector** to the left or right to select **Program AE**, then press the **Menu selector**.
3. Move the **Menu selector** to the left or right to select desired program AE option, then press the **Menu selector**.
4. To exit, press the **MENU** button.

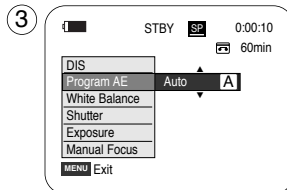
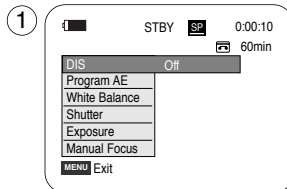

Advanced Recording

Applying Digital Effects

- ❖ The Digital Effect function works only in Camera mode.
- ❖ The Digital Effects enable you to give a creative look to your recording.
- ❖ Select the appropriate Digital Effect for the type of picture that you wish to record and the effect you wish to create.
- ❖ There are 11 Digital Effect modes.

1. ART mode

This mode gives the images a coarse effect.

2. Mosaic mode

This mode gives the images a mosaic effect.

3. Sepia mode

This mode gives the images a reddish-brown pigment.

4. Negative mode

This mode reverses the colors, creating a negative image.

5. Mirror mode

This mode cuts the picture in half, using a mirror effect.

6. BLK & WHT mode

This mode changes the images to black and white.

7. Emboss1 mode

This mode creates a 3D effect (embossing).

8. Emboss2 mode

This mode creates a 3D effect (embossing) on surrounding area of an image.

9. Pastel1 mode

This mode applies a pale pastel drawing effect to an image.

10. Pastel2 mode

This mode applies a pale pastel drawing effect to surrounding area of an image.

11. 16:9 Wide mode

Select to record a picture to be played back on a 16:9 Wide TV.

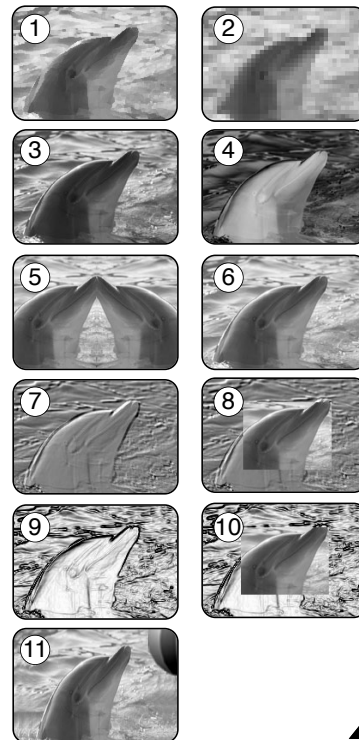

Advanced Recording

Selecting the Digital Effects

1. Set the **Power** switch to **CAMERA**.
2. Set the **Mode** switch to **TAPE**. (SC-D353/D354/D355 only)
3. Press the **MENU** button.
 - The menu list will appear.
4. Move the **Menu selector** to the left or right to select **Camera**, then press the **Menu selector**.
5. Move the **Menu selector** to the left or right to select **Digital Effect**, then press the **Menu selector**.
6. Move the **Menu selector** to the left or right to select the desired Digital Effect mode, then press the **Menu selector**.
 - The display mode is set to the selected mode.
7. To exit, press the **MENU** button.

[Notes]

- The Pastel2, Emboss2, 16:9 Wide, Mirror or Mosaic modes are not available while DIS or COLOR NITE SHUTTER is in use.
- Digital Effect modes are not available while EASY.Q or NITE PIX is in use.
- Once DIS, EASY.Q or COLOR NITE SHUTTER is set, 16:9 Wide, Emboss2, Pastel2, Mirror or Mosaic modes will be released.
- Digital Zoom is not available in the 16:9 Wide, Emboss2, Pastel2, Mirror or Mosaic modes.
- Digital Effect modes other than 16:9 Wide, Emboss2, Pastel2, Mirror or Mosaic are available while DIS is in use.
- Setting the NITE PIX while Digital Effect is in use releases the Digital Effect, and releasing the NITE PIX will set the Digital Effect to Off mode.
- Photo image recording is not available in the 16:9 Wide mode.

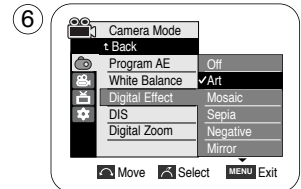
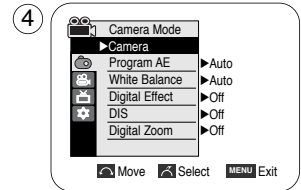
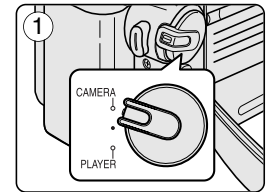

Advanced Recording

Zooming In and Out with Digital Zoom

- ❖ Zoom works only in Camera mode.

Selecting the Digital Zoom

- ❖ Zooming more than 20x is achieved digitally, up to 900x when combined with optical zoom.
- ❖ The picture quality may deteriorate depending on how much you zoom in on the subject.
- ❖ We recommend that you use the DIS feature with Digital Zoom for picture stability. (see page 61)

1. Set the **Power** switch to **CAMERA**.
2. Set the **Mode** switch to **TAPE**. (SC-D353/D354/D355 only)
3. Press the **MENU** button.
 - The menu list will appear.
4. Move the **Menu selector** to the left or right to select **Camera**, then press the **Menu selector**.
5. Move the **Menu selector** to the left or right to select **Digital Zoom**, then press the **Menu selector**.
6. Move the **Menu selector** to the left or right to select desired zoom mode (**Off**, **100x**, **200x**, **400x** or **900x**), then press the **Menu selector**.
7. To exit, press the **MENU** button.

[Notes]

- Maximum zooming may result in lower picture quality.
- Digital Zoom is not available while DIS, EASY.Q, taking a photo image, COLOR NITE SHUTTER, 16:9 Wide, Emboss2, Pastel2, Mirror or Mosaic is in use.
- Once taking a photo image, COLOR NITE SHUTTER, 16:9 Wide, Emboss2, Pastel2, Mirror or Mosaic is set, Digital Zoom mode will be released. (The Digital Zoom mode will be backed up.)
- Once DIS or EASY.Q is set, Digital Zoom mode will be released.

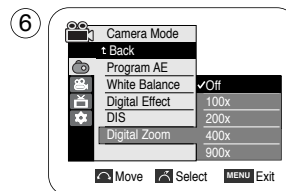
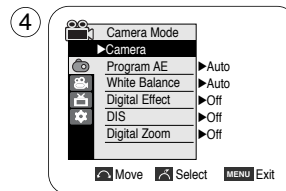
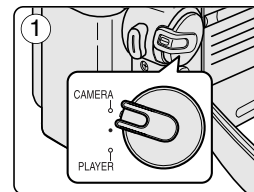

Advanced Recording

Photo Image Recording

- ❖ Photo image recording works only in Camera mode.
1. Set the **Power** switch to **CAMERA**.
 2. Set the **Mode** switch to **TAPE**. (SC-D353/D354/D355 only)
 3. Press the **PHOTO** button.
 - The still picture is recorded for about 6~7 seconds.
 4. After the PHOTO has been recorded, the Camcorder returns to its previous mode.

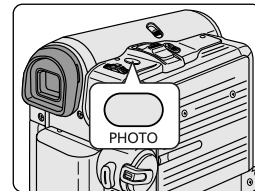

Searching for a Photo Image

- ❖ The Photo Search works only in Player mode.
1. Set the **Power** switch to **PLAYER**.
 2. Set the **Mode** switch to **TAPE**. (SC-D353/D354/D355 only)
 3. Press the **MENU** button.
 - The menu list will appear.
 4. Move the **Menu selector** to the left or right to select **Tape**, then press the **Menu selector**.
 5. Move the **Menu selector** to the left or right to select **Photo Search**, then press the **Menu selector**.
 6. Press the **◀/▶** (REW/FF) buttons to select the photo.
 - The photo search process appears on LCD screen while you are searching.
 - After completing the search, the Camcorder displays the still image.
 7. To exit, press the **■** (STOP) or **MENU** button.

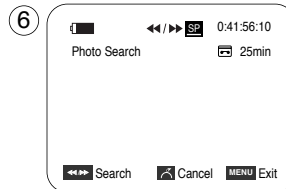
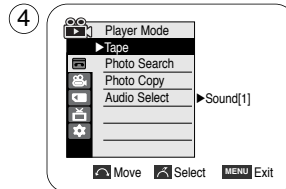

[Notes]

- Pressing the PHOTO button while recording, stops the recording and saves the still image captured at that moment. It takes approx. 6 ~7 seconds to save the image and then recording resumes.
- You can use the remote control to take a photo by using the PHOTO button on the remote control. Pressing the PHOTO button on the remote control records the still image at once with automatic focusing. (SC-D354/D355 only)
- When there are no still images recorded on the tape, it will be fully rewind or forwarded.
- Taking a photo image is not available while COLOR NITE SHUTTER or 16:9 Wide is in use.
- DIS, Digital Zoom, COLOR NITE SHUTTER, Digital Effect and Nite Pix are not available, when take a photo image.
- Taking a photo image while EASY.Q, DIS or Digital Zoom mode is in use will the mode. (After a photo image is taken, the mode will return automatically.)

Playback

Playing Back a Tape You have recorded on the LCD Screen

- ❖ The playback function works only in Player mode.
 - ❖ You can monitor the playback picture on the LCD screen.
1. Set the **Power** switch to **PLAYER**.
 2. Set the **Mode** switch to **TAPE**. (SC-D353/D354/D355 only)
 3. Insert the tape you wish to view. (see page 36)
 4. Open the LCD screen.
 - Adjust the angle of the LCD screen and set the brightness or color if necessary.
 5. Press the ◀◀(REW) button to rewind the tape to the starting point.
 - To stop rewinding, press the ■ (STOP) button.
 - The Camcorder stops automatically after rewinding is complete.
 6. Press the ▶/|| (PLAY/STILL) button to start playback.
 - You can view the picture you recorded on the LCD screen.
 - To stop the play operation, press the ■ (STOP) button.

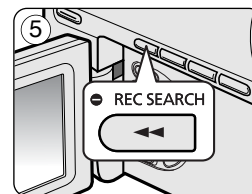
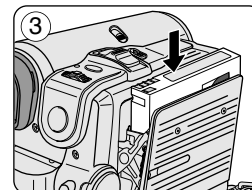
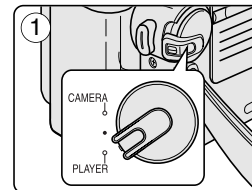

Adjusting the LCD Bright/Color during Playback

- ❖ You can adjust the LCD Bright/Color during playback.
- ❖ The adjustment method is the same procedure as used in Camera mode. (see page 32)

[Notes]

- You can also view the picture on a TV screen, after connecting the Camcorder to a TV or VCR. (see page 71~72)
- Various functions are available in Player mode. (see page 73)
- For searching and viewing still images recorded onto tape. (see page 68)

Playback

Controlling Sound from the Speaker

- ❖ The Speaker works only in Player mode.
- ❖ When you use the LCD screen for playback, you can hear recorded sound from the built-in Speaker.
 - Take the following steps to lower the volume or mute the sound while playing a tape on the Camcorder.

1. Set the **Power** switch to **PLAYER**.
2. Set the **Mode** switch to **TAPE**. (SC-D353/D354/D355 only)
3. Press the **▶/||** (PLAY/STILL) to play the tape.
4. When you hear sounds once the tape is in play, use the **Menu selector** to adjust the volume.
 - A volume level display will appear on the LCD screen. Levels may be adjusted from anywhere between 00 to 19 and you will not hear any sound when the volume is set on 00.
 - If you close the LCD screen while playing, you will not hear sound from the speaker.

[Notes]

- When the AV cable is connected to the Camcorder, you cannot hear sound from the Built-In Speaker and cannot adjust the volume.
- The sound will return when you remove the connected AV cable from the jack of your Camcorder.

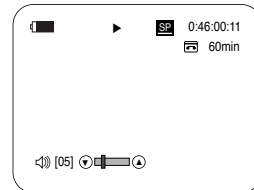
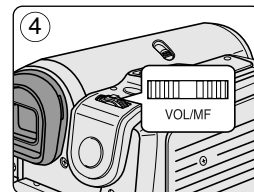
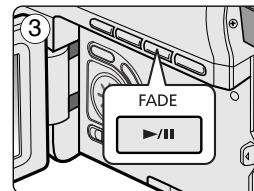

Playback

Tape Playback

- ❖ The playback function works only in Player mode.

Playback on the LCD Screen

- ❖ It is practical to view a tape using the LCD screen when in a car or outdoors.

Playback on a TV Monitor

- ❖ To play back a tape, the television must be NTSC compatible.(see page 114)
- ❖ We recommend that you use the AC Power adapter as the power source for the Camcorder.

Connecting to a TV which has Audio/Video Input Jacks

1. Connect the Camcorder to your TV with the Audio/Video cable.
 - The yellow jack: Video
 - The white jack: Audio(L)-mono
 - The red jack: Audio(R)

If you connect to a monaural TV, connect the yellow jack (Video) to the video input of the TV and the white jack (Audio L) to the audio input of the TV.
2. Set the **Power** switch to **PLAYER**.
3. Set the **Mode** switch to **TAPE**. (SC-D353/D354/D355 only)
4. Turn on the TV and set the TV/VIDEO selector on the TV to Video.
Refer to the TV user's manual.
5. Play the tape.

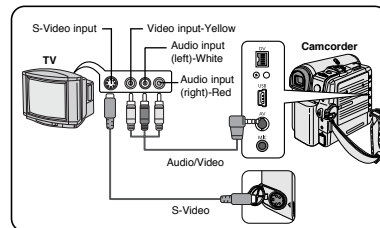

[Notes]

- You may use an S-Video (optional) cable to obtain better quality pictures if you have a S-Video connector on your TV.
- Even if you use an S-Video (optional) cable, you need to connect an audio cable.
- If you connect the cable to the Audio/Video jack, you will not hear sound from the Camcorder's speakers.
- If only a mono audio input is available on the TV set, use the audio cable with the white jack(Audio L).

Playback

Connecting to a TV which has no Audio and Video Input Jacks

- ❖ You can connect your Camcorder to a TV through a VCR.
1. Connect the Camcorder to your VCR with the Audio/Video cable.
 - The yellow jack: Video
 - The white jack: Audio(L) - Mono
 - The red jack: Audio(R)
 2. Connect a TV to the VCR.
 3. Set the **Power** switch to **PLAYER**.
 4. Set the **Mode** switch to **TAPE**. (SC-D353/D354/D355 only)
 5. Turn on both the TV and VCR.
 - Set the input selector on the VCR to Line.
 - Select the channel reserved for your VCR on the TV set.
 6. Play the tape.

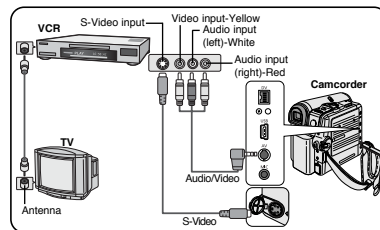

Playback

- ❖ You can play the recorded tape in Player mode.
1. Connect a power source and set the **Power** switch to **PLAYER**.
 2. Set the **Mode** switch to **TAPE**. (SC-D353/D354/D355 only)
 3. Insert the tape you wish to play back.
 4. Using the ◀/▶ (REW/FF) buttons, find the first position you wish to play back.
 5. Press the ▶/|| (PLAY/STILL) button.
 - The images you recorded will appear on the TV after a few seconds.
 - If a tape reaches its end while being played back, the tape will rewind automatically.

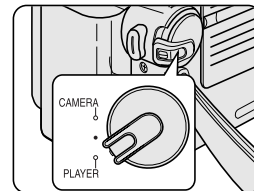

[Notes]

- The playback mode (SP/LP) is selected automatically.
- If the VCR has an S-Video input terminal, you may use S-Video for better quality.
- The S-Video terminal transmits video only. Connect audio cables for sound.
- If only a mono audio input is available on the TV set, use the audio cable with the white jack(Audio L).

Playback

Various Functions while in Player Mode

- ❖ This function works only in Player mode.
- ❖ The PLAY, STILL, STOP, FF, REW buttons are located on the Camcorder and the remote control. (SC-D354/D355 only)
- ❖ The F.ADV(Frame advance), X2, SLOW buttons are located on the remote control only. (SC-D354/D355 only)
- ❖ To prevent tape and head-drum wear, your Camcorder will automatically stop if it is left in still or slow modes for more than 3 minutes.

Playback Pause

- Press the ►/|| (PLAY/STILL) button during playback.
- To resume playback, press the ►/|| (PLAY/STILL) button.

Picture Search (Forward/Reverse)

- Press the ◀◀/▶▶ (REW/FF) buttons during playback or still mode.
To resume normal playback, press the ►/|| (PLAY/STILL) button.
- Keep pressing ◀◀/▶▶ (REW/FF) buttons during playback or still mode.
To resume normal playback, release the button.

Slow Playback (Forward/Reverse) (SC-D354/D355 only)

- Forward Slow playback
 - Press the **SLOW** button on the remote control during playback.
 - To resume normal playback, press the ►/|| (PLAY/STILL) button.
- Reverse Slow Playback
 - Press the ◀◀(-) button during forward slow play back.
 - To resume forward slow playback, press the ▶▶(+). button.
 - To resume normal playback, press the ►/|| (PLAY/STILL) button.

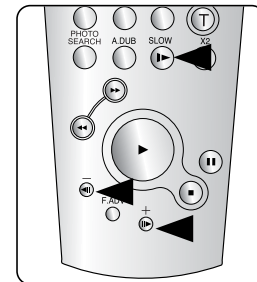
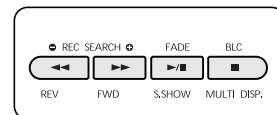

<SC-D354/D355 only>

Playback

Frame Advance (To play back frame by frame) (SC-D354/D355 only)

- Press the **F.ADV** button on the remote control while in still mode.
 - Video sequence advances frame by frame each time you press the **F.ADV** button.
 - The F.ADV function works in still mode only.
- To resume normal playback, press the **▶/||** (PLAY/STILL) button.
 - Forward frame advance
 - Press the **F.ADV** button on the remote control in still mode.
 - Reverse frame advance
 - Press the **◀|| (-)** button on the remote control to change the direction in F.ADV mode.
 - Press the **F.ADV** button on the remote control.

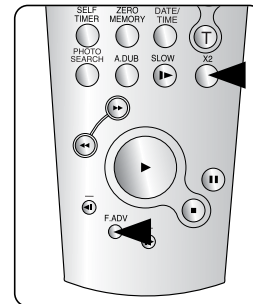

<SC-D354/D355 only>

X2 Playback (Forward/Reverse) (SC-D354/D355 only)

- Forward X2 playback
 - Press the **X2** button on the remote control during playback.
 - To resume normal playback, press the **▶/||** (PLAY/STILL) button.
- Reverse X2 playback
 - Press the **◀|| (-)** button during forward X2 playback.
 - To resume normal playback, press the **▶/||** (PLAY/STILL) button.

Reverse Playback (SC-D354/D355 only)

- To playback in reverse at normal speed, press the **◀|| (-)** button during normal forward playback.
- Press the **▶/||** (PLAY/STILL) or **||▶ (+)** button to return to normal forward playback.

[Notes]

- Mosaic shaped distortion may appear on the screen while in some of the various playback modes. Mosaic shaped distortion or noise may be experienced when you play back tapes recorded in LP which contain various playback functions.
- Sound will only be heard during normal SP or LP playback.

Playback

Zooming during Playback (PB ZOOM)

- ❖ The Playback Zoom function works in Player mode.
- ❖ The Playback Zoom function enables you to magnify the playback or still image.

1. Set the **Power** switch to **PLAYER**.
2. Set the **Mode** switch to **TAPE**. (SC-D353/D354/D355 only)
3. Press the **PB ZOOM** button in playback mode or in still mode.
4. The image is magnified starting from the center of image.
5. You can zoom in from **1.2x** to **8.0x** by moving the Zoom lever.
 - Zoom ratio is not displayed on the screen.
6. To cancel the playback Zoom function, press the **PB ZOOM** or **■** (STOP) button.

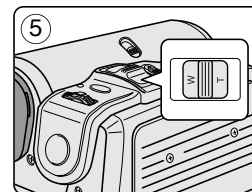
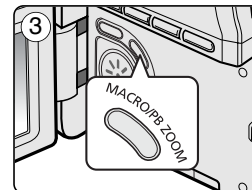

[Notes]

- The PB ZOOM function enlarges the center of the screen only.
- You cannot apply the Playback Zoom function to pictures which are being input from an external video source.
- The Playback Zoom image cannot be imported to your PC from the Camcorder's DV jack.
- The PB ZOOM images cannot be exported to a PC.
- OSD will not be displayed on the LCD screen while the PB ZOOM function is being operated.
To display OSD, press the PB ZOOM button once to stop operating PB ZOOM function, or press the **■** (STOP) button to stop playback.

Playback

AV In/Out (SC-D355 only)

- ❖ AV In/Out function works only in Player mode.
- ❖ AV in/out setting enables you to record signal from external sources and display it on LCD screen. Also, you can direct your video or image to external devices to record or play back.

1. Connect the Camcorder to your VCR or TV with the Audio/Video cable. (See pages 71~72)
2. Set the **Mode** switch to **TAPE**.
3. Set the **Power** switch to **PLAYER**.
4. Turn on the VCR or TV.
5. Insert the blank tape with protection tab closed into the Camcorder.
 - If you want to record from a connected VCR, insert a recorded VHS tape into the VCR.
6. Press the **MENU** button.
 - The menu list will appear.
7. Move the **Menu selector** to the left or right to select **Record**, then press the **Menu selector**.
8. Move the **Menu selector** to the left or right to select **AV In/Out**, then press the **Menu selector**.
9. Move the **Menu selector** to the left or right to select **In**, then press the **Menu selector**.
 - If you want to see the Camcorder picture with a TV, set AV In/Out menu to Out.
10. To exit, press the **MENU** button.
11. Press the **Start/Stop** button to set the Camcorder to **REC PAUSE** mode.
 - **PAUSE** appears on the LCD screen.
12. Select the TV program or playback the VHS tape.
13. Press the **Start/Stop** button to start recording.
 - If you want to pause recording for a while, press the **Start/Stop** button again.
14. To stop recording, press the ■ (STOP) button.

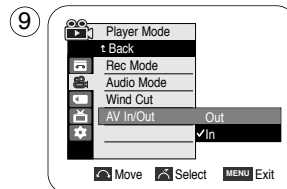
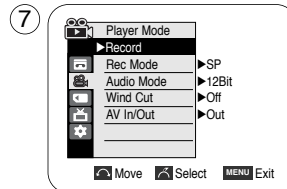
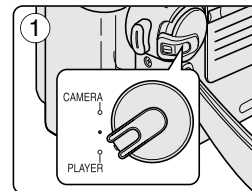

[Note]

When you record the images being played back on an analog VCR, if they are not being played back at normal speed, (for example, more than double speed or slow playback), only a gray image appears on the Camcorder.

Playback

Audio Dubbing (SC-D354/D355 only)

- ❖ The Audio Dubbing function works only in Player Mode.
- ❖ You can not dub sound on a pre-recorded tape in LP or 16 bit mode.
- ❖ You can add sound to the original sound on a pre-recorded tape recorded in SP mode with 12bit sound.
- ❖ Use the internal or an external microphone(not supplied) or other audio equipment.
- ❖ The original sound will not be erased.

Dubbing Sound

1. Set the **Power** switch to **PLAYER**.
 - If you want to use an external microphone, connect the microphone to the external MIC input jack on the Camcorder.
2. Set the **Mode** switch to **TAPE**.
3. Press the **▶/||** (PLAY/STILL) button and find the time frame of the scene to be dubbed.
4. Press the **▶/||** (PLAY/STILL) button to pause the scene.
5. Press the **A.DUB** button on the remote control.
 - Audio Dubbing icon () will be displayed on the LCD screen.
 - The Camcorder is ready for dubbing.
6. Press the **▶/||** (PLAY/STILL) button to start dubbing.
 - Press the **■** (STOP) button to stop the dubbing.

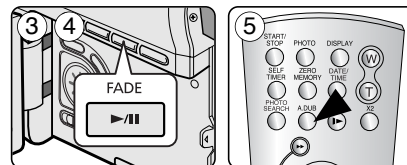
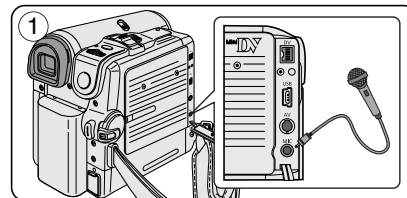

[Notes]

- You can not use the Audio Dubbing function while playing a write protected video tape.
- To utilize an external MIC or sound source, connect a microphone to the MIC jack or use the AV cable to connect external sound source input.
- To dub an external sound source, set the AV In/Out function to AV In (SC-D355 only). (see page 76).

Playback

Dubbed Audio Playback

1. Set the **Power** switch to **PLAYER**.
2. Set the **Mode** switch to **TAPE**. (SC-D353/D354/D355 only)
3. Insert the dubbed tape and press the **MENU** button.
4. Move the **Menu selector** to the left or right to select **Tape**, then press the **Menu selector**.
5. Move the **Menu selector** to the left or right to select **Audio Select**, then press the **Menu selector**.
6. Move the **Menu selector** to the left or right to select the audio playback channel, then press the **Menu selector**.
 - Sound[1]: play the original sound.
 - Sound[2]: play the dubbed sound.
 - MIX[1+2]: play back sound1 and 2 equality mixed.
7. To exit, press the **MENU** button.
8. Press the **▶/||** (PLAY/STILL) button to playback the dubbed tape.

[Note]

When you playback added sound (Sound 2 or MIX mode), you may experience a loss of sound quality.

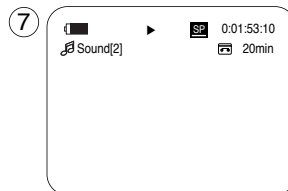
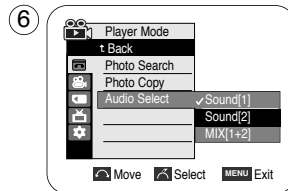
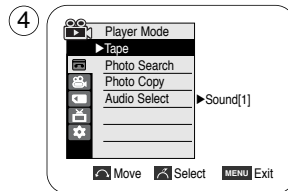

IEEE 1394 Data Transfer

Transferring IEEE1394 (i.LINK)-DV Standard Data Connections

Connecting to a DV Device (DVD Recorder, Camcorder, etc.)

- Connecting to other DV standard products.
A standard DV connection is quite simple.
If a product has a DV port, you can transfer data by connecting to the DV port using the correct cable.
!!! Please be careful since there are two types of DV ports, (4pin, 6pin). This Camcorder has a 4pin terminal.
- With a digital connection, video and audio signals are transmitted in digital format, allowing high quality images to be transferred.

Connecting to a PC

- If you want to transmit data to a PC, you must install an IEEE 1394 add-on card into the PC. (not supplied)
- The frame rate for video capture is dependent on the capacity of the PC.

[Notes]

- When you transmit data from the Camcorder to another DV device, some functions may not work.
If this occurs, please reconnect the DV cable or turn the power OFF and ON again.
- When you transmit data from the Camcorder to PC, PC function button is not available in M.Player mode.
- Do not use the Camcorder and IEEE1394 together as this will cause IEEE1394 to shut off.
- Do not connect the Camcorder to a PC using both DV and USB cables. It may not operate properly.
- Operation is not guaranteed for all computer environments recommended above.
- The IEEE1394 cable (DV cable) is sold separately.
- Video Capture software is commercially available.
- Most DV enabled PCs have a 6 pin socket. In this case, a 6pin/4pin cable is required for the connection.
- Most DV enabled Notebooks and Laptops have a 4 pin socket. Use a 4pin/4pin cable for the connection.
- DIS and COLOR NITE SHUTTER are not available when in DV (IEEE1394) mode.
- If DV(IEEE1394) mode is set, DIS and COLOR NITE SHUTTER modes will be released.

IEEE 1394 Data Transfer

System Requirements

- CPU: faster Intel® Pentium III™ 450MHz compatible.
- Operating system: Windows® 98SE, ME, XP, Mac OS (9.1~10.2)
- Main memory: more than 64 MB RAM
- IEEE1394 add-on card or built in IEEE1394 card

Recording with a DV Connection Cable

1. Set the **Power** switch to **PLAYER**.
2. Set the **Mode** switch to **TAPE**. (SC-D353/D354/D355 only)
3. Connect the DV cable (not supplied) from the DV jack of the Camcorder to the DV jack of the other DV device.
 - Make sure that **DV** is displayed on the LCD screen.
4. Press the **Start/Stop** button to begin **REC PAUSE** mode.
 - **PAUSE** is displayed on the LCD screen.
5. Start playback on the other DV device while you monitor the picture.
6. Press the **Start/Stop** button to start recording.
 - If you want to pause recording momentarily, press the **Start/Stop** button again.
7. To stop recording, press the **■** (STOP) button.

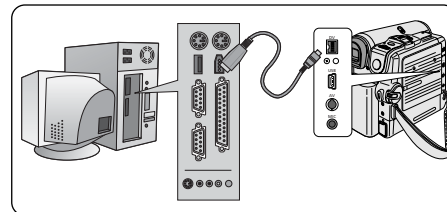

[Notes]

- When using this Camcorder as a recorder, the pictures that appear on a monitor may seem uneven, however recorded pictures will not be affected.
- Operation is not guaranteed for all the recommended computer environments mentioned above.

USB Interface (SC-D352/D353/D354/D355 only)

Transferring a Digital Image through a USB Connection

- ❖ The camcorder supports both USB 1.1 and 2.0 standards. (Depends on the PC specification)
- ❖ You can easily transfer a image from a Memory card to a PC without additional add-on cards via a USB connection.
- ❖ You can transfer a recorded file in memory card to a PC via a USB connection. (SC-D353/D354/D355 only)
- ❖ If you transfer data to a PC, you need to install the software (DV Driver, Video Codec , DirectX 9.0) supplied with the Camcorder.

USB Connection speed depending on the System

High speed USB connection is supported by Microsoft (Windows) device drivers only.

- Windows 98SE/ME - Full Speed USB
- Windows 2000 - High speed USB on a system with Service Pack 4 or later installed.
- Windows XP - High speed USB on a system with Service Pack 1 or later installed.



System Requirements

	Windows System	
	Minimum	Recommended
CPU	Intel® Pentium III™, 600MHz	Intel® Pentium 4™, 2GHz
OS(Operating System)	Windows® 98SE/ME	Windows® 2000/XP
Memory	128MB	512MB
HDD capacity	1GB or more	2GB or more
Resolution	1024 x 768 dots 24bit Color	1024 x 768 dots 24bit Color
USB	USB1.1	USB2.0 High Speed

- It is not available for Macintosh systems.

[Notes]

- USB 2.0 works only for removable disk functions.
- On a slower PC than recommended, movie playback may not be smooth or video editing may take a long time.
- On a slower PC than recommended, movie playback may skip frames or operate unexpectedly.
- Intel® Pentium III™ or Pentium 4™ is a trademark of the Intel Corporation.
- Windows® is a registered trademark of the Microsoft® Corporation.
- All other brands and names are property of their respective owners.
- Operations are not guaranteed for all of the recommended computer environments mentioned above.
- Do not connect the Camcorder to a PC using both DV and USB cables. It may not operate properly.
- In M.Cam or M.Player mode, be sure that the Memory card is inserted into Camcorder before connecting USB cable.
If no Memory card or an unformatted Memory card is inserted, PC will not recognize your Camcorder as a removable disk. (SC-D353/D354/D355 only)
- USB Streaming requires Video Codec, DV Driver and DirectX 9.0.
- If you disconnect the USB cable from the PC or the Camcorder during the data transfer, the data transfer will stop and the data may be damaged.
- If you connect the USB cable to a PC using a USB HUB or with other devices at the same time, it may cause conflict and may not work properly. If this occurs, remove all other USB devices and try the connection again.

USB Interface (SC-D352/D353/D354/D355 only)

Selecting the USB Device (SC-D353/D354/D355 only)

- ❖ USB Select function works only in M.Player mode.
- ❖ Using the USB cable, you can connect your Camcorder to a computer to copy your movies and images from the Memory card (or built-in memory;SC-D354/D355), or to a printer to print your images.

1. Set the **Power** switch to **PLAYER**.
2. Set the **Mode** switch to **MEMORY CARD**.
3. Press the **MENU** button.
 - The menu list will appear.
4. Move the **Menu selector** to the left or right to select **System**, then press the **Menu selector**.
5. Move the **Menu selector** to the left or right to select **USB Connect**, then press the **Menu selector**.
6. Move the **Menu selector** to the left or right to select **Computer** or **Printer**, then press the **Menu selector**.
 - You can select Computer to use the Camcorder as a PC Camera, USB Stream or removable disk.
 - You can select Printer to use the Pictbridge feature (see page 110).
7. To exit, press the **MENU** button.

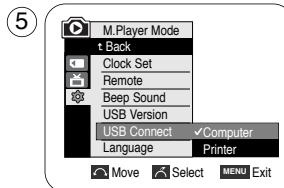
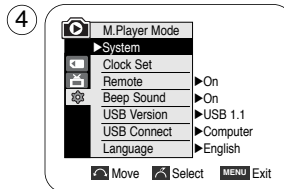
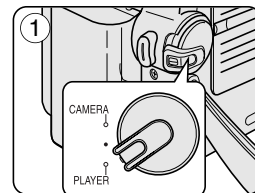

USB Interface (SC-D352/D353/D354/D355 only)

Setting the USB Communication Speed (SC-D352/D354/D355 only)

- ❖ To ensure proper communication between the camcorder and a PC, please set the USB Version before connecting the camcorder to a PC.
- ❖ It is available only in M.Cam and M.Player modes.

1. Set the **Power** switch to **CAMERA** or **PLAYER**.
2. Set the **Mode** switch to **MEMORY CARD**.
3. Press the **MENU** button.
 - The menu list will appear.
4. Move the **Menu selector** to the left or right to select **System**, then press the **Menu selector**.
5. Move the **Menu selector** to the left or right to select **USB Version**, then press the **Menu selector**.
 - Set the USB Version to USB 2.0 when it is supported by both PC and its OS (Operating System).
 - If either the PC or OS does not support USB 2.0, set the USB Version to USB 1.1.
6. To exit, press the **MENU** button.

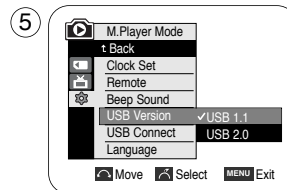
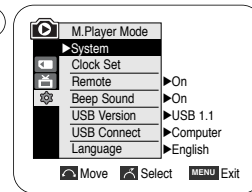
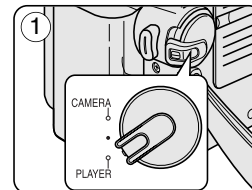

[Notes]

- When the USB Version is not set properly, the USB connection may not be established.
- USB 2.0 may not be supported by certain PCs depending on their specifications. In this case, choose the USB 1.1 for USB connection.
- When selected USB 2.0 is not supported by the PC, the USB 1.1 will be used for the USB connection automatically.

USB Interface (SC-D352/D353/D354/D355 only)

Installing DV Media PRO 1.0 Program

- ❖ To play back MPEG moving pictures recorded by the camcorder or streaming data transferred through the USB connection on a PC, the Video Codec program should be installed.
- ❖ Do not connect the Camcorder to PC before installing the program.
- ❖ If another Camcorder or scanner is connected, please disconnect it in advance.
- ❖ This explanation is based on Windows® 98SE OS.
- ❖ DV Media Pro User's Manual is included on the accompanying CD(D:\help\ in Adobe's Portable Document Format(PDF) The user's manual can be viewed using Acrobat Reader software, which is also included on the CD (D:\Support\AcrobatReader\AcroReader51_ENU_full.exe). (The Acrobat Reader is a freeware product of AdobeSystems,Inc.)
- ❖ DV Media Pro User's Manual is in English.

Program Installation

1. Insert the software CD into the CD-ROM drive of your computer.
Installation selection screen appears on the monitor.
2. If the installation selection screen does not appear after inserting the CD, click "Run" in the Windows "Start" menu and execute Autorun.exe file to begin installation.
When CD-ROM drive is set to "D:drive", type "D:\autorun.exe" and press Enter.
3. Click the icons listed below to install the selected software.
 - DV Driver Click
 - USB removable Disk Driver (Windows® 98SE only)
 - USB PC CAMERA & STREAMING Driver (CAPTURE DRIVER)
 - Connect a Camcorder to your PC to complete the DV Driver installation.
 - 1) Set the camcorder Power switch to CAMERA.
 - 2) Set the camcorder Mode switch to TAPE. (SC-D353/D354/D355 only)
 - 3) Connect the camcorder to the PC using the USB cable.
 - 4) The SAMSUNG A/V Capture driver installation begins on the PC.
 - DirectX 9.0 Click
 - Video Codec Click

The Video Codec needs to be installed in order to playback the MPEG4 Movies (stored in the Memory Card) on a PC or to use the USB Streaming/PC Camera functions.



USB Interface (SC-D352/D353/D354/D355 only)

Using the PC Camera Function

- ❖ To use the PC Camera function, the DV Driver, Video Codec and DirectX 9.0. programs must be installed in the PC.
- ❖ You can use this Camcorder as a PC CAMERA.
- ❖ When you connect to a Web site that provides video chatting functions, you can use your Camcorder for such functions.
- ❖ When using this camcorder for video conferencing (such as NetMeeting), voice communication may not be supported depending on the video conferencing software. In this case, connect an external microphone to the soundcard of the PC to enable voice communication.
- ❖ Using the Camcorder with PC Net-meeting program installed, you can participate in video conference.
- ❖ The PC CAMERA's screen size (Transferred video frame rate for the PC Camera function is max 15 fps.)
- ❖ If PC is connected with the USB to the Camcorder, only the Power, Mode, Zoom and NITE PIX switches can be operated. (SC-D352/D354/D355 only)

1. Set the **Power** switch to **CAMERA**.
2. Set the **Mode** switch to **TAPE**. (SC-D353/D354/D355 only)
3. Connect one end of the USB cable to the USB jack on the Camcorder and the other end to the USB connector on your computer.

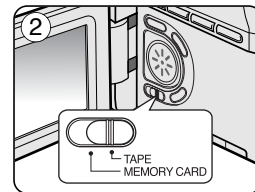
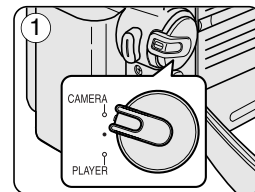

USB Interface (SC-D352/D353/D354/D355 only)

Using the USB Streaming Function

- ❖ To use USB streaming, the DV Driver, Video Codec and DirectX 9.0. programs must be installed in the PC.
 - ❖ You can view Camcorder video on your PC using USB streaming.
 - ❖ You can also store it as a moving picture in the "avi" file format, or as a still image in the "jpg" file format on a PC.
1. Set the **Mode** switch to **TAPE**(SC-D353/D354/D355 only), set the **Power** switch to **CAMERA** or **PLAYER**.
 2. Connect one end of the USB cable to the USB jack on the Camcorder and the other end to the USB port on your computer.
 3. Setup and execute Windows Movie Maker or the Ulead VIDEO Studio Software application provided on the CD.
 - For detailed instructions for Ulead VIDEO Studio use, refer to the program's Help function.
 - Windows Movie Maker is used for WINDOWS ME and XP users. (C:\program files\Movie maker\moviemk.exe)

Using the removable Disk Function (SC-D353/D354/D355 only)

- ❖ You can easily transfer data from a Memory card to a PC without additional add-on cards via a USB connection.
1. Set the **Mode** switch to **MEMORY CARD**, set the **Power** switch to **CAMERA** or **PLAYER**.
 2. Connect one end of the USB cable to the USB jack on the Camcorder and the other end to the USB port on your computer.
 3. To verify whether the removable disk has been properly recognized, open Windows Explorer and locate the removable disk.

Connecting to a PC

1. Connect a USB cable to the USB port on the PC.
 - If a USB cable is connected to the Camcorder's USB port, nothing is displayed on a TV.
2. Connect the other end of the USB cable into the USB jack on the Camcorder. (USB jack)
 - If a PC is connected to the Camcorder with a USB cable only, Zoom switch and NITE PIX (SC-D352/D354/D355 only) operate.

Disconnecting the USB Cable

- ❖ After completing the data transmission, you must disconnect the cable in the following way:
1. Select the removable disc icon and click the right mouse button to select [Eject].
 2. Select [Confirm] and disconnect the USB cable when the Windows Splash screen appears.

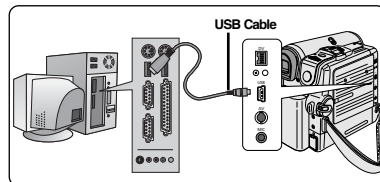

[Notes]

- If you disconnect the USB cable from the PC or the Camcorder while transferring, the data transmission will stop and the data may be damaged.
- If you connect the USB cable to a PC via a USB HUB or simultaneously connect the USB cable along with other USB devices, the Camcorder may not work properly. If this occurs, remove all USB devices from the PC and reconnect the Camcorder.

Digital Still Camera Mode (SC-D353/D354/D355 only)

Memory Stick (Optional Accessory)



- ❖ The Memory Stick stores and manages images recorded by the Camcorder.

Memory STICK Functions

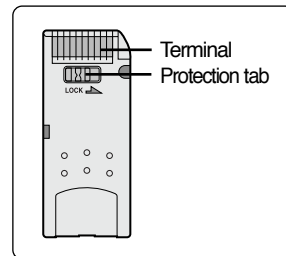
- Recording still images and MPEG4 movies
- Viewing still images and MPEG4 movies
 - Single
 - Slide show (Still images only)
 - Multi display (Still images only)
- Protecting images against accidental erasure
- Deleting images recorded on a Memory Stick
- Print marking still images
- Formatting a Memory Stick



[Notes]

- You can use most of the Camcorder's functions when recording to the Memory Stick.
-   appears on the screen while recording to the Memory Stick.
- While recording or loading an image, do not eject or insert the Memory Stick.
Inserting or ejecting a Memory Stick while recording or loading an image can cause data damage.
- If you want to save all images on the Memory Stick, set the write protect tab on the Memory Stick to LOCK.



MEMORY STICK™

- "Memory Stick" and  are trademarks of Sony Corporation.
- All other product names mentioned herein may be the trademarks or registered trademarks of their respective companies.
Furthermore, "™" and "®" are not mentioned in each case in this manual.

Digital Still Camera Mode (SC-D353/D354/D355 only)

Inserting and Ejecting the Memory Card

Inserting the Memory card

1. Set the **Power** switch to **Off**.
2. Open the Memory card cover.
3. Insert the Memory card in the direction of the arrow into the Memory card slot located on the bottom of the Camcorder.

Ejecting the Memory card

1. Set the **Power** switch to **Off**.
2. Open the Memory card cover.
3. Push the Memory card, then it comes out of the Camcorder automatically.
4. Pull out the Memory card.
Do not attempt to pull the Memory card out without first pushing it in.

[Notes]

- Memory Stick Duo type or RS-MMC (SC-D355 only) should be inserted by using the Adaptor (not supplied).
- If you set the Camcorder to M.Player mode, the last recorded still image appears. If there are no recorded images on the Memory card, **No image!** will display on the screen.
- While recording, loading, erasing or formatting, do not turn off the power or change the mode.
- Please turn the power off before you insert or eject the Memory card.
You could lose data on the Memory card.
- Do not allow metal substances to come in contact with the terminals of the Memory card.
- Do not bend, drop or apply strong shock to Memory card.
- After pulling the Memory card out from the Camcorder, please keep the Memory card in a soft case to prevent static shock.
- The stored contents may be changed or lost as a result of misuse, static electricity, electric noise or repair.
Save important images separately.
- Samsung is not responsible for data loss due to misuse.

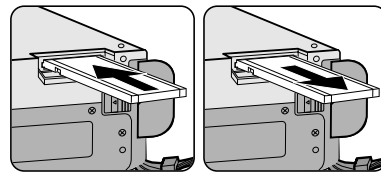

SC-D353/D354 only



Memory Stick
Memory Stick PRO

SC-D355 only



Memory Stick
Memory Stick PRO



SD/MMC

(Usable Memory card)

Digital Still Camera Mode (SC-D353/D354/D355 only)

Structure of Folders and Files on the Memory Card

- ❖ The still images that you recorded are saved in JPEG file format on the Memory card.
- ❖ The moving images that you recorded are saved in MPEG4 file format on the Memory card.
- ❖ Each file has a file number and all files are assigned to a folder.
 - A file number from DCAM0001 is sequentially assigned to each recorded image.
 - Each folder is numbered from 100SSDVC and recorded on the Memory card.

Image Format

Still Image

- Images are compressed in JPEG (Joint Photographic Experts Group) format.
- The picture size is 800x600 (Tape Capture 640x480).

Moving Image

- Images are compressed in MPEG 4(Moving Picture Experts Group) format.
- The picture size is 720x480.

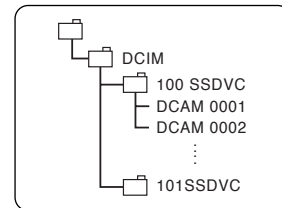

<Still image>

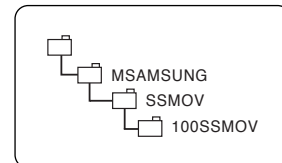

<Moving image>

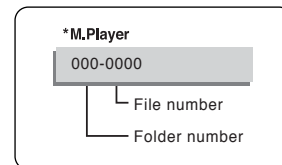

Selecting the Camcorder Mode

- ❖ You can use this Camcorder as a Digital Still Camera (DSC).
- ❖ You have to set the Mode switch to Memory card to use this Camcorder as Digital Still Camera.

M.Cam mode (Memory record mode)

1. Set the **Power** switch to **CAMERA**.
2. Set the **Mode** switch to **MEMORY CARD**.

M.Player mode (Memory playback mode)

1. Set the **Power** switch to **PLAYER**.
2. Set the **Mode** switch to **MEMORY CARD**.

Digital Still Camera Mode (SC-D353/D354/D355 only)

Selecting the Built-in Memory (SC-D354/D355 only)

- ❖ Built-in memory setting is available in the Player/M.Cam/M.Player modes. (SC-D354: 32MB/SC-D355: 64MB)
- ❖ Images can be stored and played back using the built-in memory.
Hence, set the memory type before storing and playing back images.

1. Set the **Power** switch to **CAMERA** or **PLAYER**.
2. Set the **Mode** switch to **TAPE** or **MEMORY CARD**.
3. Press the **MENU** button.
 - The menu list will appear.
4. Move the **Menu selector** to the left or right to select **Memory**, then press the **Menu selector**.
5. Move the **Menu selector** to the left or right to select **Memory Type**, then press the **Menu selector**.
6. Move the **Menu selector** to the left or right to select **Int. Memory** or **Memory card**, then press the **Menu selector**.
7. To exit, press the **MENU** button.

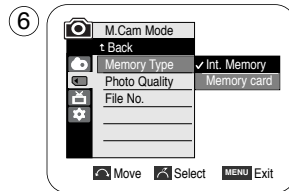
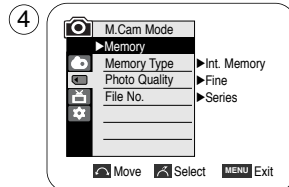

Using Quick Menu: Memory Type

1. Press the **Menu selector**.
2. Move the **Menu selector** to left or right to select **Memory Type**, then press the **Menu selector**.
3. Move the **Menu selector** to the left or right to select **Int. Memory** or **Memory card**, then press the **Menu selector**.
4. To exit, press the **MENU** button.

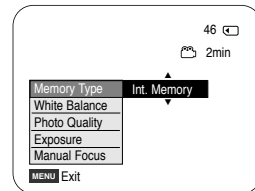

Digital Still Camera Mode (SC-D353/D354/D355 only)

Selecting the Image Quality

- ✦ You can select the quality of a still images to be recorded.

Select the Image Quality

1. Set the **Power** switch to **CAMERA**.
2. Set the **Mode** switch to **MEMORY CARD**.
3. Press the **MENU** button.
 - The menu list will appear.
4. Move the **Menu selector** to the left or right to select **Memory**, then press the **Menu selector**.
5. Move the **Menu selector** to the left or right to select **Photo Quality**, then press the **Menu selector**.
6. Move the **Menu selector** to the left or right to select desired image quality(**Super Fine**, **Fine**, **Normal**), then press the **Menu selector**.
7. To exit, press the **MENU** button.
 - The selected icon will be displayed

Number of Images on the Memory Card

QUALITY	8MB	16MB
Super Fine	Approx. 34	Approx. 68
Fine	Approx. 45	Approx. 90
Normal	Approx. 74	Approx. 148

The actual number of images that you can record varies depending on the nature of the subject to be recorded.

[Notes]

- The above approximation is based on a 8MB Memory Stick under normal recording conditions.
- The number of pictures that can be stored on a memory card depends on various conditions.

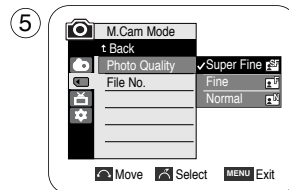
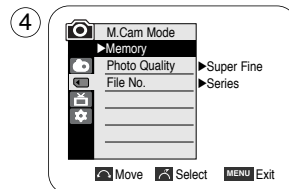
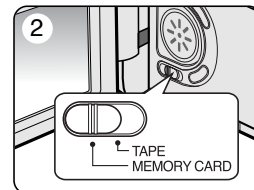

Digital Still Camera Mode (SC-D353/D354/D355 only)

Using Quick Menu: Photo Quality

- ❖ Quick menu is used to access Camcorder functions by using the Menu selector.
- ❖ Quick menu provides easier access to frequently used menus without using the MENU button.

1. Press the **Menu selector**.
2. Move the **Menu selector** to left or right to select **Photo Quality**, then press the **Menu selector**.
3. Move the **Menu selector** to the left or right to select desired image quality(**Super Fine**, **Fine**, **Normal**), then press the **Menu selector**.
4. To exit, press the **MENU** button.

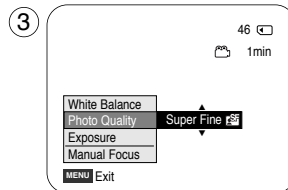
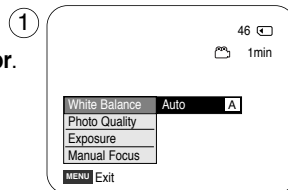

Digital Still Camera Mode (SC-D353/D354/D355 only)

Memory File Number

- ❖ File number setting works only in M.Cam mode.
- ❖ File numbers are given to images in the order they were recorded when they are stored on the Memory card.
- ❖ Memory file numbers may be set as follows:
 - Series: When there are existing files, the new image will be named as the next number in the sequence.
 - Reset: When there are no files stored on the Memory card, the file numbering starts from 0001.

1. Set the **Power** switch to the **CAMERA**.
2. Set the **Mode** switch to **MEMORY CARD**.
3. Press the **MENU** button.
 - The menu list will appear.
4. Move the **Menu selector** to the left or right to select **Memory**, then press the **Menu selector**.
5. Move the **Menu selector** to the left or right to select **File No.**, then press the **Menu selector**.
6. Move the **Menu selector** to the left or right to select desired option (**Series** or **Reset**), then press the **Menu selector**.
7. To exit, press the **MENU** button.

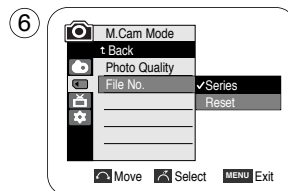
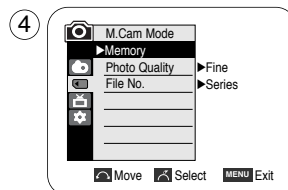

Digital Still Camera Mode (SC-D353/D354/D355 only)

Taking Photos

- ❖ You may take still images while in M.Cam mode and store the images on the Memory card. This function is useful when you want to take a snapshot of a subject while you are using the Camcorder.
- ❖ You can take photos using the remote control.(SC-D354/D355 only)
- ❖ Audio will not be recorded with a Still image on to the Memory Card.

1. Set the **Power** switch to **CAMERA**.
2. Set the **Mode** switch to **MEMORY CARD**.
3. After framing your object to record, fully press the **PHOTO** button to take the picture.
 - The picture is taken and saved into the Memory card within a few seconds.
 - Taking another picture within this interval is not possible.
 - The  indicator appears LCD screen during the time it takes to save the image.

[Notes]

- Still images are saved in the Memory card in an 800x600 format.
- The number of still images that can be stored depends on the quality of the image.

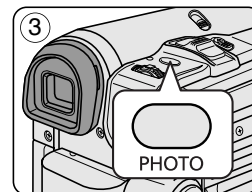
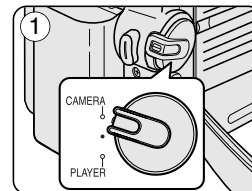

Digital Still Camera Mode (SC-D353/D354/D355 only)

Viewing Still Images

- ❖ This function works only in M.Player mode.
You can playback and view still images recorded on the Memory card.
- ❖ Be sure that the M.Play Select is set to Photo in the Menu.
- ❖ There are 3 ways to view recorded images.
 - Single: To view an image frame by frame.
 - Slide show: To view all images automatically and in consecutive order.
 - Multi display: To view 6 images at once.

To view a Single Image

1. Set the **Power** switch to **PLAYER**.
2. Set the **Mode** switch to **MEMORY CARD**.
 - The last recorded image appears.
 - If there are no recorded images on the Memory card, **No image!** will display on the screen.
3. Using the ◀◀/▶▶ (REV/FWD) buttons, search for the desired still image.
 - To view the next image: press the ▶▶ (FWD) button.
 - To view the previous image: press the ◀◀ (REV) button.
 - Pressing ▶▶ (FWD) when you are on the last image will take you to the first image and pressing ◀◀ (REV) when you are on the first image will take you to the last image.
 - Keep pressing ▶▶ (FWD) or ◀◀ (REV) to search for an image quickly.

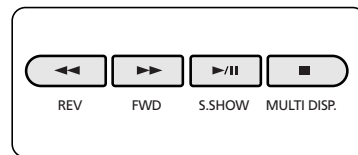

To view a Slide Show

1. Set the **Power** switch to **PLAYER**.
2. Set the **Mode** switch to **MEMORY CARD**.
 - The last recorded image appears.
3. Press the ▶/|| (S.SHOW) button.
 - All images will be played back consecutively for 2~3 seconds each.
 - The "Slide" will be display on the LCD screen.
4. To stop the slide show, press the ▶/|| (S.SHOW) button again.

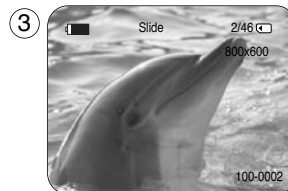

[Notes]

- Loading time may vary depending on the image size.
- The Slide Show will start from the current picture.
- Any large sized image taken with another device will be displayed as a thumbnail image.

Digital Still Camera Mode (SC-D353/D354/D355 only)

To view the Multi Display

1. Set the **Power** switch to **PLAYER**.
2. Set the **Mode** switch to **MEMORY CARD**.
 - The last recorded image appears.
3. To view six stored images on single screen, press the **■ (MULTI DISP.)** button.
 - A selection mark (◀▶) appears under the image.
 - Press ◀▶ (REV/FWD) button to select an image.
4. To return to single playback mode, press the **■ (MULTI DISP.)** button again.
 - Selected picture is displayed in full screen mode.

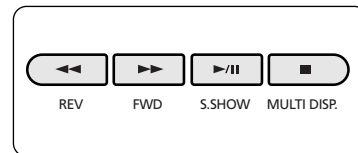
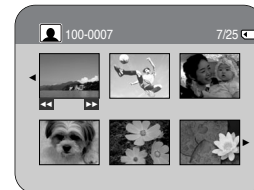

[Notes]

- To display the previous six images, press and hold the ◀ (REV) button for about 3 seconds.
- To display the next six images, press the ▶ (FWD) button for about 3 seconds.
- In order to use Delete, Protect or Print Mark functions in Multi Display view mode, use the Quick Menu by pressing the Menu Selector.

Digital Still Camera Mode (SC-D353/D354/D355 only)

Protection from accidental Erasure

- ❖ The protection function works only in M.Player mode.
- ❖ You can protect important images from accidental erasure.
If you execute format, all images including protected images will be erased.

1. Set the **Power** switch to **PLAYER**.
2. Set the **Mode** switch to **MEMORY CARD**.
 - The last recorded image appears.
 - If there are no recorded images on the Memory card, **No image!** will display on the screen.
3. Using the ◀/▶ (REV/FWD) buttons, search for the still image that you want to protect.
4. Press the **MENU** button.
 - The menu list will appear.
5. Move the **Menu selector** to the left or right to select **Memory**, then press the **Menu selector**.
6. Move the **Menu selector** to the left or right to select **Protect**, then press the **Menu selector**.
7. Move the **Menu selector** to the left or right to select **On**, then press the **Menu selector**.
8. To exit, press the **MENU** button.
 - The protection (🔒) icon will be displayed.

[Notes]

- Protected pictures will show the (🔒) mark when they are displayed.
- If the write protection tab on the Memory card is set to LOCK, you cannot set image protection.

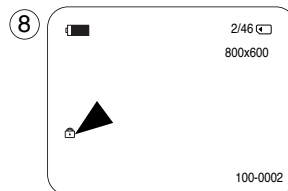
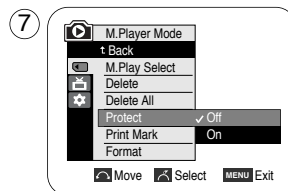
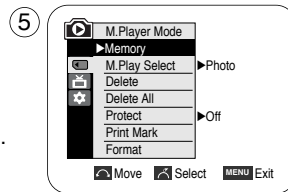

Digital Still Camera Mode (SC-D353/D354/D355 only)

Using Quick Menu: Protect

- ❖ Quick menu is used to access Camcorder functions by simply using the Menu selector.
- ❖ Quick menu provides easier access to the frequently used menus without using the MENU button.

1. Press the **Menu selector**.
2. Move the **Menu selector** to left or right to select **Protect**, then press the **Menu selector**.
3. Move the **Menu selector** to the left or right to select **Off** or **On**, then press the **Menu selector**.
4. To exit, press the **MENU** button.

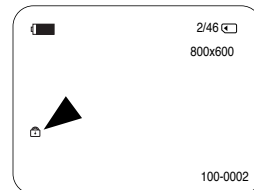
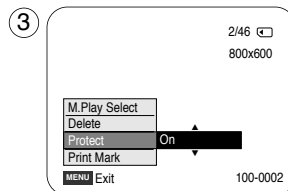
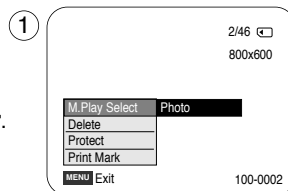

Digital Still Camera Mode (SC-D353/D354/D355 only)

Deleting Still Images and Moving Images

- ❖ The Delete function works only in M.Player mode.
 - ❖ You can erase the still images and moving images recorded on the Memory card.
 - ❖ If you want to delete protected images, you must first deactivate the image protection.
 - ❖ An image which has been deleted cannot be recovered.
1. Set the **Power** switch to **PLAYER**.
 2. Set the **Mode** switch to **MEMORY CARD**.
 3. Using the ◀/▶ (REV/FWD) buttons, search for the still image that you want to delete.
 4. Press the **MENU** button.
 - The menu list will appear.
 5. Move the **Menu selector** to the left or right to select **Memory**, then press the **Menu selector**.
 6. Move the **Menu selector** to the left or right to select **Delete**, then press the **Menu selector**.
 - A message **Do you want to delete?** appears.
 7. Move the **Menu selector** to the left or right to select **Yes** or **No**, then press the **Menu selector**.
 8. To exit, press the **MENU** button.

Deleting All images at once

Move the **Menu selector** to the left or right to select **Delete All**, then press the **Menu selector**. A message **Do you want to delete all?** appears.

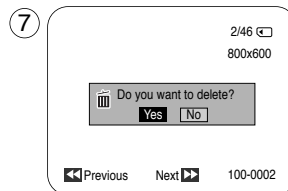
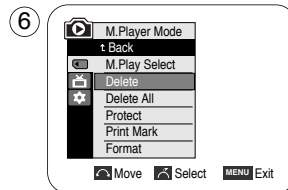
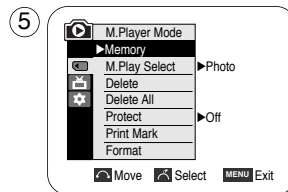

Digital Still Camera Mode (SC-D353/D354/D355 only)

Using Quick Menu: Delete

- ❖ Quick menu is used to access Camcorder functions by simply using the Menu selector.
- ❖ Quick menu provides easier access to the frequently used menus without using the MENU button.

1. Press the **Menu selector**.
2. Move the **Menu selector** to left or right to select **Delete**, then press the **Menu selector**.
3. Move the **Menu selector** to the left or right to select **Cancel** or **Delete**, then press the **Menu selector**.
4. To exit, press the **MENU** button.

[Notes]

- When there is no stored picture on the Memory card, the message **No image!** will be displayed.
- If an erroneous image file is found on the Memory card, the message **Memory card error!** will be displayed.
It may be caused by copying images from different digital devices.
- Formatting the Memory card will delete all the stored images. (see page 101)
- To protect important pictures from accidental deletion, activate the image protection (refer to page 97).
- Deleting all files using the Delete All menu may take a while.
To delete all files much faster, format the memory card after backing up the files into other storage device.

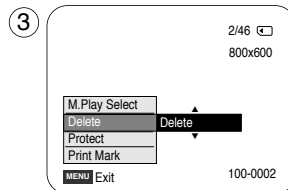
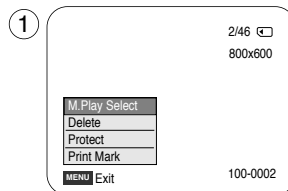

Digital Still Camera Mode (SC-D353/D354/D355 only)

Formatting the Memory Card

- ❖ The Format function works only in M.Player mode.
- ❖ You can use the memory format functions to completely delete all images and options on the Memory card, including protected images.
- ❖ The format function restores the Memory card to its initial state.
- ❖ The Memory card supplied with this Camcorder has been formatted already.

Attention

- ❖ If you execute the memory format function, all images will be erased completely and erased images cannot be recovered.

1. Set the **Power** switch to **PLAYER**.
2. Set the **Mode** switch to **MEMORY CARD**.
3. Press the **MENU** button.
 - The menu list will appear.
4. Move the **Menu selector** to the left or right to select **Memory**, then press the **Menu selector**.
5. Move the **Menu selector** to the left or right to select **Format**, then press the **Menu selector**.
6. Move the **Menu selector** to the left or right to select desired option (**Int. Memory** or **Memory card**), then press the **Menu selector**. (SC-D354/D355 only)
 - If you select Int. Memory or Memory card, a message **All files are deleted! Do you want to format?** appears.
7. Move the **Menu selector** to the left or right to select **Yes**, then press the **Menu selector**.
 - **Complete!** appears when the format is completed.
8. To exit, press the **MENU** button.

[Notes]

- If you execute the Format function, all still images/motion clips will be erased completely and erased still images/motion clips cannot be recovered.
- Formatting the Memory card using a different device will cause Memory card read errors.
- Formatting the Memory card deletes all the stored data in the Memory card.
- Do not turn the power off in the middle of the formatting.
- A Memory Stick with the protection tab set to save will not be formatted. (see page 87)
- Do not format the Memory Card on a PC.
“Not Formatted” message may appear if a Memory Card formatted on a PC was inserted.

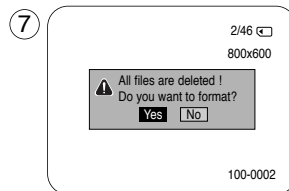
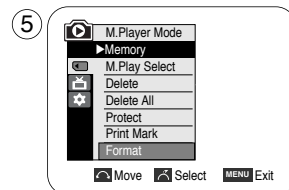
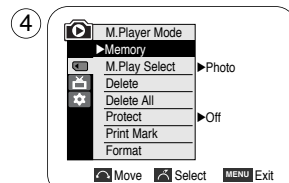

Digital Still Camera Mode (SC-D353/D354/D355 only)

MPEG Recording

- ❖ You can record moving picture images with audio on the Memory card.
- ❖ The screen format of the moving picture to be recorded is 720x480.

Saving Moving Picture Files onto a Memory Card

1. Check whether Memory card is inserted into the Camcorder.
If it is not in the Camcorder, insert it into the slot.
2. Set the **Power** switch to **CAMERA**.
3. Set the **Mode** switch to **MEMORY CARD**.
4. Press the **Start/Stop** button, the images are recorded on the Memory card in MPEG4.
You can record a Camcorder still image on Memory card by pressing the **PHOTO** button instead of the **Start/Stop** button.
5. Press the **Start/Stop** button to stop the recording.

[Notes]

- **MENU button and Menu selector are not available while MPEG recording.**
To use MENU button and Menu selector, stop recording.
MPEG recording is not available when a menu or Quick menu is displayed on the screen.
To start recording, press the MENU button to make it disappear.
- Before using the MPEG REC function, check whether the Memory card is inserted into the Camcorder.
- Moving images that you recorded are saved in *.avi(avi 1.0) file format on the Memory card.
- The files that you recorded are saved in a following folder. (see illustration low right hand corner)
- The moving picture images on a Memory card are a smaller size and lower definition than images on tape.
- The sound is recorded in mono.
- The following functions are not allowed in M.Cam Mode.
DIS (Digital Image Stabilizer), Digital Zoom, Fade, Program AE, Digital Effect, Slow Shutter.
- While recording on a Memory card, don't insert or eject the tape as it may record noise.
- While a Memory card, don't eject the card or it may break the data on the Memory card or Memory card itself.
- Turning the power off while accessing the memory card may damage the data stored on the memory card.

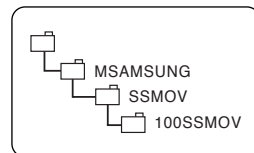
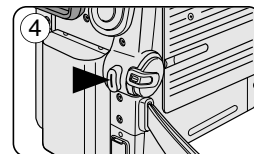
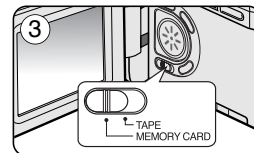
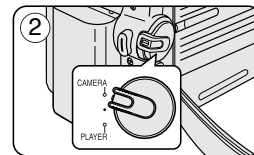

<Moving image>

Digital Still Camera Mode (SC-D353/D354/D355 only)

MPEG Playback

- ❖ The MPEG Playback function works only in M. Player mode.
 - ❖ You can play the moving picture images on the Memory card. Stereo audio is played back at the same time.
 - ❖ Playing back on a PC shows better quality than on a TV.
1. Set the **Power** switch to **PLAYER**.
 2. Set the **Mode** switch to **MEMORY CARD**.
 3. Press the **MENU** button.
 - The menu list will appear.
 4. Move the **Menu selector** to the left or right to select **Memory**, then press the **Menu selector**.
 5. Move the **Menu selector** to the left or right to select **M.Play Select**, then press the **Menu selector**.
 6. Move the **Menu selector** to the left or right to select **Movie**, then press the **Menu selector**.
 7. To exit the menu, push the **MENU** button.
 8. Using the **◀/▶** (REV/FWD) buttons, search for the moving picture that you want to playback.
 9. Press the **▶/||** (PLAY/STILL) button.
 - The moving pictures recorded on the Memory card will playback.
 - You can control playback using the **▶/||** (PLAY/STILL) **◀/▶** (REW/FF) **■** (STOP) buttons.

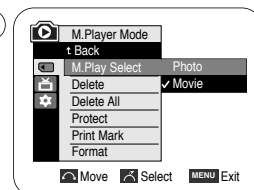
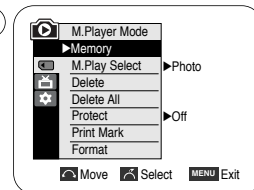
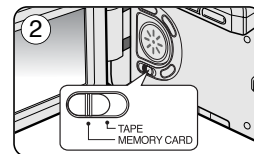

[Notes]

- **MENU** button and **Menu selector** are not available while MPEG playback. To use **MENU** button and **Menu selector**, stop playback. **MPEG playback is not available when a menu or Quick menu is displayed on the screen. To start playback, press the MENU button to make it disappear.**
- There may be broken or mosaic pictures while playing the MPEG4 moving picture images, but it is not malfunction.
- The moving picture images that you recorded on the Memory card may not play on other manufacturer's.
- The MPEG4 file recorded by another Camcorder may not play on by this Camcorder.
- To playback MPEG4 moving pictures on a PC, the Video Codec (in the CD provided with the camcorder) should be installed.
 - You need Microsoft Windows Media Player Version 9 or higher version in order to play MPEG4 file on the Memory card on your PC.
 - You can download the Microsoft Windows Media Player applied each languages on Microsoft Website, "<http://www.microsoft.com/windows/windowsmedia/download/default.asp>".
- Memory Stick PRO provides better image quality than Memory Stick.

Digital Still Camera Mode (SC-D353/D354/D355 only)

Using Quick Menu: M.Play Select

- ❖ Quick menu is used to access Camcorder functions by simply using the Menu selector.
- ❖ Quick menu provides easier access to the frequently used menus without using the MENU button.

1. Press the **Menu selector**.
2. Move the **Menu selector** to the left or right to select **M.Play Select**, then press the **Menu selector**.
3. Move the **Menu selector** to the left or right to select **Photo** or **Movie**, then press the **Menu selector**.
4. To exit, press the **MENU** button.

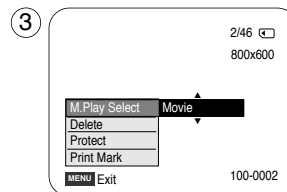
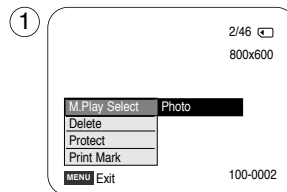

Digital Still Camera Mode (SC-D353/D354/D355 only)

Recording an Image from a Cassette as a Still Image

- ❖ This function works only in Player mode.
- ❖ You can record still images from a cassette on a Memory card.
- ❖ If you want to move recorded multiple still images from a cassette to a Memory card, use the COPY function.

1. Set the **Power** switch to **PLAYER**.
2. Set the **Mode** switch to **TAPE**.
3. Playback the cassette.
4. Press the **PHOTO** button.
 - The still image is recorded on the Memory card.
 - During the time it takes to save an image, the play back screen is paused and the OSD is displayed as illustrated in the lower right hand corner.

[Notes]

- Still images copied from the cassette to the memory card are saved in a 640x480 format.
- Number of images you can save varies depending on the image resolution.

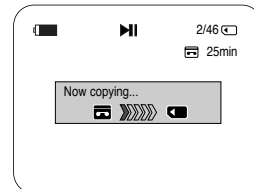
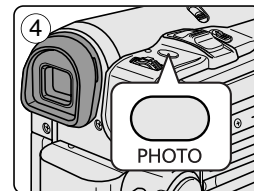
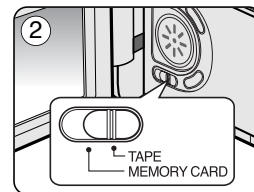
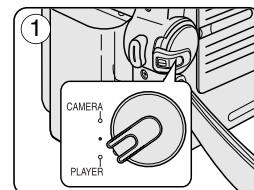

Digital Still Camera Mode (SC-D353/D354/D355 only)

Copying Still Images from a Cassette to Memory Card

- ❖ The photo copy function works only in Player mode.
- ❖ You can copy still images recorded with photo function on a cassette onto a Memory card.
- ❖ Rewind the tape to the point which you wants.

1. Set the **Power** switch to **PLAYER**.
2. Set the **Mode** switch to **TAPE**.
3. Press the **MENU** button.
 - The menu list will appear.
4. Move the **Menu selector** to the left or right to select **Tape**, then press the **Menu selector**.
5. Move the **Menu selector** to the left or right to select **Photo Copy**, then press the **Menu selector**.
 - All still images that recorded on a cassette will be copied into a Memory card.
6. The Camcorder automatically performs the photo search to find still images and copy starts.
7. Press the **■** (STOP) button to stop copying.
 - Copy stops when the cassette is finished or Memory card is full.

[Note]

Still images copied from the cassette to the memory card are saved in 640x480 format.

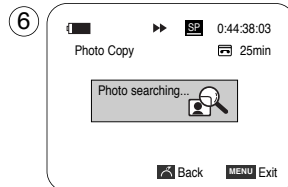
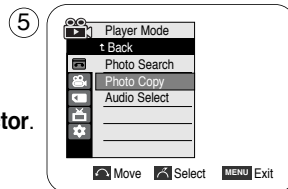
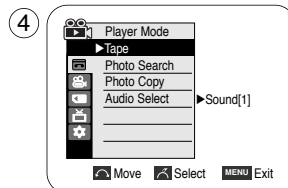

Digital Still Camera Mode (SC-D353/D354/D355 only)

Copy to (Copies Files from the Memory Card to the Built-in Memory) (SC-D354/D355 only)

- ❖ The Copy To function works only in M.Player mode.
- ❖ You can copy selected or all images stored in the Memory card to the built-in memory.

1. Set the **Power** switch to **PLAYER**.
2. Set the **Mode** switch to **MEMORY CARD**.
3. Press the **MENU** button.
 - The menu list will appear.
4. Move the **Menu selector** to the left or right to select **Memory**, then press the **Menu selector**.
5. Move the **Menu selector** to the left or right to select **Copy to**, then press the **Menu selector**.
6. Move the **Menu selector** to the left or right to select options (**Back**, **This File** or **All Files**), then press **Menu selector**.
 - To go back to the previous mode, select **Back**.
 - If This File or All Files is selected, **Now copying...** is displayed on the screen and copying starts.
7. To exit, press the **MENU** button.

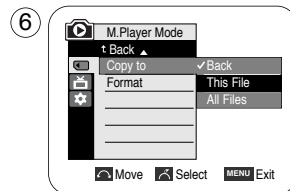
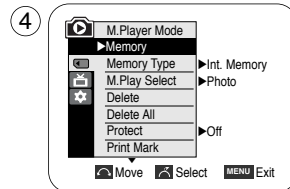
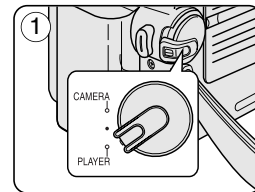

Digital Still Camera Mode (SC-D353/D354/D355 only)

Marking Images for Printing

- ❖ This Camcorder supports the DPOF (Digital Print Order Format) print format.
- ❖ You can automatically print images recorded on a Memory card with a printer supporting DPOF.
- ❖ There are 2 ways to make a Print Mark.
 - This File: You can set a print mark on the photo image displayed on the LCD screen. It can be set up to 999.
 - All Files: To print 1 copy each of all of the stored images.

1. Set the **Power** switch to **PLAYER**.
2. Set the **Mode** switch to **MEMORY CARD**.
 - The last recorded image appears.
3. Using the ◀/▶ (REV/FWD) buttons, search for the still image that you want to mark.
4. Press the **MENU** button.
 - The menu list will appear.
5. Move the **Menu selector** to the left or right to select **Memory**, then press the **Menu selector**.
6. Move the **Menu selector** to the left or right to select **Print Mark**, then press the **Menu selector**.
7. Move the **Menu selector** to the left or right to select desired option (**All Off**, **This File** or **All Files**), then press the **Menu selector**.
8. If you select **This File**, move the **Menu selector** to the left or right to select the quantity, then press the **Menu selector**.
9. To exit, press the **MENU** button.

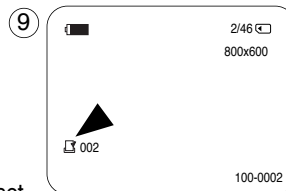
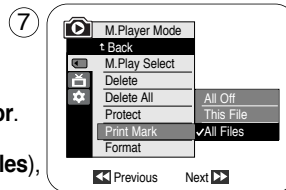
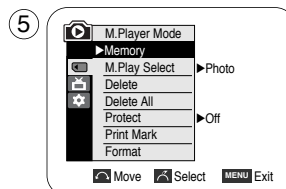

Removing the Print Mark

To remove all Print Marks select **All Off**, to remove individual file's Print Mark, select the file and set **This File** to **000**.

Digital Still Camera Mode (SC-D353/D354/D355 only)

Using Quick Menu: Print Mark

- ❖ Quick menu is used to access Camcorder functions by simply using the Menu selector.
- ❖ Quick menu provides easier access to the frequently used menus without using the MENU button.
- ❖ It can be set on the selected file only.

1. Press the **Menu selector**.
2. Move the **Menu selector** to left or right to select **Print Mark**, then press the **Menu selector**.
3. Move the **Menu selector** to the left or right to select the quantity, then press the **Menu selector**.
4. To exit, press the **MENU** button.

[Notes]

- If the Print Mark is set to This File, you can set the number of copies from 0 to 999.
- If the Print Mark is set to All Files, you can set the number of copies to 0 or 1.
- The All Files option may require extended operation time depending on the number of stored images.
- DPOF supporting printers are commercially available.
- Use the USB cable provided with the Camcorder.

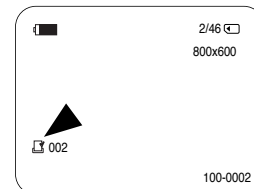
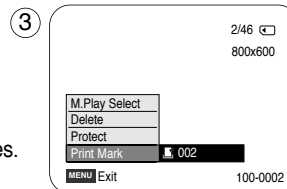
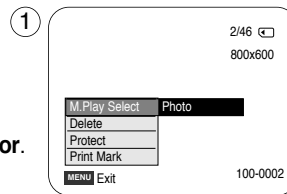

PictBridge™ (SC-D353/D354/D355 only)

Printing Your Pictures – Using the PictBridge™

- ❖ PictBridge™ function works only in M.Player mode.
- ❖ By connecting the Camcorder to printers with PictBridge support (sold separately), you can send images from the Memory card directly to the printer with a few simple operations.
- ❖ With the PictBridge Support, you can control the printer directly through your Camcorder in order to print out stored pictures. For direct printing of your stored pictures using the PictBridge function, you must connect your Camcorder to a PictBridge printer using a USB cable.

Connecting To a Printer

1. Turn your printer power off.
Turn your Camcorder on by setting the **Power** switch to **PLAYER**.
2. Set the **Mode** switch to **MEMORY CARD**.
3. Press the **MENU** button.
 - The menu list will appear.
4. Move the **Menu selector** to the left or right to select **System**, then press the **Menu selector**.
5. Move the **Menu selector** to the left or right to select **USB Connect**, then press the **Menu selector**.
6. Move the **Menu selector** to the left or right to select **Printer**, then press the **Menu selector**.
 - Computer: Connect to a computer.
 - Printer: Connect to a printer. (To use the PictBridge function, connect to a printer.)
7. Connect your Camcorder to the printer using the provided USB cable.
8. Turn your printer power on.
 - The PictBridge menu screen appears automatically after a short period.
 - The cursor highlights Printer.

Selecting Images

1. In the PictBridge settings menu, press the ◀/▶ (REV/FWD) buttons to select an image to print.

Setting the Number of Prints

2. Move the **Menu selector** to the left or right to select **Copies**, then press the **Menu selector**.
3. Move the **Menu selector** to the left or right to set the number of prints, then press the **Menu selector**.

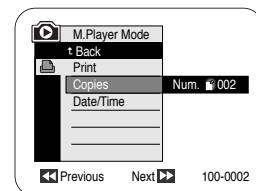
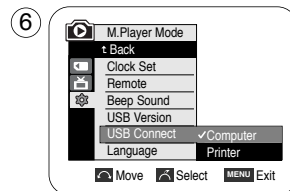
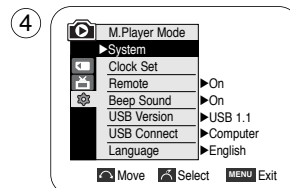

PictBridge™ (SC-D353/D354/D355 only)

Setting the Date/Time Imprint Option

4. Move the **Menu selector** to the left or right to select **Date/Time**, then press the **Menu selector**.
5. Move the **Menu selector** to the left or right to select the Date/Time display type, then press the **Menu selector**.
 - Date/Time display type: Off, Date, Time, Date&Time

Printing Images

Move the **Menu selector** to the left or right to select **Print**, then press the **Menu selector**, and selected image files will be printed.

[Notes]

- The Date/Time Imprint Option may not supported by all printers. Check with your printer manufacturer. The DATE/TIME Menu cannot be setup if the printer does not support this option.
- The PictBridge™ is a registered trademark of CIPA(Camera & Imaging Products Association), an image transfer standard developed by Canon, Fuji, HP, Olympus, Seiko Epson, and Sony.
- PictBridge supporting printers are commercially available.
- Use the USB cable provided with the Camcorder.
- Use the AC power adapter for your Camcorder during PictBridge Direct Printing. Turning your Camcorder off during the printing might damage data on the Memory card.
- Printing still images is supported. Motion clips are not available for printing.
- You can set various printing options depending on the printer.
- Please refer to the user's manual of the printer.

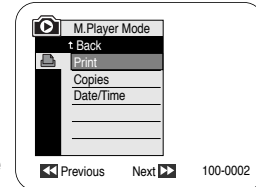
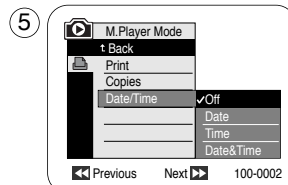

Maintenance

After Finishing a Recording

- ❖ At the end of a recording you must remove the power source.
 - ❖ When recording with a Lithium ion Battery pack, leaving the pack on the Camcorder can reduce the life span of the battery. The Battery pack should be release after recording is completed.
1. Slide the **TAPE EJECT** switch in the direction of the arrow.
 - Opening the cassette door ejects the tape automatically.
 - Please wait while the tape is completely ejected.
 2. After removing the tape, close the door and store the Camcorder in a dust free environment. Dust and other foreign materials can cause square-shaped noise or jerky images.
 3. Set the **Power** switch to the **Off**.
 4. Disconnect the power source or remove the lithium ion Battery pack. Press the **BATTERY RELEASE** button located on the bottom of the Camcorder and slide the Battery pack in the direction of the arrow.

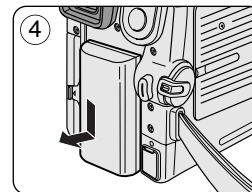
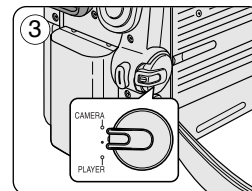
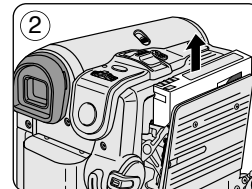
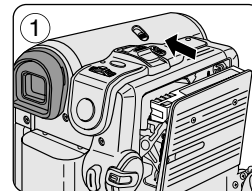

Maintenance

Cleaning and Maintaining the Camcorder

Cleaning the Video Heads

To ensure normal recording and clear pictures, clean the video heads when the playback pictures display square block-shaped noise or distortion, or a blue screen appears.

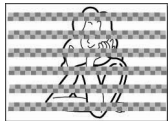

(blue screen)

1. Set the **Power** switch to **PLAYER**.
2. Set the **Mode** switch to **TAPE**. (SC-D353/D354/D355 only)
3. Insert the cleaning tape.
4. Press the ►/|| (PLAY/STILL) button.
5. Press the ■ (STOP) button after 10 seconds.

[Notes]

- Check the quality of the picture using a videocassette.
 - If the picture quality has not improved, repeat the operation.
- Clean the video heads with a dry type cassette cleaner.
- Some cleaning cassette products stop automatically. Refer to the cleaning cassette's instructions for detailed information.
 - If the problem continues after the cleaning, consult your nearest Samsung dealer or Authorized Service Center.

Maintenance

Using Your Camcorder Abroad

- ✦ Each country or region has its own electric and color systems.
- ✦ Before using your Camcorder abroad, check the following items.

Power sources

- You can use your Camcorder in any country or area with the supplied AC Power adapter within 100V to 240V, 50/60 Hz.
- Use a commercially available AC jack adapter, if necessary, depending on the design of the local wall outlet.

Color system

You can view your recording in the Viewfinder.

However, to view it on a television or copy it to a videocassette recorder, the television or VCR must be NTSC-compatible and have the appropriate audio/video jacks.

Otherwise, you may need to use a transcoder.

PAL-compatible Countries/Regions

Australia, Austria, Belgium, Bulgaria, China, CIS, Czech Republic, Denmark, Egypt, Finland, France, Germany, Greece, Great Britain, Holland, Hong Kong, Hungary, India, Iran, Iraq, Kuwait, Libya, Malaysia, Mauritius, Norway, Romania, Saudi Arabia, Singapore, Slovak Republic, Spain, Sweden, Switzerland, Syria, Thailand, Tunisia, etc.

NTSC-compatible Countries/Regions

Bahamas, Canada, Central America, Japan, Korea, Mexico, Philippines, Taiwan, United States of America, etc.

[Note]



You can make recordings with your Camcorder and view pictures on the LCD screen from anywhere in the world.

Troubleshooting

Troubleshooting

- ❖ Before contacting a Samsung authorized service center, perform the following simple checks. They may save you the time and expense of an unnecessary call.

Self Diagnosis Display

Display	Blinking	Informs that...	Action
	slow	the Battery pack is almost discharged.	Change to a charged one.
Tape end!	slow	When the remaining time on the tape is about 2 minutes.	Prepare a new one.
Tape end!	no	the tape reached its end.	Change to a new one.
No Tape!	slow	there is no tape in Camcorder.	Insert a tape.
Protection!	slow	the tape is protected from recording.	If you want to record, release the protection.
▲...D L C R	slow	the Camcorder has some mechanical fault.	1. Eject the tape. 2. Set to OFF. 3. Detach the battery. 4. Reattach the battery. * If unresolved contact your local samsung service center.
	slow	moisture condensation has formed in the Camcorder.	see below.

Moisture Condensation

- ❖ If the Camcorder is brought directly from a cold place to a warm place, moisture may condense inside the Camcorder, on the surface of the tape, or on the lens. In this condition, the tape may stick to the head drum and be damaged or the unit may not operate correctly.
To prevent possible damage under these circumstances, the Camcorder is fitted with a moisture sensor.
- ❖ If there is moisture inside the Camcorder,  (DEW) is displayed. If this happens, none of the functions except cassette ejection will work.
Open the cassette compartment and remove the battery.
Leave the Camcorder for at least two hours in a dry warm room.

Troubleshooting

Self Diagnosis Display in M.Cam/M.Player Modes (SC-D353/D354/D355 only)

Display	Blinking	Informs that...	Action
No Memory Card!	slow	There is no Memory card in the Camcorder.	Insert a Memory card.
Memory Full!	slow	There is not enough memory to record.	Change to a new Memory card. Erase recorded image.
No image!	slow	There are no images recorded on the Memory card.	Record new images.
Write protect!	slow	The Memory card is record protected.	Release the write protect tab on the Memory card.
Protect!	slow	When you try to delete to protected image.	Cancel the protection of image.
Read error!	slow	The Camcorder can not playback.	Format a Memory card or insert Memory card recorded on this Camcorder.
Write error!	slow	The Camcorder can not record.	Format a Memory card or change to a new Memory card.
Not Formatted!	slow	The Memory card needs to format.	Format a Memory card. (see page 101)
Now deleted...	slow	When progressing file delete.	Wait until delete has been finished.
Memory Card error!	slow	If inserted Memory Card is not recognized by the Camcorder.	Eject and re-insert the memory card Try another Memory Card

Troubleshooting

❖ If these instructions do not solve your problem, contact your nearest Samsung authorized service center.

Symptom	Explanation/Solution
You cannot switch the Camcorder on.	Check the Battery pack or the AC Power adapter.
Start/Stop button does not operate while recording.	Check the Power switch is set to CAMERA. You have reached the end of the cassette. Check the record protection tab on the cassette.
The Camcorder shuts off automatically.	You have left the Camcorder set to STBY for more than 5 minutes without using it. The Battery pack is fully exhausted.
Charge runs out quickly.	The atmospheric temperature is too low. The Battery pack has not been charged fully. The Battery pack is completely dead, and cannot be recharged. Use another Battery pack.
When you see a blue screen during playback.	The video heads may be dirty. Clean the head with a cleaning tape.
A vertical strip appears on the screen when recording a dark background.	The contrast between the subject and the background is too great for the Camcorder to operate normally. Make the background bright to reduce the contrast or use the BLC function while you are recording in bright Surroundings.
The image in the Viewfinder is blurred.	The Viewfinder lens has not been adjusted. Adjust the Viewfinder control lever until the indicators displayed on the Viewfinder come into sharp focus.
Auto focus does not work.	Check the Manual Focus menu. Auto focus does not work in the Manual Focus mode.
Play, FF or REW button does not work.	Check the Power switch. Set the Power switch to PLAYER. You have reached the beginning or end of the cassette.
When you see a mosaic pattern during playback search.	This is normal operation and it is not a failure or defect. The tape may be damaged. Replace the tape. Cleaning the video heads (see page 113).

Specifications

Model Name: SC-D351/D352/D353/D354/D355

System	
Video signal	NTSC
Video recording system	2 rotary heads, Helical scanning system
Audio recording system	Rotary heads, PCM system
Usable cassette	Digital video tape (6.35mm width): Mini DV cassette
Tape speed	SP: approx. 18.81mm/s LP: approx. 12.56mm/s
Tape recording time	SP: 60 minutes (when using DVM 60), LP: 90 minutes (when using DVM 60)
FF/REW time	Approx. 150 sec. (using DVM60 tape)
Image device	CCD (Charge Coupled Device) (680k pixels)
Lens	F1.6 20x(Optical), 900x(Digital) Electronic zoom lens
Filter diameter	Ø30
LCD screen/Viewfinder	
Size/dot number	2.36inches 112k
LCD screen Method	TFT LCD
Viewfinder	B/W LCD (SC-D351/D352/D353/D354 only), Color LCD (SC-D355 only)
Connectors	
Video output	1Vp-p (75Ω terminated)
S-video output	Y: 1Vp-p, 75Ω, C: 0.286Vp-p, 75Ω
Audio output	-7.5dBs (600Ω terminated)
DV input/output	4pin special in/out connector
USB output	Mini-B type connector
External mic	Ø3.5 stereo

General	
Power source	DC 8.4V, Lithium Ion Battery Pack 7.4V
Power source type	Lithium Ion Battery Pack, Power supply (100V~240V) 50/60Hz
Power consumption (Recording)	4.3W(LCD), 4.0W(Viewfinder)
Operating temperature	0°~40°C (32°F~104°F)
Storage temperature	-20°C ~ 60°C (-4°F ~ 140°F)
External dimension	Height 3.62inches(92mm), Length 4.63inches(117.5mm), Width 2.52inches(64mm)
Weight	0.904lb (410g, 14.46oz) (Except for Lithium Ion Battery Pack and tape)
Internal MIC	Omn-directional stereo microphone
Remote control (SC-D354/D355 only)	Indoors: greater than 49ft(15m) (straight line), Outdoors: about 16.4ft(5m) (straight line)

- These technical specifications and design may be changed without notice.

Index

- A -		- O -	
Accessories	12	OSD	24, 25
AF/MF	58	- P -	
Audio Dubbing	77	Photo Copy	106
Audio Mode	55	Photo Quality	91
- B -		Photo Search	68
Battery Pack	21	Program AE	63, 64
BLC	46	Protection	97
- C -		- R -	
Cassette	36	Rec Mode	54
Cleaning	113	Rec Search	41
Clock Set	27	Remote	28
Connecting	71	Remote control	17, 43
- D -		- S -	
Date/Time	33	Shutter Speed	57
DC Cable	20	Sound	70
Deleting	99	Speaker	70
Demonstration	31	Still images	95
DIS	61	- T -	
Digital Effect	65	Tele MACRO	44
DV	79, 80	TV Display	34
- E -		- U -	
EASY.Q Mode	40	USB	81-86
Exposure	57	- V -	
- F -		Viewfinder	35
Fade	45	- W -	
Formatting	101	White Balance	59
Frame advance	74	Wind Cut	56
Function buttons	13	- Z -	
- H -		ZERO MEMORY	42
Hand Strap	18	Zoom	44
- I -			
IEEE1394	79		
- L -			
LCD	32		
- M -			
Memory card	88		
Memory Stick	87		
MPEG Recording	102		

Warranty (SEA users only)

SAMSUNG LIMITED WARRANTY

SAMSUNG Electronics America Inc. (SEA), warrants that this product is free from defective material and workmanship. SEA further warrants that if product fails to operate properly within the specified warranty period and the failure is due to improper workmanship or defective material, SEA will repair or replace the product at it's option.

All warranty repairs must be performed by a SEA authorized service center. The name and address of the location nearest you can be obtained by calling toll free: 1-800 SAMSUNG (1-800-726-7864).

Labor

90 days carry-in

Parts

1 year

On carry-in models, transportation to and from the service center is the customer's responsibility.

The original dated sales receipt must be retained by the customer and is the only acceptable proof of purchase. It must be presented to the authorized service center.

EXCLUSIONS (WHAT IS NOT COVERED)

This warranty does not cover damage due to accident, fire, flood and/or other acts of God; misuse, incorrect line voltage, improper installation, improper or unauthorized repairs, commercial use, or damage that occurs in shipping. Exterior and interior finish, lamps, and glass are not covered under this warranty.

Customer adjustments which are explained in the instruction manual are not covered under the terms of this warranty. This warranty will automatically be voided for any unit found with a missing or altered serial number. This warranty is valid only on products purchased in the United States and Puerto Rico.

Some States do not allow the exclusions or limitations of incidental or consequential damages, or allow limitations on how long an implied warranty lasts, so the above limitations or exclusions may not apply to you.

This warranty gives you specific legal rights, and you may also have other rights which vary from State to State.

Memo

ENGLISH

Memo

Memo

ENGLISH

THIS CAMCORDER IS MANUFACTURED BY:



SERVICE DIVISION
400 Valley Road, Suite 201, Mt. Arlington N.J. 07856
Tel: 1-800-SAMSUNG
(1-800-726-7864)

***Samsung Electronics' Internet Home Page**

<http://www.samsung.com>

AD68-00839B