

SAMSUNG

**LTM215
LTM245W**

TFT-LCD TELEVISION

**Owner's
Instructions**

For Better Display

1. Adjust computer resolution and screen injection rate (refresh rate) in control panel of computer as described below to enjoy the best quality of picture. You can have an uneven quality of picture in the screen if the best quality of picture is not provided in TFT-LCD.
 - **Resolution :** 21" - 1600 x 1200
24" - 1920 x 1200
 - **Vertical frequency** (refresh rate) : 60 Hz
2. TFT LCD panel manufactured by using advanced semiconductor technology with precision of 99.999% above is used for this product. But the pixels of RED, GREEN, BLUE and WHITE color seem to be bright sometimes or some of black pixels could be seen. This is not from bad quality and you can use it without uneasiness.
 - For example, the number of TFT LCD pixels that is contained in this product are 5,760,000 (21"), 6,912,000 (24").
3. When you clean the LCD TV and the panel outside, please apply the recommended small amount of cleaner by using soft and dry cloth and polish it. Let LCD area not to be forced but to be scrubbed out softly. If excessive force is applied, you can have a stain on it.
4. If you are not satisfied with the quality of picture, you can get better quality of picture by executing "auto adjustment function" in display screen that is appeared as window termination button is pressed. If there's still noise after automatic adjustment, use FINE/COARSE adjustment function.

Information in this document is subject to change without notice.

© 2002 Samsung Electronics Co., Ltd. All rights reserved.

Reproduction in any manner whatsoever without the written permission of Samsung Electronics Co., Ltd. is strictly forbidden.

Samsung Electronics Co., Ltd. shall not be liable for errors contained herein or for incidental or consequential damages in connection with the furnishing, performance, or use of this material.

The **Samsung logo** is the registered trademarks of Samsung Electronics Co., Ltd.; **Microsoft, Windows®** and **Windows® NT** are registered trademark of Microsoft Corporation; **VESA, DPMS** and **DDC** are registered trademarks of Video Electronics Standard Association. All other product names mentioned herein may be the trademarks or registered trademarks of their respective owners.

Thank You for Choosing Samsung

Thank you for choosing Samsung! Your new Samsung LCD TV represents the latest in LCD TV technology. We designed it with easy-to-use on-screen menus and closed captioning capabilities, making it one of the best products in its class. We are proud to offer you a product that will provide convenient, dependable service and enjoyment for years to come.

Warning! Important Safety Instructions

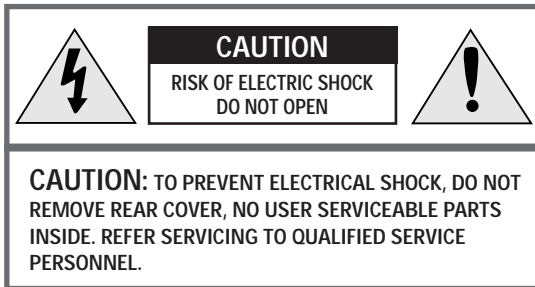

The lightning flash and arrow head within the triangle is a warning sign alerting you of "dangerous voltage" inside the product.

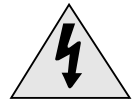

The exclamation point within the triangle is a warning sign alerting you of important instructions accompanying the product.



WARNING: TO PREVENT DAMAGE WHICH MAY RESULT IN FIRE OR SHOCK HAZARD, DO NOT EXPOSE THIS APPLIANCE TO RAIN OR MOISTURE.

Note to CATV system installer: This reminder is provided to call CATV system installer's attention to Article 820-40 of the National Electrical Code (Section 54 of Canadian Electrical Code, Part I), that provides guidelines for proper grounding and, in particular, specifies that the cable ground shall be connected to the grounding system of the building as close to the point of cable entry as practical.

Caution: FCC/CSA regulations state that any unauthorized changes or modifications to this equipment may void the user's authority to operate it.

Caution: To prevent electric shock, match the wide blade of plug to the wide slot, and fully insert the plug.

Attention: Pour éviter les chocs électriques, introduire la lame le plus large de la fiche dans la borne correspondante de la prise et pousser jusqu'au fond.

Important: One Federal Court has held that unauthorized recording of copyrighted TV programs is an infringement of U.S. copyright laws. Certain Canadian programs may also be copyrighted and any unauthorized recording in whole or in part may be in violation of these rights.

Warning! Important Safety Information

Always be careful when using your LCD TV. To reduce the risk of fire, electrical shock, and other injuries, keep these safety precautions in mind when installing, using, and maintaining your machine.

- ◆ Read all safety and operating instructions before operating your LCD TV.
- ◆ Keep the safety and operating instructions for future reference.
- ◆ Heed all warnings on the LCD TV and in the operating instructions.
- ◆ Follow all operating and use instructions.
- ◆ Unplug the LCD TV from the wall outlet before cleaning. Use a damp cloth; do not use liquid or aerosol cleaners.
- ◆ Never add any attachments and/or equipment without approval of the manufacturer. Such additions can increase the risk of fire, electric shock, or other personal injury.
- ◆ Do not use the LCD TV where contact with or immersion in water is a possibility, such as near bath tubs, sinks, washing machines, swimming pools, etc.
- ◆ Do not place the LCD TV on an unstable cart, stand, tripod, bracket, or table where it can fall. A falling LCD TV can cause serious injury to a child or adult, and serious damage to the appliance. Use only with a cart, stand, tripod, bracket, or table recommended by the manufacturer or sold with the LCD TV. Follow the manufacturer's instructions when mounting the unit, and use a mounting accessory recommended by the manufacturer. Move the LCD TV and cart with care. Quick stops, excessive force, and uneven surfaces can make the unit and cart unsteady and likely to overturn.
- ◆ Provide ventilation for the LCD TV. The unit is designed with slots in the cabinet for ventilation to protect it from overheating. Do not block these openings with any object, and do not place the LCD TV on a bed, sofa, rug, or other similar surface. Do not place it near a radiator or heat register. If you place the LCD TV on a rack or bookcase, ensure that there is adequate ventilation and that you've followed the manufacturer's instructions for mounting.
- ◆ Operate your LCD TV only from the type of power source indicated on the marking label. If you are not sure of the type of power supplied to your home, consult your appliance dealer or local power company.
- ◆ Use only a grounded or polarized outlet. For your safety, this LCD TV is equipped with a polarized alternating current line plug having one blade wider than the other. This plug will fit into the power outlet only one way. If you are unable to insert the plug fully into the outlet, try reversing the plug. If the plug still does not fit, contact your electrician to replace your outlet.
- ◆ Protect the power cord. Power supply cords should be routed so that they won't be walked on or pinched by objects placed on or against them. Pay particular attention to cords at plugs, convenience receptacles, and the point where they exit from the unit.
- ◆ Unplug the LCD TV from the wall outlet and disconnect the antenna or cable system during a lightning storm or when left unattended and unused for long periods of time. This will prevent damage to the unit due to lightning and power-line surges.



Warning! Important Safety Information

- ◆ Avoid overhead power lines. An outside antenna system should not be placed in the vicinity of overhead power lines or other electric light or power circuits or where it can fall into such power lines or circuits. When installing an outside antenna system, be extremely careful to keep from touching the power lines or circuits. Contact with such lines can be fatal.
- ◆ Do not overload the wall outlet or extension cords. Overloading can result in fire or electric shock.
- ◆ Do not insert anything through the openings in the unit, where they can touch dangerous voltage points or damage parts. Never spill liquid of any kind on the LCD TV.

- ◆ Ground outdoor antennas. If an outside antenna or cable system is connected to the LCD TV, be sure the antenna or cable system is grounded so as to provide some protection against voltage surges and built-up static charges. Section 810 of the National Electrical Code, ANSI/NFPA No.70-1984, provides information about proper grounding of the mast and supporting structure, grounding of the lead-in wire to an antenna discharge unit, size of grounding conductors, location of antenna discharge electrodes, and requirements for the grounding electrode.

EXAMPLE OF ANTENNA GROUNDING

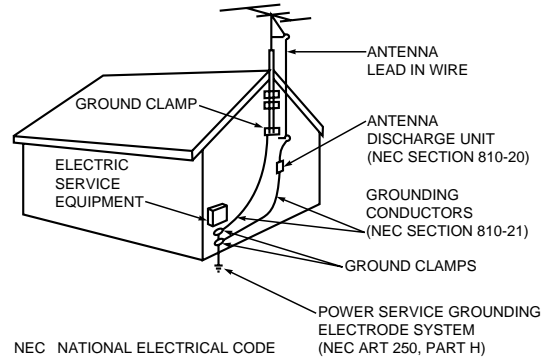

- ◆ Do not attempt to service the LCD TV yourself. Refer all servicing to qualified service personnel. Unplug the unit from the wall outlet and refer servicing to qualified service personnel under the following conditions:
 - when the power-supply cord or plug is damaged
 - if liquid has been spilled on the unit or if objects have fallen into the unit
 - if the LCD TV has been exposed to rain or water
 - if the LCD TV does not operate normally by following the operating instructions
 - if the LCD TV has been dropped or the cabinet has been damaged
 - when the LCD TV exhibits a distinct change in performance
- ◆ If you make adjustments yourself, adjust only those controls that are covered by the operating instructions. Adjusting other controls may result in damage and will often require extensive work by a qualified technician to restore the LCD TV to normal.
- ◆ When replacement parts are required, be sure the service technician uses replacement parts specified by the manufacturer or those that have the same characteristics as the original part. Unauthorized substitutions may result in additional damage to the unit.
- ◆ Upon completion of any service or repairs to this LCD TV, ask the service technician to perform safety checks to determine that the LCD TV is in a safe operating condition.

This device complies with part 15 of the FCC Rules. Operation is subject to the following two conditions:
(1) This device may not cause harmful interference, and
(2) This device must accept any interference that may cause undesired operation.

This LCD TV provides display of television closed captioning in accordance with §15.119 of the FCC rules.

Contents

For Better Display	2
Warning! Important Safety Information	3
Unpacking Your LCD TV	7
Inserting the Batteries in the Remote Control.....	7
Setting up Your LCD TV	
Setting up an Ergonomic Workstation.....	8
LCD TV location	8
Workstation height	8
Viewing angle.....	8
Plug and Play	8
Installing the Monitor Driver	8
Self-Test Feature Check (STFC).....	9
Getting Help	9
Warm-up Time	9
Connecting Your LCD TV.....	10
15 Pin D-sub connector	12
Viewing Your LCD TV	
Front Controls	13
Remote Control.....	14
Adjusting Your LCD TV	
Automatic Save	15
Accessing the Menu System.....	15
Changing your Language	15
Setting the Channel.....	16
Setting the Picture.....	18
Setting the Sound	19
Viewing the Picture In Picture (PIP).....	20
Viewing the Picture By Picture (PBP)	21
Viewing Closed Captions	22
Viewing the V-Chip	23
PC Functions and Adjustments	25
Setting the Sleep Timer	28
Switching the Sound Off Temporarily	28
Viewing pictures from External Sources.....	28
Displaying Information	28
PC Display Modes	29
PowerSaver	29
Troubleshooting	
Image	30
Audio & TV	31
Technical and Environmental Specifications	32
Regulatory Information	33

Unpacking Your LCD TV

Please make sure the following items are included with your LCD TV. If any items are missing, contact your dealer.

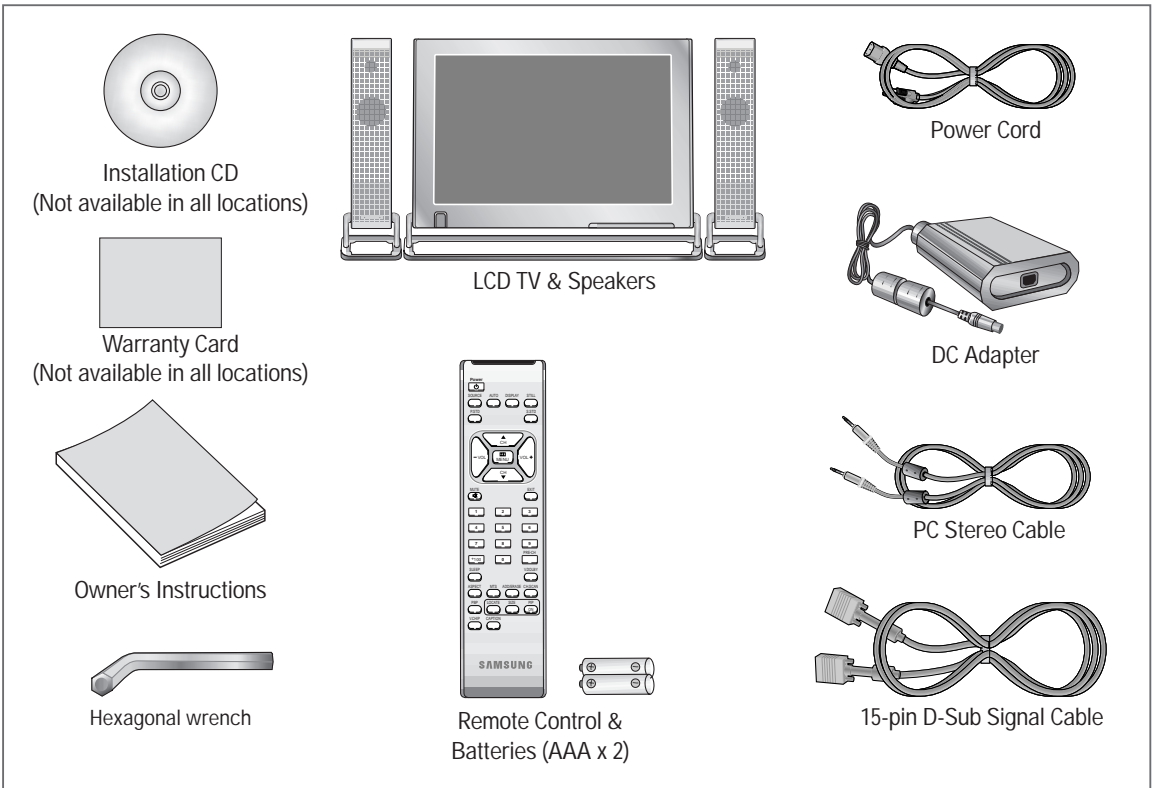

Inserting the Batteries in the Remote Control

- 1 Remove the cover on the rear of the remote control by pressing the  downwards and then pulling firmly to remove it as shown in the figure.
- 2 Insert two R03, UM4, "AAA" 1.5V or equivalent batteries taking care to respect the polarities:
 - ◆ + on the battery against + on the remote control
 - ◆ - on the battery against - on the remote control
- 3 Replace the cover by aligning it with the base of the remote control and pressing it back into place.

➤ Do not mix battery types, i.e. alkaline and manganese.

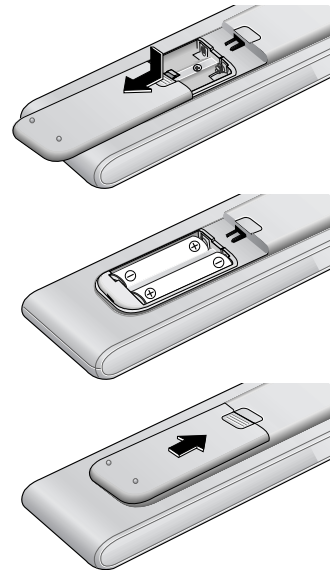

Setting up Your LCD TV

Setting up an Ergonomic Workstation

Consider the advice given below before you install your LCD TV.

LCD TV location

Choose a position that exposes your LCD TV to the least reflection from lights or windows, usually at a right angle to any window.

Workstation height

Place your LCD TV so that the top of the screen is slightly below your eye level when you are comfortably seated.

Viewing angle

Tilt the screen until you feel comfortable working with your LCD TV.

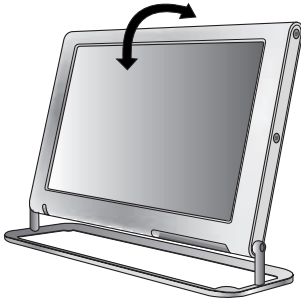

- The maximum tilt angle is 15 degree to the backward direction. Please do not tilt the LCD TV other than specified range. **Excessive force to tilt the LCD TV other than specified range may give permanent damage to the mechanical part of the stand.**

Plug and Play

The adoption of the new **VESA®** Plug and Play solution eliminates complicated and time consuming setup. It allows you to install your LCD TV in a Plug and Play compatible system without the usual hassles and confusion. Your PC system can easily identify and configure itself for use with your display. This LCD TV automatically tells the PC system its Extended Display Identification Data (EDID) using Display Data Channel (DDC) protocols so the PC system can automatically configure itself to use the flat panel display. If your PC system needs a monitor driver, follow the instructions given below according to the operating system your computer uses.

Installing the Monitor Driver

The CD that accompanies this product contains the necessary drivers for installing your LCD TV. Please refer to the driver installation instructions included with your CD package for more information.

Setting up Your LCD TV

Self-Test Feature Check (STFC)

Your LCD TV provides a self-test feature that allows you to check whether your LCD TV is functioning properly. Make sure that PC is selected as a primary source by checking if the source indicator LED labeled "PC" is on. If your LCD TV and computer are properly connected but the LCD TV screen remains dark and the power indicator is blinking, run the LCD TV self-test by following the steps:

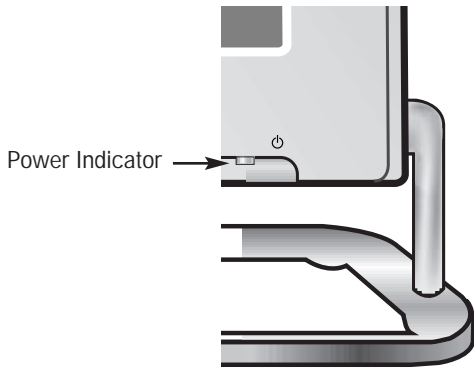

- 1 Turn off both your computer and the LCD TV.
- 2 Unplug the video cable from the back of the computer.
- 3 Turn on the LCD TV.

If the LCD TV is functioning properly, you will see a white box with a large blue oval Samsung logo and an error message : Check Signal Cable.



This box also appears during normal operation if the video cable becomes disconnected or damaged.

- 4 Turn off your LCD TV and reconnect the video cable; then turn on both your computer and the LCD TV.

If your LCD TV screen remains blank after following the previous procedure, check your video controller and computer system; your LCD TV is functioning properly.

Getting Help

If your LCD TV does not display an image, check your cable connections and refer to "Troubleshooting" on page 29. If you experience difficulties with the quality of the displayed image, press the **Auto** button (see page 13).

Warm-up Time

All LCD TV need time to become thermally stable whenever you turn on the LCD TV after letting the LCD TV be turned off for a couple of hours. Therefore, to achieve more accurate adjustments for parameters, allow the LCD TV to warm (be on) for at least 20 minutes before making any screen adjustments.

Setting up Your LCD TV

Connecting Your LCD TV

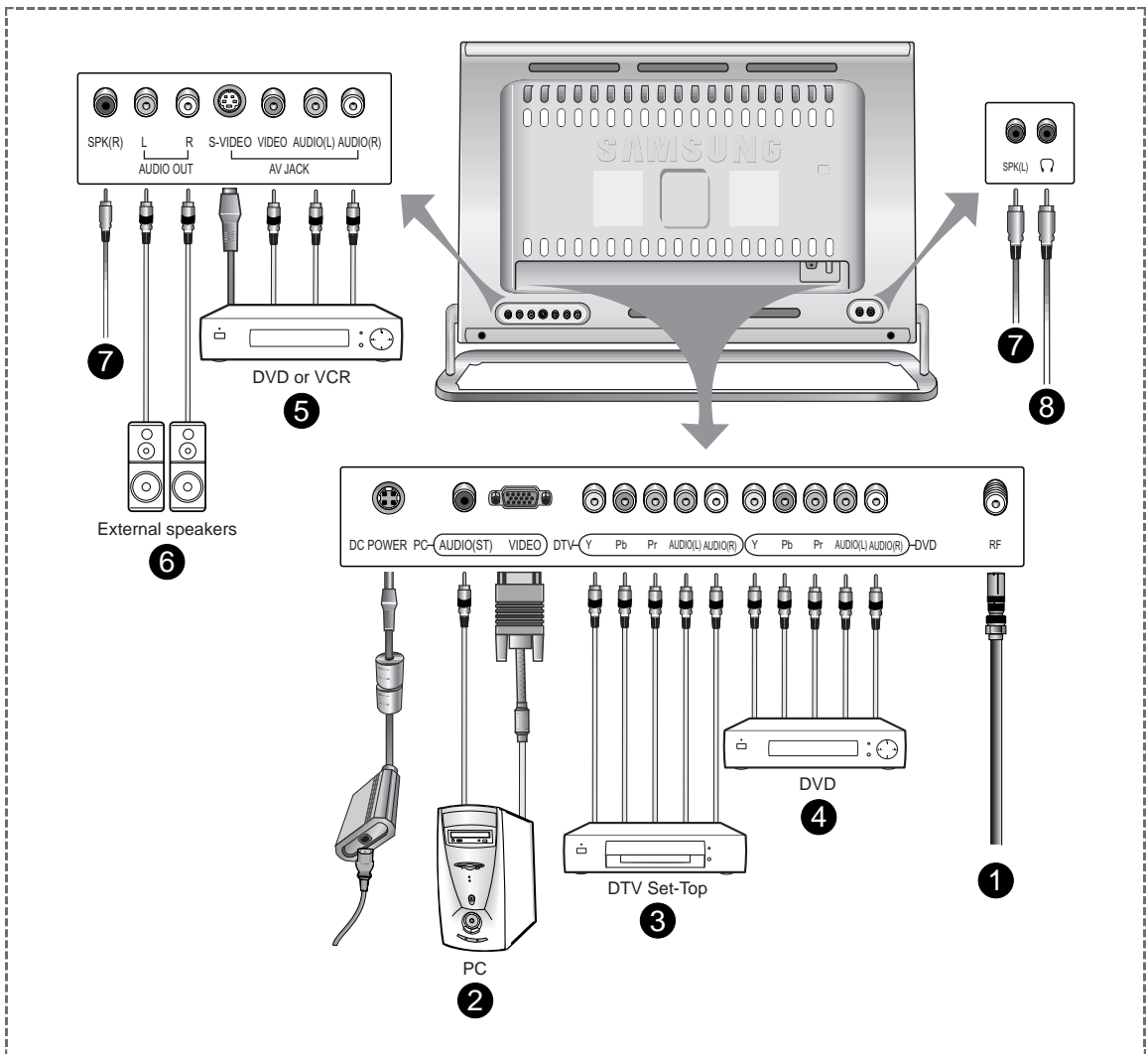

1. Connecting TV/CATV

Connect an antenna or CATV cable to the antenna terminal.

2. Connecting Computer

- Connect the 15-Pin D-SUB of the video signal cable to the PC video connector.
- Connect the PC stereo audio cable to “Audio (ST)” on the rear of the LCD TV and the other end to “Audio Out” terminal of the sound card on your computer.
- If necessary, please install monitor driver contained on the accompanied CD. For driver installation, please refer “Installing Monitor Driver” section on page 8.

3. Connecting DTV Set-Top Box

- Connect the RCA DTV Cable to the Video port of the DTV Function.
- Connect the RCA Cable to “AUDIO(L)” and “AUDIO(R)” on the rear of the LCD TV and the other end to “Audio Out” terminal of the Set-Top Box.
- Connect the RCA Cable to “Y”, “Pb”, and “Pr” on the rear of the LCD TV and the other end to “Video Out” terminal of the Set-Top Box.

continued...

Setting up Your LCD TV

4. Connecting DVD

- Connect the RCA DVD Cable to the Video port of the DVD Function.
- Connect the RCA Cable to "AUDIO(L)" and "AUDIO(R)" on the rear of the LCD TV and the other end to "Audio Out" terminal of the DVD.
- Connect the RCA Cable to "Y", "Pb", and "Pr" on the rear of the LCD TV and the other end to "Video Out" terminal of the DVD.

5. Connecting External A/V Devices

- Connect RCA or S-VHS cable to an appropriate external A/V device such as VCR, DVD or Camcorder.
- Connect RCA Audio cables to "AUDIO(L)" and "AUDIO(R)" on the rear of the LCD TV and the other ends to corresponding audio out terminals on the A/V device.
- Headphone may be connected to the headphone output on the rear of the LCD TV (8).

While the headphone is connected, the sound from the built-in speakers will be disabled.

6. Connecting External Speakers

Connect RCA Audio cables to amplifier built-in speakers (to take full advantage of the Surround sound effect).

7. Connecting Speakers

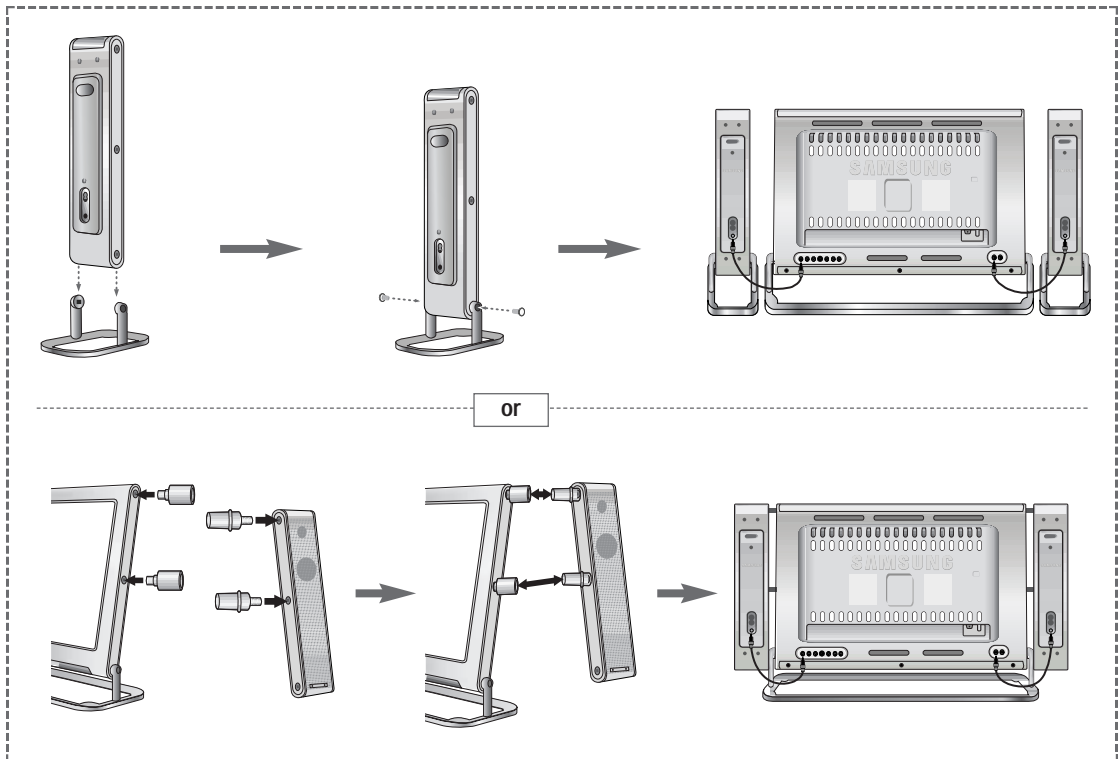

Setting up Your LCD TV

Wall Installation Instructions

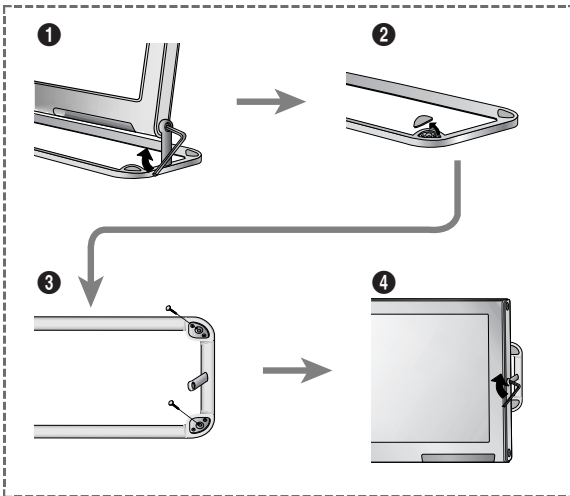

- 1 Removing the TV stand**
Using a hexagonal wrench, remove the TV stand.
- 2 Removing rubbers**
Remove the four rubbers from the edges.
- 3 Mounting on the wall**
Mount the TV stand on the wall using screws or nails.
- 4 Fixing the TV**
Using a hexagonal wrench, fix the TV into the TV stand.

15 Pin D-sub connector



Pin	Separate H/V	Composite H/V	Sync-on-green
1	Red	Red	Red
2	Green	Green	Green + H/V Sync
3	Blue	Blue	Blue
4	GND	GND	GND
5	GND (DDC Return)	GND (DDC Return)	GND (DDC Return)
6	GND-Red	GND-Red	GND-Red
7	GND-Green	GND-Green	GND-Green
8	GND-Blue	GND-Blue	GND-Blue
9	No Connection	No Connection	Not used
10	GND-Sync/Self	Test GND-Sync/Self	Test GND-Sync/Self Test
11	GND	GND	GND
12	DDC_SDA	DDC_SDA	DDC_SDA
13	H_Sync	H/V Sync	Not used
14	V_Sync	Not used	Not used
15	DDC_SCL	DDC_SCL	DDC_SCL

Viewing Your LCD TV

Front Controls

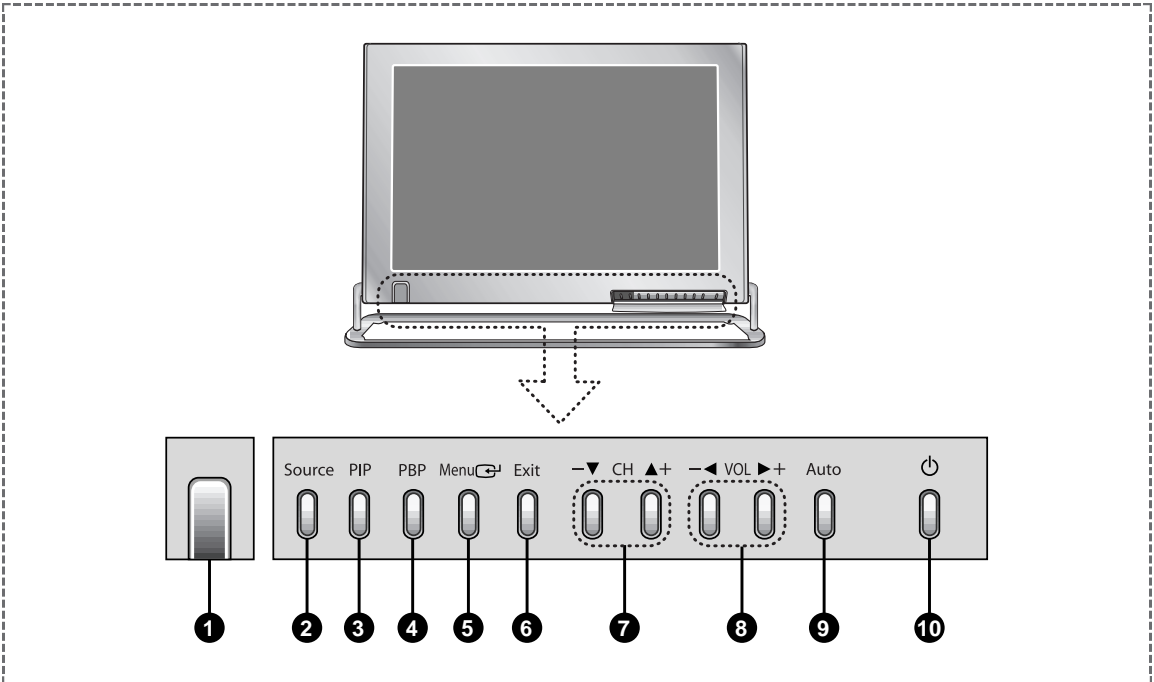
Your LCD TV allows you to easily adjust the characteristics of the image being displayed. All of these adjustments are made using the control buttons on the top of the LCD TV. While you use these buttons to adjust the controls, an OSD shows you their numeric values as they change.



- 1 Remote Control Sensor**
Aim the remote control towards this spot on the LCD TV.
- 2 Source**
Displays a menu of all of the available input sources (TV/Video/S-Video/DVD/DTV/PC).
- 3 PIP**
Activates PIP (Picture-In-Picture)
- 4 PBP**
Activates PBP (Picture-By-Picture).
- 5 Menu** 
Opens the OSD and selects the highlighted function.
- 6 Exit**
Exit from the on-screen menu.
- 7 - ▼ CH ▲ +**
Moves the selector up or down on the OSD.
Increases or decreases the channel number.
- 8 - ◀ VOL ▶ +**
Moves the selector left or right on the OSD.
Increases or decreases the level of audio volume and the values of the selected function.
- 9 Auto**
Allows the TV to self-adjust to the incoming video signal. The values of fine, coarse and position are adjusted automatically. (It works PC mode only.)
- 10  (Power)**
Turns ON/OFF the LCD TV.

Viewing Your LCD TV

Remote Control

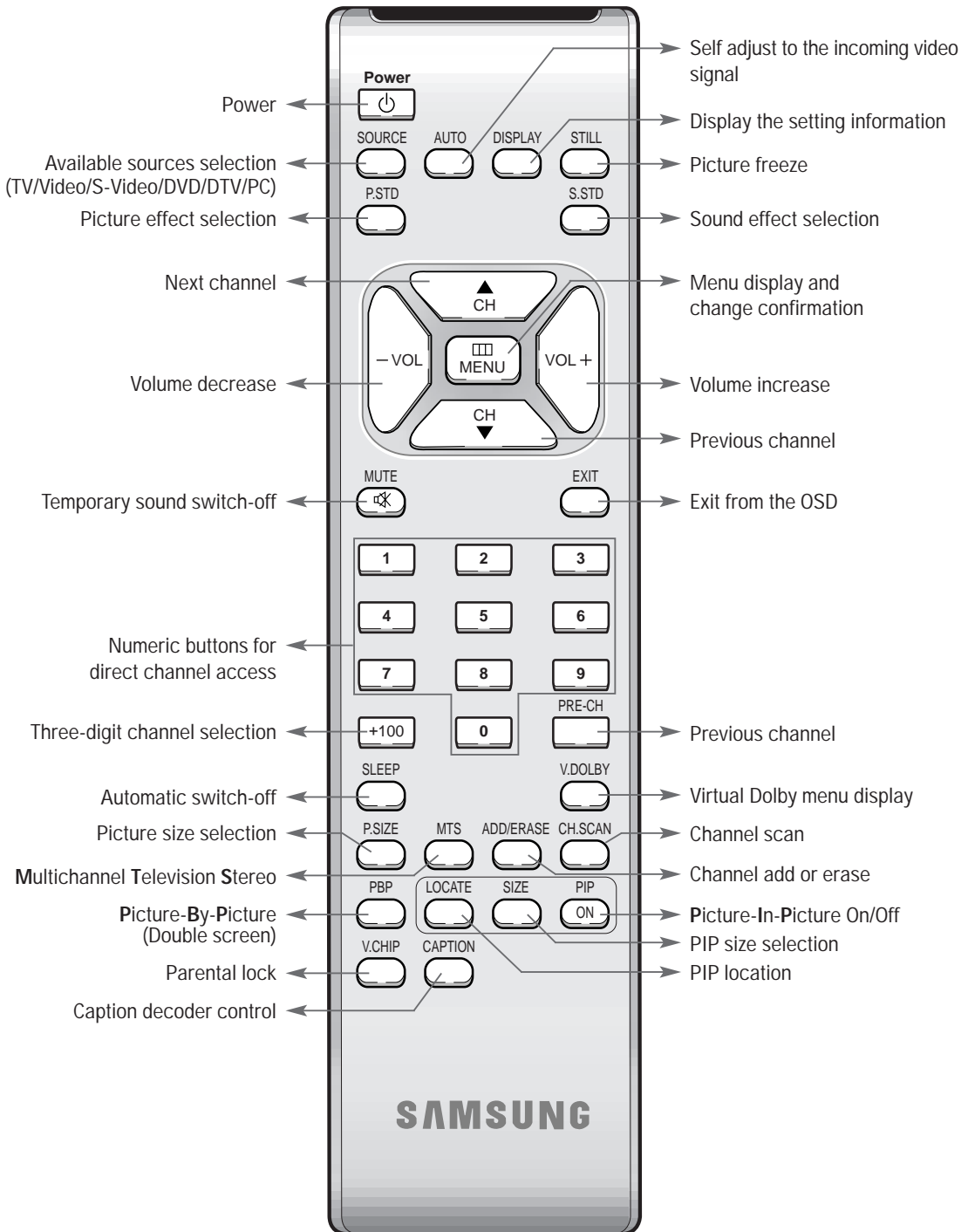

- ◆ The channel up/down and volume up/down buttons are used to select the menu option and change these values.
- ◆ It is possible that the work of the transmitter is dull or not operated normally if the light of the Bulb is on around the set.

Adjusting Your LCD TV

Automatic Save

Whenever you open the OSD and allow an adjustment window to remain active for about 3 seconds without pressing other buttons, the LCD TV automatically saves any adjustment you have made. These changes are saved into a user area in the LCD TV. The LCD TV can save adjustments for up to 4 user modes. It has 13 for LTM215 (15 for LTM245W) factory preset or preload modes, one for each signal frequency as listed in table on page 29.

If you have made no adjustments, the OSD disappears and the LCD TV does not save anything.

Accessing the Menu System

- 1 Press the **MENU** button to display the main OSD menu.
- 2 Use the **▼/▲/◀/▶** buttons to move from one function to another. As you move from one icon to another, the function name changes to reflect the function or group of functions represented by that icon.
- 3 Press the **MENU** button once to activate the highlighted function, then follow the Tool Tips to select the function and adjust the value.
- 4 Use the **▼/▲** buttons to select the sub-menu, and press the **MENU** button once to activate the selected sub-menu.
- 5 After selecting a function, use the **◀ / ▶** buttons to make necessary adjustments. The setting bar moves and the numeric value indicator changes to reflect your adjustments.
➤ The numeric value indicator is provided as a point of reference only and has nothing to do with a real measurement.
- 6 Press the **EXIT** button a couple of times to return to the main menu to select another function or to exit from the OSD.

Changing your Language

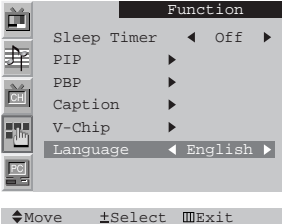
Main Menu	Sub-Menus	Function Descriptions
		<p>When you start using your LCD TV for the first time, you must select the language which will be used for displaying menus and indications.</p> <p>Select a particular language by pressing the - or + button. The following languages are available: English, Spanish, Français, Português.</p>

Adjusting Your LCD TV

Setting the Channel

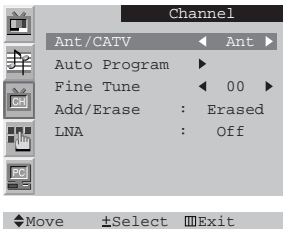
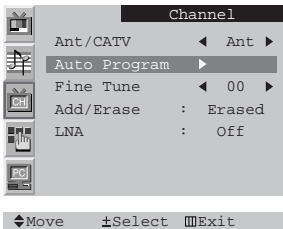
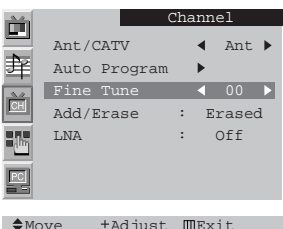
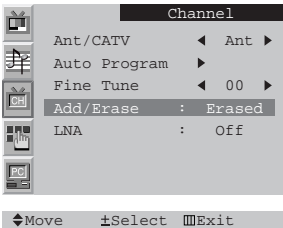
Main Menu	Sub-Menus	Function Descriptions
		<h3>Selecting the Video Signal Source</h3> <p>Before begin memorizing the available channels, you must specify the type of signal source that is connected to the your LCD TV.</p> <p>Press the – or + button to select Ant (antenna) or CATV (cable system).</p> <p>➤ Channel auto program does not work when the V-Chip function is active.</p>
		<h3>Memorizing the Channels Automatically</h3> <p>Your LCD TV can memorize and store all of the available channels found automatically for both “off-air” (antenna) and cable channels.</p> <p>Press the – or + button, and then begin memorizing all of the available channels with the horizontal bar is displayed.</p>
		<h3>Fine tuning Channel Reception</h3> <p>If the reception is clear, you do not have to fine-tune the channel, as this is done automatically during the memorize and store operation.</p> <p>If however the signal is weak or distorted, you may have to fine-tune the channel.</p>
		<h3>Skipping Unwanted Channels</h3> <p>You can exclude the channels of your choice from the channel scan operation. when you scan through the stored channels, those you have chosen to skip are not displayed. All channels that you do not specifically choose to skip are displayed during scanning.</p> <p>➤ You can do easily by pressing the ADD/ERASE button on the remote control.</p>

continued...

Adjusting Your LCD TV

Setting the Channel

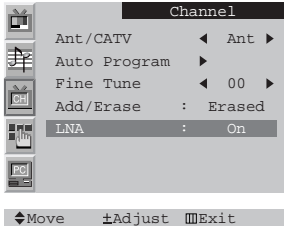
Main Menu	Sub-Menus	Function Descriptions
		<p>Using the LNA (Low Noise Amplifier) function</p> <p>This function is very useful in the situation that your LCD TV is used in weak signal. LNA amplifies the TV signal in the weak signal area, but not noise. This function is working automatically only weak signal condition, and that is memorized on current channel, additional.</p>

Scanning the Available Channels

You can view all of the available channels and then store them in memory by simply pressing the **CH.SCAN** button on the remote control. Press the **CH.SCAN** button, and then the memorized channels will appear in sequence. To stop the scanning, press the **CH.SCAN** button again.

Adjusting Your LCD TV

Setting the Picture

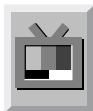
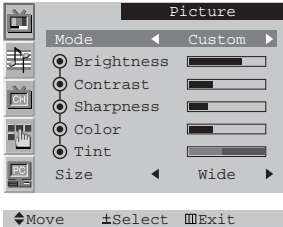
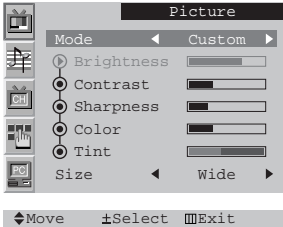
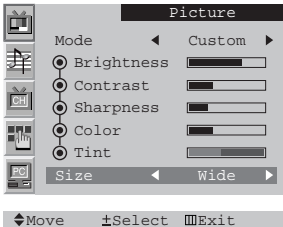
Main Menu	Sub-Menus	Function Descriptions
		<h3>Using Automatic Picture Settings</h3> <p>You can select the picture effect which best corresponds to your viewing requirements by pressing the – or + button repeatedly. The following picture effects are available: Custom, Standard, Natural, Mild.</p> <p>➤ You can select the picture effect directly by pressing the P.STD (Picture Standard) button on the remote control.</p>
		<h3>Customizing the Picture</h3> <p>Your LCD TV has several setting which allow you to control picture quality: Brightness, Contrast, Sharpness, Color, Tint.</p> <p>Select the required option by pressing the ◀ or ▶ button. Then press the – or + button to adjust the value of selected option.</p>
		<h3>Changing the Picture Format</h3> <p>You can select the picture format which best corresponds to your viewing requirements by pressing the – or + button repeatedly. The following picture formats are available: Wide, Normal 1, Normal 2, Zoom 1, Zoom 2.</p> <p>➤ You can select the picture format directly by pressing the P.SIZE (Picture Size) button on the remote control.</p>
		<h3>Freezing the Current Picture</h3> <p>Press the STILL button on the remote control to freeze the picture on a given frame. To return to normal viewing, press the STILL button again.</p>

Adjusting Your LCD TV

Setting the Sound

Main Menu



Sub-Menus

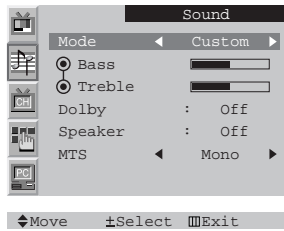

Function Descriptions

Using Automatic Picture Settings

You can select the type of special sound effect to be used when watching a given broadcast by pressing the – or + button repeatedly. The following sound effects are available: **Custom, Standard, Music, Movie, Speech.**

- You can select the sound effect directly by pressing the **S.STD** (Sound Standard) button on the remote control.

Customizing the Sound

The sound settings can be adjusted to suit your personal preferences: **Bass, Treble.** Select the required option by pressing the ↑ or ↓ button. Then press the – or + button to adjust the value of selected option.

Enjoying Dolby Sound

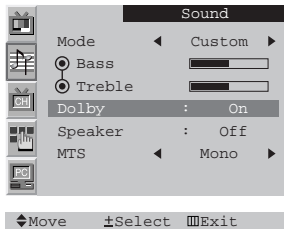

Switching the Internal Speakers On/Off

When the internal speakers are switched off, all the sound is routed to the external speakers.

Choosing the MTS (Multichannel Television Stereo)

Depending on the particular program being broadcast, you can listen to **Stereo, Mono, or Dual I/II** (Dual I/II is usually a foreign-language translation).



- You can change the sound system directly by pressing the **MTS** button on the remote control.

Switching the Sound Off Temporarily

You can switch the sound off temporarily. For example, you may wish to answer the telephone. Press the **MUTE** button and then, the sound is switched off and "⊗" is displayed. When you wish to turn the sound back on, press the **MUTE** button again or either of the volume buttons.

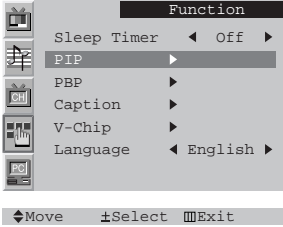
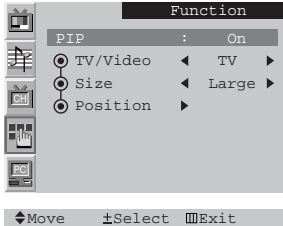
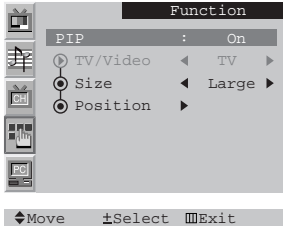
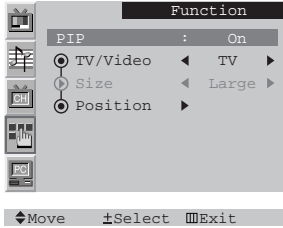
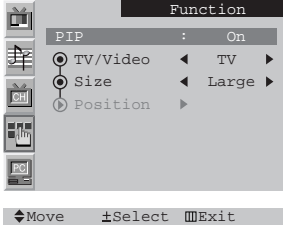

Adjusting Your LCD TV

Viewing the Picture In Picture (PIP)

Main Menu	Sub-Menus	Function Descriptions
		When external A/V devices such as VCR, DVD or RF(TV) cable are connected to the LCD TV, PIP (Picture-In-Picture) allows you to watch video from such devices in a small window superimposed on pc video signal. (It works PC mode only.)
		To activate the PIP function, set the PIP to On by pressing the - or + button. ➤ You can do directly by pressing the PIP button on the remote control.
		➤ The PIP function does not work when the V-Chip is active.
		You can select a source of the sub picture by pressing the - or + button. The sources are displayed in the following order: TV, Video, S-Video, DVD, DTV .
		You can select a size of the sub picture by pressing the - or + button. The sizes are displayed in the following order: Large, Small, Medium . ➤ You can select a size of the sub picture by pressing the SIZE button repeatedly on the remote control.
		You can select a position of the sub picture. Move the sub picture counterclockwise by pressing the - or + button. ➤ You can select a position of the sub picture by repeatedly pressing the LOCATE button on the remote control.

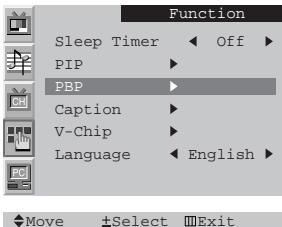
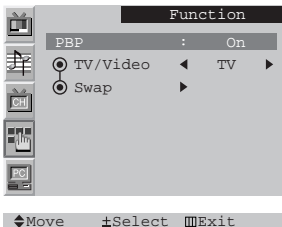

Adjusting Your LCD TV

Viewing the Picture By Picture (PBP)

Main Menu	Sub-Menus	Function Descriptions
		PBP (Picture-By-Picture) allows you to watch double screen.
		To activate the PBP function, set the PBP to On by pressing the - or + button. ➤ You can do directly by pressing the PBP button on the remote control.
		You can select a source to your viewing requirement by pressing the - or + button. The sources are displayed in the following order: TV, Video, S-Video, DVD, DTV .
		You can interchange the main picture and the sub picture by pressing the - or + button. ➤ You can do by repeatedly pressing the PBP button on the remote control.

Adjusting Your LCD TV

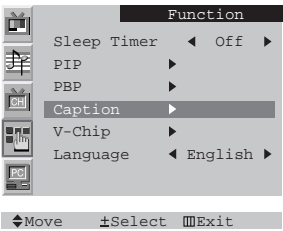
Viewing Closed Captions

Main Menu	Sub-Menus	Function Descriptions
		Your LCD TV decodes and displays the closed captions that are broadcast with certain TV shows. These captions are usually subtitles for the hearing impaired or foreign-language translations. All VCRs record the closed caption signal from television programs, so home-recorded video tapes also provide closed captions. Most pre-recorded commercial video tapes provide closed captions as well. Check for the closed caption symbol in your television schedule and on the tape's packaging:  .

➤ The Caption feature does not work with DVD or DTV signals.

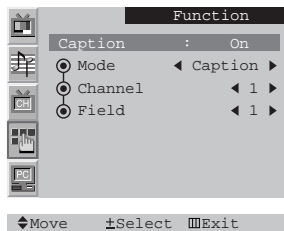

To activate the Caption function, set the **Caption** to **On** by pressing the - or + button.

➤ You can do directly by pressing the **CAPTION** button on the remote control.

➤ Misspellings and unusual characters sometimes occur during closed caption transmissions, especially those of live events. There may be a small delay before captions appear when you change channels. These are not malfunctions of your LCD TV.

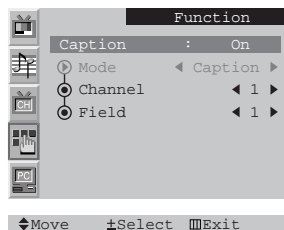

In **Caption** mode, captions appear at the bottom of the screen, and they usually cover only a small portion of the picture.

In **Text** mode, information unrelated to the program, such as news or weather, is displayed. Text often covers a large portion of the screen.

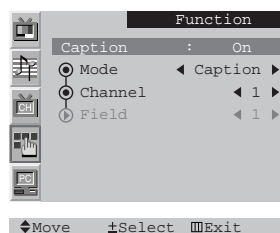
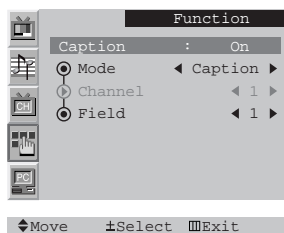

Depending on the particular broadcast, it might be necessary to make changes to **Channel** and **Field**. Different channels and fields display different information.

Adjusting Your LCD TV

Using the V-Chip

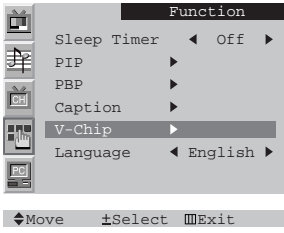
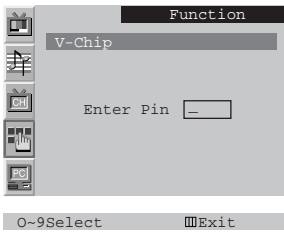
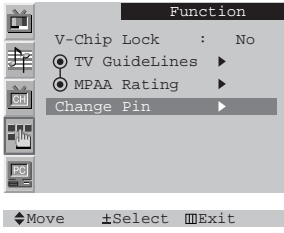
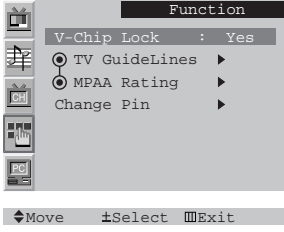
Main Menu	Sub-Menus	Function Descriptions
	 <p>Function</p> <ul style="list-style-type: none">Sleep Timer ◀ Off ▶PIP ▶PBP ▶Caption ▶V-Chip ▶Language ◀ English ▶ <p>◀ Move ▶ Select ◻ Exit</p>	<p>The V-Chip function automatically locks out programming that is deemed inappropriate for children. The user must first enter a PIN (Personal ID Number) before any of the V-Chip restrictions can be set up or changed.</p> <p>➤ When the V-Chip function is active, the PIP and channel auto program functions does not work.</p>
	 <p>Function</p> <p>V-Chip</p> <p>Enter Pin <input type="text"/></p> <p>0-9Select ◻ Exit</p>	<p>Enter your 4-digit PIN number. The default PIN number is 0000. If you enter an incorrect pin number, Incorrect message will be displayed for 3 seconds.</p> <p>➤ You can do directly by pressing the V.CHIP button on the remote control.</p>
	 <p>Function</p> <p>V-Chip Lock : No</p> <ul style="list-style-type: none">TV GuideLines ▶MPAA Rating ▶Change Pin ▶ <p>◀ Move ▶ Select ◻ Exit</p>	<p>Use the numeric buttons enter a new pin number. Confirm New Pin appears. Again, use the numeric buttons to enter the pin number you entered at the previous step. If the two pin numbers do not match, Incorrect message will be displayed for 3 seconds.</p>
	 <p>Function</p> <p>V-Chip Lock : Yes</p> <ul style="list-style-type: none">TV GuideLines ▶MPAA Rating ▶Change Pin ▶ <p>◀ Move ▶ Select ◻ Exit</p>	<p>To activate the V-Chip function, set the V-Chip Lock to Yes by pressing the - or + button.</p> <p>➤ If you forget the PIN, press the remote-control keys in the following sequence, which resets the pin to 0-0-0-0: Power Off ➔ Mute ➔ 8 ➔ 2 ➔ 4 ➔ Power On.</p>

continued...

V-Chip (US only)

The Telecommunications Act of 1996 in USA requires that every television made, starting in 1998, must be equipped with the technological device named V-Chip. The V-Chip can block certain rated television shows off television (if chosen) so children cannot watch programs that their parents do not approve. With this device, program-rating information will be transmitted along with the television signal, and be decoded by the chip in each television.

The chip will then compare the rating codes to values preset by the viewer, which is meant to be the parents. If the rating codes are higher than the preset values, the television signal will be blocked, and a blank screen will be displayed.

Adjusting Your LCD TV

Using the V-Chip

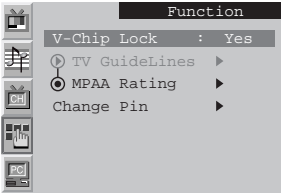
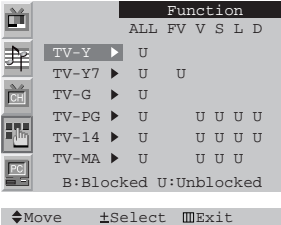
Main Menu	Sub-Menus	Function Descriptions												
	 	<h3>Setup Restrictions Using the "TV GuideLines"</h3> <p>The restrictions for these two groups work independently: If a household includes very young children as well as young adults, the TV guidelines must be set up separately for each age group.</p> <p>These categories consist of two separate groups: TV-Y and TV-Y7 (young children through age 7), and TV-G through TV-MA (everybody else).</p> <p>The V-Chip will automatically block certain categories that are "more restrictive." For example, if you block "TV-Y" category, then TV-Y7 will automatically be blocked. Similarly, if you block the TV-G category, then all the categories in the "young adult" group will be blocked (TV-G, TV-PG, TV-14 and TV-MA). The sub-ratings (V, S, L, D) work together similarly.</p> <table border="0"> <tr> <td>TV-Y : Young Children</td> <td>FV : Fantasy Violence</td> </tr> <tr> <td>TV-Y7 : Children 7 and over</td> <td>V : Violence</td> </tr> <tr> <td>TV-G : General Audience</td> <td>S : Sexual Situation</td> </tr> <tr> <td>TV-PG : Parent Guidance</td> <td>L : Coarse Language</td> </tr> <tr> <td>TV-14 : Viewers 14 and over</td> <td>D : Suggestive Dialog</td> </tr> <tr> <td>TV-MA : Mature Audience</td> <td></td> </tr> </table>	TV-Y : Young Children	FV : Fantasy Violence	TV-Y7 : Children 7 and over	V : Violence	TV-G : General Audience	S : Sexual Situation	TV-PG : Parent Guidance	L : Coarse Language	TV-14 : Viewers 14 and over	D : Suggestive Dialog	TV-MA : Mature Audience	
TV-Y : Young Children	FV : Fantasy Violence													
TV-Y7 : Children 7 and over	V : Violence													
TV-G : General Audience	S : Sexual Situation													
TV-PG : Parent Guidance	L : Coarse Language													
TV-14 : Viewers 14 and over	D : Suggestive Dialog													
TV-MA : Mature Audience														

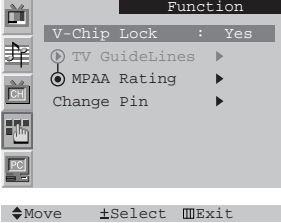
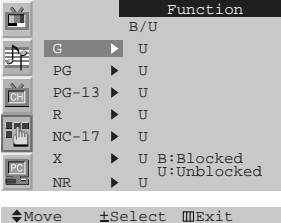
 	<h3>Setup Restrictions Using the "MPAA Rating"</h3> <p>The MPAA rating system uses the MPAA (Motion Picture Association of America) system, and its main application is for movies. (Eventually, movie videocassettes will be encoded with MPAA ratings.) When the V-Chip lock is on, the TV will automatically block any programs that are coded with objectionable ratings (either MPAA or TV-Ratings).</p> <p>The V-Chip will automatically block any category that is "more restrictive." For example, if you block the "PG-13" category, then "R," "NC-17," and "X" will automatically be blocked also.</p> <table border="0"> <tr> <td>G : General Guidance</td> </tr> <tr> <td>PG : Parental Guidance Suggested</td> </tr> <tr> <td>PG-13 : Parents Strongly Cautioned</td> </tr> <tr> <td>R : Restricted Under 17 Requires</td> </tr> <tr> <td>NC-17 : No Children Under 17 Admitted</td> </tr> <tr> <td>X : Adult Only</td> </tr> <tr> <td>NR : Not Rated</td> </tr> </table>	G : General Guidance	PG : Parental Guidance Suggested	PG-13 : Parents Strongly Cautioned	R : Restricted Under 17 Requires	NC-17 : No Children Under 17 Admitted	X : Adult Only	NR : Not Rated
G : General Guidance								
PG : Parental Guidance Suggested								
PG-13 : Parents Strongly Cautioned								
R : Restricted Under 17 Requires								
NC-17 : No Children Under 17 Admitted								
X : Adult Only								
NR : Not Rated								

Adjusting Your LCD TV

PC functions and adjustments - Image

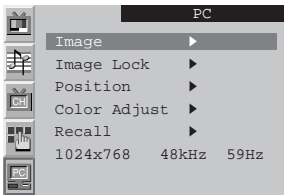
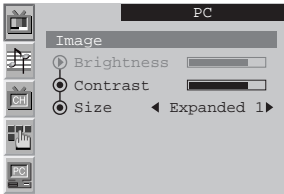
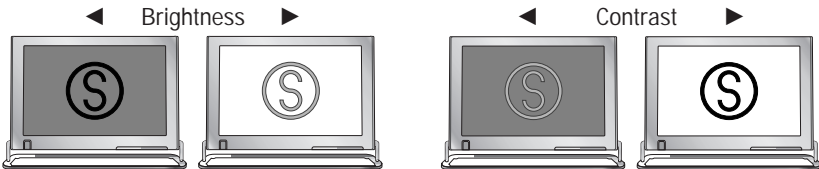
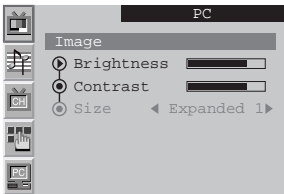
Main Menu	Sub-Menus	Function Descriptions
	 	Use the ◀ / ▶ buttons to adjust the brightness or contrast without affecting PC RGB's brightness or contrast.
		
		You can select a image size by pressing the - or + button. The sizes are displayed in the following order: Expanded 1, Expanded 2, Normal. ➤ You can select a image size by pressing the P.SIZE (Picture Size) button repeatedly on the remote control.

Adjusting Your LCD TV

PC functions and adjustments - Image Lock & Position

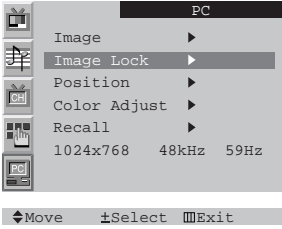
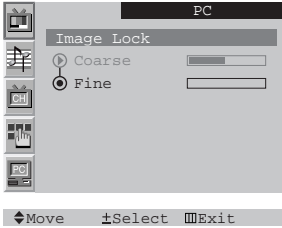
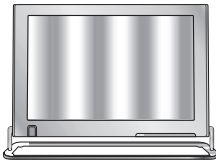
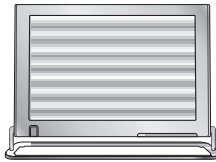
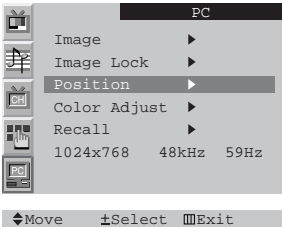
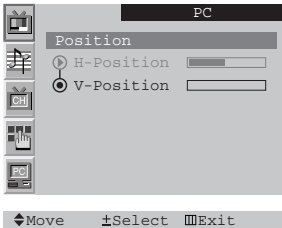
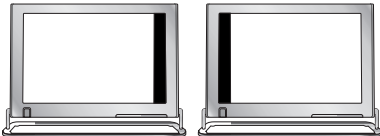
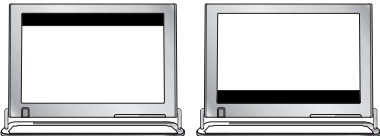
Main Menu	Sub-Menus	Function Descriptions
		<p>Image Lock is used to fine tune and get the best image by removing noises that create unstable images with jitters and shimmers.</p> <p>This function may change the width of the image. Use the H-Position menu to center the image on the screen.</p>
		<p>The Coarse and Fine adjustments allow you to fine tune the image quality of your LCD TV to your preference. Use the ◀ / ▶ buttons to remove any noise. If satisfactory results are not obtained using the Fine adjustment, use the Coarse adjustment and then use Fine again.</p>
	<p>When Coarse value is wrong.</p> 	<p>When Fine value is wrong.</p> 
		
		<p>Use the ◀ / ▶ buttons to adjust the positions (Horizontal/Vertical).</p>
	<p>◀ H-Position ▶</p> 	<p>◀ V-Position ▶</p> 

➤ The **AUTO** button allows to self-adjust to the incoming video signal. The values of fine, coarse and position are adjusted automatically.

Adjusting Your LCD TV

PC functions and adjustments - Color Adjust & Recall

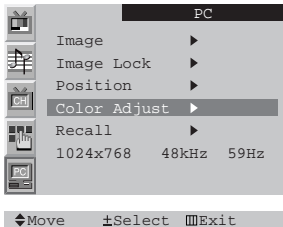
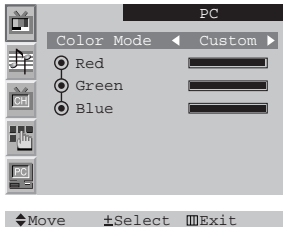
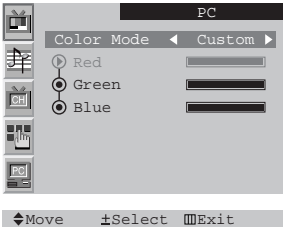
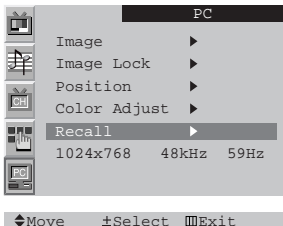
Main Menu	Sub-Menus	Function Descriptions
		Image Lock is used to fine tune and get the best image by removing noises that create unstable images with jitters and shimmers. This function may change the width of the image. Use the H-Position menu to center the image on the screen.
		Using Automatic Color Settings You can select a color mode which best corresponds to your viewing requirements by pressing the - or + button repeatedly. The following color modes are available: Custom, Color 1, Color 2, Color 3.
		Customizing the Color Select the required option (Red, Green, Blue) by pressing the ↑ or ↓ button. Then press the - or + button to adjust the value of selected option.
		All Image settings are replaced with the factory default values.

Adjusting Your LCD TV

Setting the Sleep Timer

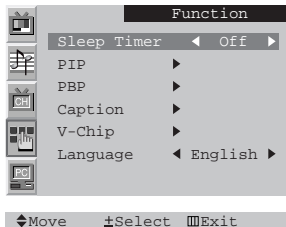
Main Menu	Sub-Menus	Function Descriptions
		<p>You can select a time period of between 10 and 240 minutes after which your LCD TV automatically switches off.</p> <p>The preset time intervals: 10, 20, 30, 60, 90, 120, 150, 180, 210, and 240 minutes.</p>
	<p>➤ Using the "SLEEP" button</p> <p>Press the SLEEP button on the remote control.</p> <p>If the sleep timer is already set, the screen displays time remaining before your LCD TV will be switched off. If the sleep timer is not yet set, displays Off.</p> <p>You can select the preset time intervals by pressing SLEEP button repeatedly.</p>	

Switching the Sound Off Temporarily

You can switch the sound off temporarily. For example, you may wish to answer the telephone. Press the **MUTE** button and then, the sound is switched off and "⊗" is displayed. When you wish to turn the sound back on, press the **MUTE** button again or either of the volume buttons.

Viewing Pictures from External Sources

Once you have connected up your various audio and video systems, you can view the different sources by selecting the appropriate input. Check that all the necessary connections have been made. Press the **SOURCE** button one or more times until the required input is displayed. Depending on the source selected, the pictures may appear automatically.

Displaying Information

You can view the setting status of selected source by pressing the **DISPLAY** button on the remote control. The displayed information are different depending on the selected source.

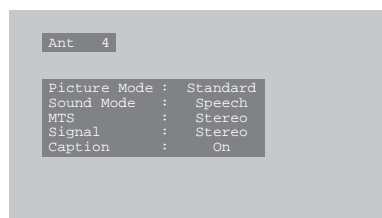

- Example: TV mode

Adjusting Your LCD TV

PC Display Modes

If the signal from the system equals to the standard signal mode, the screen is adjusted automatically. If the signal from the system doesn't equal to the standard signal mode, adjust the mode with referring to the Video card user guide because the screen might not display or only the power LED might be on. For the display modes listed below, the screen image has been optimized during manufacture.

Mode	Resolution	Horizontal Frequency (kHz)	Vertical Frequency (Hz)	Pixel Clock Frequency (MHz)	Sync Polarity (H/V)
HDTV Format	1280 x 720p	44.955	59.94	74.176	+/-, +/-
	1920 x 1080i	33.716	59.94i	74.176	+/-, +/-
VGA	720 x 400	31.469	70.087	28.322	-/+
	640 x 480	31.469	59.940	25.175	-/-
	640 x 480	37.500	75.000	31.500	-/-
	640 x 480	43.269	85.008	36.000	-/-
SVGA	800 x 600	46.875	75.000	49.500	+/+
	800 x 600	53.674	85.061	56.250	+/+
XGA	1024 x 768	48.363	60.004	65.000	-/-
	1024 x 768	60.023	75.029	78.750	+/+
	1024 x 768	68.677	84.997	94.500	+/+
SXGA	1280 x 1024	63.981	60.020	108.000	+,-/+,-
	1280 x 1024	79.976	75.025	135.000	+/+
UXGA	1600 x 1200	75.000	60.000	162.000	+/-, +/-
WUXGA (LTM245W)	1920 x 1200	75.000	60.000	193.156	+/-, +/-

PowerSaver

This LCD TV has a built-in power management system called PowerSaver. This system saves energy by switching your LCD TV into a low-power mode when it has not been used for a certain period of time. The available modes are "On", "Standby", "Sleep", and "Deep Sleep". PowerSaver operates with a VESA DPMS compliant video card installed in your computer. You use a software utility installed on your computer to set up this feature.

State	Normal Operation	Power-Saving Function mode (EPA/NUTEK)
Horizontal Sync	Active	Inactive
Vertical Sync	Active	Inactive
Power Indicator	Green	Green, Blinking (1 sec interval)
Power Consumption	LTM215 : 110W (Max.) LTM245W : 120W (Max.)	Less than 8W

➤ This LCD TV automatically returns to normal operation when horizontal and vertical sync return. This occurs when you move the computer's mouse or press a key on the keyboard.

This LCD TV is EPA ENERGY STAR[®] compliant and NUTEK compliant when used with a computer equipped with VESA DPMS functionality. For energy conservation, turn your LCD TV Off when you are not using it or when leaving it unattended for long periods.

Troubleshooting - Image

If you have a problem setting up or using your LCD TV, you may be able to solve it yourself. Before contacting customer service, try the suggested actions that are appropriate to your problem.

What you see...	Suggested Actions
Screen is black and power indicator is off	<ul style="list-style-type: none">◆ Ensure that the power cord is firmly connected and the LCD TV is on.
"Check Signal Cable" message	<ul style="list-style-type: none">◆ Ensure that the signal cable is firmly connected to the PC or video sources.◆ Ensure that the PC or video sources are turned on.
"Sync. Out of Range" message	<ul style="list-style-type: none">◆ Check the maximum resolution and the frequency of the video adapter.◆ Compare these values with the data in the Display Modes Timing Chart.
The image is too light or too dark	<ul style="list-style-type: none">◆ Adjust the Brightness and Contrast.
Horizontal bars appear to flicker, jitter or shimmer on the image	<ul style="list-style-type: none">◆ Adjust the Fine function.
Vertical bars appear to flicker, jitter or shimmer on the image.	<ul style="list-style-type: none">◆ Adjust the Coarse function and then adjust the Fine function.
Screen is black and power indicator light is steady amber or blinks every 0.5 or 1 seconds	<ul style="list-style-type: none">◆ The LCD TV is using its power management system.◆ Move the computer's mouse or press a key on the keyboard.
Image is not stable and may appear to vibrate	<ul style="list-style-type: none">◆ Check that the display resolution and frequency from your PC or video board is an available mode for your LCD TV. On your computer check: Control Panel, Display, Settings.◆ If the setting is not correct, use your computer utility program to change the display settings.<ul style="list-style-type: none">➤ Your LCD TV supports multiscan display functions within the following frequency domain: Horizontal frequency: 30~85kHz Vertical frequency: 55~85Hz
Image is not centered on the screen.	<ul style="list-style-type: none">◆ Adjust the horizontal and vertical position.
You need the monitor driver software	<ul style="list-style-type: none">◆ Download the driver from WWW pages: http://www.samsung-monitor.com http://www.samsungmonitor.com (USA Only)

Troubleshooting - Audio & TV

Problem	Suggested Actions
No sound	<ul style="list-style-type: none">◆ Ensure that the audio cable is firmly connected to both the audio-in port on your LCD TV and the audio-out port on your sound card.◆ Check the volume level.
Sound level is too low	<ul style="list-style-type: none">◆ Check the volume level.◆ If the volume is still too low after turning the control to its maximum, check the volume control on the computer sound card or software program.
Sound is too high pitched or too low pitched	<ul style="list-style-type: none">◆ Adjust the Treble and Bass to appropriate level.
TV signal is not received	<ul style="list-style-type: none">◆ Select "Channel auto program" to configure the channel system automatically.◆ Check "TV Tuner Box".

Technical and Environmental Specifications

Model	LTM215	LTM245W
Panel		
Size	21.3" Diagonal	24.06" Diagonal
Display Size	432(H) x 324(V) mm	518.4(H) x 324(V) mm
Type	a-si TFT active matrix	
Pixel pitch	0.27 (H) x 0.27 (V) mm	
Viewing Angle	80/80/80/80 (L/R/T/B)	
Frequency		
Horizontal	30 ~ 85 kHz	
Vertical	55 ~ 85 Hz	
Display color	16,777,216 colors	
Display Resolution		
Maximum Mode	1600 x 1200 @ 60 Hz	1920 x 1200 @ 60 Hz
Input Signal		
Sync.	H/V Separate, TTL, P. or N. H/V Composite, TTL, P. or N. Sync-on-green 0.3 Vp-p, N.	
Video signal	0.7 Vp-p @ 75 ohm	
TV, Video		
Color system	NTSC	
Sound system	M/N	
Video format	CVBS, S-VHS	
Component		
DTV	YPbPr Composite sync. 1080i, 720p, 480p	
DVD	YPbPr Composite sync. 480p, 480i	
Video signal	0.7 Vp-p @ 75 ohm	
Color system		
	NTSC	
Power Supply		
Input	AC 90 ~ 264 Vrms (50Hz / 60Hz)	
Output	DC 14V/8A	
Power Consumption		
Maximum	110 W	120 W
Power Saving	< 8 W	
Environmental Considerations		
Operating Temperature	50 °F to 104 °F (10 °C to 40 °C)	
Operating Humidity	10% to 80%	
Storage Temperature	- 13 °F to 113 °F (-25 °C to 45 °C)	
Storage Humidity	5% to 95%	
Audio Characteristics		
Audio Input 1	RCA Jack Red(R) White(L), 0.5Vrms (-9dB)	
Audio Input 2	3.5Ø Stereo Jack, 0.5Vrms (-9dB)	
Audio Input 3	RCA Jack Red(R) White(L), 0.5Vrms (-9dB)	
Headphone out	Max. 10mW Output (3.5Ø Stereo Jack 32Ω)	
Frequency Response	RF: 80Hz ~ 15kHz (at- 3dB) A/V: 80Hz ~ 20kHz (at - 3dB)	

Regulatory Information

User Instructions

The Federal Communications Commission Radio Frequency Interference Statement includes the following warning:

Note: This equipment has been tested and found to comply with the limits for a Class B digital device, pursuant to Part 15 of the FCC Rules. These limits are designed to provide reasonable protection against harmful interference in a residential installation. This equipment generates, uses, and can radiate radio frequency energy and, if not installed and used in accordance with the instructions, may cause harmful interference to radio communications. However, there is no guarantee that interference will not occur in a particular installation.

If this equipment does cause harmful interference to radio or television receptions, which can be determined by turning the equipment off and on, the user is encouraged to try to correct the interference by one or more of the following measures:

- ◆ Reorient or relocate the receiving antenna.
- ◆ Increase the separation between the equipment and receiver.
- ◆ Connect the equipment into an outlet on a circuit different from that to which the receiver is connected.
- ◆ Consult the dealer or an experienced radio/TV technician for help.

User Information

Changes or modifications not expressly approved by the party responsible for compliance could void the user's authority to operate the equipment.

If necessary, consult your dealer or an experienced radio/television technician for additional suggestions. You may find the booklet called How to Identify and Resolve Radio/TV Interference Problems helpful. This booklet was prepared by the Federal Communications Commission. It is available from the U.S. Government Printing Office, Washington, DC 20402, Stock Number 004-000-00345-4.

Warning

User must use shielded signal interface cables to maintain FCC compliance for the product.

Declaration of conformity for products Marked with FCC Logo

This device complies with Part 15 of the FCC Rules. Operation is subject to the following two conditions: (1) this device may not cause harmful interference, and (2) this device must accept any interference received, including interference that may cause undesired operation.

The party responsible for product compliance:
SAMSUNG ELECTRONICS CO., LTD
America QA Lab of Samsung
85 West Tasman Drive
San Jose, CA 95134 USA
Tel) 408-544-5124
Fax) 408-544-5191

Provided with this monitor is a detachable power supply cord with IEC320 style terminations. It may be suitable for connection to any UL Listed personal computer with similar configuration. Before making the connection, make sure the voltage rating of the computer convenience outlet is the same as the monitor and that the ampere rating of the computer convenience outlet is equal to or exceeds the monitor voltage rating. For 120 Volt applications, use only UL Listed detachable power cord with NEMA configuration 5-15P type (parallel blades) plug cap. For 240 Volt applications use only UL Listed Detachable power supply cord with NEMA configuration 6-15P type (tandem blades) plug cap.

IC Compliance Notice

This Class B digital apparatus meets all requirements of the Canadian Interference-Causing Equipment Regulations of ICES-003.

Notice de Conformité IC

Cet appareil Numérique de classe B respecte toutes les exigences du Règlement ICES-003 sur les équipements produisant des interférences au Canada.

MPR II Compliance

This monitor complies with SWEDAC(MPR II) recommendations for reduced electric and magnetic fields.

Regulatory Information

U.S.A.

Samsung Computer Products Customer Service
400 Valley Road, Suite 201, Mt. Arlington, NJ 07856
Tel. : (973)601-6000, 1-800-SAMSUNG (1-800-726-7864)
Fax. : (973)601-6001
<http://samsungmonitor.com/>

BRAZIL

Samsung Eletronica da Amazonia Ltda.
R. Prof. Manoelito de Ornellas, 303, Terro B
Chacara Sto. Antonio, CEP : 04719-040
Sao Paulo, SP
SAC : 0800 124 421
<http://www.samsung.com.br/>

CANADA

Samsung Electronics Canada Inc.
7037 Financial Drive
Mississauga, Ontario L5N 6R3
Tel. : 1-800-SAMSUNG (1-800-726-7864)
Fax. : (905) 542-1199
<http://www.samsung.ca>

COLOMBIA

Samsung Electrinics Colombia
Cra 9 No 99A-02 Of. 106
Bogota, Colombia
Tel.: 9-800-112-112
Fax: (571) 618 - 2068
<http://www.samsung-latin.com/>
e-mail : soporte@samsung-latin.com

MEXICO

Samsung Electronics Mexico S.A. de C.V.
Saturno 44 Col. Nueva Industrial Vallejo
Del. Gustavo A. Madero C.P. 07700
Mexico D.F.
Tel. 01 57 47 51 00
Fax. 01 57 47 52 02
RFC: SEM950215S98
<http://www.samsung.com.mx/>

PANAMA

Samsung Electronics Latinoamerica (Z.L.) S.A.
Calle 50 Edificio Plaza Credicorp, Planta Baja
Panama
Tel. : (507) 210-1122, 210-1133
Tel : 800-3278(FAST)
<http://www.samsung-latin.com/>

PERU

Servicio Integral Samsung
Av.Argentina 1790 Lima1. Peru
Tel: 51-1-336-8686
Fax: 51-1-336-8551
<http://www.samsungperu.com>

IMPORTADO POR: SAMSUNG ELECTRONICS MEXICO S.A. DE C.V. SATURNO 44 COL. NVA. INDUSTRIAL VALLEJO DEL. GUSTAVO A. MADERO C.P. 07700 MEXICO D.F. TEL. 5747-5100 RFC: SEM950215S98
EXPORTADO POR: SAMSUNG ELECTRONICS CO.,LTD. JOONG-ANG DAILY NEWS BLDG. 7 SOON-WHA-DONG CHUNG-KU, C.P.O BOX 2775, 1144 SEOUL, KOREA

Memo

