

**SAMSUNG**

**LTM225W**

**TFT-LCD TELEVISION**

**SAMSUNG**

**ELECTRONICS**

**Samsung Electronics America Inc.**

400 Valley Road, Suite 201, Mt. Arlington, NJ 07856

**SERVICE DIVISION**

TEL: 1-800-SAMSUNG (1-800-726-7864)

[www.samsungusa.com](http://www.samsungusa.com)

**Owner's  
Instructions**

# **Warning! Important Safety Instructions**



**CAUTION: TO REDUCE THE RISK OF ELECTRIC SHOCK, DO NOT REMOVE COVER (OR BACK). NO USER SERVICEABLE PARTS INSIDE. REFER SERVICING TO QUALIFIED SERVICE PERSONNEL.**

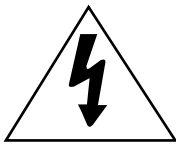

This symbol indicates high voltage is present inside. It is dangerous to make any kind of contact with any inside part of this product.



This symbol alerts you that important literature concerning operation and maintenance has been included with this product.

*Note to CATV system installer:* This reminder is provided to call CATV system installer's attention to Article 820-40 of the National Electrical Code (Section 54 of Canadian Electrical Code, Part I), that provides guidelines for proper grounding and, in particular, specifies that the cable ground shall be connected to the grounding system of the building as close to the point of cable entry as practical.

*Caution: FCC/CSA regulations state that any unauthorized changes or modifications to this equipment may void the user's authority to operate it.*

*Caution: To prevent electric shock, match the wide blade of plug to the wide slot, and fully insert the plug.*

*Attention: pour éviter les chocs électriques, introduire la lame le plus large de la fiche dans la borne correspondante de la prise et pousser jusqu'au fond.*

*Important:* One Federal Court has held that unauthorized recording of copyrighted TV programs is an infringement of U.S. copyright laws. Certain Canadian programs may also be copyrighted and any unauthorized recording in whole or in part may be in violation of these rights.

**To prevent damage which may result in fire or electric shock hazard, do not expose this appliance to rain or moisture.**

# Thank You for Choosing Samsung

Thank you for choosing Samsung! Your new Samsung TV represents the latest in television technology. We designed it with easy-to-use on-screen menus and closed captioning capabilities, making it one of the best products in its class. We are proud to offer you a product that will provide convenient, dependable service and enjoyment for years to come.

## Important Safety Information

 Always be careful when using your TV receiver. To reduce the risk of fire, electrical shock, and other injuries, keep these safety precautions in mind when installing, using, and maintaining your machine.

- Read all safety and operating instructions before operating your TV.
- Keep the safety and operating instructions for future reference.
- Heed all warnings on the TV receiver and in the operating instructions.
- Follow all operating and use instructions.
- Unplug the TV receiver from the wall outlet before cleaning. Use a damp cloth; do not use liquid or aerosol cleaners.
- Never add any attachments and/or equipment without approval of the manufacturer. Such additions can increase the risk of fire, electric shock, or other personal injury.
- Do not use the TV receiver where contact with or immersion in water is a possibility, such as near bath tubs, sinks, washing machines, swimming pools, etc.
- Do not place the TV on an unstable cart, stand, tripod, bracket, or table where it can fall. A falling TV can cause serious injury to a child or adult, and serious damage to the appliance. Use only with a cart, stand, tripod, bracket, or table recommended by the manufacturer or sold with the TV. Follow the manufacturer's instructions when mounting the unit, and use a mounting accessory recommended by the manufacturer. Move the TV and cart with care. Quick stops, excessive force, and uneven surfaces can make the unit and cart unsteady and likely to overturn.
- Provide ventilation for the TV receiver. The unit is designed with slots in the cabinet for ventilation to protect it from overheating. Do not block these openings with any object, and do not place the TV receiver on a bed, sofa, rug, or other similar surface. Do not place it near a radiator or heat register. If you place the TV receiver on a rack or bookcase, ensure that there is adequate ventilation and that you've followed the manufacturer's instructions for mounting.
- Operate your TV receiver only from the type of power source indicated on the marking label. If you are not sure of the type of power supplied to your home, consult your appliance dealer or local power company.
- Use only a grounded or polarized outlet. For your safety, this TV is equipped with a polarized alternating current line plug having one blade wider than the other. This plug will fit into the power outlet only one way. If you are unable to insert the plug fully into the outlet, try reversing the plug. If the plug still does not fit, contact your electrician to replace your outlet.



- Protect the power cord. Power supply cords should be routed so that they won't be walked on or pinched by objects placed on or against them. Pay particular attention to cords at plugs, convenience receptacles, and the point where they exit from the unit.
- Unplug the TV from the wall outlet and disconnect the antenna or cable system during a lightning storm or when left unattended and unused for long periods of time. This will prevent damage to the unit due to lightning and power-line surges.
- Avoid overhead power lines. An outside antenna system should not be placed in the vicinity of overhead power lines or other electric light or power circuits or where it can fall into such power lines or circuits. When installing an outside antenna system, be extremely careful to keep from touching the power lines or circuits. Contact with such lines can be fatal.
- Do not overload the wall outlet or extension cords. Overloading can result in fire or electric shock.
- Do not insert anything through the openings in the unit, where they can touch dangerous voltage points or damage parts. Never spill liquid of any kind on the TV.

- Ground outdoor antennas. If an outside antenna or cable system is connected to the TV, be sure the antenna or cable system is grounded so as to provide some protection against voltage surges and built-up static charges. Section 810 of the National Electrical Code, ANSI/NFPA No.70-1984, provides information about proper grounding of the mast and supporting structure, grounding of the lead-in wire to an antenna discharge unit, size of grounding conductors, location of antenna discharge unit, connection to grounding electrodes, and requirements for the grounding electrode.

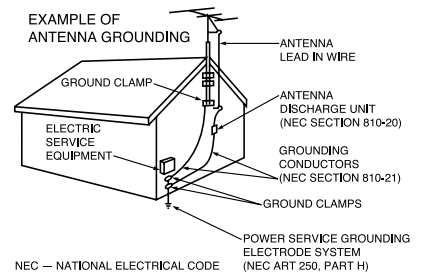

- Do not attempt to service the TV yourself. Refer all servicing to qualified service personnel. Unplug the unit from the wall outlet and refer servicing to qualified service personnel under the following conditions:
  - when the power-supply cord or plug is damaged
  - if liquid has been spilled on the unit or if objects have fallen into the unit
  - if the TV has been exposed to rain or water
  - if the TV does not operate normally by following the operating instructions
  - if the TV has been dropped or the cabinet has been damaged
  - when the TV exhibits a distinct change in performance
- If you make adjustments yourself, adjust only those controls that are covered by the operating instructions. Adjusting other controls may result in damage and will often require extensive work by a qualified technician to restore the TV to normal.
- When replacement parts are required, be sure the service technician uses replacement parts specified by the manufacturer or those that have the same characteristics as the original part. Unauthorized substitutions may result in additional damage to the unit.
- Upon completion of any service or repairs to this TV, ask the service technician to perform safety checks to determine that the TV is in a safe operating condition.

- Keep all power adapters apart.  
->Possible fire hazard.
- Keep power adapter away from any other heat source.  
->Possible fire hazard.
- Remove and discard vinyl bag from power adapter before use.  
->Possible fire hazard.
- Always keep power adapters in well-ventilated area.

# FCC Information

## Information to the user

NOTE: This equipment has been tested and found to comply with the limits for a Class B digital device, pursuant to Part 15 of the FCC Rules. These limits are designed to provide reasonable protection against harmful interference in a residential installation. This equipment generates, uses and can radiate radio frequency energy and, if not installed and used in accordance with the instructions, may cause harmful interference to radio communications. However, there is no guarantee that interference will not occur in a particular installation. If this equipment does cause harmful interference to radio or television reception, which can be determined by turning the equipment off and on, the user is encouraged to try to correct the interference by one or more of the following measures:

- Reorient or relocate the receiving antenna.
- Increase the separation between the equipment and receiver.
- Connect the equipment into an outlet on a different from that to which the receiver is connected.
- Consult the dealer or an experienced radio/TV technician for help.

Changes or modifications not expressly approved by the party responsible for compliance could void the user's authority to operate the equipment.

## Warning

User must use shielded signal interface cables to maintain FCC compliance for the product.

The party responsible for product compliance:

SAMSUNG ELECTRONICS CO., LTD  
America QA Lab of Samsung  
85 West Tasman Drive  
Irvine, CA 95134 USA

Provided with this monitor is a detachable power supply cord with IEC320 style terminations. It may be suitable for connection to any UL Listed personal computer with similar configuration. Before making the connection, make sure the voltage rating of the computer convenience outlet is the same as the monitor and that the ampere rating of the computer convenience outlet is equal to or exceeds the monitor voltage rating.

For 120 Volt applications, use only UL Listed detachable power cord with NEMA configuration 5-15P type (parallel blades) plug cap. For 240 Volt applications use only UL Listed Detachable power supply cord with NEMA configuration 6015P type (tandem blades) plug cap.

## IC Compliance Notice

This Class B digital apparatus meets all requirements of the Canadian Interference-Causing Equipment Regulations of ICES-003.

## Notice de Conformité IC

Cet appareil numérique de classe B respecte toutes les exigences du Règlement ICES-003 sur les équipements produisant des interférences au Canada.

## VCCI

This is a Class B product based on the standard of the Voluntary Control Council for Interference by Information Technology Equipment (VCCI). If this is used near a radio or television receiver in a domestic environment, it may cause radio interference. Install and use the equipment according to the instruction manual.

<b>Chapter 1: Your New TV</b> .....	<b>1.1</b>
List of Features .....	1.1
List of Parts .....	1.1
Familiarizing Yourself with Your New TV .....	1.2
Front Panel Buttons .....	1.2
Rear Panel Jacks .....	1.3
Remote Control .....	1.4
 <b>Chapter 2: Installation</b> .....	 <b>2.1</b>
Connecting VHF and UHF Antennas .....	2.1
Antennas with 300-ohm Flat Twin Leads .....	2.1
Antennas with 75-ohm Round Leads .....	2.2
Separate VHF and UHF Antennas .....	2.2
Connecting Cable TV .....	2.2
Cable without a Cable Box .....	2.2
Connecting to a Cable Box that Descrambles All Channels .....	2.3
Connecting to a Cable Box that Descrambles Some Channels .....	2.3
Connecting a VCR .....	2.5
Connecting an S-VHS VCR .....	2.6
Connecting a DVD Player .....	2.7
Connecting a Digital TV Set-Top Box .....	2.7
Connecting a PC .....	2.8
Connecting to an Audio System and Sub-woofer .....	2.9
Installing Batteries in the Remote Control .....	2.9
 <b>Chapter 3: Operation</b> .....	 <b>3.1</b>
Turning the TV On and Off .....	3.1
Plug & Play Feature .....	3.1
Viewing the Menus and On-Screen Displays .....	3.3
Viewing the Menus .....	3.3
Viewing the Display .....	3.3
Selecting a Menu Language .....	3.4
Memorizing the Channels .....	3.5
Selecting the Video Signal-source .....	3.5
Storing Channels in Memory (Automatic Method) .....	3.6
Adding and Erasing Channels (Manual Method) .....	3.7
Changing Channels .....	3.7
Using the Channel Buttons .....	3.7
Directly Accessing Channels .....	3.7
Using the Pre-CH Button to select the Previous Channel .....	3.7
Adjusting the Volume .....	3.8
Using Mute .....	3.8
Setting the Clock .....	3.9
Customizing the Picture .....	3.10
Using Automatic Picture Settings .....	3.11
Customizing the Sound .....	3.12
Using Automatic Sound Settings .....	3.13
Viewing a VCR or Camcorder Tape .....	3.14

<b>Chapter 4: Special Features</b>	<b>4.1</b>
Fine Tuning Channels	4.1
LNA (Low Noise Amplifier)	4.2
Setting the Blue Screen Mode	4.3
Changing the Screen Size	4.4
Freezing the Picture	4.4
Special Sound Options	4.5
Choosing a Multi-Channel Sound (MTS) Soundtrack	4.5
Auto Volume	4.6
Virtual Dolby	4.7
Adjusting the Headphone Sound	4.8
Selecting the Sound	4.9
Setting the On/Off Timer	4.10
Viewing Closed Captions	4.12
Viewing Picture-in-Picture	4.13
Activating Picture-in-Picture	4.13
Selecting a Signal Source (External A/V) for PIP	4.14
Swapping the Contents of the PIP and Main image	4.14
Changing the PIP Channel	4.14
Changing the Location of the PIP Window	4.14
Changing the Size of the PIP Window	4.14
Using the V-Chip	4.15
Setting Up Your Personal ID Number (PIN)	4.15
How to Enable/Disable the V-Chip	4.16
How to Set up Restrictions Using the “TV guidelines”	4.16
How to Set up Restrictions using the MPAA Ratings:	
G, PG, PG-13, R, NC-17, X	4.18
How to Reset the TV after the V-Chip	
Blocks a Channel (“Emergency Escape”)	4.19
 <b>Chapter 5: PC Display</b>	 <b>5.1</b>
Using Your TV as a Computer (PC) Display	5.1
How to Set up Your PC Software (Windows only)	5.1
Adjusting the Screen Quality	5.2
Changing the Screen Position	5.3
Changing the Screen Color Standard	5.4
Adjusting the Screen Color Settings	5.5
 <b>Chapter 6: Troubleshooting</b>	 <b>6.1</b>
Identifying Problems	6.1
 <b>Appendix</b>	 <b>A.1</b>
Display Modes	A.1
Installing VESA compliant mounting devices	A.2
Attaching a Wall or Arm mounting device	A.3
Using the Anti-Theft Kensington Lock	A.4
Pin Assignments	A.5
Cleaning and Maintaining Your TV	A.5
Using Your TV in Another Country	A.5
Specifications	A.6



# Chapter One

## YOUR NEW TV

### List of Features

Your TV was designed with the latest technology. This TV is a high-performance unit that includes the following special features:

- Easy-to-use remote control
- Easy-to-use on-screen menu system
- Automatic timer to turn the TV on and off
- Adjustable picture and sound settings that can be stored in the TV's memory
- Automatic channel tuning for up to 181 channels
- A special filter to reduce or eliminate reception problems
- Fine tuning control for the sharpest picture possible
- A built-in multi-channel sound decoder for stereo and bilingual listening
- Built-in, dual channel speakers
- Headphone jack for private listening
- 16:9 letter box format available depending upon source

### List of Parts

Please make sure the following items are included with your LCD TV. If any items are missing, contact your dealer.

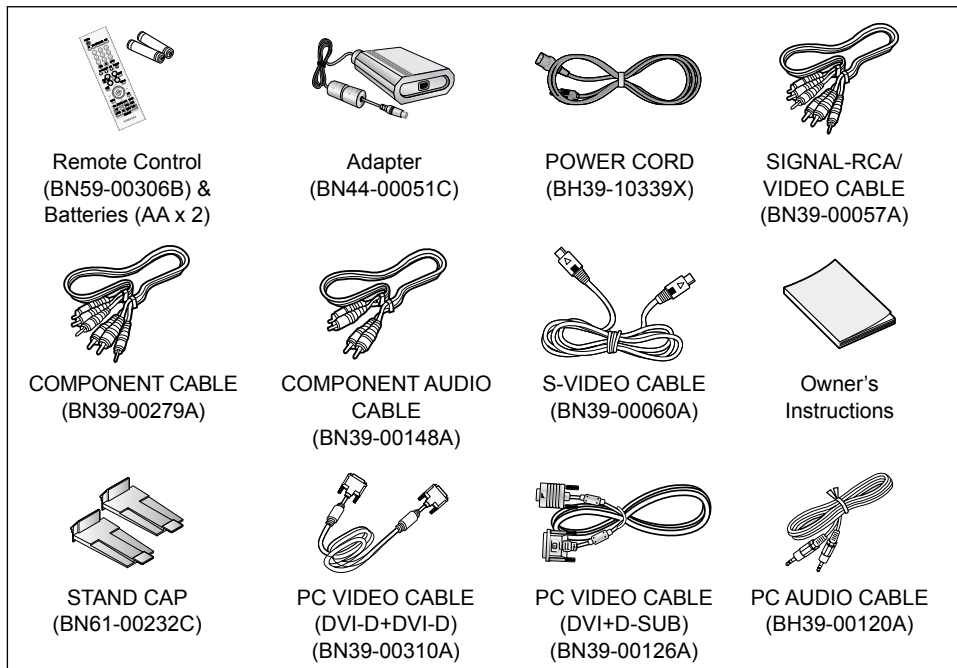

## Familiarizing Yourself with The TV

### Front Panel Buttons

The buttons on the front panel control your TV's basic features, including the on-screen menu. To use the more advanced features, you must use the remote control.

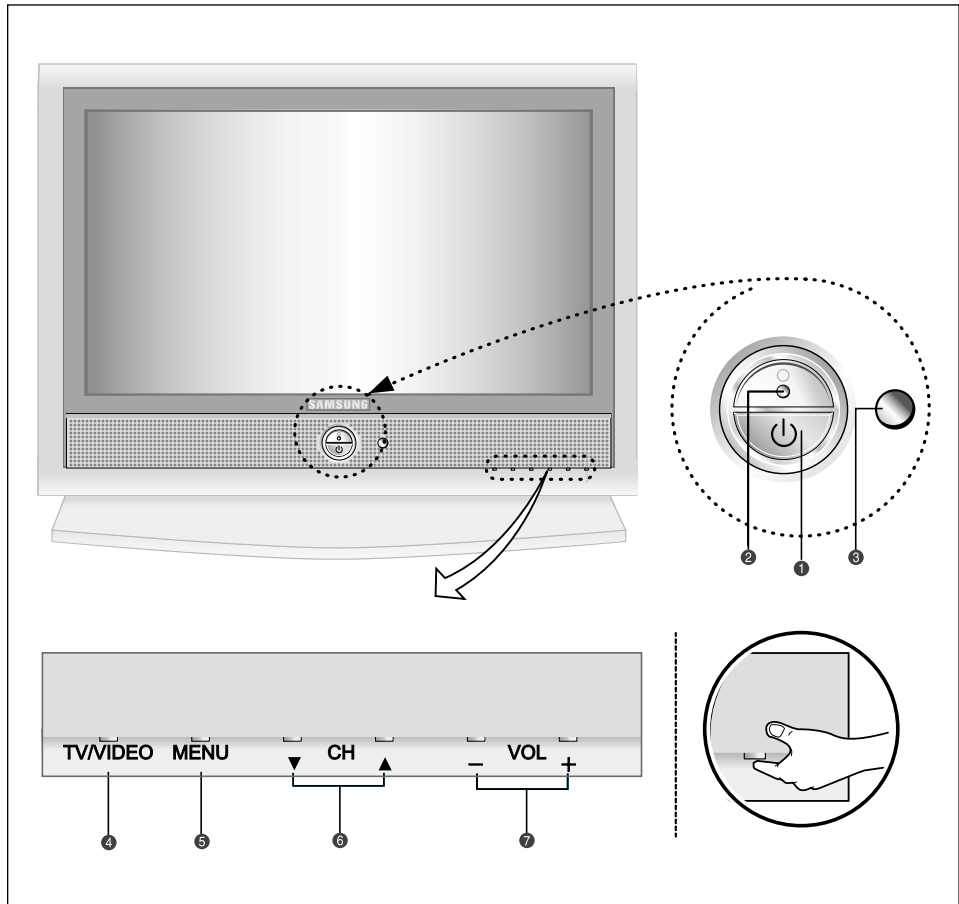

- 1 Power**  
Press to turn the TV on and off.
- 2 Power Indicator**  
Lights up when you turn the power off.
- 3 Remote Control Sensor**  
Aim the remote control towards this spot on the TV.
- 4 TV/VIDEO**  
Displays a menu of all of the available input sources (TV, VIDEO, S-VIDEO, Component 1, Component 2, PC/DVI).
- 5 MENU**  
Press to see an on-screen menu of your TV's features.
- 6 ▼ CH ▲**  
Press to change channels.  
Also press to highlight various items on the on-screen menu.
- 7 – VOL +**  
Press to increase or decrease the volume.  
Also used to select items on the on-screen menu.

### Rear Panel Jacks

Use the rear panel jacks to connect an A/V component that will be connected continuously, such as a VCR or a DVD player.

For more information on connecting equipment, see pages 2.1 – 2.9.

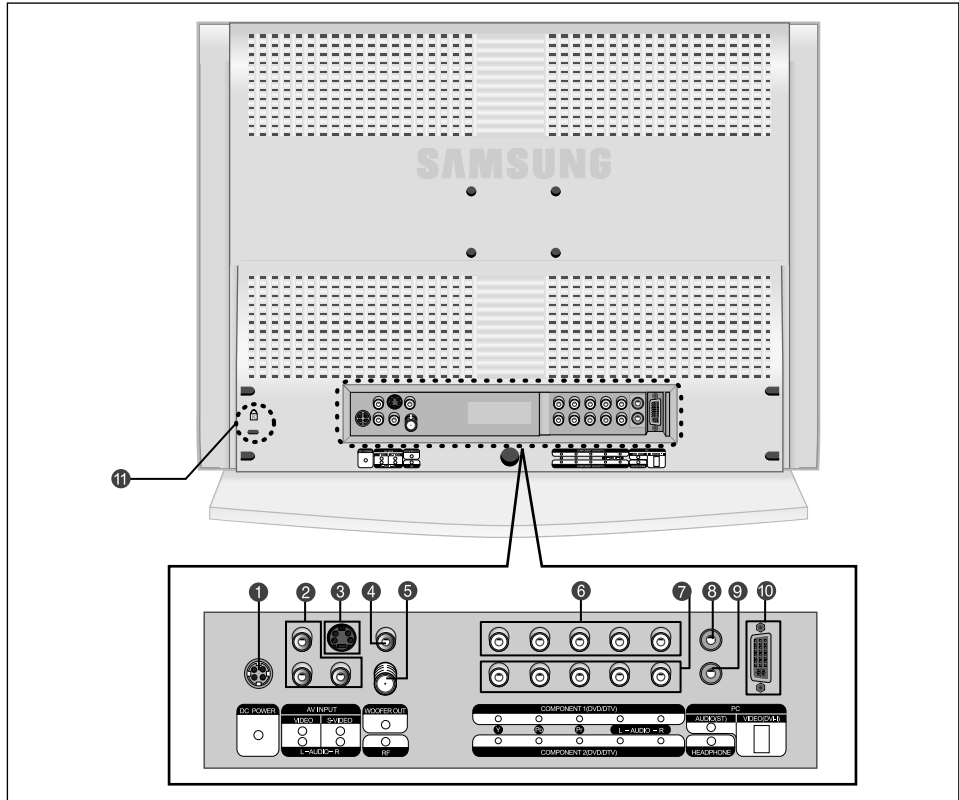

**1 DC POWER INPUT**

**2 VIDEO/AUDIO IN jack**

Used to connect a video/audio signal from a camcorder or a video game.

**3 SUPER VIDEO IN jack**

Used to connect an S-Video signal from a camcorder or a video game.

**4 WOOFER OUTPUT**

Connect RCA audio cable system or external amplifier.  
(Option : Active Woofer 500mV RMS at 20-150Hz)

**5 TV ANTENNA**

Connects to an antenna or to a cable TV system.

**6 COMPONENT 1(DVD/DTV)**

Connects component video/audio from a DVD player.

**7 COMPONENT 2 (DVD/DTV)**

Connects component video/audio from a Set-Top Box.

**8 PC AUDIO INPUT**

Connect these to the audio-output jacks on your PC.

**9 HEADPHONE jack**

Connect a set of external headphones to this jack for private listening.

**10 PC VIDEO(DVI-I) INPUT**

Connect to the video output port on your PC.

**11 Kensington lock**

(See page A.4)

## Remote Control

### Frequently Used Buttons

**1 POWER**

Turns the TV on and off.

**2 MODE**

Selects a target device to controlled by the Samsung remote control (TV, VCR, Cable box or DVD).

**3 VOL +, VOL -**

Press to increase or decrease the volume.

**4 MUTE**

Press to temporarily cut off the sound.

**5 MENU**

Displays the main on-screen menu.

**6 Number buttons**

Press to select channels directly on the TV.

**7 CH ^ and CH v (Channel Up/Down)**

Press CH ^ or CH v to change channels.

**8 JOYSTICK**

Use to select on-screen menu items and change menu values. (The remote control will only function with VCR or DVD units that are compatible with the LCD TV.)

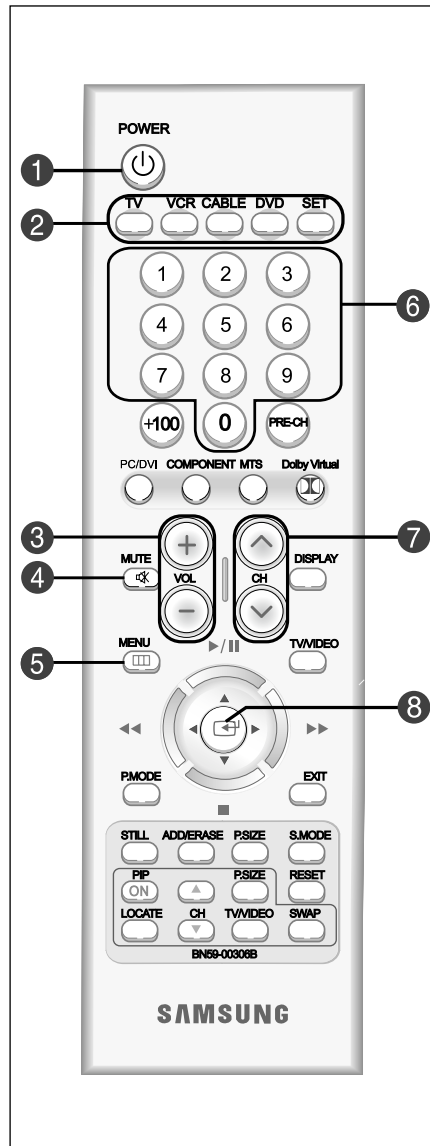

# YOUR NEW TV

## Convenient Buttons

### 1 +100

Press to select channels over 100.  
For example, to select channel 121, press "+100", then press "2" and "1".

### 2 COMPONENT

Press to switch to the COMPONENT mode.

### 3 PC/DVI

Press to switch to the PC mode.

### 4 Menu adjustment and Video or DVD adjustment button

Moves or adjusts Menu.  
Adjusts the function of Video or DVD.

### 5 P.MODE

Adjusts the TV picture by selecting one of the preset factory settings.

### 6 ADD/ERASE

Press to add or erase channels in the TV's memory.

### 7 STILL

Press to stop the action during a particular scene. Press again to resume normal video.

### 8 PIP controls CH

Displays the available channels in sequence.

(These buttons change channels in the PIP window only.)

#### **P.SIZE**

Press to make the PIP window double, large or small.

#### **LOCATE**

Press to move the PIP window to any of the four corners of the TV screen.

#### **TV/VIDEO**

Press to select one of the available signal sources for the PIP window.

#### **SWAP**

Exchanges the video signal that is currently displayed on the main screen with the signal in the PIP window.

(While the main screen is in PC mode, it does not work.)

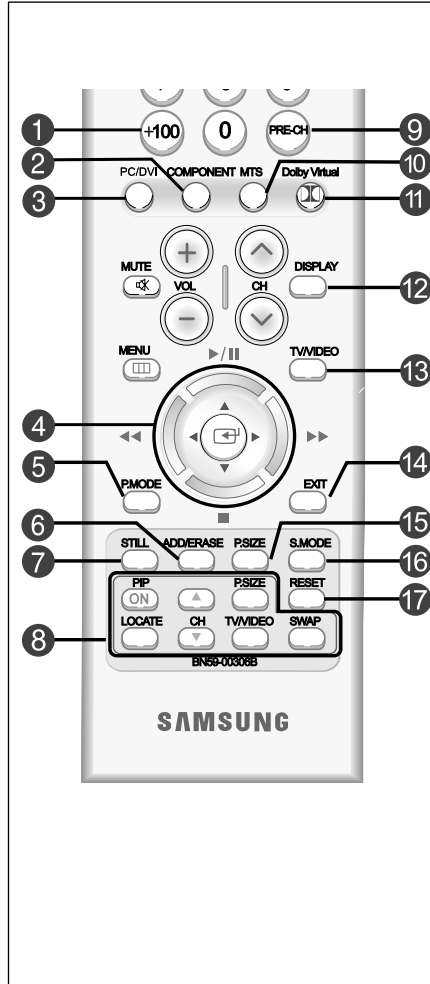

### 9 PRE-CH

Tunes to the previous channel.

### 10 MTS

(Multichannel Television Stereo)

Press to choose stereo, mono or Separate Audio Program (SAP broadcast).

### 11 Dolby Virtual

This feature allows the TV L/R speakers to provide a Home Theater-like Dolby effect.

### 12 DISPLAY

Press to display the current channel and audio-video settings.

### 13 TV/VIDEO

Press to display all of the available video sources.

### 14 EXIT

Press the menu to exit.

### 15 P.SIZE

Press to change the screen size.

### 16 S.MODE

Adjust the TV sound by selecting one of the preset factory settings (or select your personal, customized sound settings).

### 17 RESET

Return to a previous menu on a disc/teletext store. (If the remote does not appear to function correctly, remove the batteries and press the 'RESET' key. Factory settings are restored when the batteries are replaced. Reset may be used when other products (DVD, VCR, etc.) are not working.)

You can use the remote control up to 23 feet from the TV. When using the remote, always point it directly at the TV.

# Chapter Two

## INSTALLATION

### Connecting VHF and UHF Antennas

If your antenna has a set of leads that look like this, see “Antennas with 300-ohm Flat Twin Leads”, below.

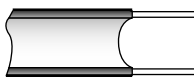

If your antenna has one lead that looks like this, see “Antennas with 75-ohm Round Leads”, on page 2.2.



If you have two antennas, see “Separate VHF and UHF Antennas”, on page 2.2.

#### Antennas with 300-ohm Flat Twin Leads

If you are using an off-air antenna (such as a roof antenna or “rabbit ears”) that has 300-ohm twin flat leads, follow the directions below.

**1**

Place the wires from the twin leads under the screws on a 300-75 ohm adaptor (not supplied). Use a screwdriver to tighten the screws.

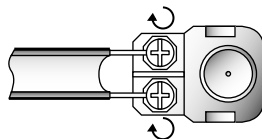

**2**

Plug the adaptor into the TV ANTENNA terminal on the bottom of the back panel.

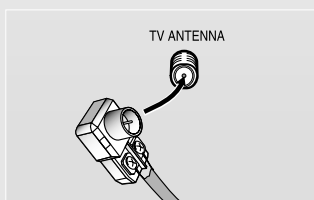

## INSTALLATION

### Antennas with 75-ohm Round Leads

**1**

Plug the antenna lead into the TV ANTENNA terminal on the bottom of the back panel.

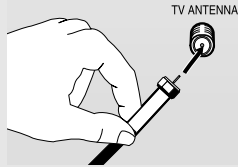

### Separate VHF and UHF Antennas

If you have two separate antennas for your TV (one VHF and one UHF), you must combine the two antenna signals before connecting the antennas to the TV. This procedure requires an optional combiner-adaptor (available at most electronics shops).

**1**

Connect both antenna leads to the combiner.

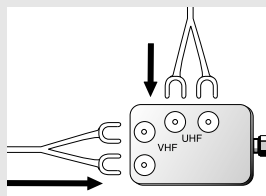

**2**

Plug the combiner into the TV ANTENNA terminal on the bottom of the rear panel.

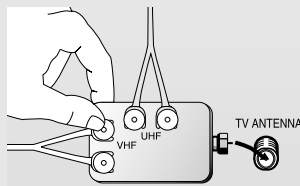

### Connecting Cable TV

To connect to a cable TV system, follow the instructions below.

#### Cable without a Cable Box

**1**

Plug the incoming cable into the TV ANTENNA terminal on back of the TV.

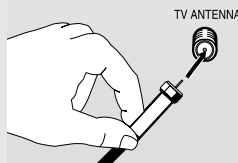

◀ Because this TV is cable-ready, you do not need a cable box to view unscrambled cable channels.

# INSTALLATION

## Connecting to a Cable Box that Descrambles All Channels

**1**

Find the cable that is connected to the ANTENNA OUT terminal on your cable box.



◀ This terminal might be labeled “ANT OUT”, “VHF OUT”, or simply, “OUT”.

**2**

Connect the other end of this cable to the TV ANTENNA terminal on the back of the TV.

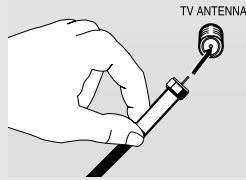

## Connecting to a Cable Box that Descrambles Some Channels

If your cable box descrambles only some channels (such as premium channels), follow the instructions below. You will need a two-way splitter, an RF (A/B) switch, and four lengths of coaxial cable. (These items are available at most electronics stores.)

**1**

Find and disconnect the cable that is connected to the ANTENNA IN terminal on your cable box.

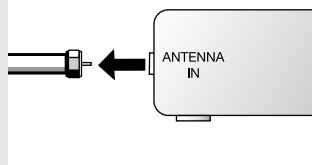

◀ This terminal might be labeled “ANT IN”, “VHF IN”, or simply, “IN”.

**2**

Connect this cable to a two-way splitter.

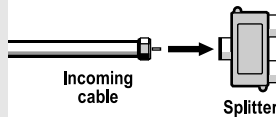

**3**

Connect a coaxial cable between an OUTPUT terminal on the splitter and the IN terminal on the cable box.

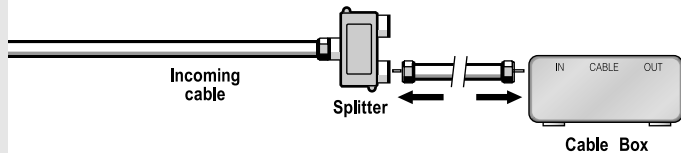



## INSTALLATION

**4**

Connect a coaxial cable between the ANTENNA OUT terminal on the cable box and the B-IN terminal on the A/B switch.

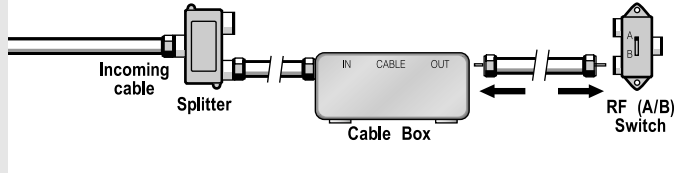

**5**

Connect another cable between the other OUT terminal on the splitter and the A-IN terminal on the RF (A/B) switch.

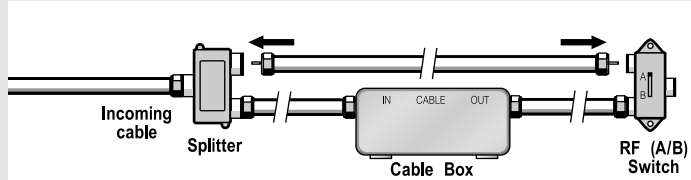

**6**

Connect the last coaxial cable between the OUT terminal on the RF (A/B) switch and the VHF/UHF terminal on the rear of the TV.

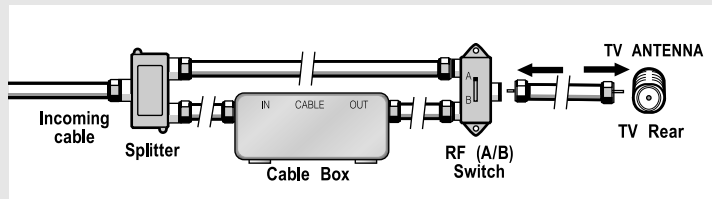

After you've made this connection, set the A/B switch to the "A" position for normal viewing. Set the A/B switch to the "B" position to view scrambled channels. (When you set the A/B switch to "B," you will need to tune your TV to the cable box's output channel, which is usually channel 3 or 4.)

## Connecting a VCR

These instructions assume that you have already connected your TV to an antenna or a cable TV system (according to the instructions on pages 2.1-2.3).

Skip step 1 if you have not yet connected to an antenna or a cable system.

**1**

Unplug the cable or antenna from the back of the TV.

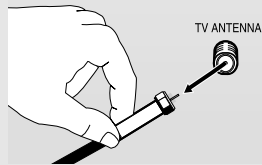

**2**

Connect the cable or antenna to the ANTENNA IN terminal on the back of the VCR.

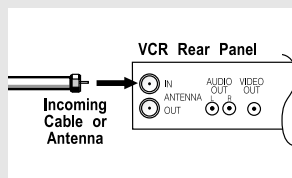

**3**

Connect a coaxial cable between the ANTENNA OUT terminal on the VCR and the antenna terminal on the TV.

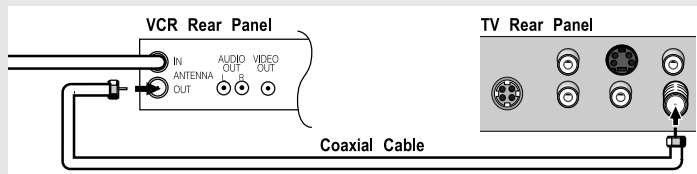

A coaxial cable is usually included with a VCR. (If not, check your local electronics store).

**4**

Connect a set of audio cables between the AUDIO OUT jacks on the VCR and the AUDIO jacks on the TV.

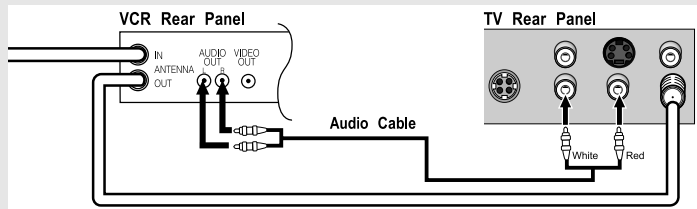

If you have a “mono” (non-stereo) VCR, use the Y-connector (not supplied) to hook up to the left and right audio input jacks of the TV. If your VCR is stereo, you must connect two cables.

**5**

Connect a video cable between the VIDEO OUT jack on the VCR and the VIDEO jack on the TV.

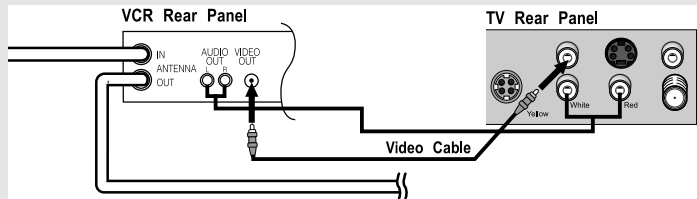

Follow the instructions in “Viewing a VCR or Camcorder Tape” to view your VCR tape.

# INSTALLATION

## Connecting an S-VHS VCR

Your Samsung TV can be connected to an S-Video signal from an S-VHS VCR. (This connection delivers a better picture as compared to a standard VHS VCR.)

**1**

To begin, follow steps 1–3 in the previous section to connect the antenna or cable to your VCR and your TV.

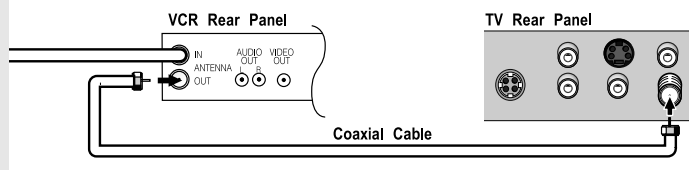

**2**

Connect a set of audio cables between the AUDIO OUT jacks on the VCR and the AUDIO INPUT jacks on the TV.

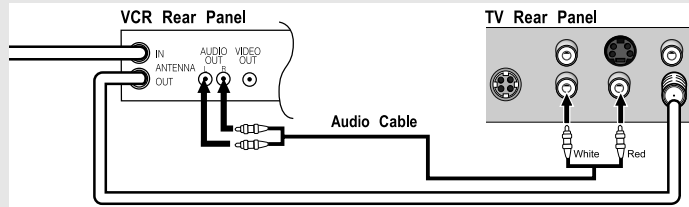

**3**

Connect an S-video cable between the S-VIDEO OUT jack on the VCR and the S-VIDEO INPUT jack on the TV.

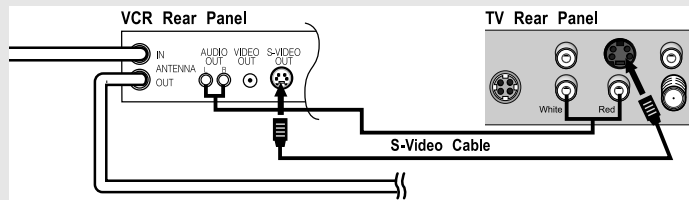

An S-video cable is usually included with an S-VHS VCR. (If not, check your local electronics store.)

## Connecting a DVD Player

The rear panel jacks on your TV make it easy to connect a DVD player to your TV.

### 1

Connect a set of audio cables between the L, R AUDIO INPUT jacks on the TV and the AUDIO OUT jacks on the DVD player.

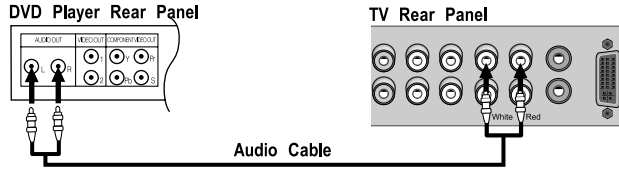

### 2

Connect a video cable between the COMPONENT1 (Y, Pb, Pr) jacks on the TV and the Y, Pb, Pr jacks on the DVD player.

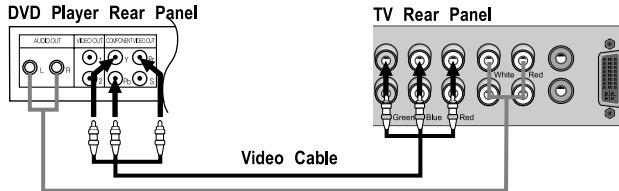

Note: For an explanation of Component video, see your DVD player owner's manual.

## Connecting a Digital TV Set-Top Box

The connections for a typical set-top box are shown below.

### 1

Connect a set of audio cables between the L, R COMPONENT2 AUDIO INPUT jacks on the TV and the AUDIO OUT jacks on the Set-Top Box.

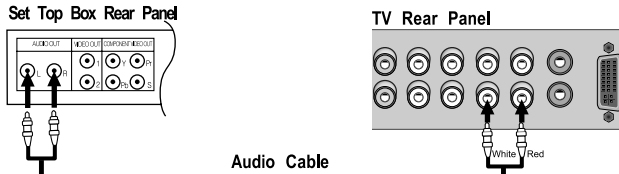

### 2

Connect a video cable between the COMPONENT2 (Y, Pb, Pr) jacks on the TV and the Y, Pb, Pr jacks on the Set-Top Box.

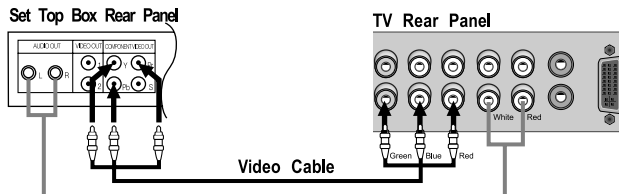

Note: For an explanation of Component video, see your Set-Top Box owner's manual.

## Connecting a PC

Note: This figure shows the Standard Connector-jack panel. The actual configuration on your TV may be different, depending on the model.

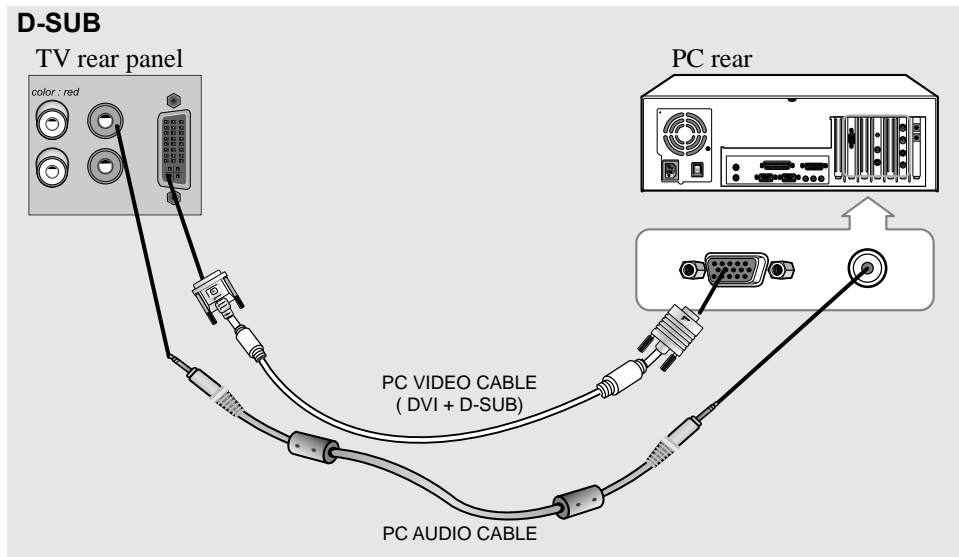
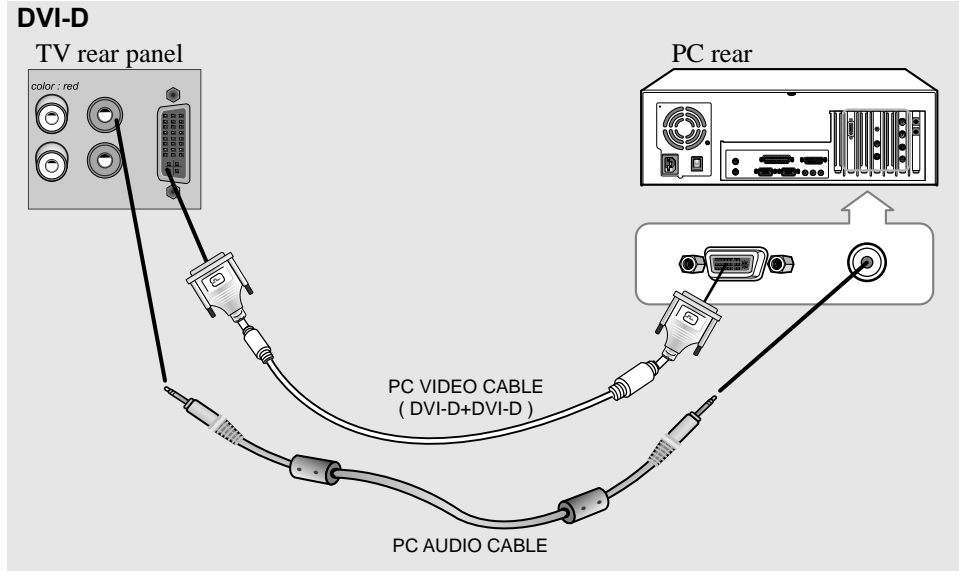

- **PC AUDIO INPUT**  
Connect these to the audio-output jacks on your PC.
- **PC VIDEO INPUT**  
Connect to the video output port on your PC.

## Connecting to an Audio System and Sub-woofer.

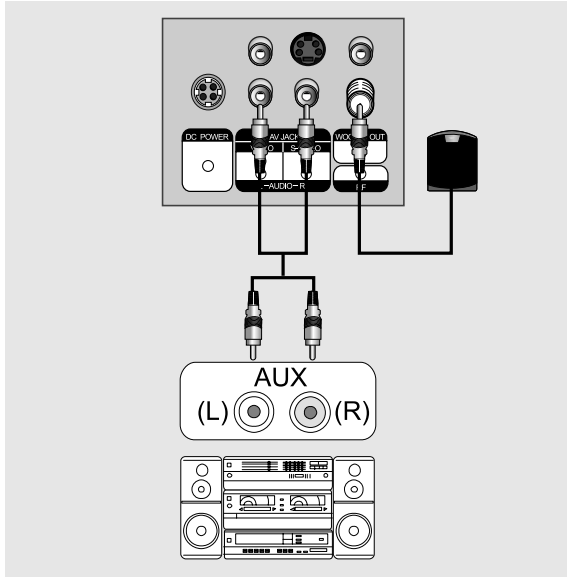

- ◀ Connect a set of audio cables between the AUX L, R jacks on the AUDIO SYSTEM and the AUDIO OUTPUT L, R jacks on the TV. Connect an audio cable between the INPUT jack on an active (powered) Sub woofer and the WOOFER OUT jack on the TV.

## Installing Batteries in the Remote Control

**1**

Slide the cover out completely.

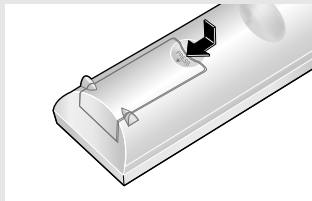

**2**

Install two AA size batteries.

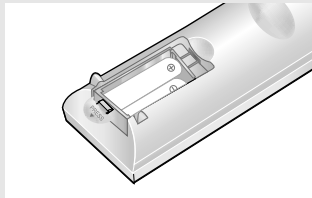

- ◀ Make sure to match the “+” and “-” ends of the batteries with the diagram inside the compartment.

**3**

Replace the cover.

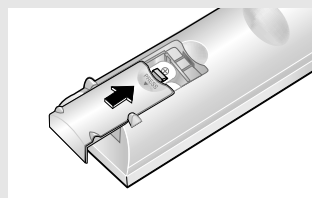

- ◀ Remove the batteries and store them in a cool, dry place if you won't be using the remote control for a long time.

The remote control can be used up to about 23 feet from the TV.

(Assuming typical TV usage, the batteries last for about one year.)

# Chapter Three

## OPERATION

### Turning the TV On and Off

Press the **POWER** button.

You can also use the Power button on the front panel.

### Plug & Play Feature

When the TV is initially powered On, two basic customer settings proceed automatically and subsequently: Setting Auto program, Clock.

**1**

Press the **POWER** button on the remote control.

The message "Plug & Play" is displayed. It flickers for a little while, then the "Language" menu is automatically displayed.

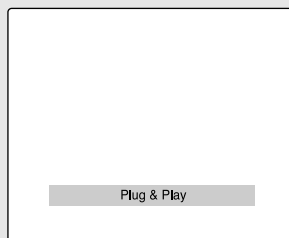

**2**

Press the **LEFT/RIGHT**  $\blacktriangleleft/\blacktriangleright$  button to select the desired language. Press the **MENU** button to enter the language, and then the "Time" menu is automatically displayed.

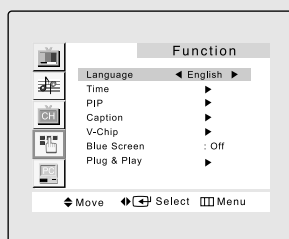

**3**

Press the **LEFT/RIGHT**  $\blacktriangleleft/\blacktriangleright$  buttons to move to the hour or minute. Set the hour or minute by pressing the **UP/DOWN**  $\blacktriangle/\blacktriangledown$  buttons. (refer to "Setting and Displaying the Current Time" on page 3.9.)

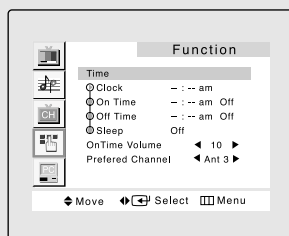

## 4

Press the **LEFT/RIGHT** **◀▶** button to select the desired video signal source.  
Press the **MENU** button to enter the video signal source, and then the "Ant Input check" is automatically displayed.

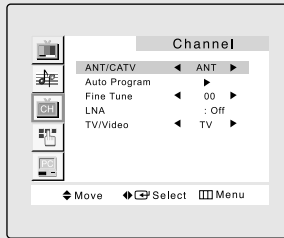

## 5

Make sure that the antenna is connected to the TV.  
Press the **LEFT/RIGHT** **◀▶** button to activate "Auto Program" or press the **MENU** button to skip. (refer to "Auto program" on page 3.6.)

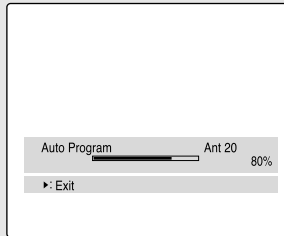

## 6

The message "Enjoy your watching." is displayed.

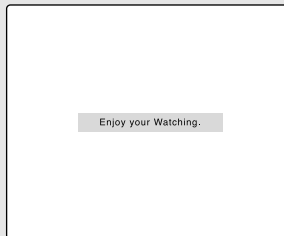

## 7

**If you want to reset this feature**

- (1) Press the **MENU** button.
- (2) Press the **DOWN** **▼** button to highlight the "Function" menu and press the **RIGHT** **▶** button.
- (3) Press the **DOWN** **▼** button to select Plug & Play and press the **RIGHT** **▶** button.  
The message "Plug & Play" is displayed.

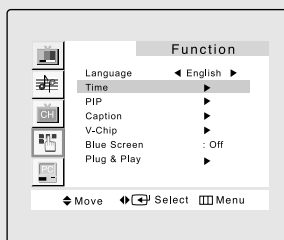



## Viewing the Menus and On-Screen Displays

### Viewing the Menu

**1**

With the power on, press the **MENU** button.

The main menu appears on the screen. Its left side has five icons: Picture, Sound, Channel, Function and PC.

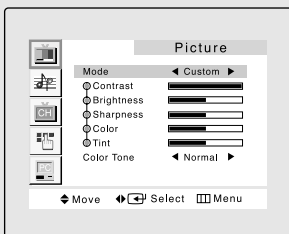

◀ The on-screen menus disappear from the screen after about thirty seconds.

**2**

Use the **UP/DOWN ▲ ▼** buttons to select one of the 5 icons. Then press **RIGHT ►** to access the icon's sub-menu.

**3**

Press the **MENU** button to exit.

◀ You can also use the **MENU**, **CHANNEL**, and **VOLUME** buttons on the control panel of the TV to make selections.

### Viewing the Display

The display identifies the current channel and the status of certain audio-video settings.

**1**

Press the **Display** button on the remote control.

The TV will display the channel, the type of sound, and the status of certain picture and sound settings.

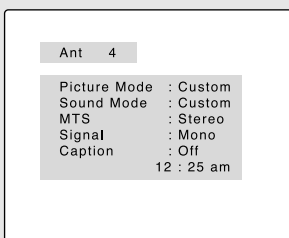

◀ The on-screen displays disappear after about ten seconds.

## Selecting a Menu Language

### 1

Press the **MENU** button to display the menu.

Press the **DOWN ▼** button to select “Function”, then press the **RIGHT ►** button.

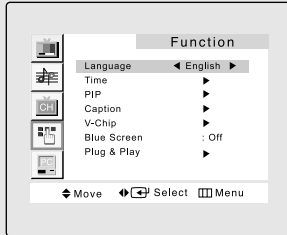

### 2

Press the **DOWN ▼** button to select Language.

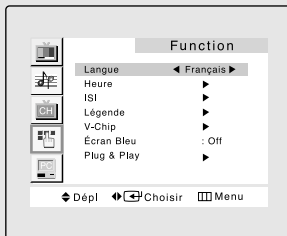

### 3

Press the **RIGHT ►** button to select the appropriate language: English, Spanish, French or Polish.

### 4

Press the **MENU** button to exit.

## Memorizing the Channels

Your TV can memorize and store all of the available channels for both “off-air” (antenna) and cable channels. After the available channels are memorized, use the CH  $\wedge$  and CH  $\vee$  buttons to scan through the channels. This eliminates the need to change channels by entering the channel digits. There are three steps for memorizing channels: selecting a broadcast source, memorizing the channels (automatic) and adding and deleting channels (manual).

### Selecting the Video Signal-source

Before your television can begin memorizing the available channels, you must specify the type of signal source that is connected to the TV (i.e., an antenna or a cable system).

# 1

Press the **MENU** button to display the menu.

Press the **DOWN**  $\blacktriangledown$  button to select “Channel”, then press the **RIGHT**  $\blacktriangleright$  button.

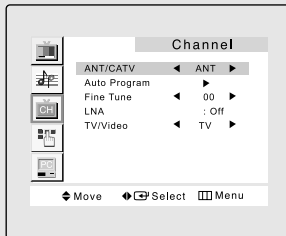

# 2

Repeatedly press the **RIGHT**  $\blacktriangleright$  button to cycle through these choices: ANT (antenna), STD, HRC or IRC (all cable TV).

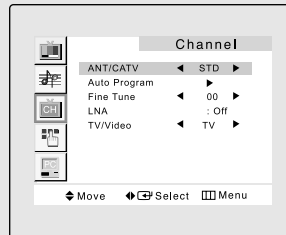

Note : STD, HRC and IRC identify various types of cable TV systems. Contact your local cable company to identify the type of cable system that exists in your particular area.

At this point the signal source has been selected.  
Proceed to “Storing Channels in Memory” (next page).

## Storing Channels in Memory (Automatic Method)

**1**

First, select the correct signal source (ANT, STD, HRC, IRC). See steps 1~2 on previous page.

Press the **MENU** button.

Press the **DOWN ▼** button to select "Channel", then press the **RIGHT ►** button.

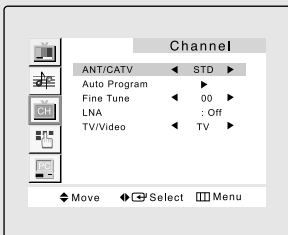

**2**

Press the **DOWN ▼** button to select "Auto program".

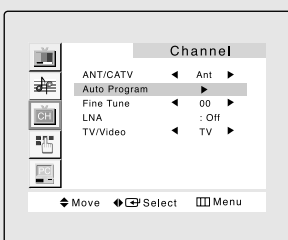

**3**

Press the **RIGHT ►** button. The TV will begin memorizing all of the available channels.

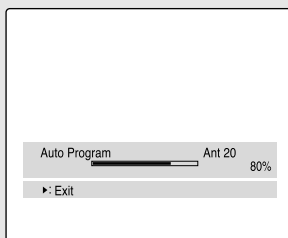

**4**

After all the available channels are stored, the Auto program menu reappears. Press the **MENU** button to exit.

◀ The TV automatically cycles through all of the available channels and stores them in memory. This takes about one to two minutes.

Press **RIGHT ►** at any time to interrupt the memorization process and return to the CHANNEL menu.

## Adding and Erasing Channels (Manual Method)

### 1

Use the number buttons to directly select the channel that will be added or erased.

### 2

Press the **ADD/ERASE** button.  
Repeatedly pressing this button will alternate between “Added” and “Erased.”

You can view any channel (including an erased channel) by using the number buttons on the remote control.

## Changing Channels

### Using the Channel Buttons

### 1

Press the **CH**  $\wedge$  /  $\vee$  buttons to change channels.

When you press the **CH**  $\wedge$  /  $\vee$  buttons, the TV changes channels in sequence. You will see all the channels that the TV has memorized. (The TV must have memorized at least three channels.) You will not see channels that were either erased or not memorized.

### Directly Accessing Channels

Use the number buttons to quickly tune to any channel.

### 1

Press the number buttons to go directly to a channel.  
For example, to select channel 27, press “2,” then “7.” The TV will change channels when you press the second number.

When you use the number buttons, you can directly select channels that were either erased or not memorized.

To select a channel over 100, press the +100 button.

(For channel 122, press “+100,” then “2,” then “2.”)

To change to single-digit channels (0–9) faster, press “0” before the single digit. (For channel “4,” press “0,” then “4.”)

### Using the Pre-CH Button to select the Previous Channel

### 1

Press the **PRE-CH** button.  
The TV will switch to the last channel viewed.

To quickly switch between two channels that are far apart, tune to one channel, then use the number button to select the second channel. Then, use the **PRE-CH** button to quickly alternate between them.

## Adjusting the Volume

### 1

Press the **VOL +/-** buttons to increase or decrease the volume.

### Using Mute

At any time, you can temporarily cut off the sound using the Mute button.

### 1

Press **MUTE** and the sound cuts off.

The word "Mute" will appear in the lower-left corner of the screen.

### 2

To turn mute off, press the **MUTE** button again, or simply press either the **VOL +/-** button.

## Setting the Clock

Setting the clock is necessary in order to use the various timer features of the TV. Also, you can check the time while watching the TV. (Just press DISPLAY.)

### 1

Press the **MENU** button to display the on-screen menu.

Press the **DOWN ▼** button three times to select "Function", then press the **RIGHT ►** button.

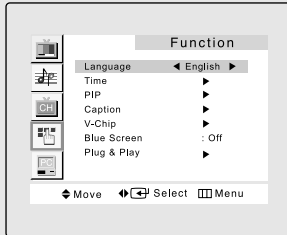

### 2

Press the **DOWN ▼** button to select "Time", then press the **RIGHT ►** button.

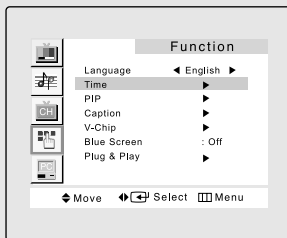

### 3

Press the **RIGHT ►** button. Press the **UP/DOWN ▲▼** buttons repeatedly until the correct hour appears.

After the hour is entered, press the **RIGHT ►** button.

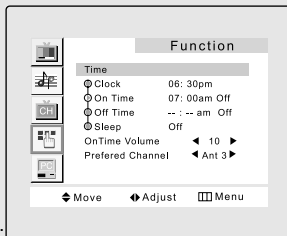

### 4

Press the **RIGHT ►** button again. Press the **UP/DOWN ▲▼** buttons repeatedly until the correct minutes appear.

After the minutes are entered, press the **RIGHT ►** button.

Press the **MENU** button to exit.

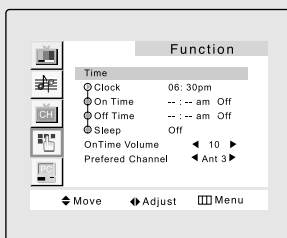

◀ When selecting the hours, be sure to select the proper time of day (AM or PM).

You can change the hours by pressing the **LEFT/RIGHT ◀▶** buttons repeatedly (or by holding down either of these buttons).

The time will appear every time you press the Display button.

## Customizing the Picture

You can use the on-screen menus to change the contrast, brightness, sharpness, color and tint according to personal preference. (Alternatively, you can use one of the “automatic” settings. See next page.)

**1**

Press the **MENU** button to display the menu.

Press the **RIGHT ▶** button to display the Picture menu.

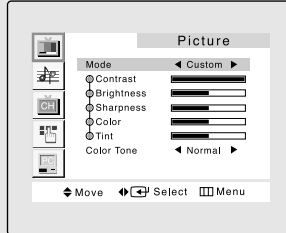

**2**

Press the **UP/DOWN ▲ ▼** buttons to select a particular item.

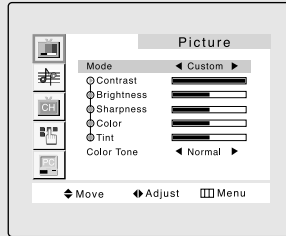

◀ The customer can select Color Tone: “Cool 2”, “Cool 1”, “Normal”, “Warm 1”, “Warm 2” according to personal preference.

**3**

Press the **LEFT/RIGHT ◀ ▶** buttons to increase or decrease the value of a particular item. For example, if you select “Contrast”, pressing **RIGHT ▶** increases it.

Press the **MENU** button to exit.

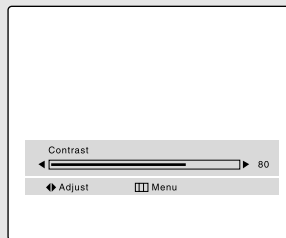



## Using Automatic Picture Settings

Your TV has two automatic picture settings (“Standard”, “Mild” and “Dynamic”) that are preset at the factory. You can activate either Standard, Mild or Dynamic by pressing P.MODE (or by making a selection from the menu). Or, you can select “Custom” which automatically recalls your personalized picture settings.

### 1

Press the **MENU** button to display the menu.

Press the **RIGHT ▶** button to display the Picture menu.

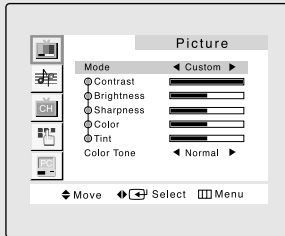

### 2

Press the **LEFT/RIGHT ◀▶** buttons to select the “Standard”, “Movie”, “Dynamic” or “Custom” picture setting.

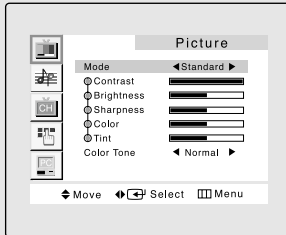

#### Alternate method:

Simply press the **P.MODE** button on the remote control to select one of the standard picture settings.

- Choose *Standard* for the standard factory settings.
- Choose *Movie* (“Movie Contrast”) when viewing the TV in low light, or when playing video games.
- Choose *Dynamic* to increase the clarity and sharpness of the picture.
- Choose *Custom* if you want to adjust the settings according to personal preference (see “Customizing the Picture, page 3.10).

## Customizing the Sound

The sound settings can be adjusted to suit your personal preference.  
(Alternatively, you can use one of the “automatic” settings. See next page.)

### 1

Press the **MENU** button to display the menu.

Press the **DOWN** ▼ button to select “Sound”, then press the **RIGHT** ► button.

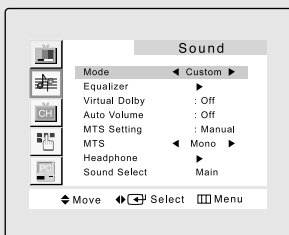

### 2

Press the **DOWN** ▼ button to select “Equalizer”, then press the **RIGHT** ► button.

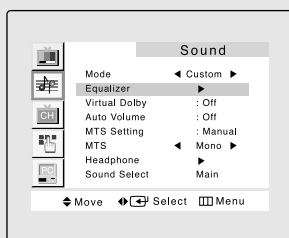

### 3

Press the **LEFT/RIGHT** ◀▶ buttons to select a particular item to be changed.

Press the **UP/DOWN** ▲▼ buttons to increase or decrease the value of a particular item.

Press the **MENU** button to exit.

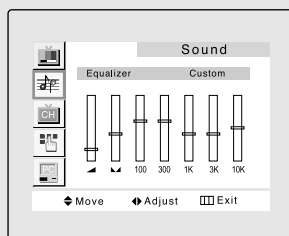

## Using Automatic Sound Settings

Your TV has four automatic sound settings (“Standard”, “Music”, “Movie” and “Speech”) that are preset at the factory. You can activate any of them by pressing the S.MODE button (or by making a selection from the on-screen menu). Or, you can select “Equalizer”, which automatically recalls your personalized sound settings.

### 1

Press the **MENU** button to display the menu.

Press the **DOWN ▼** button to select “Sound”, then press the **RIGHT ►** button.

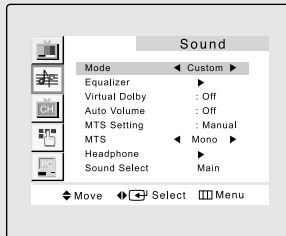

### 2

Press the **LEFT/RIGHT ◀▶** buttons repeatedly to select the “Standard”, “Music”, “Movie”, “Speech” or “Custom” sound settings.

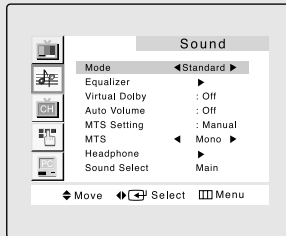

#### Alternate method:

Simply press the the **S.MODE** button on the remote control to select one of the standard sound settings.

- Choose *Standard* for the standard factory settings.
- Choose *Music* when watching music videos or concerts.
- Choose *Movie* when watching movies.
- Choose *Speech* when watching a show that is mostly dialogue (i.e., news).
- Choose *Custom* to recall your personalized settings.

## Viewing a VCR or Camcorder Tape

You must select the appropriate mode in order to view the VCR or Camcorder signal on the TV.

### 1

Press the **MENU** button to display the menu.

Press the **DOWN** ▼ button to select "Channel", then press the **RIGHT** ► button.

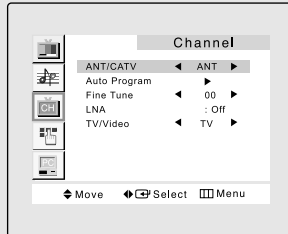

◀ Quick way to access the externa signal:  
Simply press the TV/VIDEO button on the remote control.

### 2

Press the **DOWN** ▼ button to select "TV/Video".

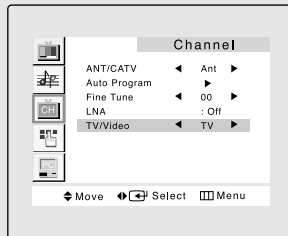

### 3

Press the **LEFT/RIGHT** ◀► button. You will switch between viewing the signals coming from equipment connected to the TV's A/V jacks, and the TV signal.

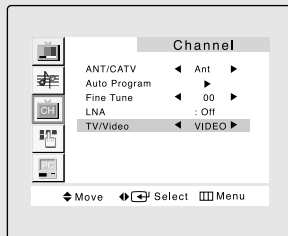

# Chapter Four

## SPECIAL FEATURES

### Fine Tuning Channels

Use fine tuning to manually adjust a particular channel for optimal reception.

**1**

Select the appropriate channel.

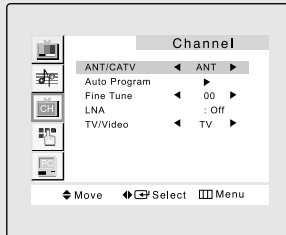

**2**

Press the **MENU** button to display the menu.

Press the **DOWN** ▼ button twice to select “Channel”, then press the **RIGHT** ► button.

**3**

Press the **DOWN** ▼ button to select “Fine Tune.”

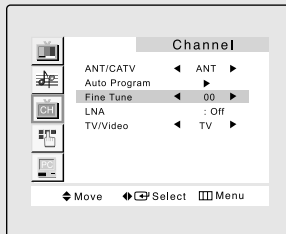

**4**

Press the **RIGHT** ► and **LEFT** ◀ buttons to adjust the fine tuning.

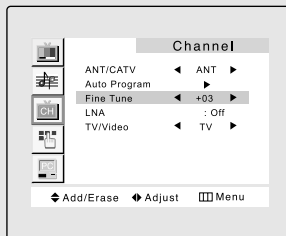

**5**

To store the fine tuning setting in the TV's memory, press the **UP** ▲ button. (A heart icon will appear.)

To reset the fine tuning to “00”, press the **DOWN** ▼ button.

Press the **MENU** button to exit.

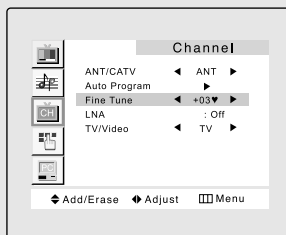

◀ After you adjust the fine tuning, the “MFT” will appear when you press Display while watching this channel.

## LNA (Low Noise Amplifier)

If the TV is operating in a weak-signal area, sometimes the LNA function can improve the reception (a low-noise preamplifier boosts the incoming signal).

### 1

Press the **MENU** button to display the menu.

Press the **DOWN** ▼ button to select “Channel”, then press the **RIGHT** ► button.

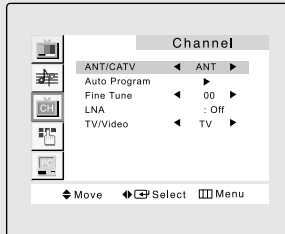

### 2

Press the **DOWN** ▼ button to select “LNA”.

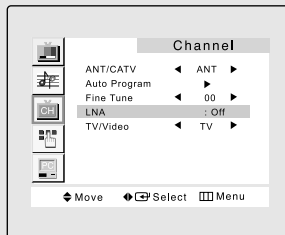

### 3

Press the **LEFT/RIGHT** ◀▶ button to set LNA “On”.

Press the **MENU** button to exit.

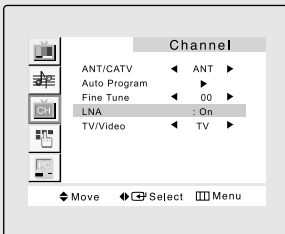

◀ Pressing **LEFT/RIGHT** ◀▶ will alternate between “On” and “Off”.

## Setting the Blue Screen Mode

If no signal is being received or the signal is very weak, a blue screen automatically replaces the noisy picture background.

If you wish to continue viewing the poor picture, you must set the “Blue screen” mode to “Off”.

### 1

Press the **MENU** button to display the menu.

Press the **DOWN** ▼ button to select “Function”, then press the **RIGHT** ► button.

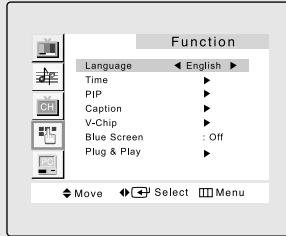

### 2

Press the **DOWN** ▼ button to select “Blue Screen.”

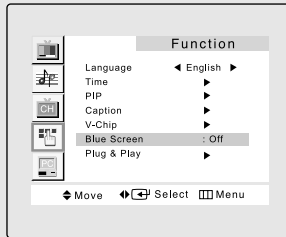

### 3

Press the **LEFT/RIGHT** ◀▶ buttons to set Blue Screen “On”.

Press the **MENU** button to exit.

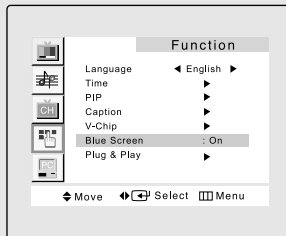

◀ Pressing the **LEFT/RIGHT** ◀▶ buttons will alternate between “On” and “Off”.

## Changing the Screen Size

### 1

Press the **P.SIZE** button to change the screen size.

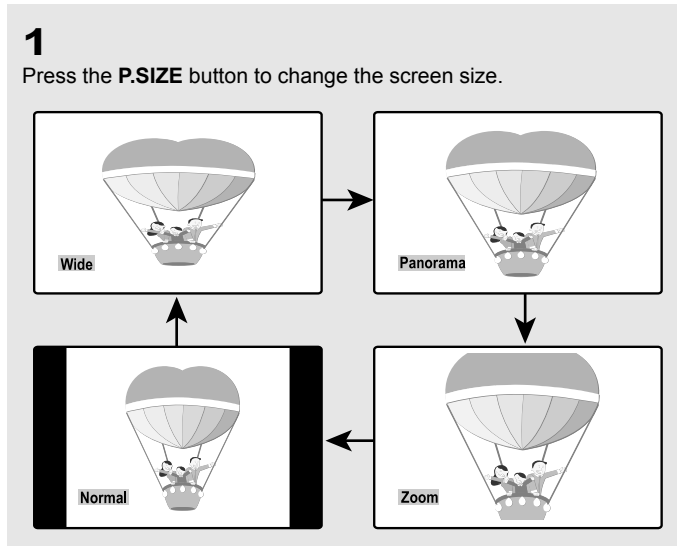

- **Wide:** Sets the picture to 16:9 wide mode.
- **Panorama :** Use this mode for the wide aspect ratio of a panoramic picture.  
(However, it does not work in 720p and 1080i modes.)
- **Zoom 1,2 :** Magnifies the size of the picture on screen.
- **Normal:** Sets the picture to 4:3 normal mode.  
This is the standard TV screen size.

## Freezing the Picture

### 1

Press the **STILL** button to freeze a moving picture.  
"main picture".

- Normal sound will still be heard.  
Press again it cancel.



## Special Sound Options

### Choosing a Multi-Channel Sound (MTS) Soundtrack

Depending on the particular program being broadcast, you can listen to stereo, mono, or a Separate Audio Program. (SAP audio is usually a foreign-language translation. Sometimes SAP has unrelated information like news or weather.)

#### 1

Press the **MENU** button to display the menu.

Press the **DOWN ▼** button to select “Sound”, then press the **RIGHT ►** button

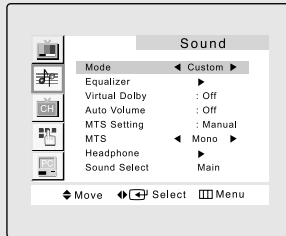

#### 2

Press the **DOWN ▼** button three times to select “MTS”.

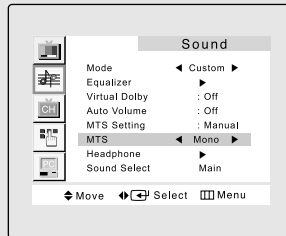

#### 3

Press the **RIGHT ►** button repeatedly to select “Mono”, “SAP”, or “Stereo”.

Press the **MENU** button to exit.

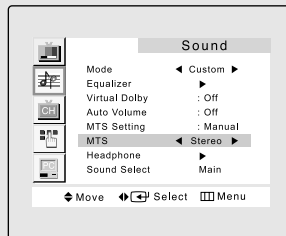

◀ The text at the bottom of the menu tells you if the incoming audio is stereo, SAP, or mono.

- Choose *Stereo* for channels that are broadcasting in stereo.
- Choose *Mono* for channels that are broadcasting in mono, or if you are having difficulty receiving a stereo signal.
- Choose *SAP* to listen to the Separate Audio Program, which is usually a foreign-language translation.

You can also change the MTS setting by pressing the “MTS” button on the remote control. (When you change channels, MTS is set to “Stereo” automatically. To listen in ‘SAP’ or ‘Mono’, change the MTS setting.)

## Auto Volume

Each broadcasting station has its own signal conditions, and it is inconvenient to adjust the volume every time the channel is changed. “Auto volume” automatically adjusts the volume of the desired channel by lowering the sound output when the modulation signal is high or by raising the sound output when the modulation signal is low.

**1**

Press the **MENU** button to display the menu.

Press the **DOWN** ▼ button to select “Sound”, then press the **RIGHT** ► button.

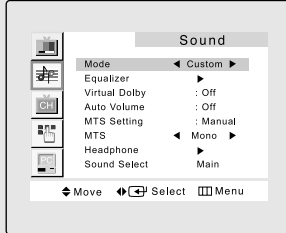

**2**

Press the **DOWN** ▼ button to select “Auto volume”.

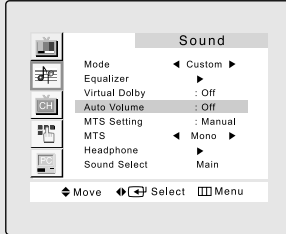

**3**

Press the **RIGHT** ► button to select “On”.

Press the **MENU** button to exit.

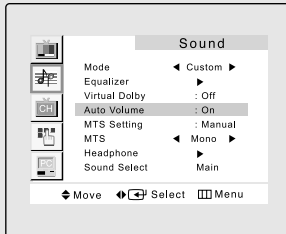

◀ Pressing **LEFT/RIGHT** ◀▶ will alternate between “On” and “Off”.

## Virtual Dolby

This feature allows the TV's L/R speakers to provide a home Theater-like Dolby effect. The center and surround sounds are mixed into the L/R speakers.

**1**

Press the **MENU** button to display the menu.

Press the **DOWN ▼** button to select "Sound", then press the **RIGHT ►** button

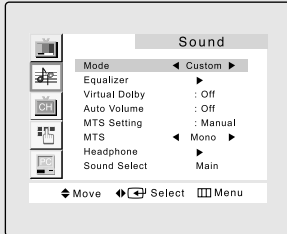

◀ Quick way to access the Virtual Dolby menu: Simply press the Dolby Virtual button on the remote control.

**2**

Press the **DOWN ▼** button to select "Virtual Dolby".

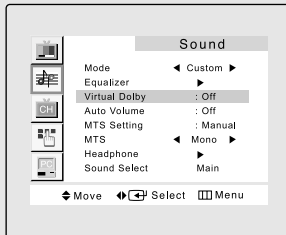

**3**

Press the **RIGHT ►** button to select "On".

Press the **MENU** button to exit.

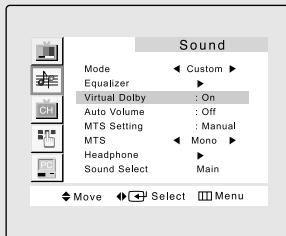

◀ Pressing **LEFT/RIGHT ◀▶** will alternate between "On" and "Off".

## Adjusting the Headphone Sound

The headphone option is especially useful when simultaneously watching the main screen and the PIP window.

**1**

Press the **MENU** button to display the menu.

Press the **DOWN ▼** button to select "Sound", then press the **RIGHT ►** button

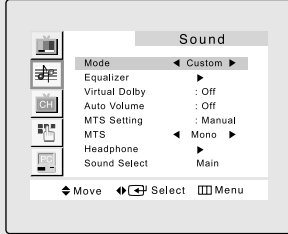

◀ Note : Headphones must be purchased separately.

**2**

Press the **DOWN ▼** button to select "Headphone" and press the **RIGHT ►** button.

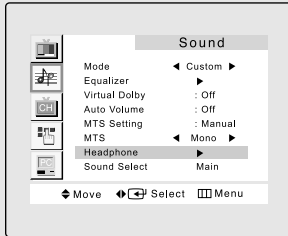

**3**

Press the **UP/DOWN ▲▼** button to select the particular item to be changed.

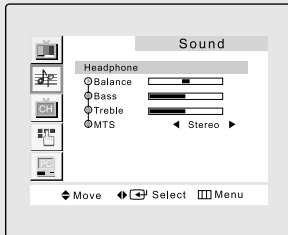

◀ Note : When you want to listen to TV with headphones only, press the MUTE or VOL- button on the remote control to set the TV speaker volume to zero(0).

**4**

Press the **LEFT/RIGHT ◀▶** buttons to increase or decrease the value of a particular item.

Press the **MENU** button to exit.

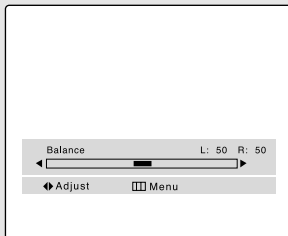

## Selecting the Sound

You can select either Main or Sub when PIP is On.

**1**

Press the **MENU** button to display the menu.

Press the **DOWN** ▼ button to select "Sound", then press the **RIGHT** ► button.

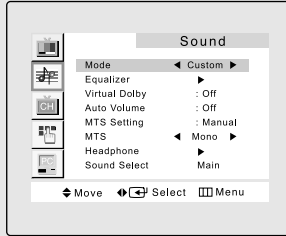

**2**

Press the **DOWN** ▼ button to select "Sound Select".

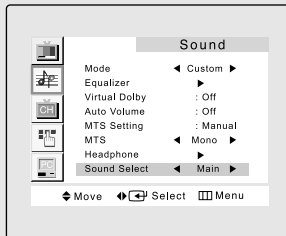

**3**

Press the **RIGHT** ► button to select "Main" or "Sub".

Select "Main" to hear the main TV sound and select "Sub" to hear the PIP window sound.

Press the **MENU** button to exit.

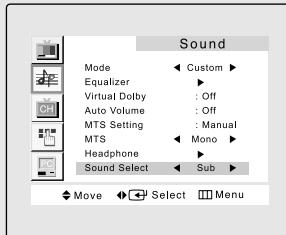

◀ **Note** : Sound Select can also be used to select the Main or Sub sound over the speakers.

## Setting the On/Off Timer

### 1

Press the **MENU** button to display the on-screen menu.

Press the **DOWN ▼** button three times to select “Function”, then press the **RIGHT ►** button.

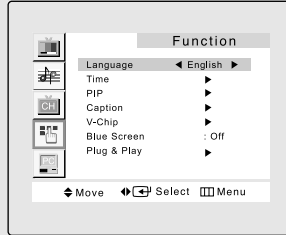

◀ Before using the timer, you must set the TV's clock.  
(See “Setting the Clock” on page 3.9)

### 2

Press the **DOWN ▼** button to select the “Time”, then press the **RIGHT ►** button.

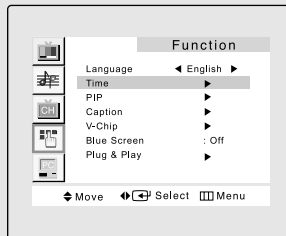

### 3

Press the **DOWN ▼** button to select “On time”, then press the **RIGHT ►** button.

Press the **UP/DOWN ▲ ▼** buttons repeatedly to select the appropriate hours (i.e., the hour when the TV will turn on).

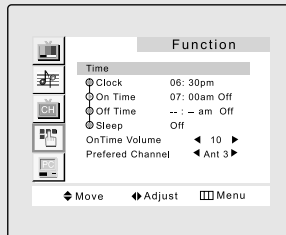

◀ When you set the hours, make sure the correct time of day (AM or PM) appears to the left of the hour.

### 4

Press the **RIGHT ►** button to select the “On time” minutes.

Press the **UP/DOWN ▲ ▼** buttons repeatedly to select the appropriate minutes.

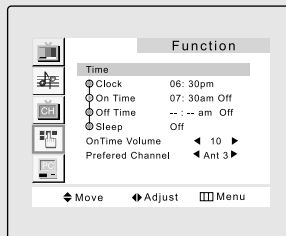

*continued...*

## 5

Press the **RIGHT ►** button to select “On/Off”.

Press the **UP/DOWN ▲ ▼** buttons to on-timer “On”. (Repeatedly pressing the **UP/DOWN ▲ ▼** buttons will alternate between on and off.)

When finished, press the **RIGHT ►** button.

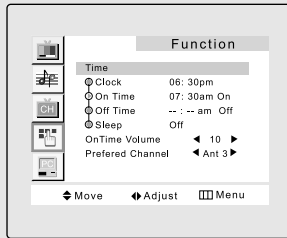

◀ To deactivate the “On time,” select “Off” during this step.

## 6

To set the Off time, press the **DOWN ▼** button to select “Off time”.

Press the **RIGHT ►** button and set the hours and minutes. (Follow the same procedure as in steps 1~5 above.)

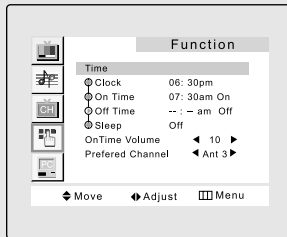

## 7

When finished setting the timer, press the **MENU** button to exit.

### • What is Absent Power Off?

When you set the timer on, your television will be turned off if you do not operate any controls during 3 hours after you turn on the TV.

This 'Absent power off' function is available in only 'Timer on' situation.

This function will prevent the leakage accident or dissipation caused by the occasion that your TV will be left in turned on situation for a long time due to 'Timer on'.  
(when you are away on holiday for example)

## Viewing Closed Captions

Your TV decodes and displays the closed captions that are broadcast with certain TV shows. These captions are usually subtitles for the hearing impaired or foreign-language translations. All VCRs record the closed caption signal from television programs, so home-recorded video tapes also provide closed captions. Most pre-recorded commercial video tapes provide closed captions as well. Check for the closed caption symbol in your television schedule and on the tape's packaging: .

Note: The Caption feature does not work with DVD or DTV signals.

### 1

Press the **MENU** button to display the menu.

Press the **DOWN ▼** button to select "Function", then press the **RIGHT ►** button.

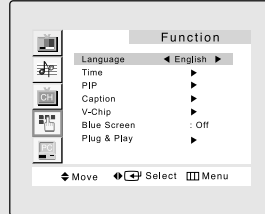

### 2

Press the **DOWN ▼** button to select "Caption", then press the **RIGHT ►** button.

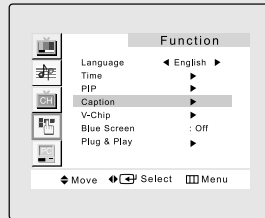

### 3

Press the **LEFT/RIGHT ◀▶** buttons to turn closed captioning on/off.

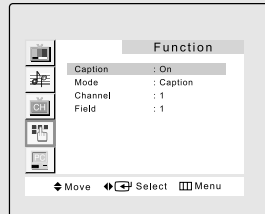

### 4

Press the **DOWN ▼** button to select "Mode".

Press the **LEFT/RIGHT ◀▶** buttons to select "Caption" or "Text".

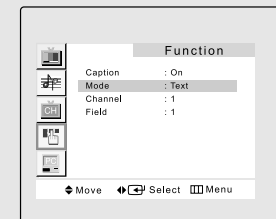

### 5

Depending on the particular broadcast, it might be necessary to make changes to "Channels" and "Field": Use the **UP ▲**, **DOWN ▼**, **RIGHT ►** and **LEFT ◀** buttons to make the changes. (Follow the same procedure as in steps 3~4 above.) Press the **MENU** button to exit.

◀ Different channels and fields display different information: Field 2 carries additional information that supplements the information in Field 1. (For example, Channel 1 may have subtitles in English, while Channel 2 has subtitles in Spanish.)



## Viewing Picture-in-Picture

This product has one tuner built-in, which does not allow PIP to function in the same mode. Please see 'PIP Settings' below for details.

You can use the PIP feature to simultaneously watch two video sources.

Note: While V-Chip is in operation, the PIP function cannot be used.

### Activating Picture-in-Picture

**1**

Press the **MENU** button to display the menu.

Press the **DOWN** ▼ to select "PIP", then press the **RIGHT** ► button.

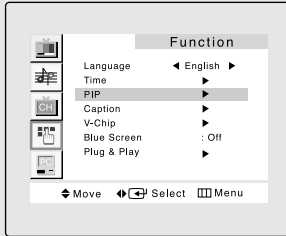

◀ Quick way to access the PIP menu: Simply press the PIP button on the remote control.

**2**

Press the **RIGHT** ► button to select PIP "On".

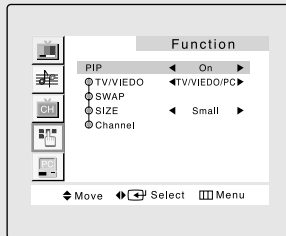

◀ If you turn the TV off while watching and turn it on again, the PIP window will disappear.

**3**

Press the **MENU** button to exit.

Note: Picture-in-Picture does not function when the V-chip is active.

### PIP Settings

O : PIP operates  
X : PIP doesn't operate

Sub picture Main picture	Antenna	Video	S-Video	Component 1	Component 2	PC/DVI
Antenna	X	X	X	O	O	X
Video	X	X	X	O	O	X
S-video	X	X	X	O	O	X
Component 1	O	O	O	X	X	X
Component 2	O	O	O	X	X	X
PC/DVI	O	O	O	X	X	X

### Selecting a Signal Source (External A/V) for PIP

Press the **TV/VIDEO(PIP)** button repeatedly to cycle through all of the available signal sources: “TV”, “Video”, “S-Video”, “Component 1” and “Component 2”.

◀ For more information about external A/V components and signals, see “Viewing a VCR or Camcorder Tape” on page 3.17. If you select “TV”, the PIP image is the same as the main image.

### Swapping the Contents of the PIP image and Main image

When you press the **SWAP** button, the image in the PIP window will appear on the main screen, and vice versa.

◀ While the main screen is in PC mode, it does not work.

### Changing the PIP Channel

Press the PIP **CH**  $\wedge$  /  $\vee$  button to change the channel that appears in the PIP window.

### Changing the Location of the PIP Window

When you press the **LOCATE** button repeatedly, the PIP window moves from corner to corner on the TV screen.

### Changing the Size of the PIP Window

Press the **P.SIZE** button to alternate between a smaller and larger PIP window.

## Using the V-Chip

The V-Chip feature automatically locks out programming that is deemed inappropriate for children. The user must first enter a PIN (personal ID number) before any of the V-Chip restrictions can be set up or changed.

### Setting Up Your Personal ID Number (PIN)

**1**

Press the **MENU** button to display the menu.

Press the **DOWN** ▼ button to select “Function”, then press the **RIGHT** ► button.

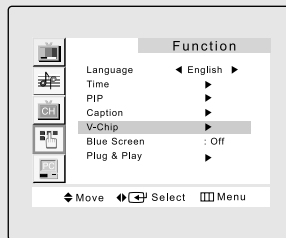

**2**

Press the **DOWN** ▼ button to select “V-chip”, then press the **RIGHT** ► button.

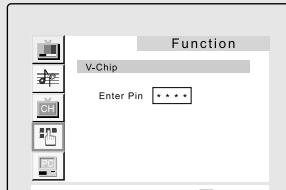

The “Enter Pin” screen will appear. Enter your 4-digit PIN number. Note: The default PIN number for a new TV set is “0-0-0-0.”

**3**

After entering a valid PIN number, the “V-chip” screen will appear. Press the **DOWN** ▼ button to select “Change Pin.”

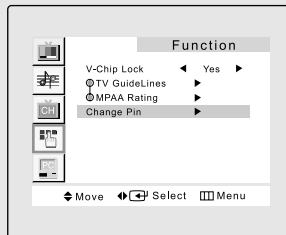

**4**

Press the **RIGHT** ► button. The Change pin screen will appear. Choose any 4-digits for your PIN and enter them.

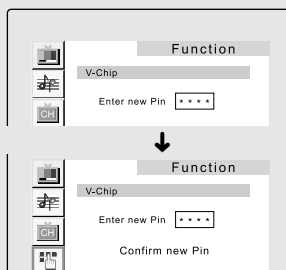

As soon as the 4 digits are entered, the “Confirm new Pin” screen appears. Re-enter the same 4 digits. When the Confirm screen disappears, your PIN has been memorized. Press the **MENU** button to exit.

◀ Note: If you forget the PIN, press the remote-control buttons in the following sequence, which resets the pin to 0-0-0-0:  
POWER OFF ► MUTE ► 8 ► 2 ► 4 ► POWER ON.

## How to Enable/Disable the V-Chip

Note: V-Chip cannot be used during PIP operation.

**1**

Press the **MENU** button to display the menu.

Press the **DOWN ▼** button to select “Function”, then press the **RIGHT ►** button.

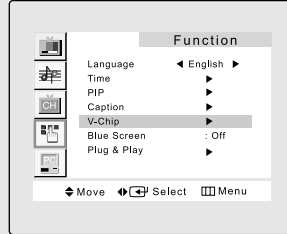

**2**

Press the **DOWN ▼** button to select “V-chip”, then press the **RIGHT ►** button.

The “Enter pin” screen will appear. Enter your 4-digit PIN number.

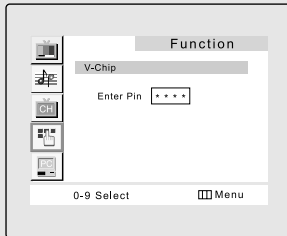

**3**

The “V-Chip” screen will appear, and “V-Chip lock” will be select.

To enable the V-Chip feature, press the **RIGHT ►** button so that the “V-Chip Lock” is set to Yes.

(Pressing the **RIGHT ►** button will alternate between Yes and No.)

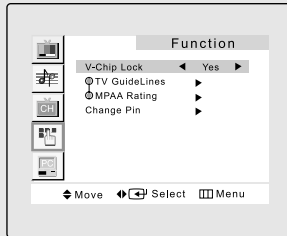

## How to Set up Restrictions Using the “TV guidelines”

First, set up a personal identification number (PIN), and enable the V-Chip. (See previous section.) Parental restrictions can be set up using either of two methods: The TV guidelines or the MPAA rating.

**1**

Press the **MENU** button to display the menu.

Press the **DOWN ▼** button to select “Function”, then press the **RIGHT ►** button.

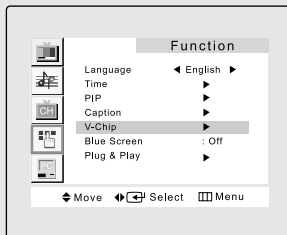

## SPECIAL FEATURES

### 2

Press the **DOWN ▼** button to select “V-chip”, then press the **RIGHT ►** button.

The “Enter pin” screen will appear. Enter your 4-digit PIN number.

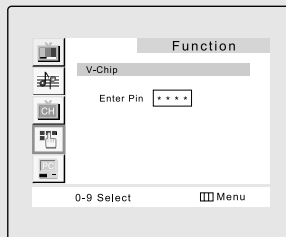

### 3

Press the **DOWN ▼** button, to select “TV Guidelines”, then press the **RIGHT ►** button.

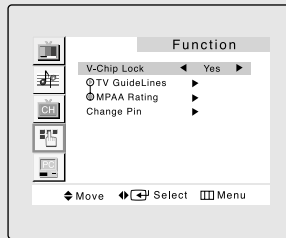

### 4

The “TV guidelines” screen will appear. Press the the **UP/DOWN ▲▼** buttons to select one of the six age-based categories:

TV-Y Young children  
TV-Y7 Children 7 and over

TV-G General audience  
TV-PG Parental guidance  
TV-14 Viewers 14 and over  
TV-MA Mature audience

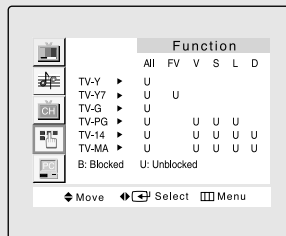

◀ Note: These categories consist of two separate groups : TV-Y and TV-Y7 (young children through age 7), and TV-G through TV-MA (everybody else).

The restrictions for these two groups work independently:

If a household includes very young children as well as young adults, the TV guidelines must be set up separately for each age group. (See next step.)

### 5

At this point, one of the TV-Ratings is selected.

Press the **RIGHT ►** button: Depending on your existing setup, a letter “U” or “B” will start blinking. (U= Unblocked, B= Blocked)

While the “U” or “B” is blinking, press the **UP/DOWN ▲▼** buttons to block or unblock the category.

Press the **MENU** button once to save the TV guidelines. A TV-Rating will be highlighted, and no letters will blink. To exit this screen, press the **MENU** again. To select a different TV-Rating, press the **UP/DOWN ▲▼** buttons and then repeat the process.

Note 1: The TV-Y7, TV-PG, TV-14 and TV-MA have additional options.

See the next step to change any of the following sub-ratings:

FV: Fantasy Violence  
D: Sexual suggestive Dialog  
L: Adult Language  
S: Sexual situation  
V: Violence

Note 2: The V-Chip will automatically block certain categories that are “more restrictive.” For example, if you block “TV-Y” category, then TV-Y7 will automatically be blocked. Similarly, if you block the TV-G category, then all the categories in the “young adult” group will be blocked (TV-G, TV-PG, TV-14 and TV-MA). The sub-ratings (D, L, S, V) work together similarly. (See next section.)

**6**

How to set the FV, D, L, S and V sub-ratings.

First, highlight one of these TV-Ratings: TV-Y7, TV-PG, TV-14 or TV-MA (See Step 4, on previous page).

Next, while the TV-Rating is selected, repeatedly press the **RIGHT ►** button. This will cycle through the available sub-ratings (FV,L, S, D or V).

A blinking letter (“U” or “B”) will be displayed for each sub-rating. While the “U” or “B” is blinking, press the **UP/DOWN ▲ ▼** buttons to change the sub-rating.

Press **MENU** once to save the TV guidelines. A TV-Rating will be selected, and no letters will blink. To exit this screen, press the **MENU** button again. To select a different TV-Rating, press the **UP/DOWN ▲ ▼** buttons and then repeat the process.

Note: The V-chip will automatically block certain categories that are “More restrictive”.

For example, if you block “L” sub-rating in TV-PG, then the “L” sub-ratings in TV-14 and TV-MA will automatically be blocked.

**7**

Press the **MENU** button three times to clear all the screens.

(Or proceed to the next section, and set up additional restrictions based on the MPAA codes).

### How to Set up Restrictions using the MPAA Ratings: G, PG, PG-13, R, NC-17, X

The MPAA rating system uses the Motion Picture Association of America (MPAA) system, and its main application is for movies. (Eventually, movie videocassettes will be encoded with MPAA ratings.) When the V-Chip lock is on, the TV will automatically block any programs that are coded with objectionable ratings (either MPAA or TV-Ratings).

**1**

Press the **MENU** button to display the menu.

Press the **DOWN ▼** button to select “Function”, then press the **RIGHT ►** button.

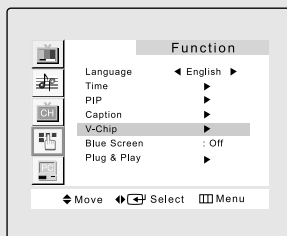
**2**

Press the **DOWN ▼** button to select “V-chip”, then press the **RIGHT ►** button.

The “Enter pin” screen will appear. Enter your 4-digit PIN number.

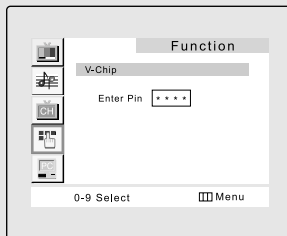

**3**  
Press the **DOWN ▼** button to select “MPAA rating”, then press the **RIGHT ►** button.

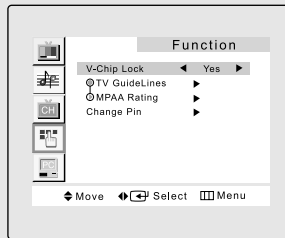

**4**  
Repeatedly press the **DOWN ▼** button to select a particular MPAA category. (When a category is selected, its color changes to blue.) Pressing the **DOWN ▼** button will cycle through the MPAA categories:

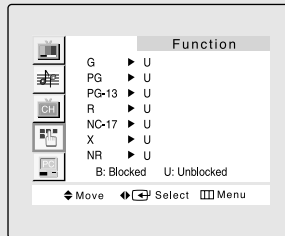

- G** General audience (no restrictions).
- PG** Parental guidance suggested.
- PG-13** PG-13 (Parents strongly cautioned).
- R** R (Restricted. Children under 17 should be accompanied by an adult).
- NC-17** No children under age 17.
- X** X (Adults only).
- NR** Not rated.

While a particular category is highlighted, press the **RIGHT ►** button to activate it. A blinking letter (“U” or “B”) will be displayed. Press the **UP/DOWN ▲ ▼** buttons to select “U” or “B”. Press the **MENU** button three times to save the settings and to clear all screens.

Note: The V-Chip will automatically block any category that is “more restrictive”. For example, if you block the “PG-13” category, then “R,” “NC-17,” and “X” will automatically be blocked also.

### How to Reset the TV after the V-Chip Blocks a Channel (“Emergency Escape”)

If the TV is tuned to a restricted channel, the V-Chip will block it. The screen will go blank and the following message will appear: “Excessive rating”.

To resume normal viewing, tune to a different channel using the number buttons. Under certain conditions (depending on the rating of the local TV programs) the V-Chip might lock out all the channels.

In this case, use the Menu button for an “emergency escape”:

Select the V.chip on the Menu. Enter your PIN number, and press the **RIGHT ►** button to temporarily disable the V-Chip Lock.

# Chapter Five

## PC DISPLAY

### Using Your TV as a Computer (PC) Display

#### How to Set up Your PC Software (Windows only)

The Windows display-settings for a typical computer are shown below. However, the actual screens on your PC will probably look different, depending upon your particular version of Windows and your particular video card. Even if your actual screens look different, the same, basic set-up information will apply in most cases.

(If not, contact your computer manufacturer or Samsung Dealer.)

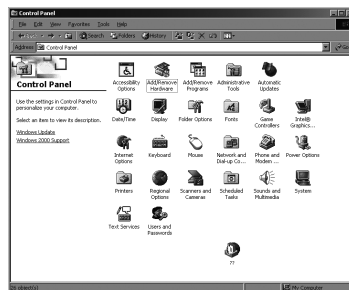
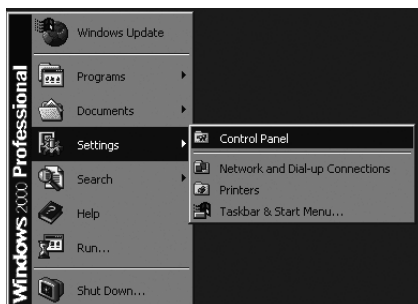

First, click on “Settings” on the Windows start menu.

While “Settings” is highlighted, move the cursor so that “Control Panel” is highlighted.

When the control panel screen appears, click on “Display” and a display dialog-box will appear.

Navigate to the “settings” tab on the display dialog-box.

The two key variables that apply the TV-PC interface are “resolution” and “colors.” The correct settings for these two variables are:

\* Size (sometimes called “resolution”): 1280 x 720 pixels

If a vertical-frequency option exists on your display settings dialog box, the correct value is “60” or “60 Hz”. Otherwise, just click “OK” and exit the dialog box.

\* See “Display Mode” on page A.1.



## Adjusting the Screen Quality

The purpose of the picture quality adjustment is to remove or reduce picture noise. If the noise is not removed by fine tuning alone, then do the frequency adjustments to the utmost and fine tune again. After the noise has been reduced, re-adjust the picture so that it is aligned on the center of screen.

Press the PC button on the remote control to select the PC mode.

**1**

Press the **MENU** button to display the menu.

Press the **DOWN** ▼ button to select "PC", then press the **RIGHT** ► button.

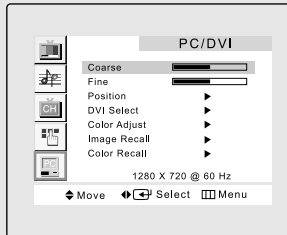

**2**

Press the **DOWN** ▼ button to select "Coarse" or "Fine".

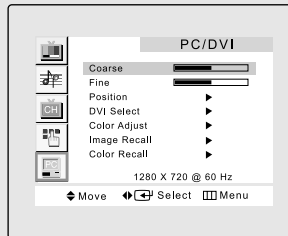

**3**

Press the **LEFT/RIGHT** ◀▶ button to adjust the screen quality, vertical stripes appear or the picture may be blurry.



<Adjusting Coarse>



<Adjusting Fine>

**4**

When you are satisfied with the settings, press the **MENU** button repeatedly to return to normal viewing.

## Changing the Screen Position

Press the PC button on the remote control to select the PC mode.

**1**

Press the **MENU** button to display the menu.

Press the **DOWN ▼** button to select “PC”, then press the **RIGHT ►** button.

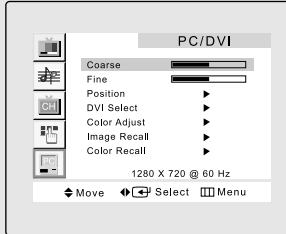

**2**

Press the **DOWN ▼** button to select “Position”, then press the **RIGHT ►** button. Repeatedly press **RIGHT ►** to choose between H-Position and V-Position.

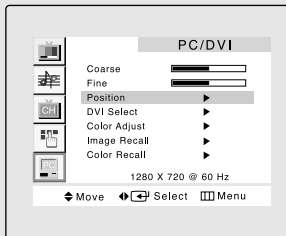

**3**

If H-Position is selected, press the **UP/DOWN ▲ ▼** button to select the item you want to adjust, then press the **LEFT/RIGHT ◀ ▶** button to adjust the H-Position.

Press the **MENU** button to exit.

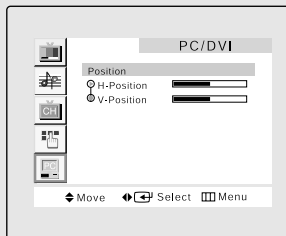

To Return the Screen Position settings to the default position.

Press the **DOWN ▼** button to select “Image Recall”, then press the **RIGHT ►** button to return H and V positions to their default settings.

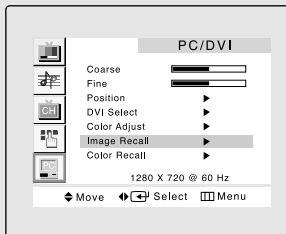

## Changing the Screen Color Standard

Press the PC button on the remote control to select the PC mode.

**1**

Press the **MENU** button to display the menu.

Press the **DOWN** ▼ button to select “PC”, then press the **RIGHT** ► button.

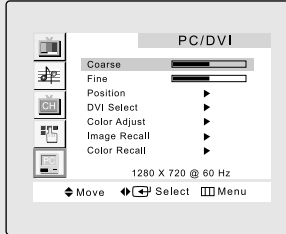

**2**

Press the **DOWN** ▼ button to select “Color Adjust”.

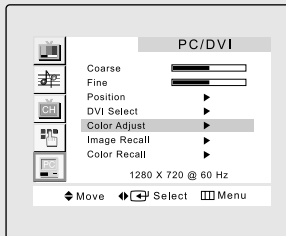

**3**

Press the **LEFT/RIGHT** ◀▶ buttons to select “Custom”, “Color1”, “Color2” or “Color3”.

Press the **MENU** button to exit.

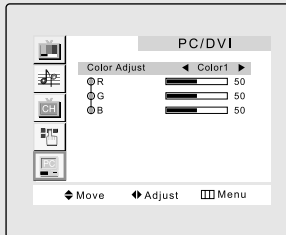

## Adjusting the Screen Color Settings

Press the PC button on the remote control to select the PC mode.

**1**

Press the **MENU** button to display the menu.

Press the **DOWN ▼** button to select “PC”, then press the **RIGHT ►** button.

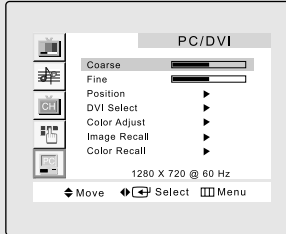

**2**

Press the **DOWN ▼** button to select “Color Adjust”, then press the **RIGHT ►** button. Repeatedly press **RIGHT ►** to choose between Color 1,2, and 3 auto settings and Custom.

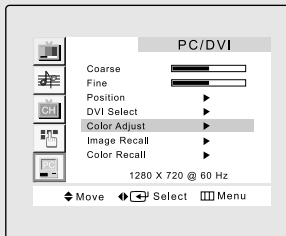

**3**

If Custom is selected, press the **UP/DOWN ▲▼** button to select the item you want to adjust, then press the **LEFT/RIGHT ◀▶** button to adjust the color(R, G, B).

Press the **MENU** button to exit.

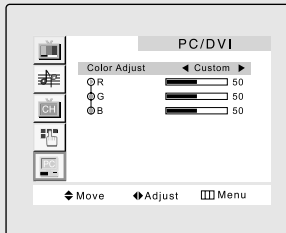

To Return the Custom settings back to the default position.

Press the **DOWN ▼** button to select “Color Recall”, then press the **RIGHT ►** button to return R,G,B to their default settings.

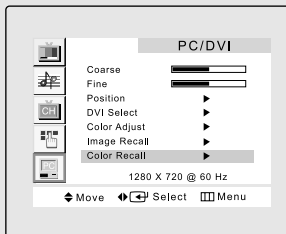

# Chapter Six

## TROUBLESHOOTING

If the TV seems to have a problem, first try this list of possible problems and solutions. If none of these troubleshooting tips apply, call your nearest Samsung service center.

### Identifying Problems

<b>Problem</b>	<b>Possible Solution</b>
Poor picture	Try another channel. Adjust the antenna. Check all wire connections.
Poor sound quality.	Try another channel. Adjust the antenna.
No picture or sound.	Try another channel. Press the TV/VIDEO button. Make sure the TV is plugged in. Check the antenna connections.
No sound or sound is too low at maximum volume.	First, check the volume of units connected to your TV (digital broadcasting receiver, DTV, DVD, cable broadcasting receiver, VCR, etc.). Then, adjust the TV volume accordingly.
No color, wrong colors or tints.	Make sure the program is broadcast in color. Adjust the picture settings. If the set is moved or turned in a different direction, the power should be OFF for at least 30 minutes. Adjust the antenna.
Picture rolls vertically.	Check all wire connections.
The TV operates erratically.	Unplug the TV for 30 seconds, then try operating it again.
The TV won't turn on.	Make sure the wall outlet is working.
Blurred or snowy picture, distorted sound.	Check the direction, location and connections of your antenna. This interference is often due to the use of an indoor antenna.
Remote control malfunctions	Replace the remote control batteries. Clean the upper edge of the remote control (transmission window). Check the battery terminals.
"Check Signal Cable" message.	Ensure that the signal cable is firmly connected to the PC sources. Ensure that the PC sources are turned on.

## TROUBLESHOOTING

<b>Problem</b>	<b>Possible Solution</b>
“Not Supported Mode!” message.	Check the maximum resolution and the frequency of the video Adapter. Compare these values with the data in the Display Modes Timing Chart.
The image is too light or too dark.	Adjust the Brightness and Contrast. Adjust the Fine function.
Horizontal bars appear to flicker, jitter or shimmer on the image.	Adjust the Coarse function and then adjust the Fine function.
Vertical bars appear to flicker, jitter or shimmer on the image.	The TV is using its power management system. Move the computer’s mouse or press a key on the keyboard.
Screen is black and power indicator light blinks steadily.	Check that the display resolution and frequency from your PC or video board is an available mode for your TV. On your computer check: Control Panel, Display, Settings.
Image is not stable and may appear to vibrate.	If the setting is not correct, use your computer utility program to change the display settings. NOTE: Your TV supports multiscan display functions within the following frequency domain: <ul style="list-style-type: none"> <li>• Horizontal frequency: 30 kHz ~ 61 kHz</li> <li>• Vertical frequency: 60 Hz ~ 75 Hz</li> <li>• Maximum refresh rate: 1280 x 720 @ 60 Hz</li> </ul>
Image is not centered on the screen.	Adjust the horizontal and vertical position.

## Display Modes

If the signal from the system equals the standard signal mode, the screen is adjusted automatically. If the signal from the system doesn't equal the standard signal mode, adjust the mode by referring to your Videocard user guide; otherwise there may be no video. For the display modes listed below, the screen image has been optimized during manufacture.

Mode	Resolution	Horizontal Frequency (kHz)	Vertical Frequency (Hz)	Pixel Clock Frequency (MHz)	Sync Polarity (H/V)
MAC	640X480	35.000	66.667	30.240	- / -
	832X624	49.726	74.551	49.500	+ / +
IBM	640X480	31.469	59.940	25.175	- / -
	720X400	31.469	70.087	28.322	- / +
VESA	640X480	37.861	72.809	31.500	- / -
	640X480	37.500	75.000	31.500	- / -
	800X600	37.879	60.317	40.000	+ / +
	800X600	48.077	72.188	50.000	+ / +
	800X600	46.875	75.000	49.500	+ / +
GTF	1280X720	44.769	60.000	74.841	- / +

## Installing VESA compliant mounting devices

Refer to page A.3 to remove the base.

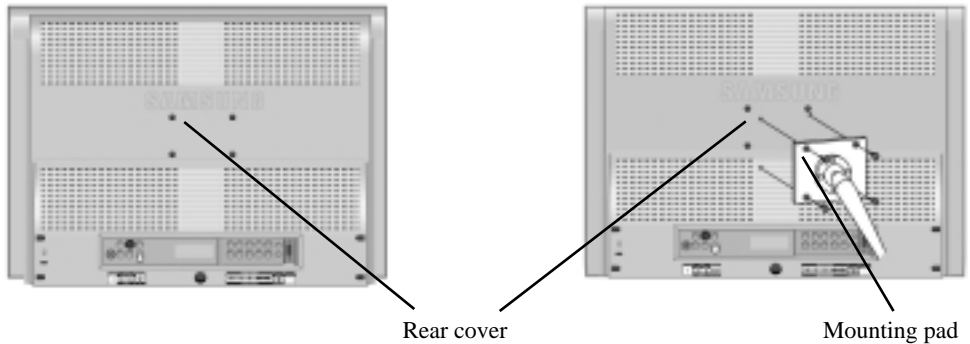

Align the mounting interface pad with the holes in the rear cover mounting pad and secure it with the four screws that come with the arm-type base, wall mount hanger or other bases.

### Wall Mount Instructions

The following instructions apply to a hollow sheet-rock wall only. Tools/Hardware needed - Philips screwdriver, four toggle bolts, 5/8in dia. Drill bit and drill. Contact Ergotron at (800) 888-8458 to purchase the triple pivot direct mount adapter and wall mount bracket kit.

- LTM225W (22") : No. 47 - 007 - 099 - 02 (Pivot direct mount adapter)  
No. 97 - 101 - 003 - 00 (Wall mount bracket kit)

Align the wall mount bracket on the wall at the desired height, making sure that the bracket will be mounted between the wall studs. Mark the four corner openings and drill four 5/8-dia. holes.

Assemble the wall mount kit according to the instructions provided with it. Securely attach Ergotron's flat panel, triple pivot direct mount adapter to the back of the TV using the four 4mm, .7 pitch x 10mm screws provided with the arm. Secure the assembly to the wall using four 3/16 by 3-inch long toggle bolts.

### Installation Notes

1. This monitor is designed for vertical wall surface installation only.
2. To protect your monitor from malfunction, please avoid installing near the following:
  - Sprinkler sensor
  - Any likely source of vibration or shock
  - High-voltage cables
  - Heat source
  - High-humidity area
3. Always install using the proper method for your specific installation.
  - i.g. For concrete wall installation, use concrete-specific nails.
4. Do not build monitor into wall.



## Attaching a Wall or Arm mounting device

The TV supports VESA mounting standard for use with various VESA mounting devices. To install any VESA mounting device, please follow the instructions given.

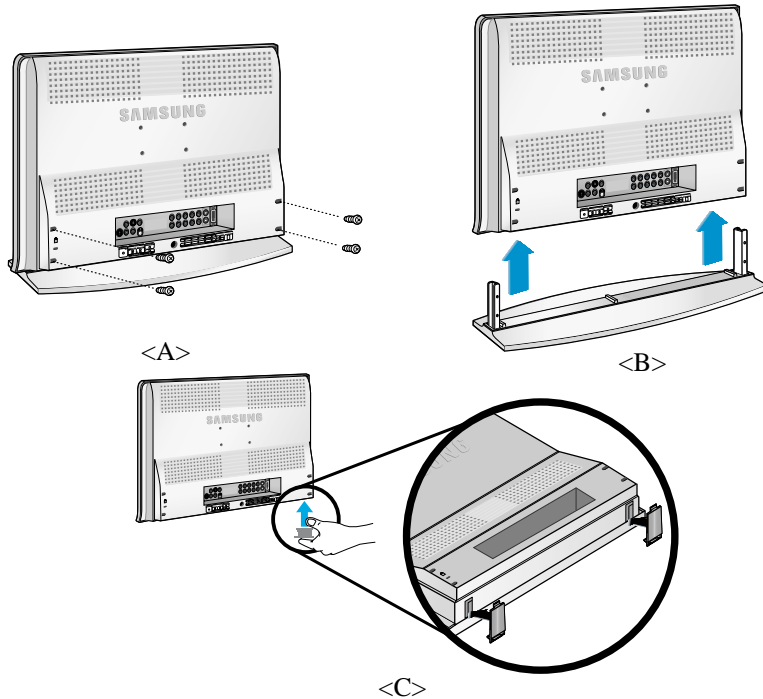

### 1

Remove all cables connected on the TV.

### 2

Remove the four screws and then remove the Stand from the LCD TV. (Refer to pictures A&B).

### 3

Push the stand cap until it clicks, as shown in Figure C.

### 4

Re-connect all cables you removed in step 1.

### 5

Now you are ready to install Wall/Arm mounting device .

## Maintenance of Your LCD TV

**WARNING:** To avoid risk of electric shock, do not disassemble the TV cabinet (except for gaining access to the cable connectors as described on Chapter 2). Users cannot service the TV. User maintenance is restricted to cleaning as explained below:

Unplug the LCD TV from the power outlet before cleaning.

- To clean your flat panel display screen, lightly dampen a soft, clean cloth with water or mild detergent. If possible, use a special screen cleaning tissue or solution suitable for the antistatic coating.
- To clean the LCD TV cabinet, use a cloth lightly dampened with a mild detergent.
- Never use flammable cleaning material to clean your LCD TV or any other electrical apparatus.

## Using the Anti-Theft Kensington Lock

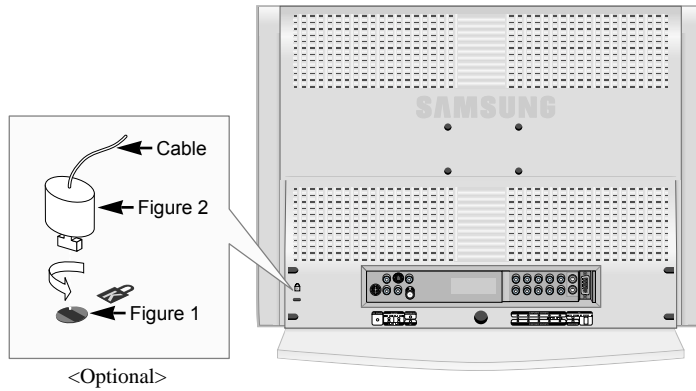

The Kensington lock is a device used to physically fix the system when using it in a public place. The locking device has to be purchased separately. The appearance and locking method may differ from the illustration depending on the manufacturer. Please refer to the manual provided with the Kensington lock for proper use.

### 1

Insert the locking device into the Kensington slot on the LCD TV (figure 1), and turn it in the locking direction (figure 2).

### 2

Connect the Kensington lock cable.

### 3

Fix the Kensington lock to a desk or a heavy stationary object.

## Pin Assignments

### Pin DVI Connection

Pin	1	2	3	4	5	6	7	8	9	10
Separate H/V	Rx 2-	Rx 2+	GND	No Connection	No Connection	DDC Clock (SCL)	DDC Data (SDA)	Analog Vertical Sync	Rx 1-	Rx 1+
Pin	11	12	13	14	15	16	17	18	19	20
Separate H/V	GND	No Connection	No Connection	DDC Input Power (+5V)	Self Laster	Output Signal Connection	Rx 0-	Rx 0+	GND	No Connection
Pin	21	22	23	24	25(C3)	26(C5)	27(C4)	28(C2)	29(C5)	30(C1)
Separate H/V	No Connection	GND	Rx C-	Rx C+	Analog (Blue)	Analog GND	Analog Horizontal Sync	Analog (Green)	Analog GND	Analog (Red)

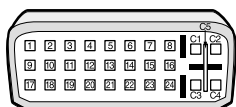

## Cleaning and Maintaining Your TV

With proper care, your TV unit will give you many years of service. Please follow these guidelines to get the maximum performance from your TV.

### Placement

- Do not place the TV near extremely hot, cold, humid or dusty places.
- Do not place the TV near appliances with electric motors that create magnetic fields, such as vacuum cleaners.
- Keep the ventilation openings clear; do not place the TV on a soft surface, such as cloth or paper.
- Place the TV in a vertical position only.

### Liquids

- Do not handle liquids near or on the TV.  
Liquids that spill into it can cause serious damage.

### Cabinet

- Never open the cabinet or touch the parts inside.
- Wipe your TV with a clean, dry cloth. Never use water, cleaning fluids, wax, or chemicals.
- Do not put heavy objects on top of the cabinet.

### Temperature

- If your TV is suddenly moved from a cold to a warm place, unplug the power cord, and allow at least two hours for moisture that may have formed inside the unit to dry completely.

## Using Your TV in Another Country

If you plan to take your TV with you to a foreign country, please be aware of the different television systems that are in use around the world. A TV designed for one system may not work properly with another system due to differences in the TV channel frequencies.

## Specifications

Model Name	LTM225W	
Panel	Display Size Size Type Pixel Pitch Viewing Angle	22.0 inch Diagonal 487.68(H) X 274.32(V)mm a-si TFT active matrix 0.381(H) X 0.381(V)mm 85/85/85/85 (L/R/U/D)
*Frequency	Horizontal Vertical Display Color	30 ~ 61 kHz 56 ~ 75 Hz 16,777,216 colors
Display Resolution	Maximum Mode	1280 X 720 @ 60 Hz
Input Signal	Sync. Video signal	H/V Separate, TTL, P. or N. 0.7 Vp-p @ 75 ohm
Video	Color system Video system	NTSC CVBS, S-VHS, RGB
Component	Video In Audio In	1.0 Vp-p @ 75 ohm 500mVrms
Power Supply	Input Output	AC 100 ~ 240 V (50/60Hz), 2A DC 14V / 8A
Power Consumption	Maximum Power Saving	120 W < 5 W
Dimensions / Weight	Unit (WxDxH): body  With stand	23.62 x 2.63 x 17.46inch / 15.65 lbs (600 x 66.8 x 443.5 mm / 7.1 kg)  23.62 x 7.28 x 18.43inch / 19.40 lbs (600 x 185 x 468 mm / 8.8 kg)
Environmental Considerations	Operating Temperature Operating Humidity Storage Temperature Storage Humidity	50 °F to 104 °F (10 °C to 40 °C)  10% to 80%  -13 °F to 113 °F (-25 °C to 45 °C)  5% to 95%
Audio Characteristics	Audio Input 1 Audio Input 2 Headphone out Frequency Response	RCA Jack Red(R) White(L), 0.5Vrms (-9dB) 3.5ø Stereo Jack, 0.5Vrms (-9dB) Max. 10mW Output (3.5ø Stereo Jack 32)  RF: 80Hz ~ 15kHz (at - 3dB) A/V: 80Hz ~ 20kHz (at - 3dB)

\* Referring to Display Modes, page A.1.