

Digital Video Camera Recorder ^{Mini DV} Digital Video Cassette

Operating Instructions

Before operating the unit, please read this manual thoroughly, and retain it for future reference.

Owner's Record

The model and serial numbers are located on the bottom. Record the serial number in the space provided below. Refer to these numbers whenever you call upon your Sony dealer regarding this product.

Model No. **DCR-PC101**

Model No. **AC-**_____

Serial No. _____ Serial No. _____

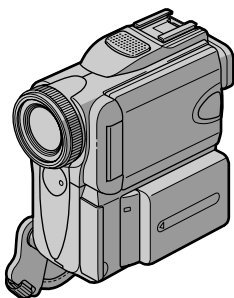

Digital Handycam

InfoLITHIUM™ M SERIES

C// Cassette
Memory



MEMORY STICK™

DCR-PC101

Welcome!

Congratulations on your purchase of this Sony Handycam. With your Handycam, you can capture life's precious moments with superior picture and sound quality. Your Handycam is loaded with advanced features, but at the same time it is very easy to use. You will soon be producing home video that you can enjoy for years to come.

WARNING

To prevent fire or shock hazard, do not expose the unit to rain or moisture.

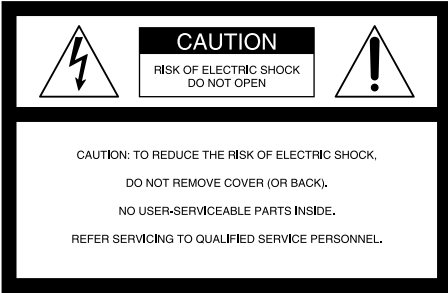

This symbol is intended to alert the user to the presence of uninsulated "dangerous voltage" within the product's enclosure that may be of sufficient magnitude to constitute a risk of electric shock to persons.



This symbol is intended to alert the user to the presence of important operating and maintenance (servicing) instructions in the literature accompanying the appliance.

For the customers in the U.S.A. and CANADA

CAUTION

TO PREVENT ELECTRIC SHOCK, MATCH WIDE BLADE OF PLUG TO WIDE SLOT, FULLY INSERT.

RECYCLING LITHIUM-ION BATTERIES

Lithium-Ion batteries are recyclable. You can help preserve our environment by returning your used rechargeable batteries to the collection and recycling location nearest you.

For more information regarding recycling of rechargeable batteries, call toll free 1-800-822-8837, or visit <http://www.rbrcc.org/>.

Caution: Do not handle damaged or leaking Lithium-Ion batteries.



"Memory Stick"

THIS DEVICE COMPLIES WITH PART 15 OF THE FCC RULES. OPERATION IS SUBJECT TO THE FOLLOWING TWO CONDITIONS:

(1) THIS DEVICE MAY NOT CAUSE HARMFUL INTERFERENCE, AND (2) THIS DEVICE MUST ACCEPT ANY INTERFERENCE RECEIVED, INCLUDING INTERFERENCE THAT MAY CAUSE UNDESIRED OPERATION.

THIS CLASS B DIGITAL APPARATUS COMPLIES WITH CANADIAN ICES-003.

For the customers in the U.S.A.

If you have any questions about this product, you may call:
Sony Customer Information Center 1-800-222-SONY (7669)

The number below is for the FCC related matters only.

Regulatory Information

Declaration of Conformity

Trade Name: SONY
Model No.: DCR-PC101
Responsible Party: Sony Electronics Inc.
Address: 680 Kinderkamack Road,
Oradell, NJ 07649 U.S.A.
Telephone No.: 201-930-6972

This device complies with Part 15 of the FCC Rules. Operation is subject to the following two conditions: (1) This device may not cause harmful interference, and (2) this device must accept any interference received, including interference that may cause undesired operation.

CAUTION

You are cautioned that any changes or modifications not expressly approved in this manual could void your authority to operate this equipment.

Note:

This equipment has been tested and found to comply with the limits for a Class B digital device, pursuant to Part 15 of the FCC Rules. These limits are designed to provide reasonable protection against harmful interference in a residential installation. This equipment generates, uses, and can radiate radio frequency energy and, if not installed and used in accordance with the instructions, may cause harmful interference to radio communications. However, there is no guarantee that interference will not occur in a particular installation. If this equipment does cause harmful interference to radio or television reception, which can be determined by turning the equipment off and on, the user is encouraged to try to correct the interference by one or more of the following measures:

- Reorient or relocate the receiving antenna.
- Increase the separation between the equipment and receiver.
- Connect the equipment into an outlet on a circuit different from that to which the receiver is connected.
- Consult the dealer or an experienced radio/TV technician for help.

Checking supplied accessories

Make sure that the following accessories are supplied with your camcorder.

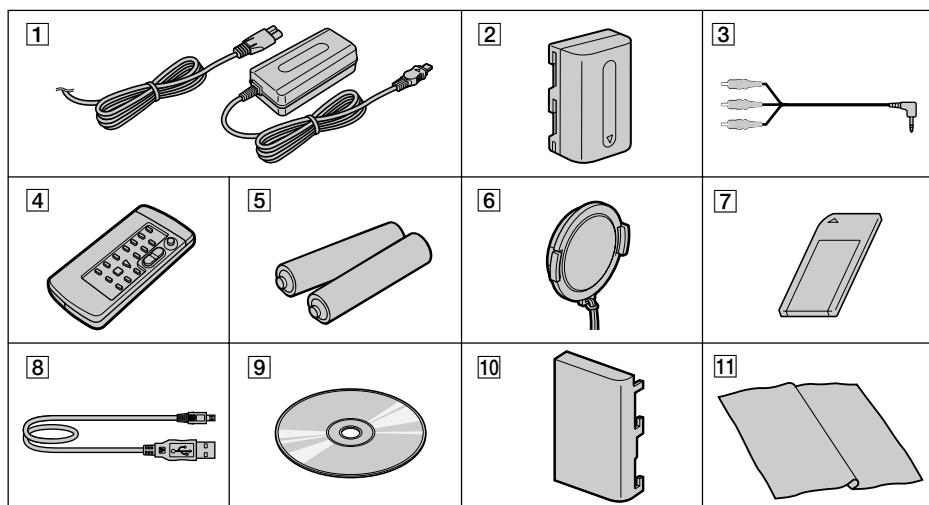

- | | |
|-------------------------------------------------------------------------|----------------------------------------------------|
| 1 AC-L10A/L10B/L10C AC power adaptor (1), Power cord (1) (p. 15) | 6 Lens cap (1) (p. 24) |
| 2 NP-FM50 battery pack (1) (p. 14, 15) | 7 "Memory Stick" (1) (p. 113) |
| 3 A/V connecting cable (1) (p. 43) | 8 USB cable (1) (p. 163) |
| 4 Wireless Remote Commander (1) (p. 221) | 9 CD-ROM (SPVD-008 USB Driver) (1) (p. 168) |
| 5 Size AA (R6) battery for Remote Commander (2) (p. 221) | 10 Battery terminal cover (1) (p. 14) |
| | 11 Cleaning cloth (1) (p. 210) |

Contents of the recording cannot be compensated if recording or playback is not made due to a malfunction of the camcorder, storage media, etc.

Main Features

Recording moving pictures or still images, and playing them back



- Recording moving pictures on tapes (p. 24)
- Recording still images on tapes (p. 47)
- Playing back tapes (p. 38)
- Recording still images on “Memory Stick”s (p. 44, 122)
- Recording moving pictures on “Memory Stick”s (p. 136)
- Viewing still images recorded on “Memory Stick”s (p. 148)
- Viewing moving pictures on “Memory Stick”s (p. 151)

Main Features

- Viewing moving pictures recorded on tapes using USB cable (p. 174)
- Viewing images recorded on “Memory Stick”s using the USB cable (p. 178, 182)
- Capturing images on your computer from your camcorder using the USB cable (p. 176)
- Converting an analog signal into digital to capture images onto your computer (p. 183)

Capturing images on your computer

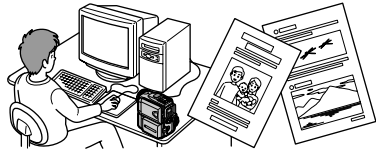

Other uses

Functions to adjust exposure in recording

- BACK LIGHT (p. 32)
- NightShot/Super NightShot/Color Slow Shutter (p. 32)
- PROGRAM AE (p. 60)
- White balance (p. 49)
- Adjusting the exposure manually (p. 63)
- Flexible Spot Meter (p. 64)

Functions to give images more impact

- Digital zoom [MENU] (p. 29)
The default setting is set to **OFF**. (To zoom greater than 10×, select the digital zoom power in **D ZOOM** in the menu settings.)
- Fader (p. 53)
- Picture effect (p. 56)
- Digital effect (p. 57)
- Titles (p. 106)
- MEMORY MIX (p. 131)

Functions to give a natural appearance to your recordings

- Sports lesson (p. 60)
- Landscape (p. 60)
- Manual focus (p. 65)
- Spot Focus (p. 66)

Functions to use after recording

- END SEARCH/EDITSEARCH/Rec Review (p. 36)
- DATA CODE (p. 39)
- Tape PB ZOOM (p. 74)
- ZERO SET MEMORY (p. 76)
- TITLE SEARCH (p. 77)
- Digital program editing (p. 85, 143)

Table of contents

Checking supplied accessories.....	3	Using the spot light-metering function	
Main Features	4	– Flexible Spot Meter	64
Quick Start Guide		Focusing manually	65
– Recording on a tape	8	Using the spot focus function	
– Recording on a “Memory Stick”	10	– Spot Focus	66
Getting started		Interval recording	67
Using this manual	12	Frame by frame recording	
Step 1 Preparing the power supply	14	– Frame recording	69
Installing the battery pack	14	Using the viewfinder	70
Charging the battery pack	15		
Connecting to a wall outlet	18	Advanced Playback	
Step 2 Setting the date and time	19	Operations	
Step 3 Inserting a cassette	21	Playing back a tape with picture effect	72
Step 4 Using the touch panel	22	Playing back a tape with digital effect	73
		Enlarging images recorded on tapes	
Recording – Basics		– Tape PB ZOOM	74
Recording a picture	24	Quickly locating a scene	
Shooting a backlit subject		– ZERO SET MEMORY	76
– BACK LIGHT	32	Searching the boundaries of recorded	
Shooting in the dark		tape by title – TITLE SEARCH	77
– NightShot/Super NightShot/ Color Slow Shutter	32	Searching a recording by date	
Self-timer recording	35	– DATE SEARCH	78
Checking the recording		Searching for a photo	
– END SEARCH/ EDITSEARCH/Rec Review	36	– PHOTO SEARCH/PHOTO SCAN ...	80
Playback – Basics		Editing	
Playing back a tape	38	Dubbing a tape	83
To display the screen indicators		Dubbing only desired scenes	
– Display function	39	– Digital program editing (on tapes) ...	85
Viewing the recording on TV	43	Recording video or TV programs	97
		Inserting a scene from a VCR	
Advanced Recording		– Insert editing	100
Operations		Audio dubbing	102
Recording still images on a		Superimposing a title	106
“Memory Stick” during recording		Making your own titles	109
on a tape	44	Labeling a cassette	111
Recording a still image on a tape			
– Tape Photo recording	47	“Memory Stick” Operations	
Adjusting the white balance manually ...	49	Using a “Memory Stick”	
Using the wide mode	51	– Introduction	113
Using the fader function	53	Recording still images on	
Using special effects – Picture effect ...	56	“Memory Stick”s	
Using special effects – Digital effect ...	57	– Memory photo recording	122
Using the PROGRAM AE	60	Recording an image from a tape	
Adjusting the exposure manually	63	as a still image	127
		Superimposing a still image in the	
		“Memory Stick” on an image	
		– MEMORY MIX	131
		Recording moving pictures on	
		“Memory Stick”s	
		– MPEG movie recording	136

Table of contents

Recording a picture from a tape as a moving picture	139
Recording edited pictures from a tape as a moving picture	
– Digital program editing (on “Memory Stick”s)	143
Copying still images from a tape	
– PHOTO SAVE	146
Viewing a still image	
– Memory photo playback	148
Viewing a moving picture	
– MPEG movie playback	151
Enlarging still images recorded on “Memory Stick”s	
– Memory PB ZOOM	154
Playing back images in a continuous loop – SLIDE SHOW	155
Preventing accidental erasure	
– Image protection	156
Deleting images – DELETE	157
Writing a print mark	
– PRINT MARK	160
Using the optional printer	161

Viewing images with your computer

Viewing images with your computer	
– Introduction	163
Connecting to your computer with USB port – For Windows users ...	166
Viewing images recorded on a tape on your computer	
– For Windows users	174
Viewing images recorded on a “Memory Stick” on your computer – For Windows users ...	178
Connecting to your computer with USB port – For Macintosh users ...	180
Viewing images recorded on a “Memory Stick” on your computer – For Macintosh users ...	182
Capturing images from an analog video unit on your computer	
– Signal convert function	183

Customizing Your Camcorder

Changing the menu settings	184
----------------------------------	-----

Troubleshooting

Types of trouble and how to correct trouble	193
Self-diagnosis display	200
Warning indicators and messages	201

Additional Information

Usable cassettes	203
About the “InfoLITHIUM” battery pack	205
About i.LINK	206
Using your camcorder abroad	208
Maintenance information and precautions	209
Specifications	214

Quick Reference

Identifying the parts and controls	216
Index	223

Quick Start Guide – Recording on a tape



Holding Grip

This chapter introduces you to the basic features to record pictures on tapes of your camcorder. See the page in parentheses “()” for more information.

Pull down the Holding Grip to hold your camcorder as illustrated.

1 Connecting the power cord (p. 18)

Use the battery pack when using your camcorder outdoors (p. 14).

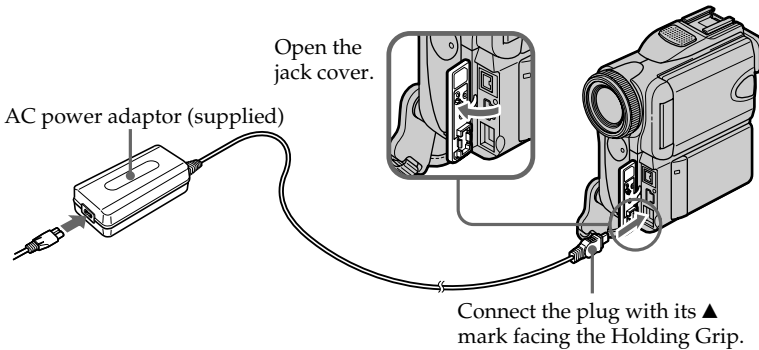

2 Inserting a cassette (p. 21)

- 1 Slide OPEN/▲EJECT▲ in the direction of the arrow and open the lid.



- 2 Push the middle portion of the back of the cassette to insert. Insert the cassette in a straight line deeply into the cassette compartment with the window facing out.

- 3 Close the cassette compartment by pressing the PUSH mark on the cassette compartment. After the cassette compartment goes down completely, close the lid until it clicks.

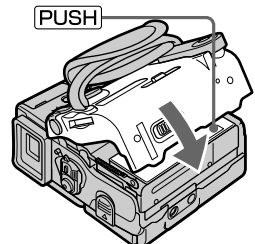
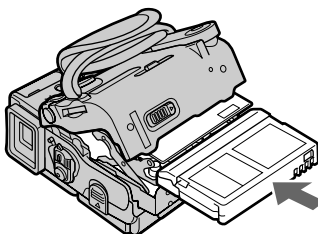
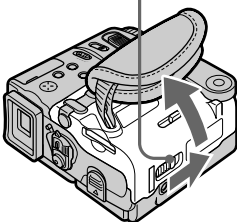

3 Recording a picture (p. 24)

1 Remove the lens cap.

3 Press OPEN to open the LCD panel. The picture appears on the screen.

Viewfinder

When the LCD panel is closed, pull out the viewfinder until it clicks. Adjust the viewfinder lens to your eyesight (p. 28).

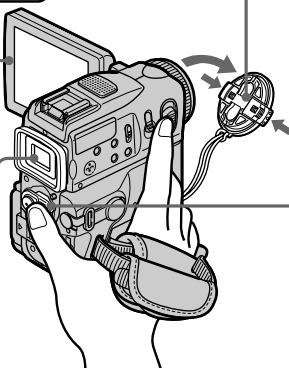

2 Set the POWER switch to CAMERA while pressing the small green button.

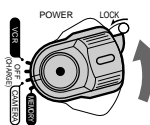

4 Press START/STOP. Your camcorder starts recording. To stop recording, press START/STOP again.

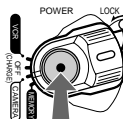

When you purchase your camcorder, the clock setting is set to off. If you want to record the date and time on a picture, set the clock setting before recording (p. 19).

4 Monitoring the playback picture on the LCD screen (p. 38)

1 Set the POWER switch to VCR while pressing the small green button.

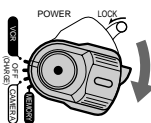

2 Press of the touch panel to rewind the tape.



3 Press of the touch panel to start playback.



NOTE

When using the touch panel, press operation buttons lightly with your thumb supporting the LCD screen from the rear of it. Do not press the LCD screen with sharp-pointed objects such as a pen.

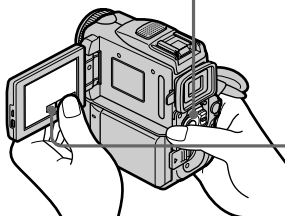

NOTE

Do not pick up your camcorder by the viewfinder, the LCD panel, the battery pack or the jack cover.

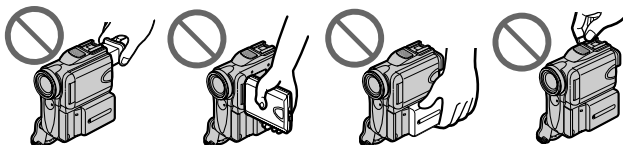

Quick Start Guide – Recording on a “Memory Stick”



Holding Grip

This chapter introduces you to the basic features to record on a “Memory Stick” of your camcorder. See the page in parentheses “()” for more information.

Pull down the Holding Grip to hold your camcorder as illustrated.

1

Connecting the power cord (p. 18)

Use the battery pack when using your camcorder outdoors (p. 14).

AC power adaptor (supplied)

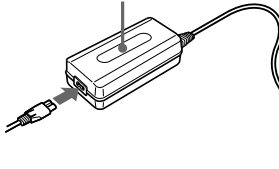

Open the jack cover.

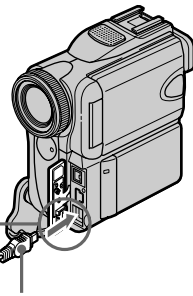
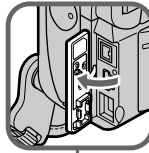

Connect the plug with its ▲ mark facing the Holding Grip.

2

Inserting a “Memory Stick” (p. 115)

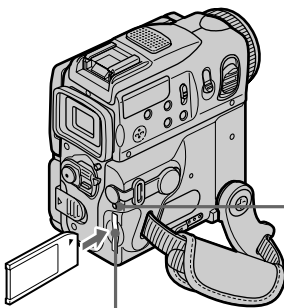

Access lamp

“Memory Stick” slot

Insert a “Memory Stick” in the “Memory Stick” slot as far as it can go with the ► mark facing up as illustrated.

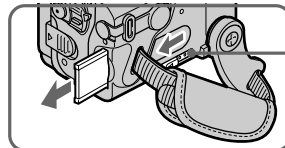

MEMORY EJECT

When you eject the “Memory Stick,” slide MEMORY EJECT in the direction of the arrow.

3

Recording a still image on a "Memory Stick" (p. 122)

1 Remove the lens cap.

3 Press OPEN to open the LCD panel. The picture appears on the screen.

Viewfinder

When the LCD panel is closed, pull out the viewfinder until it clicks. Adjust the viewfinder lens to your eyesight (p. 28).

2 Set the POWER switch to MEMORY while pressing the small green button. Make sure that the LOCK switch is set to the right (unlock) position.

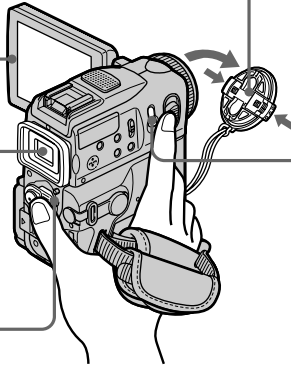

4 Press PHOTO lightly.



5 Press PHOTO deeper.



When you purchase your camcorder, the clock setting is set to off. If you want to record the date and time on a picture, set the clock setting before recording (p. 19).

4

Monitoring the still image on the LCD screen (p. 148)

1 Set the POWER switch to MEMORY while pressing the small green button. Make sure that the LOCK switch is set to the right (unlock) position.

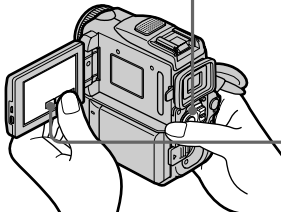
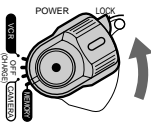

2 Press PLAY. The last recorded image is displayed.

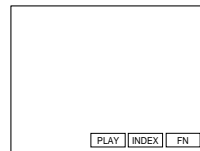

NOTE

Do not pick up your camcorder by the viewfinder, the LCD panel, the battery pack or the jack cover.

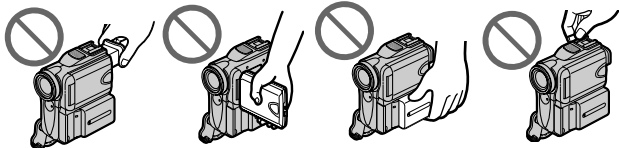

Using this manual

As you read through this manual, buttons and settings on your camcorder are shown in capital letters.

e.g. Set the POWER switch to CAMERA.

When you carry out an operation, you can hear a beep sound to indicate that the operation is being carried out.

Note on Cassette Memory

Your camcorder is based on the DV format. You can only use mini DV cassettes with your camcorder. We recommend that you use a tape with cassette memory **CM**.

The functions which require different operations depending on whether the tape has the cassette memory or not are:

- END SEARCH (p. 36)
- DATE SEARCH (p. 78)
- PHOTO SEARCH (p. 80)

The functions you can operate only with the cassette memory are:

- TITLE SEARCH (p. 77)
- Superimposing a title (p. 106)
- Labeling a cassette (p. 111)

For details, see page 203.



You see this mark in the introduction to the features that operate only with cassette memory.

Cassettes with cassette memory are marked by **CM** (Cassette Memory).

Note on TV color systems

TV color systems differ from country to country. To view your recordings on a TV, you need a NTSC system-based TV.

Copyright precautions

Television programs, movies, video tapes, and other materials may be copyrighted. Unauthorized recording of such materials may be contrary to the provision of the copyright laws.

Precautions on camcorder care

Lens and LCD screen/finder (on mounted models only)

- The LCD screen and the finder are manufactured using extremely high-precision technology, so over 99.99% of the pixels are operational for effective use. However, there may be some tiny black points and/or bright points (white, red, blue or green in color) that constantly appear on the LCD screen and the finder. These points are normal in the manufacturing process and do not affect the recording in any way.
- Do not let your camcorder get wet. Keep your camcorder away from rain and sea water. Letting your camcorder get wet may cause your camcorder to malfunction. Sometimes this malfunction cannot be repaired [a].
- Never leave your camcorder exposed to temperatures above 60 °C (140 °F), such as in a car parked in the sun or under direct sunlight [b].
- Be careful when placing your camcorder near a window or outdoors. Exposing the LCD screen, the finder or the lens to direct sunlight for long periods may cause malfunctions [c].
- Do not directly shoot the sun. Doing so might cause your camcorder to malfunction. Take pictures of the sun in low light conditions such as dusk [d].

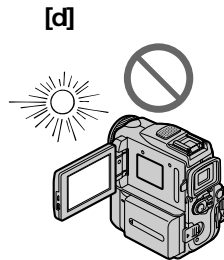
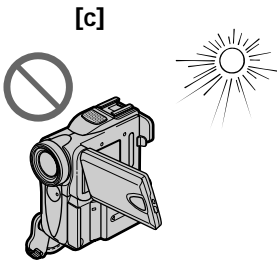
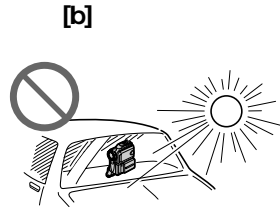
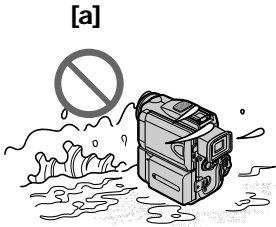

Step 1 Preparing the power supply

Installing the battery pack

- (1) While sliding BATT (battery) release lever in the direction of the arrow ❶, slide the battery terminal cover in the direction of the arrow ❷.
- (2) Insert the battery pack in the direction of the arrow until it clicks.

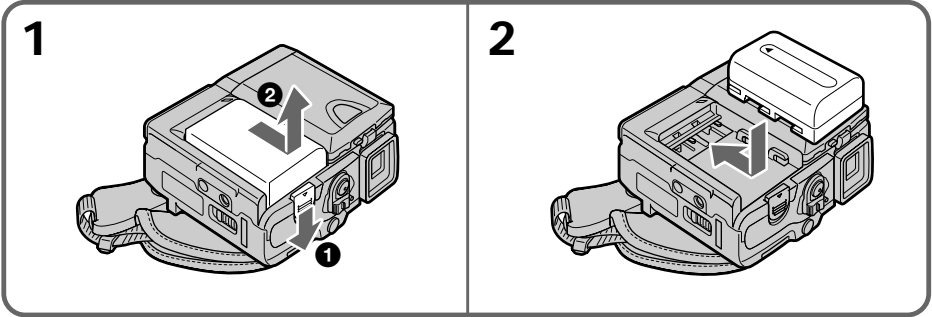

To remove the battery pack

The battery pack is removed in the same way as the battery terminal cover.

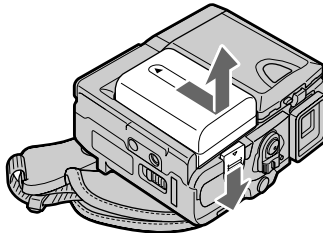

Note on the battery terminal cover

To protect the battery terminals, install the battery terminal cover after the battery pack is removed.

Step 1 Preparing the power supply

Charging the battery pack

Use the battery pack after charging it for your camcorder.
Your camcorder operates only with the "InfoLITHIUM" battery pack (M series).
See page 205 for details of the "InfoLITHIUM" battery pack.

- (1) Install the battery pack on your camcorder.
- (2) Open the jack cover and connect the AC power adaptor supplied with your camcorder to the DC IN jack with the plug's ▲ mark facing the Holding Grip.
- (3) Connect the power cord to the AC power adaptor.
- (4) Connect the power cord to a wall outlet.
- (5) Set the POWER switch to OFF (CHARGE).

The CHARGE lamp lights up when the charge begins. After the charge is completed, the CHARGE lamp goes off (full charge).

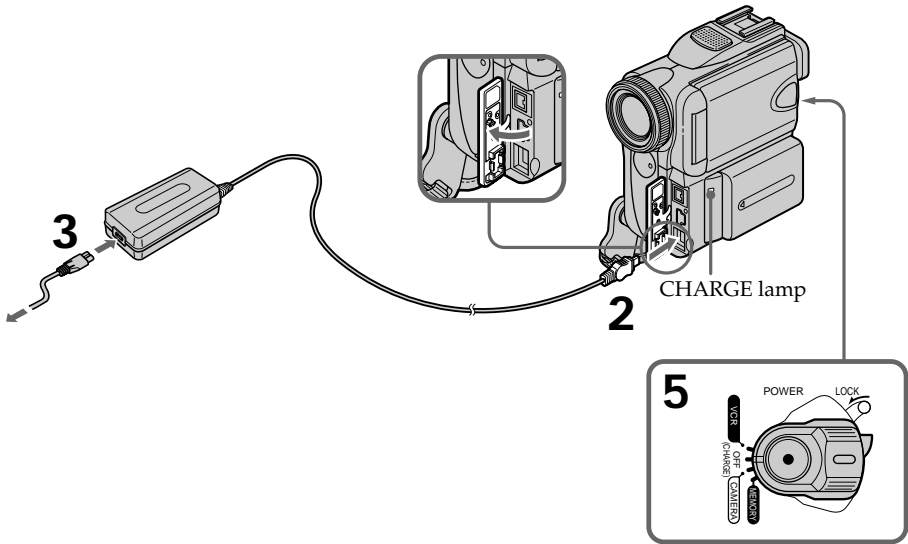

After charging the battery pack

Disconnect the AC power adaptor from the DC IN jack on your camcorder.

While charging the battery pack, the CHARGE lamp flashes in the following cases:

- The battery pack is not installed correctly.
- Something is wrong with the battery pack.

When you use the AC power adaptor

Place the AC power adaptor near a wall outlet. If any trouble occurs with this unit, disconnect the plug from a wall outlet as soon as possible to cut off the power.

Step 1 Preparing the power supply

Charging time

Battery pack	Full charge
NP-FM50 (supplied)	150
NP-FM70	240
NP-QM71	260
NP-FM90	330
NP-FM91/QM91	360

Approximate minutes at 25 °C (77 °F) to charge an empty battery pack

The charging time may increase if the battery's temperature is extremely high or low because of the ambient temperature.

Recording time

Battery pack	Recording with the viewfinder		Recording with the LCD screen	
	Continuous	Typical*	Continuous	Typical*
NP-FM50 (supplied)	150	85	120	70
NP-FM70	310	180	255	150
NP-QM71	365	215	300	175
NP-FM90	475	280	390	230
NP-FM91/QM91	550	325	455	265

Approximate minutes when you use a fully charged battery

* Approximate recording time when you repeat recording, start/stop, zoom and turn the power on/off. The actual battery life may be shorter.

Playback time

Battery pack	Playback time on LCD screen	Playback time with LCD closed
NP-FM50 (supplied)	150	195
NP-FM70	310	400
NP-QM71	365	465
NP-FM90	475	600
NP-FM91/QM91	550	695

Approximate minutes when you use a fully charged battery

Step 1 Preparing the power supply

Note

Approximate recording time and playing time at 25 °C (77 °F). The battery life will be shorter if you use your camcorder in a cold environment.

If the power goes off although the battery remaining indicator indicates that the battery pack has enough power to operate

Charge the battery pack fully again so that the indication on the battery remaining indicator is correct.

Recommended charging temperature

We recommend charging the battery pack in an ambient temperature of between 10 °C to 30 °C (50 °F to 86 °F).

What is "InfoLITHIUM"?

The "InfoLITHIUM" is a lithium ion battery pack which can exchange data such as battery consumption with compatible electronic equipment. This unit is compatible with the "InfoLITHIUM" battery pack (M series). Your camcorder operates only with the "InfoLITHIUM" battery. "InfoLITHIUM" M series battery packs have the

 mark.

"InfoLITHIUM" is a trademark of Sony Corporation.

Step 1 Preparing the power supply

Connecting to a wall outlet

When you use your camcorder for a long time, we recommend that you power it from a wall outlet using the AC power adaptor.

- (1) Open the jack cover and connect the AC power adaptor supplied with your camcorder to the DC IN jack on your camcorder with the plug's ▲ mark facing the Holding Grip.
- (2) Connect the power cord to the AC power adaptor.
- (3) Connect the power cord to a wall outlet.

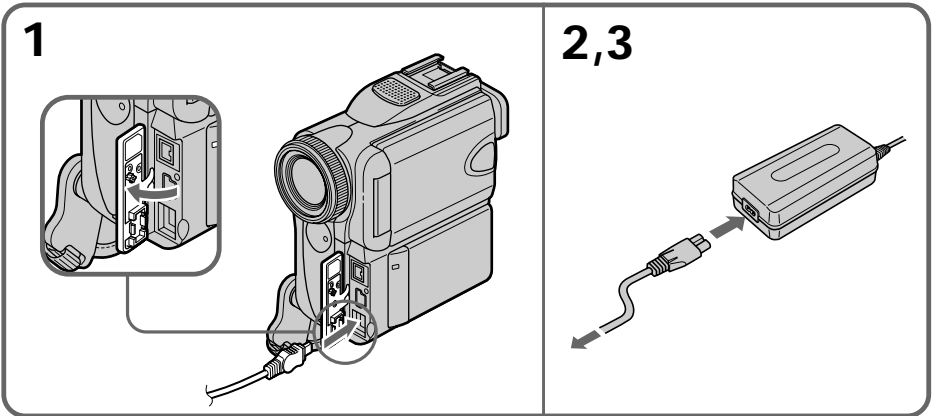

PRECAUTION

The set is not disconnected from the AC power source (house current) as long as it is connected to a wall outlet, even if the set itself has been turned off.

Notes

- The AC power adaptor can supply power even if the battery pack is attached to your camcorder.
- The DC IN jack has "source priority." This means that the battery pack cannot supply any power if the power cord is connected to the DC IN jack, even when the power cord is not plugged into a wall outlet.
- Prevent metallic objects from coming into contact with the metal parts of the DC cable of the AC power adaptor. This may cause a short-circuit, damaging the AC power adaptor.

Using a car battery

Use Sony Car Battery Adaptor (optional). Refer to the operating instructions of the Car Battery Adaptor for further information.

Step 2 Setting the date and time

Set the date and time when you use your camcorder for the first time. "CLOCK SET" will be displayed each time you set the POWER switch to CAMERA or MEMORY unless you set the date and time settings.

If you do not use your camcorder for **about three months**, the date and time settings may be released (bars may appear) because the built-in rechargeable battery installed in your camcorder will have been discharged (p. 211).

First, set the year, then the month, the day, the hour and the minute.

- (1) Set the POWER switch to CAMERA or MEMORY.
- (2) Press FN to display PAGE1 (p. 22).
- (3) Press MENU to display the menu.
- (4) Select  with ↓/↑, and press EXEC.
- (5) Select CLOCK SET with ↓/↑, and press EXEC.
- (6) Select the desired year with ↓/↑, and press EXEC.
- (7) Set the month, day and hour with the same procedure as step 6.
- (8) Set the minute with ↓/↑, and press EXEC by the time signal. The clock starts to move.

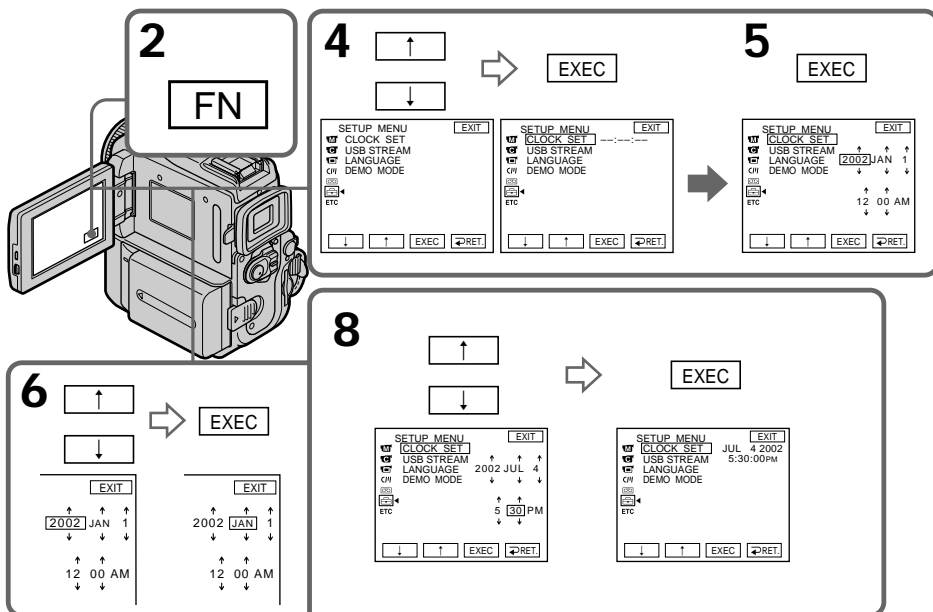

2 FN

4 EXEC

5 EXEC

6 EXEC

8 EXEC

The diagram illustrates the steps to set the date and time on the camcorder. It shows the physical camcorder and four panels of the menu system.

Panel 4: The menu is displayed with "CLOCK SET" highlighted. The user presses the EXEC button.

Panel 5: The menu is displayed with "2002 JAN 1" highlighted. The user presses the EXEC button.

Panel 6: The menu is displayed with "12 00 AM" highlighted. The user presses the EXEC button.

Panel 8: The menu is displayed with "5 30 PM" highlighted. The user presses the EXEC button.

Step 2 Setting the date and time

The year changes as follows:

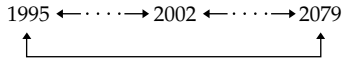

To return to FN

Press EXIT.

If you do not set the date and time

“-----” and “-:-:-:-” are recorded on the data code of the tape and the “Memory Stick”.

Note on the time indicator

The internal clock of your camcorder uses a 12-hour cycle.

- 12:00 AM stands for midnight.
- 12:00 PM stands for noon.

Step 3 Inserting a cassette

- (1) Prepare the power source.
- (2) Slide OPEN/▲EJECT▼ in the direction of the arrow and open the lid. The cassette compartment automatically lifts up and opens.
- (3) Push the middle portion of the back of the cassette to insert. Insert the cassette in a straight line deeply into the cassette compartment with the window facing out.
- (4) Close the cassette compartment by pressing the [PUSH] mark on the cassette compartment. The cassette compartment automatically goes down.
- (5) After the cassette compartment goes down completely, close the lid until it clicks.

Getting started

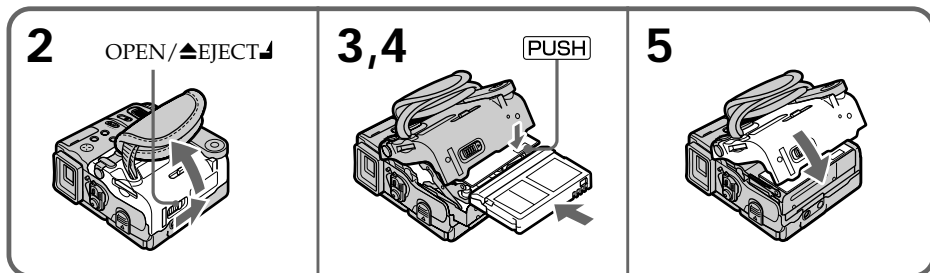

To eject a cassette

Follow the procedure above, and take out the cassette in step 3.

Notes

- Do not press the cassette compartment down. Doing so may cause malfunction.
- The cassette compartment may not be closed when you press any part of the compartment other than the [PUSH] mark.

When you use mini DV cassettes with cassette memory

Read instructions about cassette memory to use this function properly (p. 203).

To prevent accidental erasure

Slide the write-protect tab on the cassette to expose the red mark.

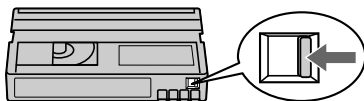

Step 4 Using the touch panel

Your camcorder has operation buttons on the LCD screen. Touch the LCD panel directly to operate each function.

- (1) Prepare the power source.
- (2) Press OPEN to open the LCD panel.
- (3) Set the POWER switch to CAMERA or VCR while pressing the small green button.
- (4) Press FN. Operation buttons appear on the LCD screen.
- (5) Press PAGE2 to go to PAGE2. Operation buttons appear on the LCD screen.
- (6) Press a desired operation item. See relevant pages of this manual for each function.

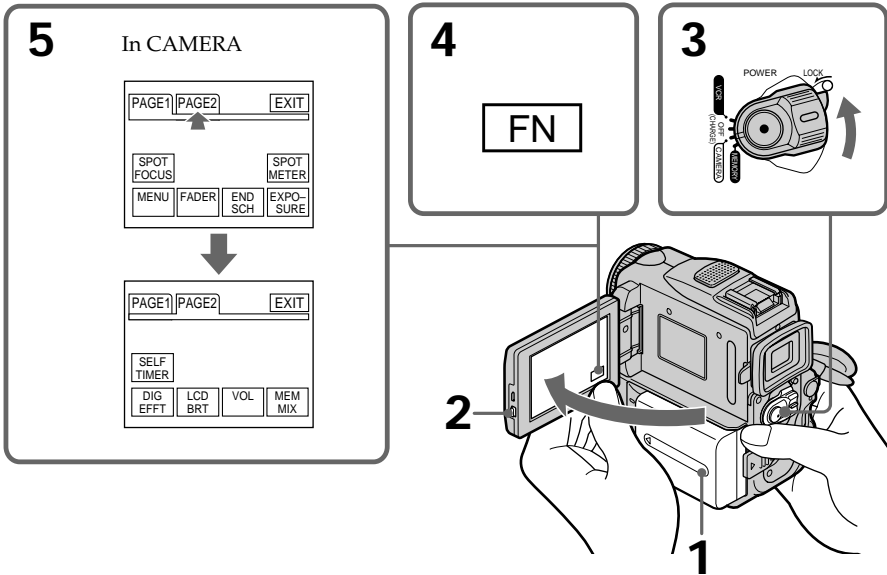

To return to FN

Press EXIT.

To execute settings

Press EXEC or  OK. The display returns to PAGE1/PAGE2/PAGE3.

To cancel settings

Press  OFF to return to PAGE1/PAGE2/PAGE3.

Step 4 Using the touch panel

Notes

- When using the touch panel, press operation buttons with your thumb supporting the LCD screen from the back side of it or press those buttons lightly with your index finger.
- Do not press operation buttons with sharp-pointed objects such as a pen.
- Do not press the LCD screen too hard.
- Do not touch the LCD screen with wet hands.
- If FN is not on the LCD screen, touch the LCD screen lightly to make it appear. You can control the display with DISPLAY/TOUCH PANEL on your camcorder.
- When operation buttons do not work even if you press them, an adjustment is required (CALIBRATION) (p. 211).
- When the LCD screen gets dirty, use the supplied cleaning cloth.

When executing each item

The green bar appears above the item.

If an item is not available

The color of the items changes to gray.

Touch panel

You can operate with the touch panel using the viewfinder (p. 70).

Press FN to display the following buttons:

CAMERA

PAGE1	SPOT FOCUS, MENU, FADER, END SCH, SPOT METER, EXPOSURE
PAGE2	SELF TIMER, DIG EFFT, LCD BRT, VOL, MEM MIX

VCR

PAGE1	MENU, LCD BRT, VOL, END SCH
PAGE2	PB ZOOM, DIG EFFT, DATA CODE
PAGE3	V SPD PLAY, A DUB CTRL, REC CTRL

See page 116 when you set the POWER switch to MEMORY .

Recording a picture

Your camcorder automatically focuses for you.

- (1) Remove the lens cap and pull the lens cap string to fix it.
- (2) Install the power source and insert a cassette. See "Step 1" to "Step 3" for more information (p. 14 to 21).
- (3) Pull down the Holding Grip. Hold your camcorder firmly as illustrated.
- (4) Set the POWER switch to CAMERA while pressing the small green button. Your camcorder is in standby.
- (5) Press OPEN to open the LCD panel. The picture appears on the LCD panel.
- (6) Press START/STOP. Your camcorder starts recording. The REC indicator appears. The camera recording lamp located on the front of your camcorder lights up. To stop recording, press START/STOP again.

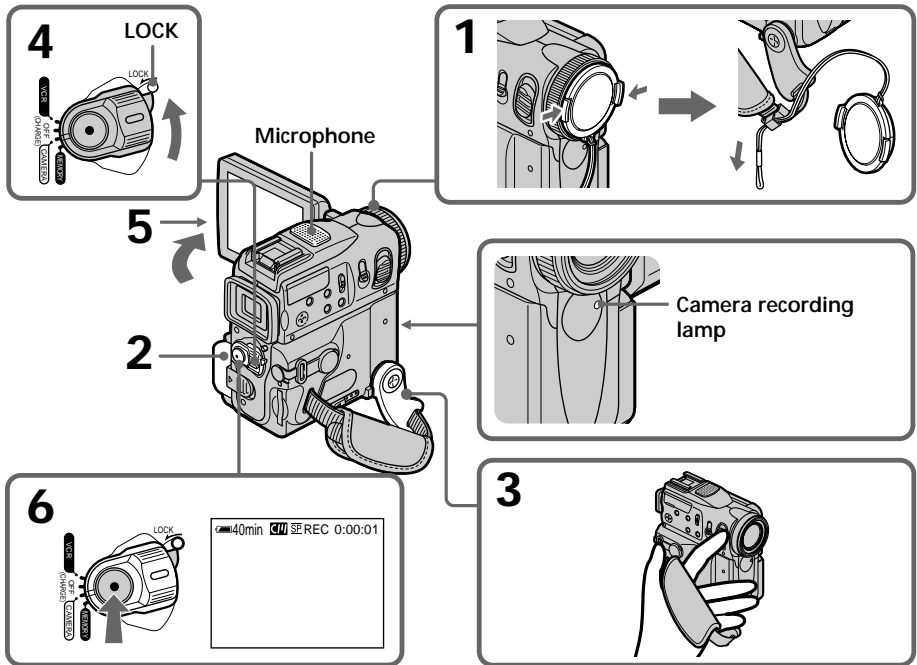

After recording

- (1) Set the POWER switch to OFF (CHARGE).
- (2) Close the LCD panel and set the Holding Grip back to the previous position.
- (3) Eject the cassette.
- (4) Remove the battery pack.

Notes

- Fasten the grip strap firmly.
- Do not touch the built-in microphone during recording.
- The recording data (date/time or various settings when recorded) are not displayed during recording. However, they are recorded automatically onto the tape. To display the recording data, press DATA CODE during playback. You can also use the Remote Commander for this operation (p. 39).

Note on Recording mode

Your camcorder records and plays back in the SP (standard play) mode and in the LP (long play) mode. Select SP or LP in the menu settings (p. 190). In the LP mode, you can record **1.5 times** as long as in the SP mode.

When you record a tape in the LP mode on your camcorder, we recommend playing the tape on your camcorder.

Note on the LOCK switch

When you slide the LOCK switch to the left, the POWER switch can no longer be set to MEMORY accidentally. The LOCK switch is set to the right as a default setting.

To enable smooth transition

Transition between the last scene you recorded and the next scene is smooth as long as you do not eject the cassette even if you turn off your camcorder.

However, check the following:

- Do not mix recordings in the SP mode and in the LP mode on one tape.
- When you change the battery pack, set the POWER switch to OFF (CHARGE).
- When you use a tape with cassette memory, you can make the transition smooth even after ejecting the cassette by using the END SEARCH function (p. 36).

If you leave your camcorder in tape recording standby for five minutes while the cassette is inserted

Your camcorder automatically turns off. This is to save battery power and to prevent battery and tape wear. To resume tape recording standby, set the POWER switch to OFF (CHARGE), and to CAMERA again. To start recording, press START/STOP again without switching the POWER switch. However, your camcorder does not turn off automatically while the cassette is not inserted.

When you record in the SP and LP modes on one tape or you record in the LP mode

- The transition between scenes is not smooth.
- The playback picture may be distorted or the time code may not be written properly between scenes.

The battery life when you record using the LCD screen

The battery time is slightly shorter than the shooting time using the viewfinder.

Recording a picture

Adjusting the LCD screen

The LCD panel moves about 90 degrees to the viewfinder side and about 180 degrees to the lens side.

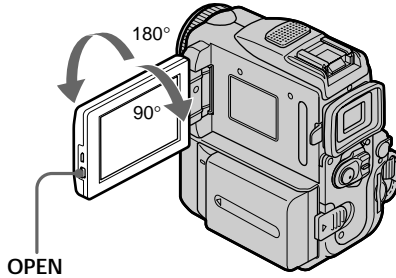

When closing the LCD panel, set it vertically, and swing it into the camcorder body.

Note

When using the LCD screen except in the mirror mode, the viewfinder automatically turns off.

When you use the LCD screen outdoors in direct sunlight

The LCD screen may be difficult to see. If this happens, we recommend that you use the viewfinder.

When you adjust the angle of the LCD panel

Make sure the LCD panel is opened up to 90 degrees.

Adjusting the brightness of the LCD screen

- (1) When you set the POWER switch to CAMERA, press FN and select PAGE2.
When you set the POWER switch to VCR, press FN to display PAGE1 (p. 22).
When you set the POWER switch to MEMORY, press FN and select PAGE3.
- (2) Press LCD BRT. The screen to adjust the brightness of the LCD screen appears.
- (3) Adjust the brightness of the LCD screen using -/+.
- : to dim
+ : to brighten
- (4) Press \rightarrow OK to return to PAGE1/PAGE2/PAGE3.

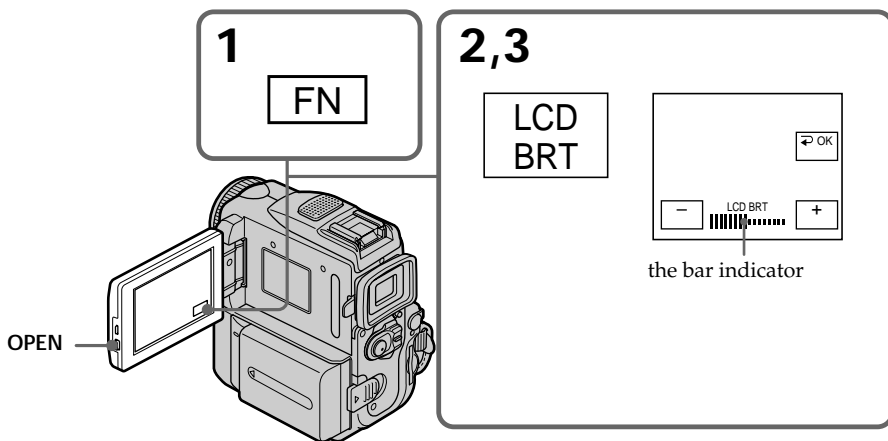

To return to FN

Press EXIT.

LCD screen backlight

You can change the brightness of the backlight. Select LCD B.L. in the menu settings when using the battery pack (p. 187).

Even if you adjust LCD BRT or LCD B.L.

The recorded picture will not be affected.

Recording a picture

Adjusting the viewfinder

If you record pictures with the LCD panel closed, check the picture with the viewfinder. Adjust the viewfinder lens to your eyesight so that the indicators in the viewfinder come into sharp focus.

Pull out the viewfinder and move the viewfinder lens adjustment lever.

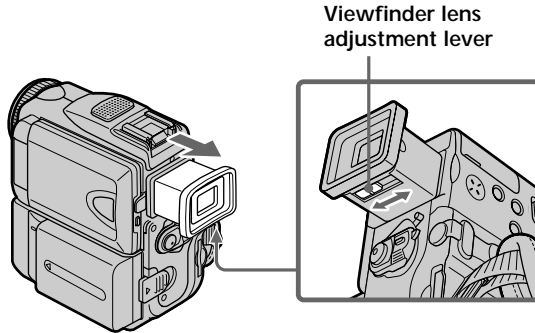

You can turn the LCD panel over and move it back to your camcorder body with the LCD screen facing out. You can operate with the touch panel using the viewfinder when the POWER switch is set to CAMERA or MEMORY (p. 70).

Viewfinder backlight

You can change the brightness of the backlight.

Select VF B.L. in the menu settings when using the battery pack (p. 187).

Even if you adjust VF B.L.

The recorded picture will not be affected.

Recording a picture

Using the zoom feature

Move the power zoom lever a little for a slower zoom. Move it further for a faster zoom. Using the zoom function sparingly results in better-looking recordings.

T: for telephoto (subject appears closer)

W: for wide-angle (subject appears further away)

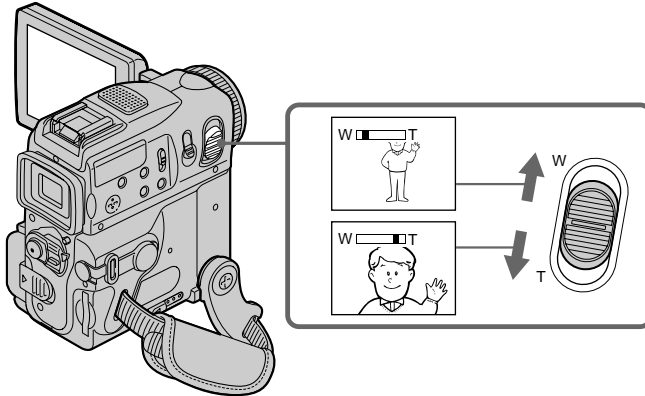

To zoom greater than 10×

Zoom greater than 10× is performed digitally. To activate the digital zoom, select the digital zoom power in D ZOOM in the menu settings. The digital zoom function is set to OFF as a default setting (p. 186).

The right side of the bar shows the digital zooming zone.
The digital zooming zone appears when you select the digital zoom power in the menu settings.

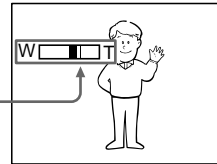

When you shoot close to a subject

If you cannot get a sharp focus, move the power zoom lever to the “W” side until the focus is sharp. You can shoot a subject that is at least about 80 cm (about 2 feet 5/8 inch) away from the lens surface in the telephoto position, or about 1 cm (about 1/2 inch) away in the wide-angle position.

Notes on digital zoom

- Digital zoom can be set to 20× or 120×.
- The picture quality deteriorates as you move the power zoom lever toward the “T” side.

When the POWER switch is set to MEMORY

You cannot use the digital zoom.

Recording a picture

Shooting with the Mirror Mode

This feature allows the camera subject to view him- or herself on the LCD screen. The subject can see his or her own image on the LCD screen while you look at the subject in the viewfinder.

Set the POWER switch to CAMERA or MEMORY.

Pull out the viewfinder and rotate the LCD screen 180 degrees.

The ☺ indicator appears in the viewfinder and on the LCD screen.

When the POWER switch is set to CAMERA, **||●** appears in standby, and **●** appears in recording. Some other indicators appear mirror-reversed and others are not displayed.

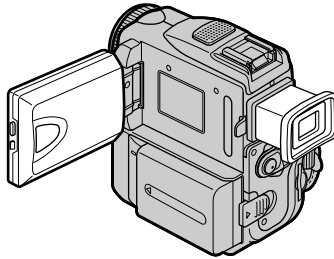

Picture in the mirror mode

The picture on the LCD screen is a mirror-image. However, the picture will be normal when recorded.

During recording in the mirror mode

- ZERO SET MEMORY on the Remote Commander does not work.
- FN appears mirror-reversed in the viewfinder.

When you press FN

The ☺ indicator does not appear on the screen.

Indicators displayed in the recording mode

The indicators are not recorded on the tape.

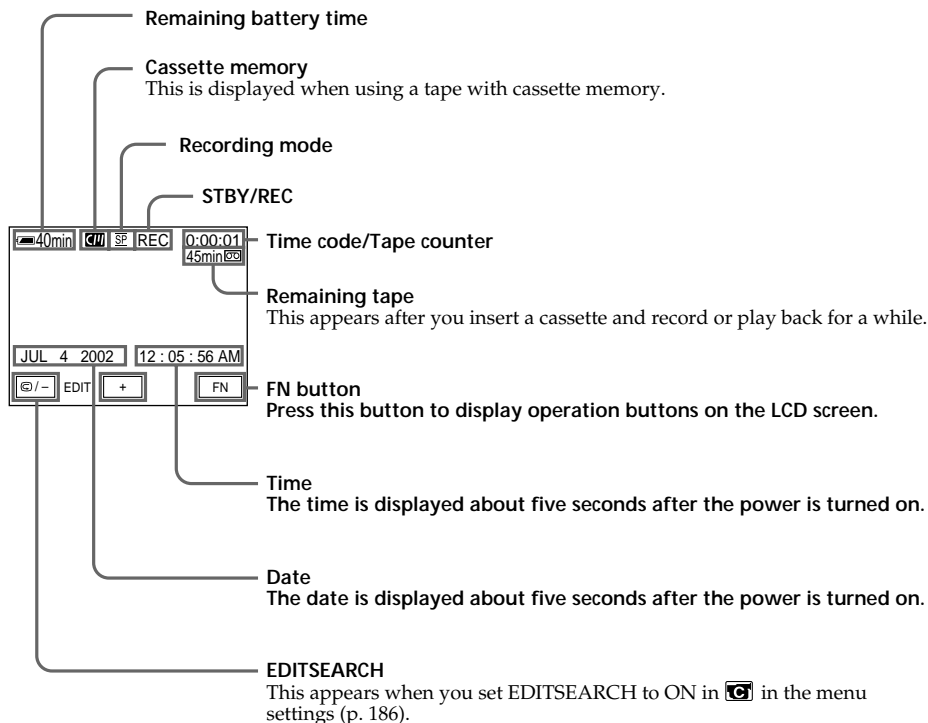

Remaining battery time indicator during recording

The remaining battery time indicator roughly indicates the continuous recording time. The indicator may not be correct, depending on the conditions in which you are recording. When you close the LCD panel and open it again, it takes about one minute for the correct remaining battery time in minutes to be displayed.

Time code

The time code indicates "0:00:00" (hours : minutes : seconds) in recording and "0:00:00:00" (hours : minutes : seconds : frames) in playback. You cannot rewrite only the time code.

Remaining tape indicator

The indicator may not be displayed accurately depending on the tape.

Recording data

The recording data (date/time or various settings when recorded) are not displayed during recording. However, they are recorded automatically on the tape. To display the recording data, press DATA CODE during playback. You can also use the Remote Commander for this operation (p. 39).

Recording a picture

Shooting a backlit subject – BACK LIGHT

When you shoot a subject with the light source behind the subject or a subject with a light background, use the backlight function.

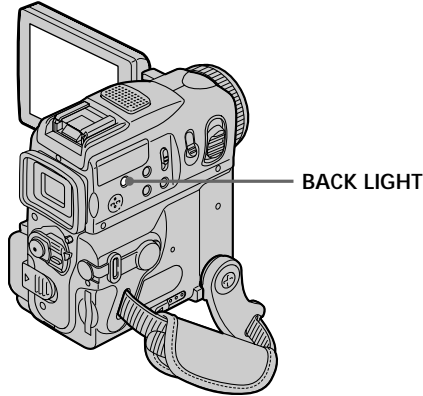

Set the POWER switch to CAMERA or MEMORY, then press BACK LIGHT. The  indicator appears on the screen. To cancel, press BACK LIGHT again.

During back light function

The backlight function will be canceled when you press MANUAL (p. 63) in EXPOSURE or SPOT METER (p. 64).

Shooting in the dark – NightShot/Super NightShot/Color Slow Shutter

NightShot enables you to shoot a subject in a dark place. For example, you can satisfactorily record the environment of nocturnal animals for observation when you use this function.

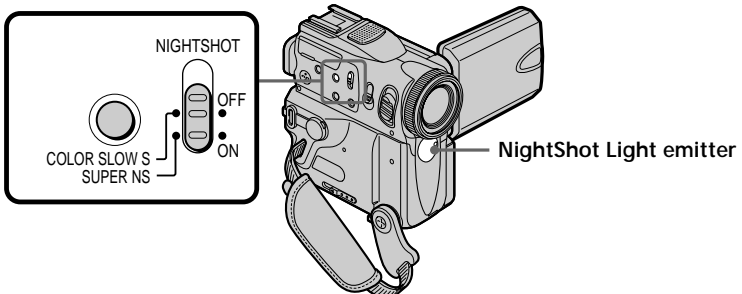

Using NightShot

Set the POWER switch to CAMERA or MEMORY, then slide NIGHTSHOT to ON. The  indicator and “NIGHTSHOT” flash on the screen. To cancel NightShot, slide NIGHTSHOT to OFF.

Notes



- Do not use the NightShot function in bright places (e.g. outdoors in the daytime). This may cause your camcorder to malfunction.
- When you keep NIGHTSHOT set to ON in normal recording, the picture may be recorded in incorrect or unnatural colors.
- If focusing is difficult when using the NightShot function, focus manually.
- Do not cover the NightShot Light emitter when using the NightShot function.

While using NightShot, you cannot use the following functions:

- Exposure
- Flexible Spot Meter
- PROGRAM AE (The indicator flashes.)
- White balance

Using Super NightShot

Super NightShot makes subjects more than 16 times brighter than those recorded in NightShot.

- (1) Set the POWER switch to CAMERA, then slide NIGHTSHOT to ON. The  indicator and “NIGHTSHOT” flash on the screen.
- (2) Press SUPER NS. The  indicator and “SUPER NIGHTSHOT” flash on the screen.
To cancel Super NightShot, press SUPER NS again.

While using Super NightShot

The shutter speed will be automatically adjusted depending on the brightness of the background. The motion of the moving picture may slow down.

While using Super NightShot, you cannot use the following functions:

- Fader
- Exposure
- Digital effect
- PROGRAM AE
- Recording on a “Memory Stick” in tape recording or tape recording standby
- White balance
- Flexible Spot Meter

When the POWER switch is set to MEMORY

You cannot use Super NightShot function.

Recording a picture

Using the NightShot Light

The picture will be clearer with the NightShot Light on. To activate NightShot Light, set N.S.LIGHT to ON in the menu settings (p. 185).
(The default setting is ON.)

NightShot Light

NightShot Light rays are infrared and so are invisible. The maximum shooting distance using the NightShot Light is about 3 m (10 feet).

Using Color Slow Shutter

Color Slow Shutter enables you to record color images in a dark place.

- (1) Set the POWER switch to CAMERA, slide NIGHTSHOT to OFF.
- (2) Press COLOR SLOW S.

The [2] indicator and COLOR SLOW SHUTTER flash on the screen.

To cancel the Color Slow Shutter function, press COLOR SLOW S again.

While using Color Slow Shutter

The shutter speed will be automatically adjusted depending on the brightness of the background. The motion of the moving picture may slow down.

When the POWER switch is set to MEMORY

You cannot use Color Slow Shutter function.

While using the Color Slow Shutter function, you cannot use the following functions:

- Fader
- Exposure
- Digital effect
- PROGRAM AE
- Recording on a "Memory Stick" in tape recording or tape recording standby
- Flexible Spot Meter

In total darkness

Color Slow Shutter may not work properly.

Self-timer recording

Recording automatically starts in 10 seconds after you set the self-timer. You can also use the Remote Commander for this operation.

- (1) In standby, press FN and select PAGE2 (p. 22).
- (2) Press SELFTIMER.

The  (self-timer) indicator appears on the screen.

- (3) Press START/STOP.

The self-timer starts counting down from 10 with a beep sound. In the last two seconds of the countdown, the beep sound gets faster, then recording starts automatically.

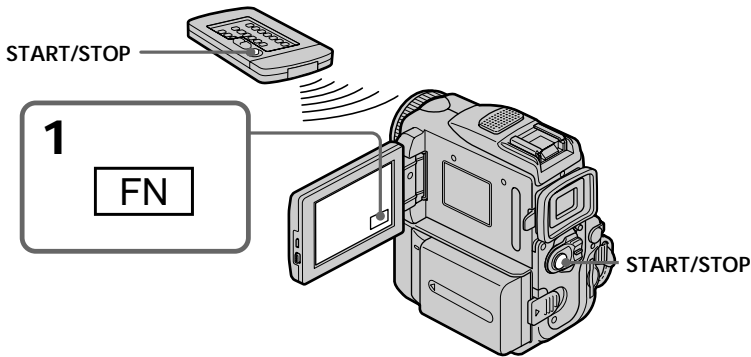

To stop the count down

Press START/STOP.

To restart the countdown, press START/STOP again.

To cancel self-timer recording

Press SELFTIMER so that the  (self-timer) indicator disappears from the screen while your camcorder is in standby. You cannot cancel self-timer recording using the Remote Commander.

Note

Self-timer recording is automatically canceled when:

- Self-timer recording is finished.
- The POWER switch is set to OFF (CHARGE) or VCR.

When the POWER switch is set to MEMORY

You can also record images with the self-timer (p. 126, 138).

Checking the recording

- END SEARCH/EDITSEARCH/Rec Review

You can use these buttons to check the recorded picture or shot so that the transition between the last recorded scene and the next scene you record is smooth.

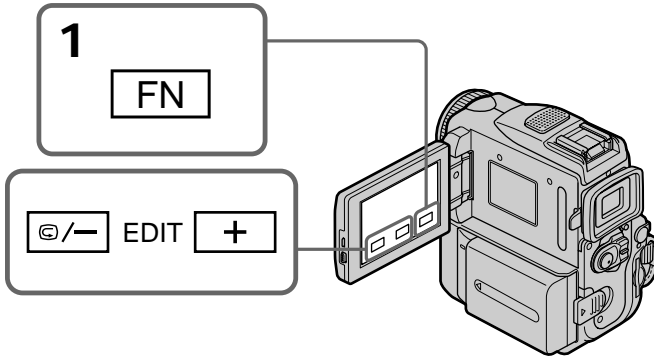

END SEARCH

You can go to the end of the recorded section after you record.

- (1) In standby, press FN to display PAGE1 (p. 22).
- (2) Press END SCH.

The last five seconds of the recorded section are played back and your camcorder returns to standby. You can monitor the sound from the speaker or headphones.

To return to FN

Press EXIT.

To stop searching

Press END SCH again.

END SEARCH function



When you use a tape without cassette memory, END SEARCH does not work once you eject the cassette after you have recorded on the tape. If you use a tape with cassette memory, END SEARCH works even after you eject the cassette.



If a tape has a blank portion in the recorded sections

END SEARCH may not work correctly.

EDITSEARCH



You can search for the next recording start point.

- (1) In standby, press FN to display PAGE1 (p. 22).
- (2) Press MENU, then set EDITSEARCH to ON in  (p. 186).
- (3) Hold down the  / - · + side of EDIT. The recorded section is played back.
 - + : to go forward
 -  / - : to go backward

Release  / - · + to stop playback. If you press START/STOP, re-recording begins from the point you released  / - · +. You cannot monitor the sound.

Rec Review



You can check the last recorded section.

- (1) In standby, press FN to display PAGE1 (p. 22).
- (2) Press MENU, then set EDITSEARCH to ON in  (p. 186).
- (3) Press the  / - side of EDIT momentarily .

The section you have stopped most recently will be played back for a few seconds, and then your camcorder will return to standby. You can monitor the sound from the speaker or headphones.

Playing back a tape

You can monitor the recorded tape etc. on the LCD screen. If you close the LCD panel, you can monitor the playback picture in the viewfinder. You can also control playback using the Remote Commander supplied with your camcorder.

- (1) Prepare the power source and insert the recorded tape.
- (2) Set the POWER switch to VCR while pressing the small green button.
- (3) Press OPEN to open the LCD panel.
- (4) Press  to rewind the tape.
- (5) Press  to start playback.
- (6) Adjust the volume following the steps below.
 - ① Press FN to display PAGE1.
 - ② Press VOL. The screen to adjust volume appears.
 - ③ Press -/+ to adjust the volume.
 - : to decrease the volume
 - + : to increase the volume
- (7) Press  OK to return to PAGE1.

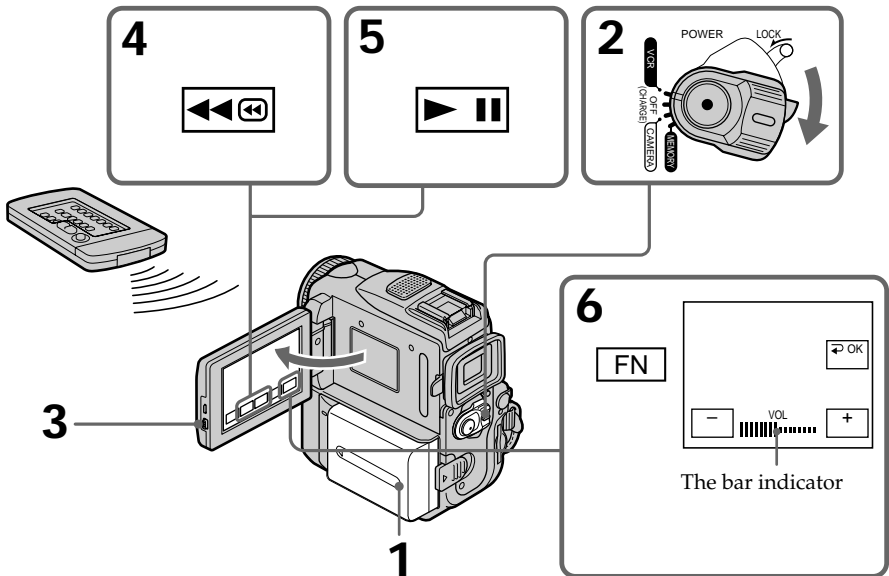

To return to FN

Press EXIT.

To stop playback

Press .

Playing back a tape

When monitoring on the LCD screen

You can turn the LCD panel over and move it back to the camcorder body with the LCD screen facing out.

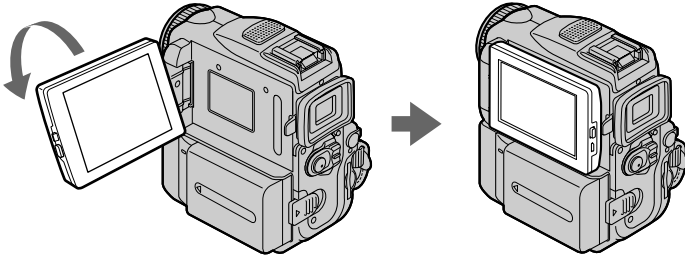

If you leave the power on for a long time

Your camcorder gets warm. This is not a malfunction.

When you open or close the LCD panel

Make sure that the LCD panel is set vertically.

To display the screen indicators - Display function

Press DISPLAY/TOUCH PANEL on your camcorder or DISPLAY on the Remote Commander supplied with your camcorder.

The indicators disappear from the screen.

To make the indicators appear, press DISPLAY/TOUCH PANEL or DISPLAY again.

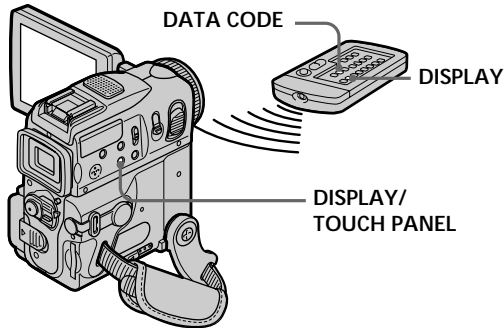

About date/time and various settings

Your camcorder automatically records not only images on the tape but also the recording data (date/time or various settings when recorded) (**Data code**).

Follow the steps on the next page to display the data code using the touch panel or the Remote Commander.

Playing back a tape

Using the touch panel

- (1) In playback, press FN and select PAGE2 (p. 22).
- (2) Press DATA CODE.

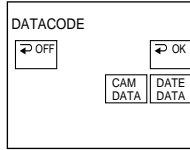

- (3) Select CAM DATA or DATE DATA, then press ↵ OK.

- (4) Press EXIT.

Using the Remote Commander

Press the DATA CODE button on the Remote Commander in playback.

The display changes as follows:

date/time → various settings (SteadyShot OFF, exposure, white balance, gain, shutter speed, aperture value) → no indicator

Not to display various settings

Set DATA CODE to DATE in the menu settings (p. 192).

The display changes as follows when you press the DATA CODE button on the Remote Commander: date/time ↔ no indicator

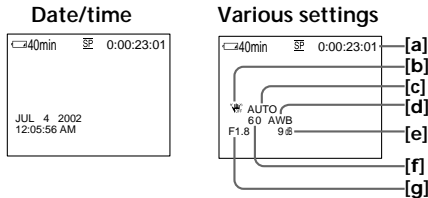

- [a]: Tape counter
- [b]: SteadyShot OFF
- [c]: Exposure mode
- [d]: White balance
- [e]: Gain
- [f]: Shutter speed
- [g]: Aperture value

Various settings

Various settings shows the camcorder's recording information at the time of recording. In tape recording standby, the various settings will not be displayed.

When you use the data code function, bars (-- --) appear if:

- A blank portion of the tape is being played back.
- The tape is unreadable due to tape damage or noise.
- The tape was recorded by a camcorder without the date and time set.

Data code

When you connect your camcorder to a TV, the data code also appears on the TV screen.

Playing back a tape

Remaining battery time indicator during playback

The indicator indicates the approximate continuous playback time. The indicator may not be correct, depending on the conditions in which you are playing back. When you close the LCD panel and open it again, it takes about one minute for the correct remaining battery time to be displayed.



Various playback modes

To operate video control buttons, set the POWER switch to VCR.



When using the touch panel

- (1) Press FN and select PAGE3.
- (2) Press V SPD PLAY to display video control buttons.



To view a still image (playback pause)

Press  during playback. To resume playback, press  again.



To fastforward the tape

Press  during playback stop. To resume normal playback, press .



To rewind the tape

Press  during playback stop. To resume normal playback, press .



To change the playback direction

Press  during playback to reverse the playback direction. Press  to pause playback. Press  to resume normal playback.







To locate a scene while monitoring the picture (picture search)

Keep pressing  or  during playback. To resume normal playback, release the button.







To monitor the high-speed picture while fastforwarding or rewinding the tape (skip scan)

Keep pressing  while fastforwarding or  while rewinding the tape. To resume fastforwarding or rewinding, release the button.





To view the picture at slow speed (slow playback)

Press  during playback. For slow playback in the reverse direction, press  / , then press . Press  to pause playback. Press  to resume normal playback.

To view the picture at double speed

Press  during playback. For double speed playback in the reverse direction, press  / , then press . Press  to pause playback. Press  to resume normal playback.

To view the picture frame-by-frame

Press  in playback pause. For frame-by-frame playback in the reverse direction, press  / . To resume normal playback, press .

To search the last scene recorded (END SEARCH)









Press END SCH on PAGE1 in the stop mode. The last five seconds of the recorded section are played back then the camcorder stop.

Playing back a tape









Video control buttons

Marks on your camcorder are different from those on the Remote Commander supplied with your camcorder.

Your camcorder:

-  To play back or pause a tape
-  To stop a tape
-  To rewind a tape
-  To fastforward a tape
-  To play back a tape slowly
-  To forward one frame at a time
-  To rewind one frame at a time
-  To play back a tape at double speed

Remote Commander:

-  To play back a tape
-  To pause a tape
-  To rewind a tape
-  To fastforward a tape
-  To play back a tape slowly
-  To forward one frame at a time
-  To rewind one frame at a time
-  To play back a tape at double speed

In the various playback modes

- Sound is muted.
- The previous picture may remain as a mosaic image during playback.

When playback pause lasts for five minutes

Your camcorder automatically enters the stop mode. To resume playback, press

 / .

Slow playback

Slow playback can be performed smoothly on your camcorder. However, this function does not work for an output signal from the  DV Interface.

When you play back a tape in reverse

Horizontal noise may appear at the center, or the top and bottom of the screen. This is not a malfunction.

Viewing the recording on TV

Connect your camcorder to your TV with the A/V connecting cable supplied with your camcorder to watch the playback pictures on the TV screen. You can operate the playback control buttons in the same way as when you view playback pictures on the LCD screen. When viewing the playback picture on the TV screen, we recommend that you power your camcorder from a wall outlet using the AC power adaptor (p. 18). Refer to the operating instructions of your TV.

Open the jack cover. Connect your camcorder to the TV with the A/V connecting cable. Then, set the TV/VCR selector on the TV to VCR.

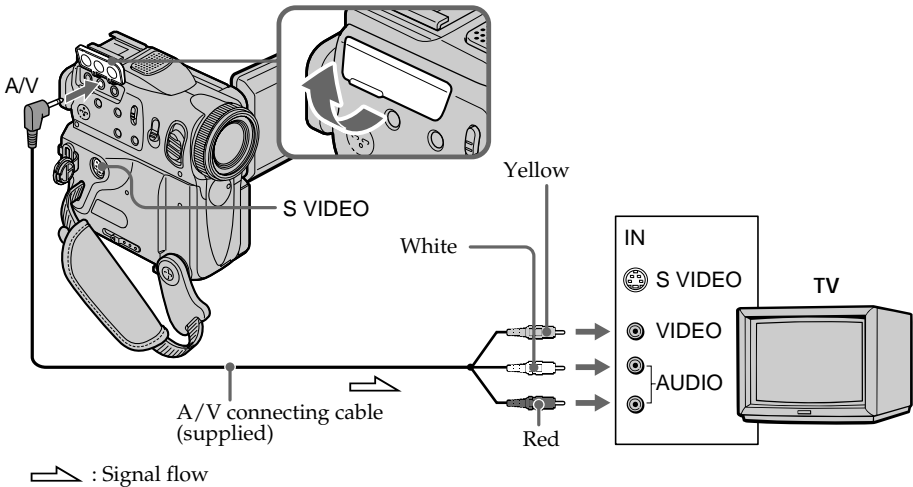

If your TV is already connected to the VCR

Connect your camcorder to the LINE IN input on the VCR with the A/V connecting cable supplied with your camcorder. Set the input selector on the VCR to LINE.

If your TV or VCR is a monaural type

Connect the yellow plug of the A/V connecting cable to the video input jack and the white or the red plug to the audio input jack on the VCR or the TV. If you connect the white plug, the sound is L (left) signal. If you connect the red plug, the sound is R (right) signal.

If your TV has an S video jack

Pictures can be reproduced more faithfully by using an S video cable (optional). With this connection, you do not need to connect the yellow (video) plug of the A/V connecting cable.

Connect the S video cable (optional) to the S video jacks on both your camcorder and the TV or the VCR.

This connection produces higher quality DV format pictures.

To display the screen indicators on TV

Set DISPLAY to V-OUT/LCD in the menu settings (p. 192).

Then press DISPLAY/TOUCH PANEL on your camcorder. To turn off the screen indicators, press DISPLAY/TOUCH PANEL on your camcorder again.

Recording still images on a “Memory Stick” during recording on a tape

You can record still images on a “Memory Stick” in tape recording or tape recording standby.

You can also record still images on a tape (p. 47).

Before operation

- Insert a “Memory Stick” into your camcorder.
- Set PHOTO REC to MEMORY in the menu settings. (The default setting is MEMORY.)

- (1) In standby, keep pressing PHOTO lightly until a still image appears. The CAPTURE indicator appears. Recording does not start yet. To change the still image, release PHOTO, select a still image again, and then press and hold PHOTO lightly.
- (2) Press PHOTO deeper.
Recording is complete when the bar scroll indicator disappears.
The image displayed on the screen when you pressed PHOTO deeper will be recorded on the “Memory Stick.”

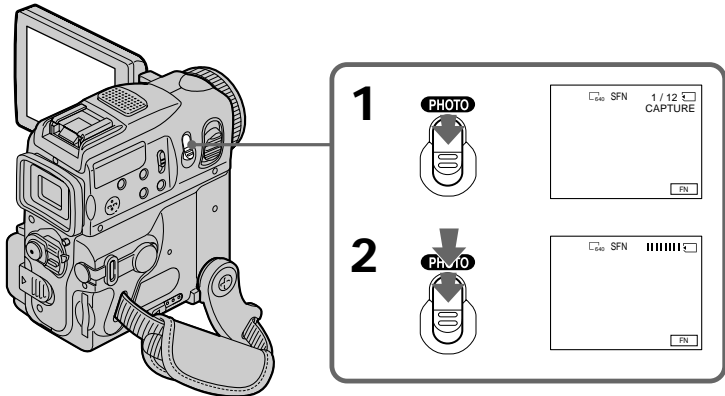

Notes

- Do not shake or strike your camcorder when you record still images.
The image may fluctuate.
- You cannot record still images on a “Memory Stick” during following operations:
 - Wide mode
 - Fader
 - Picture effect
 - Digital effect
 - Super NightShot
 - Color Slow Shutter
 - END SEARCH
 - EDITSEARCH
 - MEMORY MIX

Recording still images on a “Memory Stick” during recording on a tape

“Memory Stick”

For details, see page 113 for more information.

Image size of still images

Image size is automatically set to 640 × 480.

When you want to record still images in different sizes, use the Memory Photo recording function (p. 122).

When the POWER switch is set to CAMERA

You cannot select image quality.

The image quality you selected when the POWER switch was set to MEMORY is used. (The default setting is SUPER FINE.)

During and after recording still images on a “Memory Stick”

Your camcorder continues recording on tape.

When you press PHOTO on the Remote Commander

Your camcorder immediately records the image that is on the screen when you press the button.

To record still images on a “Memory Stick” during tape recording

You cannot check an image on the screen by pressing PHOTO lightly. The image when you press PHOTO will be recorded on the “Memory Stick.”

To record images with higher quality

We recommend you use the Memory Photo recording function (p. 122).

Title

You cannot record a title.

Recording still images on a “Memory Stick” during recording on a tape

Self-timer memory photo recording

You can record still images on a “Memory Stick” with the self-timer. You can also use the Remote Commander for this operation.

Before operation

- Insert a “Memory Stick” into your camcorder.
- Set PHOTO REC to MEMORY in the menu settings. (The default setting is MEMORY.)

(1) In standby, press FN and select PAGE2.

(2) Press SELFTIMER.

The  (self-timer) indicator appears on the screen.

(3) Press PHOTO deeper.

The self-timer starts counting down from 10 with a beep. In the last two seconds of the countdown, the beep gets faster, then the recording starts automatically.

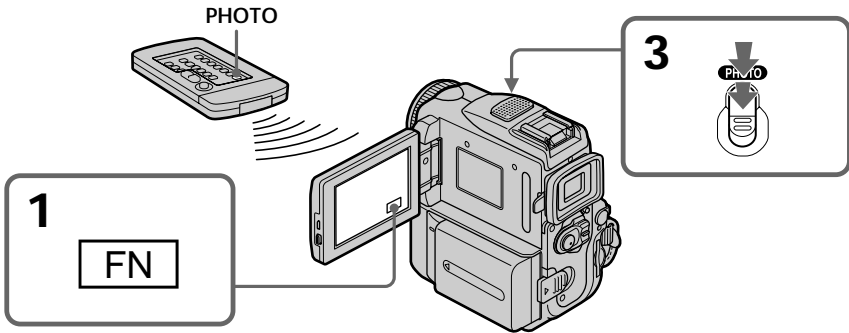

To cancel self-timer recording

Press SELFTIMER so that the  (self-timer) indicator disappears from the screen while your camcorder is in standby. You cannot cancel self-timer recording using the Remote Commander.

Note

Self-timer recording is automatically canceled when:

- Self-timer recording is finished.
- The POWER switch is set to OFF (CHARGE) or VCR.

During tape recording

You cannot use self-timer recording.

Recording a still image on a tape

- Tape Photo recording

You can record still images such as photographs. You can record about 510 images in the SP mode and about 765 images in the LP mode on a 60-minute tape. You can also record still images on a "Memory Stick" (p. 44, 122).

- (1) In standby, press FN to display PAGE1.
- (2) Press MENU, then set PHOTO REC to TAPE in  (p. 186).
- (3) Keep pressing PHOTO lightly until a still image appears. The CAPTURE indicator appears. Recording does not start yet.
To change the still image, release PHOTO, select a still image again, and then press and hold PHOTO lightly.
- (4) Press PHOTO deeper.

The still image displayed on the screen when you pressed PHOTO deeper is recorded for about seven seconds. The sound during those seven seconds is also recorded.

The still image is displayed on the screen until the recording is completed.

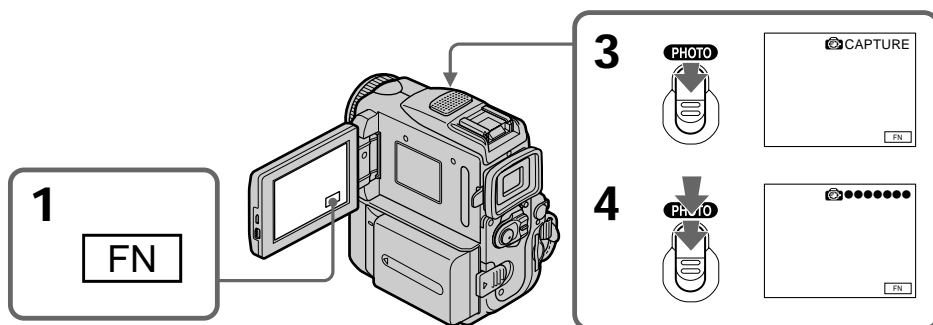

Recording images with self-timer

- (1) Set PHOTO REC to TAPE in  in the menu settings (p. 186).
- (2) Follow steps 1 to 3 on page 46.

Notes

- During tape photo recording, you cannot change the mode or setting.
- When recording a still image, do not shake your camcorder. The image may fluctuate.
- The tape photo recording function does not work during following operations:
 - Fader
 - Digital effect

Recording a still image on a tape – Tape Photo recording

If you record a moving subject with the tape photo recording function

When you play back the still image on other equipment, the image may fluctuate.

When you press PHOTO on the Remote Commander

Your camcorder immediately records the image that is on the screen when you press the button.

To record still images on a tape during tape recording

You cannot check an image on the screen by pressing PHOTO lightly. Press PHOTO deeper. The still image is recorded for about seven seconds and your camcorder returns to tape recording standby.

To record clear and less fluctuated still images

We recommend that you record on “Memory Stick”s.

Adjusting the white balance manually

You can manually adjust and set the white balance. This adjustment makes white subjects look white and allows more natural color balance. Normally white balance is automatically adjusted.

- (1) Set the POWER switch to CAMERA or MEMORY, then press FN to display PAGE1.
- (2) Press MENU, then set WHT BAL to the desired mode in  (p. 185).

HOLD:

Recording a single-colored subject or background

(OUTDOOR):

- Recording a sunset/sunrise, just after sunset, just before sunrise, neon signs, or fireworks
- Under a color matching fluorescent lamp

(INDOOR):

- When lighting conditions change quickly
- In too bright places such as photography studios
- Under sodium lamps or mercury lamps

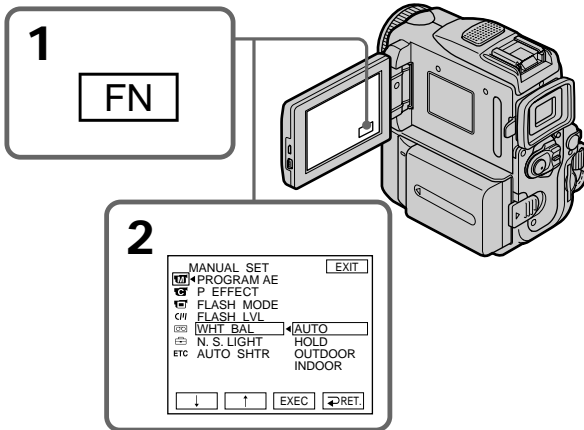

To return to FN

Press EXIT.

To return to the automatic white balance mode

Set WHT BAL to AUTO in the menu settings.

Adjusting the white balance manually

If the picture is being taken in a studio lit by TV lighting

We recommend that you record in the  INDOOR mode.

When you record under fluorescent lighting

Use the AUTO or HOLD mode.

Your camcorder may not adjust the white balance correctly in the  INDOOR mode.

In the automatic white balance mode

Point your camcorder at the white subject for about 10 seconds after setting the POWER switch to CAMERA to get better adjustment when:

- You detach the battery for replacement.
- You bring your camcorder from indoors to outdoors holding the exposure, or vice versa.

In HOLD

Set the white balance to AUTO and reset to HOLD after few seconds when:

- You change the PROGRAM AE mode.
- You bring your camcorder from indoors to outdoors, or vice versa.

Using the wide mode

You can record a 16:9 wide picture to watch on the 16:9 wide-screen TV (16:9WIDE). Black bands appear on the screen during recording in 16:9WIDE mode [a]. The picture during playing back on a normal TV [b] or a wide-screen TV [c] are compressed in the widthwise direction. If you set the screen mode of the wide-screen TV to the full mode, you can watch pictures of normal images [d].

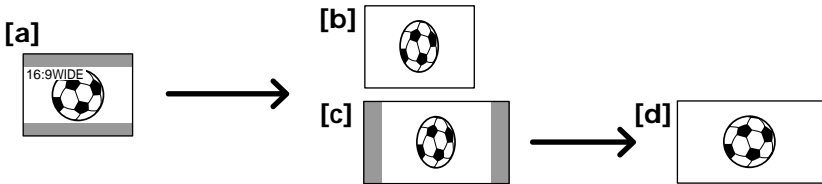

- (1) In standby, press FN to display PAGE1.
- (2) Press MENU, then set 16:9WIDE to ON in  (p. 186).

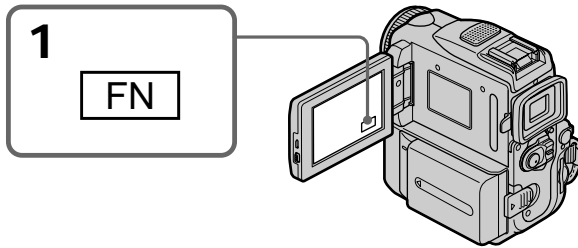

To return to FN

Press EXIT.

To cancel the wide mode

Set 16:9WIDE to OFF in the menu settings.

In the wide mode, you cannot select the following functions:

- Recording still images on a "Memory Stick" in tape recording or tape recording standby
- OLD MOVIE
- BOUNCE

During recording

You cannot select or cancel the wide mode. When you cancel the wide mode, set your camcorder to tape recording standby and then set 16:9WIDE to OFF in the menu settings.

Using the wide mode

Connection for a TV

Pictures recorded in the 16:9WIDE mode automatically appear on the TV screen at full size when:

- You connect your camcorder to a TV that is compatible with the video ID (ID-1/ID-2) system.
- You connect your camcorder to the S video jack on the TV.

ID-1 system

The ID-1 system sends aspect ratio information (16:9, 4:3, or letter box) with video signals. If you connect a TV compatible with the ID-1 system, the screen size is automatically selected.

ID-2 system

The ID-2 system sends a copyright protection signal with ID-1 signals inserted between video signals when you connect your camcorder to other equipment using the A/V connecting cable.

Using the fader function

You can fade in or out to give your recording a professional appearance.

[a] STBY REC

NORM. FADER
(normal)

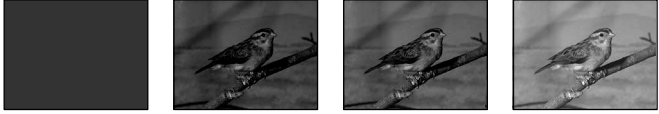

MOSC.FADER
(mosaic)



BOUNCE^{1) 2)}



OVERLAP²⁾



WIPE²⁾

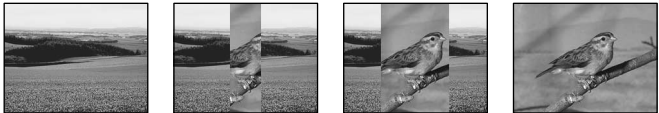

DOT²⁾

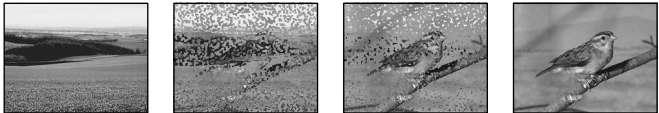

[b] STBY REC

MONOTONE

When fading in, the picture gradually changes from black-and-white to color.
When fading out the picture gradually changes from color to black-and-white.

¹⁾ You can use BOUNCE when D ZOOM is set to OFF in the menu settings.

²⁾ Fade in only.

Using the fader function

- (1) To fade in [a]
In standby, press FN to display PAGE1.
To fade out [b]
In recording, press FN to display PAGE1.
- (2) Press FADER. The screen to select the fader mode appears.
- (3) Select a desired mode.
- (4) Press \rightarrow OK to return to PAGE1, and press EXIT to return to FN.
The fader indicator you selected flashes.
- (5) Press START/STOP. After the fade in/out is carried out, your camcorder automatically returns to the normal mode.

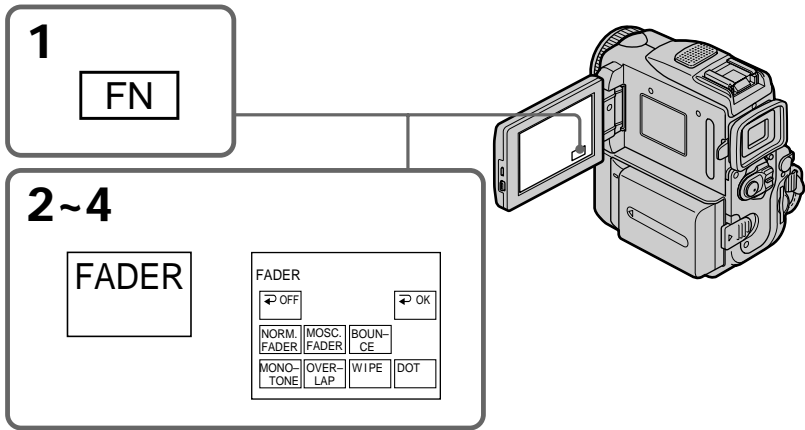

To cancel the fader function

Before pressing START/STOP, press \rightarrow OFF to return to PAGE1 and press EXIT to return to FN.

Note

You cannot use the following functions while using the fader function. Also, you cannot use the fader function while using the following functions:

- Digital effect
- Super NightShot
- Color Slow Shutter
- Tape photo recording
- Recording on a "Memory Stick" in tape recording or tape recording standby
- Interval recording
- Frame recording

When you select OVERLAP, WIPE or DOT

Your camcorder automatically stores the image stored on a tape. As the image is being stored, the playback picture disappears. At this stage, the picture may not be recorded clearly, depending on the tape condition.

Using the fader function

While using **BOUNCE**, you cannot use the following functions:

- Exposure
- Flexible Spot Meter
- Focus
- Zoom
- Picture effect

Note on BOUNCE

You cannot select **BOUNCE** in the following mode or functions:

- **D ZOOM** is activated in the menu settings
- Wide mode
- Picture effect
- **PROGRAM AE**

During MPEG movie recording

You cannot use the fader function.

Using special effects – Picture effect

You can digitally process images to obtain special effects like those in movies or on the TV.

NEG. ART [a] : The color and brightness of the picture are reversed.

SEPIA : The picture is sepia.

B&W : The picture is monochrome (black-and-white).

SOLARIZE [b] : The light intensity is clearer, and the picture looks like an illustration.

PASTEL [c] : The contrast of the picture is emphasized, and the picture looks like an animated cartoon.

MOSAIC [d] : The picture is mosaic.

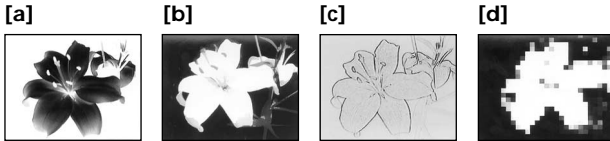

(1) Set the POWER switch to CAMERA, then press FN to display PAGE1.

(2) Press MENU, then set P EFFECT to the desired mode in  (p. 185).

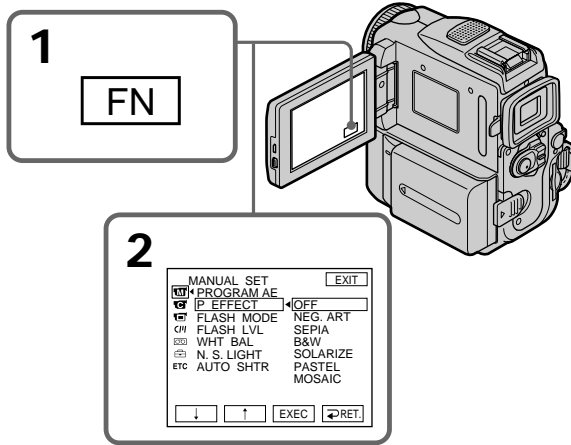

To return to FN

Press EXIT.

To cancel the picture effect function

Select OFF in P EFFECT in the menu settings.

While using the picture effect function, you cannot use following functions:

- OLD MOVIE
- BOUNCE
- Recording on a “Memory Stick” in tape recording or tape recording standby

When you change the POWER switch to other than CAMERA

The picture effect is automatically canceled.

Using special effects – Digital effect

You can add special effects to recorded pictures using the various digital functions. The sound is recorded normally.

STILL

You can record a still image so that it is superimposed on a moving picture.

FLASH (FLASH MOTION)

You can record still images successively at regular intervals.

LUMI. (LUMINANCEKEY)

You can swap the brighter area in a still image with a moving picture.

TRAIL

You can record a picture so that an incidental image like a trail is left.

SLOW SHTR (SLOW SHUTTER)

You can slow down the shutter speed. The slow shutter mode is good for recording dark pictures more brightly.

OLD MOVIE

You can add an old movie type atmosphere to pictures. Your camcorder automatically sets the wide mode to ON, the picture effect to SEPIA, and the appropriate shutter speed.

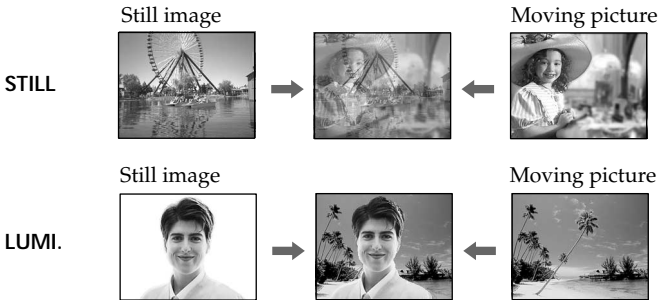

Using special effects – Digital effect

- (1) Set the POWER switch to CAMERA, then press FN and select PAGE2.
- (2) Press DIG EFFT. The screen to select a desired digital effect mode appears.
- (3) Press a desired digital effect mode. In STILL and LUMI., the still image is stored in memory.
- (4) Press -/+ to adjust the effect.

Items to adjust

STILL	The rate of the still image you want to superimpose on the moving picture
FLASH	The interval of flash motion
LUMI.	The color scheme of the area in the still image which is to be swapped with a moving picture
TRAIL	The vanishing time of the incidental image
SLOW SHTR	Shutter speed. The larger the shutter speed number, the slower the shutter speed.
OLD MOVIE	No adjustment necessary

- (5) Press ↻ OK to return to PAGE2.

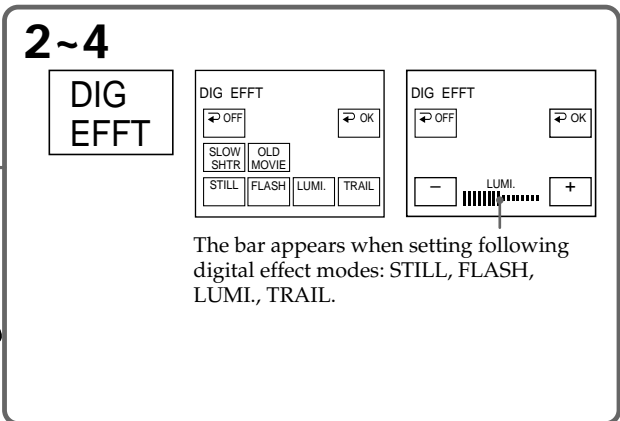
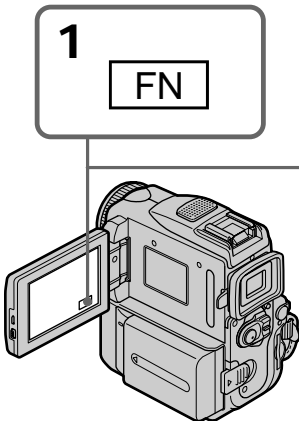

To return to FN

Press EXIT.

To cancel the digital effect

Press ↻ OFF to return to PAGE2.

Using special effects – Digital effect

Notes

- The following functions do not work during digital effect:
 - Fader
 - Tape photo recording
 - Super NightShot
 - Color Slow Shutter
 - Recording on a “Memory Stick” in tape recording or tape recording standby
- The PROGRAM AE function does not work in SLOW SHTR.
- The following functions do not work in OLD MOVIE:
 - Wide mode
 - Picture effect
 - PROGRAM AE

When you change the POWER switch to other than CAMERA

The digital effect will be automatically canceled.

When recording in the slow shutter mode

Auto focus may not be effective. Focus manually using a tripod.

Shutter speed

Shutter speed number	Shutter speed
SLOW SHTR 1	1/30
SLOW SHTR 2	1/15
SLOW SHTR 3	1/8
SLOW SHTR 4	1/4

Using the PROGRAM AE

You can select PROGRAM AE (Auto Exposure) mode to suit your specific shooting requirements.

SPOTLIGHT (Spotlight)

This mode prevents people's faces, for example, from appearing excessively white when shooting subjects lit by strong light in the theater.

PORTRAIT (Soft portrait)

This mode brings out the subject while creating a soft background for subjects such as people or flowers.

SPORTS (Sports lesson)

This mode minimizes shake on fast-moving subjects such as in tennis or golf.

BEACH&SKI (Beach & ski)

This mode prevents people's faces from appearing dark in strong light or reflected light, such as at a beach in midsummer or on a ski slope.

SUNSETMOON (Sunset & moon)

This mode allows you to maintain atmosphere when you are recording sunsets, general night views, fireworks displays and neon signs.

LANDSCAPE (Landscape)

This mode is for when you record distant subjects such as mountains. Also it prevents your camcorder from focusing on glass or metal mesh in windows when you record a subject behind glass or a screen.



Using the PROGRAM AE

- (1) Set the POWER switch to CAMERA or MEMORY, then press FN to display PAGE1.
- (2) Press MENU, then set PROGRAM AE to the desired mode in  (p. 185).

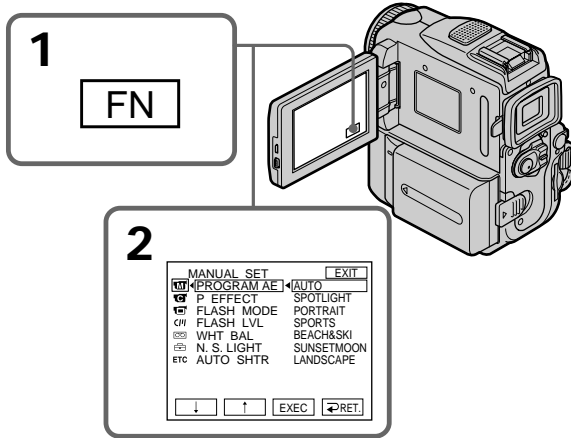

To return to FN

Press EXIT.

To turn the PROGRAM AE off

Select AUTO in PROGRAM AE in the menu settings.

Notes

- Because your camcorder is set to focus only on subjects in the middle to far distance, you cannot take close-ups in the following modes:
 - SPOTLIGHT
 - SPORTS
 - BEACH&SKI
- Your camcorder is set to focus only on distant subjects in the following modes:
 - SUNSETMOON
 - LANDSCAPE
- The following functions do not work in PROGRAM AE:
 - Color Slow Shutter
 - SLOW SHTR
 - OLD MOVIE
 - BOUNCE
- The PROGRAM AE does not work in the following cases (The indicator flashes):
 - To set the NIGHTSHOT to ON.
 - To record images on a “Memory Stick” using the MEMORY MIX.
- When you set the POWER switch to MEMORY, SPORTS does not work. (The indicator flashes.)

Using the PROGRAM AE

While WHT BAL is set to AUTO in the menu settings

The white balance is adjusted even if the PROGRAM AE is selected.

You can adjust the following functions while using the PROGRAM AE:

- Exposure
- Flexible Spot Meter

If you record under a discharge tube such as a fluorescent lamp, sodium lamp or mercury lamp

Flickering or changes in color may occur in the following modes. If this happens, turn the PROGRAM AE off:

- PORTRAIT
- SPORTS

Adjusting the exposure manually

You can adjust and set the exposure. Normally the exposure is automatically adjusted. Adjust the exposure manually in the following cases:

- The subject is backlit
- To shoot a bright subject against a background
- To record dark pictures (e.g. night scenes) faithfully

- (1) Set the POWER switch to CAMERA or MEMORY, then press FN to display PAGE1.
- (2) Press EXPOSURE. The screen to adjust the exposure appears.
- (3) Press MANUAL.
- (4) Adjust the exposure using -/+.
 - : to dim
 - + : to brighten
- (5) Press \rightarrow OK to return to PAGE1.

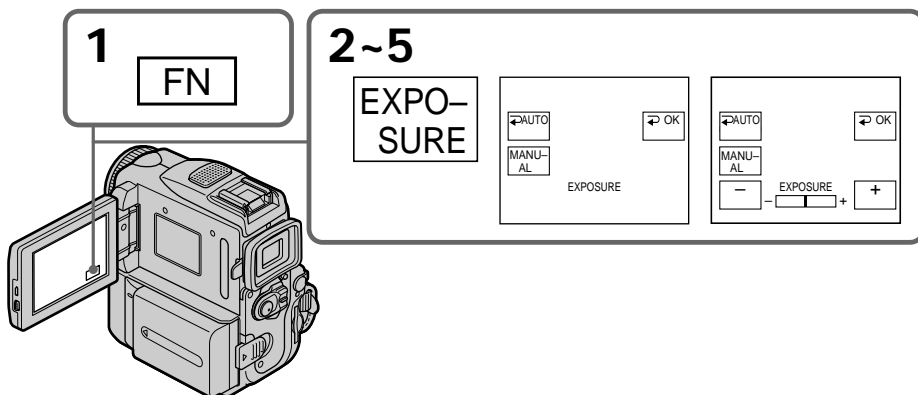

To return to FN

Press EXIT.

To return to the automatic exposure mode

Press \rightarrow AUTO to return to PAGE1.

Note

When you adjust the exposure manually, the following functions do not work:

- Color Slow Shutter
- BACK LIGHT

Your camcorder automatically returns to the automatic exposure mode:

- If you change the PROGRAM AE mode.
- If you slide NIGHTSHOT to ON.

Using the spot light-metering function – Flexible Spot Meter

You can take a picture with the appropriate exposure automatically for just the point you want to focus on and with its exposure fixed. Use the Flexible Spot Meter function in the following cases:

- The subject is backlit.
- When there is strong contrast between the subject and background such as with a subject that is on stage and lit by a spotlight.

- (1) Set the POWER switch to CAMERA or MEMORY, then press FN to display PAGE1.
- (2) Press SPOT METER. The SPOT METER screen appears.
- (3) Press the desired area in the frame on the LCD screen.
The SPOT METER indicator flashes on the LCD screen. The exposure of the point you selected is adjusted.
- (4) Press \rightarrow OK to return to PAGE1.

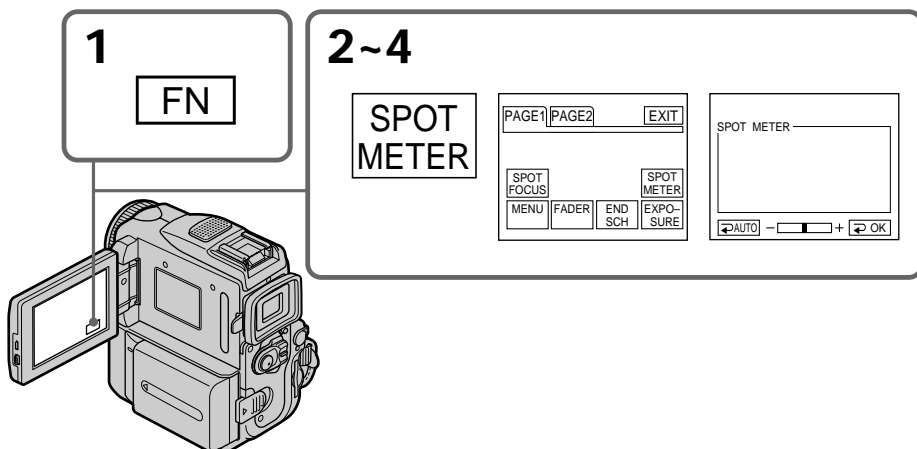

To return to FN

Press EXIT.

To return to the automatic exposure mode

Press \rightarrow AUTO to return to PAGE1.

Note

The following functions do not work during the Flexible Spot Meter:

- Color Slow Shutter
- BACK LIGHT
- Exposure
- Spot focus

Flexible Spot Meter is automatically canceled:

- If you change the PROGRAM AE mode.
- If you slide NIGHTSHOT to ON.

Focusing manually

You can gain better results by manually adjusting the focus in the following cases. Normally, focus is automatically adjusted.

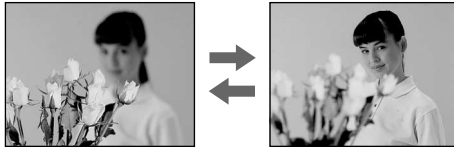

- The autofocus mode is not effective when shooting:
 - subjects through glass coated with water droplets
 - horizontal stripes
 - subjects with little contrast with backgrounds such as walls or the sky
- When you want to change the focus from a subject in the foreground to a subject in the background
- Shooting a stationary subject when using a tripod

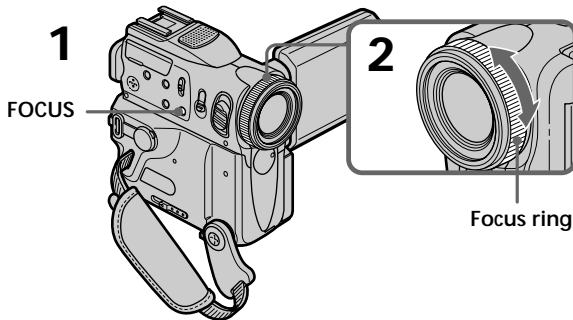

- (1) Set the POWER switch to CAMERA or MEMORY, then press FOCUS lightly. The  indicator appears.
- (2) Turn the focus ring to sharpen focus.



To return to the autofocus mode

Press FOCUS lightly to turn off ,  or  indicator.

To record distant subjects

When you press FOCUS down deeper, the focus becomes infinite and the  indicator appears. When you release FOCUS, your camcorder returns to the manual focus mode. Use this mode when your camcorder focuses on near objects even though you are trying to shoot a distant subject.



To focus precisely

It is easier to focus on the subject if you adjust the zoom to shoot at the “W” (wide-angle) position after focusing at the “T” (telephoto) position.

When you shoot close to the subject

Focus at the end of the “W” (wide-angle) position.

 changes as follows:

-  when recording a distant subject
-  when the subject is too close to focus on

Using the spot focus function

- Spot Focus

You can take a picture with the appropriate focus automatically for just the point you want to focus on and with its focus fixed.

- (1) Set the POWER switch to CAMERA or MEMORY, then press FN to display PAGE1.
- (2) Press SPOT FOCUS. The SPOT FOCUS screen appears.
- (3) Press the desired area in the frame on the LCD screen.
The SPOT FOCUS indicator flashes on the LCD screen. The focus of the point you selected is adjusted.
- (4) Press \rightarrow OK to return to PAGE1.

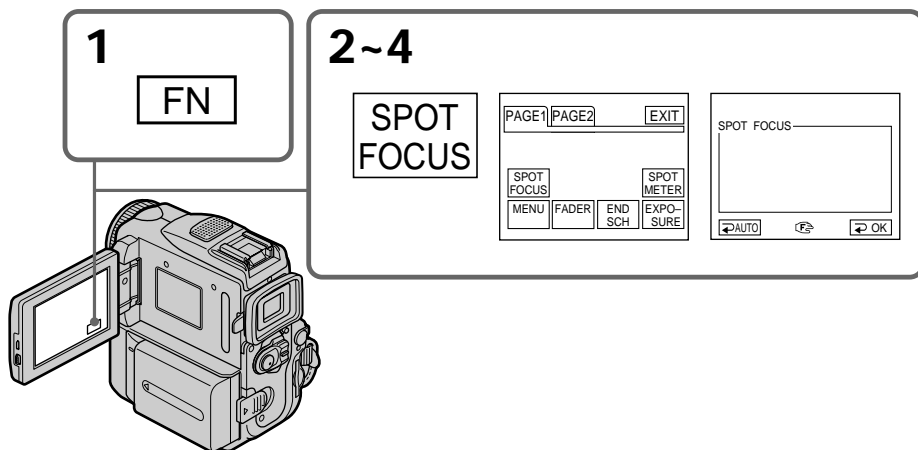

To return to FN

Press EXIT.

To return to the autofocus mode

Press \rightarrow AUTO to return to PAGE1.

Note

You cannot use Spot Focus during PROGRAM AE.

Interval recording

You can make a time-lapse recording by setting the camcorder to automatically record and standby sequentially. You can achieve an excellent recording for flowering, emergence, etc. with this function.

Example

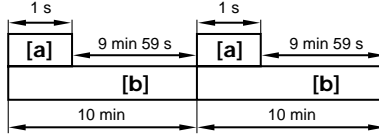

[a] REC TIME

[b] INTERVAL

- (1) In standby, press FN to display PAGE1.
- (2) Press MENU, then set INT. REC to SET in , then press EXEC (p. 186).
- (3) Set INTERVAL and REC TIME.
 - ① Press ↓/↑ to select INTERVAL, then press EXEC.
 - ② Press ↓/↑ to select the desired interval time, then press EXEC.
The time: 30SEC ↔ 1MIN ↔ 5MIN ↔ 10MIN
 - ③ Press ↓/↑ to select REC TIME, then press EXEC.
 - ④ Press ↓/↑ to select the desired recording time, then press EXEC.
The time: 0.5SEC ↔ 1SEC ↔ 1.5SEC ↔ 2SEC
 - ⑤ Press ↶ RET.

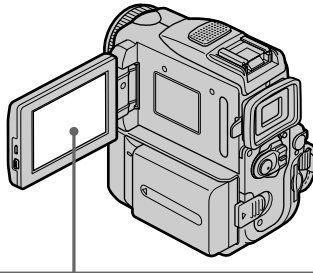

3

①

CAMERA SET		EXIT
INT. REC	30SEC	
INTERVAL	30SEC	
REC TIME		
CH/		
ES		
ETC		
↓ ↑ EXEC ↶RET		

②

CAMERA SET		EXIT
INT. REC	1MIN	
INTERVAL	10MIN	
REC TIME		
CH/		
ES		
ETC		
↓ ↑ EXEC ↶RET		

③

CAMERA SET		EXIT
INT. REC	0.5SEC	
INTERVAL		
REC TIME		
CH/		
ES		
ETC		
↓ ↑ EXEC ↶RET		

④

CAMERA SET		EXIT
INT. REC	1.5SEC	
INTERVAL		
REC TIME		
CH/		
ES		
ETC		
↓ ↑ EXEC ↶RET		

Interval recording

- (4) Set INT. REC to ON, then press EXEC.
- (5) Press EXIT to return to FN.
The INTERVAL indicator flashes on the screen.
- (6) Press START/STOP to start interval recording.
The INTERVAL indicator lights up.

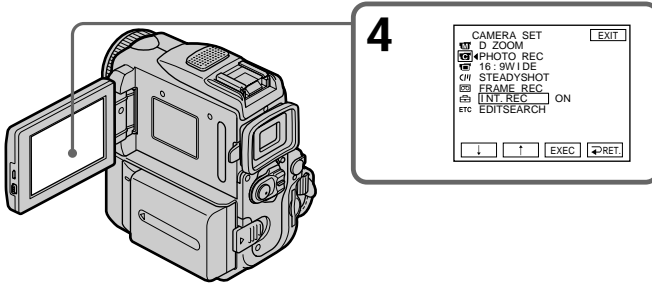

To cancel the interval recording

Perform either of the following:

- Set INT. REC to OFF in the menu settings.
- Set the POWER switch to other than CAMERA.

To perform normal recording during interval recording

Press START/STOP. The INTERVAL indicator flashes, and normal recording starts. Press START/STOP again, then normal recording finishes and returns to the screen in step 5.

Note

You cannot do interval recording during MPEG movie recording.

Recording time

There may be a discrepancy in recording time of up to +/- 6 frames from the selected time.

Frame by frame recording

- Frame recording

You can make a recording with a stop-motion animated effect using frame recording. To create this effect, alternately move the subject a little and make a frame recording. We recommend that you use a tripod, and operate the camcorder using the Remote Commander after step 4.

- (1) In standby, press FN to display PAGE1.
- (2) Press MENU, then set FRAME REC to ON in  (p. 186).
- (3) Press EXIT to return to FN.
The FRAME REC indicator lights up.
- (4) Press START/STOP to start frame recording. The camcorder makes a recording for about six frames, and returns to standby.
- (5) Move the subject, and repeat step 4.

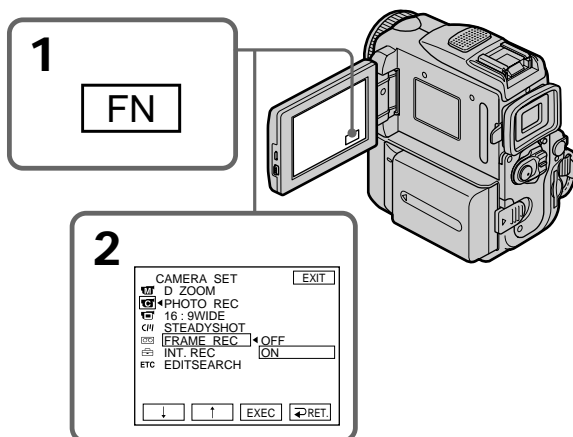

To cancel frame recording

Perform either of the following:

- Set FRAME REC to OFF in the menu settings.
- Set the POWER switch to other than CAMERA.

Notes

- The proper remaining tape time is not indicated if you use this function continuously.
- You cannot do frame recording during MPEG movie recording.

When using the frame recording function





The last recorded frame is longer than other frames.

Using the viewfinder

Pull out the viewfinder until it clicks, and then turn the LCD panel over and move it back to your camcorder body with the LCD screen facing out. You can operate with the touch panel using the viewfinder.

Use the viewfinder in the following case:

When operating camera brightness and the fader (only in CAMERA) on the touch panel using the viewfinder.

- (1) Set the POWER switch to CAMERA or MEMORY. Pull out the viewfinder until it clicks, and then turn the LCD panel over and move it back to your camcorder body with the LCD screen facing out.
- (2) Press  OFF. The message PANEL OFF appears on the screen.
- (3) Press OK. The LCD screen is turned off.
- (4) Using the viewfinder, press the LCD screen. EXPOSURE,  OK,  ON and FADER (only in CAMERA) appear.
- (5) Select a desired item, then press  OK.

EXPOSURE: adjust the exposure by pressing -/+.

FADER: press FADER until the desired fader mode is displayed.

The indicator changes as follows:

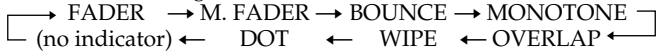

 ON: The LCD screen lights up, then becomes Mirror Mode.

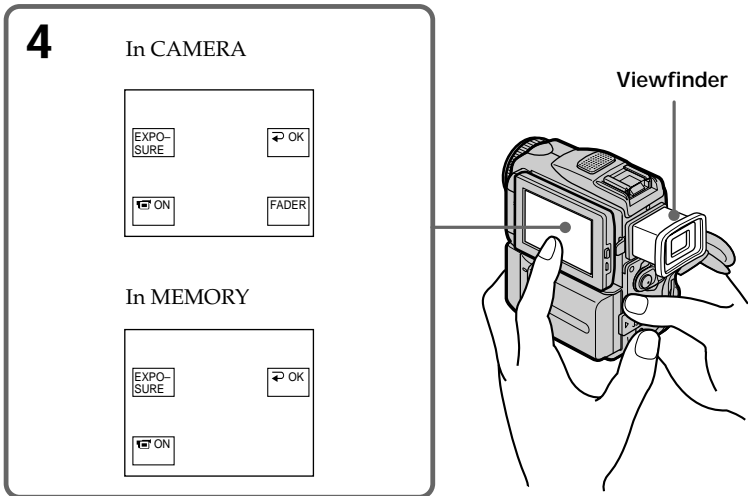

To make the buttons on the LCD screen disappear

Press  OK.

Using the viewfinder

Notes

- Do not touch the LCD screen with wet hands.
- Do not press the LCD screen with sharp objects such as a pen.
- In VCR or memory playback, you cannot operate with the touch panel using the viewfinder.

To operate the items that are not displayed

Set the LCD screen and the viewfinder back to the previous position. Operate the items using the LCD screen.

FN and OFF in the viewfinder

These buttons appear mirror-reversed.

Available recording time

This is the time when you record pictures using the viewfinder (p. 16).

Playing back a tape with picture effect

During playback, you can process a scene using the picture effect functions: NEG.ART, SEPIA, B&W and SOLARIZE.

- (1) In playback or playback pause, press FN to display PAGE1.
- (2) Press MENU, then set P EFFECT to the desired mode in  (p. 185). See page 56 for details of each picture effect function.

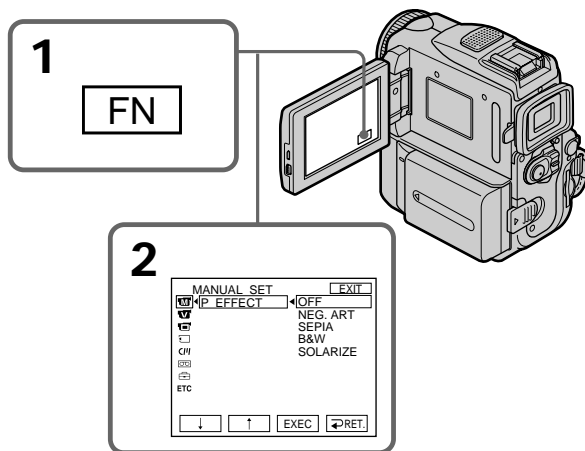

To return to FN

Press EXIT.

To cancel the picture effect function

Set P EFFECT to OFF in the menu settings.

Notes

- You cannot process externally input scenes using the picture effect function.
- You cannot record images on a tape on your camcorder while you are processing the image using the picture effect function. Record images on a “Memory Stick” (p. 127, 139), or on a VCR using your camcorder as a player.

Pictures processed by the picture effect function

Pictures processed by the picture effect function are not output through the  DV Interface.

When you set the POWER switch to OFF (CHARGE) or stop playing back

The picture effect function is automatically canceled.

Playing back a tape with digital effect

During playback, you can process a scene using the digital effect functions: STILL, FLASH, LUMI. and TRAIL.

- (1) In playback or playback pause, press FN and select PAGE2.
- (2) Press DIG EFFT. The screen to select a desired digital effect mode appears.
- (3) Select a desired digital effect mode. In STILL or LUMI., the picture that you select the mode to is stored in memory as a still image.
- (4) Press -/+ to adjust the effect. See page 58 for details.
- (5) Press ↵ OK to return to PAGE2.

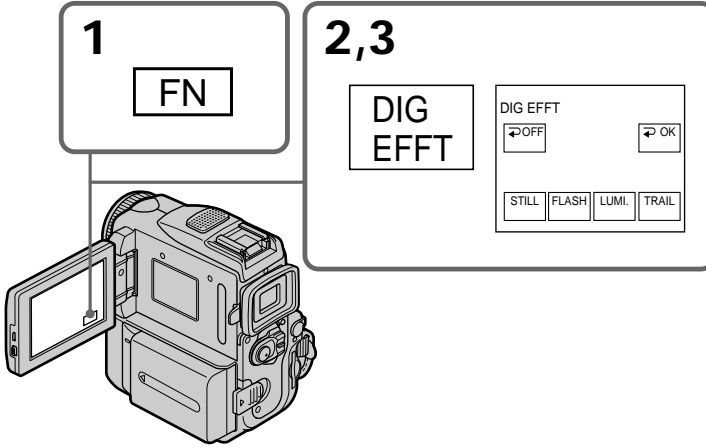

To return to FN

Press EXIT.

To cancel the digital effect function

Press ↵ OFF to return to PAGE2.

Notes

- You cannot process externally input scenes using the digital effect function.
- You cannot record images on a tape on your camcorder while you are processing the image using the digital effect function. Record images on a "Memory Stick" (p. 127, 139), or on a VCR using your camcorder as a player.

Pictures processed by the digital effect function

Pictures processed by the digital effect function are not output through the  DV Interface.

When you set the POWER switch to OFF (CHARGE) or stop playing back

The digital effect function is automatically canceled.

Enlarging images recorded on tapes - Tape PB ZOOM

You can enlarge playback images recorded on tapes. Besides the operation described here, your camcorder can enlarge still images recorded on "Memory Stick"s (p. 154).

- (1) In playback or playback pause, press FN and select PAGE2.
- (2) Press PB ZOOM. The PB ZOOM screen appears.
- (3) Press the area you want to enlarge in the frame on the PB ZOOM screen.
The area you pressed moves to the center of the screen, and the playback image is enlarged to about twice the size. If you press the other area again, the area moves to the center of the screen.
- (4) Adjust the zoom ratio by the zoom lever.
You can select the zoom ratio from approximately 1.1 times up to five times its size.
W: Decrease the zoom ratio.
T: Increase the zoom ratio.

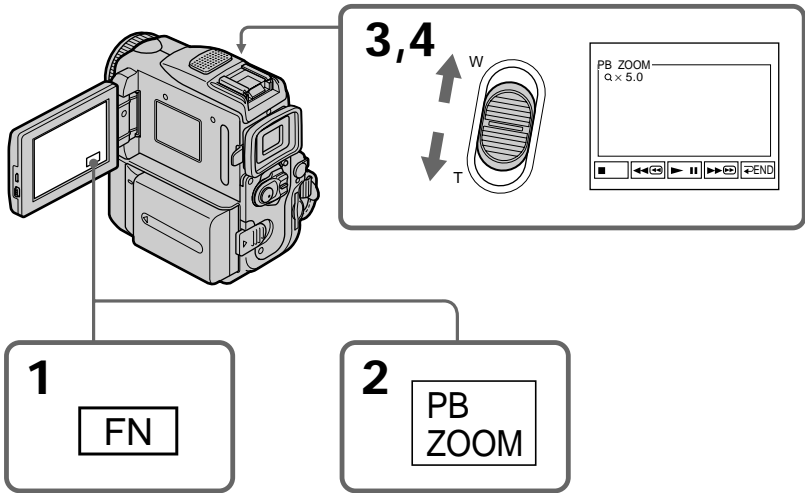

To cancel the PB ZOOM function

Press END.

Notes



- You cannot process externally input scenes using the PB ZOOM function with your camcorder.
- You cannot record images on a tape on your camcorder while you are processing the image using the tape PB ZOOM function. However, you can record images on a VCR using your camcorder as a player.
- You cannot record moving pictures on a "Memory Stick" on your camcorder when you have processed the picture using tape PB ZOOM.

Enlarging images recorded on tapes – Tape PB ZOOM

The PB ZOOM function is automatically canceled when you operate the following functions:

- Set the POWER switch to OFF (CHARGE).
- Stop playing back.
- Insert a “Memory Stick.”

Images in PB ZOOM

Images in the PB ZOOM mode are not output through the  DV Interface and  (USB) jack.

In PB ZOOM

If you press DISPLAY/TOUCH PANEL, the frame on the PB ZOOM screen disappears. You cannot move the part you pressed to the center of the screen.

Edge of the enlarged image

The edge of the enlarged image cannot be displayed at the center of the screen.

Quickly locating a scene - ZERO SET MEMORY

Your camcorder automatically searches for a desired scene having a tape counter value of "0:00:00". Use the Remote Commander for this operation.

- (1) In playback, press DISPLAY on the Remote Commander if the counter is not on the screen.
- (2) Press ZERO SET MEMORY on the Remote Commander at the point you want to locate later. The tape counter shows "0:00:00" and the ZERO SET MEMORY indicator flashes.
- (3) Press ■ when you want to stop playback.
- (4) Press ◀◀ to rewind the tape to the tape counter's zero point. The tape stops automatically when the tape counter reaches approximately zero. The ZERO SET MEMORY indicator disappears and the time code appears.
- (5) Press ▶▶. Playback starts from the counter's zero point.

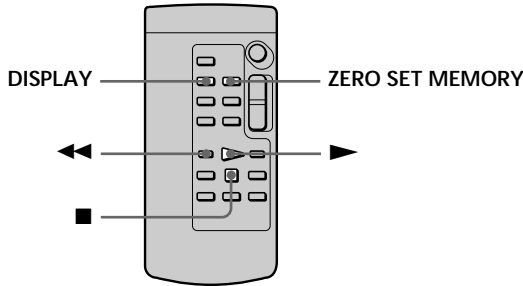

Notes

- When you press ZERO SET MEMORY before rewinding the tape, the zero set memory function will be canceled.
- There may be a discrepancy of several seconds between the time code and the tape counter.
- The ZERO SET MEMORY indicator disappears when you press FN.

If a tape has a blank portion in the recorded sections

ZERO SET MEMORY may not work correctly.

Searching the boundaries of recorded tape by title – TITLE SEARCH

CM
only

If you use a tape with cassette memory, you can search for the boundaries of a recorded tape by title. Use the Remote Commander for this operation.

Before operation

Set CM SEARCH to ON in the menu settings. (The default setting is ON.)

- (1) Set the POWER switch to VCR.
- (2) Press SEARCH MODE on the Remote Commander repeatedly, until the TITLE SEARCH indicator appears.

The indicator changes as follows:

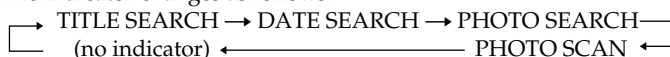

- (3) Press ◀◀ or ▶▶ on the Remote Commander to select the title for playback. Your camcorder automatically starts playback of the scene having the title that you selected.

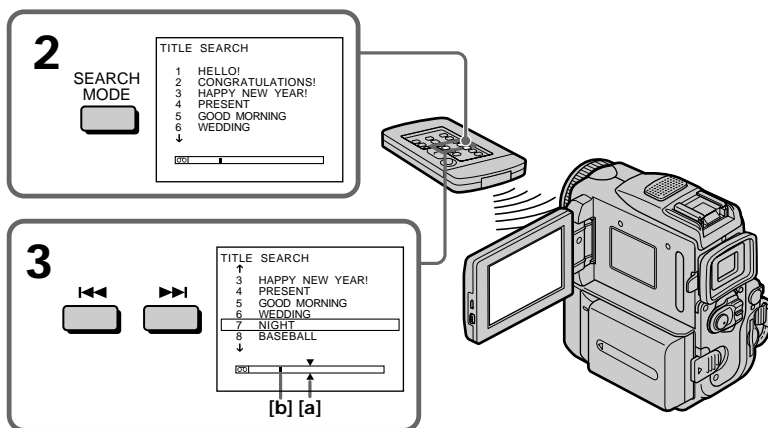

[a]: Actual point you are trying to search for

[b]: Present point on the tape

To stop searching

Press ■ on the Remote Commander.

If you use a cassette without cassette memory

You cannot superimpose or search a title.

If a tape has a blank portion between recorded sections

TITLE SEARCH may not work correctly.

To superimpose a title

See page 106.

Searching a recording by date

- DATE SEARCH

Your camcorder automatically searches for the point where the recording date changes and starts playback from that point (**DATE SEARCH**).

Use a tape with cassette memory for convenience. Use the Remote Commander for this operation.

Use this function to check where recording dates change or to edit the tape at each recording date.

Searching for the date by using cassette memory

Before operation

- You can use this function only when playing back a tape with cassette memory.
- Set CM SEARCH to ON in the menu settings. (The default setting is ON.)

- (1) Set the POWER switch to VCR.
- (2) Press SEARCH MODE on the Remote Commander repeatedly, until the DATE SEARCH indicator appears.

The indicator changes as follows:



- (3) Press ◀◀ or ▶▶ on the Remote Commander to select the date for playback. Your camcorder automatically starts playback at the beginning of the selected date.

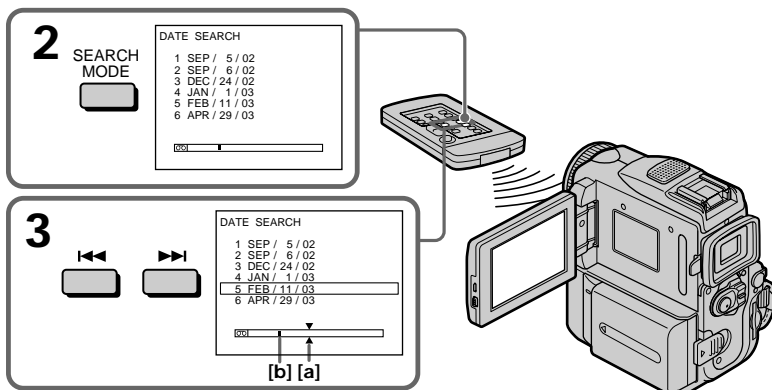

[a]: Actual point you are trying to search for
[b]: Present point on the tape

To stop searching

Press ■ on the Remote Commander.

Searching a recording by date – DATE SEARCH

Note

If one day's recording is less than two minutes, your camcorder may not accurately find the point where the recording date changes.

If a tape has a blank portion between recorded sections

DATE SEARCH may not work correctly.

Cassette memory





The tape cassette memory can hold six recording date data. If you search the date among seven or more data, see "Searching for the date without using cassette memory."

Searching for the date without using cassette memory

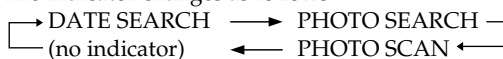
- (1) Set the POWER switch to VCR.
- (2) Press FN to display PAGE1.
- (3) Press MENU, then set CM SEARCH to OFF in  (p. 190).
- (4) Press SEARCH MODE on the Remote Commander repeatedly, until the DATE SEARCH indicator appears.

The indicator changes as follows:



- (5) Press  on the Remote Commander to search for the previous date or press  on the Remote Commander to search for the next date. Your camcorder automatically starts playback at the point where the date changes. Each time you press  or , your camcorder searches for the previous or next date.

To stop searching

Press  on the Remote Commander or  on your camcorder.

Searching for a photo

- PHOTO SEARCH/PHOTO SCAN

You can search for a still image you have recorded on a tape (**PHOTO SEARCH**). You can also search for still images one after another and display each image for five seconds automatically regardless of the cassette memory (**PHOTO SCAN**). Use the Remote Commander for these operations. Use this function to check or edit still images.

Searching for a photo by using cassette memory

Before operation

- You can use this function only when playing back a tape with cassette memory.
- Set CM SEARCH to ON in the menu settings. (The default setting is ON.)

- (1) Set the POWER switch to VCR.
- (2) Press SEARCH MODE on the Remote Commander repeatedly, until the PHOTO SEARCH indicator appears.

The indicator changes as follows:



- (3) Press ◀◀ or ▶▶ on the Remote Commander to select the date for playback. Your camcorder automatically starts playback of the photo having the date that you selected.

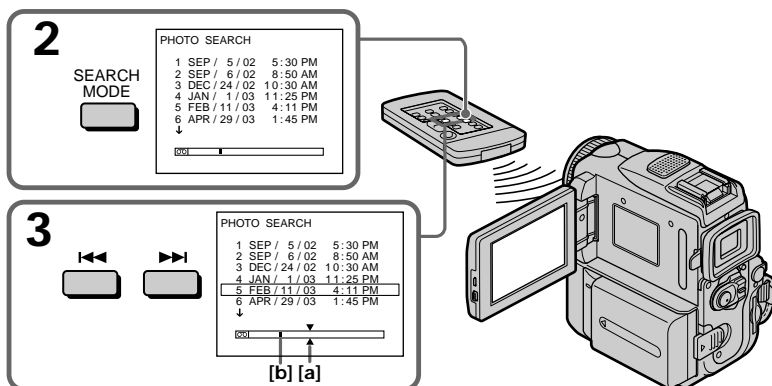

[a]: Actual point you are trying to search for

[b]: Present point on the tape

To stop searching

Press ■ on the Remote Commander.





Searching for a photo – PHOTO SEARCH/PHOTO SCAN

Searching for a photo without using cassette memory

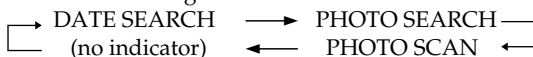
- (1) Set the POWER switch to VCR.
- (2) Press FN to display PAGE1.
- (3) Press MENU, then set CM SEARCH to OFF in  (p. 190).
- (4) Press SEARCH MODE on the Remote Commander repeatedly, until the PHOTO SEARCH indicator appears.

The indicator changes as follows:



- (5) Press  or  on the Remote Commander to select the photo for playback. Each time you press  or , your camcorder searches for the previous or next photo. Your camcorder automatically starts playback of the photo.

To stop searching



Press  on the Remote Commander or  on your camcorder.

Scanning photo

- (1) Set the POWER switch to VCR.
- (2) Press SEARCH MODE on the Remote Commander repeatedly, until the PHOTO SCAN indicator appears.

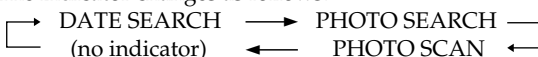
The indicator changes as follows:



- (3) Press  or  on the Remote Commander. Each photo is played back for about five seconds automatically.

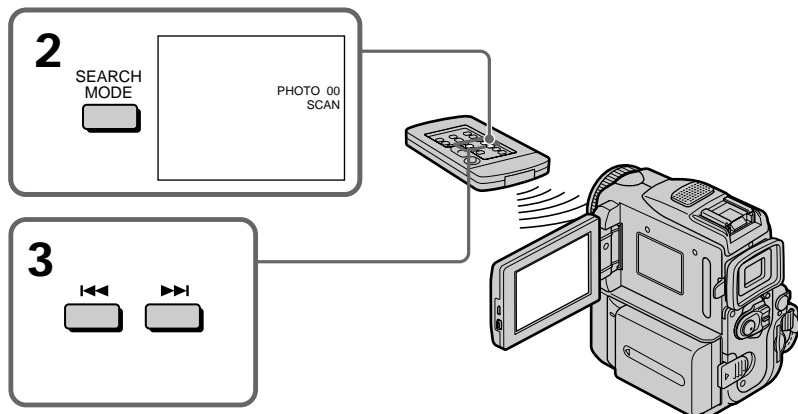

To stop scanning

Press  on the Remote Commander or  on your camcorder.

Searching for a photo – PHOTO SEARCH/PHOTO SCAN

If a tape has a blank portion between recorded sections

PHOTO SEARCH and PHOTO SCAN may not work correctly.

The available number of photos that can be searched using the cassette memory

The available number is up to 12 photos. However, you can search 13 photos or more using the photo scan function.

Dubbing a tape

Using the A/V connecting cable

You can dub or edit on the VCR connected to your camcorder using your camcorder as a player.

Connect your camcorder to the VCR using the A/V connecting cable supplied with your camcorder.

Before operation

- Set DISPLAY to LCD in the menu settings. (The default setting is LCD.)
- Press the following buttons to make the indicator disappear so that they will not be superimposed on the edited tape:

On your camcorder:

DISPLAY/TOUCHPANEL

On the Remote Commander:

DISPLAY, DATA CODE, SEARCH MODE

- (1) Insert a blank tape (or a tape you want to record over) into the VCR, and insert the recorded tape into your camcorder.
- (2) Connect the A/V connecting cable to A/V jack. Prepare the VCR for recording, then set the input selector to LINE.
Refer to the operating instructions of the VCR.
- (3) Set the POWER switch to VCR on your camcorder.
- (4) Play back the recorded tape on your camcorder.
- (5) Start recording on the VCR.
Refer to the operating instructions of your VCR.

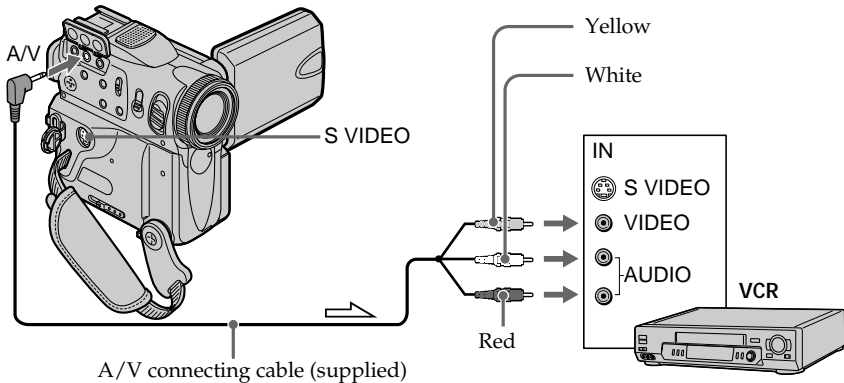

➤ : Signal flow

When you have finished dubbing a tape

Press ■ on both your camcorder and the VCR.

You can edit on VCRs that support the following systems

8 mm **B**, Hi8 **Hi8**, Digital8 **D8**, VHS **VHS**, S-VHS **S-VHS**, VHSC **VHSC**, S-VHSC **S-VHSC**, Betamax **B**, ED Betamax **ED Beta**, mini DV ^{Mini} **DV**, DV **DV** or MICRO MV **MICRO MV**

If your VCR is a monaural type

Connect the yellow plug of the A/V connecting cable to the video input jack and the white or the red plug to the audio input jack on the VCR or the TV. When the white plug is connected, the left channel audio is output, and when the red plug is connected, the right channel audio is output.

Dubbing a tape

If your VCR has an S video jack

Pictures can be reproduced more faithfully by using an S video cable (optional). With this connection, you do not need to connect the yellow (video) plug of the A/V connecting cable.

Connect an S video cable (optional) to the S video jacks of both your camcorder and the VCR.

This connection produces higher quality DV format pictures.

Using the i.LINK cable

Simply connect the i.LINK cable (optional) to the  DV Interface of your camcorder and to DV IN of the DV products. With digital-to-digital connection, video and audio signals are transmitted in digital form for high-quality editing. You cannot dub the titles, display indicators or the contents of cassette memory or letters on the "Memory Stick" index screen.

Set the input selector on the VCR to the DV input position if the VCR is equipped with an input selector.

- (1) Insert a blank tape (or a tape you want to record over) into the VCR, and insert the recorded tape into your camcorder.
- (2) Prepare the VCR for recording, then set the input selector to LINE. Refer to the operating instructions of the VCR.
- (3) Set the POWER switch to VCR on your camcorder.
- (4) Play back the recorded tape on your camcorder.
- (5) Start recording on the VCR. Refer to the operating instructions of the VCR.

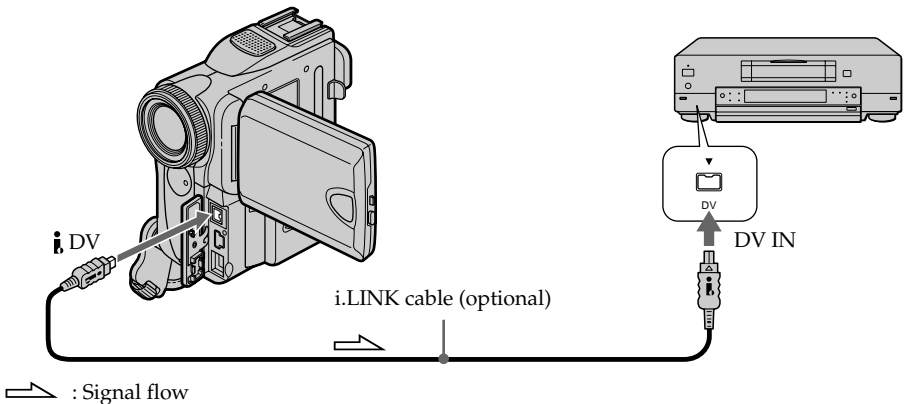

When you have finished dubbing a tape

Press  on both your camcorder and the VCR.

You can connect one VCR only using the i.LINK cable

See page 206 for more information about i.LINK.

Pictures processed by the picture effect, the digital effect or PB ZOOM function

Pictures processed by the picture effect, the digital effect or PB ZOOM function are not output through the  DV Interface.

If you record a paused playback picture with the DV Interface

The recorded picture becomes rough. And when you play back the picture using other video equipment, the picture may jitter.

Dubbing only desired scenes

- Digital program editing (on tapes)

You can duplicate selected scenes (programs) for editing onto a tape without operating the VCR.

Scenes can be selected by frame. You can set up to 20 programs.

Your camcorder can dub on "Memory Stick"s. See page 143 for more information.

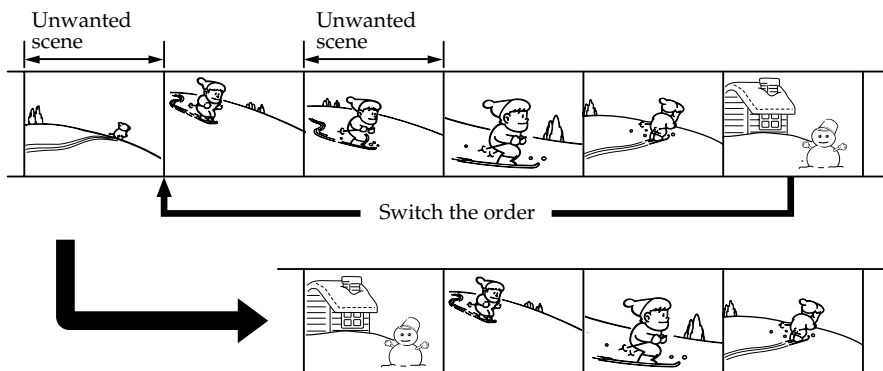

Before operating the Digital program editing on tapes recorded on other equipment

Step 1 Connecting to the VCR (p. 85).

Step 2 Setting the VCR to operate (p. 86, 90).

Step 3 Adjusting the synchronization of the VCR (p. 92).

When you dub using the same VCR again, you can skip steps 2 and 3.

Using the Digital program editing function on tapes recorded on other equipment

Operation 1 Making the program (p. 94).

Operation 2 Performing Digital program editing (Dubbing a tape) (p. 96).

Note

When editing digital video, the operation signals to the VCR cannot be sent with LANC .

Step 1: Connecting to the VCR

You can connect either the A/V connecting cable or the i.LINK cable .

When you use the A/V connecting cable, connect the devices as illustrated in page 83.

When you use the i.LINK cable, connect the devices as illustrated in page 84.

If you connect using an i.LINK cable

With digital-to-digital connection, video and audio signals are transmitted in digital form for high-quality editing.

Step 2: Setting the VCR to operate with the A/V connecting cable

To edit using the VCR, send the control signal by infrared rays to the remote sensor on the VCR.

When you connect using the A/V connecting cable, follow the procedures below, (1) to (4), to send the control signal correctly.

(1) Setting the IR SETUP code

- ① Set the POWER switch to VCR on your camcorder.
- ② Turn the power of the connected VCR on, then set the input selector to LINE.
When you connect a video camera recorder, set its power switch to VCR/VTR.
- ③ Press FN to display PAGE1.
- ④ Press MENU, then select VIDEO EDIT in $\boxed{\text{EDIT}}$, then press EXEC (p. 192).
- ⑤ Press ↓/↑ to select TAPE, then press EXEC.
- ⑥ Press EDIT SET.
- ⑦ Press ↓/↑ to select CONTROL, then press EXEC.
- ⑧ Press ↓/↑ to select IR, then press EXEC.
- ⑨ Press ↓/↑ to select IR SETUP, then press EXEC.
- ⑩ Press ↓/↑ to select the IR SETUP code of your VCR, then press EXEC.
Check the code in “About the IR SETUP code” (p. 88).

Dubbing only desired scenes – Digital program editing (on tapes)

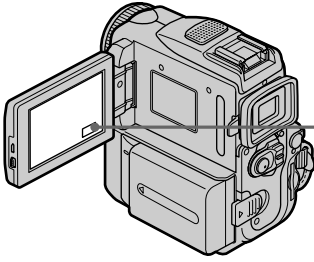

3

FN

<p>4</p> <div style="border: 1px solid black; padding: 5px;"> <p style="text-align: right;">EXIT</p> <p>OTHERS</p> <p>DATA CODE</p> <p>REPE</p> <p>COMMANDER</p> <p>DISPLA Y</p> <p>VIDEO EDIT READY</p> <p style="text-align: right;">EXEC RET</p> </div>	<p>5</p> <div style="border: 1px solid black; padding: 5px;"> <p style="text-align: right;">EXIT</p> <p>OTHERS</p> <p>DATA CODE</p> <p>REPE</p> <p>COMMANDER</p> <p>DISPLA Y</p> <p>VIDEO EDIT RETURN</p> <p>MEMORY</p> <p style="text-align: right;">EXEC RET</p> </div>	<p>6</p> <div style="border: 1px solid black; padding: 5px;"> <p style="text-align: right;">0:32:30:14</p> <p>VIDEO EDIT</p> <p>MARK IN START EDIT SET UNDO</p> <p>◀◀ ▶▶</p> <p>TOTAL 0:00:00:00</p> <p>SCENE 0</p> <p>████████████████████████████████████████</p> <p style="text-align: right;">END</p> </div>
<p>7</p> <div style="border: 1px solid black; padding: 5px;"> <p style="text-align: right;">END</p> <p>VIDEO EDIT</p> <p>EDIT SET</p> <p>CONTROL IR</p> <p>ADJ TEST</p> <p>"CUT-IN"</p> <p>"CUT-OUT"</p> <p>IR SETUP</p> <p>PAUSEMODE</p> <p>IR TEST</p> <p style="text-align: right;">EXEC RET</p> </div>	<p>8~10</p> <div style="display: flex; justify-content: space-around;"> <div style="border: 1px solid black; padding: 5px; width: 45%;"> <p style="text-align: right;">END</p> <p>VIDEO EDIT</p> <p>EDIT SET</p> <p>CONTROL IR</p> <p>ADJ TEST I.LINK</p> <p>"CUT-IN"</p> <p>"CUT-OUT"</p> <p>IR SETUP</p> <p>PAUSEMODE</p> <p>IR TEST</p> <p style="text-align: right;">EXEC RET</p> </div> <div style="font-size: 2em;">→</div> <div style="border: 1px solid black; padding: 5px; width: 45%;"> <p style="text-align: right;">END</p> <p>VIDEO EDIT</p> <p>EDIT SET</p> <p>CONTROL IR</p> <p>ADJ TEST</p> <p>"CUT-IN"</p> <p>"CUT-OUT"</p> <p>IR SETUP</p> <p>PAUSEMODE</p> <p>IR TEST</p> <p style="text-align: right;">EXEC RET</p> </div> </div>	
<div style="border: 1px solid black; padding: 5px;"> <p style="text-align: right;">EXIT</p> <p>VIDEO EDIT</p> <p>EDIT SET</p> <p>CONTROL</p> <p>ADJ TEST</p> <p>"CUT-IN"</p> <p>"CUT-OUT"</p> <p>IR SETUP 3</p> <p>PAUSEMODE</p> <p>IR TEST</p> <p style="text-align: right;">EXEC RET</p> </div>	<div style="display: flex; justify-content: space-around;"> <div style="font-size: 2em;">→</div> <div style="border: 1px solid black; padding: 5px;"> <p style="text-align: right;">END</p> <p>VIDEO EDIT</p> <p>EDIT SET</p> <p>CONTROL</p> <p>ADJ TEST</p> <p>"CUT-IN"</p> <p>"CUT-OUT"</p> <p>IR SETUP 1</p> <p>PAUSEMODE</p> <p>IR TEST</p> <p style="text-align: right;">EXEC RET</p> </div> </div>	

Editing

Dubbing only desired scenes – Digital program editing (on tapes)

About the IR SETUP code

The IR SETUP code is stored in the memory of your camcorder. Be sure to set the correct code, depending on your VCR. Default setting is code number 3.

Brand	IR SETUP code	Brand	IR SETUP code
Sony	1, 2, 3, 4, 5, 6	Mitsubishi/MGA	22, 23, 24, 28, 29
Admiral (M. Wards)	89	Multitech	23, 32, 80
Aiwa	47, 54, 80	NEC	21, 33, 35
Akai	49, 51	Olympic	77, 78
Audio Dynamic	21, 35	Optimus	22
Bell&Howell (M. Wards)	36	Orion	60
Broksonic	21, 70, 82	Panasonic	16, 17, 77, 78
Canon	77, 78	Pentax	8, 42
Citizen	47	Philco	26, 70, 77, 78
Craig	47, 73	Philips	47, 77, 78, 83
Curtis Mathis	8, 77, 80	Pioneer	78
Daewoo	26, 40, 77	Quasar	6, 16, 17, 77, 78
DBX	21, 33, 35	RCA/PROSCAN	7, 8, 16, 40, 41, 42, 77, 78, 78*, 83, 101
Dimensia	8	Realistic	22, 36, 37, 77, 80, 88
Emerson	26, 48, 59, 70, 80, 81, 82	Sansui	21
Fisher	36, 37, 44, 45	Singer	73
Funai	80	Samsung	24, 24*, 32, 32*, 41, 94, 94*
General Electric	8, 32*, 77, 94*, 101	Sanyo	26, 36, 37, 47
Goldstar/LG	47	Scott	22, 23, 24, 28, 32, 37, 40, 41
GO VIDEO	71	Sharp	88, 89
Hitachi	8, 42, 78	Shintom	73
HQ	40	Signature 2000	80, 89
Instant Replay	77, 78	Sylvania	77, 78, 80, 83
JC Penny	8, 21, 33, 35, 36, 42, 77	Symphonic	80
JVC	12, 13, 14, 21, 33, 35	Tashiro	47
Kenwood	21, 33, 35, 47	Tatung	21, 33, 35
LXI (Sears)	36, 37, 42, 44, 45, 47, 49, 80	Teac	21, 33, 35, 80
Magnavox	17, 77, 78, 83	Technics	77, 78
Marantz	21, 33, 35	Toshiba	7, 40, 49
Marta	47	Wards	37, 47, 88, 89, 95
Memorex	37, 77	Yamaha	21, 33, 35, 36
Minolta	8, 42	Zenith	95

* TV/VCR component

Note on the IR SETUP code

Digital program editing is not possible if the VCR does not support IR SETUP codes.

Dubbing only desired scenes – Digital program editing (on tapes)

(2) Setting the modes to cancel the recording pause on the VCR

- ① Press ↓/↑ to select PAUSEMODE, then press EXEC.
- ② Press ↓/↑ to select the mode to cancel recording pause on the VCR, then press EXEC.

The correct button depends on your VCR.

Refer to the operating instructions of your VCR.

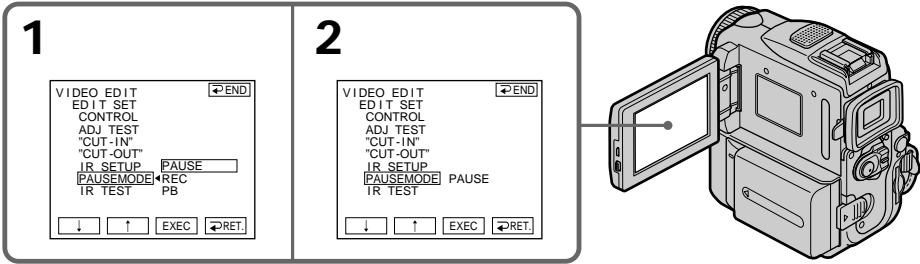

Editing

Buttons that cancel recording pause on the VCR

The buttons vary depending on your VCR. To cancel recording pause of your VCR:

- Select PAUSE if the button to cancel recording pause is ■.
- Select REC if the button to cancel recording pause is ●.
- Select PB if the button to cancel recording pause is ►.

(3) Locate the infrared rays emitter of your camcorder and face it towards the remote sensor of the VCR

Set the devices about 30 cm (12 in.) apart, and remove any obstacles between the devices.

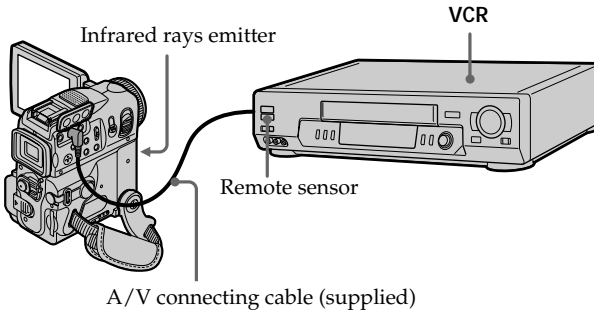

Dubbing only desired scenes – Digital program editing (on tapes)

(4) Confirming the VCR operation

- ① Insert a recordable tape into the VCR, then set the VCR to recording pause.
- ② Press ↓/↑ to select IR TEST, then press EXEC.
- ③ Press ↓/↑ to select EXECUTE, then press EXEC.

If the VCR starts recording, the setting is correct.

The indicator you selected to cancel recording pause on the VCR flashes on the LCD screen. When finished, the indicator changes to COMPLETE.

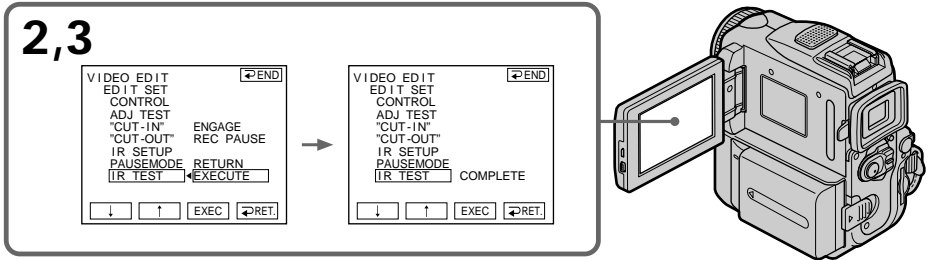

When the VCR does not operate correctly

- After checking the code in “About the IR SETUP” code, set the IR SETUP or the PAUSEMODE again.
- Place your camcorder at least 30 cm (12 in.) away from the VCR.
- Refer to the operating instructions of your VCR.

Step 2: Setting the VCR to operate with the i.LINK cable

When you connect using the i.LINK cable (optional), follow the procedures below.

- (1) Set the POWER switch to VCR on your camcorder.
- (2) Turn the power of the connected VCR on, then set the input selector to DV input.

When you connect a digital video camera recorder, set its power switch to VCR/VTR.

- (3) Press FN to display PAGE1.
- (4) Press MENU, then select VIDEO EDIT in ETC, then press EXEC (p. 192).
- (5) Press ↓/↑ to select TAPE, then press EXEC.
- (6) Press EDIT SET.
- (7) Press ↓/↑ to select CONTROL, then press EXEC.
- (8) Press ↓/↑ to select i.LINK, then press EXEC.

Dubbing only desired scenes – Digital program editing (on tapes)

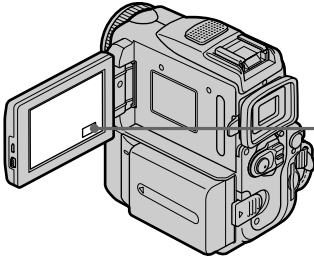

3

FN

4

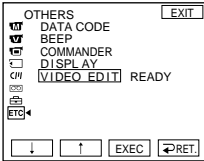

7,8

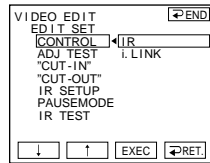
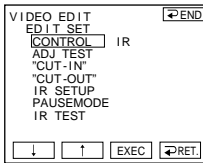

5

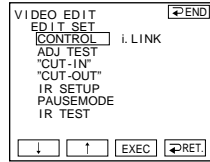
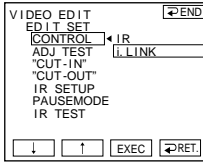
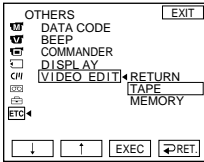

6

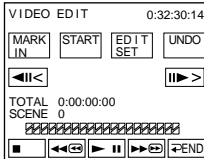

Editing

Note

When you connect with an i.LINK cable, you may not be able to operate the dubbing function correctly, depending on the VCR.

Set CONTROL to IR in the menu settings of your camcorder.

When you connect using i.LINK cable

You cannot dub the titles, display indicators.

Step 3: Adjusting the synchronization of the VCR

You can adjust the synchronization of your camcorder and the VCR.

Prepare a pen and paper for notes.

Before operation, eject a cassette from your camcorder (if inserted).

- (1) Insert a recordable tape into the VCR, then set the VCR to recording pause.
When you select i.LINK in CONTROL, the recording pause is not necessary.
- (2) Press ↓/↑ to select ADJ TEST, then press EXEC.
- (3) Press ↓/↑ to select EXECUTE, then press EXEC.
IN and OUT are recorded on an image for five times each to calculate the numerical values for adjusting the synchronization.
The EXECUTING indicator flashes on the LCD screen. When finished, the indicator changes to COMPLETE.
- (4) Rewind the tape in the VCR, then start slow playback.
Take a note of the opening numerical value of each IN and the closing numerical value of each OUT.
- (5) Calculate the average of five opening numerical values of five IN, and the average of all the closing numerical values of each OUT.
- (6) Press ↓/↑ to select "CUT-IN", then press EXEC.
- (7) Press ↓/↑ to select the average numerical value of IN, then press EXEC.
The calculated start position for recording is set.
- (8) Press ↓/↑ to select "CUT-OUT", then press EXEC.
- (9) Press ↓/↑ to select the average numerical value of OUT, then press EXEC.
The calculated stop position for recording is set.
- (10) Press ↩ RET. to execute.

Dubbing only desired scenes – Digital program editing (on tapes)

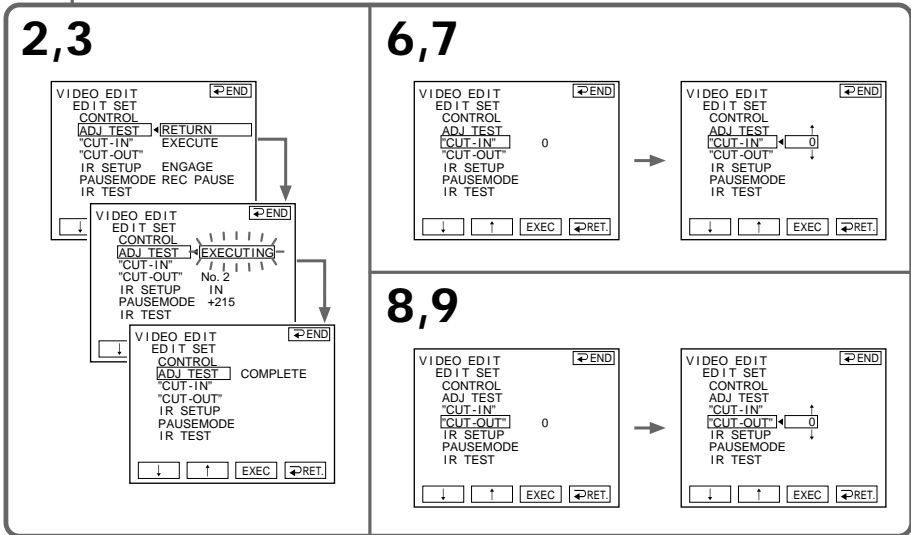
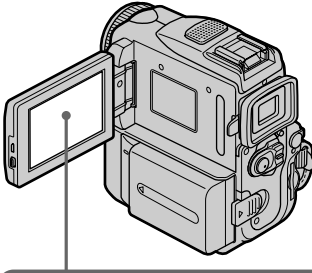

Editing

To return to FN

Press [END] to return to PAGE1, then press EXIT.

Notes

- When you complete step 3, the image to adjust the synchronization is recorded for about 50 seconds.
- If you start recording from the very beginning of the tape, the first few seconds of the tape may not be recorded properly. Be sure to allow about 10 seconds' lead before starting the recording.
- When the recording unit cannot be operated properly by the i.LINK cable, leave the connection as it is, and make the A/V connecting cable settings (p. 86). Video and audio are sent by digital signals.

Dubbing only desired scenes – Digital program editing (on tapes)

Operation 1: Making the Program

- (1) Insert the tape for playback into your camcorder, and insert a tape for recording into the VCR.
- (2) Press FN to display PAGE1.
- (3) Press MENU, then select VIDEO EDIT in **ETC**, then press EXEC (p. 192).
- (4) Press ↓/↑ to select TAPE, then press EXEC.
- (5) Search for the beginning of the first scene you want to insert using the video control buttons on the LCD screen, then pause playback. You can fine-adjust one frame at a time with **◀◀|◀** / **▶▶|▶**.
- (6) Press MARK IN on the screen.
The IN point of the first program is set, and the upper part of the program mark changes to light blue.
- (7) Search for the end of the first scene you want to insert using the video control buttons on the LCD screen, then pause playback. You can fine-adjust one frame at a time with **◀◀|◀** / **▶▶|▶**.
- (8) Press MARK OUT on the screen.
The OUT point of the first program is set, then the lower part of the program mark changes to light blue.
- (9) Repeat steps 5 to 8.
When one program is set, the program mark changes to light blue.
You can set 20 programs in maximum.

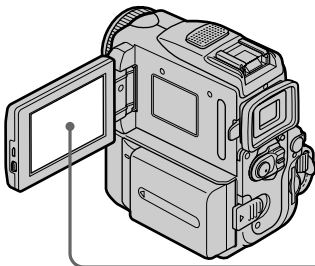

4

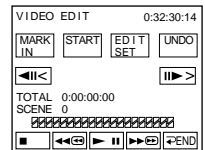
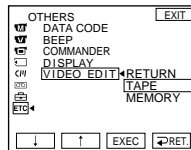

5~8

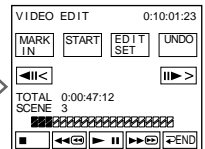
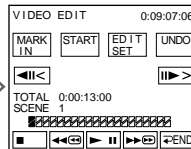
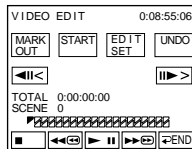

Dubbing only desired scenes – Digital program editing (on tapes)

Erasing the program you have set

Erase OUT mark first, and then IN mark of the last program.

- (1) Press UNDO.
- (2) Press ERASE 1 MARK. The last set program mark flashes, then DELETE ? appears.
- (3) Press EXEC. The last set program is deleted.

To cancel erasing

Press CANCEL in step 3.

Erasing all programs

- (1) Press MENU, then select VIDEO EDIT in $\overline{\text{ETC}}$, then press EXEC (p. 192).
- (2) Press ↓/↑ to select TAPE, then press EXEC.
- (3) Press UNDO.
- (4) Press ERASE ALL. All the set program marks flash, then DELETE ? appears.
- (5) Press EXEC. All the set programs are deleted.

To cancel erasing all programs

Press CANCEL in step 5.

To finish making programs

Press ↩ END.

The program is stored in memory until the tape is ejected.

Note

You cannot operate recording during the Digital program editing.

On a blank portion of the tape

You cannot set IN or OUT.

If there is a blank portion between the IN point and the OUT point on the tape

The time code may not be displayed correctly.

Dubbing only desired scenes – Digital program editing (on tapes)

Operation 2: Performing Digital program editing (Dubbing a tape)

Make sure your camcorder and the VCR are connected, and that the VCR is set to recording pause. When you use an i.LINK cable the following procedure is not necessary.

When you use a digital video camera recorder, set the power switch of VCR to VCR/VTR.

- (1) Press MENU, then select VIDEO EDIT in ETC, then press EXEC (p. 192).
- (2) Press ↓/↑ to select TAPE, then press EXEC.
- (3) Press START.
- (4) Press EXEC.

Search for the beginning of the first program, then start dubbing.

The SEARCH indicator appears during search, and the EDITING indicator appears during edit on the LCD screen.

The program mark changes to light blue after the dubbing is complete.

When the dubbing ends, your camcorder and the VCR automatically stop.

To stop dubbing during editing

Press CANCEL.

To finish the Digital program editing function

Your camcorder stops when the dubbing is complete. Then the display returns to VIDEO EDIT in the menu settings.

Press ↩ END to end the video edit function.

You cannot record on the VCR when:

- The tape has run out.
- The write-protect tab on the cassette is set to lock.
- The IR SETUP code is not correct. (When IR is selected.)
- The button to cancel recording pause is not correct. (When IR is selected.)

CHECK "i.LINK" & REC STATUS appears on the LCD screen when:

- i.LINK is selected but an i.LINK cable is not connected.
- The power of the connected VCR is not turned on. (When i.LINK is selected.)

When the program has not been set

You cannot press START.

Recording video or TV programs

Using the A/V connecting cable

You can record a tape from another VCR or a TV program from a TV that has video/audio outputs. Use your camcorder as a recorder.

Before operation

Set DISPLAY to LCD in the menu settings. (The default setting is LCD.)

- (1) Insert a blank tape (or a tape you want to record over) into your camcorder. If you are recording a tape from the VCR, insert a recorded tape into the VCR.
- (2) Set the POWER switch to VCR on your camcorder.
- (3) Press FN and select PAGE3, then press REC CTRL. And press REC PAUSE.
- (4) Press ► on the VCR to start playback if you record a tape from VCR. Select a TV program if you record from TV. The picture from TV or VCR appears on the screen.
- (5) Press REC START at the scene where you want to start recording from.

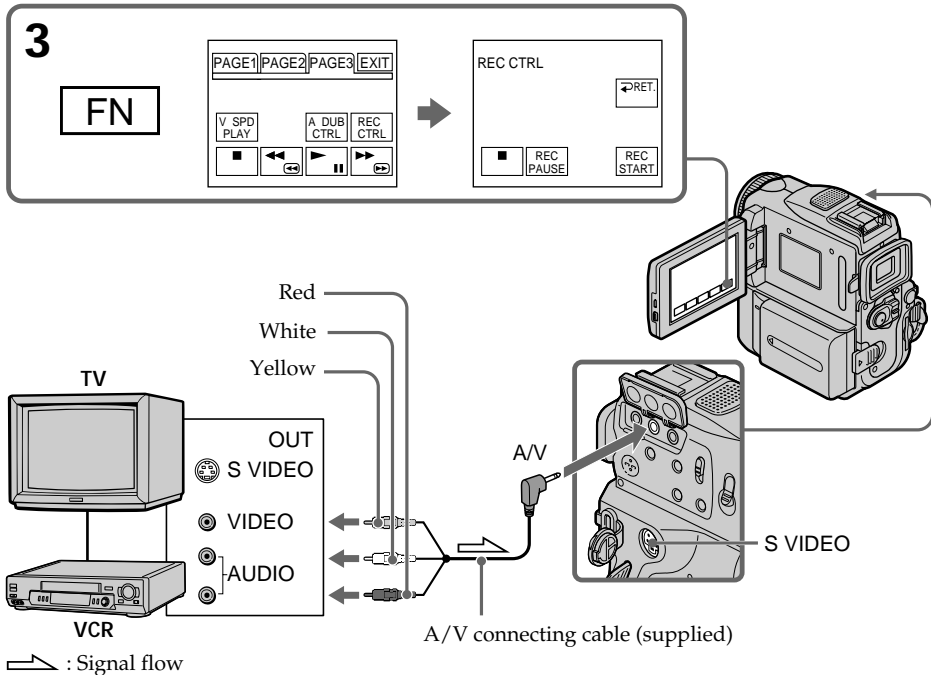

When you have finished dubbing a tape

Press ■ on both your camcorder and the VCR.

If your VCR is a monaural type

Connect the yellow plug of the A/V connecting cable to the video output jack and the white or the red plug to the audio output jack on the VCR or the TV. When the white plug is connected, the left channel audio is output, and when the red plug is connected, the right channel audio is output.

Recording video or TV programs

If your TV or VCR has an S video jack

Pictures can be reproduced more faithfully by using an S video cable (optional).

With this connection, you do not need to connect the yellow (video) plug of the A/V connecting cable.

Connect an S video cable (optional) to the S video jacks of both your camcorder and the TV or VCR.

This connection produces higher quality DV format pictures.

Using the i.LINK cable

Simply connect the i.LINK cable (optional) to the **i** DV Interface on your camcorder and to DV OUT on the DV products. With digital-to-digital connection, video and audio signals are transmitted in digital form for high-quality editing.

- (1) Insert a blank tape (or a tape you want to record over) into your camcorder, and insert the recorded tape into VCR.
- (2) Set the POWER switch to VCR on your camcorder.
- (3) Press FN and select PAGE3, then press REC CTRL. And press REC PAUSE.
- (4) Press **▶** on the VCR to start playback. The picture from the DV products appears on the screen of your camcorder.
- (5) Press REC START at the scene where you want to start recording.

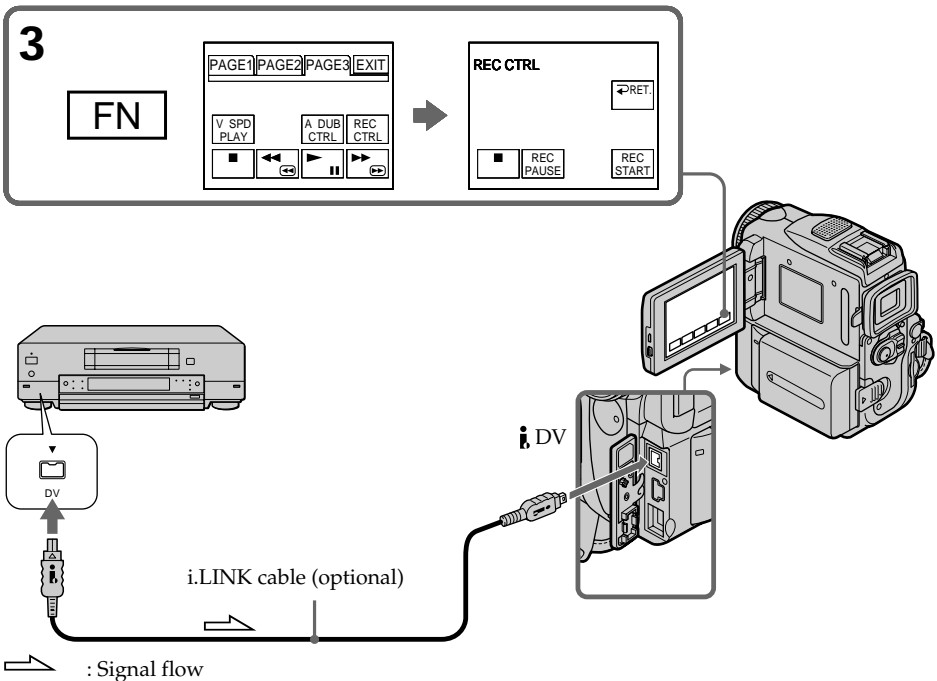

Recording video or TV programs

When you have finished dubbing a tape

Press ■ on both your camcorder and the VCR.

You can connect one VCR only using the i.LINK cable.

See page 206 for more information about i.LINK.

When you dub a picture in digital form

The color of the display may be uneven. However, this does not affect the dubbed picture.

If you record a paused playback picture with the i DV Interface

The recorded picture becomes rough. And when you play back the picture using your camcorder, the picture may jitter.

Before recording

Make sure if the DV IN indicator appears on the screen. The DV IN indicator may appear on both equipment.

Inserting a scene from a VCR - Insert editing

You can insert a new scene from a VCR onto your originally recorded tape by specifying the insert start and end points. Use the Remote Commander for this operation. Connections are the same as on page 97 or 98 .
Insert a cassette containing the desired scene to insert into the VCR.

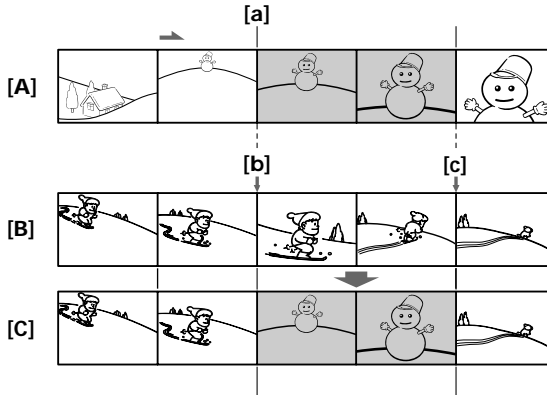

[A]: A tape that contains the scene to be superimposed
[B]: A tape before editing
[C]: A tape after editing

- (1) Set the POWER switch to VCR.
- (2) On the VCR, locate just before the insert start point **[a]**, then set the VCR to playback pause.
- (3) On your camcorder, locate the insert end point **[c]** by pressing ◀◀ or ▶▶. Then set it to playback pause.
- (4) Press ZERO SET MEMORY on the Remote Commander. The ZERO SET MEMORY indicator flashes and the end point of the insert is stored in memory. The tape counter shows "0:00:00."
- (5) On your camcorder, locate the insert start point **[b]** by pressing ◀◀. Press FN and select PAGE3, then press REC CTRL. And press REC PAUSE.
- (6) First press ■ on the VCR, and after a few seconds press REC START on your camcorder to start inserting the new scene.
Inserting automatically stops near the zero point on the tape counter. Your camcorder automatically stops recording.

Inserting a scene from a VCR – Insert editing

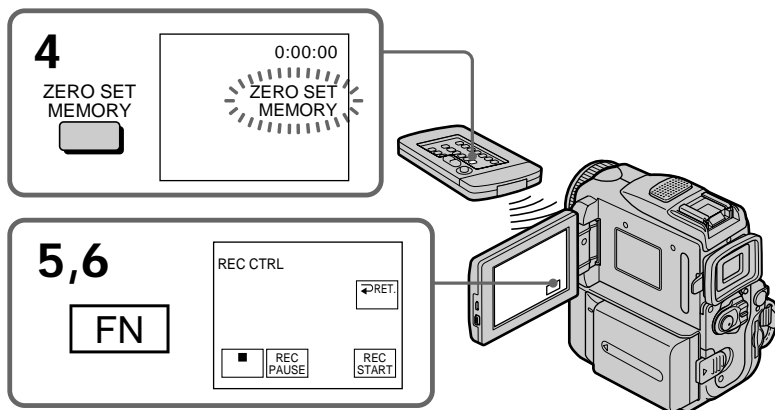

To change the insert end point

Press ZERO SET MEMORY again after step 5 to erase the ZERO SET MEMORY indicator and begin from step 3.

Note

The picture and sound recorded on the section between the insert start and end points will be erased when you insert the new scene.

If you insert scenes on the tape recorded with other camcorder (including other DCR-PC101)

The picture and sound may be distorted. We recommend that you insert scenes on a tape recorded with your camcorder.

When the inserted picture is played back

The picture and sound may be distorted at the end of the inserted section. This is not a malfunction.

The picture and sound at the start point and the end point may be distorted in the LP mode.

To insert a scene without setting the insert end point

Skip step 3 and 4. Press on the Remote Commander or on your camcorder when you want to stop inserting.

If you press FN

The ZERO SET MEMORY indicator is not displayed.

Audio dubbing

You can record additional audio to the original sound on a tape by connecting audio equipment or a microphone. If you connect the audio equipment, you can add sound to your tape already recorded in the 12-bit mode by specifying starting and ending points. The original sound will not be erased.

Select one of the following connections to add additional audio.

Connecting the microphone with the MIC jack

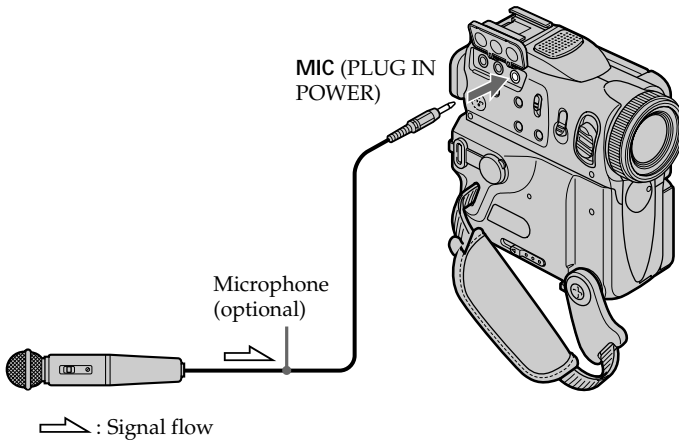

You can check the recorded picture and sound by connecting the A/V jack to a TV. The recorded sound is not output from a speaker. Check the sound by using the headphones or TV.

Connecting the microphone to the intelligent accessory shoe

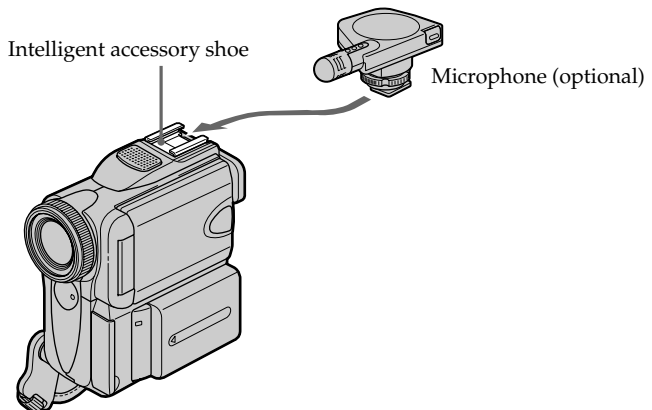

Audio dubbing

Connecting the A/V connecting cable to the A/V jack

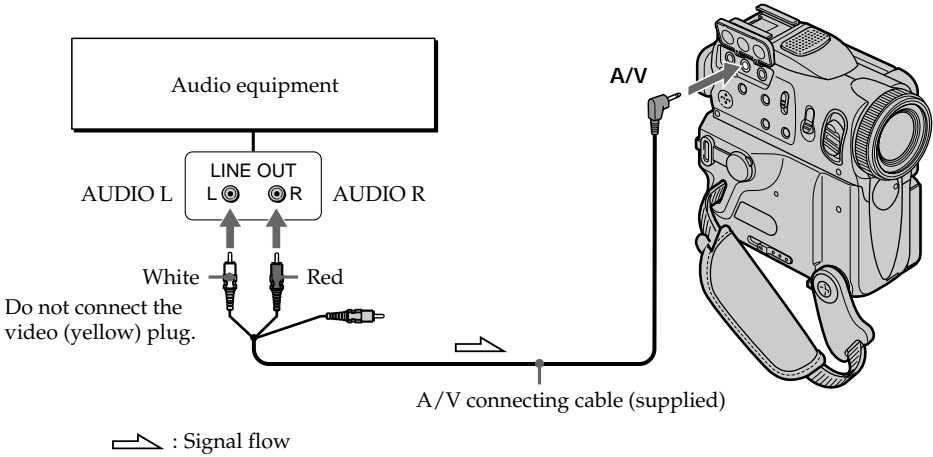

Dubbing with the built-in microphones

No connection is necessary.

Note

When dubbing with the A/V jack or the built-in microphone, pictures are not output through the S VIDEO jack or A/V jack. Check the recorded picture on the screen. You can check the recorded sound by using headphones.

If you make all the connections

The audio input to be recorded will take precedence over others in the following order.

- MIC (PLUG IN POWER) jack
- Intelligent accessory shoe
- A/V jack
- Built-in microphone

Audio dubbing

Adding an audio sound on a recorded tape

Choose a connection mentioned before, and connect audio equipment or microphone to your camcorder. Then follow the procedure below.

- (1) Insert your recorded tape into your camcorder.
- (2) Set the POWER switch to VCR.
- (3) Locate the recording start point. Press to start playing back. To pause playing back, press at the recording start point. You can fine adjust the recording start point by pressing / .
- (4) Press FN, then select PAGE3.
- (5) Press A DUB CTRL to display control buttons.
- (6) Press AUDIO DUB. The green appears on the LCD screen.
- (7) Press on your camcorder and at the same time start playing back the audio you want to record.

The new sound is recorded in stereo 2 (ST2) during playback. While recording new sound, the red appears on the LCD screen.

- (8) Press on your camcorder at the point where you want to stop recording.

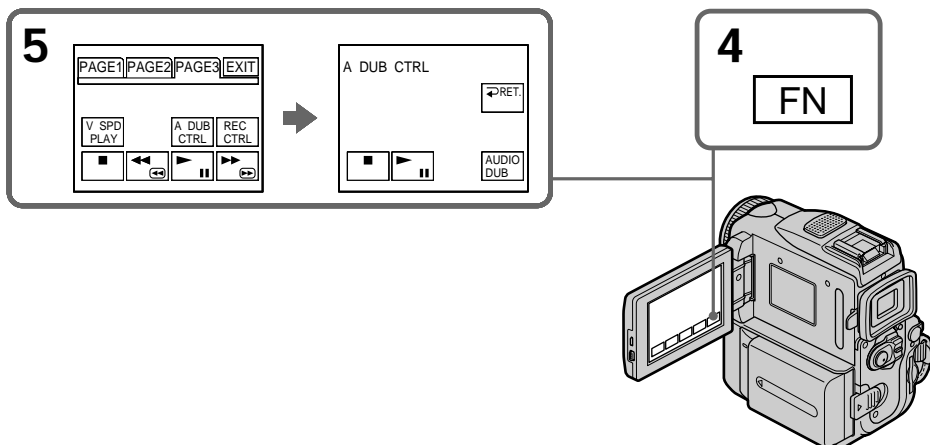

To add new sound more precisely

Press ZERO SET MEMORY at the point where you want to stop recording later in playback.

Carry out step 3. Recording automatically stops at the point where ZERO SET MEMORY was pressed.

Monitoring the new recorded sound

- (1) Play back the tape on which you added audio.
- (2) Select AUDIO MIX in  in the menu settings, then press EXEC (p. 187).

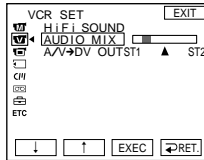

- (3) Press ↓/↑ to adjust the balance between the original sound (ST1) and the new sound (ST2), then press EXEC.

About five minutes after you disconnect the power source or remove the battery pack, the setting of AUDIO MIX returns to the original sound (ST1) only. The default setting is original sound only.

Notes

- New sound cannot be recorded on a tape already recorded in the 16-bit mode (32 kHz, 44.1 kHz or 48 kHz) (p. 190).
- New sound cannot be recorded on a tape already recorded in the LP mode.
- You cannot add audio with the  DV Interface.
- New sound cannot be recorded on blank portions of the tape.

If the i.LINK cable (optional) is connected to your camcorder

You cannot add new sound to a recorded tape.

We recommend that you add new sound on a tape recorded with your camcorder

If you add new sound on a tape recorded with another camcorder (including other DCR-PC101), the sound quality may become worse.

If you set the write-protect tab of the tape to lock

You cannot record on a tape. Slide the write-protect tab to release the write protection.

Superimposing a title

CM
only

If you use a tape with cassette memory, you can superimpose the title. When you play back the tape, the title is displayed for about five seconds from the point where you superimposed it.



- (1) In standby, recording, playback or playback pause, press FN to display PAGE1.
- (2) Press MENU, then select TITLE in $\overline{\text{CM}}$, then press EXEC. (p. 190)
- (3) Press \downarrow/\uparrow to select $\overline{\text{CM}}$, and then press EXEC.
- (4) Press \downarrow/\uparrow to select a desired title, and then press EXEC. The title is displayed on the LCD screen.
- (5) If necessary, change the color, size, or position by pressing COLOR, SIZE, POS \downarrow or POS \uparrow .
- (6) Press TITLE OK.
- (7) Press SAVE TITLE.

In playback, playback pause or recording:

The TITLE SAVE indicator appears on the screen for about five seconds and the title is set.

In standby:

The TITLE indicator appears. And when you press START/STOP to start recording, TITLE SAVE appears on the screen for about five seconds and the title is set.

1

FN

2

↓

↑

➡

EXEC

CM SET [EXIT]

TITLE

TITLE ERASE

TITLE DSPL

CM SEARCH

TAPE TITLE

ERASE ALL

ETC

CM SET [EXIT]

TITLE READY

TITLE ERASE

TITLE DSPL

CM SEARCH

TAPE TITLE

ERASE ALL

ETC

3

↓

↑

➡

EXEC

PRESET TITLE [EXIT]

HELLO!

HAPPY BIRTHDAY

HAPPY HOLIDAYS

CONGRATULATIONS!

OUR SWEET BABY

WEDDING

VACATION

THE END

PRESET TITLE [EXIT]

HELLO!

HAPPY BIRTHDAY

HAPPY HOLIDAYS

CONGRATULATIONS!

OUR SWEET BABY

WEDDING

VACATION

THE END

4~6

↓

↑

➡

EXEC

PRESET TITLE [EXIT]

HELLO!

HAPPY BIRTHDAY

HAPPY HOLIDAYS

CONGRATULATIONS!

OUR SWEET BABY

WEDDING

VACATION

THE END

TITLE [RET.] [EXIT]

OK

VACATION

COLOR SIZE POS ↓ POS ↑

Superimposing a title

If you set the write-protect tab to lock

You cannot superimpose or erase the title. Slide the write-protect tab to release the write protection.

To use the custom title

If you want to use the custom title, select  in step 3.

On a blank portion of the tape

You cannot superimpose a title on the tape.

If the tape has a blank portion in the middle of the recorded parts

The title may not be displayed correctly.

The titles superimposed with your camcorder

- They are displayed only by DV^{Mini} DV format video equipment with index titler function.
- The point you superimposed the title may be detected as an index signal when searching a recording with other video equipment.

If the tape has too many index signals

You may not be able to superimpose a title because the memory is full. In this case, delete data you do not need.

Not to display title

Set TITLE DSPL to OFF in the menu settings (p. 190).

Title setting

- The title color changes as follows:

→ WHITE → YELLOW → VIOLET → RED → CYAN → GREEN → BLUE →

- The title size changes as follows:

SMALL ↔ LARGE

You cannot input 13 characters or more in LARGE size.

- If you select the title size SMALL, you have nine choices for the title position.
If you select the title size LARGE, you have eight choices for the title position.

One cassette can have up to about 20 titles, if one title consists of five characters

However, if the cassette memory is full with date, photo, and cassette label data, one cassette can have only up to about 11 titles with five characters each.

Cassette memory capacity is as follows:

- Six date data (maximum)
- 12 photo data (maximum)
- One cassette label (maximum)

If the “ FULL” mark appears

The cassette memory is full. Erase any titles you do not need.

Superimposing a title

Erasing a title

- (1) Set the POWER switch to CAMERA or VCR.
- (2) Press FN to display PAGE1.
- (3) Press MENU, then select TITLEERASE in $\overline{[M]}$, then press EXEC (p. 190).
- (4) Select the title you want to erase with \downarrow/\uparrow , and then press EXEC. ERASE OK? appears.
- (5) Make sure the title is the one you want to erase, and press OK. ERASING flashes on the screen. When the title is erased, COMPLETE is displayed.

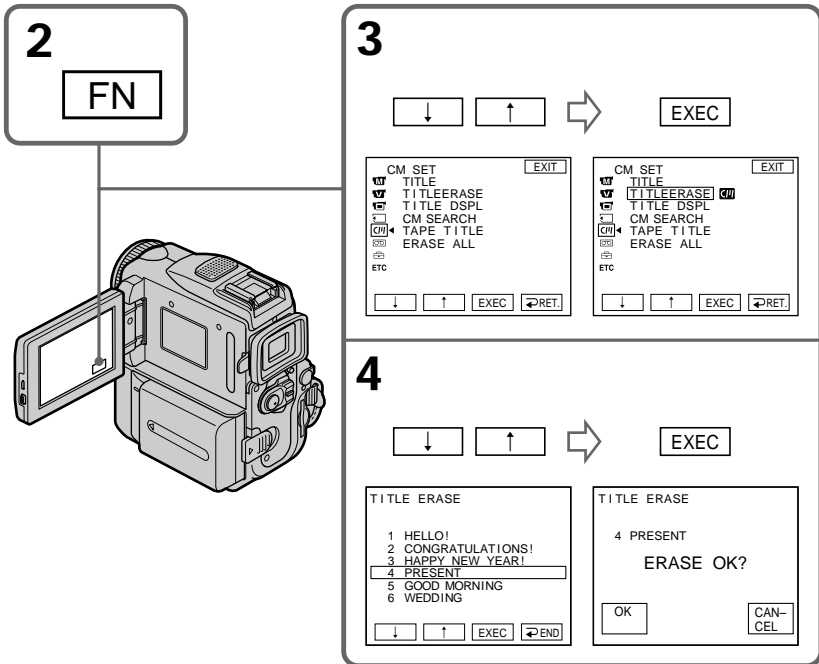

To return to FN



Press EXIT.

To cancel erasing

Press CANCEL in step 5.

Making your own titles

You can make up to two titles and store them in the memory of your camcorder. Each title can have up to 20 characters.

- (1) Set the POWER switch to CAMERA or VCR.
- (2) Press FN to display PAGE1.
- (3) Press MENU, then select TITLE in , then press EXEC (p. 190).
- (4) Select  with ↓/↑, and press EXEC.
- (5) Select CUSTOM1 SET or CUSTOM2 SET with ↓/↑, and press EXEC.
- (6) Select the desired character. Repeat pressing a key to select the desired character on the key.
- (7) Press → to move the cursor for the next character. Repeat the same procedure as step 6 to complete your title.
- (8) Press SET. The title is stored in memory.

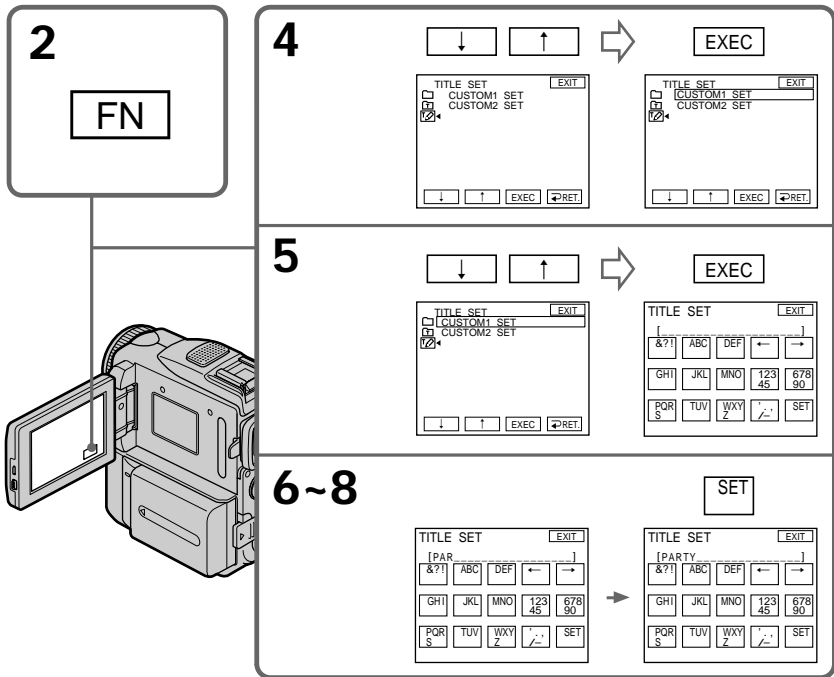

To return to FN

Press EXIT.

To change a title you have stored

In step 5, select CUSTOM1 SET or CUSTOM2 SET, depending on which title you want to change, then press EXEC and enter the new title as desired.

Making your own titles

If you take five minutes or longer to enter characters in tape recording standby while a cassette is in your camcorder

The power automatically goes off. The characters you have entered remain stored in memory. Set the POWER switch to OFF (CHARGE) once and then to CAMERA again, then start again from step 1.

We recommend setting the POWER switch to VCR or removing the cassette so that your camcorder does not automatically turn off while you are entering title characters.

To erase the title

Press ←. The last character is erased.

To enter a space

Press →.

To enter the same character on the same button in succession

Press → to move the cursor to the next position, and enter the character.

Labeling a cassette

CM
only

If you use a cassette with cassette memory, you can label a cassette. The label can consist of up to 10 characters and is stored in cassette memory. When you insert the labeled cassette and set the POWER switch to CAMERA or VCR, the label is displayed for about five seconds.

- (1) Insert the cassette you want to label.
- (2) Set the POWER switch to CAMERA or VCR.
- (3) Press FN to display PAGE1.
- (4) Press MENU, then select TAPE TITLE in , then press EXEC (p. 190).
- (5) Select a desired character. Repeat pressing a key to select the desired character on the key.
- (6) Press → to move the cursor for the next character. Repeat the same procedure as step 5 to complete the label.
- (7) Press SET. The label is stored in memory.

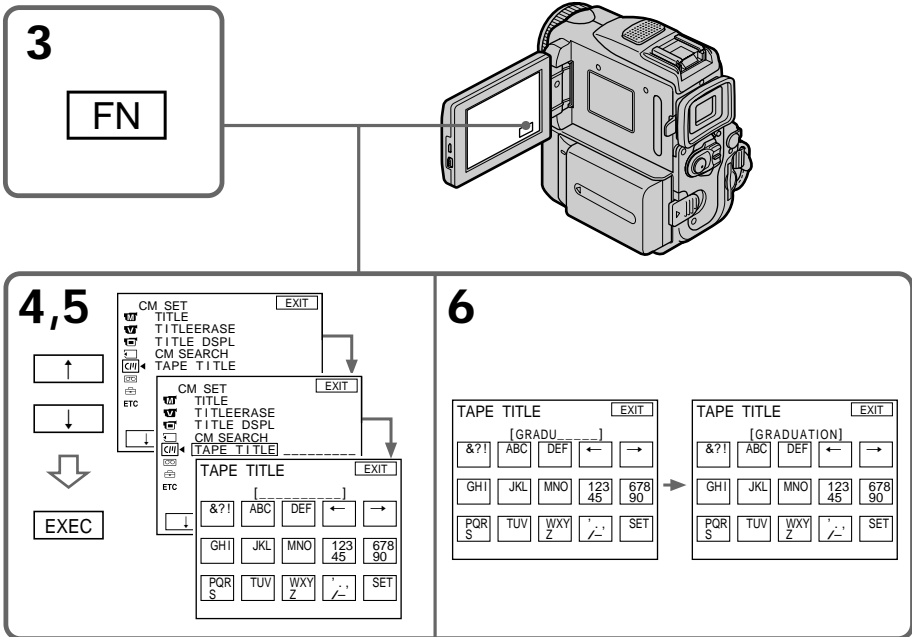

3

FN

4,5

CM SET [EXIT]
TITLE
TITLE ERASE
TITLE DSPL
CM SEARCH
TAPE TITLE

CM SET [EXIT]
TITLE
TITLE ERASE
TITLE DSPL
CM SEARCH
TAPE TITLE

TAPE TITLE [EXIT]
[&?!] [ABC] [DEF] [←] [→]
[GHI] [JKL] [MNO] [123] [678]
[PQR] [STU] [WXY] [./:] [SET]

6

TAPE TITLE [EXIT]
[GRADU] [←] [→]
[&?!] [ABC] [DEF] [←] [→]
[GHI] [JKL] [MNO] [123] [678]
[PQR] [STU] [WXY] [./:] [SET]

TAPE TITLE [EXIT]
[GRADUATION]
[&?!] [ABC] [DEF] [←] [→]
[GHI] [JKL] [MNO] [123] [678]
[PQR] [STU] [WXY] [./:] [SET]

To return to FN

Press EXIT.

To erase the label you have made

Select ← in step 5, and press SET.

To change the label you have made

Insert the cassette to change the label, and operate in the same way to make a new label.

Labeling a cassette

If you set the write-protect tab to lock

You cannot label the cassette. Slide the write-protect tab to release the write protection.

If the cassette has too many index signals

You may not be able to label a cassette because the memory is full. In this case, delete data you do not need.

If you have superimposed titles in the cassette

When the label is displayed, up to four titles also appear.

When the "-----" indicator has fewer than 10 spaces

The cassette memory is full.

The "-----" indicates the number of characters you can select for the label.

To erase the title

Press ←. The last character is erased.

To enter a space

Press →.

To enter the same character on the same button in succession

Press → to move the cursor to the next position, and enter the character.

Erasing all the data in cassette memory

You can erase all the data in cassette memory at once.

- (1) Set the POWER switch to CAMERA or VCR.
- (2) Press FN to display PAGE1.
- (3) Press MENU, then select ERASE ALL in , then press EXEC (p. 190).
- (4) Select OK with ↓/↑, then press EXEC.
OK changes to EXECUTE.
- (5) Select EXECUTE with ↓/↑, and then press EXEC. ERASING flashes on the screen. Once deleting is completed, COMPLETE is displayed.

To return to FN

Press EXIT.

To cancel deleting

Select RETURN in step 5, then press EXEC.

Using a “Memory Stick” – Introduction

You can record and play back images on a “Memory Stick” supplied with your camcorder. You can easily play back, record or delete images. You can exchange image data with other equipment such as your computer etc., using the USB cable for “Memory Stick” supplied with your camcorder.

File format

Still image (JPEG)

Your camcorder compresses image data in JPEG format (extension .jpg).

Moving picture (MPEG)

Your camcorder compresses picture data in MPEG format (extension .mpg).

Typical image data file name

Still image

100-0001: This file name appears on the screen of your camcorder.

Dsc00001.jpg: This file name appears on the display of your computer.

Moving picture

MOV00001: This file name appears on the screen of your camcorder.

Mov00001.mpg: This file name appears on the display of your computer.

Using a “Memory Stick”

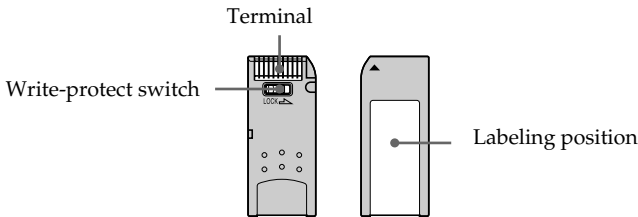

- You cannot record or erase images when the write-protect switch on the “Memory Stick” is set to LOCK.
- The position and shape of the write-protect switch may be different depending on the model.
- We recommend backing up important data on the hard disk of your computer.
- Image data may be damaged in the following cases:
 - If you remove the “Memory Stick”, turn the power off or detach the battery for replacement when the access lamp is flashing.
 - If you use “Memory Stick”s near magnets or magnetic fields such as those of speakers and televisions.
- Prevent metallic objects or your finger from coming into contact with the metal parts of the connecting section.
- Stick its label on the labeling position.
- Do not bend, drop or apply strong shock to “Memory Stick”s.
- Do not disassemble or modify “Memory Stick”s.
- Do not let “Memory Stick”s get wet.
- Do not use or keep “Memory Stick”s in locations that are:
 - Extremely hot such as in a car parked in the sun or under the scorching sun
 - Under direct sunlight
 - Very humid or subject to corrosive gases
- When you carry or store a “Memory Stick”, put it in its case.

Using a “Memory Stick” – Introduction

“Memory Stick”s formatted by a computer

“Memory Stick”s formatted by Windows OS or Macintosh computers do not have a guaranteed compatibility with this camcorder.

Notes on image data compatibility

- Image data files recorded on “Memory Stick”s by your camcorder conform with the Design Rules for Camera File Systems universal standard established by the JEITA (Japan Electronics and Information Technology Industries Association).
On your camcorder, you cannot play back still images recorded on other equipment (DCR-TRV890E/TRV900/TRV900E or DSC-D700/D770) that does not conform to this universal standard. (These models are not sold in some areas.)
- If you cannot use the “Memory Stick” that is used with other equipment, format it with this camcorder (p. 189). Note that formatting erases all information on the “Memory Stick.”

-
- “Memory Stick” and  are trademarks of Sony Corporation.
 - All other product names mentioned herein may be the trademarks or registered trademarks of their respective companies.
- Furthermore, “™” and “®” are not mentioned in each case in this manual.

Using a "Memory Stick" – Introduction

Inserting a "Memory Stick"

Insert a "Memory Stick" in the "Memory Stick" slot as far as it can go with the ► mark facing up as illustrated.

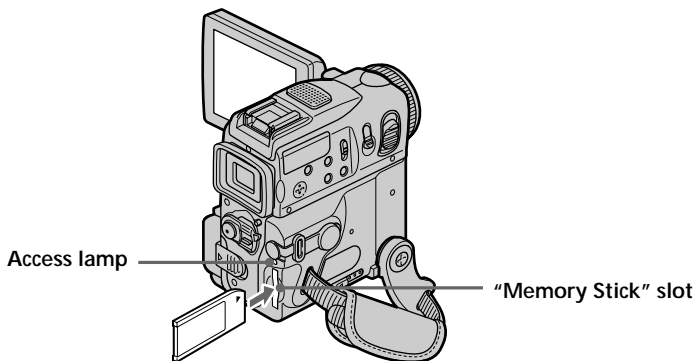

Ejecting a "Memory Stick"

Slide MEMORY EJECT in the direction of the arrow.

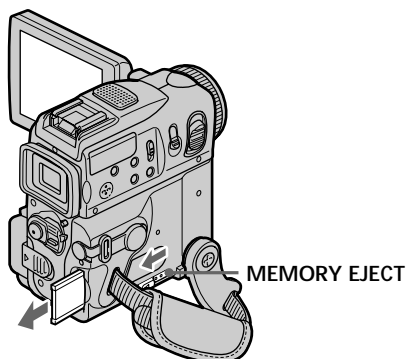

While the access lamp is lit or flashing

Do not shake or strike your camcorder because your camcorder is reading the data from the "Memory Stick" or recording the data on the "Memory Stick." Do not turn the power off, eject a "Memory Stick" or remove the battery pack. Otherwise, image data breakdown may occur.

If "FORMAT ERROR" is displayed

Reinsert "Memory Stick" a few times. The "Memory Stick" may be damaged if the indicator is still displayed. If this occurs, use another "Memory Stick."

Using a "Memory Stick" – Introduction

Using a touch panel

Operation buttons for most functions using a "Memory Stick" are displayed on the LCD screen. Press the LCD panel directly to operate each function. (Touch panel operation)

- (1) Set the POWER switch to MEMORY. Make sure that the LOCK switch is set to the right (unlock) position.
- (2) Press OPEN to open the LCD panel. Operation buttons appear on the LCD screen. You can switch the memory playback or memory camera mode by pressing PLAY/CAM.
- (3) Press FN. Operation buttons appear on the LCD screen.
- (4) Press PAGE2 to go to PAGE2. Operation buttons appear on the LCD screen.
- (5) Press PAGE3 to go to PAGE3. Operation buttons appear on the LCD screen.
- (6) Press a desired operation item.
See relevant pages for each function.

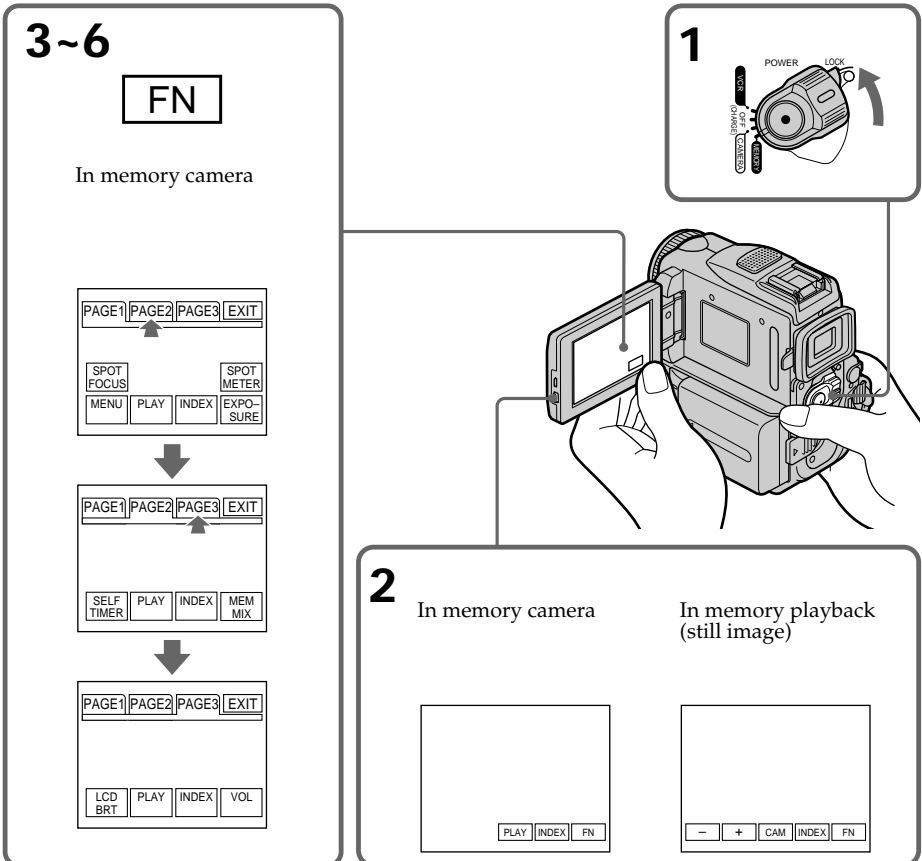

Using a “Memory Stick” – Introduction

To return to FN

Press EXIT.

To execute settings

Press  OK.

To cancel settings

Press  OFF to return to PAGE1/PAGE2/PAGE3.

Notes

- When using the touch panel, press operation buttons with your thumb supporting the LCD screen from the back side of it or press those buttons lightly with your index finger.
- Do not press them with sharp-pointed objects such as a pen.
- Do not touch the LCD screen with wet hands.
- If FN is not on the LCD screen, touch the LCD screen lightly to make it appear. You can control the display with DISPLAY/TOUCH PANEL on your camcorder.
- When operation buttons do not work even if you press them, an adjustment is required (CALIBRATION) (p. 211).
- When the LCD screen gets dirty, use the supplied cleaning cloth.

When executing each item

The green bar appears above the item.

If the items are not available

The color of the items changes to gray.

Touch panel







You can operate with the touch panel using the viewfinder (p. 70).

Press FN to display the following buttons:

In memory camera

PAGE1	SPOT FOCUS, MENU, PLAY, INDEX, EXPOSURE, SPOT METER
PAGE2	SELFTIMER, PLAY, INDEX, MEM MIX
PAGE3	LCD BRT, PLAY, INDEX, VOL

In memory playback

PAGE1	MENU, CAM, INDEX, DELETE,  , 
PAGE2	PB ZOOM, CAM, INDEX, DATA CODE,  , 
PAGE3	LCD BRT, CAM, INDEX, VOL,  , 

Using a "Memory Stick" – Introduction

Selecting still image quality mode

You can select the image quality mode in still image recording. The default setting is SUPER FINE.

- (1) Set the POWER switch to MEMORY or VCR. Make sure that the LOCK switch is set to the right (unlock) position.
- (2) Press FN to display PAGE1.
- (3) Press MENU, then select STILL SET in , then press EXEC (p. 188).
- (4) Press ↓/↑ to select QUALITY, then press EXEC.
- (5) Press ↓/↑ to select a desired image quality, then press EXEC.

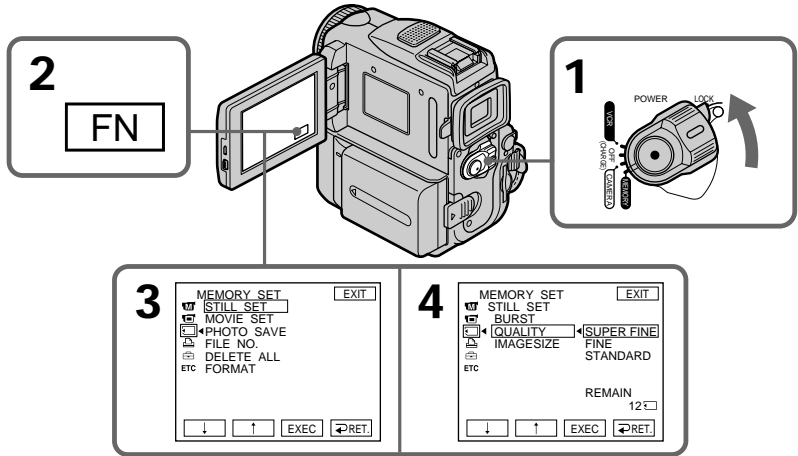

To return to FN
Press EXIT.

Image quality settings

Setting	Meaning
SUPER FINE (SFN)	This is the highest image quality in your camcorder. The number of still images you can record is less than in FINE mode. Super fine images are compressed to about 1/3.
FINE (FINE)	Use this mode when you want to record high quality images. Fine images are compressed to about 1/6.
STANDARD (STD)	This is the standard image quality. Standard images compressed to about 1/10.

Note

In some cases, changing the image quality mode may not affect the image quality, depending on the type of images you are shooting.

Using a “Memory Stick” – Introduction

Differences in image quality mode

Recorded images are compressed in JPEG format before being stored in memory. The memory capacity allocated to each image varies depending on the selected image quality mode and image size. Details are shown in the table below. (You can select 1152 × 864 or 640 × 480 image size in the menu settings.)

1152 × 864 image size

Image quality	Memory capacity
SUPER FINE	About 600 KB
FINE	About 300 KB
STANDARD	About 200 KB

640 × 480 image size

Image quality	Memory capacity
SUPER FINE	About 190 KB
FINE	About 100 KB
STANDARD	About 60 KB

Image quality mode indicator

The image quality mode indicator is not displayed during playback.

When you select image quality

The number of images you can shoot in the currently selected image quality appears on the screen.

Using a "Memory Stick" – Introduction

Selecting the image size

You can select either of two image sizes

Still images: 1152 × 864 or 640 × 480 (When the POWER switch is set to CAMERA or VCR, the image size is automatically set to 640 × 480.)

The default setting is 1152 × 864.

Moving pictures: 320 × 240 or 160 × 112

The default setting is 320 × 240.

- (1) Set the POWER switch to MEMORY. Make sure that the LOCK switch is set to the right (unlock) position.
- (2) Press FN to display PAGE1.
- (3) Press MENU, then select STILL SET (still image) or MOVIE SET (moving picture) in , then press EXEC (p. 188).
- (4) Press ↓/↑ to select IMAGESIZE, then press EXEC.
- (5) Press ↓/↑ to select the desired image size, then press EXEC.

The indicator changes as follows:

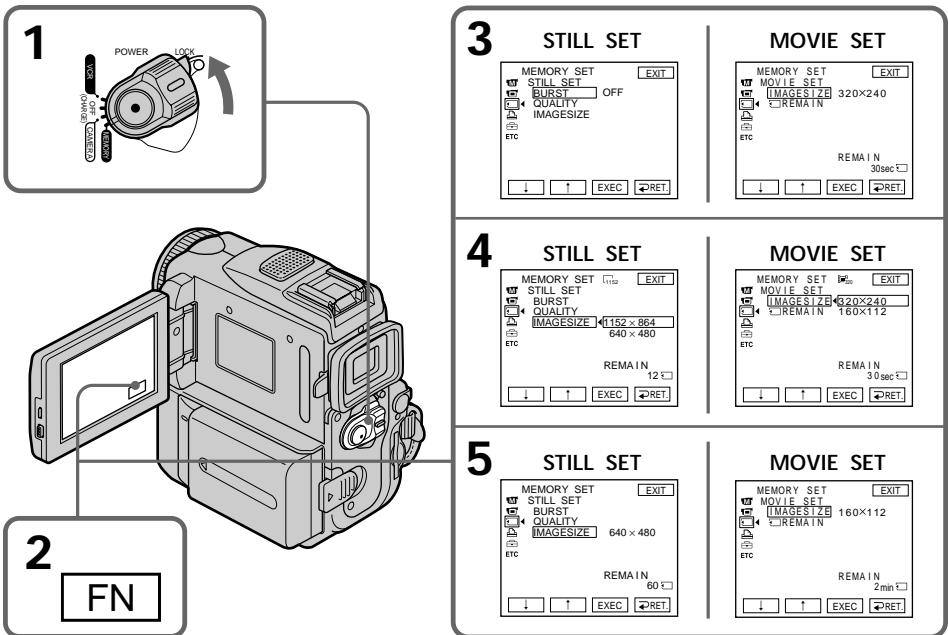
1

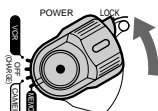

2

FN

3

STILL SET	MOVIE SET
MEMORY SET [EXIT]	MEMORY SET [EXIT]
STILL SET	MOVIE SET
BURST OFF	IMAGESIZE 320×240
QUALITY	REMAIN
IMAGESIZE	
etc	REMAIN 30sec
[↓] [↑] [EXEC] [PRET]	[↓] [↑] [EXEC] [PRET]

4

STILL SET	MOVIE SET
MEMORY SET [EXIT]	MEMORY SET [EXIT]
STILL SET	MOVIE SET
BURST	IMAGESIZE 320×240
QUALITY	REMAIN 160×112
IMAGESIZE 1152 × 864	
640 × 480	
REMAIN 12	REMAIN 30sec
[↓] [↑] [EXEC] [PRET]	[↓] [↑] [EXEC] [PRET]





5

STILL SET	MOVIE SET
MEMORY SET [EXIT]	MEMORY SET [EXIT]
STILL SET	MOVIE SET
BURST	IMAGESIZE 160×112
QUALITY	REMAIN
IMAGESIZE 640 × 480	
etc	REMAIN 2min
[↓] [↑] [EXEC] [PRET]	[↓] [↑] [EXEC] [PRET]

120

Using a “Memory Stick” – Introduction

Image size settings

Setting	Meaning	Indicator
1152 × 864	Records 1152 × 864 still images.	
640 × 480	Records 640 × 480 still images.	
320 × 240	Records 320 × 240 moving pictures.	
160 × 112	Records 160 × 112 moving pictures.	

Approximate number of still images you can record on a “Memory Stick”

The number of images you can record varies depending on which image quality mode you select and the complexity of the subject.

Image quality	Image size	Type of “Memory Stick”s				
		8MB (supplied)	16MB (optional)	32MB (optional)	64MB (optional)	128MB (optional)
SUPER FINE	1152 × 864	12 images	25 images	51 images	100 images	205 images
	640 × 480	40 images	80 images	160 images	325 images	650 images
FINE	1152 × 864	25 images	50 images	100 images	205 images	415 images
	640 × 480	80 images	160 images	325 images	650 images	1310 images
STANDARD	1152 × 864	37 images	74 images	150 images	300 images	600 images
	640 × 480	120 images	240 images	485 images	980 images	1970 images

Note

If you record a 1152 × 864 still image with your camcorder and attempt to play back the date file on another device that does not support this image size, a part of the image might not be displayed or the image might be displayed in a small size in the center of the screen.

Approximate time of moving pictures you can record on a “Memory Stick”

The time of moving pictures you can record varies depending on which image size you select and the complexity of the subject.

Image size	Type of “Memory Stick”s				
	8MB (supplied)	16MB (optional)	32MB (optional)	64MB (optional)	128MB (optional)
320 × 240	1 min. 20 sec.	2 min. 40 sec.	5 min. 20 sec.	10 min. 40 sec.	21 min. 20 sec.
	5 min. 20 sec.	10 min. 40 sec.	21 min. 20 sec.	42 min. 40 sec.	85 min. 20 sec.

The table above shows approximate number of still images and time of moving pictures you can record on a “Memory Stick” formatted by your camcorder.

Recording still images on “Memory Stick”s – Memory photo recording

You can record still images on “Memory Stick”s.

Before operation

Insert a “Memory Stick” into your camcorder.

- (1) Set the POWER switch to MEMORY. Make sure that the LOCK switch is set to the right (unlock) position.
- (2) Keep pressing PHOTO lightly. The green ● mark stops flashing, then lights up. The brightness of the image and the focus are adjusted and fixed while your camcorder targets at the middle of the image. Recording does not start yet.
- (3) Press PHOTO deeper. Recording is complete when the bar scroll indicator disappears.
The image displayed on the screen when you pressed PHOTO deeper will be recorded on the “Memory Stick.”

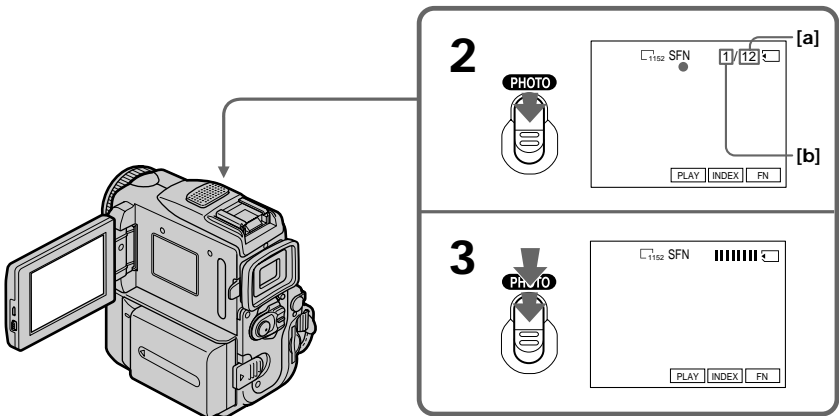

[a]: Approximate number of images can be recorded on the “Memory Stick”

[b]: Number of recorded images

Recording still images on “Memory Stick”s – Memory photo recording

You can record still images on “Memory Stick”s in tape recording or tape recording standby

For the details, see page 44.

When the POWER switch is set to MEMORY

The following functions do not work:

- Wide mode
- Digital zoom
- SteadyShot function
- Super NightShot
- Color Slow Shutter
- Fader
- Picture effect
- Digital effect
- Title
- SPORTS of PROGRAM AE (The indicator flashes.)

While you are recording a still image

You cannot turn off the power or press PHOTO.

When you press PHOTO on the Remote Commander

Your camcorder immediately records the image that is on the screen when you press the button.

When you press PHOTO lightly in step 2

The image momentarily flickers. This is not a malfunction.

Recording data

The recording data (date/time or various settings when recorded) are not displayed while recording. However, they are recorded automatically onto the “Memory Stick.” To display the recording data, press DATA CODE during playback. You can also use the Remote Commander for this operation (p. 39).

If you record still images when the POWER switch is set to MEMORY

The angle of view is slightly larger compared with the angle of view when the POWER switch is set to CAMERA.

Recording still images on “Memory Stick”s - Memory photo recording

Recording images continuously

You can record still images continuously. Before recording, select one of the three modes described below in the menu settings.

NORMAL [a]

Your camcorder shoots up to four still images in 1152 × 864 size or 13 still images in 640 × 480 size at about 0.5 sec intervals. ()

EXP BRKTG

Your camcorder automatically shoots three images at about 0.5 sec intervals at different exposures. ()

MULTI SCRN [b]

Your camcorder shoots nine still images at about 0.4 sec intervals and displays the images on a single page divided into nine boxes. Still images are recorded in 640 × 480 size. ()

[a]



[b]



Recording still images on "Memory Stick"s - Memory photo recording

- (1) Set the POWER switch to MEMORY. Make sure that the LOCK switch is set to the right (unlock) position.
- (2) Press FN to display PAGE1.
- (3) Press MENU, then select STILL SET in , then press EXEC (p. 188).
- (4) Press ↓/↑ to select BURST, then press EXEC.
- (5) Press ↓/↑ to select a desired setting, then press EXEC.
- (6) Press EXIT to make the menu settings disappear.
- (7) Press PHOTO deeper.

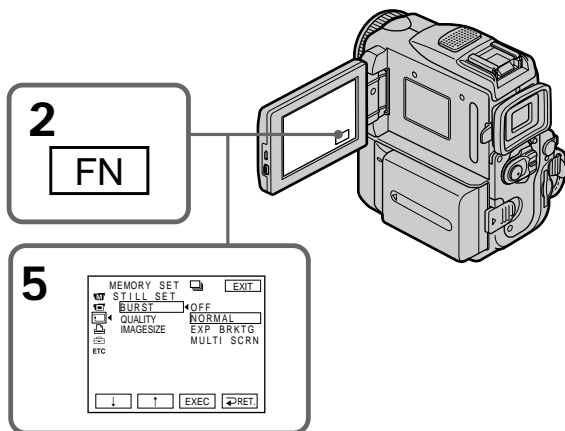

If the "Memory Stick" becomes full

" FULL" appears on the screen, and you cannot record still images on this "Memory Stick."

The number of still images in continuous shooting

The number of still images you can shoot continuously varies depending on the image size and the capacity of the "Memory Stick."

During continuous recording of images

The flash (optional) does not work.

When shooting with the self-timer or the Remote Commander

Your camcorder automatically records up to the maximum number of still images.

If remaining capacity on the "Memory Stick" is less than for three images

EXP BRKTG does not work. " FULL" is displayed when you press PHOTO.

The effect of EXP BRKTG

The effect of EXP BRKTG may not be noticeable on the LCD screen.

We recommend viewing images on TV or the computer to recognize the effect.

When selecting NORMAL

Recording continues up to the maximum number of still images during pressing PHOTO deeper. Release PHOTO to stop recording.

Recording still images on “Memory Stick”s – Memory photo recording

Self-timer memory photo recording

You can record images on “Memory Stick”s with the self-timer. You can also use the Remote Commander for this operation.

- (1) Set the POWER switch to MEMORY. Make sure that the LOCK switch is set to the right (unlock) position.
- (2) Press FN and select PAGE2.
- (3) Press SELFTIMER in standby.
The  (self-timer) indicator appears on the screen.
- (4) Press PHOTO deeper.
The self-timer starts counting down from 10 with a beep sound. In the last two seconds of the countdown, the beep sound gets faster, then recording starts automatically.

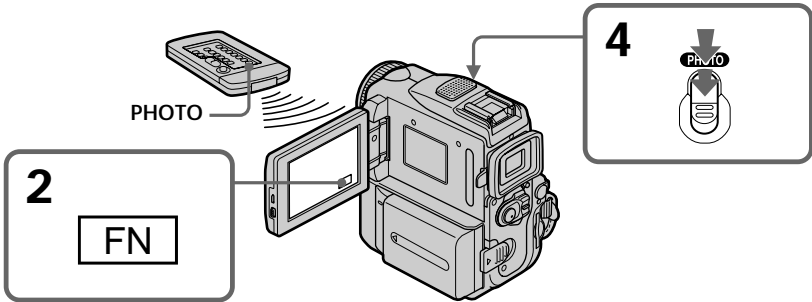

To cancel self-timer recording

Press SELFTIMER so that the  (self-timer) indicator disappears from the screen. You cannot cancel self-timer recording using the Remote Commander.

Note

Self-timer recording is automatically canceled when:

- Self-timer recording is finished.
- The POWER switch is set to OFF (CHARGE) or VCR.

Recording an image from a tape as a still image

Your camcorder can read moving picture data recorded on a tape and record it as a still image on a "Memory Stick."

Your camcorder can also take in moving picture data through the input connector and record it as a still image on a "Memory Stick."

Before operation

- Insert a recorded tape into your camcorder.
- Insert a "Memory Stick" into your camcorder.

- (1) Set the POWER switch to VCR.
- (2) Press . The picture recorded on the tape is played back.
- (3) Keep pressing PHOTO lightly until the picture from the tape freezes. CAPTURE appears on the screen. Recording does not start yet.
To change the still image, release PHOTO, select a still image again, and then press and hold PHOTO lightly.
- (4) Press PHOTO deeper. Recording is complete when the bar scroll indicator disappears. The image displayed on the screen when you pressed PHOTO deeper will be recorded on the "Memory Stick."

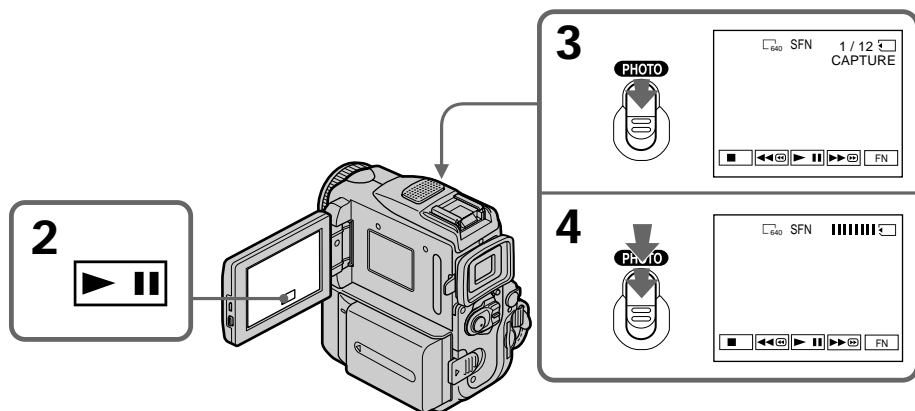

Image size of still images

Image size is automatically set to 640 × 480.

When the access lamp is lit or flashing

Do not shake or strike the unit. As well do not turn the power off, eject a "Memory Stick" or remove the battery pack. Otherwise, the image data breakdown may occur.

If "" appears on the screen

The inserted "Memory Stick" is incompatible with your camcorder because its format does not conform with your camcorder. Check the format of the "Memory Stick."

Recording an image from a tape as a still image

If you press PHOTO lightly in playback

The cassette stops momentarily.

Sound recorded on a tape

You cannot record audio from a tape.

Titles which have already been recorded on tapes

You cannot record the titles on "Memory Stick"s. The title does not appear while you are recording a still image with PHOTO.

Recording date/time

The date/time when it is recorded on a "Memory Stick" is recorded. Various settings are not recorded.

When you press PHOTO on the Remote Commander

Your camcorder immediately records the image that is on the screen when you press the button.

Recording an image from a tape as a still image

Recording a still image from other equipment

Before operation

Set DISPLAY to LCD in the menu settings. (The default setting is LCD.)

- (1) Set the POWER switch to VCR.
- (2) Play back the recorded tape, or turn the TV on to see the desired program.
The image of the other equipment is displayed on the LCD screen or in the viewfinder.
- (3) At the point where you want to record, follow the steps 3 and 4 on page 127.

Using the A/V connecting cable

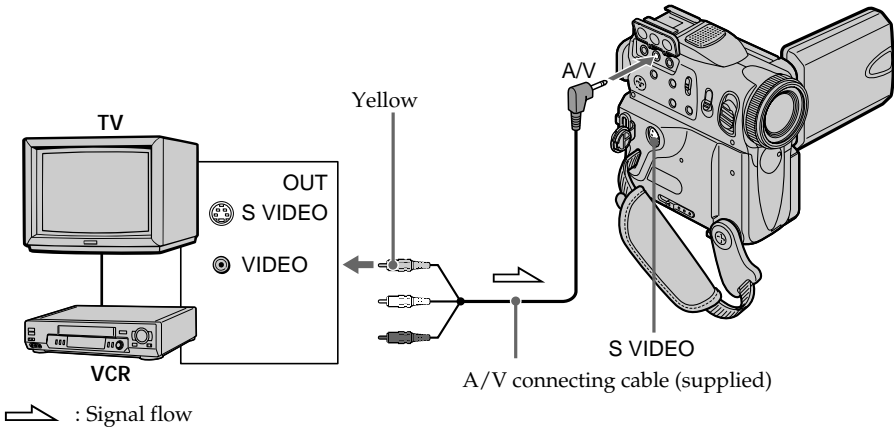

Connect the yellow plug of the A/V connecting cable to the video jack on the VCR or the TV.

If your TV or VCR has an S VIDEO jack

Pictures can be reproduced more faithfully by using an S video cable (optional).

With this connection, you do not need to connect the yellow (video) plug of the A/V connecting cable.

Connect an S video cable (optional) to the S video jacks of both your camcorder and the TV or VCR.

This connection produces higher quality DV format pictures.

Recording an image from a tape as a still image

Using the i.LINK cable

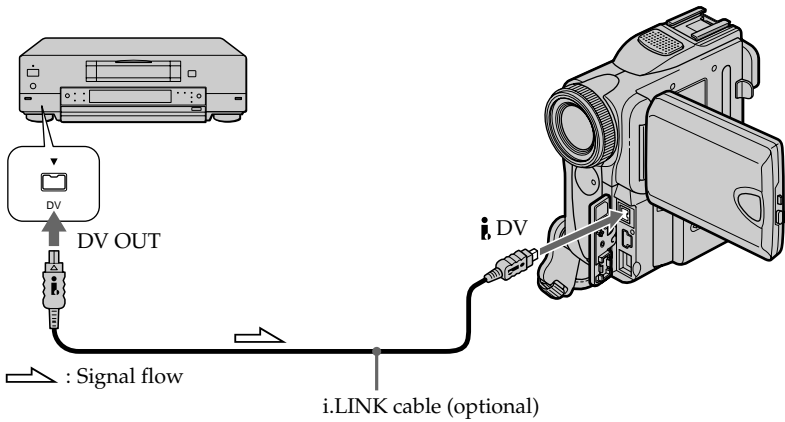

Note

In the following instances “ REC ERROR” appears and recording cannot be carried out. Record distortion-free images:

- When recording from a tape in poor condition, for example, a tape worn out from repeated dubbing.
- When attempting to input images distorted by radio wave interference, emanating from a TV tuner, radio set, etc.

Superimposing a still image in the “Memory Stick” on an image – MEMORY MIX

You can superimpose a still image you have recorded on a “Memory Stick” on top of the moving picture you are recording. You can record the superimposed images on a tape or a “Memory Stick.” (However, you can record only superimposed still images on the “Memory Stick.”)

M. CHROM (Memory Chromakey)

You can swap only the blue area of a still image such as an illustration or a frame with a moving picture.

M. LUMI (Memory Luminancekey)

You can swap the brighter area of a still image (such as a handwritten illustration or a title) with a moving picture. To use this function, we recommend recording a title on a “Memory Stick” before a trip or event.

C. CHROM (Camera Chromakey)

You can superimpose a moving picture on top of a still image such as an image which can be used as background. Shoot the subject against a blue background. Only the blue area of the moving picture will be swapped with a still image.

M. OVERLAP* (Memory Overlap)

You can make a moving picture fade in on top of a still image.

M. CHROM

M←CAM
CHROM

Still image



Blue

+

Moving picture



➔



M. LUMI

M←CAM
LUMI

Still image



+

Moving picture



➔



C. CHROM

CAM←M
CHROM

Still image

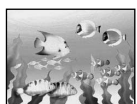

+

Moving picture



➔

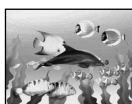

Blue

M. OVERLAP*

OVER-
LAP

Still image



➔



➔



Moving picture

* The superimposed image using Memory overlap function can be recorded on tapes only.

Superimposing a still image in the “Memory Stick” on an image - MEMORY MIX

Recording a superimposed image to tape

Before operation

- Insert a tape for recording into your camcorder.
- Insert a “Memory Stick” recorded with still images into your camcorder.

- (1) Set the POWER switch to CAMERA.
- (2) In standby, press FN and select PAGE2.
- (3) Press MEM MIX. The last image recorded on the “Memory Stick” appears on the right lower part of the screen.
- (4) Press -/+ on the right lower corner of the screen to select the still image which you want to superimpose.
 - : to see the previous image
 - +: to see the next image
- (5) Press a desired mode. The still image is superimposed on the moving picture.
- (6) Press -/+ on the left lower corner of the screen to adjust the effect, then press  OK to return to PAGE2.

- M. CHROM – The color (blue) scheme of the area in the still image which is to be swapped with a moving image
- M. LUMI – The color (bright) scheme of the area in the still image which is to be swapped with a moving image
- C. CHROM – The color (blue) scheme of the area in the moving image which is to be swapped with a still image
- M. OVERLAP – No adjustment necessary

The fewer bars there are on the screen, the stronger the effect.

- (7) Press EXIT to return to FN.
- (8) Press START/STOP to start recording.

Superimposing a still image in the “Memory Stick” on an image - MEMORY MIX

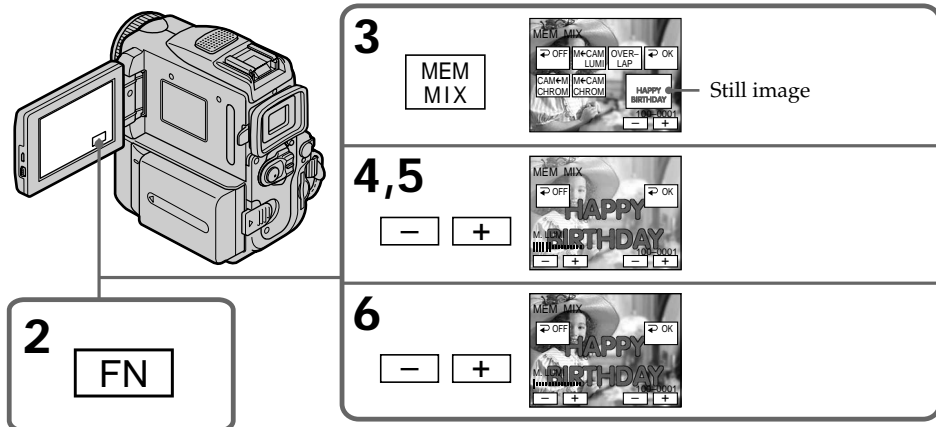

To change the still image to be superimposed

Press -/+ on the right lower corner before step 6.

To cancel MEMORY MIX

Follow the steps 2 and 3 on page 132, then press \rightarrow OFF to return to PAGE2.

Notes

- You cannot use the MEMORY MIX function for moving pictures recorded on “Memory Stick”s.
- When the overlapping still image has a large amount of white, the thumbnail image of the picture may not be clear.
- During recording you cannot reselect the mode setting. Press \rightarrow OFF to return to PAGE2.

Image data modified on your computer or shot with other equipment

You may not be able to play back modified images with your camcorder.

To record a still image on a tape as it is

In the M. LUMI mode press -/+ to increase the bar indicator to the maximum position.

When you select M. OVERLAP

You cannot change the still image or the mode setting.

To record the superimposed image as a still image

Press PHOTO deeper in step 8. (You should set PHOTO REC to TAPE in the menu settings beforehand.)

Superimposing a still image in the “Memory Stick” on an image - MEMORY MIX

Recording a superimposed image to “Memory Stick” as a still image

Before operation

Insert a recorded “Memory Stick” into your camcorder.

- (1) Set the POWER switch to MEMORY.
Make sure that the LOCK switch is set to the right (unlock) position.
- (2) In standby, press FN and select PAGE2.
- (3) Press MEM MIX. The last image recorded on the “Memory Stick” appears on the left corner of the screen.
- (4) Press -/+ on the right lower corner of the screen to select the still image which you want to superimpose.
-: to see the previous image
+: to see the next image
- (5) Press a desired mode. The still image is superimposed on the moving picture.
- (6) Press -/+ on the left lower corner of the screen to adjust the effect, then press  OK to return to PAGE2.

- M. CHROM – The color (blue) scheme of the area in the still image which is to be swapped with a moving image
- M. LUMI – The color (bright) scheme of the area in the still image which is to be swapped with a moving image
- C. CHROM – The color (blue) scheme of the area in the moving image which is to be swapped with a still image

The fewer bars there are on the screen, the stronger the effect.

- (7) Press EXIT to return to FN.
- (8) Press PHOTO deeper to start recording. Recording is complete when the bar scroll indicator disappears. The image displayed on the screen when you pressed PHOTO deeper will be recorded on the “Memory Stick.”

Superimposing a still image in the “Memory Stick” on an image - MEMORY MIX

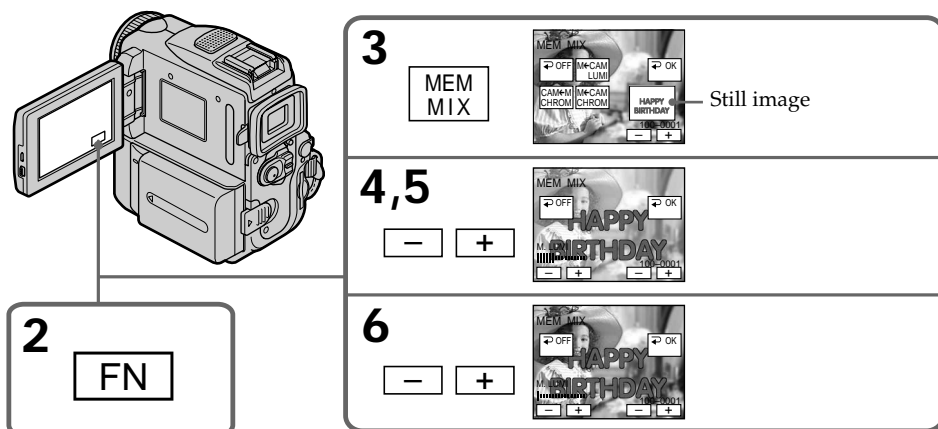

To change the still image to be superimposed

Press -/+ on the right lower corner before step 6.

To cancel MEMORY MIX

Follow the steps 2 and 3 on page 134, then press \rightarrow OFF to return to PAGE2.

Notes

- You cannot use MEMORY MIX function for moving pictures recorded on “Memory Stick”s.
- If the overlapping still image has a large amount of white, the thumbnail image of the picture may not be clear.
- During recording you cannot reselect the mode. Press \rightarrow OFF again to return to PAGE2.

Image size of still images

Image size is automatically set to 640 × 480.

Image data modified with your computers or shot with other equipment

You may not be able to play them back with your camcorder.

When recording images on a “Memory Stick” using MEMORY MIX

The PROGRAM AE does not work. (The indicator flashes.)

The “Memory Stick” supplied with your camcorder stores 20 images:

- For M. CHROM: 18 images (such as a frame) 100-0001~100-0018
- For C. CHROM: two images (such as a background) 100-0019~100-0020

Sample images

Sample images stored in the “Memory Stick” supplied with your camcorder are protected (p. 156).

Recording moving pictures on “Memory Stick”s – MPEG movie recording

You can record moving pictures with sound on “Memory Stick”s. The picture and sound are recorded up to the full capacity of “Memory Stick” (MPEG MOVIE EX).

Before operation

Insert a “Memory Stick” into your camcorder.

- (1) Set the POWER switch to MEMORY. Make sure that the LOCK switch is set to the right (unlock) position.
- (2) Press START/STOP. Your camcorder starts recording. The camera recording lamp located on the front of your camcorder lights up. The picture and sound are recorded up to the capacity of “Memory Stick.” For more information about recording time, see page 121.

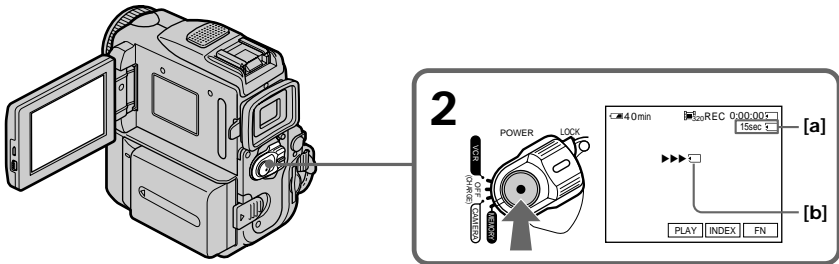

[a]: Available recording time on “Memory Stick” is displayed.

[b]: This indicator is displayed for five seconds after pressing START/STOP. This indicator is not recorded.

To stop recording

Press START/STOP.

Recording moving pictures on “Memory Stick”s – MPEG movie recording

Note

Sound is recorded in monaural.

When the POWER switch is set to MEMORY

The following functions do not work:

- Wide mode
- Digital zoom
- SteadyShot function
- Super NightShot
- Color Slow Shutter
- Fader
- Picture effect
- Digital effect
- Title
- SPORTS of PROGRAM AE (The indicator flashes.)

When using an external flash (optional)

Turn the power of the external flash off when recording moving pictures on “Memory Stick”s.

Otherwise, the charging sound of the flash may be recorded.

Recording date/time

The date/time are not displayed during recording. However, they are automatically recorded onto the “Memory Stick”. To display the recording date/time, press DATA CODE during playback. Various settings cannot be recorded. You can also use the Remote Commander for this operation (p. 39).

During recording on “Memory Stick”

Do not eject the cassette from your camcorder. While ejecting the cassette, sound is not recorded on the “Memory Stick.”

If you record moving pictures when the POWER switch is set to MEMORY

The angle of view is slightly larger compared with the angle of view when the POWER switch is set to CAMERA.

Recording moving pictures on “Memory Stick”s – MPEG movie recording

Self-timer MPEG movie recording

You can record images on “Memory Stick”s with the self-timer. You can also use the Remote Commander for this operation.

- (1) Set the POWER switch to MEMORY. Make sure that the LOCK switch is set to the right (unlock) position.
- (2) Press FN and select PAGE2.
- (3) Press SELFTIMER in standby.
The  (self-timer) indicator appears on the screen.
- (4) Press START/STOP.

Self-timer starts counting down from 10 with a beep. In the last two seconds of the countdown, the beep gets faster, and recording starts automatically.

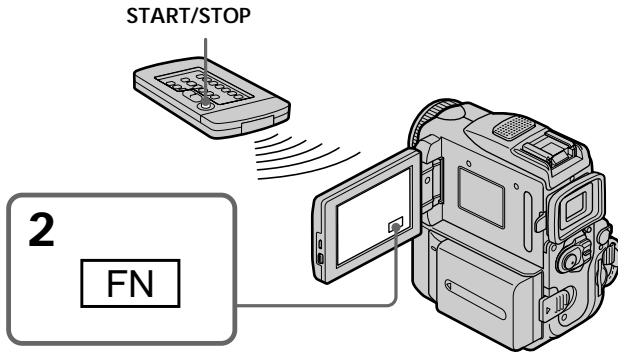

To stop the count down

Press START/STOP.

To restart the countdown, press START/STOP again.

To cancel self-timer recording

Press SELFTIMER so that the  (self-timer) indicator disappears from the screen. You cannot cancel self-timer recording using the Remote Commander.

Note

Self-timer recording is automatically canceled when:



- Self-timer recording is finished.
- The POWER switch is set to OFF (CHARGE) or VCR.

Recording a picture from a tape as a moving picture

Your camcorder can read moving picture data recorded on a tape and record it as a moving picture on a “Memory Stick.” Your camcorder can also take in moving picture data through the input connector and record it as a moving picture on a “Memory Stick.”

Before operation

- Insert a recorded tape into your camcorder.
- Insert a “Memory Stick” into your camcorder.

- (1) Set the POWER switch to VCR.
- (2) Press . The picture recorded on the tape is played back. And press  again to pause playback at the scene where you want to start recording from.
- (3) Press START/STOP. Images and sound are recorded up to the remaining capacity of the “Memory Stick.” For more information about recording time, see page 121.

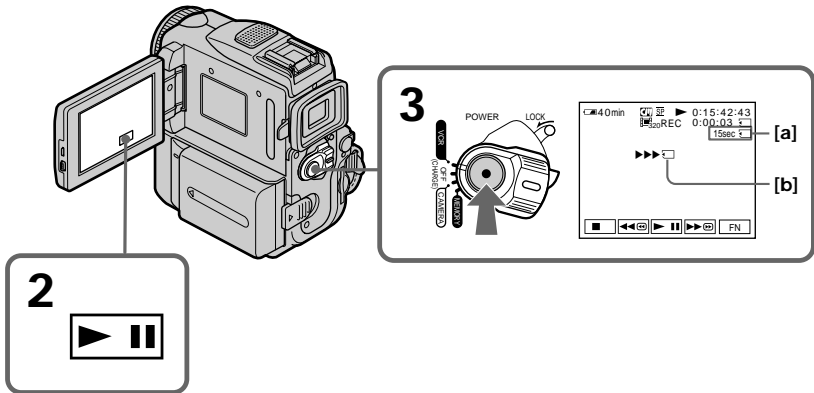

[a]: Available recording time on the “Memory Stick” is displayed.

[b]: This indicator is displayed for five seconds after pressing START/STOP. This indicator is not recorded.

To stop recording

Press START/STOP.

Notes

- Sound recorded in 48 kHz is converted to one in 32 kHz when recording images from a tape to a “Memory Stick.”
- Sound recorded in stereo is converted to monaural sound when recording from a tape.

Recording a picture from a tape as a moving picture

When the access lamp is lit or flashing

Do not shake or strike the unit. As well do not turn the power off, eject a "Memory Stick" or remove the battery pack. Otherwise, the image data breakdown may occur.

Titles have already recorded on tapes

You cannot record the titles on "Memory Stick"s. The title does not appear while you are recording a moving picture with START/STOP.

If "AUDIO ERROR" is displayed

Sound that cannot be recorded by your camcorder has been recorded. Connect the A/V connecting cable to input images played back on an external device (p. 141).

Recording date/time

The date/time when it is recorded on "Memory Stick" is recorded. Various settings are not recorded.

Recording a picture from a tape as a moving picture

Recording a moving picture from other equipment

Before operation

Set DISPLAY to LCD in the menu settings. (The default setting is LCD.)

- (1) Set the POWER switch to VCR.
- (2) Play back the recorded tape, or turn the TV on to see the desired program.
The image of the other equipment is displayed on the LCD screen or in the viewfinder.
- (3) Follow the procedure on page 139 from the step 3 onwards at the point where you want to start recording.

Using the A/V connecting cable

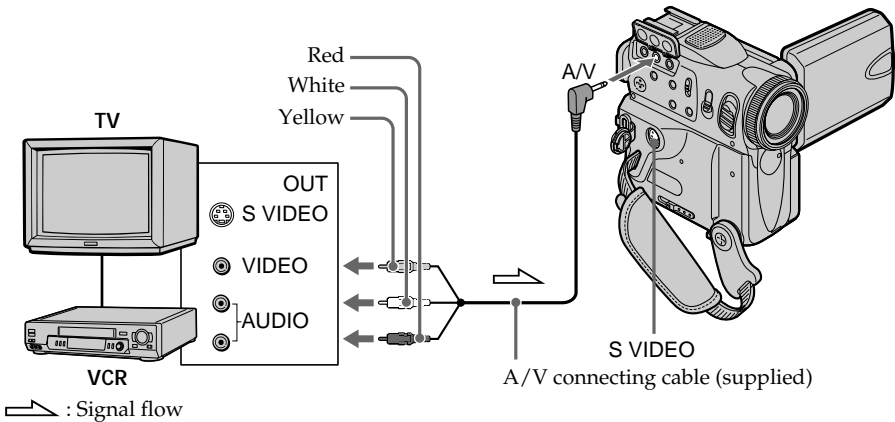

If your VCR is a monaural type

Connect the yellow plug of the A/V connecting cable to the video input jack and the white or the red plug to the audio input jack on the VCR or the TV. When the white plug is connected, the left channel audio is output, and when the red plug is connected, the right channel audio is output.

If your TV or VCR has an S video jack

Pictures can be reproduced more faithfully by using an S video cable (optional). With this connection, you do not need to connect the yellow (video) plug of the A/V connecting cable. Connect an S video cable (optional) to the S video jacks of both your camcorder and the TV or VCR.

Recording a picture from a tape as a moving picture

Using the i.LINK cable

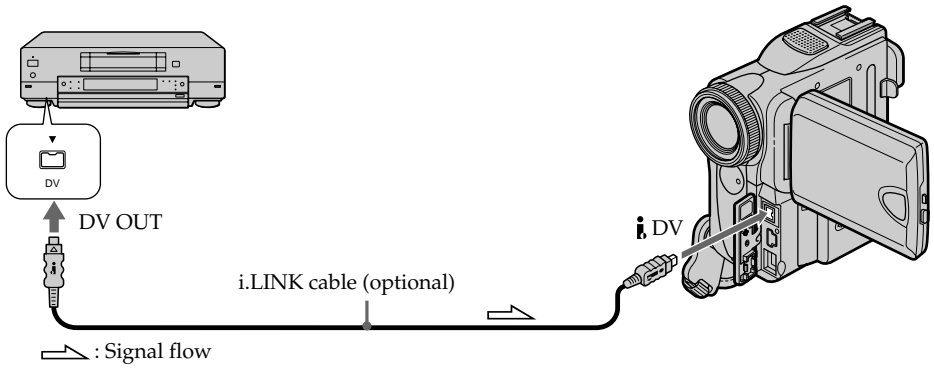

Note

In the following instances " REC ERROR" appears and recording is canceled:

- When recording from a tape in poor condition, for example, a tape worn out from repeated dubbing.
- When attempting to input images distorted by radio wave interference, emanating from a TV tuner, radio set, etc.
- When the input signal is cut off.

Recording edited pictures from a tape as a moving picture - Digital program editing (on "Memory Stick"s)

You can duplicate selected scenes (programs) for editing onto "Memory Stick"s.

Making the program

- (1) Set the POWER switch to VCR.
- (2) Insert the tape for playback, and a "Memory Stick" for recording into your camcorder.
- (3) Press FN to display PAGE1.
- (4) Press MENU, then select VIDEO EDIT in **[ETC]**, then press EXEC (p. 192).
- (5) Press ↓/↑ to select MEMORY, then press EXEC.
- (6) Repeat pressing IMAGESIZE to select the desired size.
- (7) Search for the beginning of the first scene you want to insert, then pause playback.
You can fine-adjust one frame at a time with **[◀◀|>]** / **[|▶▶]**.
- (8) Press MARK IN.
The IN point of the first program is set, and the upper part of the program mark changes to light blue.
- (9) Search for the end of the first scene you want to insert, then pause playback.
You can fine-adjust one frame at a time with **[◀◀|>]** / **[|▶▶]**.
- (10) Press MARK OUT.
The OUT point of the first program is set, then the lower part of the program mark changes to light blue.
- (11) Repeat steps 7 to 10, then set the programs.
When one program is set, the program mark changes to light blue.
You can set 20 programs in maximum.

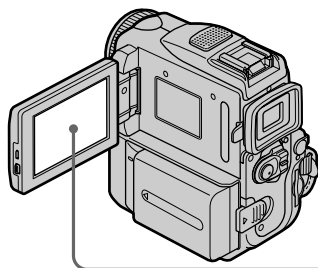

5

<table border="1" style="width: 100%; border-collapse: collapse;"> <tr> <td style="text-align: right;">OTHERS</td> <td style="text-align: right;">EXIT</td> </tr> <tr> <td>DATA CODE</td> <td></td> </tr> <tr> <td>BEEP</td> <td></td> </tr> <tr> <td>COMMANDER</td> <td></td> </tr> <tr> <td>DISPLAY</td> <td></td> </tr> <tr> <td>CM</td> <td>VIDEO EDIT*RETURN</td> </tr> <tr> <td>DIS</td> <td>TAPE</td> </tr> <tr> <td>ETC</td> <td>MEMORY</td> </tr> <tr> <td style="text-align: center;">↓</td> <td style="text-align: center;">↑</td> </tr> <tr> <td style="text-align: center;">EXEC</td> <td style="text-align: center;">RET</td> </tr> </table>	OTHERS	EXIT	DATA CODE		BEEP		COMMANDER		DISPLAY		CM	VIDEO EDIT*RETURN	DIS	TAPE	ETC	MEMORY	↓	↑	EXEC	RET	➔	<table border="1" style="width: 100%; border-collapse: collapse;"> <tr> <td colspan="2" style="text-align: center;">VIDEO EDIT</td> <td style="text-align: right;">0:32:30:14</td> </tr> <tr> <td>MARK IN</td> <td>START</td> <td>IMAGE SIZE UNDO</td> </tr> <tr> <td colspan="3" style="text-align: center;">TOTAL 0:00:00</td> </tr> <tr> <td colspan="3" style="text-align: center;">SCENE 0</td> </tr> <tr> <td colspan="3" style="text-align: center;">████████████████████████████████████████</td> </tr> <tr> <td style="text-align: center;">■</td> <td style="text-align: center;">◀◀</td> <td style="text-align: center;">▶▶</td> </tr> <tr> <td style="text-align: center;">■</td> <td style="text-align: center;">◀◀</td> <td style="text-align: center;">▶▶</td> </tr> </table>	VIDEO EDIT		0:32:30:14	MARK IN	START	IMAGE SIZE UNDO	TOTAL 0:00:00			SCENE 0			████████████████████████████████████████			■	◀◀	▶▶	■	◀◀	▶▶
OTHERS	EXIT																																										
DATA CODE																																											
BEEP																																											
COMMANDER																																											
DISPLAY																																											
CM	VIDEO EDIT*RETURN																																										
DIS	TAPE																																										
ETC	MEMORY																																										
↓	↑																																										
EXEC	RET																																										
VIDEO EDIT		0:32:30:14																																									
MARK IN	START	IMAGE SIZE UNDO																																									
TOTAL 0:00:00																																											
SCENE 0																																											
████████████████████████████████████████																																											
■	◀◀	▶▶																																									
■	◀◀	▶▶																																									

8~10

<table border="1" style="width: 100%; border-collapse: collapse;"> <tr> <td colspan="2" style="text-align: center;">VIDEO EDIT</td> <td style="text-align: right;">0:08:55:06</td> </tr> <tr> <td>MARK OUT</td> <td>START</td> <td>IMAGE SIZE UNDO</td> </tr> <tr> <td colspan="3" style="text-align: center;">TOTAL 0:00:00</td> </tr> <tr> <td colspan="3" style="text-align: center;">SCENE 0</td> </tr> <tr> <td colspan="3" style="text-align: center;">████████████████████████████████████████</td> </tr> <tr> <td style="text-align: center;">■</td> <td style="text-align: center;">◀◀</td> <td style="text-align: center;">▶▶</td> </tr> <tr> <td style="text-align: center;">■</td> <td style="text-align: center;">◀◀</td> <td style="text-align: center;">▶▶</td> </tr> </table>	VIDEO EDIT		0:08:55:06	MARK OUT	START	IMAGE SIZE UNDO	TOTAL 0:00:00			SCENE 0			████████████████████████████████████████			■	◀◀	▶▶	■	◀◀	▶▶	<table border="1" style="width: 100%; border-collapse: collapse;"> <tr> <td colspan="2" style="text-align: center;">VIDEO EDIT</td> <td style="text-align: right;">0:09:07:06</td> </tr> <tr> <td>MARK IN</td> <td>START</td> <td>IMAGE SIZE UNDO</td> </tr> <tr> <td colspan="3" style="text-align: center;">TOTAL 0:07:01</td> </tr> <tr> <td colspan="3" style="text-align: center;">SCENE 1</td> </tr> <tr> <td colspan="3" style="text-align: center;">████████████████████████████████████████</td> </tr> <tr> <td style="text-align: center;">■</td> <td style="text-align: center;">◀◀</td> <td style="text-align: center;">▶▶</td> </tr> <tr> <td style="text-align: center;">■</td> <td style="text-align: center;">◀◀</td> <td style="text-align: center;">▶▶</td> </tr> </table>	VIDEO EDIT		0:09:07:06	MARK IN	START	IMAGE SIZE UNDO	TOTAL 0:07:01			SCENE 1			████████████████████████████████████████			■	◀◀	▶▶	■	◀◀	▶▶	<table border="1" style="width: 100%; border-collapse: collapse;"> <tr> <td colspan="2" style="text-align: center;">VIDEO EDIT</td> <td style="text-align: right;">0:10:01:23</td> </tr> <tr> <td>MARK IN</td> <td>START</td> <td>IMAGE SIZE UNDO</td> </tr> <tr> <td colspan="3" style="text-align: center;">TOTAL 0:30:11</td> </tr> <tr> <td colspan="3" style="text-align: center;">SCENE 3</td> </tr> <tr> <td colspan="3" style="text-align: center;">████████████████████████████████████████</td> </tr> <tr> <td style="text-align: center;">■</td> <td style="text-align: center;">◀◀</td> <td style="text-align: center;">▶▶</td> </tr> <tr> <td style="text-align: center;">■</td> <td style="text-align: center;">◀◀</td> <td style="text-align: center;">▶▶</td> </tr> </table>	VIDEO EDIT		0:10:01:23	MARK IN	START	IMAGE SIZE UNDO	TOTAL 0:30:11			SCENE 3			████████████████████████████████████████			■	◀◀	▶▶	■	◀◀	▶▶
VIDEO EDIT		0:08:55:06																																																															
MARK OUT	START	IMAGE SIZE UNDO																																																															
TOTAL 0:00:00																																																																	
SCENE 0																																																																	
████████████████████████████████████████																																																																	
■	◀◀	▶▶																																																															
■	◀◀	▶▶																																																															
VIDEO EDIT		0:09:07:06																																																															
MARK IN	START	IMAGE SIZE UNDO																																																															
TOTAL 0:07:01																																																																	
SCENE 1																																																																	
████████████████████████████████████████																																																																	
■	◀◀	▶▶																																																															
■	◀◀	▶▶																																																															
VIDEO EDIT		0:10:01:23																																																															
MARK IN	START	IMAGE SIZE UNDO																																																															
TOTAL 0:30:11																																																																	
SCENE 3																																																																	
████████████████████████████████████████																																																																	
■	◀◀	▶▶																																																															
■	◀◀	▶▶																																																															

Recording edited pictures from a tape as a moving picture - Digital program editing (on "Memory Stick"s)

Erasing the program you have set

Erase OUT first and then IN from of the last program.

- (1) Press UNDO.
- (2) Press ERASE 1 MARK. The last set program mark flashes, then DELETE ? appears.
- (3) Press EXEC. The last set program is deleted.

To cancel erasing

Press CANCEL in step 3.

Erasing all programs

- (1) Press MENU, then select VIDEO EDIT in $\overline{\text{ETC}}$, then press EXEC (p. 192).
- (2) Press \downarrow/\uparrow to select MEMORY, then press EXEC.
- (3) Press UNDO.
- (4) Press ERASE ALL. All the set program marks flash, then DELETE ? appears.
- (5) Press EXEC. All the set programs are deleted.

To cancel erasing all programs

Press CANCEL in step 5.

To cancel a program you have set

Press \leftarrow END.

The program is stored in memory until the tape is ejected.

Notes

- You cannot dub the titles, display indicators, or the contents of cassette memory.
- You cannot operate recording during the digital program editing on "Memory Stick"s.

On a blank portion of the tape

You cannot set IN or OUT on a blank portions of the tape.

If there is a blank portion between IN and OUT on the tape

The total time code may not be displayed correctly.

During making a program

If you eject the cassette, the program will be erased.

Recording edited pictures from a tape as a moving picture – Digital program editing (on “Memory Stick”s)

Performing the program (Dubbing a “Memory Stick”)

- (1) Press MENU, then select VIDEO EDIT in , then press EXEC (p. 192).
- (2) Press ↓/↑ to select MEMORY, then press EXEC.
- (3) Press START.
- (4) Press EXEC.

Your camcorder searches for the beginning of the first program, then starts dubbing.

The program mark flashes.

The SEARCH indicator appears during search, the EDITING indicator appears during writing of data on your camcorder, and REC appears during dubbing on the screen.

The program mark changes to light blue after dubbing is complete.

When the dubbing ends, your camcorder automatically stops.

To stop dubbing

Press CANCEL.

The program you made is recorded on a “Memory Stick” up to the place where you pressed CANCEL.

To end the Digital program editing function

Your camcorder stops when the dubbing ends. Then the display returns to VIDEO EDIT in the menu settings.

Press  END to end the program editing function.

When the program has not been set

You cannot press START.

When the available recording time of “Memory Stick” is not enough

LOW MEMORY appears on the screen. However, you can record pictures up to the time indicated.

When available recording time is not left on the “Memory Stick”

MEMORY FULL appears.

When the “Memory Stick” is not inserted

NO MEMORY STICK appears.

When the write-protect switch on the “Memory Stick” is set to LOCK

MEMORY STICK LOCKED appears.

Copying still images from a tape – PHOTO SAVE

Using the search function, your camcorder automatically takes in only still images from tapes and record them on a “Memory Stick” in sequence.

Before operation

- Insert a recorded tape into your camcorder and rewind the tape.
- Insert a “Memory Stick” into your camcorder.

- (1) Set the POWER switch to VCR.
- (2) Press FN to display PAGE1.
- (3) Press MENU, then select PHOTO SAVE in , then press EXEC. PHOTO BUTTON appears on the LCD screen (p. 189).
- (4) Press PHOTO deeper. The still image from the tape is recorded on the “Memory Stick.” The number of still images copied is displayed. END is displayed when copying is completed.

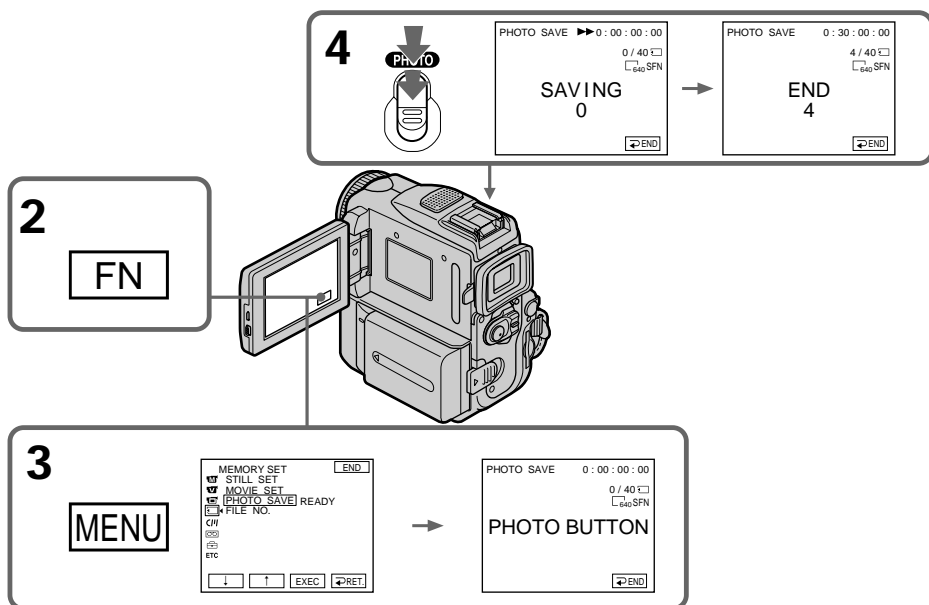

Copying still images from a tape – PHOTO SAVE

To stop copying

Press \leftarrow END.

To return to FN

Press \leftarrow END to return to PAGE1, then press EXIT.

When the “Memory Stick” is full

MEMORY FULL appears on the LCD screen, and the copying stops. Press \leftarrow END, insert another “Memory Stick” and repeat the procedure from step 2.

Image size of still images

Image size is automatically set to 640×480 .

When the access lamp is lit or flashing

Do not shake or strike your camcorder. As well do not turn the power off, eject a “Memory Stick” or remove the battery pack. Otherwise, the image data breakdown may occur.

If the write-protect switch on the “Memory Stick” is set to LOCK

NOT READY appears when you select the item in the menu settings.

When you change “Memory Stick”s in the middle of copying

Your camcorder resumes copying from the last image recorded on the previous “Memory Stick.”

Viewing a still image

- Memory photo playback

You can play back still images recorded on a "Memory Stick." You can also play back six images including moving pictures at a time arranged in the same order of recording on a "Memory Stick" by selecting the index screen.

Before operation

Insert a "Memory Stick" into your camcorder.

- (1) Set the POWER switch to MEMORY. Make sure that the LOCK switch is set to the right (unlock) position.
- (2) Press PLAY. The last recorded image is displayed.
- (3) Press -/+ on your camcorder to select the desired still image.
 - : to see the previous image
 - + : to see the next image

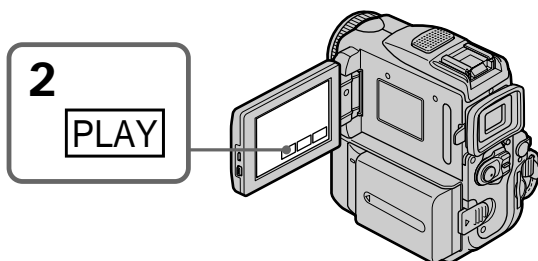

To stop memory photo playback

Press CAM.

Note

You may not be able to play back images with your camcorder:

- When playing back image data modified on your computers.
- When playing back image data shot with other equipment.

Notes on the file name

- The directory number may not be displayed and only the file name may be displayed if the structure of the directory does not conform to the DCF standard.
- "⏏ DIRECTORY ERROR" may appear on the LCD screen if the structure of the directory does not conform to the DCF standard. If this message appears, you can play back images but cannot record them on the "Memory Stick."
- The file name flashes on the LCD screen if the file is corrupted or the file is unreadable.

To play back recorded images on a TV screen

- Connect your camcorder to the TV with the A/V connecting cable supplied with your camcorder before the operation.
- When operating memory photo playback on a TV or on the LCD screen, the image quality may appear to have deteriorated. This is not a malfunction. The image data is as good as ever.
- Turn the audio volume of the TV down before operation, or noise (howling) may be output from the TV speakers.

Still image

You can select still images also with -/+ on PAGE1/PAGE2/PAGE3.

Viewing a still image - Memory photo playback

Screen indicators during still image playback

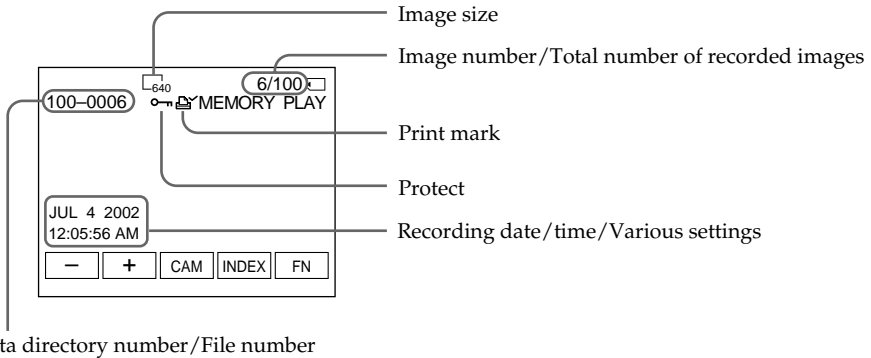

Recording data

To display the recording data (date/time or various settings when recorded), press DATA CODE during playback. You can also use the Remote Commander for this operation (p. 39).

To make screen indicators disappear

Press DISPLAY/TOUCH PANEL.

Viewing a still image – Memory photo playback

Playing back six recorded images at a time (index screen)

You can play back six recorded images at a time. This function is especially useful when searching for a particular image.

Before operation

Insert a “Memory Stick” into your camcorder.

- (1) Set the POWER switch to MEMORY. Make sure that the LOCK switch is set to the right (unlock) position.
- (2) Press INDEX to display the index screen.

A red ► mark appears above the image that is displayed before changing to the index screen mode.

← : to display the previous six images

→ : to display the following six images

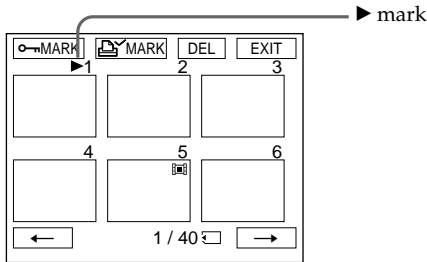

To return to FN

Press EXIT.

To return to the normal playback screen (single screen)

Press the image you want to display.

Note

When displaying the index screen, the number appears above each image. This indicates the order in which images are recorded on the “Memory Stick.” These numbers are different from the data file names.

Image data modified with your computers or shot with other equipment

These files may not be displayed on the index screen.

Viewing a moving picture - MPEG movie playback

You can play back moving pictures recorded on a "Memory Stick." You can also play back six images including still images in order of recording on a "Memory Stick" at a time by selecting the index screen.

Before operation

Insert a "Memory Stick" into your camcorder.

- (1) Set the POWER switch to MEMORY. Make sure that the LOCK switch is set to the right (unlock) position.
- (2) Press PLAY. The last recorded image is displayed.
- (3) Press -/+ to select the desired moving pictures.
- : To see the previous picture
+ : To see the next picture
- (4) Press MPEG ► || to start playback.
- (5) Adjust the volume following the steps below.
 - ① Press FN and select PAGE3.
 - ② Press VOL. The screen to adjust volume appears.
 - ③ Press -/+ to adjust the volume.
- : to decrease the volume.
+ : to increase the volume.
 - ④ Press ↵ OK.

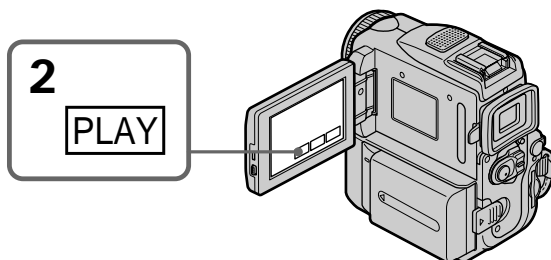

To stop MPEG movie playback

Press MPEG ► ||.

Note

You may not be able to play back images with your camcorder:

- When playing back image data modified on your computer.
- When playing back image data shot with other equipment.

To play back recorded images on a TV screen

- Connect your camcorder to the TV with the A/V connecting cable supplied with your camcorder before operation.
- Turn the audio volume of the TV down before operation, or noise (howling) may be output from the TV speakers.

Moving picture

You can select moving pictures also with -/+ on PAGE1/PAGE2/PAGE3.

Viewing a moving picture – MPEG movie playback

Playback picture from desired part

The moving picture recorded on the “Memory Stick” is divided into 23 parts. You can select every each one point and playback pictures.

Before operation

Insert a “Memory Stick” into your camcorder.

- (1) Set the POWER switch to MEMORY.
Make sure that the LOCK switch is set to the right (unlock) position.
- (2) Press PLAY.
The last recorded image is displayed.
- (3) Press +/- to select the desired moving pictures.
To see the previous picture, press -.
To see the next picture, press +.
- (4) Press ◀/▶ to select the point where you want to play back.
◀ : to see previous part
▶ : to see next part
- (5) Press MPEG ▶ || to start playback.
- (6) Adjust the volume following the steps below.
 - ① Press FN and select PAGE3.
 - ② Press VOL. The screen to adjust volume appears.
 - ③ Press -/+ to adjust the volume.
- : to decrease the volume.
+ : to increase the volume.
 - ④ Press ↵ OK.

To stop MPEG movie playback

Press MPEG ▶ ||.

When recording time is too short

The moving picture may not be divided into 23 parts.

Viewing a moving picture - MPEG movie playback

Screen indicators during moving picture playback

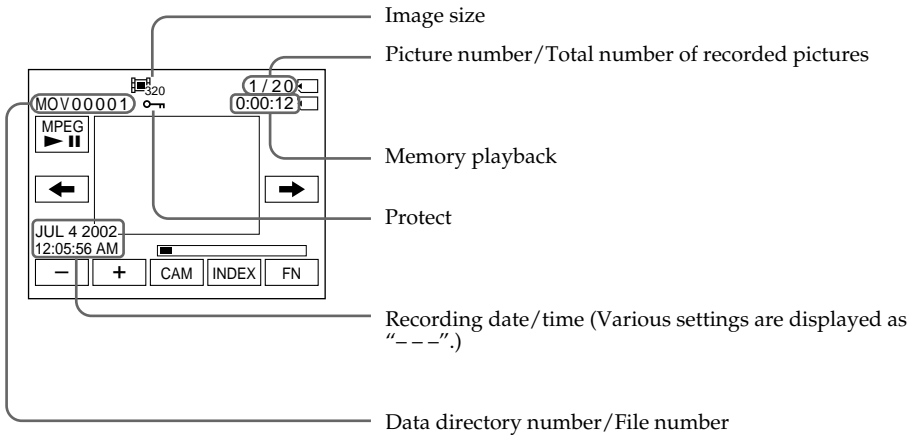

Recording date/time

To display the recording date/time, press DATA CODE during playback. You can also use the Remote Commander for this operation (p. 39).

To make screen indicators disappear

Press DISPLAY/TOUCH PANEL.

Enlarging still images recorded on “Memory Stick”s – Memory PB ZOOM

You can enlarge still images recorded on a “Memory Stick”. You can select and view a desired part from the enlarged still image. Also, you can copy the desired part of the enlarged still image to tapes or “Memory Stick”s.

Before operation

Insert a “Memory Stick” into your camcorder.

- (1) In memory playback, press FN and select PAGE2.
- (2) Press PB ZOOM. PB ZOOM screen appears.
- (3) Press the area that you want to enlarge in the frame on the PB ZOOM screen. The area you pressed moves to the center of the screen, and the playback image is enlarged to about twice the size. If you press the other area, the area moves to the center of the screen.
- (4) Adjust the zoom ratio by the zoom lever.
You can select the image from approximately 1.1 times up to five times its size.
W: Decrease the zoom ratio.
T: Increase the zoom ratio.

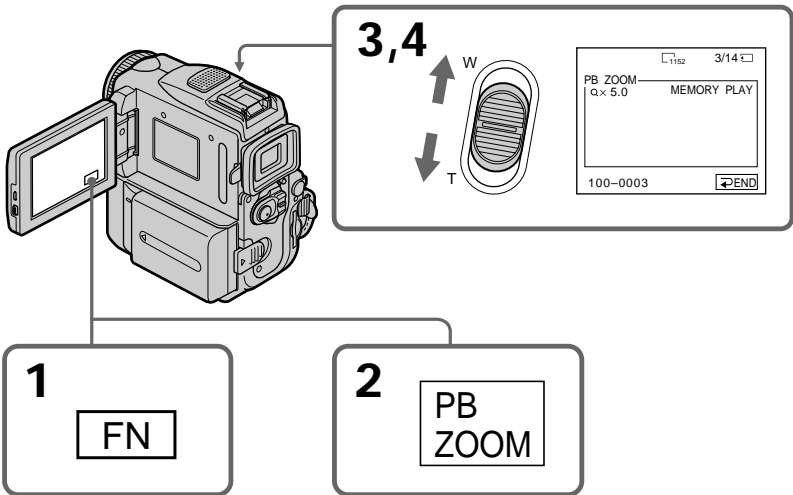

To cancel the Memory PB ZOOM function

Press \rightarrow END.

In Memory PB ZOOM

If you press DISPLAY/TOUCH PANEL, the frame on the Memory PB ZOOM screen disappears. You cannot move the part you pressed to the center of the screen.

Edge of an enlarged image

The edge of an enlarged image cannot be displayed in the center of the screen.

Moving pictures recorded on “Memory Stick”s

The PB ZOOM function does not work.

To record an image processed by Memory PB ZOOM on “Memory Stick”s

Press PHOTO to record the image processed by PB ZOOM. (Images are recorded at 640 × 480 size.)

Playing back images in a continuous loop – SLIDE SHOW

Your camcorder can automatically play back images in sequence. This function is especially useful when checking recorded images or during a presentation.

Before operation

Insert a “Memory Stick” into your camcorder.

- (1) Set the POWER switch to MEMORY. Make sure that the LOCK switch is set to the right (unlock) position.
- (2) Press FN to display PAGE1.
- (3) Press MENU, then select SLIDE SHOW in , then press EXEC (p. 189).
- (4) Press START. Your camcorder plays back the images recorded on a “Memory Stick” in sequence.

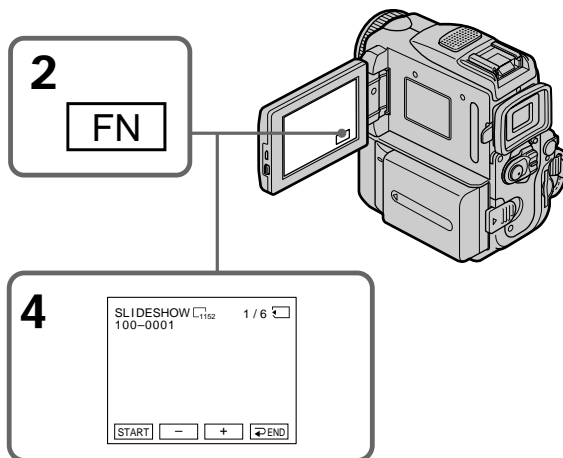

To stop the slide show

Press  END.

To pause during a slide show

Press PAUSE.

To return to FN

Press  END.

To start the slide show from a particular image

Select the desired image using -/+ buttons before step 4.

To view the recorded images on TV

Connect your camcorder to a TV with the A/V connecting cable supplied with your camcorder before operation.

If you change “Memory Stick”s during operation



The slide show does not operate. If you change the “Memory Stick,” be sure to follow the steps again from the beginning.

Preventing accidental erasure – Image protection

To prevent accidental erasure of important images, you can protect selected images.

Before operation

Insert a “Memory Stick” into your camcorder.

- (1) Set the POWER switch to MEMORY. Make sure that the LOCK switch is set to the right (unlock) position.
- (2) Press INDEX to display the index.
- (3) Press  MARK. The screen to protect the image appears.
- (4) Press the image you want to protect. The “” appears on the protected image.

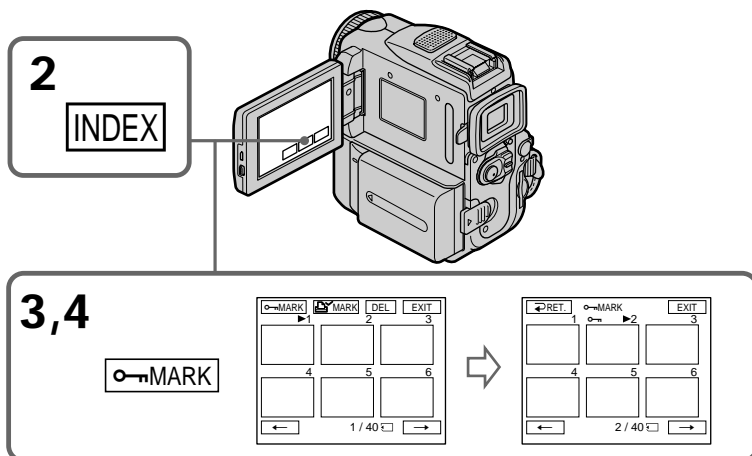

To return to FN

Press EXIT.

To cancel image protection

Press the image you want to cancel image protection in step 4 again. The “” disappears.

Note

Formatting erases all information on the “Memory Stick,” including the protected image data. Check the contents of the “Memory Stick” before formatting.

If the write-protect switch on the “Memory Stick” is set to LOCK

You cannot carry out image protection.

Deleting images – DELETE

You can delete images stored in a “Memory Stick.” You can delete all images or selected images.

Deleting selected images

Before operation

Insert a “Memory Stick” into your camcorder.

- (1) Set the POWER switch to MEMORY. Make sure that the LOCK switch is set to the right (unlock) position.
- (2) Play back the image you want to delete.
- (3) Press FN to display PAGE1.
- (4) Press DELETE. DELETE? appears on the screen.
- (5) Press OK. The selected image is deleted.

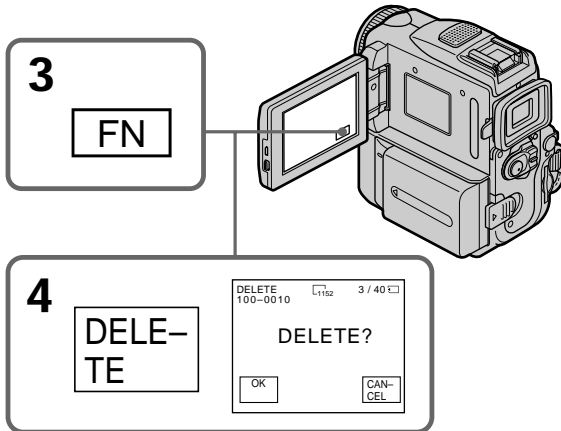

To return to FN

Press EXIT.

To cancel deleting an image

Press CANCEL in step 5.

Notes

- To delete a protected image, first cancel image protection.
- Once you delete an image, you cannot restore it. Check the images to delete carefully before deleting them.

If the write-protect switch on the “Memory Stick” is set to LOCK

You cannot delete images.

Deleting images – DELETE

Deleting selected images on the index screen

Before operation

Insert a “Memory Stick” into your camcorder.

- (1) Set the POWER switch to MEMORY. Make sure that the LOCK switch is set to the right (unlock) position.
- (2) Press INDEX to display the index.
- (3) Press DEL. Then press the image you want to delete. The number of the selected image is highlighted.
- (4) Press EXEC. DELETE? appears on the screen.
- (5) Press OK. The selected images are deleted.

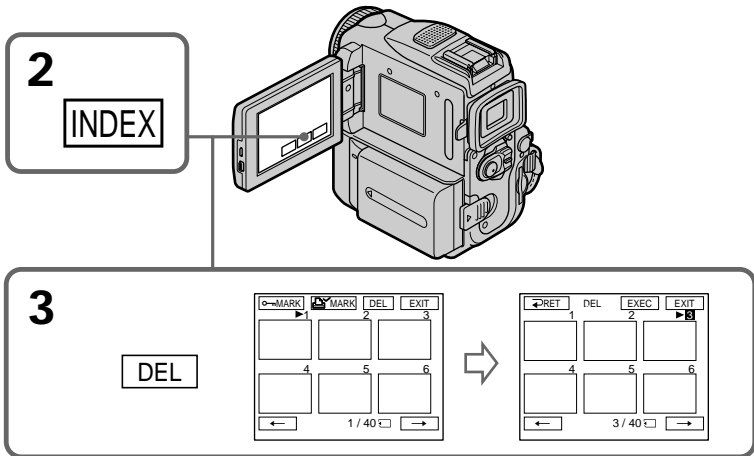

To return to FN

Press EXIT.

To cancel deleting an image

Press CANCEL in step 5.

Deleting images – DELETE

Deleting all the images

You can delete all the unprotected images in a “Memory Stick.”

Before operation

Insert a “Memory Stick” into your camcorder.

- (1) Set the POWER switch to MEMORY. Make sure that the LOCK switch is set to the right (unlock) position.
- (2) Press FN to display PAGE1.
- (3) Press MENU, then select DELETE ALL in , then press EXEC (p. 189).
- (4) Press ↓/↑ to select OK, then press EXEC.
OK changes to EXECUTE.
- (5) Press ↓/↑ to select EXECUTE, then press EXEC.
DELETING appears on the screen.
When all the unprotected images are deleted, COMPLETE is displayed.

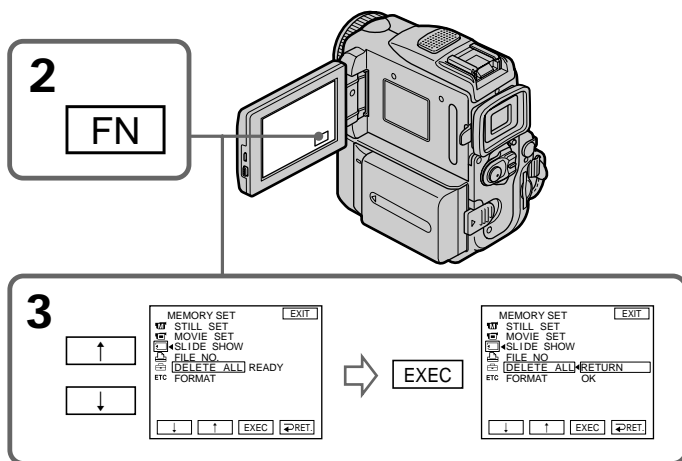

To return to FN

Press EXIT.

To cancel deleting all the images in the “Memory Stick”

Select RETURN in step 5, then press EXEC.

While DELETING appears

Do not turn the POWER switch or press any buttons.



Writing a print mark – PRINT MARK

You can specify the recorded still image to print out by putting marks. This function is useful for printing out still images later.

Your camcorder conforms with the DPOF (Digital Print Order Format) standard for specifying the still images to print out.

Before operation

Insert a “Memory Stick” into your camcorder.

- (1) Set the POWER switch to MEMORY. Make sure that the LOCK switch is set to the right (unlock) position.
- (2) Press INDEX to display the index.
- (3) Press  MARK. The screen to write a print mark appears.
- (4) Press the image you want to write a print mark. The  appears on the selected image.

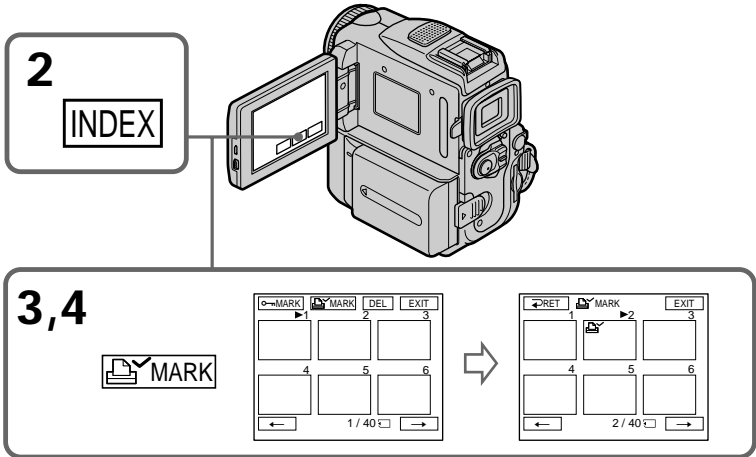

To return to FN

Press EXIT.

To cancel writing print marks

Press the image you want to cancel the print mark in step 4 again. The  disappears.

If the write-protect switch on the “Memory Stick” is set to LOCK

You cannot write print marks on still images.

Moving pictures

You cannot write print marks on moving pictures.

While the file name is flashing

You cannot write print mark on the still image.

Using the optional printer

You can use the optional printer on your camcorder to print images on print paper. For details, refer to the operating instructions of the printer.

There are various ways of printing still images. The following, however, describes how to print by selecting  in the menu on the touch panel on your camcorder.

Before operation

- Insert a recorded “Memory Stick” into your camcorder.
- Attach the optional printer to your camcorder as illustrated.

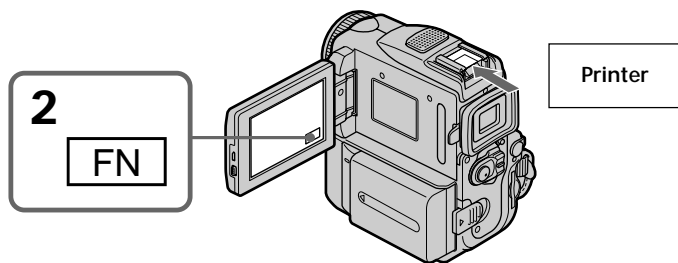

Selecting a type of the 9PICS print screen

You can make nine stickers using a 9-cut sticker sheet. To make stickers, print images recorded on a “Memory Stick” in 9PIC PRINT.

- (1) Set the POWER switch to MEMORY. Make sure that the LOCK switch is set to the right (unlock) position.
- (2) Press FN to display PAGE1.
- (3) Press MENU, then select 9PIC PRINT in , then press EXEC (p. 189).
- (4) Press ↓/↑ to select a desired mode, then press EXEC.

SAME PICS



MULTI PICS or *MARKED PICS



* Nine still images with print marks are printed together.

Using the optional printer

Selecting date/time

You can print the recorded date/time.

- (1) Set the POWER switch to MEMORY. Make sure that the LOCK switch is set to the right (unlock) position.
- (2) Press FN to display PAGE1.
- (3) Press MENU, then select DATE/TIME in , then press EXEC (p. 189).
- (4) Press ↓/↑ to select a desired mode, then press EXEC.

DATE



DAY & TIME



Images recorded in the multi screen mode

You cannot print images recorded in the multi screen mode on a 9-cut sticker sheet.

Moving pictures recorded on "Memory Stick"

You cannot print moving pictures.

When "Memory Stick" has no files

" NO FILE" appears on the screen.

Images processed by 9PIC PRINT

You cannot insert a DATE/TIME indicator.

When there are no files with a PRINT MARK

" NO PRINT MARK" appears on the screen.

Viewing images with your computer

– Introduction

There are following ways of connecting your camcorder to your computer in order to view images saved on a “Memory Stick” or recorded on a tape on your computer.

To view images on your computer which has a Memory Stick slot, first eject the “Memory Stick” from your camcorder and then insert it into your computer’s Memory Stick slot.

Tape stills and movies

Camcorder Connection jack	Connection cable	Computer environment requirements
USB jack	USB cable (supplied)	USB port, editing software
DV jack	i.LINK cable (optional)	DV port, editing software

“Memory Stick” stills and movies

Camcorder Connection jack	Connection cable	Computer environment requirements
USB jack	USB cable (supplied)	USB port, editing software

When connecting to your computer with the USB port, complete installation of the USB driver before connecting your camcorder to your computer. If you connect your camcorder to your computer first, you will not be able to install the USB driver correctly.

For details about your computer’s ports and editing software, contact your computer manufacturer.

Viewing images with your computer

Viewing images recorded on a tape

When connecting to your computer with the USB port

For details, see page 166.

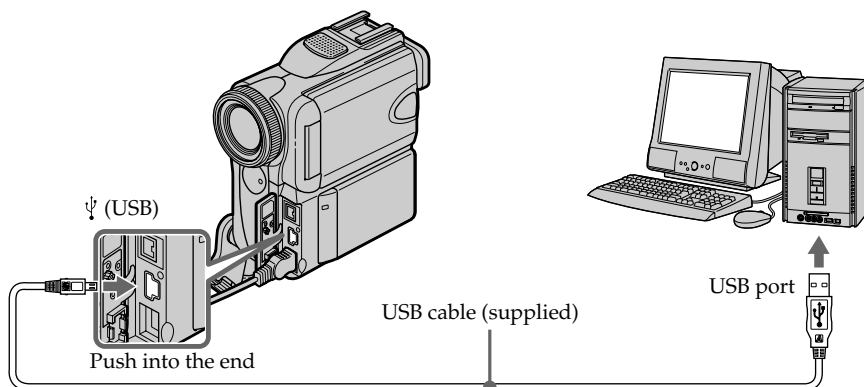

Viewing images with your computer – Introduction

When connecting to your computer with the DV port

Your computer must have a DV port and editing software installed that can read video signals.

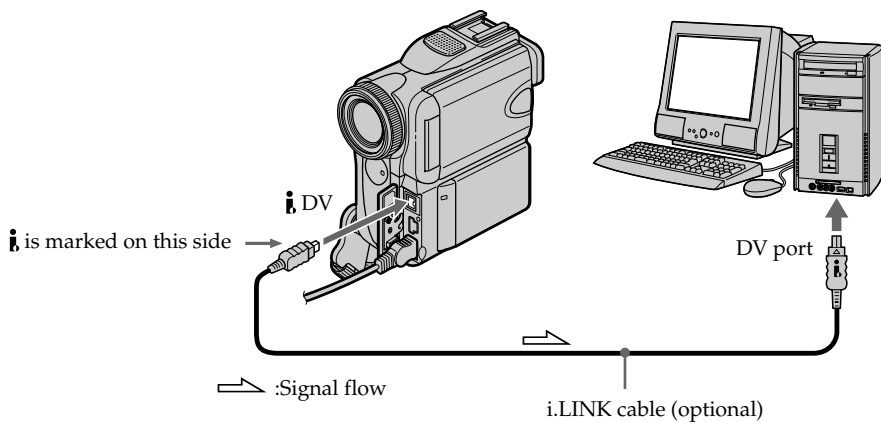

Viewing images recorded on a "Memory Stick"

When connecting to your computer with the USB port

There are two methods of USB connection, NORMAL and PTP. The default setting is NORMAL.

Here we explain how to use the camcorder with a standard USB connection (NORMAL). See page 166 when using Windows and page 180 when using Macintosh.

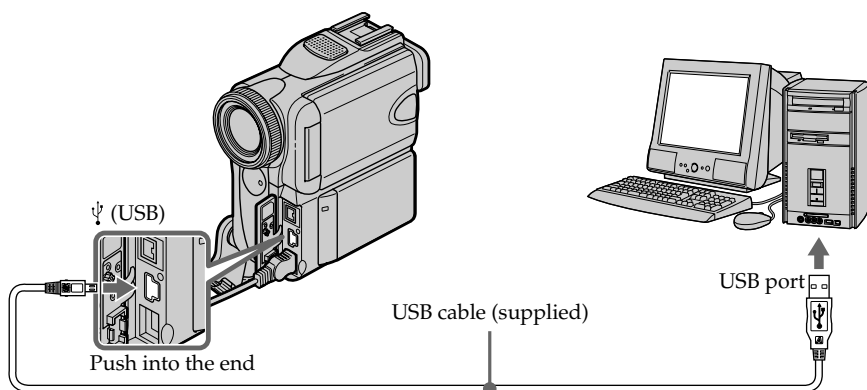

You can also use a "Memory Stick" Reader/Writer (optional).

When connecting to your computer without a USB port

Use an optional floppy disk adaptor for Memory Stick or a PC card adaptor for Memory Stick.

When purchasing an accessory, check its catalog beforehand for the recommended operating environment.

Notes on using your computer

“Memory Stick”

- “Memory Stick” operations on your camcorder cannot be assured if a “Memory Stick” formatted on your computer is used on your camcorder, or if the “Memory Stick” in your camcorder was formatted from your computer when the USB cable was connected.
- Do not compress the data on the “Memory Stick.” Compressed files cannot be played back on your camcorder.

Software

- Depending on your application software, the file size may increase when you open a still image file.
- When you load an image modified using retouching software from your computer to your camcorder or when you directly modify the image on your camcorder, the image format will differ so a file error indicator may appear and you may be unable to open the file.

Connecting to your computer with USB port – For Windows users

Complete installation of the USB driver before connecting your camcorder to your computer. If you connect your camcorder to your computer first, you will not be able to install the USB driver correctly.

When connecting to your computer with the USB port

You must install a **USB driver** onto your computer in order to connect your camcorder to your computer's USB port. The USB driver can be found on the CD-ROM supplied, along with the application software required for viewing images.

If you connect your camcorder and your computer using the USB cable, you can view pictures live from your camcorder and pictures recorded on a tape on your computer (USB streaming function).

Furthermore, if you download pictures from your camcorder to your computer, you can process or edit them in image processing software and append them to e-mail. You can also view images recorded on a "Memory Stick" with your computer.

Recommended computer usage environment when connecting USB cable and viewing tape images on the computer

OS:

Microsoft Windows 98 SE, Windows Me, Windows 2000 Professional, Windows XP Home Edition or Windows XP Professional

Standard installation is required.

However, operation is not assured if the above environment is an upgraded OS.

You cannot hear sound if your computer is running Windows 98, but you can read still images.

CPU:

Minimum 500 MHz Intel Pentium III or faster (800 MHz or faster recommended)

Application:

DirectX 8.0a or later

Sound system:

16 bit stereo sound card and speakers

Memory:

64 MB or more

Hard disk:

Available memory required for installation:

at least 200MB

Available hard disk memory recommended:

at least 1GB (depending on the size of the image files edited)

Display:

4 MB VRAM video card, Minimum 800 × 600 dot Hi color (16 bit color, 65,000 colors), Direct Draw display driver capability (At 800 × 600 dot or less, 256 colors and less, this product will not operate correctly.)

Others:

This product is compatible with DirectX technology, so it is necessary to install DirectX.

The USB port must be provided as standard.

You cannot use this function in the Macintosh environment.

Recommended computer usage environment when connecting USB cable and viewing “Memory Stick” images on the computer

OS:

Microsoft Windows 98, Windows 98 SE, Windows Me, Windows 2000 Professional, Windows XP Home Edition or Windows XP Professional

Standard installation is required.

However, operation is not assured if the above environment is an upgraded OS.

CPU:

MMX Pentium 200 MHz or faster

The USB port must be provided as standard.

Windows Media Player must be installed (to play back moving pictures).

Notes

- Operations are not assured for the Windows environment if you connect two or more USB equipment to a single computer at the same time, or when using a hub.
- Some equipment may not operate depending on the type of USB equipment that is used simultaneously.
- Operations are not assured for all the recommended computer environments mentioned above.
- Windows and Windows Media are trademarks or registered trademarks of Microsoft Corporation in the United States and/or other countries.
- Pentium is either trademark or registered trademark of Intel Corporation.
- All other product names mentioned herein may be the trademarks or registered trademarks of their respective companies. Furthermore, “™” and “®” are not mentioned in each case in this manual.

Installing the USB driver

Start the following operation without connecting the USB cable to your computer.
Connect the USB cable according to “Making your computer recognize your camcorder”.

If you are using Windows 2000 Professional or Windows XP Home Edition/Professional, log in with permission of administrators.

- (1) Turn on your computer and allow Windows to load.
- (2) Insert the supplied CD-ROM into the CD-ROM drive of your computer. The application software starts up and the title screen appears.
- (3) Move the cursor to “USB Driver” and click.



USB driver installation starts.

- (4) Follow the on-screen messages to install the USB driver.
- (5) Remove the CD-ROM and then restart your computer following the instructions on the screen.

Note

If you connect the USB cable before USB driver installation is completed, the USB driver will not be properly registered. Carry out installation again following the steps on page 171.

Windows XP Home Edition/Professional users

If you set USBCONNECT to PTP in the menu settings, you can copy “Memory Stick” images from your camcorder onto your computer without installing the USB driver. This is ideal for simply copying images from your camcorder onto your computer. See page 191 for details.

Making your computer recognize your camcorder

Viewing images recorded on a tape on your computer

See page 170 for details on viewing “Memory Stick” images on your computer.

You need to install “PIXELA ImageMixer ” to view images recorded on a tape. Install it from the CD-ROM supplied with your camcorder.

To install and use this software in Windows 2000 Professional, you must be authorized as Power Users or Administrators. For Windows XP Home Edition/Professional, you must be authorized as Administrators.

- (1) Turn on your computer and allow Windows to load.
If you are using your computer, close all running applications.
- (2) Insert the supplied CD-ROM into the CD-ROM drive of your computer.
The application software starts up and the title screen appears. If the title screen does not appear, double-click “My Computer” and then “ImageMixer” (CD-ROM Drive). The title screen appears after a while.
- (3) Move the cursor to “PIXELA ImageMixer” and click.
The Install Wizard program starts up and the language selection dialog box appears.
- (4) Select the language for installation.
- (5) Follow the on-screen messages.
The installation screen disappears when installation is completed.
- (6) Click DirectX.
Follow the on-screen messages to install DirectX.
Restart your computer when the installation is completed.
- (7) Connect the AC power adaptor to your camcorder.
- (8) Set the POWER switch to VCR.
- (9) Set USB STREAM to ON in  in the menu settings (p. 191).
- (10) With the CD-ROM inserted, connect the Ψ (USB) jack on your camcorder with the USB port on your computer using the supplied USB cable.
Your computer recognizes your camcorder, and the Add Hardware Wizard starts.

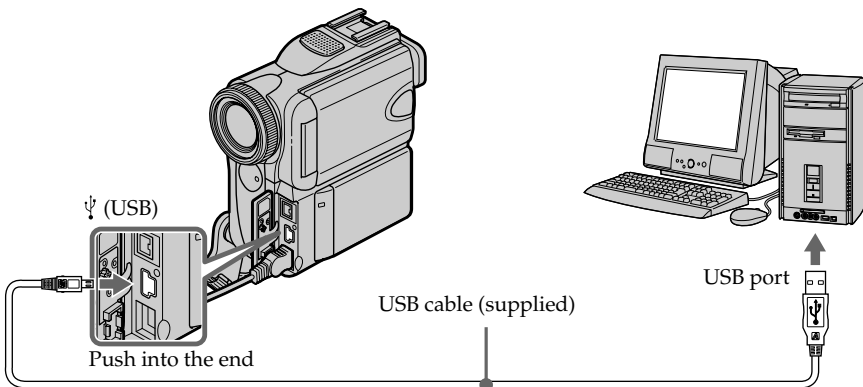

Connecting to your computer with USB port – For Windows users

- (11) Follow the on-screen messages so that the Add Hardware Wizard recognizes that the USB drivers have been installed. The Add Hardware Wizard starts three times because three different USB drivers are installed. Be sure to allow the installation to complete without interrupting them.

For Windows 2000 Professional, Windows XP Home Edition/Professional users

- (12) After the “File Needed” screen appears:

Open “Browse...” → “My Computer” → “ImageMixer” → “Sonyhcb.sys”, and click “OK”.

Viewing images recorded on “Memory Stick”s on your computer

Before operation

Set USBCONNECT to NORMAL in the menu settings. (The default setting is set to NORMAL.)

- (1) Insert a “Memory Stick” into your camcorder.
- (2) Connect the AC power adaptor to your camcorder and set the POWER switch to MEMORY.
- (3) Connect the ψ (USB) jack on your camcorder with the USB port on your computer using the supplied USB cable.
USB MODE appears on the LCD screen of your camcorder. Your computer recognizes the camcorder, and the Add Hardware Wizard starts.

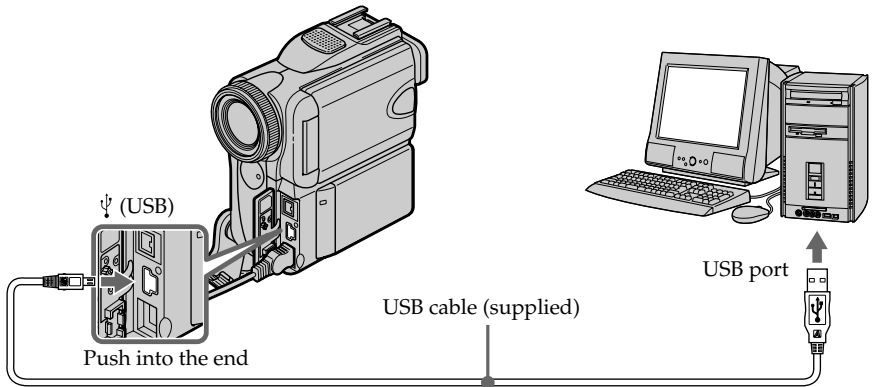

- (4) Follow the on-screen messages so that the Add Hardware Wizard recognizes that the USB drivers have been installed. The Add Hardware Wizard starts two times because two different USB drivers are installed. Be sure to allow each installation to complete without interrupting them.

You cannot install the USB driver if a “Memory Stick” is not in your camcorder. Be sure to insert a “Memory Stick” into your camcorder before installing the USB driver.

If you cannot install the USB driver

The USB driver has been registered incorrectly as your computer was connected to your camcorder before installation of the USB driver was completed. Perform the following procedure to correctly install the USB driver.

Viewing images recorded on a tape

Step 1: Uninstall the incorrect USB driver

- ① Turn on your computer and allow Windows to load.
- ② Connect the AC power adaptor to your camcorder, and set the POWER switch to VCR.
- ③ Connect the Ψ (USB) jack on your camcorder with the USB port on your computer using the supplied USB cable.
- ④ Open your computer's "Device Manager".

Windows XP Home Edition/Professional:

Select "Start" → "Control Panel" → "System" → "Hardware", and click the "Device manager" button.

If there is no "System" inside "Pick a category" after clicking "Control Panel", click "Switch to classic view" instead.

Windows 2000 Professional:

Select "My Computer" → "Control Panel" → "System" → "Hardware" tab, and click the "Device Manager" button.

Windows 98 SE, Windows Me:

Select "My Computer" → "Control Panel" → "System", and click "Device Manager" button.

- ⑤ Select and delete the underlined devices on the next page.

Connecting to your computer with USB port – For Windows users

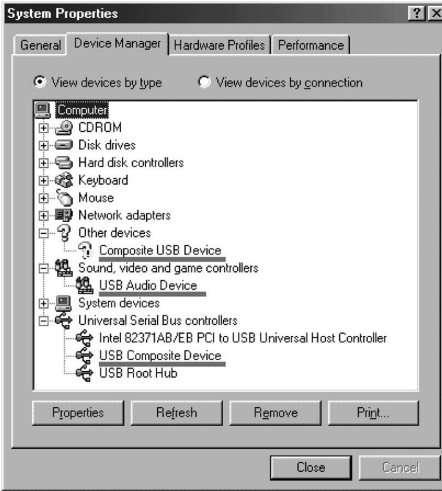

Windows 98 SE

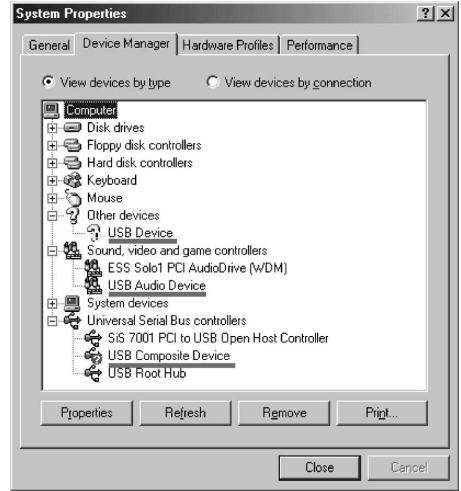

Windows Me

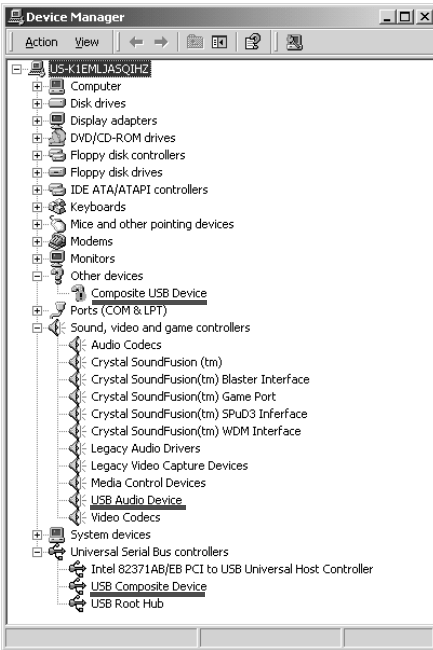

Windows 2000 Professional

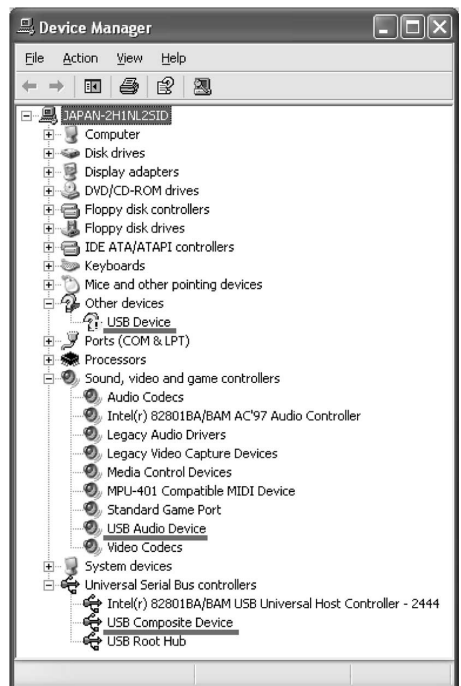

Windows XP Home Edition/Professional

Connecting to your computer with USB port – For Windows users

- ⑥ Turn the POWER switch to OFF (CHARGE) on your camcorder, and then disconnect the USB cable.
- ⑦ Restart your computer.

Step 2: Install the USB driver on the supplied CD-ROM

Perform the entire procedure described in “Installing the USB driver” on page 168.

Viewing images recorded on a “Memory Stick”

Step1: Uninstall the incorrect USB driver

- ① Turn on your computer and allow Windows to load.
- ② Insert a “Memory Stick” into your camcorder.
- ③ Connect the AC power adaptor to your camcorder, and set the POWER switch to MEMORY.
- ④ Connect the Ψ (USB) jack on your camcorder with the USB port on your computer using the supplied USB cable.
- ⑤ Open your computer’s “Device Manager”.

Windows 2000 Professional:

Select “My Computer” → “Control Panel” → “System” → “Hardware”, and click the “Device Manager” button.

Other OS:

Select “My Computer” → “Control Panel” → “System”, and click “Device Manager” button.

- ⑥ Select “Other devices”.
Select the device prefixed with the “?” mark and delete.
e.g. (?) Sony Handycam
- ⑦ Set the POWER switch to OFF (CHARGE) on your camcorder, and then disconnect the USB cable.
- ⑧ Restart your computer.

Step2: Install the USB driver on the supplied CD-ROM

Perform the entire procedure described in “Installing the USB driver” on page 168.



Viewing images recorded on a tape on your computer – For Windows users

Capturing images with “PIXELA ImageMixer Ver.1.0 for Sony”

You need to install the USB driver and “PIXELA ImageMixer ” to view images recorded on a tape on your computer (p. 168).

To install and use this software in Windows 2000 Professional, you must be authorized as Power Users or Administrators. For Windows XP Home Edition/Professional, you must be authorized as Administrators.

Viewing images recorded on a tape

- (1) Turn on your computer and allow Windows to load.
- (2) Connect the AC power adaptor to your camcorder, and insert a tape into your camcorder.
- (3) Set the POWER switch to VCR.
Set USB STREAM to ON in  in the menu settings (p. 191).
- (4) Select “Start” → “Programs” → “PIXELA” → “ImageMixer” → “PIXELA ImageMixer Ver.1.0 for Sony”.
The “PIXELA ImageMixer Ver.1.0 for Sony” startup screen appears on your computer.
- (5) Click  on the leftmost on the screen.



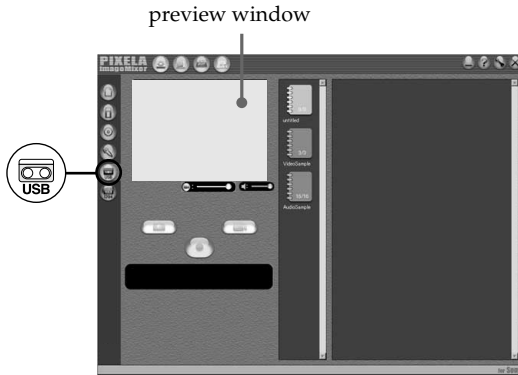

Viewing images recorded on a tape on your computer – For Windows users

- (6) Click .

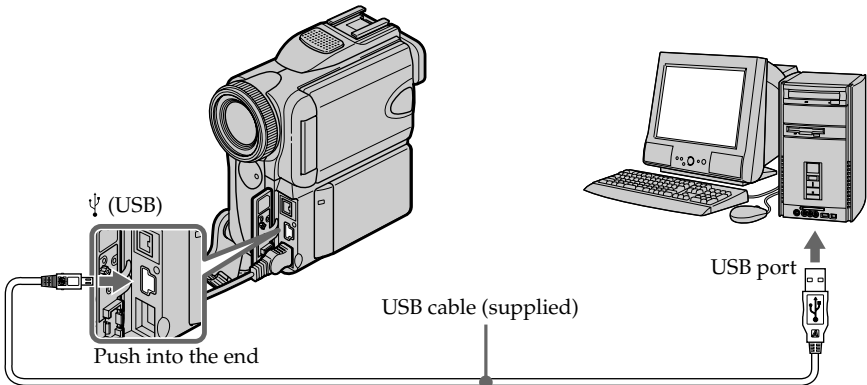

- (7) Connect the Ψ (USB) jack on your camcorder with the USB port on your computer using the supplied USB cable.





- (8) Press  to start playback.
The picture from the tape appears on preview window on your computer.

Viewing pictures live from your camcorder

- (1) Follow the steps 1 and 2 on page 174.
- (2) Set the POWER switch to CAMERA.
Set USB STREAM to ON in  in the menu settings (p. 191).
- (3) Follow the steps 4 to 7 on page 174 and 175.
The picture from your camcorder appears on preview window on your computer.

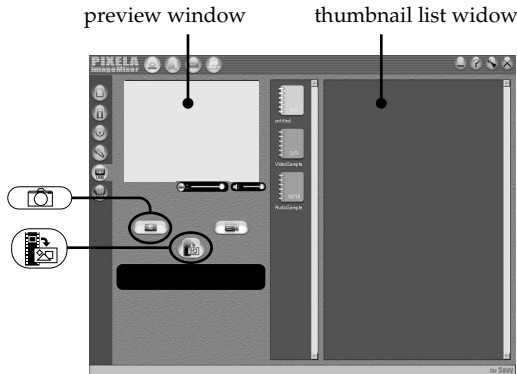



Capturing still images

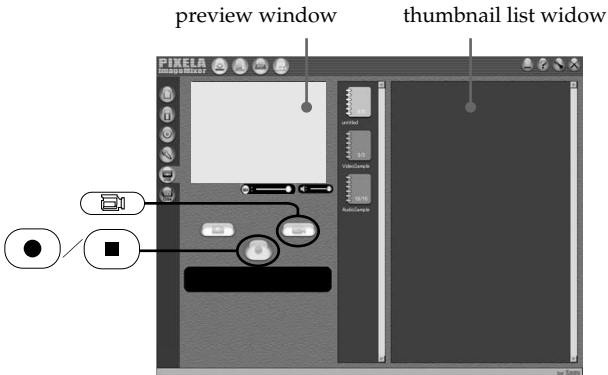

- (1) Click  .
- (2) Looking at the preview window, move the cursor to  and click it at the point you want to capture. The still image is captured. Captured images are displayed in the thumbnail list window.

Capturing moving pictures



- (1) Click  .
- (2) Looking at the preview window, move the cursor to  and click on it at the first scene of the movie you want to capture.  changes to  .
- (3) Looking at the preview window, move the cursor to  and click on it at the last scene you want to capture. The moving picture is captured. Captured images are displayed in the thumbnail list window.

Notes

- The followings may occur while you are using your camcorder, and are not due to any malfunction.
 - The image shakes up and down.
 - Some images are not displayed correctly due to noise, etc.
 - Images of different color systems to that of your camcorder are not displayed correctly.
- When your camcorder is in tape recording standby with a cassette inserted, it turns off automatically after five minutes.
- We recommend setting DEMO MODE to OFF in the menu settings when your camcorder is in tape recording standby without cassette.
- Indicators in the camcorder LCD screen do not appear on images that are captured into your computer.

If image data cannot be transferred by the USB connection

The USB driver has been registered incorrectly as your computer was connected to your camcorder before installation of the USB driver was completed. Reinstall the USB driver following the procedure on page 171.

If any trouble occurs

Close all running applications, then restart your computer.

Carry out the following operations after quitting the application:

- Disconnect the USB cable.
- Change the POWER switch position to others or set it to OFF (CHARGE).

Seeing the on-line help (operating instructions) of “PIXELA ImageMixer Ver.1.0 for Sony”

A “PIXELA ImageMixer Ver.1.0 for Sony” on-line help site is available where you can find the detailed operating method of “PIXELA ImageMixer Ver.1.0 for Sony.”

- (1) Click  located in the upper-right corner of the screen.
The ImageMixer’s Manual screen appears.
- (2) You can find the information you need from the list of contents.

To close on-line help

Click  at the top right of the screen.

If you have any questions about “PIXELA ImageMixer Ver.1.0 for Sony”

“PIXELA ImageMixer Ver.1.0 for Sony” is the product of PIXELA corporation. For more information, refer to the instruction manual of the CD-ROM supplied with your camcorder.

Note on using your computer

Communications with your computer

Communications between your camcorder and your computer may not recover after recovering from Suspend, Resume, or Sleep.

Viewing images recorded on a “Memory Stick” on your computer – For Windows users

Viewing images

Before operation

- You need to install the USB driver to view “Memory Stick” images on your computer. (p. 168).
An application such as Windows Media Player must be installed to play back moving pictures in Windows environment.
 - Set USBCONNECT to NORMAL in the menu settings. (The default setting is NORMAL.)
- (1) Turn on your computer and allow Windows to load.
 - (2) Insert a “Memory Stick” into your camcorder, and connect the AC power adaptor to your camcorder and then to a wall outlet.
 - (3) Set the POWER switch to MEMORY .
 - (4) Connect the Ψ (USB) jack on your camcorder with the USB port on your computer using the supplied USB cable.
USB MODE appears on the screen of your camcorder.

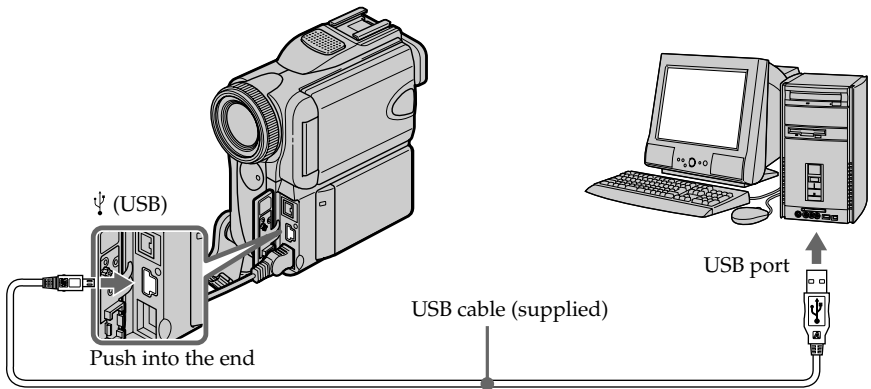

- (5) Open “My Computer” on Windows and double-click the newly recognized drive (e.g. “Removable Disk (E:)”).
The folders inside the “Memory Stick” are displayed.
- (6) Select and double-click the desired image file from the folder.
For the detailed folder and file name, see “Image file storage destinations and image files” (p. 179).

Desired file type	Double-click in this order
Still image	“Dcim” folder → “100msdcf” folder → Image file
Moving picture*	“Mssony” folder → “Moml0001” folder → Image file*

* Copying a file to the hard disk of your computer before viewing it is recommended. If you play back the file directly from the “Memory Stick,” the image and sound may break off.

Viewing images recorded on a “Memory Stick” on your computer – For Windows users

Image file storage destinations and image files

Image files recorded with your camcorder are grouped in folders by recording mode. The meanings of the file names are as follows. □□□□ stands for any number within the range from 0001 to 9999.

For Windows Me users (The drive recognizing your camcorder is [E:].)

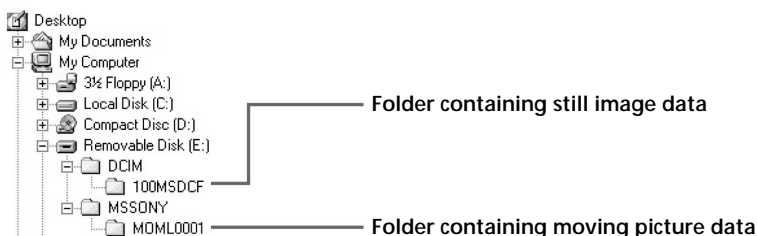

Folder	File	Meaning
100MSDCF	DSC0□□□□.JPG	Still image file
MOML0001	MOV0□□□□.MPG	Moving picture file

Disconnect the USB cable and eject the “Memory Stick” or set the POWER switch to OFF (CHARGE)

– For Windows 2000 Professional, Windows Me, Windows XP Home Edition/
Professional users

To disconnect the USB cable, eject the “Memory Stick” or set the POWER switch to OFF (CHARGE), follow the procedure below.

- (1) Move the cursor to the “Unplug or Eject Hardware” icon on the Task Tray and click to cancel the applicable drive.
- (2) After the “Safe to remove” message appears, disconnect the USB cable and eject the “Memory Stick” or set the POWER switch to OFF (CHARGE).

Connecting to your computer with USB port – For Macintosh users

When connecting to your computer with the USB port

Before connecting your camcorder to your computer, **install the USB driver** on your computer. The USB driver is packaged together with application software for viewing images on the CD-ROM supplied with your camcorder.

Recommended Macintosh environment

Mac OS 8.5.1/8.6/9.0/9.1/9.2 or Mac OS X (v10.0/v10.1)

Standard installation is required.

However, note that the upgrade to Mac OS 9.0/9.1 should be used for the following models.

- iMac with the Mac OS 8.6 standard installation and a slot loading type CD-ROM drive
- iBook or Power Mac G4 with the Mac OS 8.6 standard installation

The USB port must be provided as standard.

QuickTime 3.0 or newer must be installed (to play back moving pictures).

Notes

- Operations are not assured for the Macintosh environment if you connect two or more USB equipment to a single computer at the same time, or when using a hub.
- Some equipment may not operate depending on the type of USB equipment that is used simultaneously.
- Operations are not assured for all the recommended computer environments mentioned above.
- Macintosh and Mac OS, QuickTime are trademarks of Apple Computer Inc.
- All other product names mentioned herein may be the trademarks or registered trademarks of their respective companies. Furthermore, “™” and “®” are not mentioned in each case in this manual.

Installing the USB driver

Do not connect the USB cable to your computer before installation of the USB driver is completed.

For Mac OS 8.5.1/8.6/9.0 users

- (1) Turn on your computer and allow Mac OS to load.
- (2) Insert the supplied CD-ROM into the CD-ROM drive of your computer.
The application software screen appears.



- (3) Click the “USB Driver” to open the folder containing the six files related to “Driver.”

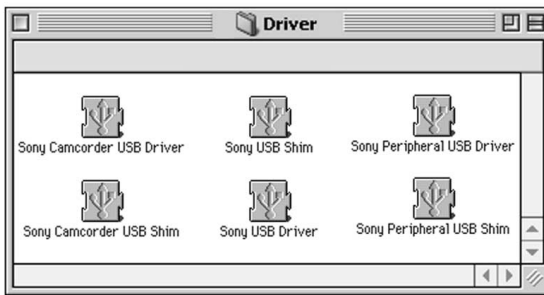

- (4) Select the following two files, and drag and drop them into the System Folder:
 - Sony Camcorder USB Driver
 - Sony Camcorder USB Shim
- (5) When the message appears, click “OK.”
The USB driver is installed on your computer.
- (6) Remove the CD-ROM from your computer.
- (7) Restart your computer.

For Mac OS 9.1/9.2/Mac OS X (v10.0/v10.1)

The USB driver need not be installed. Your Mac is automatically recognized as a driver just by connecting your Mac using the USB cable.

Viewing images recorded on a “Memory Stick” on your computer – For Macintosh users

Viewing images

Before operation

You need to install the USB driver to view “Memory Stick” images on your computer. (p. 181)

QuickTime 3.0 or newer must be installed to play back moving pictures.

- (1) Turn on your computer and allow Mac OS to load.
- (2) Insert a “Memory Stick” into your camcorder, and connect the AC power adaptor to your camcorder and then to a wall outlet.
- (3) Set the POWER switch to MEMORY.
- (4) Connect the ⏏ (USB) jack on your camcorder with the USB port on your computer using the supplied USB cable.
USB MODE appears on the screen of your camcorder.
- (5) Double click the “Memory Stick” icon on the desktop.
The folders inside the “Memory Stick” are displayed.
- (6) Select and double-click the desired image file from the folder.

Desired file type	Double-click in this order
Still image	“Dcim” folder → “100msdcf” folder → Image file
Moving picture*	“Mssony” folder → “Moml0001” folder → Image file*

* Copying a file to the hard disk of your computer before viewing it is recommended. If you play back the file directly from the “Memory Stick,” the image and sound may break off.

Disconnect the USB cable and eject the “Memory Stick” or set the POWER switch to OFF (CHARGE)

To disconnect the USB cable, eject the “Memory Stick” or set the POWER switch to OFF (CHARGE), follow the procedure below.

- (1) Close all running applications.
Make sure that the access lamp of your camcorder is not lit.
- (2) Drag the “Memory Stick” icon into the “Trash.” Alternatively, select the “Memory Stick” icon by clicking on it, and then select “Eject disk” from the “Special” menu at the top left of the screen.
- (3) Disconnect the USB cable or eject the “Memory Stick.” Set the POWER switch of your camcorder to OFF (CHARGE).

For Mac OS X (v10.0) users

Shut down your computer, then disconnect the USB cable and eject the “Memory Stick” or set the POWER switch to OFF (CHARGE).

Capturing images from an analog video unit on your computer – Signal convert function

You can capture images and sound from an analog video unit connected to your computer which has the **i** DV Interface to your camcorder.

Before operation

Set DISPLAY to LCD in the menu settings. (The default setting is LCD.)

- (1) Set the POWER switch to VCR.
- (2) Press FN to display PAGE1.
- (3) Press MENU, then set A/V → DV OUT to ON in **▼** (p. 187).
- (4) Start playback on the analog video unit.
- (5) Start capturing procedures on your computer.

The operation procedures depend on your computer and the software which you use.

For details on how to capture images, refer to the instruction manual of your computer and software.

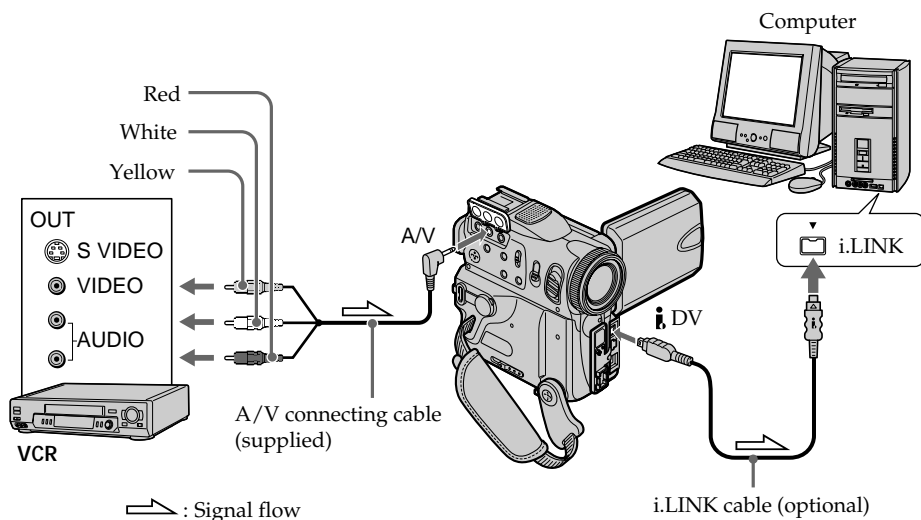

After capturing images and sound

Stop capturing procedures on your computer, and stop playback on the analog video unit.

Notes

- You need to install software which can exchange video signals.
- Depending on the condition of the analog video signals, your computer may not be able to output the images correctly when you convert video signals into digital video signals via your camcorder.
- You cannot record or capture the video output via your camcorder when the video tapes include copyright protection signals such as the ID-2 system.
- You can capture images and sound with an S video cable (optional) instead of the A/V connecting cable (supplied).

If your computer has a USB port

You can connect using a USB cable, but images may not be transferred smoothly.

Changing the menu settings

To change the mode settings in the menu settings, select the menu items with ↓/↑. The default settings can be partially changed. First, select the icon, then the menu item and the mode.

- (1) In VCR, CAMERA or MEMORY, press FN to display PAGE1.
- (2) Press MENU to display the menu.
- (3) Press ↓/↑ to select a desired icon, and press EXEC.
- (4) Press ↓/↑ to select a desired item, and press EXEC.
- (5) Press ↓/↑ to select a desired setting, and press EXEC.
- (6) Repeat steps from 3 to 5 if you want to change other items. Press ↶ RET. to return to step 3.

For details, see “Selecting the mode setting of each item” (p. 185).

1

FN

2

VCR

CAMERA

MENU

MANUAL SET

EXIT

P EFFECT
 CH
 ETC

↓ ↑ EXEC ↶RET

MEMORY

MANUAL SET

EXIT

PROGRAM AE
 FLASH MODE
 FLASH LVL
 WHT BAL
 N. S. LIGHT
 ETC

↓ ↑ EXEC ↶RET

3

↑

↓

EXEC

4

↑

↓

EXEC

5

↑



↓

EXEC

To return to FN
Press EXIT.

Changing the menu settings

Menu items are displayed as the following icons:

-  MANUAL SET
-  CAMERA SET
-  VCR SET
-  LCD/VF SET
-  MEMORY SET
-  PRINT SET
-  CM SET
-  TAPE SET
-  SETUP MENU
-  OTHERS

Selecting the mode setting of each item ● is the default setting.

Menu items differ depending on the position of the POWER switch.
The LCD screen shows only the items you can operate at the moment.

Icon/item	Mode	Meaning	POWER switch
 MANUAL SET			
PROGRAM AE	—	To suit your specific shooting requirement (p. 60)	CAMERA MEMORY
P EFFECT	—	To add special effects like those in movies or on the TV to images (p. 56, 72)	VCR CAMERA
FLASH MODE	● ON	To fire the flash (optional) regardless of the brightness of the surroundings	CAMERA MEMORY
	AUTO	To fire the flash (optional) automatically	
	AUTO ●	To fire the flash (optional) before recording to reduce the red-eye phenomenon	
FLASH LVL	HIGH	To make the flash level higher than normal	CAMERA MEMORY
	● NORMAL	To use the normal setting	
	LOW	To make the flash level lower than normal	
WHT BAL	—	To adjust the white balance (p. 49)	CAMERA MEMORY
N.S. LIGHT	● ON	To use the NightShot Light function (p. 34)	CAMERA MEMORY
	OFF	To cancel the NightShot Light function	
AUTO SHTR	● ON	To automatically activate the electronic shutter when shooting in bright conditions	CAMERA
	OFF	To not automatically activate the electronic shutter even when shooting in bright conditions	



Note on FLASH MODE and FLASH LVL

You can use FLASH MODE and FLASH LVL only when the external flash (optional) is set.

Note on FLASH LVL

You cannot adjust FLASH LVL if the external flash (optional) is not compatible with the flash level.

Changing the menu settings

Icon/item	Mode	Meaning	POWER switch
CAMERA SET			
D ZOOM	● OFF	To deactivate the digital zoom. Up to 10× zoom is carried out.	CAMERA
	20×	To activate the digital zoom. More than 10× to 20× zoom is performed digitally (p. 29).	
	120×	To activate the digital zoom. More than 10× to 120× zoom is performed digitally.	
PHOTO REC	● MEMORY	To record still images on “Memory Stick”s when you press PHOTO in tape recording or tape recording standby (p. 44)	CAMERA
	TAPE	To record still images on tape when you press PHOTO in tape recording or tape recording standby (p. 47)	
16:9WIDE	● OFF	Not to record a 16:9 wide picture	CAMERA
	ON	To record a 16:9wide picture (p. 51)	
STEADYSHOT	● ON	To compensate for camera-shake	CAMERA
	OFF	To cancel the SteadyShot function. Natural pictures are produced when shooting a stationary subject with a tripod.	
FRAME REC	● OFF	To deactivate the frame recording function	CAMERA
	ON	To activate the frame recording function (p. 69)	
INT. REC	ON	To activate the interval recording function (p. 67)	CAMERA
	● OFF	To deactivate the interval recording function	
	SET	To set INTERVAL and REC TIME for interval recording function	
EDITSEARCH	● OFF	Not to display  / - · + on the LCD screen	CAMERA
	ON	To display  / - · + on the LCD screen (p. 37)	



Notes on the SteadyShot function

- The SteadyShot function will not correct excessive camera-shake.
- Attachment of a conversion lens (optional) may influence the SteadyShot function.

If you cancel the SteadyShot function

The SteadyShot off indicator  appears. Your camcorder prevents excessive compensation for camera-shake.

Changing the menu settings

Icon/item	Mode	Meaning	POWER switch
VCR SET			
HiFi SOUND	<input checked="" type="radio"/> STEREO	To play back a stereo tape or dual sound track tape with main and sub sound (p. 204)	VCR
	1	To play back a stereo tape with the left sound or a dual sound track tape with main sound	
	2	To play back a stereo tape with the right sound or a dual sound track tape with sub sound	
AUDIO MIX	—	To adjust the balance between stereo 1 and stereo 2 (p. 105)	VCR
			
A/V → DV OUT	<input checked="" type="radio"/> OFF	To output digital images and sound in analog format using your camcorder	VCR
	ON	To output analog images and sound in digital format using your camcorder (p. 183)	
LCD/VF SET			
LCD B.L.	<input checked="" type="radio"/> BRT NORMAL	To set the brightness on the LCD screen normal	VCR CAMERA MEMORY
	BRIGHT	To brighten the LCD screen	
LCD COLOR	—	To adjust the color on the LCD screen with -/+	VCR CAMERA MEMORY
			
VF B.L.	<input checked="" type="radio"/> BRT NORMAL	To set the brightness on the viewfinder screen to normal	VCR CAMERA MEMORY
	BRIGHT	To brighten the viewfinder screen	

Notes on LCD B.L. and VF B.L.

- When you select BRIGHT, battery life is reduced by about 10 percent during recording.
- When you use power sources other than the battery pack, BRIGHT is automatically selected.

Even if you adjust LCD B.L., LCD COLOR and VF B.L.

The recorded picture will not be affected.



Changing the menu settings

Icon/item	Mode	Meaning	POWER switch
MEMORY SET			
STILL SET			
BURST	● OFF	Not to record continuously	MEMORY
	NORMAL	To record from four to 13 images continuously (p. 124)	
	EXP BRKTG	To record three images continuously with different exposure	
	MULTI SCRN	To record nine images continuously, display the images on a single page divided into nine boxes	
QUALITY	● SUPER FINE	To record still images in the finest image quality mode (p. 118)	VCR MEMORY
	FINE	To record still images in the fine image quality mode	
	STANDARD	To record still images in the standard image quality mode	
IMAGESIZE	● 1152 × 864	To record still images in 1152 × 864 size (p. 120)	MEMORY
	640 × 480	To record still images in 640 × 480 size	
MOVIE SET			
IMAGESIZE	● 320 × 240	To record moving pictures in 320 × 240 size (p. 120)	VCR MEMORY
	160 × 112	To record moving pictures in 160 × 112 size	
REMAIN	● AUTO	To display the remaining capacity of the "Memory Stick" in the following cases: <ul style="list-style-type: none"> • for five seconds after setting the POWER switch to VCR or MEMORY and inserting a "Memory Stick" • when the remaining capacity of the "Memory Stick" is less than one minute after setting the POWER switch to MEMORY • for five seconds from the start of moving picture recording • for five seconds after completing moving picture recording 	VCR MEMORY
	ON	To always display the remaining capacity of the "Memory Stick"	

When you select image quality

The number of images you can shoot in the currently selected image quality appears on the screen.

Changing the menu settings

Icon/item	Mode	Meaning	POWER switch
 MEMORY SET			
SLIDE SHOW	—	To play back images in a continuous loop (p. 155)	MEMORY
PHOTO SAVE	—	To copy still images on a tape onto a "Memory Stick" (p. 146)	VCR
FILE NO.	● SERIES	To assign numbers to file in sequence even if the "Memory Stick" is changed	VCR MEMORY
	RESET	To reset the file numbering each time the "Memory Stick" is changed	
DELETE ALL	—	To delete all the unprotected images (p. 159)	MEMORY
FORMAT	● RETURN	To cancel formatting	MEMORY
	OK	To format an inserted "Memory Stick." Formatting erases all information on the "Memory Stick." Check the contents of the "Memory Stick" before formatting. 1. Select FORMAT with ↓/↑, then press EXEC. 2. Press ↓/↑ to select OK, then press EXEC. 3. After EXECUTE appears, press EXEC. FORMATTING flashes during formatting. COMPLETE appears when formatting is finished.	
 PRINT SET			
9PIC PRINT	● RETURN	To stop 9PICS print	MEMORY
	SAME	To execute SAME PICS print (p. 161)	
	MULTI	To execute MULTI PICS print	
	MARKED	To print images with print mark arranging them in order of recording	
DATE/TIME	● OFF	To make prints without the recording date and time	MEMORY
	DATE	To make prints with the recording date (p. 162)	
	DAY&TIME	To make prints with the recording date and time	





Notes on formatting

- Do not do any of the following while FORMATTING is displayed:
 - Change the POWER switch position to others
 - Operate buttons
 - Eject the "Memory Stick"
- The "Memory Stick" supplied with your camcorder has been formatted at factory. Formatting with your camcorder is not required.
- You cannot format the "Memory Stick" if the write-protect switch on the "Memory Stick" is set to LOCK.
- Format the "Memory Stick" if "FORMAT ERROR" appears.
- Formatting erases protected image data on the "Memory Stick."

Note on PRINT SET

9PIC PRINT and DATE/TIME are displayed only when an external printer (optional) is connected to the intelligent accessory shoe.

Changing the menu settings

Icon/item	Mode	Meaning	POWER switch
 CM SET			
TITLE	—	To superimpose a title or make your own title (p. 106, 109)	VCR CAMERA
TITLEERASE	—	To erase the title you have superimposed (p. 108)	VCR CAMERA
TITLE DSPL	● ON	To display the title you have superimposed	VCR
	OFF	Not to display the title (p. 107)	
CM SEARCH	● ON	To search using cassette memory (p. 77, 78, 80)	VCR
	OFF	To search without using cassette memory (p. 79, 81)	
TAPE TITLE	—	To label a cassette (p. 111)	VCR CAMERA
ERASE ALL	—	To erase all the data in cassette memory (p. 112)	VCR CAMERA
 TAPE SET			
REC MODE	● SP	To record in the SP (Standard Play) mode	VCR CAMERA
	LP	To increase the recording time to 1.5 times the SP mode	
AUDIO MODE	● 12BIT	To record in the 12-bit mode (two stereo sounds)	VCR CAMERA
	16BIT	To record in the 16-bit mode (the one stereo sound with high quality)	
 REMAIN	● AUTO	To display the remaining tape: <ul style="list-style-type: none"> • for about eight seconds after setting the POWER switch to VCR or CAMERA and inserting a cassette, then your camcorder calculates the remaining amount of tape • for about eight seconds after setting the POWER switch to VCR or CAMERA and DISPLAY/TOUCH PANEL is pressed • for about eight seconds after setting the POWER switch to VCR and  is pressed 	VCR CAMERA
	ON	To always display the remaining tape indicator	

Notes on the LP mode

- When you record a tape in the LP mode on your camcorder, we recommend playing the tape on your camcorder. When you play back the tape on other camcorders or VCRs, noise may occur in pictures or sound.
- When you record in the LP mode, we recommend using a Sony Excellence/Master mini DV cassette so that you can get the most out of your camcorder.
- You cannot make audio dubbing on a tape recorded in the LP mode. Use the SP mode for the tape to be audio dubbed.
- When you record in the SP and LP modes on one tape or you record some scenes in the LP mode, the playback picture may be distorted or the time code may not be written properly between scenes.

Notes on AUDIO MODE

- You cannot dub audio sound on a tape recorded in the 16-bit mode.
- When playing back a tape recorded in the 16-bit mode, you cannot adjust the balance in AUDIO MIX.

Changing the menu settings

Icon/item	Mode	Meaning	POWER switch
 SETUP MENU			
CLOCK SET	—	To set the date or time (p. 19)	CAMERA MEMORY
USB STREAM	● OFF	To deactivate the USB streaming function	VCR
	ON	To activate the USB streaming function	CAMERA
USBCONNECT	● NORMAL	To connect and recognize the “Memory Stick” drive	MEMORY
	PTP	To connect and only copy a “Memory Stick” image from your camcorder to a computer (only with Windows XP Home Edition/Professional or Mac OS X) 1 Press ↓/↑ to select USBCONNECT, then press EXEC. 2 Press ↓/↑ to select PTP, then press EXEC. 3 Insert a “Memory Stick” into your camcorder, and connect your camcorder to your computer using a USB cable. Copy Wizard will automatically start up.	
LANGUAGE	● ENGLISH	To display the following information indicators in English: min, STBY, REC, CAPTURE, VOL, END SEARCH and START	VCR CAMERA MEMORY
	FRANÇAIS	To display the information indicators in French	
	ESPAÑOL	To display the information indicators in Spanish	
	PORTUGUÊS	To display the information indicators in Portuguese	
	中文	To display the information indicators in Chinese	
	한국어	To display the information indicators in Korean	
DEMO MODE	● ON	To make the demonstration appear	CAMERA
	OFF	To cancel the demonstration mode	

Notes on DEMO MODE

- You cannot select DEMO MODE when a cassette or a “Memory Stick” is inserted in your camcorder.
- DEMO MODE is set to STBY (Standby) at the default setting and the demonstration starts about 10 minutes after you have set the POWER switch to CAMERA without a cassette and “Memory Stick” inserted.
To cancel the demonstration, insert a cassette, set the POWER switch to other than CAMERA, or set DEMO MODE to OFF. To set to STBY (Standby) again, leave the DEMO MODE at ON in the menu settings, turn the POWER switch OFF (CHARGE), and return the POWER switch to CAMERA.
- If you press the touch panel during the demonstration, the demonstration stops for a while, and it starts again after about 10 minutes.
- When NIGHTSHOT is set to ON, the “NIGHTSHOT” indicator appears on the screen and you cannot select DEMO MODE in the menu settings.

Changing the menu settings

Icon/item	Mode	Meaning	POWER switch
ETC OTHERS			
DATA CODE (On the Remote Commander)	● DATE/CAM	To display date, time and various settings during playback when you press the DATA CODE button on the Remote Commander (p. 39)	VCR MEMORY
	DATE	To display date and time during playback when you press the DATA CODE button on the Remote Commander	
WORLD TIME	—	To set the clock to the local time. Press ↓/↑ to set a time difference. The clock changes by the time difference you set here. If you set the time difference to 0, the clock returns to the originally set time.	CAMERA MEMORY
BEEP	● MELODY	To output the melody when you start/stop recording or when an unusual condition occurs on your camcorder	VCR CAMERA MEMORY
	NORMAL	To output the beep instead of the melody	
	OFF	To cancel melody, the beep sound and shutter sound	
COMMANDER	● ON	To activate the Remote Commander supplied with your camcorder	VCR CAMERA MEMORY
	OFF	To deactivate the Remote Commander to avoid remote control misoperation caused by other VCR's remote control	
DISPLAY	● LCD	To show the display on the LCD screen and viewfinder	VCR CAMERA MEMORY
	V-OUT/LCD	To show the display on the TV screen, LCD screen and viewfinder	
REC LAMP	● ON	To light up the camera recording lamp at the front of your camcorder	CAMERA MEMORY
	OFF	To turn the camera recording lamp off so that the person is not aware of the recording	
VIDEO EDIT	● RETURN	To cancel video editing	VCR
	TAPE	To make programs and perform video editing (p. 85)	
	MEMORY	To make programs and perform MPEG editing (p. 143)	

Note

If you press DISPLAY/TOUCH PANEL with DISPLAY set to V-OUT/LCD in the menu settings, the picture from a TV or VCR will not appear on the LCD screen even when your camcorder is connected to the output jacks on the TV or VCR.

When recording a close subject

When REC LAMP is set to ON, the red camera recording lamp on the front of your camcorder may reflect on the subject if it is close. In this case, we recommend you set REC LAMP to OFF.

In more than five minutes after removing the power source

The PROGRAM AE, FLASH LVL, AUDIO MIX, WHT BAL, HiFi SOUND and COMMANDER items are returned to their default settings.

Other menu items are held in memory even when the battery is removed.

Types of trouble and how to correct trouble

If you run into any problem using your camcorder, use the following table to troubleshoot the problem. If the problem persists, disconnect the power source and contact your Sony dealer. If “C:□□:□□” appears on the screen, the self-diagnosis display function has activated. See page 200.

In recording

Symptom	Cause and/or Corrective Actions
START/STOP does not operate.	<ul style="list-style-type: none"> • The POWER switch is not set to CAMERA. → Set it to CAMERA (p. 24). • The tape has run out. → Rewind the tape or insert a new one (p. 21, 41). • The write-protect tab is set to expose the red mark. → Use a new cassette or slide the tab (p. 21). • The tape is stuck to the drum (moisture condensation). → Remove the cassette and leave your camcorder for at least one hour to acclimatize (p. 209).
The power goes off.	<ul style="list-style-type: none"> • While being operated in CAMERA, your camcorder has been in tape recording standby for more than five minutes. → Set the POWER switch to OFF (CHARGE) and then to CAMERA. • The battery pack is dead or nearly dead. → Install a fully charged battery pack.
You cannot record still images on a “Memory Stick” when you set the POWER switch to CAMERA.	<ul style="list-style-type: none"> • PHOTO REC is set to TAPE in the menu settings. → Set it to MEMORY (p. 186).
Tape photo recording does not work.	<ul style="list-style-type: none"> • PHOTO REC is set to MEMORY in the menu settings. → Set it to TAPE (p. 186).
The image on the viewfinder screen is not clear.	<ul style="list-style-type: none"> • Viewfinder is not extended to the end. → Pull out the viewfinder (p. 28). • The viewfinder lens is not adjusted. → Adjust the viewfinder lens (p. 28).
The SteadyShot function does not work.	<ul style="list-style-type: none"> • STEADYSHOT is set to OFF in the menu settings. → Set it to ON (p. 186).
The autofocusing function does not work.	<ul style="list-style-type: none"> • The setting is the manual focus. → Press FOCUS to set to the autofocus (p. 65). • Shooting conditions are not suitable for autofocus. → Adjust to focus manually (p. 65).
The picture does not appear in the viewfinder.	<ul style="list-style-type: none"> • The LCD panel is open. → Close the LCD panel (p. 26).
A vertical band appears when you shoot a subject such as lights or a candle flame against a dark background.	<ul style="list-style-type: none"> • The contrast between the subject and background is too high. This is not a malfunction.
A vertical band appears when you shoot a very bright subject.	<ul style="list-style-type: none"> • This is not a malfunction.
Some tiny spots in white, red, blue or green appear on the screen.	<ul style="list-style-type: none"> • SLOW SHTR, Super NightShot or Color Slow Shutter is activated. This is not a malfunction.

(continued on the following page)

Types of trouble and how to correct trouble

Symptom	Cause and/or Corrective Actions
An unknown picture is displayed on the screen.	<ul style="list-style-type: none">• If 10 minutes elapse after you set the POWER switch to CAMERA or DEMO MODE is set to ON in the menu settings without a cassette and a "Memory Stick" inserted, your camcorder automatically starts the demonstration. → Insert a cassette and a "Memory Stick" or press the LCD screen. The demonstration stops. You can also cancel DEMO MODE (p. 191).
The picture is recorded in incorrect or unnatural colors.	<ul style="list-style-type: none">• NIGHTSHOT is set to ON. → Set it to OFF (p. 32).
Picture appears too bright, and the subject does not appear on the screen.	<ul style="list-style-type: none">• NIGHTSHOT is set to ON in a bright place. → Set it to OFF (p. 32).• BACK LIGHT is active. → Set it off (p. 32).
The click of the shutter does not sound.	<ul style="list-style-type: none">• BEEP is set to OFF in the menu settings. → Set it to MELODY or NORMAL (p. 192).
Black bands appear when you record a TV screen or computer screen.	<ul style="list-style-type: none">→ Set STEADYSHOT to OFF in the menu settings (p. 186).
An external flash (optional) does not work.	<ul style="list-style-type: none">• The power of the external flash (optional) is off or the power source is not installed. → Turn on the external flash (optional) or install the power source.• Two or more external flashes (optional) are attached. → Only one external flash (optional) can be attached.

Types of trouble and how to correct trouble





In playback

Symptom	Cause and/or Corrective Actions
Playback is not possible.	<ul style="list-style-type: none">• The tape has run out. → Rewind the tape (p. 38).
There are horizontal lines on the picture or the playback picture is not clear or does not appear.	<ul style="list-style-type: none">• The video head may be dirty. → Clean the head using the cleaning cassette (optional) (p. 210).
No sound or only a low sound is heard when playing back a tape.	<ul style="list-style-type: none">• The stereo tape is played back with HiFi SOUND set to 2 in the menu settings. → Set it to STEREO (p. 187).• Volume is turned to minimum. → Turn up the volume (p. 38).• AUDIO MIX is set to ST2 in the menu settings. → Adjust AUDIO MIX (p. 187).
Displaying the record date, the date search function does not work.	<ul style="list-style-type: none">• The tape has no cassette memory. → Use a tape with cassette memory (p. 78).• CM SEARCH is set to OFF in the menu settings. → Set it to ON (p. 190).• The tape has a blank portion in the recorded portion (p. 79).
The title search function does not work.	<ul style="list-style-type: none">• The tape has no cassette memory. → Use a tape with cassette memory (p. 77).• CM SEARCH is set to OFF in the menu settings. → Set it to ON (p. 190).• There is no title in the tape. → Superimpose the titles (p. 106).• The tape has a blank portion in the recorded portion (p. 77).
New sound added to the recorded tape is not heard.	<ul style="list-style-type: none">• AUDIO MIX is set to ST1 side in the menu settings. → Adjust AUDIO MIX (p. 187).
The title is not displayed.	<ul style="list-style-type: none">• TITLE DSPL is set to OFF in the menu settings. → Set it to ON (p. 190).

(continued on the following page)

Types of trouble and how to correct trouble

In recording and playback

Symptom	Cause and/or Corrective Actions
The power does not turn on.	<ul style="list-style-type: none"> The battery pack is not installed, or is dead or nearly dead. → Install a charged battery pack (p. 14, 15). The AC power adaptor is not connected to a wall outlet. → Connect the AC power adaptor to a wall outlet (p. 18).
END SEARCH does not work.	<ul style="list-style-type: none"> The tape was ejected after recording when using a cassette without cassette memory (p. 36). You have not recorded on the new cassette yet (p. 36).
END SEARCH does not work correctly.	<ul style="list-style-type: none"> The tape has a blank portion in the beginning or middle (p. 36).
The battery pack is quickly discharged.	<ul style="list-style-type: none"> The temperature of the environment is too low. The battery pack is not fully charged. → Charge the battery pack fully again (p. 15). The battery pack is completely dead, and cannot be recharged. → Replace with a new battery pack (p. 14).
The battery remaining indicator does not indicate the correct time.	<ul style="list-style-type: none"> You have used the battery pack in an extremely hot or cold environment for a long time. The battery pack is completely dead, and cannot be recharged. → Replace with a new battery pack (p. 14). The battery is not fully charged. → Install a charged battery pack (p. 14, 15). A deviation has occurred in the remaining time. → Charge the battery pack fully again so that the indication on the battery remaining indicator is correct (p. 15).
The power goes off although the battery remaining indicator indicates that the battery pack has enough power to operate.	<ul style="list-style-type: none"> A deviation has occurred in the remaining battery time. → Charge the battery pack fully again so that the indication on the battery remaining indicator is correct (p. 15).
The cassette cannot be removed from the holder.	<ul style="list-style-type: none"> The power source is disconnected. → Connect it firmly (p. 14, 18). The battery is dead. → Use a charged battery pack (p. 14, 15).
The  and  indicators flash and no functions except for cassette ejection work.	<ul style="list-style-type: none"> Moisture condensation has occurred. → Remove the cassette and leave your camcorder for at least one hour to acclimatize (p. 209).
 indicator does not appear when using a tape with cassette memory.	<ul style="list-style-type: none"> The gold-plated connector of the tape is dirty or dusty. → Clean the gold-plated connector (p. 204).
Remaining tape indicator is not displayed.	<ul style="list-style-type: none"> The  REMAIN is set to AUTO in the menu settings. → Set it to ON to always display the remaining tape indicator (p. 188).

Types of trouble and how to correct trouble

When operating using a "Memory Stick"

Symptom	Cause and/or Corrective Actions
The "Memory Stick" does not function.	<ul style="list-style-type: none">• The POWER switch is not set to MEMORY. → Set it to MEMORY (p. 122).• A "Memory Stick" is not inserted. → Insert a "Memory Stick" (p. 115).
Recording does not function.	<ul style="list-style-type: none">• The "Memory Stick" has already been recorded to its full capacity. → Delete unnecessary images and record again (p. 157).• The "Memory Stick" formatted incorrectly is inserted. → Format the "Memory Stick" using your camcorder or use another "Memory Stick" (p. 115, 189).• The write-protect switch on the "Memory Stick" is set to LOCK. → Release the lock (p. 113).
The image cannot be deleted.	<ul style="list-style-type: none">• The image is protected. → Cancel image protection (p. 156).• The write-protect switch on the "Memory Stick" is set to LOCK. → Release the lock (p. 113).
You cannot format the "Memory Stick."	<ul style="list-style-type: none">• The write-protect switch on the "Memory Stick" is set to LOCK. → Release the lock (p. 113).
Deleting all the images cannot be carried out.	<ul style="list-style-type: none">• The write-protect switch on the "Memory Stick" is set to LOCK. → Release the lock (p. 113).
You cannot protect the image.	<ul style="list-style-type: none">• The write-protect switch on the "Memory Stick" is set to LOCK. → Release the lock (p. 113).• INDEX screen is not displayed. → Press INDEX to display the index screen then protect the image (p. 156).
You cannot write a print mark on the still image.	<ul style="list-style-type: none">• The write-protect switch on the "Memory Stick" is set to LOCK. → Release the lock (p. 113).• INDEX screen is not displayed. → Press INDEX to display the index screen, then write a print mark (p. 160).• You are trying to write a print mark on a moving picture. → Print marks cannot be written to a moving picture.
The photo save function does not work.	<ul style="list-style-type: none">• The write-protect switch on the "Memory Stick" is set to LOCK. → Release the lock (p. 113).
You cannot play back images in actual size.	<ul style="list-style-type: none">• You may not be able to play back images in actual size when you try to play back images recorded by other equipment. This is not a malfunction.
You cannot play back image data.	<ul style="list-style-type: none">• Your camcorder cannot play back some images processed with your computer. (The file name flashes.)• If you record images with any other equipment, the images may not play back normally on your camcorder.

Types of trouble and how to correct trouble

Others

Symptom	Cause and/or Corrective Actions
A title is not recorded.	<ul style="list-style-type: none">• The cassette has no cassette memory. → Use a cassette with cassette memory (p. 106).• The cassette memory is full. → Erase unnecessary title (p. 108).• The cassette is set to prevent accidental erasure. → Slide the write-protect tab so that red portion is not visible (p. 21).• The tape has a blank portion in the recorded portion. → Superimpose the title to the recorded position (p. 106).
A cassette label is not recorded.	<ul style="list-style-type: none">• The tape has no cassette memory. → Use a tape with cassette memory (p. 111).• The cassette memory is full. → Erase unwanted data (p. 108).• The tape is set to prevent accidental erasure. → Slide the write-protect tab so that red portion is not visible (p. 21).
Digital program editing to a tape does not function.	<ul style="list-style-type: none">• The input selector on the VCR is not set correctly. → Set the selector correctly, and check the connection between the VCR and your camcorder (p. 86).• The camcorder is connected to DV equipment of other than Sony using the i.LINK cable. → Set it to IR (p. 91).• Setting program on a blank portion of the tape is attempted. → Set the program again on a recorded portion (p. 94).• The synchronization of your camcorder and the VCR is not adjusted. → Adjust the synchronization of the VCR (p. 92).• The IR SETUP code is incorrect. → Set the correct code (p. 88).
Digital program editing to a "Memory Stick" does not function.	<ul style="list-style-type: none">• Setting program on a blank portion of the tape is attempted. → Set the program again on a recorded portion (p. 143).
The Remote Commander supplied with your camcorder does not work.	<ul style="list-style-type: none">• COMMANDER is set to OFF in the menu settings. → Set it to ON (p. 192).• Something is blocking the infrared rays. → Remove the obstacle.• The batteries are inserted in the battery holder with the + - polarities incorrectly matching the + - marks. → Insert the batteries with the correct polarity (p. 221).• The batteries are dead. → Insert new ones (p. 221).
The picture from a TV or VCR does not appear even when your camcorder is connected to the outputs on the TV or VCR.	<ul style="list-style-type: none">• DISPLAY is set to V-OUT/LCD in the menu settings. → Set it to LCD (p. 192).

Types of trouble and how to correct trouble

Symptom	Cause and/or Corrective Actions
The melody or beep sounds for five seconds.	<ul style="list-style-type: none"> • Moisture condensation has occurred. <ul style="list-style-type: none"> → Remove the cassette and leave your camcorder for at least one hour to acclimatize (p. 209). • Some troubles have occurred in your camcorder. <ul style="list-style-type: none"> → Remove the cassette and insert it again, then operate your camcorder.
No function works though the power is on.	<ul style="list-style-type: none"> → Disconnect the AC power adaptor from a wall outlet or remove the battery, then reconnect it in about one minute. Turn the power on. If the functions still do not work, press the RESET button using a sharp-pointed object. (If you press the RESET button, all the settings including the date and time return to the default) (p. 14, 18, 219).
When you set the POWER switch to VCR or OFF (CHARGE), if you move your camcorder, you may hear a clattering sound from inside your camcorder.	<ul style="list-style-type: none"> • This is because some functions use a linear mechanism. Your camcorder is not malfunctioning.
While charging the battery pack, the CHARGE lamp does not light up.	<ul style="list-style-type: none"> • Charging is completed. • The battery pack is not properly installed. <ul style="list-style-type: none"> → Install it properly (p. 14).
You cannot charge the battery pack.	<ul style="list-style-type: none"> • The POWER switch is not set to OFF (CHARGE). <ul style="list-style-type: none"> → Set it to OFF (CHARGE) (p. 15).
While charging the battery pack, the CHARGE lamp flashes.	<ul style="list-style-type: none"> • The battery pack is not properly installed. <ul style="list-style-type: none"> → Install it properly (p. 14). • Something is wrong with the battery pack. <ul style="list-style-type: none"> → Please contact your Sony dealer or local authorized Sony service facility.
The buttons do not appear on the touch panel.	<ul style="list-style-type: none"> • DISPLAY/TOUCH PANEL is pressed. <ul style="list-style-type: none"> → Press the LCD screen lightly. → Press DISPLAY/TOUCH PANEL on your camcorder or DISPLAY on the Remote Commander (p. 39).
The buttons on the LCD screen do not work.	<ul style="list-style-type: none"> → Adjust the screen (CALIBRATION) (p. 211).
The indicators appear mirror-reversed in the viewfinder.	<ul style="list-style-type: none"> • The mirror mode is activated. This is not a malfunction (p. 30).
Image data cannot be transferred by the USB connection.	<ul style="list-style-type: none"> • The USB cable was connected before installation of the USB driver was completed. <ul style="list-style-type: none"> → Uninstall the incorrect USB driver and re-install the USB driver (p. 168, 171). • USBCONNECT is set to PTP when the POWER switch is set to MEMORY. <ul style="list-style-type: none"> → Set it to NORMAL (p. 191).
A cassette cannot be removed even if the cassette lid is open.	<ul style="list-style-type: none"> • Moisture condensation has started to condense in your camcorder (p. 209).

Self-diagnosis display

Your camcorder has a self-diagnosis display function.

This function displays the current condition of your camcorder as a 5-digit code (a combination of a letter and figures) on the screen. If a 5-digit code is displayed, check the following code chart. The last two digits (indicated by □□) will differ depending on the state of your camcorder.

LCD screen or Viewfinder

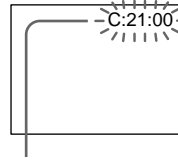

Self-diagnosis display

- C:□□:□□
You can service your camcorder yourself.
- E:□□:□□
Contact your Sony dealer or local authorized Sony facility.

5-digit display	Cause and/or Corrective Actions
C:04:□□	<ul style="list-style-type: none"> • You are using a battery pack that is not an "InfoLITHIUM" battery pack. → Use an "InfoLITHIUM" battery pack (p. 17, 205).
C:21:□□	<ul style="list-style-type: none"> • Moisture condensation has occurred. → Remove the cassette and leave your camcorder for at least one hour to acclimatize (p. 209).
C:22:□□	<ul style="list-style-type: none"> • The video heads are dirty. → Clean the heads using the cleaning cassette (optional) (p. 210).
C:31:□□ C:32:□□	<ul style="list-style-type: none"> • A malfunction other than the above that you can service has occurred. → Remove the cassette and insert it again, then operate your camcorder. → Disconnect the power cord of the AC adaptor or remove the battery pack. After reconnecting the power source, operate your camcorder.
E:20:□□ E:61:□□ E:62:□□	<ul style="list-style-type: none"> • A malfunction that you cannot service has occurred. → Contact your Sony dealer or local authorized Sony service facility and inform them of the 5-digit code. (e.g. E:61:10)

If you are unable to rectify the problem even if you try corrective actions a few times, contact your Sony dealer or local authorized Sony service facility.

Warning indicators and messages

If indicators and messages appear on the screen, check the following:
See the page in parentheses “()” for more information.

Warning indicators

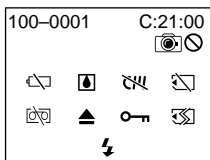

100-0001 Warning indicator as to file

Slow flashing:

- The file is corrupted.
- The file is unreadable.
- You are trying to carry out MEMORY MIX function on moving picture (p. 133).

C:21:00 Self-diagnosis display (p. 200)

The battery is dead or nearly dead

Slow flashing:

- The battery is nearly dead.
Depending on operational, environmental or battery conditions the  indicator may flash, even if there are approximately five to 10 minutes remaining.

Fast flashing:

- The battery is dead.

Moisture condensation has occurred*

Fast flashing:

- Eject the cassette, turn off your camcorder, and leave it for about one hour with the cassette compartment open (p. 209).

Warning indicator as to cassette memory*

Slow flashing:

- No cassette with cassette memory is inserted (p. 203).

Warning indicator as to “Memory Stick”*

Slow flashing:

- No “Memory Stick” is inserted.
- The write-protect switch on the “Memory Stick” is set to LOCK (p. 113).

Fast flashing:

- The “Memory Stick” is not readable with your camcorder (p. 113).
- The image cannot be recorded on “Memory Stick.”

Warning indicator as to “Memory Stick” formatting*

Fast flashing:

- “Memory Stick” is not formatted correctly (p. 189).
- The “Memory Stick” data is corrupted (p. 113).

Warning indicator as to tape

Slow flashing:

- The tape is near the end.
- No tape is inserted.*
- The write-protect tab of the cassette is effective (red) (p. 21).*

Fast flashing:

- The tape has run out.*

You need to eject the cassette*

Slow flashing:

- The write-protect tab of the cassette is effective (red) (p. 21).

Fast flashing:

- Moisture condensation has occurred (p. 209).
- The tape has run out.
- The self-diagnosis display function is activated (p. 200).

The image is protected*

Slow flashing:

- The image is protected (p. 156).
- The write-protect switch on the “Memory Stick” is set to LOCK (p. 113).

Warning indicator as to the flash (optional)

Slow flashing:

- During charging*.

Fast flashing:

- There is something wrong with the external flash (optional).

Warning indicator as to still image recording























Slow flashing:

- The still image cannot be recorded on a tape or a “Memory Stick.”

* You hear the melody or beep sound.













Warning indicators and messages

Warning messages

- **CLOCK SET** Set the date and time (p. 19).
- **FOR "InfoLITHIUM" BATTERY ONLY** Use an "InfoLITHIUM" battery pack (p. 17).
-  **CLEANING CASSETTE** The video heads are dirty (p. 210). The  indicator and "CLEANING CASSETTE" message appear one after another on the screen.
- **COPY INHIBIT** You tried to record a picture that has a copyright control signal (p. 203).*
-  **FULL** The cassette memory is full (p. 107).*
-  **16BIT** AUDIO MODE is set to 16BIT.* You cannot dub new sound (p. 190).
-  **REC MODE** REC MODE is set to LP.* You cannot dub new sound (p. 190).
-  **TAPE** There is no recorded portion on the tape.* You cannot dub new sound.
-  **"i.LINK" CABLE** i.LINK cable is connected.* You cannot dub new sound (p. 105).
-  **FULL** The "Memory Stick" is full (p. 125).*
-  **LOCK** The write-protect switch on the "Memory Stick" is set to LOCK (p. 113).*
-  **NO FILE** No image is recorded on the "Memory Stick".*
-  **NO MEMORY STICK** No "Memory Stick" is inserted.*
-  **NO STILL IMAGE FILE** You select MULTI in 9PIC PRINT in the menu settings using a "Memory Stick" containing no still image.*
-  **AUDIO ERROR** You are trying to record an image with sound that cannot be recorded by your camcorder on "Memory Stick" (p. 140).*
-  **MEMORY STICK ERROR** The "Memory Stick" data is corrupted.*
-  **FORMAT ERROR** The "Memory Stick" is not recognized (p. 115, 189).* Check the format.
-  **DIRECTORY ERROR** There is more than two same directories (p. 148).*
-  **PLAY ERROR** The image is distorted and cannot be played back.*
-  **REC ERROR** Check the input signal, then record again.*
-  **TAPE END** The tape has reached the end of the tape.*
-  **NO TAPE** Insert a cassette.*
-  **NO PRINT MARK** You selected MARKED in 9PIC PRINT in the menu settings using a "Memory Stick" contains no image with a print mark (p. 162).*
- **DELETING** You press the PHOTO button on your camcorder while deleting data in a "Memory Stick."*
- **FORMATTING** You press the PHOTO button on your camcorder while formatting a "Memory Stick."*
-  **NOW CHARGING** Charging an external flash (optional) does not work correctly.*

Usable cassettes

Selecting cassette types

You can use the mini DV  cassette only.* You cannot use any other 8 mm , Hi8 , Digital8 , VHS , VHSC , S-VHS , S-VHSC , Betamax , ED Betamax , DV  or MICRO MV  cassette.

* There are two types of mini DV cassettes: with cassette memory and without cassette memory.

Tapes with cassette memory have  (Cassette Memory) mark.

We recommend that you use cassettes with cassette memory.

IC memory is mounted on this type of cassette. Your camcorder can read and write data such as dates of recording or titles, etc. to this memory.

The functions using the cassette memory require successive signals recorded on the tape. If the tape has a blank portion at the beginning or between recorded portions, titles may not be displayed properly or the search functions may not work properly. Perform the following to prevent a blank portion from being made on the tape.



Press END SEARCH to go to the end of the recorded portion before you begin the next recording if you operate the following:

- You have ejected the cassette during recording.
- You have played back the tape.
- You have used EDITSEARCH.

If there is a blank portion or discontinuous signal on your tape, re-record from the beginning to the end of the tape as described above.

The same result may occur when you record using a digital video camera recorder without a cassette memory on a tape recorded by one with the cassette memory.

4K mark on the cassette

The memory capacity of tapes marked with 4K is 4K bits. Your camcorder can accommodate up to 16K bits. 16K bits tape is marked with 16K.

 This is the Mini DV mark.

 This is the Cassette Memory mark.

These are trademarks.

Copyright signal

When you play back

If the tape you play back on your camcorder contains copyright signals, you cannot copy it with another video camera connected to your camcorder.

When you record

You cannot record software on your camcorder that contains copyright control signals for copyright protection of software.

COPY INHIBIT appears on the screen, or on the TV screen if you try to record such software. Your camcorder does not record copyright control signals on the tape when it records.

Usable cassettes

Audio mode

12-bit mode: The original sound can be recorded in stereo 1, and the new sound in stereo 2 in 32 kHz. The balance between stereo 1 and stereo 2 can be adjusted by selecting AUDIO MIX in the menu settings during playback. Both sounds can be played back.

16-bit mode: A new sound cannot be recorded but the original sound can be recorded in high quality. Moreover, it can also play back sound recorded in 32 kHz, 44.1 kHz or 48 kHz. When playing back a tape recorded in the 16-bit mode, 16BIT indicator appears on the screen.

When you play back a dual sound track tape

When you play back a dual sound track tape recorded in a stereo system, set HiFi SOUND to the desired mode in the menu settings (p. 187).

Sound from speaker

HiFi Sound Mode	Playing back a stereo tape	Playing back a dual sound track tape
STEREO	Stereo	Main sound and sub sound
1	Lch	Main sound
2	Rch	Sub sound

You cannot record dual sound programs on your camcorder.

Notes on the cassette

When affixing a label on the cassette

Be sure to affix a label only on the locations as illustrated below [a] so as not to cause malfunction of your camcorder.

After using the cassette

Rewind the tape to the beginning, put the cassette in its case, and store it in an upright position.

When the cassette memory function does not work

Reinsert a cassette. The gold-plated connector of mini DV cassettes may be dirty or dusty.

Cleaning gold-plated connector

If the gold-plated connector on the cassette is dirty or dusty, the remaining tape indicator is sometimes not displayed correctly, and you may not be able to operate functions using cassette memory. Clean up the gold-plated connector with a cotton-wool swab, about every 10 times ejection of a cassette. [b]

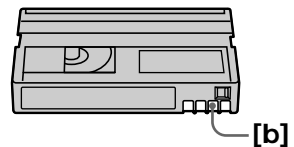
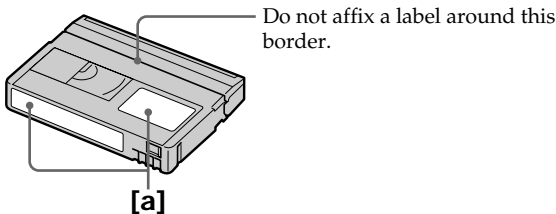

About the “InfoLITHIUM” battery pack

What is the “InfoLITHIUM” battery pack?

The “InfoLITHIUM” battery pack is a lithium-ion battery pack that has functions for communicating information related to operating conditions between your camcorder and an optional AC adaptor/charger.

The “InfoLITHIUM” battery pack calculates the power consumption according to the operating conditions of your camcorder, and displays the remaining battery time in minutes. With an AC adaptor/charger (optional), the remaining battery time and charging time are displayed.

Charging the battery pack

- Be sure to charge the battery pack before you start using your camcorder.
- We recommend charging the battery pack in an ambient temperature of between 10 °C to 30 °C (50 °F to 86 °F) until the CHARGE lamp goes off. If you charge the battery outside of this temperature range, you may not be able to efficiently charge the battery pack.
- After charging is completed, either disconnect the cable from the DC IN jack on your camcorder or remove the battery pack.

Effective use of the battery pack

- Battery pack performance decreases in low-temperature surroundings. So, the time that the battery pack can be used becomes shorter. We recommend the following to use the battery pack longer:
 - Put the battery pack in a pocket to warm it up, and insert it in your camcorder immediately before you start taking shots.
 - Use the large capacity battery pack (NP-FM70/QM71/FM90/FM91/QM91, optional).
- Frequently using the LCD panel or frequently operating playback, fast forward or rewind wears out the battery pack faster. We recommend using the large capacity battery pack (NP-FM70/QM71/FM90/FM91/QM91, optional).
- Be certain to turn the POWER switch to OFF (CHARGE) when not taking shots or playing back on your camcorder. The battery pack is also consumed when your camcorder is in tape recording standby or playback pause.
- Have spare battery packs handy for two or three times the expected recording time, and make trial recordings before taking the actual recording.
- Do not expose the battery pack to water. The battery pack is not water resistant.

Remaining battery time indicator

- If the power goes off although the remaining battery time indicator indicates that the battery pack has enough power to operate, charge the battery pack fully again so that the indication on the remaining battery time indicator is correct. Note, however, that the correct battery indication sometimes will not be restored if it is used in high temperatures for a long time or left in a fully charged state, or the battery pack is frequently used. Regard the remaining battery time indication as the approximate shooting time.
- The  mark indicating little remaining battery time sometimes flashes depending on the operating conditions or ambient temperature and environment even if the remaining battery time is about five to 10 minutes.

How to store the battery pack

- If the battery pack is not used for a long time, do the following procedure once per year to maintain proper function.
 1. Fully charge the battery.
 2. Discharge on your electronic equipment.
 3. Remove the battery from the equipment and store it in a dry, cool place.
- To use the battery pack up on your camcorder, leave your camcorder in tape recording standby until the power goes off without a cassette inserted.

Battery life

- The battery life is limited. Battery capacity drops little by little as you use it more and more, and as time passes. When the available battery time is shortened considerably, a probable cause is that the battery pack has reached the end of its life. Please buy a new battery pack.
- The battery life varies depending on how it is stored and operating conditions and environment for each battery pack.

About i.LINK

The DV Interface on this unit is an i.LINK-compliant DV input/output Interface. This section describes the i.LINK standard and its features.

What is i.LINK?

i.LINK is a digital serial interface for handling digital video, digital audio and other data in two directions between equipment having the i.LINK, and for controlling other equipment.

i.LINK-compatible equipment can be connected by a single i.LINK cable. Possible applications are operations and data transactions with various digital AV equipment. When two or more i.LINK-compatible equipment are connected to this unit in a daisy chain, operations and data transactions are possible with not only the equipment that this unit is connected to but also with other devices via the directly connected equipment.

Note, however, that the method of operation sometimes varies according to the characteristics and specifications of the equipment to be connected, and that operations and data transactions are sometimes not possible on some connected equipment.

Note

Normally, only one piece of equipment can be connected to this unit by the i.LINK cable. When connecting this unit to i.LINK-compatible equipment having two or more DV Interfaces, refer to the instruction manual of the equipment to be connected.

About the name “i.LINK”

i.LINK is a more familiar term for IEEE 1394 data transport bus proposed by SONY, and is a trademark approved by many corporations. IEEE 1394 is an international standard standardized by the Institute of Electrical and Electronics Engineers.

i.LINK Baud rate

i.LINK's maximum baud rate varies according to the equipment. Three maximum baud rates are defined:

- S100 (approx. 100Mbps*)
- S200 (approx. 200Mbps)
- S400 (approx. 400Mbps)

The baud rate is listed under “Specifications” in the instruction manual of each equipment. It is also indicated near the i.LINK on some equipment.

The maximum baud rate of equipment on which it is not indicated such as this unit is “S100.”

When units are connected to equipment having a different maximum baud rate, the baud rate sometimes differs from the indicated baud rate.

*What is Mbps?

Mbps stands for megabits per second, or the amount of data that can be sent or received in one second. For example, a baud rate of 100Mbps means that 100 megabits of data can be sent in one second.

About i.LINK

i.LINK functions on this unit

For details on how to dub when this unit is connected to other video equipment having DV Interface, see page 84 and 98.

This unit can also be connected to other i.LINK (DV Interface) compatible equipment made by SONY (e.g. VAIO series personal computer) other than video equipment. Before connecting this unit to your computer, make sure that application software supported by this unit is already installed on your computer.

For details on precautions when connecting this unit, also refer to the instruction manuals for the equipment to be connected.

Required i.LINK Cable

Use the Sony i.LINK 4-pin-to-4-pin cable (during DV dubbing).

i.LINK and  are trademarks.

Using your camcorder abroad

Using your camcorder abroad

You can use your camcorder in any country or area with the AC power adaptor supplied with your camcorder within 100 V to 240 V AC, 50/60 Hz.

When charging the battery pack, use a commercially available AC plug adaptor [a], if necessary, depending on the design of the wall outlet [b].

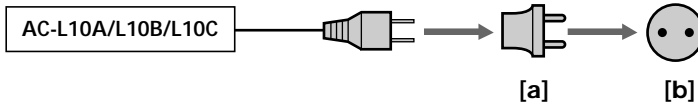

Your camcorder is a NTSC system based camcorder. If you want to view the playback picture on a TV, it must be a NTSC system based TV with AUDIO/VIDEO input jack. The following shows TV color systems used overseas.

NTSC system

Bahama Islands, Bolivia, Canada, Central America, Chile, Colombia, Ecuador, Guyana, Jamaica, Japan, Korea, Mexico, Peru, Surinam, Taiwan, the Philippines, the U.S.A., Venezuela, etc.

PAL system

Australia, Austria, Belgium, China, Czech Republic, Denmark, Finland, Germany, Holland, Hong Kong, Hungary, Italy, Kuwait, Malaysia, New Zealand, Norway, Poland, Portugal, Singapore, Slovak Republic, Spain, Sweden, Switzerland, Thailand, United Kingdom, etc.

PAL-M system

Brazil

PAL-N system

Argentina, Paraguay, Uruguay

SECAM system



Bulgaria, France, Guiana, Iran, Iraq, Monaco, Russia, Ukraine, etc.

Simple setting of clock by time difference



You can easily set the clock to the local time by setting a time difference. Select WORLD TIME in the menu settings. See page 192 for more information.

Maintenance information and precautions

Moisture condensation

If your camcorder is brought directly from a cold place to a warm place, moisture may condense inside your camcorder, on the surface of the tape, or on the lens. In this condition, the tape may stick to the head drum and be damaged or your camcorder may not operate correctly. If there is moisture inside your camcorder, the beep sounds and the  indicator flashes. When the  indicator flashes at the same time, the cassette is inserted in your camcorder. If moisture condenses on the lens, the indicator will not appear.

If moisture condensation has occurred

None of the functions except cassette ejection will work. Eject the cassette, turn off your camcorder, and leave it for about one hour with the cassette lid open. Your camcorder can be used again if the  or  indicator does not appear when the power is turned on again.

If moisture starts to condense, your camcorder sometimes cannot detect condensation. If this happens, the cassette is sometimes not ejected for 10 seconds after the cassette lid is opened. This is not a malfunction. Do not close the cassette lid until the cassette is ejected.

Note on moisture condensation

Moisture may condense when you bring your camcorder from a cold place into a warm place (or vice versa) or when you use your camcorder in a hot place as follows:

- You bring your camcorder from a ski slope into a place warmed up by a heating device.
- You bring your camcorder from an air-conditioned car or room into a hot place outside.
- You use your camcorder after a squall or a shower.
- You use your camcorder in a high temperature and humidity place.

How to prevent moisture condensation

When you bring your camcorder from a cold place into a warm place, put your camcorder in a plastic bag and tightly seal it. Remove the bag when the air temperature inside the plastic bag has reached the surrounding temperature (after about one hour).

Maintenance information and precautions

Maintenance information

Cleaning the video head

To ensure normal recording and clear pictures, clean the video head. The video head may be dirty when:

- mosaic-pattern noise appears on the playback picture.
- playback pictures do not move.
- playback pictures do not appear.
- the **X** indicator and "CLEANING CASSETTE" message appear one after another or the **X** indicator flashes on the screen during recording.

If the above problem, [a], [b] or [c] occurs, clean the video heads for 10 seconds with the Sony DVM-12CLD cleaning cassette (optional). Check the picture and if the above problem persists, repeat cleaning.

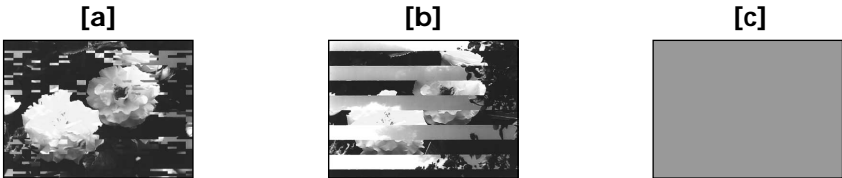

If the video heads get dirtier, the entire screen becomes blue [c].

Note on the video head

The video head suffers from wear after long use. If you cannot obtain a clear image even after using a cleaning cassette, it might be because the video head is worn. Please contact your Sony dealer or local authorized Sony service facility to have the video head replaced.

Cleaning the LCD screen

If fingerprints or dust make the LCD screen dirty, we recommend using a LCD cleaning cloth (supplied) to clean the LCD screen. When you use the LCD Cleaning Kit (optional), do not apply the cleaning liquid directly to the LCD screen. Clean the LCD screen with cleaning paper moistened with the liquid.

Removing dust from inside the viewfinder

- (1) Pull out the viewfinder in the direction of the arrow ①.
Remove the two screws in the direction of the arrow ② with a screwdriver (optional).
Remove the eyecup in the direction of the arrow ③.

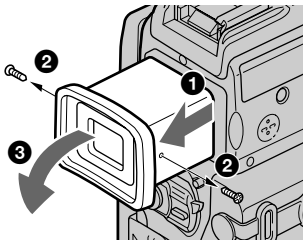

- (2) Remove dust from inside the eyecup and viewfinder with a commercially available blower.
- (3) In the reverse way of (1), attach the eyecup.

Maintenance information and precautions

Caution

Do not remove any other screws. You may remove only the screw to remove the eyecup.

Notes

- Do not drop or bend the eyecup shaft.
- Be careful when handling the eyecup.

Charging the built-in rechargeable battery

Your camcorder has a built-in rechargeable battery so that the date, time and other settings are retained even when the POWER switch is turned off. The built-in rechargeable battery is always charged as long as you are using your camcorder. The battery, however, will get discharged gradually if you do not use your camcorder. It will be completely discharged in **about three months** if you do not use your camcorder at all. Even if the built-in rechargeable battery is not charged, it will not affect the camcorder operation. To retain the date and time, etc., charge the battery if the battery is discharged.

Charging the built-in rechargeable battery

- Connect your camcorder to the house current using the AC adaptor supplied with your camcorder, and leave your camcorder with the POWER switch turned off for more than 24 hours.
- Or install the fully charged battery pack in your camcorder, and leave your camcorder with the POWER switch set to OFF (CHARGE) for more than 24 hours.

Adjusting the LCD screen (CALIBRATION)

The buttons on the touch panel may not work correctly. If this happens, follow the procedure below.

- (1) Set the POWER switch to OFF (CHARGE).
- (2) Eject the tape from your camcorder, then disconnect any connecting cable from your camcorder.
- (3) Set the POWER switch to VCR while pressing DISPLAY/TOUCH PANEL on your camcorder, then keep pressing DISPLAY/TOUCH PANEL for about five seconds.
- (4) Follow the procedure below using an object such as the corner of a "Memory Stick."
 - ① Touch **X** at the upper left corner.
 - ② Touch **X** at the lower right corner.
 - ③ Touch **X** in the middle of the screen.

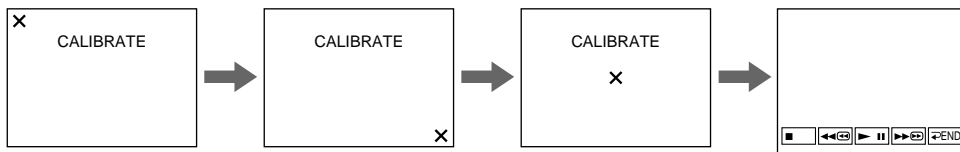

Note

If you do not press the right spot, **X** always returns to the position at the upper left corner. In this case, start from step 4 again.

Precautions

Camcorder operation

- Operate your camcorder on 7.2 V (battery pack) or 8.4 V (AC adaptor).
- For DC or AC operation, use the accessories recommended in this operating instructions.
- If any solid object or liquid get inside the casing, unplug your camcorder and have it checked by a Sony dealer before operating it any further.
- Avoid rough handling or mechanical shock. Be particularly careful of the lens.
- Keep the POWER switch set to OFF (CHARGE) when you are not using your camcorder.
- Do not wrap your camcorder with a towel, for example, and operate it. Doing so might cause heat to build up inside.
- Keep your camcorder away from strong magnetic fields or mechanical vibration.
- Do not press the LCD screen with a sharp-pointed object.
- If your camcorder is used in a cold place, a residual image may appear on the LCD screen. This is not a malfunction.
- While using your camcorder, the back of the LCD screen may heat up. This is not a malfunction.

On handling tapes

- Do not insert anything into the small holes on the rear of the cassette. These holes are used to sense the type and thickness of the tape and if the recording tab is in or out.
- Do not open the tape protect cover or touch the tape.
- Avoid touching or damaging the terminals. To remove dust, clean the terminals with a soft cloth.

Camcorder care

- Remove the tape, and periodically turn on the power, operate the CAMERA and VCR sections and play back a tape for about three minutes when your camcorder is not to be used for a long time.
- Clean the lens with a soft brush to remove dust. If there are fingerprints on the lens, remove them with a soft cloth.
- Clean the camcorder body with a dry soft cloth, or a soft cloth lightly moistened with a mild detergent solution. Do not use any type of solvent which may damage the finish.
- Do not let sand get into your camcorder. When you use your camcorder on a sandy beach or in a dusty place, protect it from the sand or dust. Sand or dust may cause your camcorder to malfunction, and sometimes this malfunction cannot be repaired.

AC power adaptor

- Unplug the unit from a wall outlet when you are not using the unit for a long time. To disconnect the power cord, pull it out by the plug. Never pull the power cord itself.
- Do not operate the unit with a damaged cord or if the unit has been dropped or damaged.
- Do not bend the power cord forcibly, or place a heavy object on it. This will damage the cord and may cause fire or electrical shock.
- Prevent metallic objects from coming into contact with the metal parts of the connecting section. If this happens, a short may occur and the unit may be damaged.
- Always keep metal contacts clean.
- Do not disassemble the unit.
- Do not apply mechanical shock or drop the unit.
- While the unit is in use, particularly during charging, keep it away from AM receivers and video equipment. AM receivers and video equipment disturb AM reception and video operation.
- The unit becomes warm during use. This is not a malfunction.
- Do not place the unit in locations that are:
 - Extremely hot or cold
 - Dusty or dirty
 - Very humid
 - Vibrating

About care and storage of the lens

- Wipe the surface of the lens clean with a soft cloth in the following instance:
 - When there are fingerprints on the lens surface
 - In hot or humid locations
 - When the lens is used in environments such as the seaside
- Store the lens in a well-ventilated location subject to little dirt or dust.

To prevent mold from occurring, periodically perform the above.

We recommend turning on and operating the video camera recorder about once per month to keep the video camera recorder in an optimum state for a long time.

Battery pack

- Use only the specified charger or video equipment with the charging function.
- To prevent an accident from a short circuit, do not allow metal objects to come into contact with the battery terminals.
- Keep the battery pack away from fire.
- Never expose the battery pack to temperatures above 60 °C (140 °F), such as in a car parked in the sun or under direct sunlight.
- Store the battery pack in a cool, dry place.
- Do not expose the battery pack to any mechanical shock.
- Do not disassemble nor modify the battery pack.
- Attach the battery pack to the video equipment securely.
- Charging while some capacity remains does not affect the original battery capacity.

Note on dry batteries

To avoid possible damage from battery leakage or corrosion, observe the following:

- Be sure to insert the batteries with the + – polarities matched to the + – marks.
- Dry batteries are not rechargeable.
- Do not use a combination of new and old batteries.
- Do not use different types of batteries.
- Current flows from batteries when you are not using them for a long time.
- Do not use leaking batteries.

If batteries are leaking

- Wipe off the liquid in the battery compartment carefully before replacing the batteries.
- If you touch the liquid, wash it off with water.
- If the liquid get into your eyes, wash your eyes with a lot of water and then consult a doctor.

If any problem occurs, unplug your camcorder and contact your nearest Sony dealer.

Specifications

Video camera recorder

System

Video recording system

2 rotary heads

Helical scanning system

Audio recording system

2 rotary heads, PCM system

Quantization: 12 bits (Fs 32 kHz, stereo 1, stereo 2), 16 bits (Fs 48 kHz, stereo)

Video signal

NTSC color, EIA standards

Usable cassette

Mini DV cassette with the  mark printed

Tape speed

SP: Approx. 18.81 mm/s

LP: Approx. 12.56 mm/s

Recording/playback time (using cassette DVM60)

SP: 1 hour

LP: 1.5 hours

Fastforward/rewind time (using cassette DVM60)

When using the battery pack:
Approx. 2 min. and 30 seconds

When using the AC power adaptor:

Approx. 1 min. and 45 seconds

Viewfinder

Electric viewfinder (color)

Image device

3.8 mm (1/4.7 type) CCD

(Charge Coupled Device)

Gross: Approx. 1 070 000 pixels

Effective (still):

Approx. 1 000 000 pixels

Effective (moving):

Approx. 690 000 pixels

Lens

Carl Zeiss

Combined power zoom lens

Filter diameter 30 mm. (1 3/16 in.)

10× (Optical), 120× (Digital)

F = 1.8 - 2.0

Focal length

3.7 - 37 mm (5/32 - 1 1/2 in.)

When converted to a 35 mm still camera



In CAMERA:

50 - 500 mm (2 - 19 3/4 in.)

In MEMORY:

42 - 420 mm (1 11/16 - 16 5/8 in.)

Color temperature

Auto, HOLD (Hold),  Indoor (3 200K),  Outdoor (5 800K)

Minimum illumination

7 lx (lux) (F 1.8)

0 lx (lux) (in the NightShot mode)*

* Objects unable to be seen due to the dark can be shot with infrared lighting.

Input/Output connectors

S video input/output

4-pin mini DIN

Luminance signal: 1 Vp-p,

75 Ω (ohms), unbalanced, sync negative

Chrominance signal: 0.286 Vp-p, 75 Ω (ohms), unbalanced

A/V (Audio/Video) input/output

AV MINI JACK, input/output auto switch

Video signal: 1 Vp-p, 75 Ω (ohms), unbalanced, sync negative

Audio signal: 327 mV, (at output impedance more than 47 kΩ (kilohms))

Input impedance with more than 47 kΩ (kilohms)

Output impedance with less than 2.2 kΩ (kilohms)

DV input/output

4-pin connector

Headphone jack

Stereo minijack (ø 3.5 mm)

LANC jack

Stereo mini-minijack (ø 2.5 mm)

USB jack

mini-B

MIC jack

Minijack, 0.388 mV low impedance with 2.5 to 3.0 V DC, output impedance 6.8 kΩ (kilohms)

(ø 3.5 mm)

Stereo type

LCD screen

Picture

6.2 cm (2.5 type)

50.3 × 37.4 mm (2 × 1 1/2 in.)

Total dot number

211 200 (960 × 220)

General

Power requirements

7.2 V (battery pack)

8.4 V (AC power adaptor)

Average power consumption (when using the battery pack)

During camera recording using

LCD: 4.0 W
Viewfinder: 3.3 W

Operating temperature

0 °C to 40 °C (32 °F to 104 °F)

Storage temperature

-20 °C to +60 °C (-4 °F to +140 °F)

Dimensions (approx.)

55 × 105 × 99 mm

(2 1/4 × 4 1/4 × 4 in.) (w/h/d)

Mass (approx.)

480 g (1 lb 0 oz)

excluding the battery pack and cassette

580 g (1 lb 4 oz)

including the battery pack,

NP-FM50, cassette DVM60 and lens cap

Supplied accessories

See page 3.

AC power adaptor

Power requirements

100 - 240 V AC, 50/60 Hz

Power consumption

23 W

Output voltage

DC OUT: 8.4 V, 1.5 A during operation

Operating temperature

0 °C to 40 °C (32 °F to 104 °F)

Storage temperature

-20 °C to +60 °C (-4 °F to +140 °F)

Dimensions (approx.)

125 × 39 × 62 mm

(5 × 1 9/16 × 2 1/2 in.) (w/h/d)

excluding projecting parts

Mass (approx.)

280 g (9.8 oz)

excluding the power cord

Specifications

Battery pack

Maximum output voltage

DC 8.4 V

Output voltage

DC 7.2 V

Capacity

8.5 Wh (1 180 mAh)

Dimensions (approx.)

38.2 × 20.5 × 55.6 mm

(1 9/16 × 13/16 × 2 1/4 in.)

(w/h/d)

Mass (approx.)

76 g (2.7 oz)

Type

Lithium ion

“Memory Stick”

Memory

Flash memory

8MB: MSA-8A

Operating voltage

2.7-3.6V

Power consumption

Approx. 45mA during operation

Approx. 130µA in tape recording
standby

Dimensions (approx.)

50 × 2.8 × 21.5 mm

(2 × 1/8 × 7/8 in.) (w/h/d)

Mass (approx.)

4 g (0.14 oz)

Design and specifications are
subject to change without notice.

Identifying the parts and controls

Camcorder

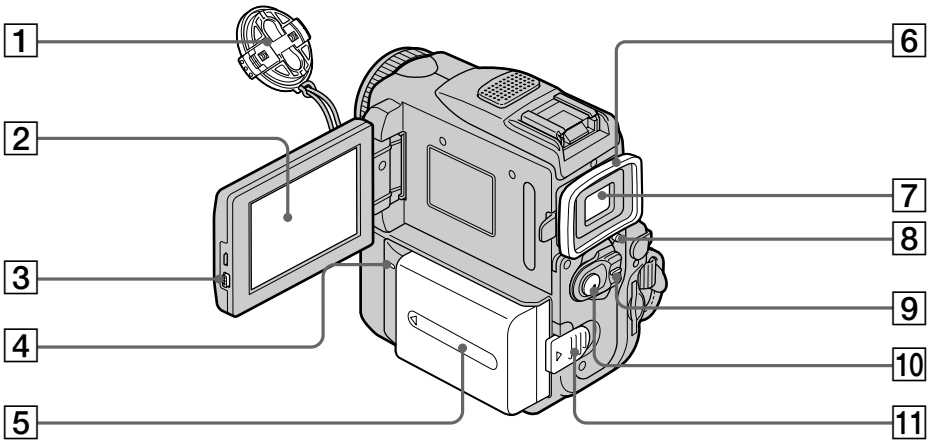

1 Lens cap (p. 24)

2 LCD screen/Touch panel (p. 22, 26, 116)

3 OPEN button (p. 24)

4 CHARGE lamp (p. 15)

5 Battery pack/Battery terminal cover
(p. 14)

6 Eyecup

7 Viewfinder (p. 28)

8 LOCK switch (p. 25)



9 POWER switch (p. 24)

10 START/STOP button (p. 24)

11 BATT (battery) release lever (p. 14)

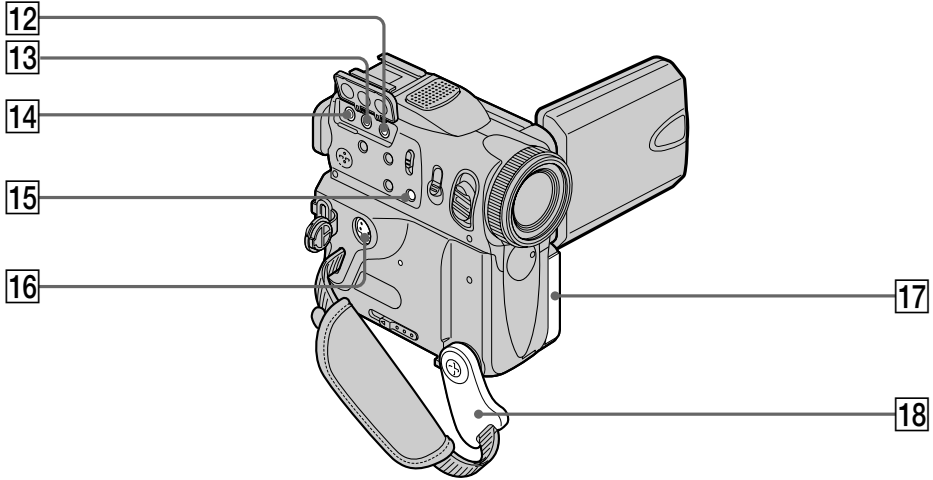
Identifying the parts and controls



- | | |
|--------------------------------------------------------------------------------------------------------------------------------------------------------------------------------------------------------------------------------------------------------------------------------------------------------------------------------------------------------------------------------------------------------------------------------------------------------------------------------|---------------------------------------------------|
| 12 MIC (PLUG IN POWER) jack (red)
(p. 102)
Connect an external microphone (optional). This jack also accepts a “plug-in-power” microphone. | 15 FOCUS button (p. 65) |
| 13 A/V (AUDIO/VIDEO) ID-2 jack (yellow)
(p. 43, 83, 129, 183) | 16 S VIDEO ID-2 jack (p. 43, 83, 129, 183) |
| 14  (LANC) jack (blue)
LANC stands for Local Application Control Bus System. The  control jack is used for controlling the tape transport of video equipment and other peripherals connected to the video equipment. This jack has the same function as the jack indicated as CONTROL L or REMOTE. | 17 Jack cover |
| | 18 Holding Grip (p. 24) |

About the Holding Grip

Grasp the Holding Grip firmly as illustrated.

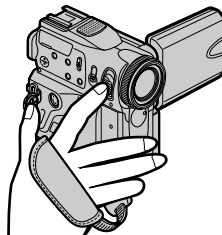

Identifying the parts and controls

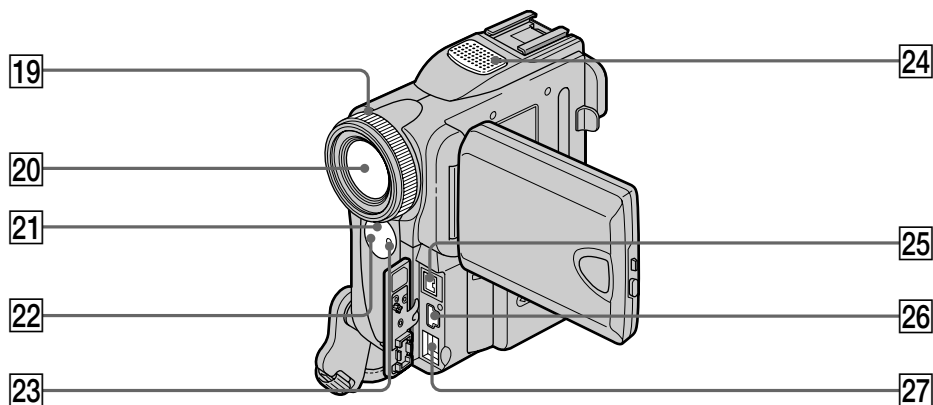

19 Focus ring (p. 65)

20 Lens

21 Infrared rays emitter (p. 32, 89)

22 Remote sensor

23 Camera recording lamp (p. 24)

24 Microphone

25 **i** DV Interface (p. 84, 98, 130, 142, 183)
The **i** DV Interface is i.LINK compatible.

26 **ψ** (USB) jack (p. 163)

27 DC IN jack (p. 15, 18)

Note on the Carl Zeiss lens

Your camcorder is equipped with a Carl Zeiss lens which can reproduce a fine image. The lens for your camcorder was developed jointly by Carl Zeiss, in Germany, and Sony Corporation. It adopts the MTF* measurement system for video camera and offers a quality as the Carl Zeiss lens.

* MTF is an abbreviation of Modulation Transfer Function.

The value number indicates the amount of light of a subject penetrating into the lens.

Identifying the parts and controls

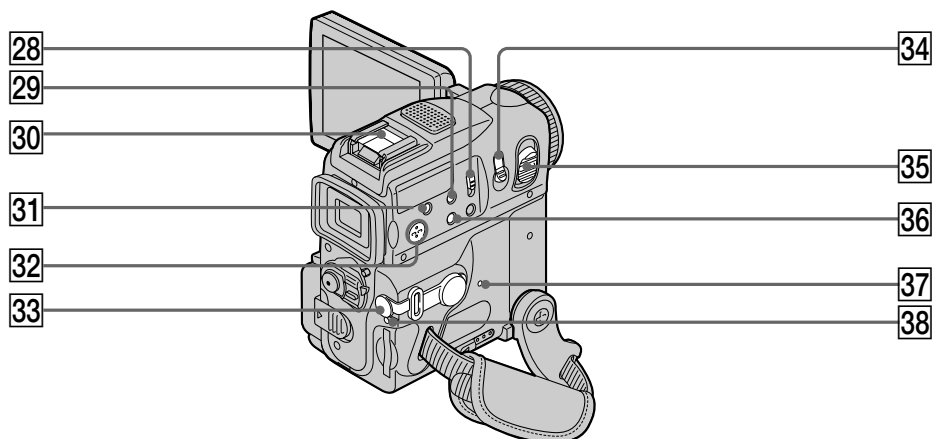

28 NIGHTSHOT switch (p. 32)

29 SUPER NS/COLOR SLOW S button
(p. 33, 34)

30 Intelligent accessory shoe

31 BACK LIGHT button (p. 32)

32 Speaker

33  (headphones) jack (green)

When you use headphones, the speaker on your camcorder is muted.

34 PHOTO button (p. 44, 47, 122)

35 Power zoom lever (p. 29, 74, 154)

36 DISPLAY/TOUCH PANEL button (p. 39)

37 RESET button (p. 199)

38 Access lamp (p. 115)



Notes on the intelligent accessory shoe

- The intelligent accessory shoe supplies power to optional accessories such as a video light or microphone.
- The intelligent accessory shoe is linked to the POWER switch, allowing you to turn the power supplied by the shoe on and off. Refer to the operating instructions of the accessory for further information.
- The intelligent accessory shoe has a safety device for fixing the installed accessory securely. To connect an accessory, press down and push it to the end, and then tighten the screw.
- To remove an accessory, loosen the screw, and then press down and pull out the accessory.

Identifying the parts and controls

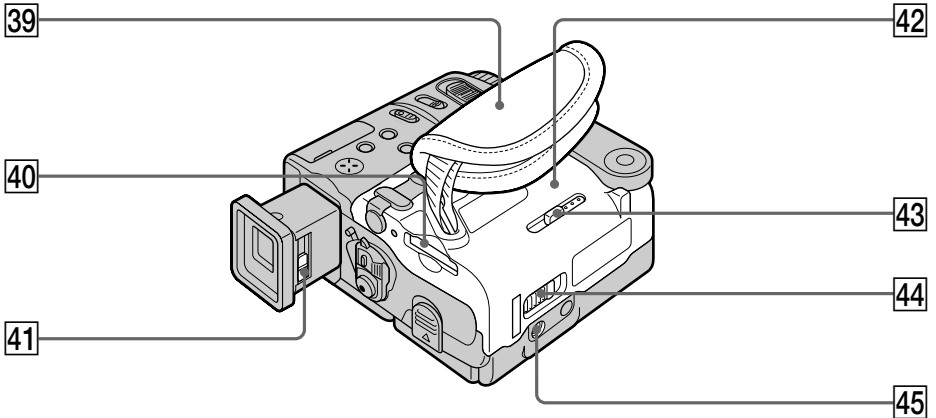

39 Grip Strap

40 "Memory Stick" slot

41 Viewfinder lens adjustment lever
(p. 28)

42 Cassette lid (p. 21)

43 MEMORY EJECT lever (p. 115)

44 OPEN/EJECT lever (p. 21)

45 Tripod receptacle

Make sure that the length of the tripod screw is less than 5.5 mm (7/32 inch). Otherwise, you cannot attach the tripod securely and the screw may damage your camcorder.

Fastening the grip strap

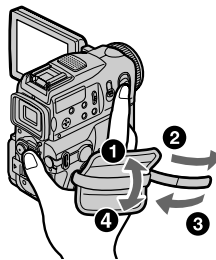

Fasten the grip strap firmly.

Identifying the parts and controls

Remote Commander

Buttons that share the same name on the camcorder and Remote Commander share the same function.

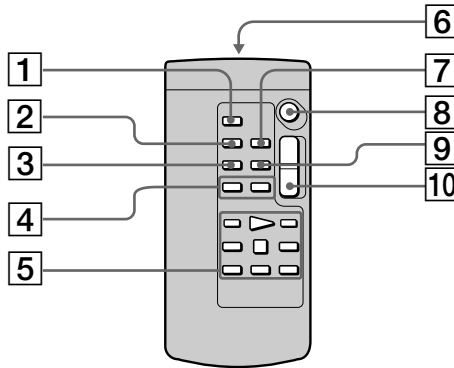

- | | |
|---------------------------------------------|-------------------------------------------------------------------------------------------------------------------|
| 1 PHOTO button (p. 45, 48, 123) | 6 Transmitter
Point toward the remote sensor to control your camcorder after turning on your camcorder. |
| 2 DISPLAY button (p. 39) | 7 ZERO SET MEMORY button (p. 76) |
| 3 SEARCH MODE button (p. 77, 78, 80) | 8 START/STOP button (p. 24) |
| 4 ◀◀/▶▶ buttons (p. 77, 78, 80) | 9 DATA CODE button (p. 39) |
| 5 Video control buttons (p. 41) | 10 Power zoom button (p. 29) |

To prepare the Remote Commander

Insert two size AA (R6) batteries by matching the + and - polarities on the batteries to the + - marks inside the battery compartment.

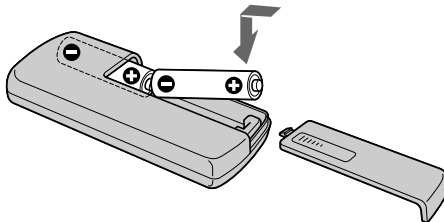

Notes on the Remote Commander

- Point the remote sensor away from strong light sources such as direct sunlight or overhead lighting. Otherwise, the Remote Commander may not function properly.
- Your camcorder works in the commander mode VTR 2. Commander modes 1, 2 and 3 are used to distinguish your camcorder from other Sony VCRs to avoid remote control misoperation. If you use another Sony VCR in the Commander mode VTR 2, we recommend changing the commander mode or covering the sensor of the VCR with black paper.

Identifying the parts and controls

Operation indicators

LCD screen and viewfinder

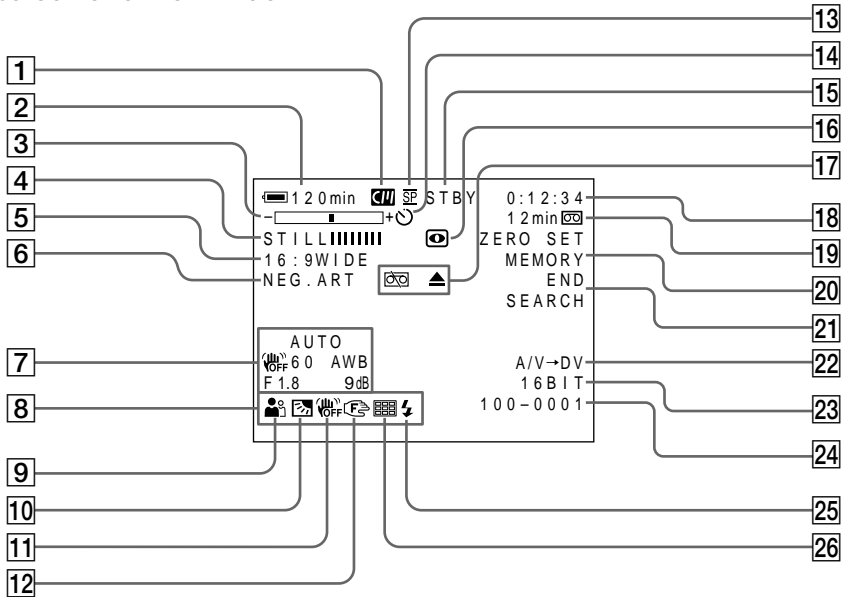

- 1 Cassette memory (p. 12, 203)
- 2 Remaining battery time (p. 31)
- 3 Zoom (p. 29)/Exposure (p. 63)/
Data file name (p. 149)
- 4 Digital effect (p. 57, 73)/MEMORY MIX
(p. 131)/FADER (p. 53)
- 5 16:9WIDE (p. 51)
- 6 Picture effect (p. 56, 72)
- 7 Data code (p. 39)
- 8 Date (p. 31)
- 9 PROGRAM AE (p. 60)
- 10 BACK LIGHT (p. 32)
- 11 SteadyShot off (p. 186)
- 12 Manual focus/Infinity (p. 65)
- 13 Recording mode (p. 31)
- 14 Self-timer (p. 35, 46, 47, 126, 138)
- 15 STBY/REC (p. 31)/Video control mode
(p. 41)/Image size (p. 120)/Image
quality mode (p. 118)
- 16 NIGHTSHOT (p. 33)/SUPER NIGHTSHOT
(p. 33)/COLOR SLOW SHUTTER (p. 34)
- 17 Warning (p. 201)
- 18 Tape counter (p. 31, 40)/Time code
(p. 31)/Self-diagnosis (p. 200)/Photo
mode (p. 47, 122)/Image number (p. 149)
- 19 Remaining tape (p. 31)/Memory
playback (p. 149)
- 20 ZERO SET MEMORY (p. 76)
- 21 END SEARCH (p. 36)
- 22 A/V → DV (p. 183)/DV IN
- 23 Audio mode (p. 190)
- 24 Data file name (p. 133) /Time (p. 31)
- 25 Flash
This indicator appears when you use the
video flash light (optional).
- 26 Continuous photo recording (p. 124)

Index

A, B

AC power adaptor 15, 18
Adjusting the viewfinder 28
Audio dubbing 102
AUDIO MIX 187
AUDIO MODE 190
AUTO SHTR 185
A/V connecting cable 43, 83,
89, 97, 103, 129, 141, 183
BACK LIGHT 32
Battery pack 14
BEEP 192
BOUNCE 53

C, D

CALIBRATION 211
Camera Chromakey 131
Cassette memory 12, 203
Charging battery 15
Charging manganese-lithium
battery 211
CLEANING CASSETTE 210
Clock set 19
Color Slow Shutter 34
Data code 39
Date search 78
DEMO MODE 191
DIGITAL EFFECT 57, 73
Digital program editing
..... 85, 143
DISPLAY 39
DOT 53
Dual sound track tape 204

E

EDITSEARCH 37
END SEARCH 36
EXP BRKTG 124
Exposure 63

F, G, H

Fade in/out 54
FLASH MOTION 57
Flexible Spot Meter 64
FOCUS 65
Format 114, 189
FRAME REC 69
Full charge 15
Grip strap 220
Headphone jack 219
Heads 210
HiFi SOUND 187
Holding Grip 217

I, J, K, L

i.LINK 206
i.LINK cable 84, 98, 130, 142, 183
Image protection 156
Image quality mode 118
Image size 120
Index screen 150
“InfoLITHIUM” battery
..... 17, 205
Infrared rays emitter 218
Intelligent accessory shoe
..... 102, 219
Interval recording 67
JPEG 113
Labeling a cassette 111
LANC jack 217
LUMINANCEKEY 57

M, N

Main sound 204
Manual focus 65
Memory Chromakey 131
Memory Luminancekey 131
MEMORY MIX 131
Memory Overlap 131
Memory PB ZOOM 154
“Memory Stick” 113
Menu settings 184
Mirror mode 30
Moisture condensation 209
MONOTONE 53
MOSC. FADER 53
MPEG 113
Multi screen mode 124
NIGHTSHOT 33
NORM. FADER 53
NTSC system 208

O, P, Q

OLD MOVIE 57
OVERLAP 53
Photo save 146
Photo scan 81
Photo search 80
PICTURE EFFECT 56, 72
Picture search 41
Playback time 16
Print mark 160
PROGRAM AE 60
PTP 191

R

Recording time 16
Rec Review 37
Remaining battery time
indicator 31
Remaining tape indicator 31
Remote commander 221
Remote sensor 218
RESET 199, 219

S

Self-diagnosis display 200
Self-timer recording
..... 35, 46, 47, 126, 138
Signal convert function 183
Skip scan 41
Slide show 155
SLOW SHUTTER 57
SPOT FOCUS 66
STEADYSHOT 186
Stereo tape 204
STILL 57
Sub sound 204
SUPER NIGHTSHOT 33
S VIDEO jack
..... 43, 83, 97, 129, 141, 183

T, U, V

Tape counter 31
Tape PB ZOOM 74
Tape Photo recording 47
Telephoto 29
Time code 31
Title 106
Title search 77
Touch panel 22
TRAIL 57
Transition 25
TV color systems 208
USB jack 163
USB streaming 166

W, X, Y, Z

Warning indicators 201
Warning messages 202
White balance 49
Wide-angle 29
Wide mode 51
WIPE 53
WORLD TIME 192
Write-protect switch 113
Write-protect tab 21
Zero set memory 76
Zoom 29

<http://www.sony.net/>

Printed on recycled paper

Sony Corporation Printed in Japan

