

Digital Video Camera Recorder

Operating Instructions

Before operating the unit, please read this manual thoroughly, and retain it for future reference.

Owner's Record

The model and serial numbers are located on the bottom. Record the serial number in the space provided below. Refer to these numbers whenever you call upon your Sony dealer regarding this product.

Model No. DCR-TRV _____ Model No. AC- _____

Serial No. _____ Serial No. _____

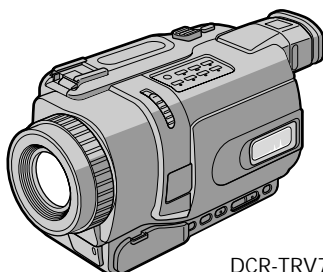

DCR-TRV740

Digital Handycam



MEMORY STICK™



Digital 8

DCR-TRV240/TRV340/TRV740/
TRV840

Welcome!

Congratulations on your purchase of this Sony Handycam. With your Handycam, you can capture life's precious moments with superior picture and sound quality. Your Handycam is loaded with advanced features, but at the same time it is very easy to use. You will soon be producing home video that you can enjoy for years to come.

WARNING

To prevent fire or shock hazard, do not expose the unit to rain or moisture.

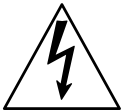
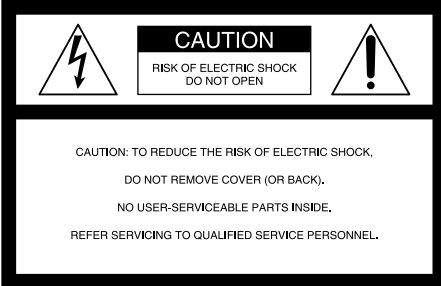

This symbol is intended to alert the user to the presence of uninsulated "dangerous voltage" within the product's enclosure that may be of sufficient magnitude to constitute a risk of electric shock to persons.



This symbol is intended to alert the user to the presence of important operating and maintenance (servicing) instructions in the literature accompanying the appliance.

Never expose the battery pack to temperatures above 60°C (140°F) such as in a car parked in the sun or under direct sunlight.

For customers in the U.S.A. and CANADA

CAUTION

TO PREVENT ELECTRIC SHOCK, MATCH WIDE BLADE OF PLUG TO WIDE SLOT, FULLY INSERT.

RECYCLING LITHIUM-ION BATTERIES

Lithium-Ion batteries are recyclable.

You can help preserve our environment by returning your used rechargeable batteries to the collection and recycling location nearest you.



For more information regarding recycling of rechargeable batteries, call toll free 1-800-822-8837, or visit <http://www.rbrcc.org/>.

Caution: Do not handle damaged or leaking Lithium-Ion batteries.

"Memory Stick"

THIS DEVICE COMPLIES WITH PART 15 OF THE FCC RULES. OPERATION IS SUBJECT TO THE FOLLOWING TWO CONDITIONS:

(1) THIS DEVICE MAY NOT CAUSE HARMFUL INTERFERENCE, AND (2) THIS DEVICE MUST ACCEPT ANY INTERFERENCE RECEIVED, INCLUDING INTERFERENCE THAT MAY CAUSE UNDESIRE OPERAION.

THIS CLASS B DIGITAL APPARATUS COMPLIES WITH CANADIAN ICES-003.

For the customers in the U.S.A.

If you have any questions about this product, you may call:
Sony Customer Information Center 1-800-222-SONY (7669)
The number below is for the FCC related matters only.

Regulatory Information

Declaration of Conformity

Trade Name: SONY
Model No.: DCR-TRV240, DCR-TRV340
Responsible Party: Sony Electronics Inc.
Address: 680 Kinderkamack Road, Oradell, NJ07649 U.S.A.
Telephone No.: 201-930-6972

This device complies with Part 15 of the FCC Rules. Operation is subject to the following two conditions: (1) This device may not cause harmful interference, and (2) this device must accept any interference received, including interference that may cause undesired operation.

Declaration of Conformity

Trade Name: SONY
Model No.: DCR-TRV740, DCR-TRV840
Responsible Party: Sony Electronics Inc.
Address: 680 Kinderkamack Road, Oradell, NJ07649 U.S.A.
Telephone No.: 201-930-6972

This device complies with Part 15 of the FCC Rules. Operation is subject to the following two conditions: (1) This device may not cause harmful interference, and (2) this device must accept any interference received, including interference that may cause undesired operation.

CAUTION

You are cautioned that any changes or modifications not expressly approved in this manual could void your authority to operate this equipment.

Note:

This equipment has been tested and found to comply with the limits for a Class B digital device, pursuant to Part 15 of the FCC Rules. These limits are designed to provide reasonable protection against harmful interference in a residential installation. This equipment generates, uses, and can radiate radio frequency energy and, if not installed and used in accordance with the instructions, may cause harmful interference to radio communications. However, there is no guarantee that interference will not occur in a particular installation. If this equipment does cause harmful interference to radio or television reception, which can be determined by turning the equipment off and on, the user is encouraged to try to correct the interference by one or more of the following measures:

- Reorient or relocate the receiving antenna.
- Increase the separation between the equipment and receiver.
- Connect the equipment into an outlet on a circuit different from that to which the receiver is connected.
- Consult the dealer or an experienced radio/TV technician for help.

The supplied interface cable must be used with the equipment in order to comply with the limits for a digital device pursuant to Subpart B of Part 15 of FCC Rules.

Main features

Recording moving or still images, and playing them back

- Recording moving pictures on a tape (p. 21)
- Recording still images on a tape (p. 39)
- Playing back a tape (p. 34)
- Recording still images on “Memory Stick”s (except DCR-TRV240) (p. 124)
- Recording moving pictures on “Memory Stick”s (except DCR-TRV240) (p. 140)
- Viewing still images recorded on “Memory Stick”s (except DCR-TRV240) (p. 150)
- Viewing moving pictures on “Memory Stick”s (except DCR-TRV240) (p. 153)

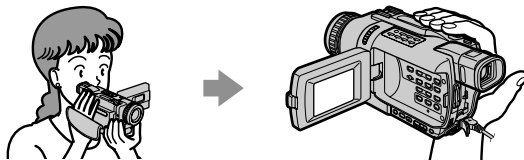

Capturing images on your computer

- Viewing images recorded on “Memory Stick”s using the USB cable (except DCR-TRV240) (p. 155)
- Viewing images recorded on a tape using the USB cable (p. 94)
- Viewing images live on your computer from your camcorder using the USB cable (p. 103)
- Capturing images from an analog video unit on your computer (p. 88)

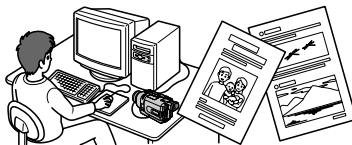

Other uses

Functions for adjusting exposure in the recording mode

- BACKLIGHT (p. 28)
- NightShot/Super NightShot/Color Slow Shutter (p. 29)
- PROGRAM AE (p. 51)
- Adjusting the exposure manually (p. 53)

Functions for giving images more impact

- Digital zoom [MENU] (p. 24) The default setting is OFF. (To zoom greater than 25 \times , (DCR-TRV240/TRV340)/15 \times (DCR-TRV740/TRV840), select the digital zoom power in D ZOOM in the menu settings.)
- Fader (p. 44)
- Picture effects (p. 47)
- Digital effects (p. 48)
- Titles (p. 58, 60)
- MEMORY MIX (except DCR-TRV240) (p. 129)

Functions for giving a natural appearance to your recordings

- Sports lesson (p. 51)
- Landscape (p. 51)
- Manual focus (p. 54)

Functions for use on recorded tapes

- END SEARCH/EDITSEARCH/Rec Review (p. 32)
- DATA CODE (p. 35)
- Tape PB ZOOM (p. 65)
- ZERO SET MEMORY (p. 67)
- Digital program editing (on tapes) (p. 74)/(on “Memory Stick”s) (except DCR-TRV240) (p. 146)

Checking supplied accessories

Make sure that the following accessories are supplied with your camcorder.

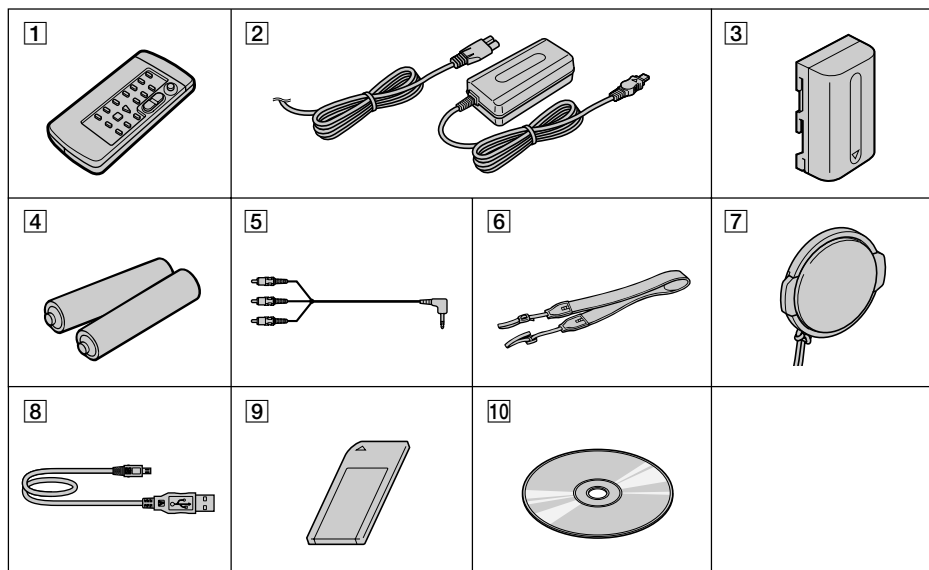

- | | |
|--|---|
| <ul style="list-style-type: none">1 Wireless Remote Commander (1) (p. 207)2 AC-L10A/L10B/L10C AC power adaptor (1), Power cord (1) (p. 13)3 NP-FM30 battery pack (1) (p. 12, 13)
DCR-TRV240/TRV340
NP-FM50 battery pack (1) (p. 12, 13)
DCR-TRV740/TRV8404 Size AA (R6) battery for Remote Commander (2) (p. 207) | <ul style="list-style-type: none">5 A/V connecting cable (1) (p. 38)6 Shoulder strap (1) (p. 201)7 Lens cap (1) (p. 21)8 USB cable (1) (p. 96, 156)9 "Memory Stick" (1) (except DCR-TRV240) (p. 116)10 CD-ROM (SPVD-008 USB Driver) (1) (p. 96, 156) |
|--|---|

Contents of the recording cannot be compensated if recording or playback is not made due to a malfunction of the camcorder, storage media, etc.

Table of contents

Main features	4	Using the PROGRAM AE function	51
Checking supplied accessories.....	5	Adjusting the exposure manually	53
<hr/>		Focusing manually	54
Quick Start Guide	8	Interval recording	55
<hr/>		Frame by frame recording	
Getting Started		– Frame recording	57
Using this manual	10	Superimposing a title	58
Step 1 Preparing the power supply ...	12	Making your own titles	60
Installing the battery pack	12	Inserting a scene	62
Charging the battery pack	13	<hr/>	
Connecting to a wall outlet	17	Advanced Playback Operations	
Step 2 Setting the date and time	18	Playing back tapes with picture	
Step 3 Inserting a cassette	20	effects	63
<hr/>		Playing back tapes with digital	
Recording – Basics		effects	64
Recording a picture	21	Enlarging recorded images	
Shooting backlit subjects		– Tape PB ZOOM	65
– BACK LIGHT	28	Quickly locating a scene	
Shooting in the dark		– ZERO SET MEMORY	67
– NightShot/Super NightShot/ Color Slow Shutter	29	Searching a recording by date	
Self-timer recording		– DATE SEARCH	68
(except DCR-TRV240)	31	Searching for a photo – PHOTO SEARCH/PHOTO SCAN	69
Checking recordings – END SEARCH/ EDITSEARCH/Rec Review	32	<hr/>	
<hr/>		Editing	
Playback – Basics		Dubbing a tape	71
Playing back a tape	34	Dubbing only desired scenes	
To display the screen indicators		– Digital program editing	
– Display function	35	(on tapes)	74
Viewing recordings on TV	38	Capturing images from an analog video unit on your computer	
<hr/>		– Signal convert function	88
Advanced Recording Operations		Recording video or TV programs	89
Recording still images on a tape		Inserting a scene from a VCR	
– Tape Photo recording	39	– Insert Editing	92
Using the wide mode	42	Viewing images recorded on a tape on your computer	
Using the fader function	44	(Windows users only)	94
Using special effects		<hr/>	
– Picture effect	47	Customizing Your Camcorder	
Using special effects		Changing the menu settings	105
– Digital effect	48		

Table of contents

“Memory Stick” operations (except DCR-TRV240)

Using “Memory Stick”	
– Introduction	116
Recording still images on “Memory Stick”s	
– Memory Photo recording	124
Superimposing a still image in the “Memory Stick” on an image	
– MEMORY MIX	129
Recording images from a tape as still images	135
Copying still images from a tape	
– PHOTO SAVE	138
Recording moving pictures on “Memory Stick”s	
– MPEG movie recording	140
Recording pictures from a tape as moving pictures	142
Recording edited pictures as a moving picture	
– Digital program editing (on “Memory Stick”s)	146
Viewing still images	
– Memory Photo playback	150
Viewing moving pictures	
– MPEG movie playback	153
Viewing images recorded on “Memory Stick”s on your computer	155
Copying images recorded on “Memory Stick”s to tape	164
Enlarging still images recorded on “Memory Stick”s	
– Memory PB ZOOM	166
Playing back images in a continuous loop – SLIDE SHOW	168
Preventing accidental erasure	
– Image protection	170
Deleting images – DELETE	171
Writing a print mark	
– PRINT MARK	174
Using the optional printer	176

Troubleshooting

Types of trouble and how to correct trouble	178
Self-diagnosis display	184
Warning indicators and messages	185

Additional Information

Digital8  system, recording and playback	187
About the “InfoLITHIUM” battery pack	189
About i.LINK	191
Using your camcorder abroad	193
Maintenance information and precautions	194
Specifications	199

Quick Reference

Identifying parts and controls	201
Index	209

Quick Start Guide



This chapter introduces you to the basic features of your camcorder. See the page in parentheses “()” for more information.

1 Connecting the power cord (p. 17)

Use the battery pack when using your camcorder outdoors (p. 12).

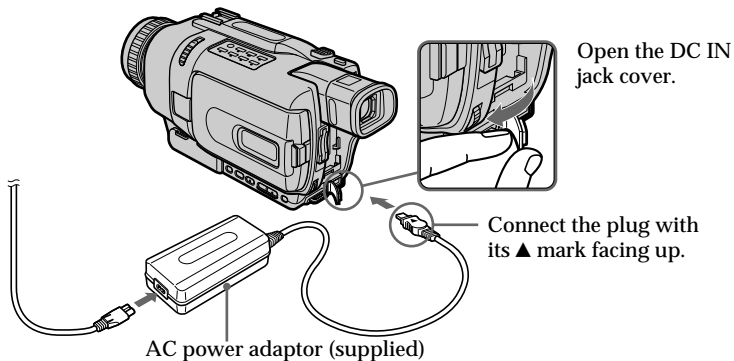

2 Inserting a cassette (p. 20)

- 1 Slide OPEN/EJECT in the direction of the arrow and open the lid.

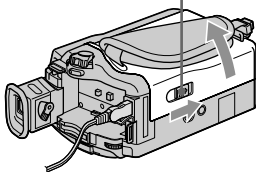
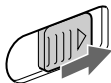

- 2 Insert the cassette in straight as far as possible into the cassette compartment with the window facing up. Push the center of the cassette back to insert the cassette.

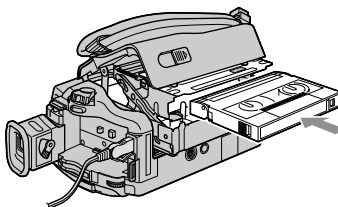

- 3 Close the cassette compartment by pressing **PUSH** on the cassette compartment. After the cassette compartment goes down completely, close the lid until it clicks.

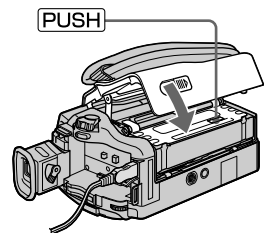

3 Recording a picture (p. 21)

- 1 Remove the lens cap.

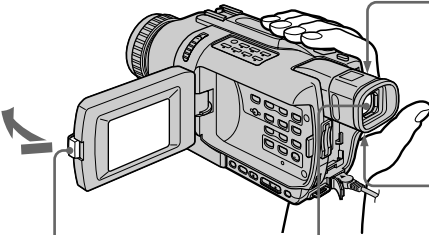

- 2 Set the POWER switch to CAMERA while pressing the small green button.

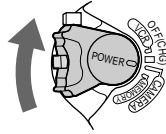

- 3 Open the LCD panel while pressing OPEN. The picture appears on the LCD screen.

Viewfinder

When the LCD panel is closed, use the viewfinder with your eye against the eyecup.

The picture in the viewfinder is black and white.

- 4 Press START/STOP. Your camcorder starts recording. To stop recording, press START/STOP button again.



When you purchase your camcorder, the clock setting is set to off. If you want to record the date and time for a picture, set the clock setting before recording (p. 18).

4 Monitoring the playback picture on the LCD screen (p. 34)

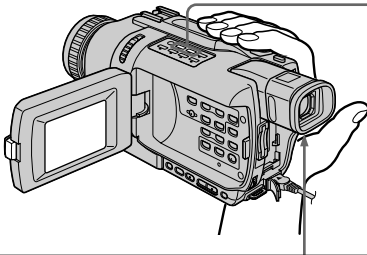

- 2 Press ◀◀ to rewind the tape.



- 3 Press ▶ to start playback.



- 1 Set the POWER switch to VCR while pressing the small green button.

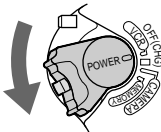

Note

Do not pick up your camcorder by holding the viewfinder, the LCD panel, or the battery pack.

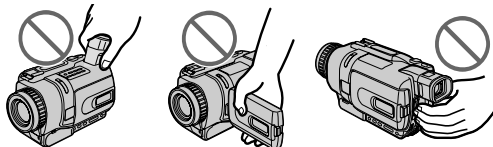

Using this manual

The instructions in this manual are for the four models listed in the table below. Before you start reading this manual and operating your camcorder, check the model number by looking at the bottom of your camcorder. The DCR-TRV740 is the model used for illustration purposes. Otherwise, the model name is indicated in the illustrations. Any differences in operation are clearly indicated in the text, for example, “except DCR-TRV240.”

As you read through this manual, buttons and settings on your camcorder are shown in capital letters.

e.g. Set the POWER switch to CAMERA.

When you carry out an operation, you can hear a beep to indicate that the operation is being carried out.











Differences by camcorder model

DCR-	TRV240	TRV340	TRV740	TRV840
MEMORY mark* (on the POWER switch)	—	●	●	●
Self-timer	—	●	●	●
Digital zoom	700×	700×	420×	420×
LCD Screen	6.2 cm (2.5 type)	6.2 cm (2.5 type)	6.2 cm (2.5 type)	8.8 cm (3.5 type)

- Provided
- Not provided

* The models with MEMORY marked on the POWER switch is provided with memory functions. See page 116 for details.

Before using your camcorder

With your digital camcorder, you can use Hi8 /Digital8  video cassettes. Your camcorder records and plays back pictures in the Digital8  system. Also, your camcorder plays back tapes recorded in the Hi8 /standard 8  (analog) system. You, however, cannot use the functions in “Advanced Playback Operations” on page 63 to 70 for playback in the Hi8 /standard 8  system. To enable smooth transition, we recommend that you do not mix pictures recorded in the Hi8 /standard 8  with the Digital8  system on a tape.

Note on TV color systems

TV color systems differ from country to country. To view your recordings on a TV, you need an NTSC system-based TV.

Copyright precautions

Television programs, films, video tapes, and other materials may be copyrighted. Unauthorized recording of such materials may be contrary to the provision of the copyright laws.

Precautions on camcorder care

Lens and LCD screen/finder

- The LCD screen and the finder are manufactured using extremely high-precision technology so over 99.99% of the pixels are operational for effective use. However, there may be some tiny black points and/or bright points (white, red, blue or green in color) that constantly appear on the LCD screen and the finder. These points are normal in the manufacturing process and do not affect the recording in any way.
- Do not let your camcorder become wet. Keep your camcorder away from rain and sea water. Letting your camcorder become wet may cause your camcorder to malfunction. Sometimes this malfunction cannot be repaired [a].
- Never leave your camcorder exposed to temperatures above 60°C (140°F), such as in a car parked in the sun or under direct sunlight [b].
- Be careful when placing the camera near a window or outdoors. Exposing the LCD screen, the finder or the lens to direct sunlight for long periods may cause malfunctions [c].
- Do not directly shoot the sun. Doing so might cause your camcorder to malfunction. Take pictures of the sun in low light conditions such as dusk [d].

[a]

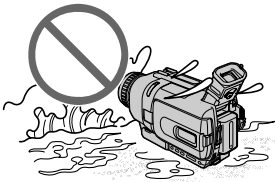

[b]

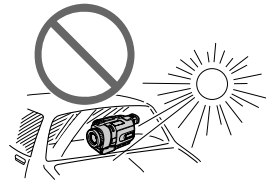

[c]

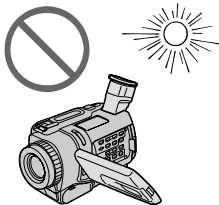

[d]

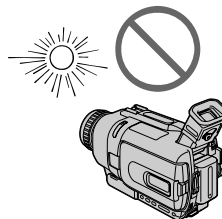

Step 1 Preparing the power supply

Installing the battery pack

- (1) Lift up the viewfinder.
- (2) Slide the battery pack down until it clicks.

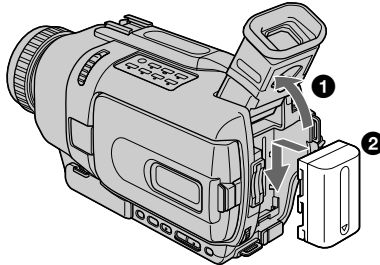

To remove the battery pack

- (1) Lift up the viewfinder.
- (2) Slide the battery pack out in the direction of the arrow while pressing BATT (battery) release lever down.

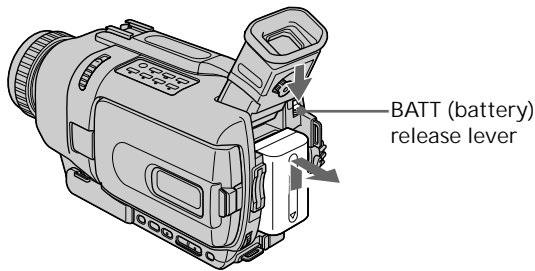

If you install the large-capacity battery pack
If you install the NP-FM70/QM71/FM90/QM91/FM91 battery pack on your camcorder, extend its viewfinder.

Step 1 Preparing the power supply

Charging the battery pack

Use the battery pack after charging it for your camcorder.
Your camcorder operates only with the “InfoLITHIUM” battery pack (M series).
See page 189 for details of “InfoLITHIUM” battery pack.

- (1) Open the DC IN jack cover and connect the AC power adaptor supplied with your camcorder to the DC IN jack with the plug’s ▲ mark facing up.
- (2) Connect the power cord to the AC power adaptor.
- (3) Connect the power cord to a wall outlet.
- (4) Set the POWER switch to OFF (CHG). Charging begins. The remaining battery time is indicated in minutes on the display window.

When the remaining battery indicator changes to , normal charge is completed. To fully charge the battery (full charge), leave the battery pack attached after normal charge is completed until FULL appears on the display window. Fully charging the battery allows you to use the battery longer than usual.

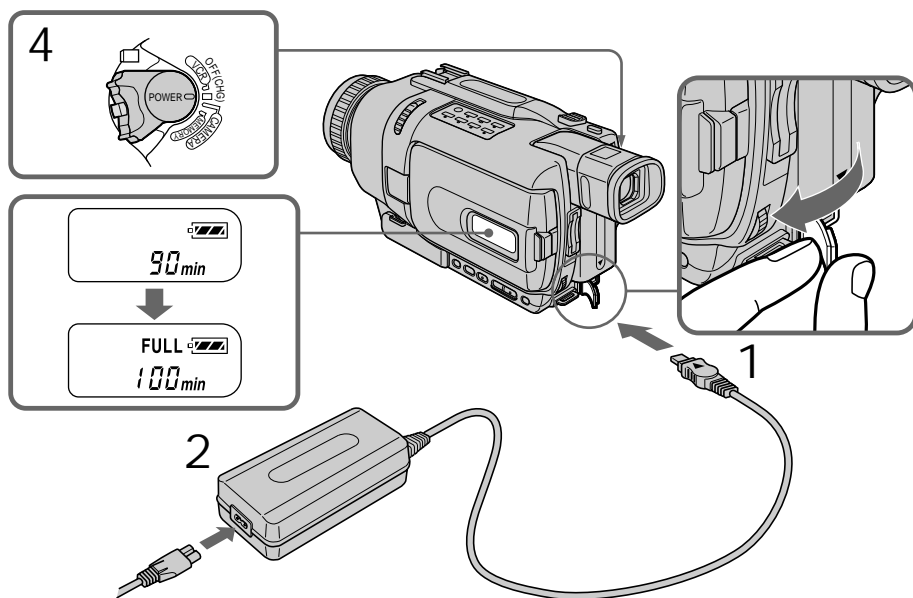

The number in the illustration of the display window may differ from that on your camcorder.

After charging the battery pack

Disconnect the AC power adaptor from the DC IN jack on your camcorder.

Step 1 Preparing the power supply

Note

Prevent metallic objects from coming into contact with the metal parts on the DC plug of the AC power adaptor. This may cause a short-circuit, damaging the AC power adaptor.

When the battery pack is charged fully
The LCD backlight of the display window is turned off.

Remaining battery time indicator
The remaining battery time indicator in the display window roughly indicates the recording time when recording using the viewfinder.

Until your camcorder calculates the actual remaining battery time
“---- min” appears in the display window.

While charging the battery pack
No indicator appears or the indicator flashes in the display window in the following cases:

- The battery pack is not installed correctly.
- Something is wrong with the battery pack.

If the power may go off although the remaining battery time indicator indicates that the battery pack has enough power to operate
Charge the battery pack fully again so that the indication on the remaining battery time indicator is correct.

When you use the AC power adaptor
Place the AC power adaptor near a wall outlet. If any trouble occurs with this unit, disconnect the plug from the wall outlet as soon as possible to cut off the power.

Recommended charging temperature
We recommend charging the battery pack in an ambient temperature of between 10°C to 30°C (50°F to 86°F).

What is “InfoLITHIUM”?

The “InfoLITHIUM” is a lithium ion battery pack that can exchange data such as battery consumption with compatible electronic equipment. This unit is compatible with the “InfoLITHIUM” battery pack (M series). Your camcorder operates only with the “InfoLITHIUM” battery. “InfoLITHIUM” M series battery packs have the

 mark.

“InfoLITHIUM” is a trademark of Sony Corporation.

Step 1 Preparing the power supply

Charging time

Battery pack	Full charge (Normal charge)
NP-FM30 ¹⁾	145 (85)
NP-FM50 ²⁾	150 (90)
NP-FM70	240 (180)
NP-QM71	260 (200)
NP-FM90	330 (270)
NP-QM91/FM91	360 (300)

The charging time may increase if the battery's temperature is extremely high or low because of the ambient temperature.

Approximate number of minutes to charge an empty battery pack at 25°C (77°F)

¹⁾ Supplied with DCR-TRV240/TRV340

²⁾ Supplied with DCR-TRV740/TRV840

Recording time

DCR-TRV240/TRV340

Battery pack	Recording with the viewfinder		Recording with the LCD screen	
	Continuous*	Typical**	Continuous*	Typical**
NP-FM30 (supplied)	100	55	80	45
NP-FM50	165	95	130	75
NP-FM70	345	200	270	155
NP-QM71	400	230	315	180
NP-FM90	520	300	410	235
NP-QM91/FM91	605	350	475	275

DCR-TRV740

Battery pack	Recording with the viewfinder		Recording with the LCD screen	
	Continuous*	Typical**	Continuous*	Typical**
NP-FM30	85	45	70	40
NP-FM50 (supplied)	140	80	110	60
NP-FM70	295	170	240	135
NP-QM71	340	195	275	155
NP-FM90	450	260	360	205
NP-QM91/FM91	520	300	420	240

DCR-TRV840

Battery pack	Recording with the viewfinder		Recording with the LCD screen	
	Continuous*	Typical**	Continuous*	Typical**
NP-FM30	85	45	65	35
NP-FM50 (supplied)	140	80	105	60
NP-FM70	295	170	225	130
NP-QM71	340	195	265	150
NP-FM90	450	260	345	200
NP-QM91/FM91	520	300	400	230

Step 1 Preparing the power supply

Approximate number of minutes when you use a fully charged battery

- * Approximate continuous recording time at 25°C (77°F). The battery life will be shorter if you use your camcorder in a cold environment.
- ** Approximate number of minutes when recording while you repeat recording start/stop, zooming and turning the power on/off. The actual battery life may be shorter

Playing time

DCR-TRV240/TRV340

Battery pack	Playing time on LCD screen	Playing time with LCD closed
NP-FM30 (supplied)	80	110
NP-FM50	130	180
NP-FM70	270	370
NP-QM71	315	430
NP-FM90	410	560
NP-QM91/FM91	475	645

DCR-TRV740

Battery pack	Playing time on LCD screen	Playing time with LCD closed
NP-FM30	80	105
NP-FM50 (supplied)	135	170
NP-FM70	275	355
NP-QM71	325	415
NP-FM90	425	540
NP-QM91/FM91	490	625

DCR-TRV840

Battery pack	Playing time on LCD screen	Playing time with LCD closed
NP-FM30	75	105
NP-FM50 (supplied)	125	170
NP-FM70	265	355
NP-QM71	305	415
NP-FM90	400	540
NP-QM91/FM91	465	625

Approximate number of minutes when you use a fully charged battery

Approximate continuous playing time at 25°C (77°F). The battery life will be shorter if you use your camcorder in a cold environment.

Note

The table shows the playing time for tapes recorded in the Digital8  system. The playing time of tapes recorded in the Hi8/standard 8 system is reduced by about 20%..

Step 1 Preparing the power supply

Connecting to a wall outlet

When you use your camcorder for a long time, we recommend that you power it from a wall outlet using the AC power adaptor.

- (1) Open the DC IN jack cover, and connect the AC power adaptor to the DC IN jack on your camcorder with the plug's ▲ mark facing up.
- (2) Connect the power cord to the AC power adaptor.
- (3) Connect the power cord to a wall outlet.

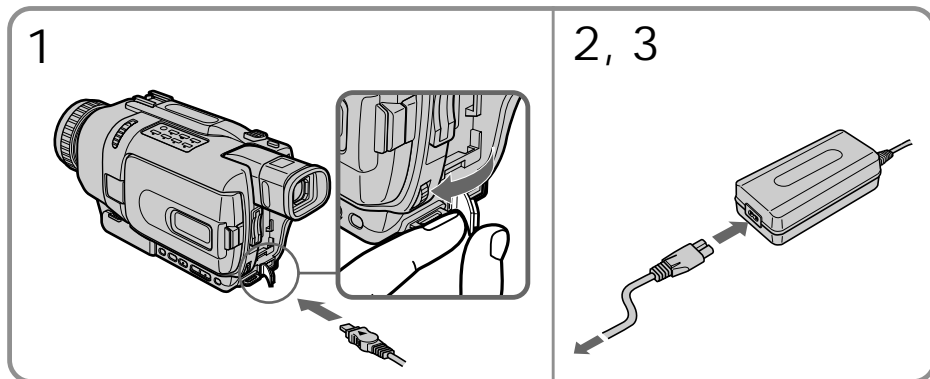

PRECAUTION

The set is not disconnected from the AC power source (house current) as long as it is connected to the wall outlet, even if the set itself has been turned off.

Notes

- The AC power adaptor can supply power even if the battery pack is attached to your camcorder.
- The DC IN jack has “source priority”. This means that the battery pack cannot supply any power if the power cord is connected to the DC IN jack, even when the power cord is not plugged into a wall outlet.

Using a car battery

Use Sony Car Battery Adaptor (optional).

Step 2 Setting the date and time

Set the date and time settings when you use your camcorder for the first time. "CLOCK SET" will be displayed each time that you set the POWER switch to CAMERA/MEMORY (except DCR-TRV240) unless you set the date and time settings. If you do not use your camcorder for about half a year, the date and time settings may be cleared from memory (bars may appear) because the built-in rechargeable battery installed in your camcorder will have been discharged (p. 196). Set the year, then the month, the day, the hour and then the minute.

- (1) Set the POWER switch to CAMERA or MEMORY (except DCR-TRV240), and then press MENU to display the menu settings.
- (2) Turn the SEL/PUSH EXEC dial to select CLOCK SET in , then press the dial.
- (3) Turn the SEL/PUSH EXEC dial to adjust the desired year, then press the dial.
- (4) Set the month, day and hour by turning the SEL/PUSH EXEC dial and pressing the dial.
- (5) Set the minute by turning the SEL/PUSH EXEC dial and pressing the dial by the time signal. The clock starts to move.
- (6) Press MENU to make the menu settings disappear.

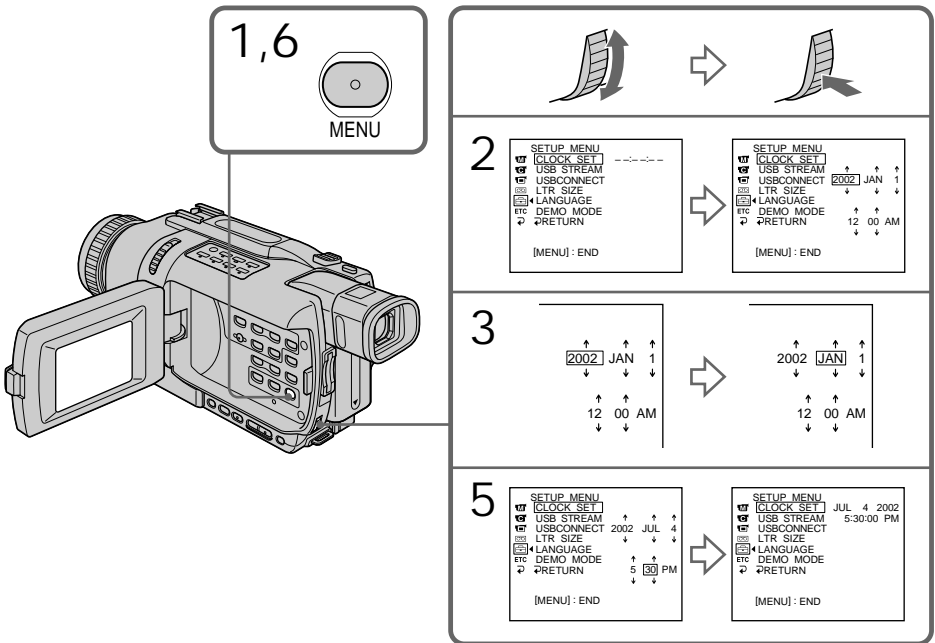

Step 2 Setting the date and time

The year changes as follows:



If you do not set the date and time

“-----” “-:-:-:-” is recorded on the tape and the “Memory Stick”.
(except DCR-TRV240)

Note on the time indicator

The internal clock of your camcorder operates on a 12-hour cycle.

- 12:00 AM stands for midnight.
- 12:00 PM stands for noon.

Step 3 Inserting a cassette

We recommend using Hi8 **Hi8**/Digital8 **D8** video cassettes.

- (1) Prepare the power source (p. 12).
- (2) Slide OPEN/EJECT in the direction of the arrow and open the lid.
The cassette compartment automatically lifts up and opens.
- (3) Insert the cassette straight as far as possible into the cassette compartment with the window facing up.
Push the center of the cassette back to insert.
- (4) Close the cassette compartment by pressing **[PUSH]** on the cassette compartment.
The cassette compartment automatically goes down.
- (5) After the cassette compartment going down completely, close the lid until it clicks.

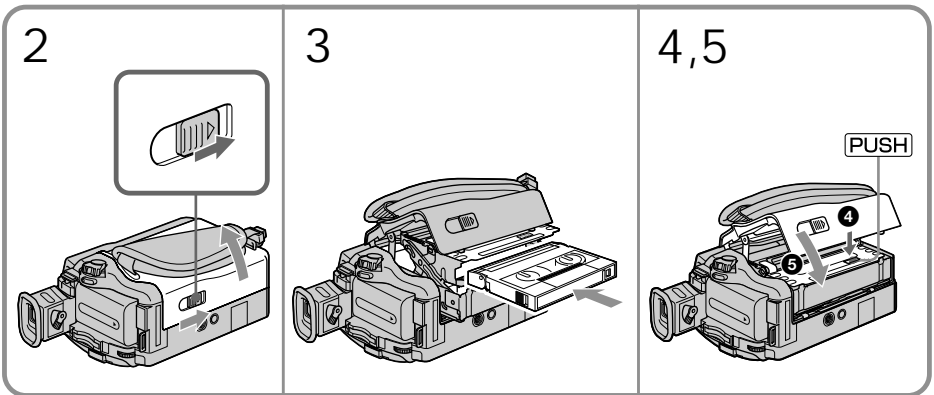

To eject a cassette

Follow the procedure above, and take out the cassette in step 3.

Notes

- Do not press the cassette compartment down. Doing so may cause a malfunction.
- Your camcorder records pictures in the Digital8 **D8** system.
- The recording time when you use your camcorder is half of indicated time on Hi8 **Hi8** tape. If you select the LP mode in the menu settings, 3/4 of indicated time on Hi8 **Hi8** tape.
- If you use standard 8 **8** tape, be sure to play back the tape on your camcorder. Mosaic pattern noise may appear when you play back standard 8 **8** tape on other camcorders (including other DCR-TRV240/TRV340/TRV740/TRV840).
- The cassette compartment may not be closed when you press any part of the lid other than the **[PUSH]** mark.

To prevent accidental erasure

Slide the write-protect tab on the cassette to expose the red mark.

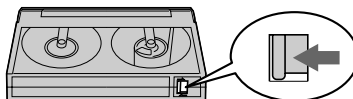

Recording a picture

Your camcorder automatically focuses for you.

- (1) Remove the lens cap by pressing both knobs on its sides and attach the lens cap to the grip strap.
- (2) Install the power source and insert a cassette. See “Step 1” to “Step 3” for more information (p. 12 to 20).
- (3) Set the POWER switch to CAMERA while pressing the small green button. This sets your camcorder to the standby mode.
- (4) Open the LCD panel while pressing OPEN. The viewfinder automatically turns off.
- (5) Press START/STOP. Your camcorder starts recording. The REC indicator appears on the screen. The camera recording lamp located on the front of your camcorder lights up. To stop recording, press START/STOP again. The recording lamp lights up in the viewfinder when you record with the viewfinder.

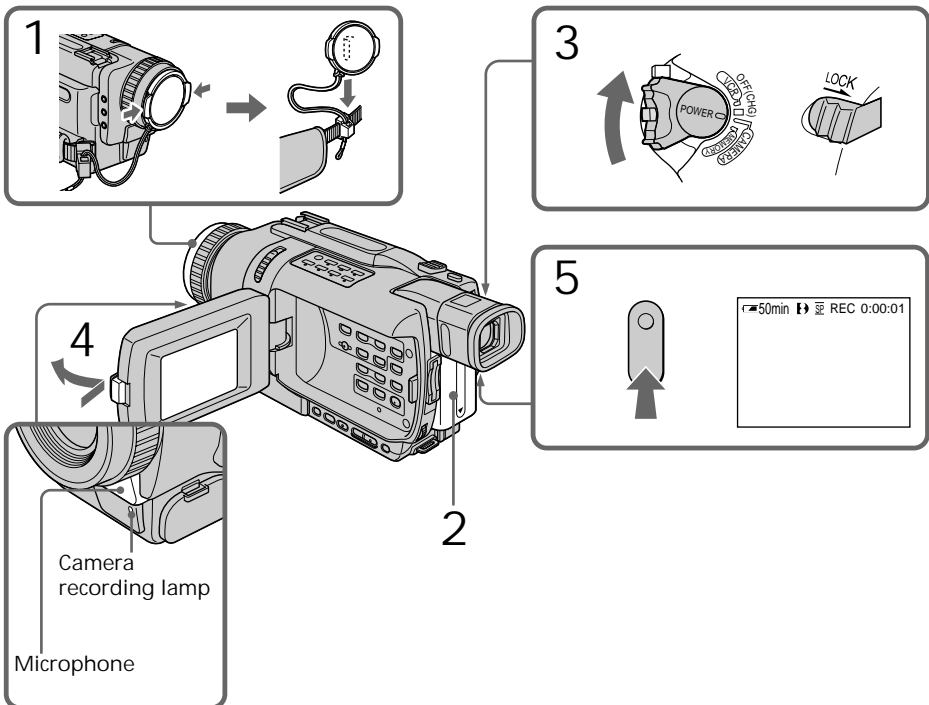

Notes

- Fasten the grip strap firmly.
- Do not touch the built-in microphone during recording.

Recording a picture

Note on recording mode

Your camcorder records and plays back in the SP (standard play) mode and in the LP (long play) mode. Select SP or LP in the menu settings (p. 105). In the LP mode, you can record 1.5 times as long as in the SP mode. When you record a tape in the LP mode on your camcorder, we recommend that you play back the tape on your camcorder.

Note on the LOCK switch (except DCR-TRV240)

When you slide the LOCK switch to the right, the POWER switch can no longer be set to MEMORY accidentally. The LOCK switch is released as the default setting.

To enable smooth transition

Transition between the last scene you recorded and the next scene is smooth as long as you do not eject the cassette even if you turn off your camcorder.

However, check the following:

- Do not mix recordings in the SP mode and in the LP mode on one tape.
- When you change the battery pack, set the POWER switch to OFF (CHG).

If you leave your camcorder in the standby mode for three minutes while the cassette is inserted

Your camcorder automatically turns off. This is to save battery power and to prevent battery and tape wear. To resume the standby mode, set the POWER switch to OFF (CHG) once, then turn it to CAMERA again. However, your camcorder does not turn off automatically while the cassette is not inserted.

When you record in the SP and LP modes on one tape or you record some scenes in the LP mode

- The transition between scenes may not be smooth.
- The playback picture may be distorted or the time code may not be written properly between scenes.

Recording data

The recording data (date/time or various settings when recorded) are not displayed while recording. However, they are recorded automatically onto the tape. To display the recording data, press DATA CODE on the Remote Commander during playback.

After recording

- (1) Set the POWER switch to OFF (CHG).
- (2) Close the LCD panel.
- (3) Eject the cassette.
- (4) Remove the battery pack.

Adjusting the LCD screen

The LCD panel can be opened up to 90 degrees. The LCD panel moves about 90 degrees to the viewfinder side and about 180 degrees to the lens side.

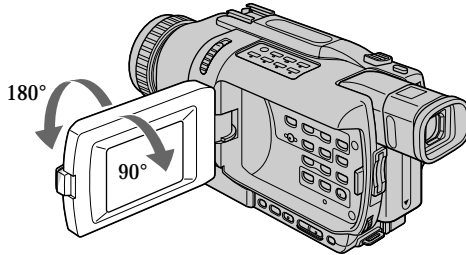

When closing the LCD panel, set it vertically until it clicks, and swing it into the camcorder body.

Note

When using the LCD screen except in the mirror mode, the viewfinder automatically turns off.

When you use the LCD screen outdoors in direct sunlight

The LCD screen may be difficult to see. If this happens, we recommend that you use the viewfinder.

When you adjust angles of the LCD panel

Make sure if the LCD panel is opened up to 90 degrees.

When recording with the LCD panel opened

Recording time becomes shorter a little compared with when recording with the LCD panel closed.

Brightness of the LCD screen

You can adjust the brightness of the LCD screen. Select LCD B.L. or LCD BRIGHT in the menu settings (p. 105). Even if you adjust the LCD B.L. or LCD BRIGHT, the recorded picture will not be affected.

Using the zoom feature

Move the power zoom lever a little for a slower zoom. Move it further for a faster zoom. Using the zoom function sparingly results in better-looking recordings.

“T” side: for telephoto (subject appears closer)

“W” side: for wide-angle (subject appears farther away)

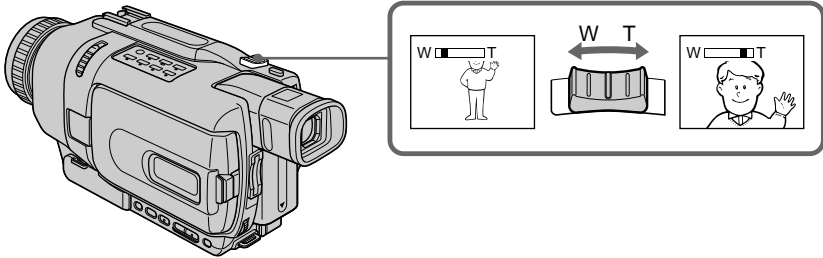

To use zoom greater than 25 \times (DCR-TRV240/TRV340)/15 \times (DCR-TRV740/TRV840) Zoom greater than 25 \times (DCR-TRV240/TRV340)/15 \times (DCR-TRV740/TRV840) is performed digitally. To activate digital zoom, select the digital zoom power in D ZOOM in the menu settings. (p. 105)

The digital zoom function is set to OFF as the default setting.

The right side of the bar shows the digital zooming zone.

The digital zooming zone appears when you select the digital zoom power in the menu settings.

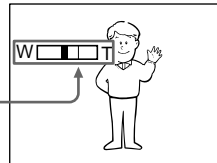

Notes on digital zoom

- Digital zoom starts to function when zoom exceeds 25 \times (DCR-TRV240/TRV340)/15 \times (DCR-TRV740/TRV840).
- The picture quality deteriorates as you go towards the “T” side.

When you shoot close to a subject

If you cannot get a sharp focus, move the power zoom lever to the “W” side until the focus is sharp. You can shoot a subject that is at least about 80 cm (about 2 feet 5/8 inch) away from the lens surface in the telephoto position, or about 1 cm (about 1/2 inch) away in the wide-angle position.

When the POWER switch is set to MEMORY (except DCR-TRV240)

You cannot use the digital zoom.

Adjusting the viewfinder

If you record pictures with the LCD panel closed, check the picture with the viewfinder. Adjust the viewfinder lens to your eyesight so that the indicators in the viewfinder come into sharp focus.

Lift up the viewfinder and move the viewfinder lens adjustment lever.

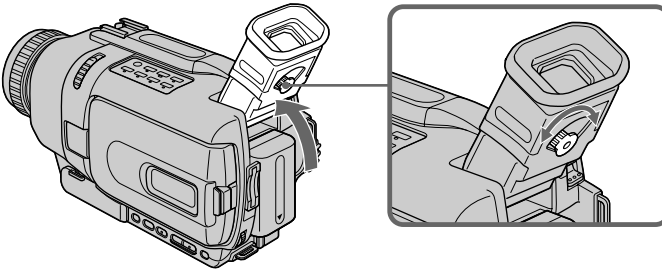

Viewfinder backlight

You can change the brightness of the backlight. Select VF B.L. in the menu settings (p. 105). Even if you adjust the VF B.L., the recorded picture will not be affected.

Shooting with the Mirror Mode

This feature allows the camera subject to view him-or herself on the LCD screen. The subject uses this feature to check his or her own image on the LCD screen while you look at the subject in the viewfinder.

Set the POWER switch to CAMERA or MEMORY (except DCR-TRV240).
Rotate the LCD screen 180 degrees.

The ☺ indicator appears in the viewfinder and on the LCD screen.
■● appears in the standby mode, and ● appears in the recording mode. Some of other indicators appear mirror-reversed and others are not displayed.

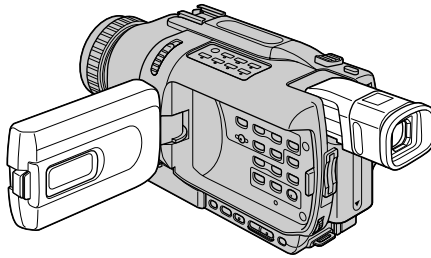

Pictures in the mirror mode

The picture on the LCD is a mirror-image. However, the picture will be normal when recorded.

During recording in the mirror mode

ZERO SET MEMORY on the Remote Commander does not work.

Indicators displayed in the recording mode

Indicators are not recorded on tapes.

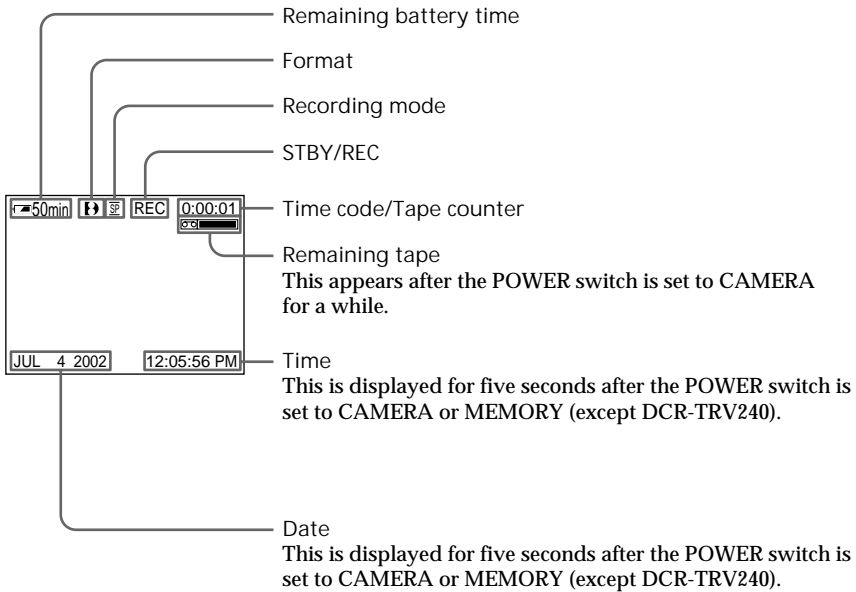

Remaining battery time indicator during recording

The remaining battery time indicator roughly indicates the continuous recording time. The indicator may not be correct, depending on the conditions in which you are recording. When you close the LCD panel and open it again, it takes about one minute for the correct remaining battery time in minutes to be displayed.

Time code (for tapes recorded in the Digital8 **D** system only)

The time code indicates the recording or playback time, "0:00:00" (hours:minutes:seconds) in CAMERA mode and "0:00:00:00" (hours:minutes:seconds:frames) in VCR mode. You cannot rewrite only the time code.

When you play back tapes recorded in the Hi8/standard 8 system, the tape counter appears on the screen.

You cannot reset the time code or the tape counter.

Shooting backlit subjects – BACK LIGHT

When you shoot a subject with the light source behind the subject or a subject with a light background, use the backlight function.

In CAMERA or MEMORY (except DCR-TRV240) mode, press BACK LIGHT.
The  indicator appears on the screen.
To cancel, press BACK LIGHT again.

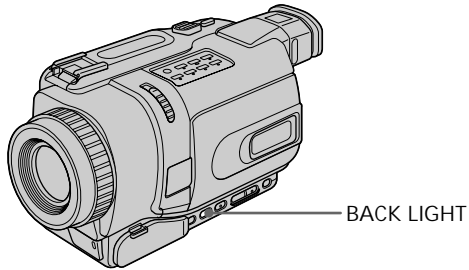

If you press EXPOSURE when shooting backlit subjects
The backlight function will be canceled.

Shooting in the dark – NightShot/Super NightShot/Color Slow Shutter

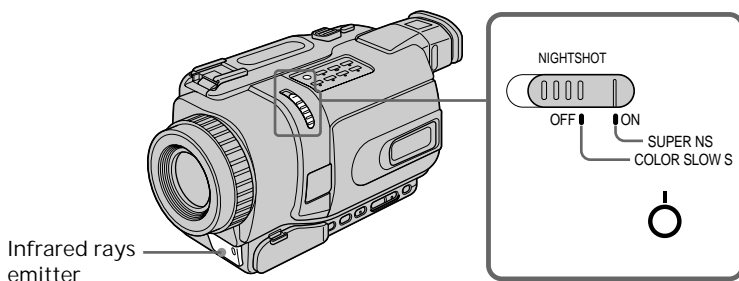

The NightShot function enables you to shoot a subject in a dark place. For example, you can satisfactorily record the environment of nocturnal animals for observation when you use this function.

In CAMERA or MEMORY (except DCR-TRV240) mode, slide NIGHTSHOT to ON. The  and “NIGHTSHOT” indicators flash on the screen. To cancel the NightShot function, slide NIGHTSHOT to OFF.



Using Super NightShot

The Super NightShot function makes subjects up to 16 times brighter than those recorded in the NightShot mode.

- (1) In CAMERA mode, slide NIGHTSHOT to ON. The  and “NIGHTSHOT” indicators flash on the screen.
- (2) Press SUPER NS. The  and “SUPER NIGHTSHOT” indicators flash on the screen.

To cancel the Super NightShot mode, press SUPER NS again.

Using the NightShot Light

The picture will be clearer with the NightShot Light on. To enable NightShot Light, set N.S.LIGHT to ON in the menu settings (The default setting is ON.) (p. 105).

Using Color Slow Shutter

The Color Slow Shutter function enables you to record color images in a dark place.

- (1) Slide NIGHTSHOT to OFF in CAMERA mode.
- (2) Press COLOR SLOW S.

The  and COLOR SLOW SHUTTER indicators flash on the screen.

To cancel the Color Slow Shutter function, press COLOR SLOW S again.

Recording a picture

Notes

- Do not use the NightShot mode in bright places (e.g. outdoors in the daytime). This may cause your camcorder to malfunction.
- When you keep NIGHTSHOT set to ON in normal recording, the picture may be recorded in incorrect or unnatural colors.
- If focusing is difficult with the autofocus mode when using the NightShot function, focus manually.
- You cannot use the Color Slow Shutter function in dark places where the illumination is 0 lux.

While using the NightShot function, you can not use the following functions:

- Exposure
- PROGRAM AE

While using the Super NightShot or Color Slow Shutter function, you cannot use the following functions:

- Fader
- Digital effects
- Exposure
- PROGRAM AE
- Memory Photo recording (except DCR-TRV240)

While using the Super NightShot or Color Slow Shutter function

The shutter speed is automatically adjusted depending on the brightness. At this time, moving pictures may slow down.

When the POWER switch is set to MEMORY (except DCR-TRV240)

You cannot use the following functions:

- Super NightShot
- Color Slow Shutter

NightShot Light

NightShot Light rays are infrared and so are invisible. The maximum shooting distance using the NightShot Light is about 3 m (10 feet).

Self-timer recording

– Except DCR-TRV240

Recording with the self-timer starts in 10 seconds automatically.
You can also use the Remote Commander for this operation.

- (1) In the standby mode, press MENU to display the menu settings.
- (2) Turn the SEL/PUSH EXEC dial to select SELFTIMER in , then press the dial.
- (3) Turn the SEL/PUSH EXEC dial to select ON, then press the dial.
- (4) Press MENU to make the menu settings disappear.
- (5) Press START/STOP.

The self-timer starts counting down from 10 with a beep. In the last two seconds of the countdown, the beep gets faster, then recording starts automatically.

To stop recording, press START/STOP again.

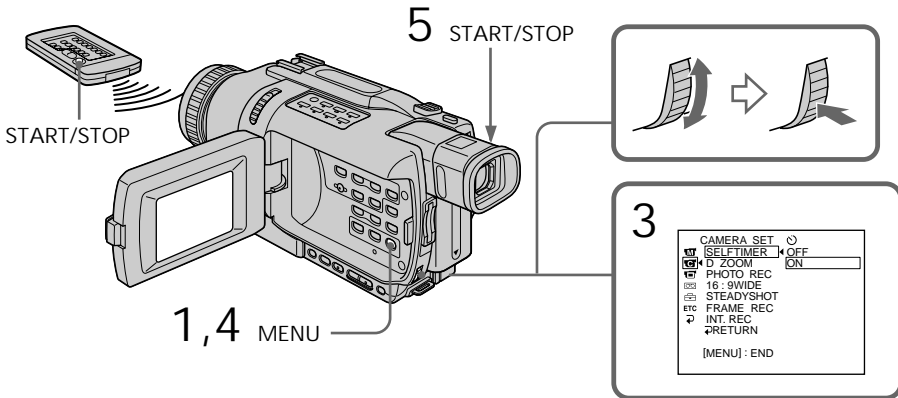

To stop the countdown

Press START/STOP.

To restart the countdown, press START/STOP again.

To cancel self-timer recording

Set SELFTIMER to OFF in the menu settings in the standby mode.

Note

The self-timer recording mode is automatically canceled when:

- Self-timer recording is finished.
- The POWER switch is set to OFF (CHG) or VCR.

When the POWER switch is set to MEMORY (except DCR-TRV240)

You can also record still images on "Memory Stick"s with the self-timer (p. 128).

Checking recordings

- END SEARCH/EDITSEARCH/Rec Review

You can use these buttons to check the recorded picture or shoot so that the transition between the last recorded scene and the next scene you record is smooth.

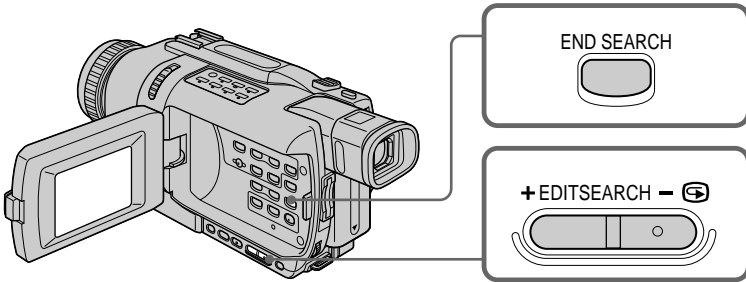

END SEARCH

You can go to the end of the recorded section after you record.

In the standby mode, press END SEARCH.

The last five seconds of the recorded section are played back and your camcorder returns to the standby mode. You can monitor the sound from the speaker or headphones.

EDITSEARCH

You can search for the next recording start point.

In the standby mode, hold down the +/-  side of EDITSEARCH. The recorded portion is played back.

+ : to go forward

-  : to go backward

Release EDITSEARCH to stop playback. If you press START/STOP, re-recording begins from the point you released EDITSEARCH. You cannot monitor the sound.

Rec Review

You can check the last recorded section.

In the standby mode, press the -  side of EDITSEARCH momentarily.

The section you have stopped most recently will be played back for a few seconds, and then your camcorder will return to the standby mode. You can monitor the sound from the speaker or headphones.

Notes

- END SEARCH, EDITSEARCH and Rec Review work only for tapes recorded in the Digital8  system.
- If you start recording after using the end search function, occasionally, the transition between the last scene you recorded and the next scene may not be smooth.
- Once you eject the cassette after you have recorded on the tape, the end search function does not work.

If a tape has a blank portion between recorded portions
The end search function may not work correctly.

Playing back a tape

You can monitor the playback picture on the LCD screen. If you close the LCD panel, you can monitor the playback picture in the viewfinder.
You can control playback using the Remote Commander supplied with your camcorder.

- (1) Install the power source and insert the recorded tape.
- (2) Set the POWER switch to VCR while pressing the small green button.
- (3) Open the LCD panel while pressing OPEN.
- (4) Press ◀◀ to rewind the tape.
- (5) Press ▶▶ to start playback.
- (6) To adjust the volume, press either of the two buttons on VOLUME. When you close the LCD panel, sound is muted.

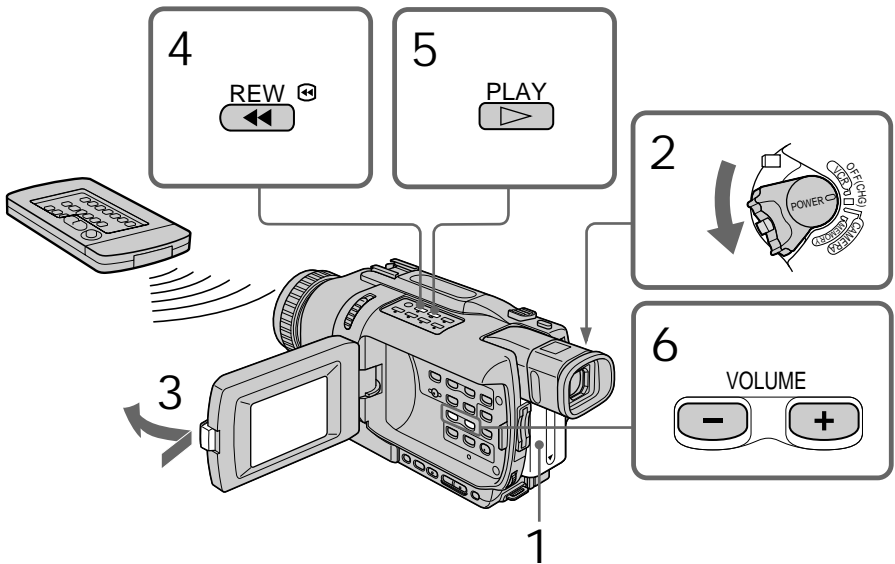

To stop playback
Press ■.

When monitoring on the LCD screen

You can turn the LCD panel over and move it back to the camcorder body with the LCD screen facing out.

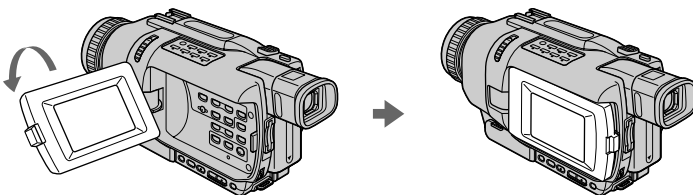

To display the screen indicators – Display function

Press DISPLAY on your camcorder or the Remote Commander supplied with your camcorder. The indicators appear on the screen.

To make the indicators disappear, press DISPLAY again.

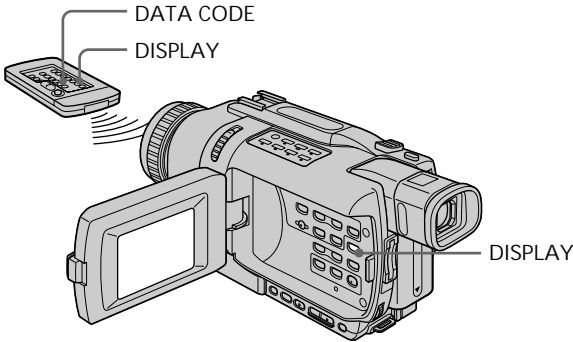

About date/time and various settings

Your camcorder automatically records not only pictures on the tape but also the recording data (date/time or various settings when recorded) (Data code).

Use the Remote Commander for this operation.

① Set the POWER switch to VCR, then playback a tape.

② Press DATA CODE on the Remote Commander.

The display changes as follows:

date/time → various settings (SteadyShot, exposure, white balance, gain, shutter speed, aperture value) → no indicator

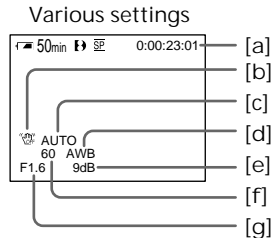

- [a] Time code/Tape counter
- [b] SteadyShot off
- [c] Exposure mode
- [d] White balance
- [e] Gain
- [f] Shutter speed
- [g] Aperture value

Playing back a tape

To not display various settings

Set DATA CODE to DATE in the menu settings (p. 105).

The display changes as follows when you press DATA CODE on the Remote Commander:

date/time ↔ no indicator

Notes on the data code function

- The data code function works only for tapes recorded in the Digital8  system.
- Various settings of the recording data are not recorded when recording images on “Memory Stick”s (except DCR-TRV240).

Recording data

Recording data is your camcorder’s information when you have recorded. In the recording mode, the recording data will not be displayed.

When you use data code function, bars (-- --) appear if:

- A blank portion of the tape is being played back.
- The tape is unreadable due to tape damage or noise.
- The tape was recorded by a camcorder without the date and time set.

Data code

When you connect your camcorder to the TV, the data code appears on the TV screen.



Remaining battery time indicator during playback

The indicator indicates the approximate continuous playback time. The indicator may not be correct, depending on the conditions in which you are playing back. When you close the LCD panel and open it again, it takes about one minute for the correct remaining battery time to be displayed.



Various playback modes

To operate video control buttons, set the POWER switch to VCR.



To playback pause (view a still image)

Press  during playback. To resume normal playback, press  or .

To advance the tape

Press  in the stop mode. To resume normal playback, press .

To rewind the tape



Press  in the stop mode. To resume normal playback, press .

To change the playback direction

Press < on the Remote Commander during playback to reverse the playback direction.

To resume normal playback, press .

To locate a scene monitoring the picture (picture search)

Keep pressing  or  during playback. To resume normal playback, release the button.

To monitor high-speed pictures while advancing or rewinding the tape (skip scan)

Keep pressing ◀◀ while rewinding or ▶▶ while advancing the tape. To resume rewinding or advancing, release the button.

To view pictures at slow speed (slow playback)

Press ▶▶ on the Remote Commander during playback. For slow playback in the reverse direction, press <, then press ▶▶ on the Remote Commander. To resume normal playback, press ▶.

To view pictures at double speed

Press ×2 on the Remote Commander during playback. For double speed playback in the reverse direction, press <, then press ×2 on the Remote Commander. To resume normal playback, press ▶.

To view pictures frame-by-frame

Press II▶ on the Remote Commander in the playback pause mode. For frame-by-frame playback in the reverse direction, press ◀II. To resume normal playback, press ▶.

To search the last scene recorded (END SEARCH)

Press END SEARCH in the stop mode. The last five seconds of the recorded section plays back and stops.

In the various playback modes

- Noise may appear when your camcorder plays back tapes recorded in the Hi8/standard 8 system.
- Sound is muted.
- The previous recording may appear as a mosaic image when playing back in the Digital8 D system.

Notes on the playback pause mode

- When the playback pause mode lasts for three minutes, your camcorder automatically enters the stop mode. To resume playback, press ▶.
- The previous recording may appear.

Slow playback for tapes recorded in the Digital8 D system

Slow playback can be performed smoothly on your camcorder; however, this function does not work for an output signal through the DV IN/OUT jack.

When you play back a tape in reverse

Horizontal noise may appear at the center, or top and bottom of the screen. This is not a malfunction.

Viewing recordings on TV

Connect your camcorder to your TV with the A/V connecting cable supplied with your camcorder to watch playback pictures on the TV screen. You can operate the video control buttons in the same way as when you monitor playback pictures on the LCD screen. When monitoring playback pictures on the TV screen, we recommend that you power your camcorder from a wall outlet using the AC power adaptor (p. 17). Refer to the operating instructions of your TV.

Open the jack cover. Connect your camcorder to the TV using the A/V connecting cable supplied with your camcorder. Then, set the TV/VCR selector on the TV to VCR.

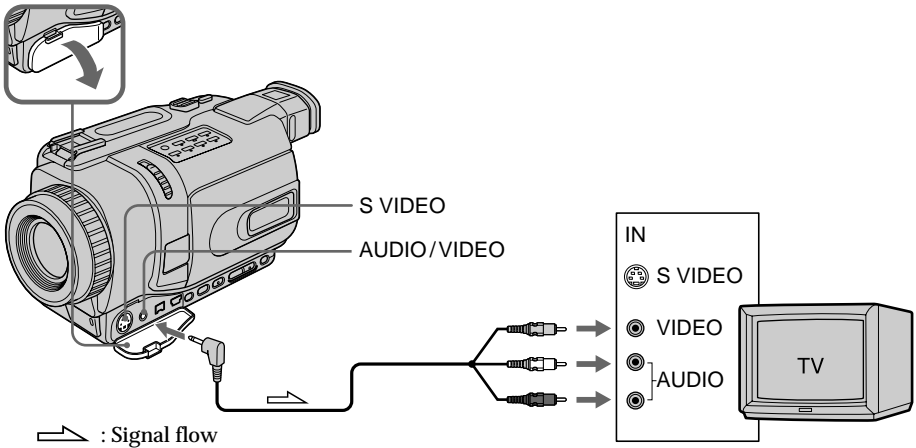

If your TV is already connected to a VCR

Connect your camcorder to the LINE IN input on the VCR by using the A/V connecting cable supplied with your camcorder. Set the input selector on the VCR to LINE.

If your TV or VCR is a monaural type

Connect the yellow plug of the A/V connecting cable to the video input jack and the white or the red plug to the audio input jack on the VCR or the TV. If you connect the white plug, the sound is L (left) signal. If you connect the red plug, the sound is R (right) signal.

If your TV has an S video jack

Pictures can be reproduced more faithfully by using an S video cable (optional). With this connection, you do not need to connect the yellow (video) plug of the A/V connecting cable. Connect the S video cable (optional) to the S video jacks on both your camcorder and the TV.

To display the screen indicators on TV

Set DISPLAY to V-OUT/LCD in the menu settings (p. 105).

Then, press DISPLAY on your camcorder. To turn the screen indicators off, press DISPLAY on your camcorder again.

Recording still images on a tape

– Tape Photo recording

You can record still images such as photographs.

You can record about 510 images in the SP mode and about 765 images in the LP mode on a tape which can record for 60 minutes in the SP mode.

Besides the operation described here, your camcorder can record still images on "Memory Stick"s (except DCR-TRV240) (p. 124).

Before operation

Set PHOTO REC to TAPE in the menu settings. (The default setting is MEMORY.) (except DCR-TRV240) (p. 105)

- (1) In the standby mode, keep pressing PHOTO lightly until a still image appears. The CAPTURE indicator appears. Recording does not start yet.
To change the still image, release PHOTO, select a still image again, and then press and hold PHOTO lightly.
- (2) Press PHOTO deeper.
The still image on the screen is recorded for about seven seconds. The sound during those seven seconds is also recorded.
The still image is displayed on the screen until recording is completed.

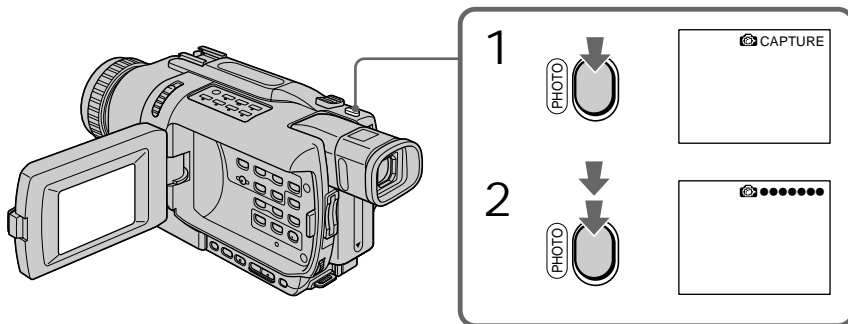

Notes

- During Tape Photo recording, you cannot change the mode or setting.
- You cannot use PHOTO during the following operations:
 - Fader
 - Digital effects
- When recording a still image, do not shake your camcorder. The image may fluctuate.

If you record a moving subject with tape photo recording function
The image may fluctuate when you play back the still image on other equipment.
This is not a malfunction.

To use tape photo recording function using the Remote Commander
Press PHOTO on the Remote Commander. Your camcorder records an image on the screen immediately.

Recording still images on a tape – Tape Photo recording

To use the tape photo recording function during normal CAMERA recording
You cannot check an image on the screen by pressing PHOTO lightly. Press PHOTO deeper. The still image is then recorded for about seven seconds, and your camcorder returns to the standby mode.

To record clear and less fluctuated still images
We recommend that you record on “Memory Stick”s.
You can record still images on “Memory Stick”s even in CAMERA mode. (P.124)
(except DCR-TRV240)

Self-timer recording

– Except DCR-TRV240

You can record still images on tapes with the self-timer.

You can also use the Remote Commander for this operation.

Before operation

Set PHOTO REC to TAPE in the menu settings. (The default setting is MEMORY.)

(p. 105)

- (1) In the standby mode, press MENU to display the menu settings.
- (2) Turn the SEL/PUSH EXEC dial to select SELFTIMER in , then press the dial.
- (3) Turn the SEL/PUSH EXEC dial to select ON, then press the dial.
- (4) Press MENU to make the menu settings disappear.
- (5) Press PHOTO deeper.

The self-timer starts counting down from 10 with a beep sound. In the last two seconds of the countdown, the beep gets faster, then recording starts automatically.

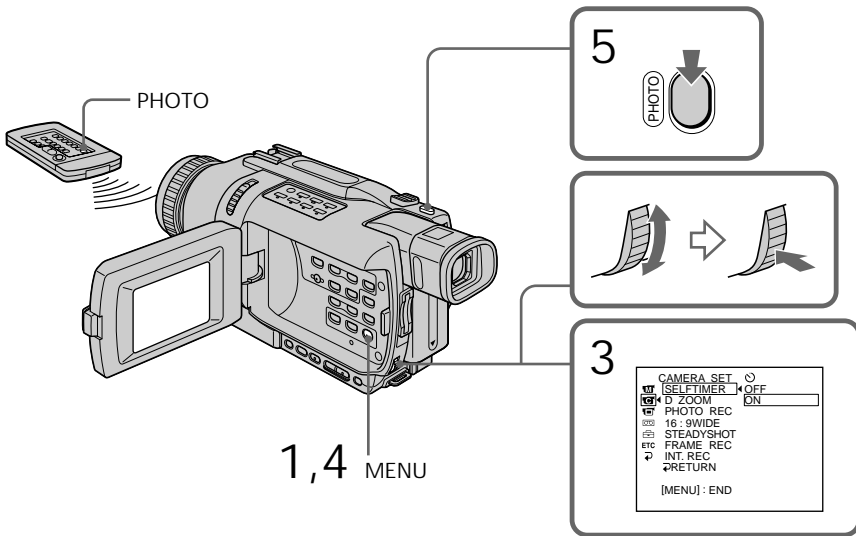

To cancel self-timer recording

In the standby mode, set SELFTIMER to OFF in the menu settings.

You cannot cancel self-timer recording using the Remote Commander.

Note

The self-timer recording mode is automatically canceled when:

- Self-timer recording is finished.
- The POWER switch is set to OFF (CHG) or VCR.

Using the wide mode

You can record a 16:9 wide picture to watch on a 16:9 wide-screen TV (16:9WIDE). Black bands appear on the screen during recording in 16:9WIDE mode [a]. The picture during playing back on a normal TV [b] or a wide-screen TV [c] are compressed in the widthwise direction. If you set the screen mode of the wide-screen TV to the full mode, you can watch pictures of normal images [d].

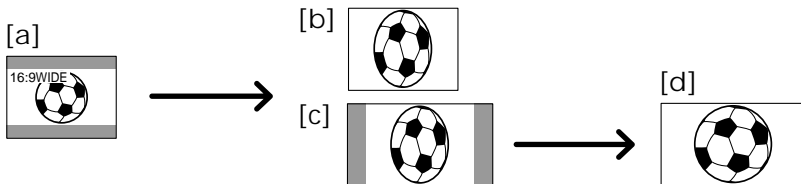

- (1) In the standby mode, press MENU to display the menu settings.
- (2) Turn the SEL/PUSH EXEC to select 16:9WIDE in **[C]**, then press the dial.
- (3) Turn the SEL/PUSH EXEC to select ON, then press the dial.

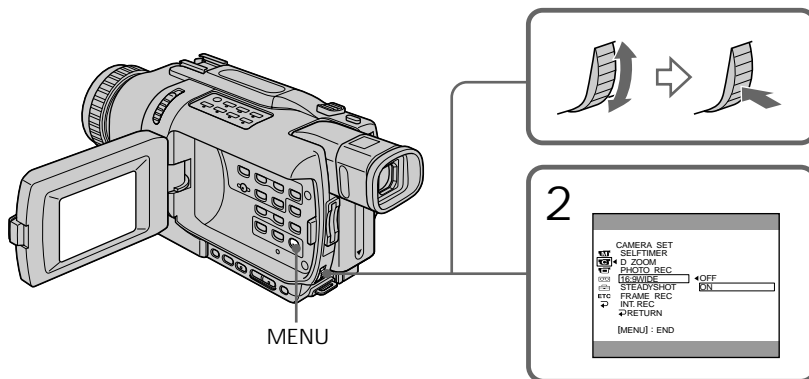

To cancel the wide mode
Set 16:9WIDE to OFF in the menu settings.

In the wide mode

You cannot operate the following functions:

- OLD MOVIE
- BOUNCE
- Memory Photo recording (except DCR-TRV240)

During recording

You cannot select or cancel the wide mode.

When you cancel the wide mode, set your camcorder to the standby mode and then set 16:9WIDE to OFF in the menu settings.

Connection for a TV

Pictures recorded in the 16:9WIDE mode automatically appear on the TV screen at full size when:

- You connect your camcorder to a TV that is compatible with the video ID (ID-1/ID-2) system.
- You connect your camcorder to the S video jack on the TV.

Using the wide mode

ID-1 system

The ID-1 system sends aspect ratio (screen horizontal/vertical ratio) information (16:9, 4:3, or letter box) with video signals. If you connect a TV compatible with the ID-1 system, the screen size is automatically selected.

ID-2 system

The ID-2 system sends a copyright protection signal with ID-1 signals inserted between video signals when you connect your camcorder to other equipment by an A/V connecting cable.

If 16:9WIDE is set to ON (DCR-TRV240/TRV340 only)

The SteadyShot function does not work. If you set 16:9WIDE to ON in the menu settings when the SteadyShot function is working,  flashes and the SteadyShot function does not function.

Using the fader function

You can fade in or out to give your recording a more professional appearance.

[a] STBY REC

FADER



M.FADER
(mosaic)



BOUNCE ^{1) 2)}

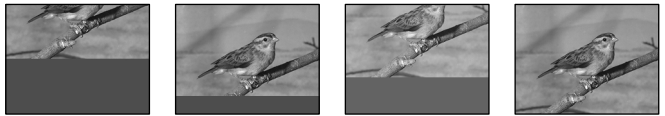

OVERLAP ²⁾

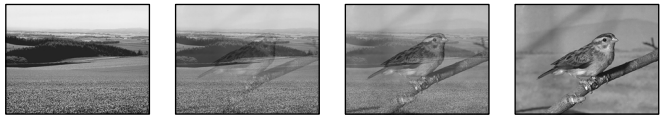

WIPE ²⁾



DOT ²⁾

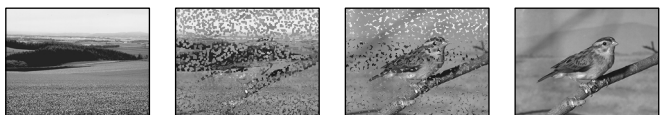

[b] STBY REC

MONOTONE

When fading in, the picture gradually changes from black-and-white to color.
When fading out, the picture gradually changes from color to black-and-white.

¹⁾ You can use this function when D ZOOM is set to OFF in the menu settings.

²⁾ Fade in only

Using the fader function

- (1) When fading in [a]
In the standby mode, press FADER until the desired fader indicator flashes.
When fading out [b]
In the recording mode, press FADER until the desired fader indicator flashes.
The indicator changes as follows:
FADER → M.FADER → BOUNCE → MONOTONE
no indicator ← DOT ← WIPE ← OVERLAP
The last selected fader mode is indicated first of all.
- (2) Press START/STOP. The fader indicator stops flashing.
After fade in/out ends, your camcorder automatically returns to the normal mode.

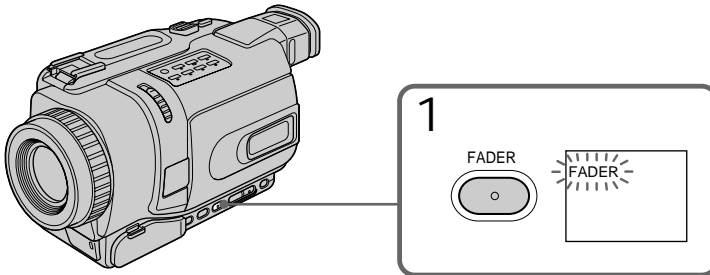

To cancel the fader function

Before pressing START/STOP, press FADER repeatedly until the indicator disappears.

Notes

- The overlap, wipe and dot functions work only for tapes recorded in the Digital8  system.
- You cannot use the following functions while using the fader function. Also, you cannot use the fader function while using the following functions:
 - Digital effects
 - Color Slow Shutter
 - Super NightShot
 - Photo recording
 - Interval recording
 - Frame recording

When you select OVERLAP, WIPE, or DOT

Your camcorder automatically stores the picture recorded on tape. While the picture is being stored, the indicators flash fast, and the picture from the tape appears on the screen. At this stage, the picture may not be recorded clearly, depending on the tape condition.

Using the fader function

While using the bounce function, you cannot use the following functions:

- Focus
- Zoom
- Picture effects

Note on the bounce function

The BOUNCE indicator does not appear in the following mode or functions:

- When D ZOOM is activated in the menu settings
- Wide mode
- Picture effects
- PROGRAM AE

Using special effects – Picture effect

You can digitally process pictures to obtain special effects like those in films or on the TV.

NEG. ART [a] : The color and brightness of the picture is reversed.

SEPIA : The picture appears in sepia.

B&W : The picture appears in monochrome (black-and-white).

SOLARIZE [b] : The light intensity becomes clearer to make the picture look more like an illustration.

SLIM [c] : The picture expands vertically.

STRETCH [d] : The picture expands horizontally.

PASTEL [e] : The contrast of the picture is emphasized to make the picture look more like an animated cartoon.

MOSAIC [f] : The picture appears mosaic-patterned.

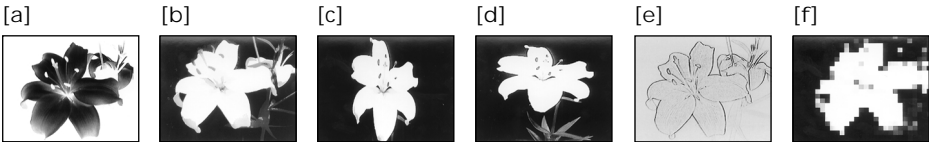

- (1) In CAMERA mode, press MENU to display the menu settings.
- (2) Turn the SEL/PUSH EXEC dial to select P EFFECT in , then press the dial.
- (3) Turn the SEL/PUSH EXEC dial to select the desired picture effect mode, then press the dial.

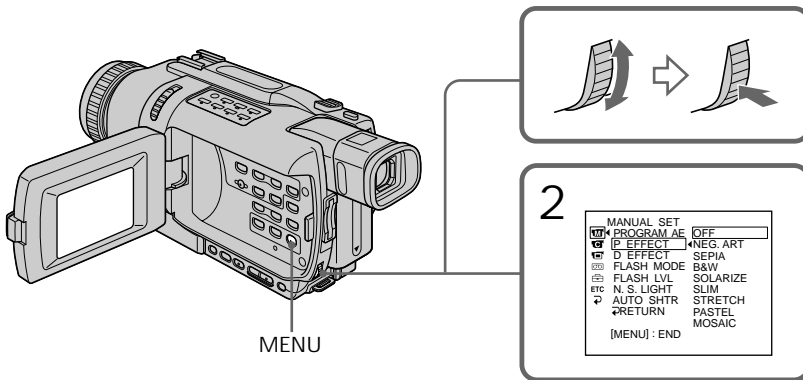

To cancel the picture effect
Set P EFFECT to OFF in the menu settings.

While using the picture effect function

You cannot operate the following functions:

- OLD MOVIE with the digital effect function.
- Memory Photo recording (except DCR-TRV240)

When you set the POWER switch to OFF (CHG)
Picture effects are automatically canceled.

Using special effects – Digital effect

You can add special effects to recorded picture using the various digital functions. Sound is recorded normally.

STILL

You can record a still image so that it is superimposed on a moving picture.

FLASH (FLASH MOTION)

You can record still images successively at constant intervals.

LUMI. (LUMINANCEKEY)

You can swap a brighter area in a still image with a moving picture.

TRAIL

You can record the picture so that an incidental image like a trail is left.

SLOW SHTR (SLOW SHUTTER)

You can slow down the shutter speed. The slow shutter mode is good for recording dark picture more brightly.

OLD MOVIE

You can add an old movie type atmosphere to pictures. Your camcorder automatically sets the wide mode to ON, picture effect to SEPIA, and sets the appropriate shutter speed.

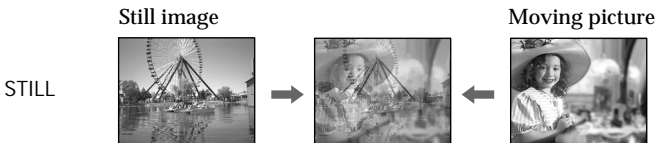

Using special effects – Digital effect

- (1) In CAMERA mode, press MENU to display the menu settings.
- (2) Turn the SEL/PUSH EXEC dial to select D EFFECT in , then press the dial.
- (3) Turn the SEL/PUSH EXEC dial to select the desired digital effect mode.
- (4) Press the SEL/PUSH EXEC dial. The bars appear on the screen. In the STILL and LUMI. modes, the still image is stored in memory.
- (5) Turn the SEL/PUSH EXEC dial to adjust the effect as follows:

Items to be adjusted

STILL	The rate of the still image you want to superimpose on the moving picture
FLASH	The interval of flash motion
LUMI.	The color scheme of the area in the still image which is to be swapped with a moving picture
TRAIL	The vanishing time of the incidental picture
SLOW SHTR	Shutter speed. The larger the shutter speed number, the slower the shutter speed becomes.
OLD MOVIE	No adjustment necessary

The more bars there are on the screen, the stronger the digital effect. The bars appear in the following modes: STILL, FLASH, LUMI. and TRAIL.

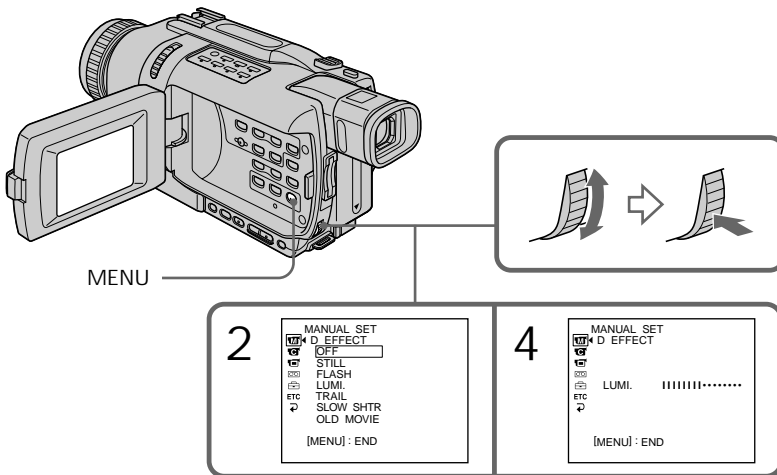

To cancel the digital effect
Set D EFFECT to OFF in the menu settings.

Notes

- The following functions do not work during digital effects:
 - Fader
 - Photo recording
 - Super NightShot
 - Color Slow Shutter
- The PROGRAM AE function does not work in the slow shutter mode.
- The following functions do not work in the old movie mode:
 - Wide mode
 - Picture effects
 - PROGRAM AE

When you set the POWER switch to OFF (CHG)

Digital effects are automatically canceled.

When recording in the slow shutter mode

Auto focus may not be effective. Focus manually using a tripod.

Shutter speed

Shutter speed number	Shutter speed
SLOW SHTR 1	1/30
SLOW SHTR 2	1/15
SLOW SHTR 3	1/8
SLOW SHTR 4	1/4

Using the PROGRAM AE function

You can select the PROGRAM AE (Auto Exposure) mode to suit your specific shooting requirements.

Spotlight

This mode prevents people's faces, for example, from appearing excessively white when shooting subjects lit by strong light in the theater.

Soft portrait

This mode brings out the subject while creating a soft background for subjects such as people or flowers.

Sports lesson

This mode minimizes camera shake on fast-moving subjects such as in tennis or golf.

Beach & ski

This mode prevents peoples' faces from appearing dark in strong light or reflected light, such as at a beach in midsummer or on a ski slope.

Sunset & moon

This mode allows you to maintain atmosphere when you are recording sunsets, general night views, fireworks displays and neon signs.

Landscape

This mode is for when you are recording distant subjects such as mountains and prevents your camcorder from focusing on glass or metal mesh in windows' when you are recording a subject behind glass or a screen.



Using the PROGRAM AE function

- (1) In CAMERA or MEMORY (except DCR-TRV240) mode, press MENU to display the menu settings.
- (2) Turn the SEL/PUSH EXEC dial to select PROGRAM AE in , then press the dial.
- (3) Turn the SEL/PUSH EXEC dial to select the desired mode.

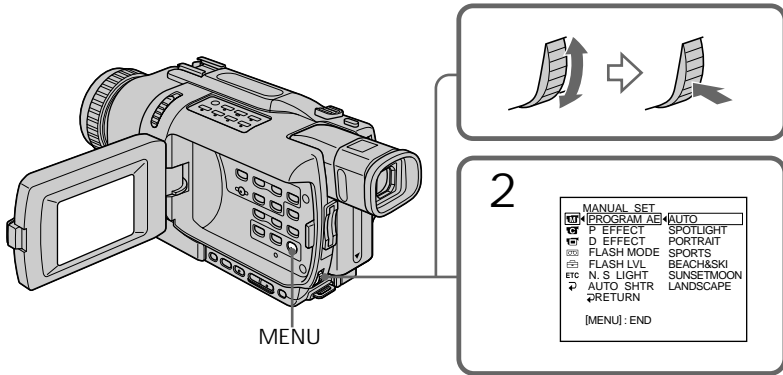

To cancel the PROGRAM AE function
Set PROGRAM AE to AUTO in the menu settings.

Notes

- Because your camcorder is set to focus only on subjects in the middle to far distance, you cannot take close-ups in the following modes:
 - Spotlight
 - Sports lesson
 - Beach & ski
- Your camcorder is set to focus only on distant subjects in the following modes:
 - Sunset & moon
 - Landscape
- The following functions do not work in the PROGRAM AE mode:
 - Color Slow Shutter
 - Slow shutter
 - OLD MOVIE
 - BOUNCE
- While setting NIGHTSHOT to ON, the PROGRAM AE function does not work. (The indicator flashes.)
- The PROGRAM AE function does not work in the Color Slow Shutter mode.

If you are recording under a discharge tube such as a fluorescent lamp, sodium lamp or mercury lamp

Flickering or changes in color may occur in the following modes. If this happens, turn the PROGRAM AE function off.

- Soft portrait
- Sports lesson

Adjusting the exposure manually

You can manually adjust and set the exposure. Normally, exposure is automatically adjusted.

Adjust the exposure manually in the following cases:

- When the subject is backlit
- When shooting bright subjects and dark backgrounds
- When recording dark pictures (e.g. night scenes) faithfully

- (1) In CAMERA or MEMORY (except DCR-TRV240) mode, press EXPOSURE. The exposure indicator appears on the screen.
- (2) Turn the SEL/PUSH EXEC dial to adjust the brightness.

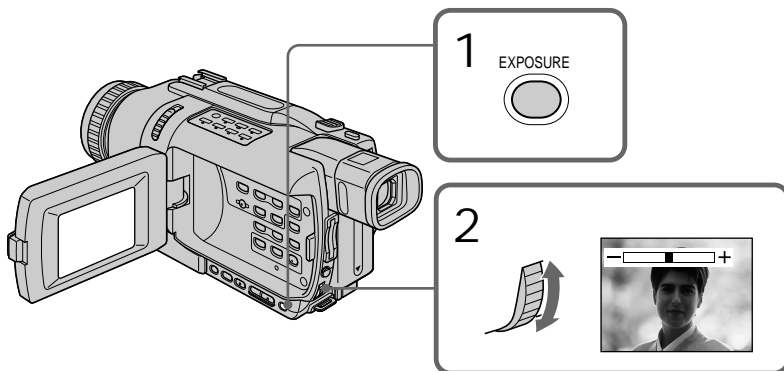

To return to the automatic exposure mode

Press EXPOSURE to turn off the indicator.

Note

When you adjust the exposure manually, the following functions do not work:

- BACKLIGHT
- Color Slow Shutter

Your camcorder automatically returns to the automatic mode:

- If you change the PROGRAM AE mode
- If you slide NIGHTSHOT to ON

Focusing manually

You can gain better results by manually adjusting the focus in the following cases.
Normally, focus is automatically adjusted:

- The autofocus mode is not effective when shooting:
 - Subjects through glass coated with water droplets.
 - Horizontal stripes.
 - Subjects with little contrast with backgrounds such as walls and sky.
- When you want to change the focus from a subject in the foreground to a subject in the background.
- Shooting a stationary subject when using a tripod.

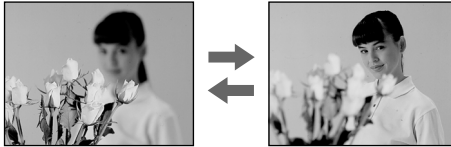

- (1) In CAMERA or MEMORY (except DCR-TRV240) mode, press FOCUS. The  indicator appears on the screen.
- (2) Turn the focus ring to sharpen focus.

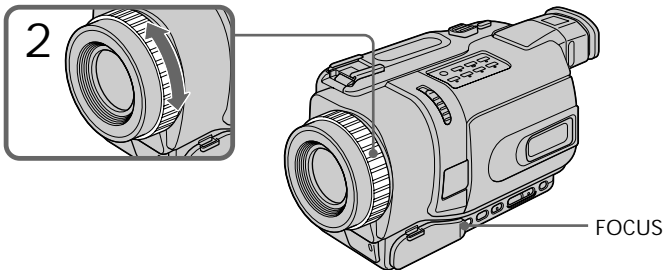



To return to the autofocus mode
Press FOCUS to turn off the indicator.

To focus precisely

It is easier to focus on subjects if you adjust the zoom to shoot at the “W” (wide-angle) after focusing at the “T” (telephoto) position.

When you shoot close to the subject
Focus at the end of the “W” (wide-angle) position.

 changes to the following indicators:

-  when recording a distant subject.
-  when the subject is too close to focus on.

Interval recording

You can make a time-lapse recording by setting your camcorder to automatically record and standby sequentially. You can achieve an excellent recording for flowering, gradual appearances, etc., with this function.

Example

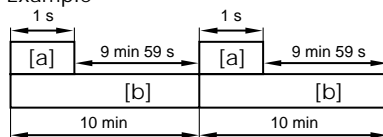

[a] REC TIME

[b] INTERVAL

- (1) In the standby mode, press MENU to display the menu settings.
- (2) Turn the SEL/PUSH EXEC dial to select INT. REC in , then press the dial.
- (3) Turn the SEL/PUSH EXEC dial to select SET, then press the dial.
- (4) Set INTERVAL and REC TIME.
 - ① Turn the SEL/PUSH EXEC dial to select INTERVAL, then press the dial.
 - ② Turn the SEL/PUSH EXEC dial to select the desired interval time, then press the dial.
The time: 30SEC ↔ 1MIN ↔ 5MIN ↔ 10MIN
 - ③ Turn the SEL/PUSH EXEC dial to select REC TIME, then press the dial.
 - ④ Turn the SEL/PUSH EXEC dial to select the desired recording time, then press the dial.
The time: 0.5SEC ↔ 1SEC ↔ 1.5SEC ↔ 2SEC
 - ⑤ Turn the SEL/PUSH EXEC dial to select ↶ RETURN, then press the dial.
- (5) Turn the SEL/PUSH EXEC dial to select ON, then press the dial.
- (6) Press MENU to make the menu settings disappear. The INTERVAL indicator flashes.
- (7) Press START/STOP to start interval recording. The INTERVAL indicator lights up.

Interval recording

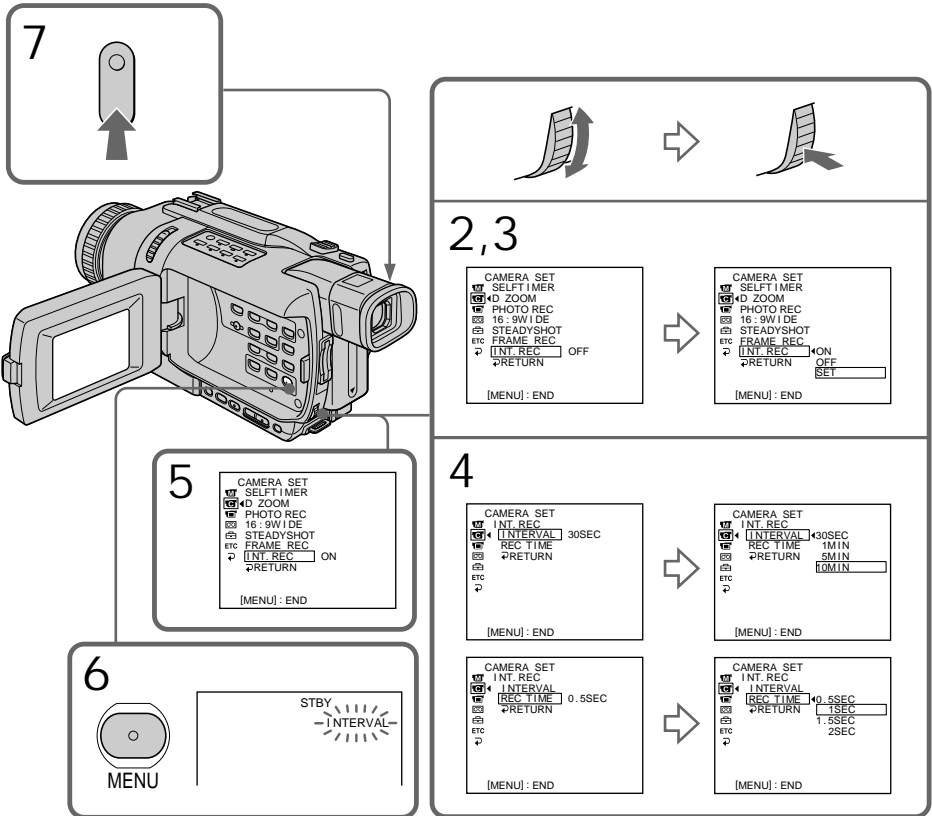

To cancel interval recording

Perform either of the following:

- Set INT. REC to OFF in the menu settings.
- Set the POWER switch to other than CAMERA.

To perform normal recording during interval recording

You can perform normal recording only once during INTERVAL.

Press START/STOP. The INTERVAL indicator flashes, and normal recording starts. To stop normal recording, press START/STOP again.

On recording time

There may be a discrepancy in the recording time of up to +/- six frames from the selected time.

Frame by frame recording

– Frame recording

You can make a recording with a stop-motion animated effect using frame recording. To create this effect, alternately move the subject a little and make a frame recording. We recommend that you use a tripod, and operate your camcorder using the Remote Commander after step 5.

- (1) In the standby mode, press MENU to display the menu settings.
- (2) Turn the SEL/PUSH EXEC dial to select FRAME REC in , then press the dial.
- (3) Turn the SEL/PUSH EXEC dial to select ON, then press the dial.
- (4) Press MENU to make the menu settings disappear.

The FRAME REC indicator appears.

- (5) Press START/STOP to start frame recording. Your camcorder makes a recording for about six frames, and returns to recording standby.
- (6) Move the subject, and repeat step 5.

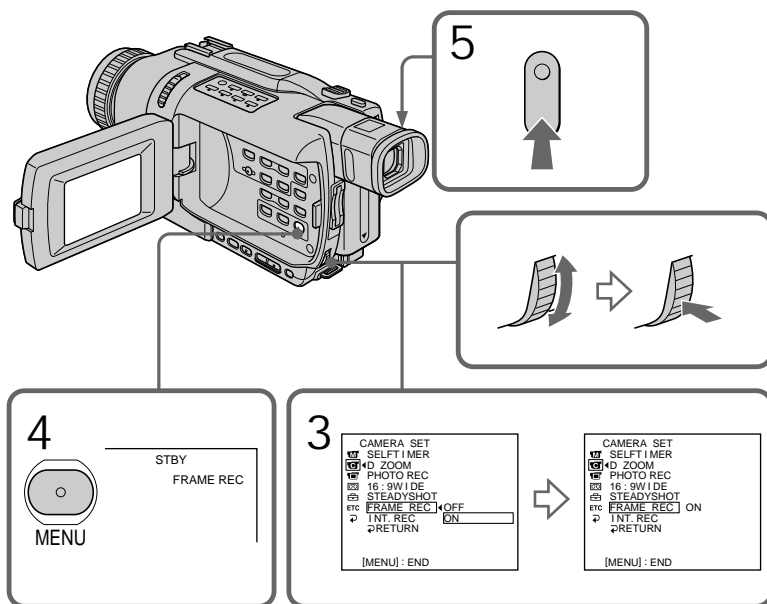

To cancel the frame recording

Perform either of the following:

- Set FRAME REC to OFF in the menu settings.
- Set the POWER switch to other than CAMERA.

Note

The remaining tape time is not indicated correctly if you use this function continuously.

When using the frame recording function

The last recorded cut is longer than other cuts.

Superimposing a title

You can select one of eight preset titles and two custom titles (p. 60). You can also select the language, color, size and position of titles.



- (1) In the standby mode, press TITLE to display the title menu. The title menu display appears on the screen.
- (2) Turn the SEL/PUSH EXEC dial to select , then press the dial.
- (3) Turn the SEL/PUSH EXEC dial to select the desired title, then press the dial. The titles are displayed in the language you selected.
- (4) Change the color, size, or position, if necessary.
 - ① Turn the SEL/PUSH EXEC dial to select COLOR, SIZE, or POSITION, then press the dial. The selected item appears on the screen.
 - ② Turn the SEL/PUSH EXEC dial to select the desired item, then press the dial.
 - ③ Repeat steps ① and ② until the title is laid out as desired.
- (5) Press the SEL/PUSH EXEC dial again to complete the setting.
- (6) Press START/STOP to start recording.
- (7) When you want to stop recording the title, press TITLE.

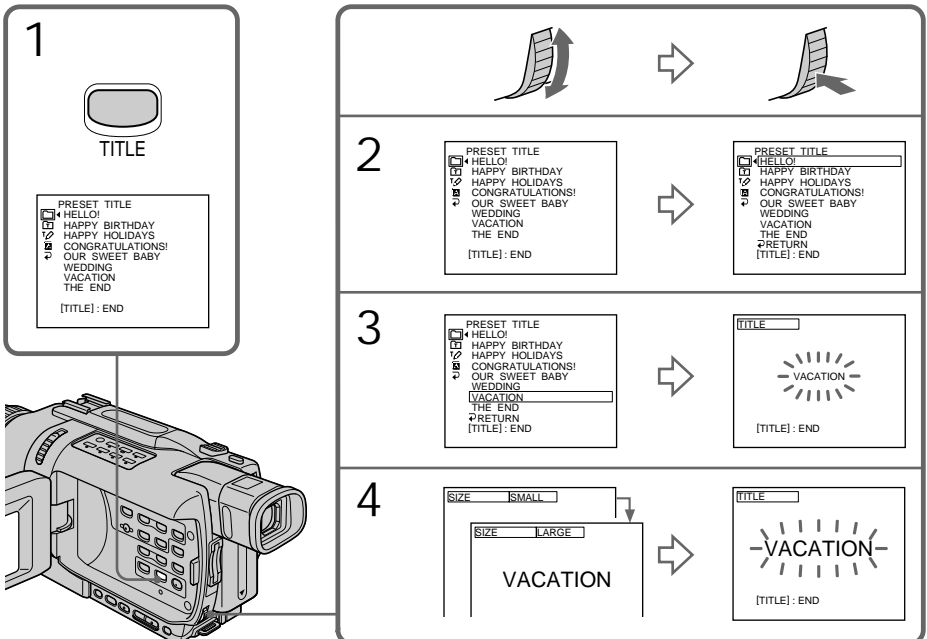

Superimposing a title

To superimpose the title while you are recording

Press TITLE while you are recording, and carry out steps 2 to 5. When you press the SEL/PUSH EXEC dial at step 5, the title is recorded.

To select the language of a preset title

If you want to change the language, select  before step 2. Then select the desired language and return to step 2.

If you display the menu while superimposing a title

The title is not recorded while the menu is displayed.

To use a custom title

If you want to use a custom title, select  in step 2.

Title setting

- The title color changes as follows:
WHITE ↔ YELLOW ↔ VIOLET ↔ RED ↔ CYAN ↔ GREEN ↔ BLUE

- The title size changes as follows:

SMALL ↔ LARGE

You cannot input 13 characters or more in LARGE size. If you input more than 12 characters, the title size returns to SMALL even you select LARGE.

- The title position changes as follows:

1 ↔ 2 ↔ 3 ↔ 4 ↔ 5 ↔ 6 ↔ 7 ↔ 8 ↔ 9

The larger the position number, the lower the title is positioned.

When you select the title size LARGE, you cannot choose position 9.

When you are selecting and setting the title

You cannot record the title displayed on the screen.

When you superimpose a title while you are recording

The beep does not sound.

While you are playing back

You can superimpose a title. However, the title is not recorded on tape.

You can record a title when you dub a tape connecting your camcorder to the VCR with the A/V connecting cable. If you use the i.LINK cable instead of the A/V connecting cable, you cannot record the title.

Making your own titles

You can make up to two titles and store them in your camcorder. Each title can have up to 20 characters.

- (1) In the standby or VCR mode, press TITLE.
- (2) Turn the SEL/PUSH EXEC dial to select , then press the dial.
- (3) Turn the SEL/PUSH EXEC dial to select CUSTOM1 SET or CUSTOM2 SET, then press the dial.
- (4) Turn the SEL/PUSH EXEC dial to select the column of the desired character, then press the dial.
- (5) Turn the SEL/PUSH EXEC dial to select the desired character, then press the dial.
- (6) Repeat steps 4 and 5 until you have selected all characters and completed the title.
- (7) To finish making your own titles, turn the SEL/PUSH EXEC dial to select [SET], then press the dial. The title is stored in memory.
- (8) Press TITLE to make the title menu disappear.

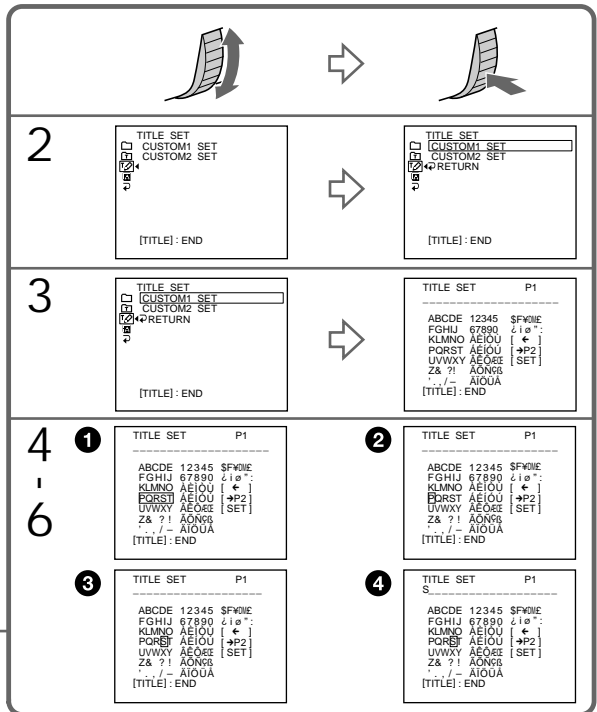
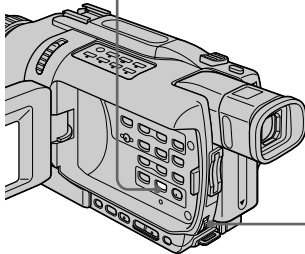
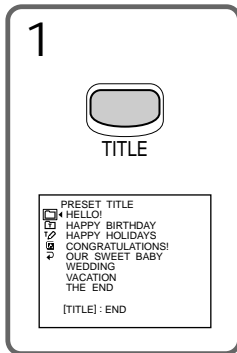

Making your own titles

To change a title you have stored

In step 3, select CUSTOM1 SET or CUSTOM2 SET, depending on which title you want to change, then press the SEL/PUSH EXEC dial.

Turn the SEL/PUSH EXEC dial to select [←], then press the dial to delete the title. The last character is erased. Enter the new title as desired.

If you take three minutes or longer to enter characters in the standby mode while a cassette is in your camcorder

The power automatically goes off. The characters you have entered remain stored in memory. Set the POWER switch to OFF (CHG) once, and turn it to CAMERA again, then proceed from step 1.

We recommend setting the POWER switch to VCR or removing the cassette so that your camcorder does not automatically turn off while you are entering title characters.

If you select [→P2]

The menu for selecting alphabet and Russian characters appear. Select [→P1] to return to the previous screen.

To erase a character

Select [←]. The last character is erased.

To enter a space

Select [Z& ?!], then select the blank part.

Inserting a scene

You can insert a scene in the middle of a recorded tape by setting the start and end points. The previously recorded frames between these start and end points will be erased.

Use the Remote Commander for this operation.

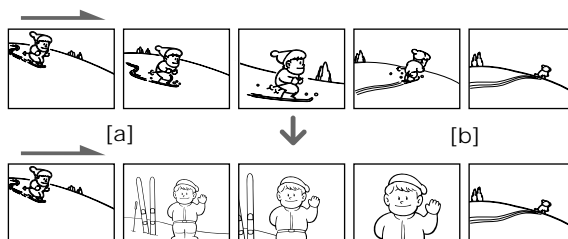

- (1) In the standby mode, keep pressing EDITSEARCH, and release the button at the insert end point [b].
- (2) Press ZERO SET MEMORY on the Remote Commander.
The ZERO SET MEMORY indicator flashes and the counter resets to zero.
- (3) Keep pressing the - ⊖ side of EDITSEARCH and release the button at the insert start point [a].
- (4) Press START/STOP to start recording.
The scene is inserted. Recording stops automatically near the counter zero point. Your camcorder returns to the standby mode.

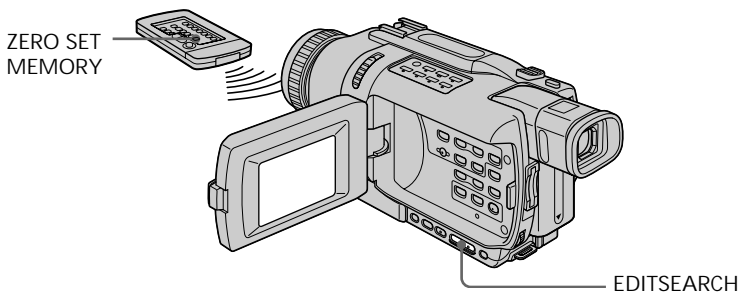

Notes

- The zero set memory function works only for tapes recorded in the Digital8 B system.
- The picture and the sound may be distorted at the end of the inserted section when it is played back.

If a tape has a blank portion between recorded portions
The zero set memory function may not work correctly.

Playing back tapes with picture effects

During playback, you can process a scene using the following picture effect functions: NEG.ART, SEPIA, B&W and SOLARIZE.

- (1) In the playback or playback pause mode, press MENU to display the menu settings.
- (2) Turn the SEL/PUSH EXEC dial to select P EFFECT in , then press the dial.
- (3) Turn the SEL/PUSH EXEC dial to select the desired picture effect mode, then press the dial.

For details of each picture effect function, see page 47.

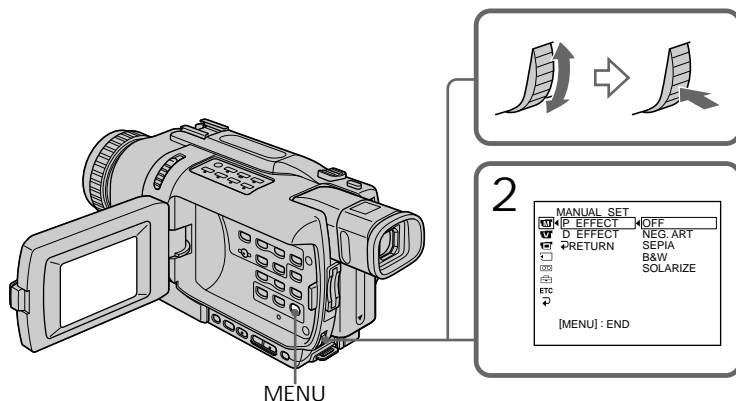

To cancel the picture effect
Set P EFFECT to OFF in the menu settings.

Notes

- Picture effect functions work only for tapes recorded in the Digital8  system.
- You cannot process externally input scenes using the picture effect functions.
- You cannot record pictures on a tape on your camcorder when you have processed the picture using the picture effect function. However, you can record pictures on a “Memory Stick” (except DCR-TRV240) (p. 135, 142), or on a VCR using your camcorder as a player.

Pictures processed by picture effect functions

Pictures processed by picture effect functions are not output through the  DV IN/OUT jack.

When you set the POWER switch to OFF (CHG) or stop playing back
The picture effect function is automatically canceled.

Playing back tapes with digital effects

During playback, you can process a scene using the following digital effect functions: STILL, FLASH, LUMI. and TRAIL.

- (1) In the playback mode, press MENU to display the menu settings.
- (2) Turn SEL/PUSH EXEC dial to select D EFFECT in , then press the dial.
- (3) Turn SEL/PUSH EXEC dial to select the desired digital effect mode, then press the dial.

The bars appear on the screen.

In the STILL or LUMI. mode, the picture is captured and is stored in memory as a still image at the time you press the SEL/PUSH EXEC dial.

- (4) Turn the SEL/PUSH EXEC dial to adjust the effect.

For details of each digital effect function, see page 48.

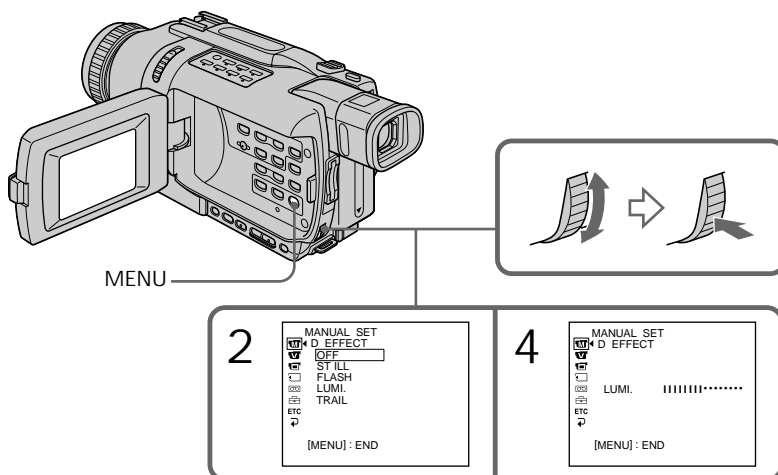

To cancel the digital effect
Set D EFFECT to OFF in the menu settings.

Notes

- Digital effect functions work only for tapes recorded in the Digital8  system.
- You cannot process externally input scenes using digital effect functions.
- You cannot record images on a tape on your camcorder when you have processed the image using digital effect functions. However, you can record images on a "Memory Stick" (except DCR-TRV240) (p. 135, 142), or on a VCR using your camcorder as a player.

Pictures processed by digital effect functions

Pictures processed by digital effect functions are not output through the  DV IN/OUT jack.

When you set the POWER switch to OFF (CHG) or stop playing back
The digital effect function is automatically canceled.

Enlarging recorded images – Tape PB ZOOM

You can enlarge moving and still images recorded on tapes.

Besides the operation described here, your camcorder can enlarge still images recorded on "Memory Stick"s (except DCR-TRV240) (p. 166).

- (1) In the playback or playback pause mode, press PB ZOOM. The image is enlarged, and $\uparrow\downarrow$ indicators which showing the direction to move the image appear on the screen.
- (2) Turn SEL/PUSH EXEC dial to move the enlarged image, then press the dial.
 - \uparrow : The image moves downwards.
 - \downarrow : The image moves upwards.
- (3) Turn SEL/PUSH EXEC dial to move the enlarged image, then press the dial.
 - \leftarrow : The image moves rightward (Turn the dial downwards.)
 - \rightarrow : The image moves leftward (Turn the dial upwards.)
- (4) Except DCR-TRV240:

Adjust the zoom ratio by the power zoom lever.

You can enlarge the image from 1.1 times up to five times its size.

W : Decreases the zoom ratio.

T : Increase the zoom ratio.

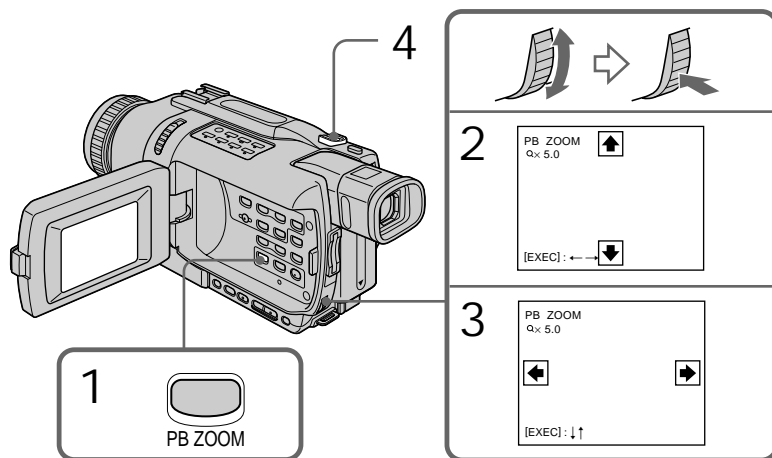

To cancel the PB ZOOM function
Press PB ZOOM to turn off the indicator.

Enlarging recorded images – Tape PB ZOOM

Notes

- The PB ZOOM function works only for tapes recorded in the Digital8  system.
- You cannot process externally input scenes using the PB ZOOM function.
- You cannot record images on a tape on your camcorder when you have processed the image using the PB ZOOM function. However, you can record images on a “Memory Stick” (except DCR-TRV240) (p. 135), or on a VCR using your camcorder as a player.

Images in the PB ZOOM function

Images in the PB ZOOM function are not output through the  DV IN/OUT jack.

PB ZOOM function is automatically canceled when:

- The POWER switch is set to OFF (CHG)
- You stop playing back
- You press MENU
- You press TITLE
- You insert a “Memory Stick” (except DCR-TRV240)

To record an image processed by Tape PB ZOOM on “Memory Stick”s (except DCR-TRV240)

Press PHOTO to record the image processed by Tape PB ZOOM.

Quickly locating a scene – ZERO SET MEMORY

Your camcorder goes forward or backward to automatically stop at a desired scene having a tape counter value of “0:00:00”.

Use the Remote Commander for this operation.

Use this function, for example, to view a desired scene later on during playback.

- (1) In the playback mode, press DISPLAY.
- (2) Press ZERO SET MEMORY at the point you want to locate later. The tape counter shows “0:00:00” and the ZERO SET MEMORY indicator flashes on the screen.
- (3) Press ■ when you want to stop playback.
- (4) Press ◀◀ to rewind the tape to the counter’s zero point. The tape stops automatically when the counter reaches approximately zero. The ZERO SET MEMORY indicator disappears, and the time code appears.
- (5) Press ▶▶. Playback starts from the counter’s zero point.

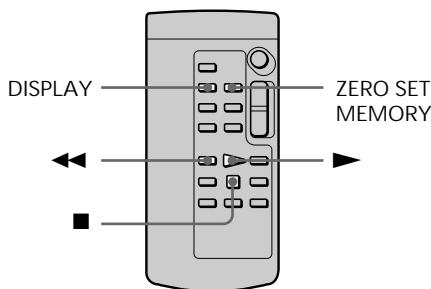

Notes

- The zero set memory function works only for tapes recorded in the Digital8  system.
- When you press ZERO SET MEMORY before rewinding the tape, the zero set memory function is canceled.
- There may be a discrepancy of several seconds from the time code.

If a tape has a blank portion between recorded portions

The zero set memory function may not work correctly.

Searching a recording by date - DATE SEARCH

You can automatically search for the point where the recording date changes and start playback from that point (date search).

Use the Remote Commander for this operation.

Use this function to check where recording dates change or to edit the tape at each recording date.

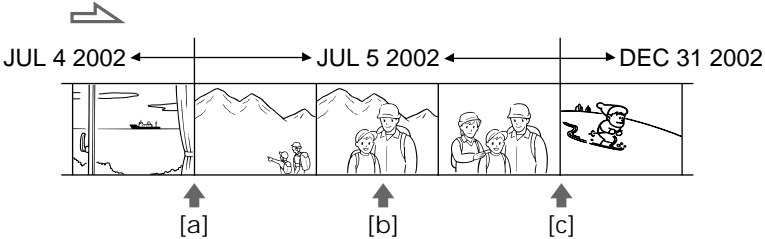

- (1) Set the POWER switch to VCR.
- (2) Press SEARCH MODE on the Remote Commander repeatedly until the DATE SEARCH indicator appears on the screen. The indicator changes as follows:
DATE SEARCH → PHOTO SEARCH → PHOTO SCAN → (no indicator)
- (3) When the current position is [b], press ◀◀ to search towards [a] or press ▶▶ to search towards [c]. Your camcorder automatically starts playback at the point where the date changes. Each time you press ◀◀ or ▶▶ your camcorder searches for the previous or next date.

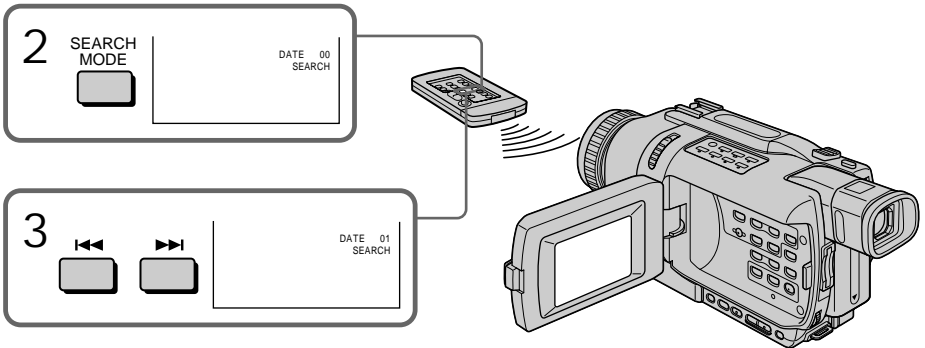

To stop searching
Press ■.

Notes

- The date search function works only for tapes recorded in the Digital8  system.
- If one day's recording is less than two minutes, your camcorder may not accurately find the point where the recording date changes.

If a tape has a blank portion between recorded portions
The date search function may not work correctly.

Searching for a photo

- PHOTO SEARCH/PHOTO SCAN

You can search for the recorded still image recorded on tape (photo search).
You can also search for still images one after another and display each image for five seconds automatically (photo scan).
Use the Remote Commander for these operations.

Searching for a photo

- (1) Set the POWER switch to VCR.
- (2) Press SEARCH MODE on the Remote Commander repeatedly until the photo search indicator appears on the screen. The indicator changes as follows:
DATE SEARCH → PHOTO SEARCH → PHOTO SCAN → (no indicator)
- (3) Press ◀◀ or ▶▶ to select the photo for playback. Each time you press ◀◀ or ▶▶ your camcorder searches for the previous or next photo. Your camcorder automatically starts playback from the photo.

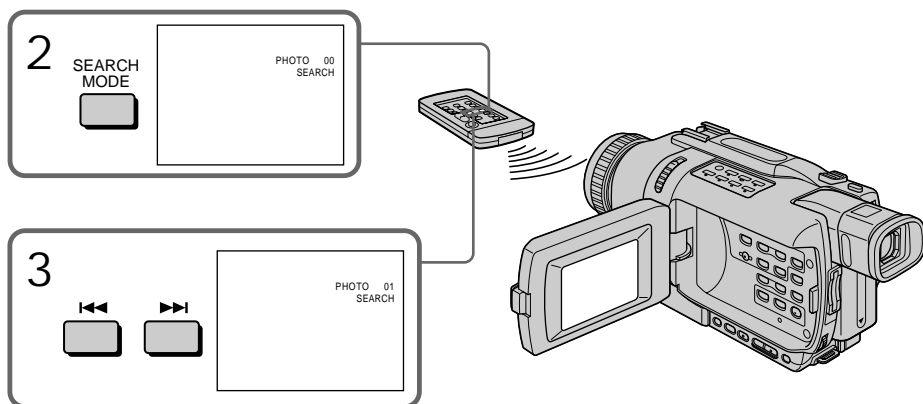

To stop searching
Press ■.

Scanning photo

- (1) Set the POWER switch to VCR.
 - (2) Press SEARCH MODE on the Remote Commander repeatedly until the photo scan indicator appears on the screen.
The indicator changes as follows:
DATE SEARCH → PHOTO SEARCH → PHOTO SCAN → (no indicator)
 - (3) Press ◀◀ or ▶▶.
- Each photo is played back for about five seconds automatically.

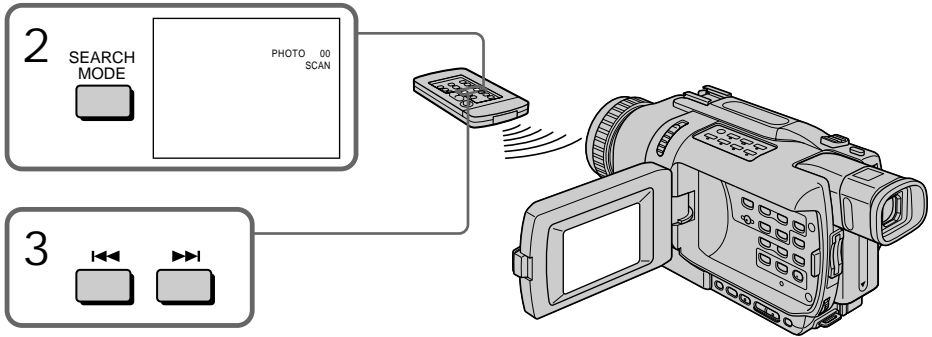

To stop scanning

Press ■.

Note

The photo search and photo scan functions work only for tapes recorded in the Digital8  system.

If a tape has a blank portion between recorded portions
The photo search/photo scan function may not work correctly.

Dubbing a tape

Using the A/V connecting cable

You can dub or edit on the VCR connected to your camcorder using your camcorder as a player.

Connect your camcorder to the VCR using the A/V connecting cable supplied with your camcorder.

Before operation

- Set DISPLAY to LCD in the menu settings. (The default setting is LCD.)
- Press the following buttons to make the indicators disappear so that they will not be superimposed on the edited tape:
 - DISPLAY
 - DATA CODE on the Remote Commander
 - SEARCH MODE on the Remote Commander

- (1) Insert a blank tape (or a tape you want to record over) into the VCR, and insert the recorded tape into your camcorder.
 - (2) Prepare the VCR for recording, then set the input selector to LINE. Connect the A/V connecting cable to the AUDIO/VIDEO jack. Refer to the operating instructions of your VCR.
 - (3) Set the POWER switch to VCR on your camcorder.
 - (4) Play back the recorded tape on your camcorder.
 - (5) Start recording on the VCR.
- Refer to the operating instructions of your VCR.

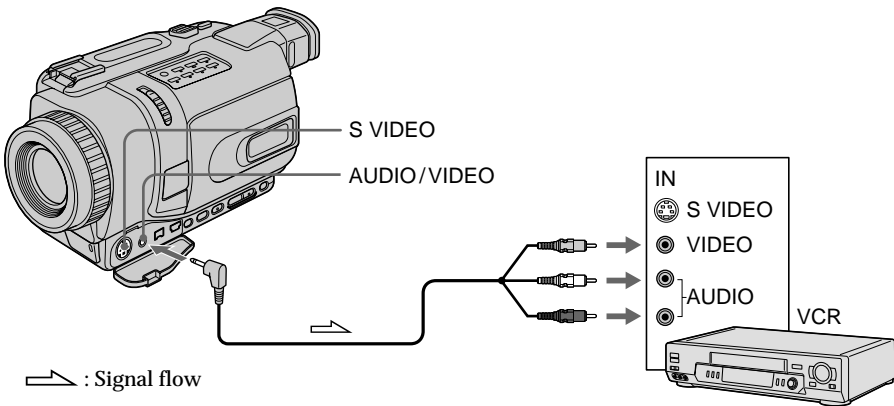

When you have finished dubbing a tape

Press **■** on both your camcorder and the VCR.

You can edit on VCRs that support the following systems:

8 8 mm, **Hi8** Hi8, **VHS** VHS, **S-VHS** S-VHS, **VHS-C** VHS-C, **S-VHS-C** S-VHS-C, **B** Betamax, **ED Beta** ED Betamax, ^{Mini}**DV** mini DV, **DV** DV or **D** Digital8

Dubbing a tape

If your VCR is a monaural type

Connect the yellow plug of the A/V connecting cable to the video input jack and the white or the red plug to the audio input jack on the VCR or the TV. When the white plug is connected, the left channel audio is output, and when the red plug is connected, the right channel audio is output.

If your VCR has an S video jack

Pictures can be reproduced more faithfully by using an S video cable (optional). With this connection, you do not need to connect the yellow (video) plug of the A/V connecting cable.

Connect an S video cable (optional) to the S video jacks of both your camcorder and the VCR.

Using the i.LINK cable (DV connecting cable)

Simply connect the i.LINK cable (DV connecting cable) (optional) to  DV IN/OUT on your camcorder and to DV IN/OUT on the DV products. With a digital-to-digital connection, video and audio signals are transmitted in digital form for high-quality editing. You cannot dub the screen indicators.

- (1) Insert a blank tape (or a tape you want to record over) into the VCR, and insert the recorded tape into your camcorder.
 - (2) Set the input selector on the VCR to DV IN if it is available. Refer to the operating instructions of your VCR.
 - (3) Set the POWER switch to VCR on your camcorder.
 - (4) Play back the recorded tape on your camcorder.
 - (5) Start recording on the VCR.
- Refer to the operating instructions of your VCR.

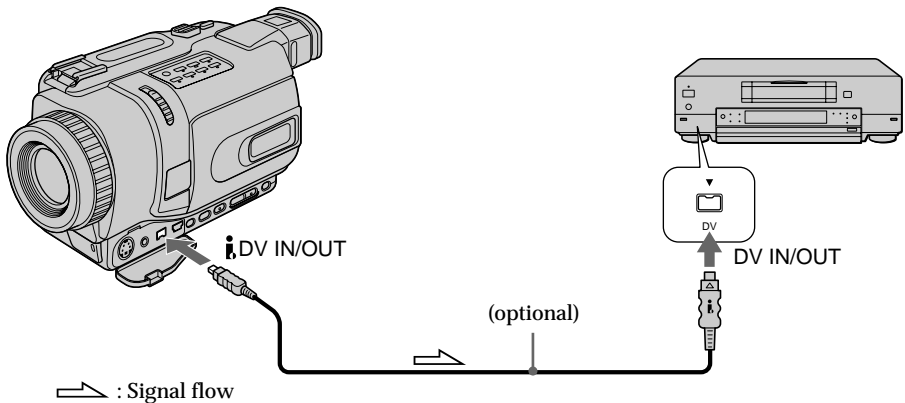

When you have finished dubbing a tape
Press  on both your camcorder and the VCR.

Dubbing a tape

Note on tapes that are not recorded in the Digital8  system
The picture may fluctuate. This is not a malfunction.

During playback of tapes recorded in the Hi8/standard 8 system
Digital signals are output as the image signals from the  DV IN/OUT jack.

You can connect one VCR only using the i.LINK cable (DV connecting cable)
See page 191 for more information about i.LINK.

Pictures processed by picture effects, digital effects or the PB ZOOM function
Pictures processed by picture effects, digital effects or the PB ZOOM function are not
output through the  DV IN/OUT jack.

If you record playback pause picture with the  DV IN/OUT jack
The recorded picture becomes rough. Also, when you play back the picture using other
video equipment, the picture may jitter.

Dubbing only desired scenes

- Digital program editing (on tapes)

You can duplicate selected scenes (programs) for editing onto a tape without operating the VCR.

Scenes can be selected by frame. You can set up to 20 programs.

Your camcorder can dub on "Memory Stick"s (except DCR-TRV240). See page 146 for more information.

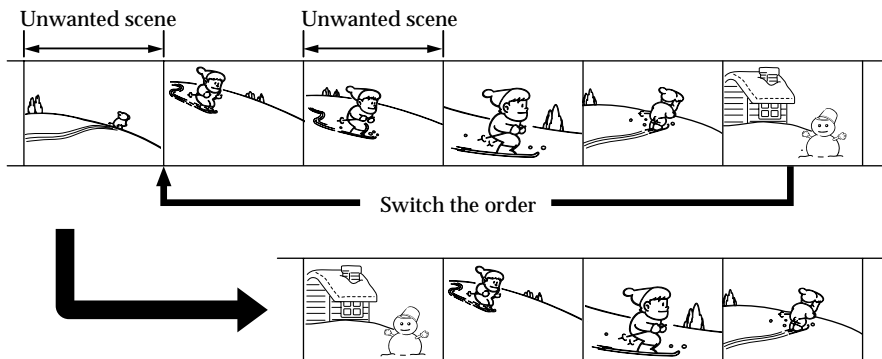

Before operating the Digital program editing function on tapes recorded other equipment

Step 1 Connecting the VCR (p. 75).

Step 2 Setting the VCR for operation (p. 75, 80).

Step 3 Adjusting the synchronization of the VCR (p. 82).



When you dub using the same VCR again, you can skip steps 2 and 3.

Using the Digital program editing function on tapes recorded other equipment

Operation 1 Making a program (p. 84).

Operation 2 Performing the program (dubbing a tape) (p. 87).

Notes

- The Digital program editing works only for tapes recorded in the Digital8  system.
- When you connect with an i.LINK cable (DV connecting cable), you may not be able to operate the dubbing function correctly, depending on the VCR. Set CONTROL to IR in the menu settings of your camcorder.
- When editing digital video, the operation signals cannot be sent with LANC .

Step 1: Connecting the VCR

You can connect both an A/V connecting cable and an i.LINK cable (DV connecting cable).

When you use the A/V connecting cable, connect the devices as illustrated in page 71.

When you use an i.LINK cable (DV connecting cable), connect the devices as illustrated on page 72.

If you connect using an i.LINK cable (DV connecting cable)

With a digital-to-digital connection, video and audio signals are transmitted in digital format for high-quality editing.

Step 2: Setting the VCR to operate with the A/V connecting cable

To edit using the VCR, send the control signal by infrared rays to the remote sensor on the VCR.

When you connect using an A/V connecting cable, follow the procedure below, steps (1) to (4), to send the control signal correctly.

(1) Set the IR SETUP code

① Set the POWER switch to VCR on your camcorder.

② Turn the power of the connected VCR on, then set the input selector to LINE.

When you connect a video camera recorder, set its power switch to VCR/VTR.

③ Press MENU to display the menu settings.

④ Turn the SEL/PUSH EXEC dial to select $\overline{\text{ETC}}$, then press the dial.

⑤ For DCR-TRV240:

Turn the SEL/PUSH EXEC dial to select VIDEO EDIT, then press the dial.

For DCR-TRV340/TRV740/TRV840:

Turn the SEL/PUSH EXEC dial to select TAPE in VIDEO EDIT, then press the dial.

⑥ Turn the SEL/PUSH EXEC dial to select EDIT SET, then press the dial.

⑦ Turn the SEL/PUSH EXEC dial to select CONTROL, then press the dial.

⑧ Turn the SEL/PUSH EXEC dial to select IR, then press the dial.

⑨ Turn the SEL/PUSH EXEC dial to select IR SETUP.

⑩ Turn the SEL/PUSH EXEC dial to select IR SETUP code number of your VCR, then press the dial.

Check the code in “About IR SETUP codes.” (p. 77)

Dubbing only desired scenes – Digital program editing (on tapes)

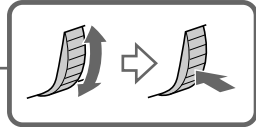
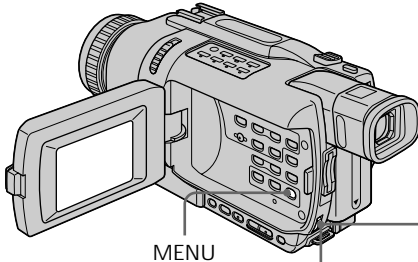

5 For DCR-TRV240:

```

OTHERS
DATA CODE
BEEP
COMMANDER
DISPLAY
VIDEO EDIT READY
INDICATOR
RETURN
[MENU]: END
    
```



```

VIDEO_EDIT 0:08:55:06
MARK 1 IN
UNDO
ERASE ALL
START
EDIT SET
TOTAL 0:00:00:00
SCENE 0
[MENU]: END
    
```

6

```

VIDEO_EDIT 0:08:55:06
MARK
UNDO
ERASE ALL
START
EDIT SET IR
TOTAL 0:00:00:00
SCENE 0
[MENU]: END
    
```

For DCR-TRV340/TRV740/TRV840:

```

OTHERS
DATA CODE
BEEP
COMMANDER
DISPLAY
VIDEO EDIT RETURN
INDICATOR TAPE
RETURN MEMORY
[MENU]: END
    
```



```

VIDEO_EDIT 0:08:55:06
MARK 1 IN
UNDO
ERASE ALL
START
EDIT SET
TOTAL 0:00:00:00
SCENE 0
[MENU]: END
    
```

7

```

VIDEO_EDIT 0:08:55:06
EDIT SET
CONTROL MIR
ADJ TEST I.LINK
"CUT-IN"
"CUT-OUT"
IR SETUP
PAUSEMODE
IR TEST
RETURN
[MENU]: END
    
```

10

```

VIDEO_EDIT 0:08:55:06
EDIT SET
CONTROL
ADJ TEST
"CUT-IN"
"CUT-OUT"
IR SETUP 3
PAUSEMODE
IR TEST
RETURN
[MENU]: END
    
```

Dubbing only desired scenes – Digital program editing (on tapes)

About IR SETUP codes

The IR SETUP code is stored in the memory of your camcorder. Be sure to set the correct code to match your VCR. The default setting is code number 3.

Brand	IR SETUP code
Sony	1, 2, 3, 4, 5, 6
Admiral (M. Wards)	89
Aiwa	47, 54, 80
Akai	49, 51
Audio Dynamic	21, 35
Bell&Howell (M. Wards)	36
Broksonic	21, 70, 82
Canon	77, 78
Citizen	47
Craig	47, 73
Curtis Mathis	8, 77, 80
Daewoo	26, 40, 77
DBX	21, 33, 35
Dimensia	8
Emerson	26, 48, 59, 70, 80, 81, 82
Fisher	36, 37, 44, 45
Funai	80
General Electric	8, 32*, 77, 94*, 101
Goldstar/LG	47
GO VIDEO	71
Hitachi	8, 42, 78
HQ	40
Instant Replay	77, 78
JC Penny	8, 21, 33, 35, 36, 42, 77
JVC	12, 13, 14, 21, 33, 35
Kenwood	21, 33, 35, 47
LXI (Sears)	36, 37, 42, 44, 45, 47, 49, 80
Magnavox	17, 77, 78, 83
Marantz	21, 33, 35
Marta	47
Memorex	37, 77
Minolta	8, 42

Brand	IR SETUP code
Mitsubishi/MGA	22, 23, 24, 28, 29
Multitech	23, 32, 80
NEC	21, 33, 35
Olympic	77, 78
Optimus	22
Orion	60
Panasonic	16, 17, 77, 78
Pentax	8, 42
Philco	26, 70, 77, 78
Philips	47, 77, 78, 83
Pioneer	78
Quasar	6, 16, 17, 77, 78
RCA/PROSCAN	7, 8, 16, 40, 41, 42, 77, 78, 78*, 83, 101
Realistic	22, 36, 37, 77, 80, 88
Sansui	21
Singer	73
Samsung	24, 24*, 32, 32*, 41, 94, 94*
Sanyo	26, 36, 37, 47
Scott	22, 23, 24, 28, 32, 37, 40, 41
Sharp	88, 89
Shintom	73
Signature 2000	80, 89
Sylvania	77, 78, 80, 83
Symphonic	80
Tashiro	47
Tatung	21, 33, 35
Teac	21, 33, 35, 80
Technics	77, 78
Toshiba	7, 40, 49
Wards	37, 47, 88, 89, 95
Yamaha	21, 33, 35, 36
Zenith	95

* TV/VCR component

Note on IR SETUP codes

Digital program editing is not possible if the VCR does not support IR SETUP codes.

Dubbing only desired scenes – Digital program editing (on tapes)

- (2) Setting the modes to cancel the recording pause on the VCR
 - ① Turn the SEL/PUSH EXEC dial to select PAUSEMODE, then press the dial.
 - ② Turn the SEL/PUSH EXEC dial to select the mode to cancel recording pause on the VCR, then press the dial.

Refer to the operating instructions of your VCR.

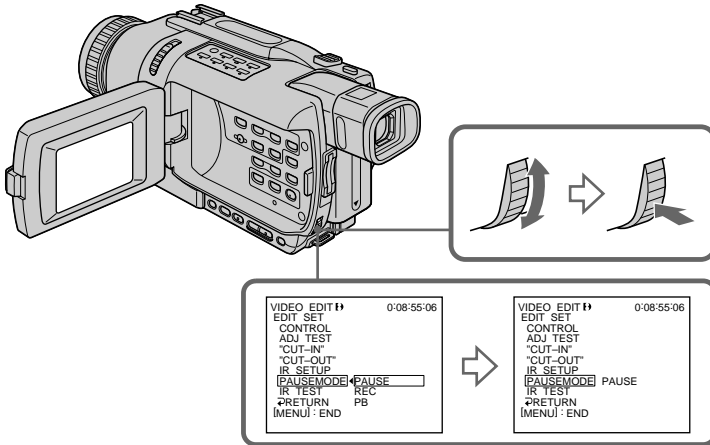

Buttons to cancel recording pause on the VCR

The buttons vary depending on your VCR. To cancel recording pause:

- Select PAUSE if the button to cancel recording pause is **II**.
- Select REC if the button to cancel recording pause is **●**.
- Select PB if the button to cancel recording pause is **▶**.

- (3) Setting your camcorder and the VCR to face each other
Locate the infrared rays emitter of your camcorder and face it towards the remote sensor of the VCR.

Set the devices about 30 cm (12 in.) apart, and remove any obstacles between the devices.

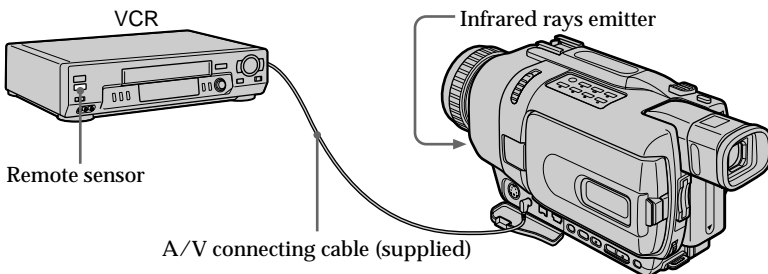

Dubbing only desired scenes – Digital program editing (on tapes)

(4) Confirming VCR operation

- ① Insert a recordable tape into the VCR, then set to recording pause.
- ② Turn the SEL/PUSH EXEC dial to select IR TEST, then press the dial.
- ③ Turn the SEL/PUSH EXEC dial to select EXECUTE, then press the dial.

If the VCR starts recording, the setting is correct.

When recording is finished, the indicator changes to COMPLETE.

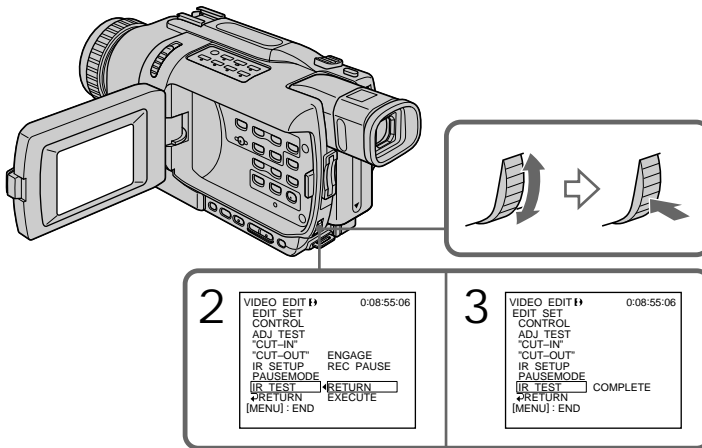

When the VCR does not operate correctly

- After checking the code in “About IR SETUP codes”, set the IR SETUP or the PAUSEMODE again.
- Place your camcorder at least 30 cm (12 in.) away from the VCR.
- Refer to the operating instructions of your VCR.

Step 2: Setting the VCR to operate with the i.LINK cable
(DV connecting cable)

When you connect using i.LINK cable (DV connecting cable) (optional), follow the procedure below.

- (1) Set the POWER switch to VCR on your camcorder.
- (2) Turn the power of the connected VCR on, then set the input selector to DV input. When you connect a digital video camera recorder, set its power switch to VCR/VTR.
- (3) Press MENU to display the menu settings.
- (4) Turn the SEL/PUSH EXEC dial to select $\overline{\text{ETC}}$, then press the dial.
- (5) For DCR-TRV240:
Turn the SEL/PUSH EXEC dial to select VIDEO EDIT, then press the dial.
For DCR-TRV340/TRV740/TRV840:
Turn the SEL/PUSH EXEC dial to select TAPE in VIDEO EDIT, then press the dial.
- (6) Turn the SEL/PUSH EXEC dial to select EDIT SET, then press the dial.
- (7) Turn the SEL/PUSH EXEC dial to select CONTROL, then press the dial.
- (8) Turn the SEL/PUSH EXEC dial to select i.LINK, then press the dial.

Dubbing only desired scenes – Digital program editing (on tapes)

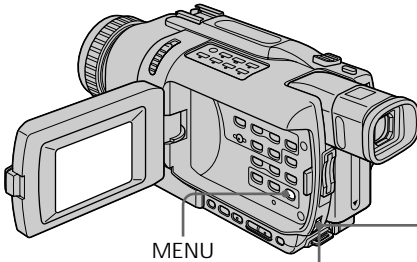

MENU

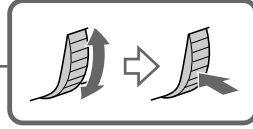

5 For DCR-TRV240:

```

OTHERS
DATA CODE
BEEP
COMMANDER
DISPLAY
VIDEO EDIT READY
INDICATOR
RETURN
[MENU]: END
    
```



```

VIDEO EDIT 0:08:55:06
[MARK] 1 IN
UNDO
ERASE ALL
START
EDIT SET
TOTAL 0:00:00:00
SCENE 0
[MENU]: END
    
```

6

```

VIDEO EDIT 0:08:55:06
MARK
UNDO
ERASE ALL
START
EDIT SET IR
TOTAL 0:00:00:00
SCENE 0
[MENU]: END
    
```

For DCR-TRV340/TRV740/TRV840:

```

OTHERS
DATA CODE
BEEP
COMMANDER
DISPLAY
VIDEO EDIT RETURN
INDICATOR TAPE MEMORY
RETURN
[MENU]: END
    
```



```

VIDEO EDIT 0:08:55:06
[MARK] 1 IN
UNDO
ERASE ALL
START
EDIT SET
TOTAL 0:00:00:00
SCENE 0
[MENU]: END
    
```

7

```

VIDEO EDIT 0:08:55:06
EDIT SET
CONTROL IR
ADJ TEST I.LINK
"CUT-IN"
"CUT-OUT"
IR SETUP
PAUSEMODE
IR TEST
RETURN
[MENU]: END
    
```

8

```

VIDEO EDIT 0:08:55:06
EDIT SET
CONTROL I.LINK
ADJ TEST
"CUT-IN"
"CUT-OUT"
IR SETUP
PAUSEMODE
IR TEST
RETURN
[MENU]: END
    
```

When you connect using an i.LINK cable (DV connecting cable)
You cannot dub the titles and display indicators.

Step 3: Adjusting the synchronization of the VCR

You can adjust the synchronization of your camcorder and the VCR. Have a pen and paper ready for notes. Before operation, eject the cassette from your camcorder if inserted.

- (1) Set the POWER switch to VCR on your camcorder.
- (2) Insert a blank tape (or a tape you want to record over) into the VCR, then set to recording pause.
When you select i.LINK in CONTROL, you do not need to set to recording pause.
- (3) Turn the SEL/PUSH EXEC dial to select ADJ TEST, then press the dial.
- (4) Turn the SEL/PUSH EXEC dial to select EXECUTE, then press the dial.
IN and OUT are recorded on an image for five times each to calculate the number values for adjusting the synchronization.
The EXECUTING indicator flashes on the screen.
When finished, the indicator changes to COMPLETE.
- (5) Rewind the tape in the VCR, then start slow playback.
Take a note of the first number value of each IN and the last number value of each OUT.
- (6) Calculate the average of all the first number values of each IN, and the average of all the last number values of each OUT.
- (7) Turn the SEL/PUSH EXEC dial to select "CUT-IN", then press the dial.
- (8) Turn the SEL/PUSH EXEC dial to select the average number value of IN, then press the dial.
The calculated start position for recording is set.
- (9) Turn the SEL/PUSH EXEC dial to select "CUT-OUT", then press the dial.
- (10) Turn the SEL/PUSH EXEC dial to select the average number value of OUT, then press the dial.
The calculated stop position for recording is set.
- (11) Turn the SEL/PUSH EXEC dial to select ↩ RETURN, then press the dial.

Dubbing only desired scenes – Digital program editing (on tapes)

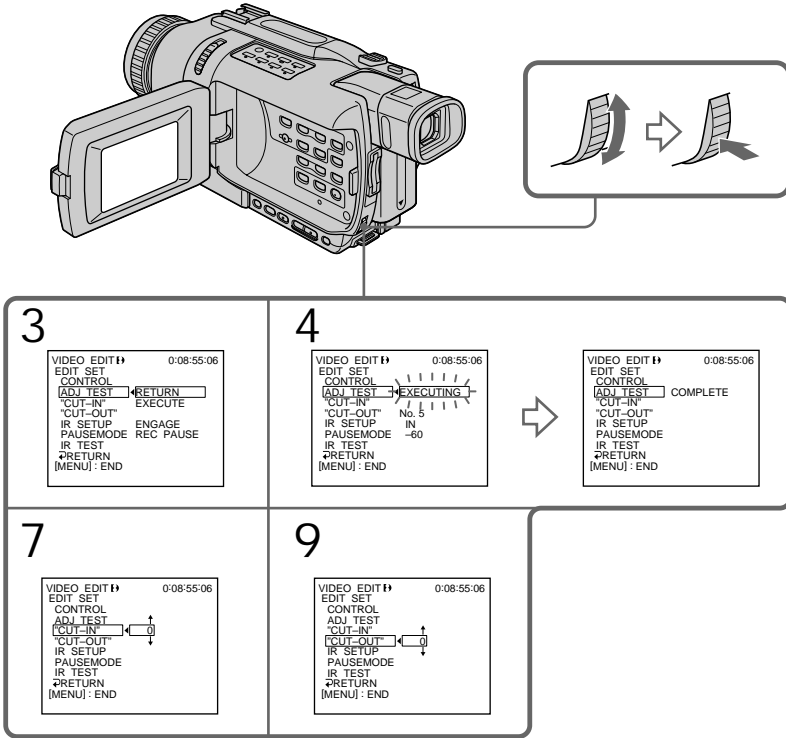

Editing

Notes

- When you complete step 3, the image used to adjust synchronization is recorded for about 50 seconds.
- If you start recording from the very beginning of the tape, the first few seconds of the tape may not record properly. Be sure to allow about 10 seconds' lead before starting recording.
- When you connect with an i.LINK cable (DV connecting cable) you may not be able to operate the dubbing function correctly, depending on the VCR. Keep the i.LINK connection, and set CONTROL to IR in the menu settings. Video and audio signals are transmitted in digital format.

Operation 1: Making a program

- (1) Insert the tape for playback into your camcorder, and insert a tape for recording into the VCR.
- (2) Press MENU to display the menu settings.
- (3) Turn the SEL/PUSH EXEC dial to select **ETC**, then press the dial.
- (4) For DCR-TRV240:
Turn the SEL/PUSH EXEC dial to select VIDEO EDIT, then press the dial.
For DCR-TRV340/TRV740/TRV840:
Turn the SEL/PUSH EXEC dial to select TAPE in VIDEO EDIT, then press the dial.
- (5) Search for the beginning of the first scene you want to insert using the video operation buttons, then pause playback.
You can fine-adjust one frame at a time with EDITSEARCH.
- (6) Press the SEL/PUSH EXEC dial.
The IN point of the first program is set, and the top part of the program mark changes to light blue.
- (7) Search for the end of the first scene you want to insert using the video operation buttons, then pause playback.
- (8) Press the SEL/PUSH EXEC dial.
The OUT point of the first program is set, then the bottom part of the program mark changes to light blue.
- (9) Repeat steps 5 to 8, then set the program.
When the program is set, the program mark changes to light blue.
You can set up to 20 programs.

Dubbing only desired scenes – Digital program editing (on tapes)

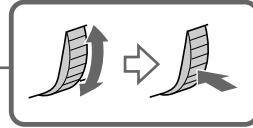
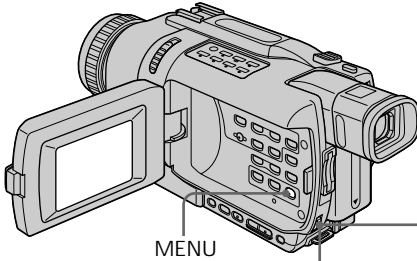

4 For DCR-TRV240:

```

OTHERS
DATA CODE
BEEP
COMMANDER
DISPLAY
VIDEO EDIT READY
INDICATOR
RETURN
[MENU] : END
    
```



```

VIDEO EDIT 0:08:55:06
L MARK 1 IN
UNDO
ERASE ALL
START
EDIT SET
TOTAL 0:00:00:00
SCENE 0
[MENU] : END
    
```

5

```

VIDEO EDIT 0:08:55:06
L MARK 1 IN
UNDO
ERASE ALL
START
EDIT SET
TOTAL 0:00:00:00
SCENE 0
[MENU] : END
    
```

For DCR-TRV340/TRV740/TRV840:

```

OTHERS
DATA CODE
BEEP
COMMANDER
DISPLAY
VIDEO EDIT RETURN
INDICATOR (TAPE)
RETURN MEMORY
[MENU] : END
    
```



```

VIDEO EDIT 0:08:55:06
L MARK 1 IN
UNDO
ERASE ALL
START
EDIT SET
TOTAL 0:00:00:00
SCENE 0
[MENU] : END
    
```

6

```

VIDEO EDIT 0:08:55:06
L MARK 1 OUT
UNDO
ERASE ALL
START
EDIT SET
TOTAL 0:00:00:00
SCENE 0
[MENU] : END
    
```

8

```

VIDEO_EDIT 0:09:07:06
L MARK 2 IN
UNDO
ERASE ALL
START
EDIT SET
TOTAL 0:00:12:00
SCENE 1
[MENU] : END
    
```

9

```

VIDEO_EDIT 0:10:01:23
L MARK 4 IN
UNDO
ERASE ALL
START
EDIT SET
TOTAL 0:00:47:12
SCENE 3
[MENU] : END
    
```

Erasing the program you have set

Erase OUT first and then IN from of the last program.

- (1) Turn the SEL/PUSH EXEC dial to select UNDO, then press the dial.
- (2) Turn the SEL/PUSH EXEC dial to select EXECUTE, then press the dial.
The last set program mark flashes, then the setting is canceled.

To cancel erasing

Select RETURN in step 2.

Erasing all programs

- (1) For DCR-TRV240:

Turn the SEL/PUSH EXEC dial to select VIDEO EDIT, then press the dial.

For DCR-TRV340/TRV740/TRV840:

Select VIDEO EDIT in the menu settings. Turn the SEL/PUSH EXEC dial to select TAPE, then press the dial.

- (2) Select ERASE ALL in the menu settings. Turn the SEL/PUSH EXEC dial to select EXECUTE, then press the dial.
All the program marks flash, then the settings are canceled.

To cancel erasing all programs

Select RETURN in step 2.

To cancel a program you have set

Press MENU.

The program is stored in memory until the tape is ejected.

Notes

- Digital program editing does not work when PB MODE is set to **Hi 8/8** in the menu settings.
- You cannot operate recording during Digital program editing.

You cannot set IN or OUT to the following portions of the tape:

- A blank portion of the tape
- A portion recorded in a system other than Digital8 **8**

The total time code may not be displayed correctly in the following cases:

- The tape is not recorded in the Digital8 **8** system.
- There is a blank portion between IN and OUT on the tape.

Operation 2: Performing the program (Dubbing a tape)

Make sure that your camcorder and VCR are connected, and that the VCR is set to recording pause. When you use an i.LINK cable (DV connecting cable), the following procedure is not necessary.

When you use a digital video camera recorder, set its power switch to VCR/VTR.

(1) For DCR-TRV240:

Turn the SEL/PUSH EXEC dial to select VIDEO EDIT, then press the dial.

For DCR-TRV340/TRV740/TRV840:

Select VIDEO EDIT in the menu settings. Turn the SEL/PUSH EXEC dial to select TAPE, then press the dial.

(2) Select START in the menu settings. Turn the SEL/PUSH EXEC dial to select EXECUTE, then press the dial.

Search for the beginning of the first program, then start dubbing.

The program mark flashes.

The SEARCH indicator appears during search, and the EDITING indicator appears during edit on the screen.

The program mark changes to light blue after dubbing ends.

When dubbing ends, your camcorder and the VCR automatically stop.

To stop dubbing during editing

Press ■ on your camcorder.

To end the Digital program editing function

Your camcorder stops when the dubbing ends. Then the display returns to VIDEO EDIT in the menu settings.

Press MENU to end the Digital program editing function.

You cannot record on the VCR when:

- The cassette has run out of tape.
- The write-protect tab on the cassette is set to lock.
- The IR SETUP code is not correct (when IR is selected).
- The button to cancel recording pause is not correct (when IR is selected).

NOT READY appears on the LCD screen when:

- The program to operate Digital program editing has not been made.
- i.LINK is selected but an i.LINK cable (DV connecting cable) is not connected.
- The power of the connected VCR is not turned on (when you set i.LINK).

Capturing images from an analog video unit on your computer – Signal convert function

You can capture images and sound from an analog video unit connected to your computer which has the i.LINK (DV) jack connected to your camcorder.

Before operation

Set DISPLAY to LCD in the menu settings. (The default setting is LCD.)

- (1) Set the POWER switch to VCR.
- (2) Press MENU to display the menu settings.
- (3) Turn the SEL/PUSH EXEC dial to set A/V → DV OUT in  to ON. (p. 105)
- (4) Start playback on the analog video unit.
- (5) Start procedures for capturing images and sound on your computer.

The operation procedures depend on your computer and the software you are using.

For details on how to capture images, refer to the operating instructions of your computer and the software you are using.

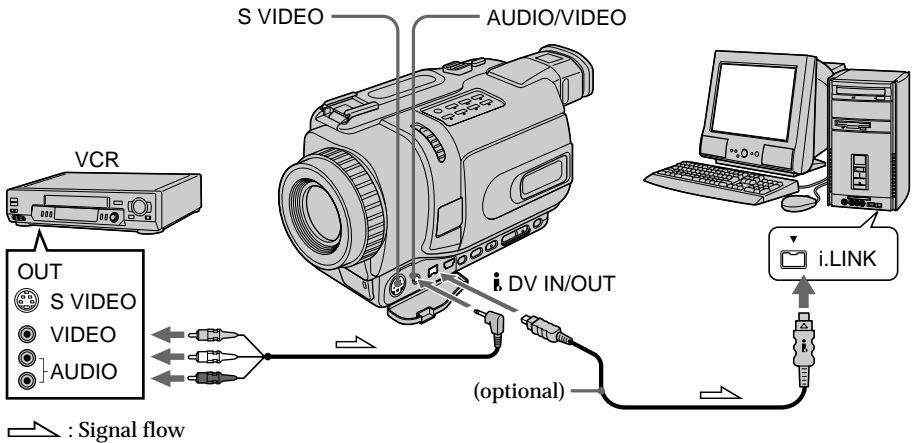

After capturing images and sound

Stop capturing procedures on your computer, and stop the playback on the analog video unit.

Notes

- You need to install software that supports the exchange video signals.
- Depending on the state of the analog video signals, your computer may not be able to output the images correctly when you convert analog video signals into digital video signals via your camcorder. Depending on the analog video unit, the image may contain noise or incorrect colors.
- You cannot record or capture video output via your camcorder when the video tapes include copyright protection signals such as the ID-2 system.
- You can capture images and sound with an S video cable (optional) instead of the A/V connecting cable (supplied).

If your computer has a USB jack

You can connect your camcorder to your computer using the USB cable supplied with your camcorder. Note, however, that the image may flicker.

Recording video or TV programs

Using the A/V connecting cable

You can record a tape from another VCR or a TV program from a TV that has video/audio outputs. Use your camcorder as a recorder.

Before operation

Set DISPLAY to LCD in the menu settings. (The default setting is LCD.)

- (1) Insert a blank tape (or a tape you want to record over) into your camcorder. If you are recording a tape from the VCR, insert a recorded tape into the VCR.
- (2) Set the POWER switch to VCR on your camcorder.
- (3) Press ● REC and the button on its right simultaneously on your camcorder, then immediately press ■ on your camcorder.
- (4) Press ► on the VCR to start playback if you are recording a tape from VCR. Select a TV program if you are recording from TV.
The picture from a TV or VCR appears on the screen of your camcorder.
- (5) Press ■ on your camcorder at the scene where you want to start recording from.

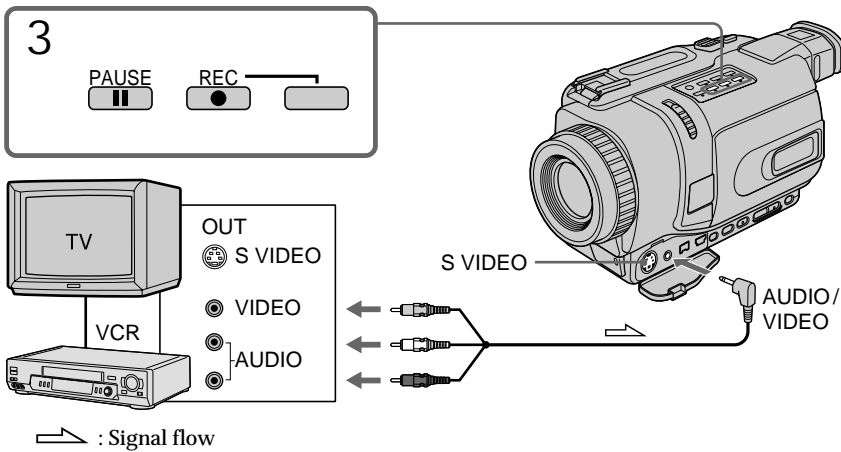

When you have finished dubbing a tape
Press ■ on both your camcorder and the VCR.

Recording video or TV programs

Notes

- To enable smooth transition, we recommend that you do not mix pictures recorded in the Hi8/standard 8 with the Digital8  system on a tape.
- If you fast-forward or slow-playback on the other equipment, the image being recorded may fluctuate. When recording from other equipment, be sure to play back the original tape at normal speed.

If your VCR is a monaural type

Connect the yellow plug of the A/V connecting cable to the video output jack and the white or the red plug to the audio output jack on the VCR or the TV. When the white plug is connected, the left channel audio is output, and when the red plug is connected, the right channel audio is output.

If your TV or VCR has an S video jack

Pictures can be reproduced more faithfully by using an S video cable (optional).

With this connection, you do not need to connect the yellow (video) plug of the A/V connecting cable.

Connect an S video cable (optional) to the S video jacks of both your camcorder and the TV or VCR.

Using the i.LINK cable (DV connecting cable)

Simply connect the i.LINK cable (DV connecting cable) (optional) to **i** DV IN/OUT of your camcorder and to DV OUT of the DV products. With a digital-to-digital connection, video and audio signals are transmitted in digital form for high-quality editing.

- (1) Insert a blank tape (or a tape you want to record over) into your camcorder, and insert the recorded tape into the VCR on your camcorder.
- (2) Set the POWER switch to VCR on your camcorder.
- (3) Press **●** REC and the button on its right simultaneously on your camcorder, then immediately press **■** on your camcorder.
- (4) Press **▶** on the VCR to start playback.
The picture to be recorded appears on the screen of your camcorder.
- (5) Press **■** on your camcorder at the scene where you want to start recording from.

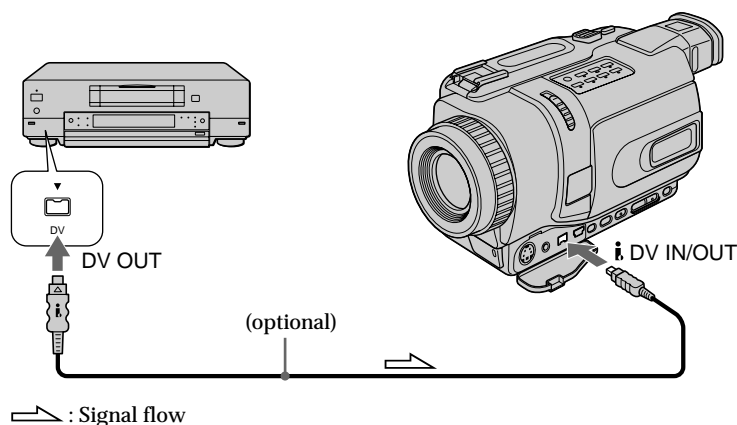

When you have finished dubbing a tape
Press **■** on both your camcorder and the VCR.

You can connect one VCR only using the i.LINK cable (DV connecting cable).

During digital editing

The color of the display may be uneven. However this does not affect the dubbed picture.

If you record playback pause picture with the **i** DV IN/OUT jack

The recorded picture becomes rough. When you play back the picture using your camcorder, the picture may jitter.

Before recording

Make sure that the DV IN indicator appears on the screen of your camcorder by pressing DISPLAY. The DV IN indicator may appear on both equipment.

Inserting a scene from a VCR - Insert Editing

You can insert a new scene from a VCR onto your originally recorded tape by specifying the insert start and end points.

Use the Remote Commander for this operation.

Connections are the same as on page 89, 91. Insert a cassette containing the desired scene to insert into the VCR.

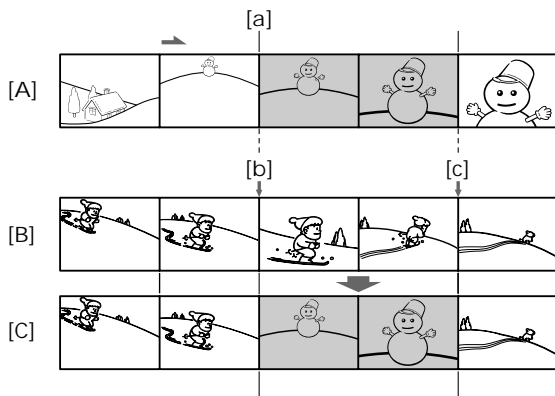

[A]: A tape that contains the scene to be superimposed

[B]: A tape before editing

[C]: A tape after editing

Inserting a scene from a VCR – Insert Editing

- (1) Set the POWER switch to VCR on your camcorder.
- (2) On the connected VCR, locate just before the insert start point [a], then press **II** to set the VCR to the playback pause mode.
- (3) On your camcorder, locate the insert end point [c] by pressing **◀◀** or **▶▶**. Then press **II** to set your camcorder to the playback pause mode.
- (4) Press ZERO SET MEMORY on the Remote Commander. The ZERO SET MEMORY indicator flashes and the end point of the insert is stored in memory. The tape counter shows “0:00:00.”
- (5) On your camcorder, locate the insert start point [b] by pressing **◀◀**, then press **● REC** and the button on its right simultaneously to set your camcorder to the recording pause mode.
- (6) First press **II** on the VCR, and after a few seconds press **II** on your camcorder to start inserting the new scene. Inserting automatically stops near the zero point on the counter. Your camcorder automatically stops. The end point [c] of the insert stored in memory is canceled.

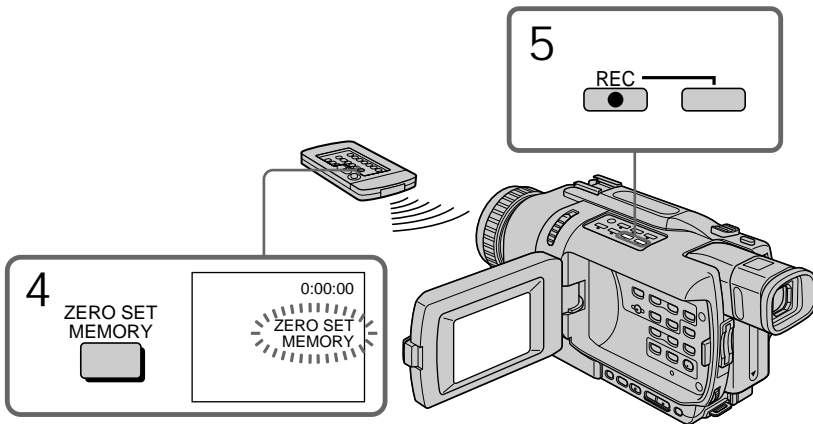

To change the insert end point

Press ZERO SET MEMORY again after step 5 to make the ZERO SET MEMORY indicator disappear and begin from step 3.

Notes

- The zero set memory function works only for tapes recorded in the Digital8 **D** system.
- Pictures and sound recorded on the section between the insert start and end points will be erased when you insert the new scene.

When the inserted picture is played back

Pictures may be distorted at the end of the inserted section. This is not a malfunction.

To insert a scene without setting the insert end point

Skip step 3 and 4. Press **■** when you want to stop inserting.

Viewing images recorded on a tape on your computer (Windows users only)

If you connect your camcorder and your computer using the USB cable, you can view pictures live from your camcorder and pictures recorded on a tape on your computer (USB Streaming function).

Furthermore, if you capture images recorded on a tape from your camcorder to your computer, you can process or edit them in image processing software and append them to e-mail.

Connecting with USB cable and viewing images on your computer

- Installing the USB driver (p. 96)
- Installing “PIXELA ImageMixer Ver.1.0 for Sony” (p. 100)
- Capturing images with “PIXELA ImageMixer Ver.1.0 for Sony” (p. 101)

Recommended computer environment

OS:

Microsoft Windows 98SE, Windows Me, Windows 2000 Professional, Windows XP Home Edition or Windows XP Professional (standard installation)

However, operation is not assured if the above environment is an upgraded OS.

If you are using Windows 98, you cannot capture sounds.

CPU:

Minimum 500 MHz Intel Pentium III or faster (800 MHz or faster recommended)

Application:

DirectX 8.0a or later

Sound system:

16 bit stereo sound card and speakers

Memory:

64 MB or more

Hard disk:

Minimum 200 MB available hard disk space for installation

1 GB hard disk space or more recommended for working area (depending on the file size of editing images)

Display:

4 MB VRAM video card, Minimum 800 × 600 dot Hi color (16 bit color, 65,000 colors), Direct Draw display driver capability (At 800 × 600 dot or less, 256 colors and less, this product will not operate correctly.)

Others:

This product is compatible with DirectX technology, so it is necessary to install DirectX.

The USB connector is provided as standard.

You cannot use this function in the Macintosh environment.

Viewing images recorded on a tape on your computer (Windows users only)

Notes

- Operations are not guaranteed for either the Windows or Macintosh environment if you connect two or more USB equipment to a single computer at the same time, or when using a hub.
- Some equipment may not operate depending on the type of USB equipment that is used simultaneously.
- Operations are not guaranteed for all the recommended computer environments mentioned above.

Windows and Windows Media are trademarks or registered trademarks of Microsoft Corporation in the United States and/or other countries.

All other product names mentioned herein may be the trademarks or registered trademarks of their respective companies. Furthermore, “™” and “®” are not mentioned in each case in this manual.

Installing the USB driver

Before connecting your camcorder to your computer, install the USB driver on the computer. The USB driver is packaged together with application software for viewing images on the CD-ROM supplied with your camcorder.

Start the following operation without connecting the USB cable to your computer.

Connect the USB cable in step 8.

If the USB driver has been registered incorrectly because your computer was connected to your camcorder before installation of the USB driver was complete, reinstall the USB driver following the procedure on page 97.

For Windows 98SE, Windows Me, Windows 2000 Professional, Windows XP users
If you are using Windows 2000 Professional or Windows XP, log in with permission of administrator.

- (1) Turn on your computer and allow Windows to load.
- (2) Insert the supplied CD-ROM into the CD-ROM drive of your computer. The application software screen appears.
- (3) Move the cursor to “USB Driver” and click. This starts USB driver installation.



- (4) Follow the on-screen messages to install the USB driver.
- (5) Connect the AC power adaptor to your camcorder and then to a wall outlet.
- (6) Set the POWER switch to CAMERA or VCR.
- (7) Select USB STREAM to ON in  in the menu settings (p. 105).
- (8) With the CD-ROM inserted, connect the USB jack on your camcorder to the USB connector on your computer using the supplied USB cable.
Your computer recognizes the camcorder, and the Windows Add Hardware Wizard starts.

Viewing images recorded on a tape on your computer (Windows users only)

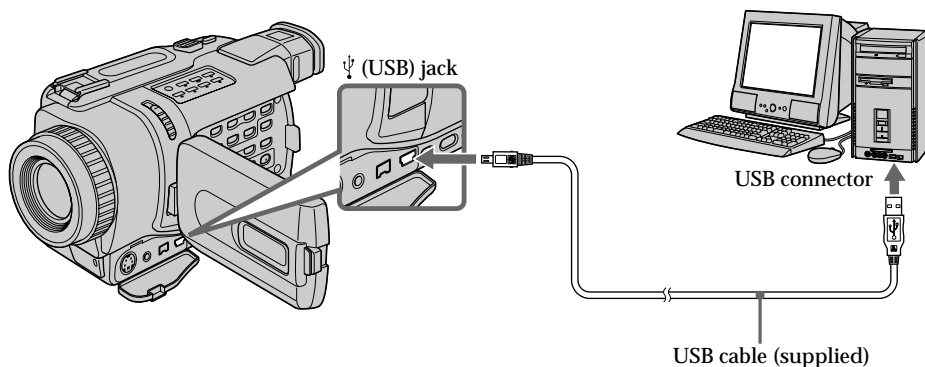

- (9) Follow the on-screen messages so that the Add Hardware Wizard recognizes that the USB drivers have been installed. The Add Hardware Wizard starts three times because three different USB drivers are installed. Be sure to allow the installation to complete without interrupting it.

If the “Files Needed” screen appears (For Windows 2000 Professional/Windows XP users)

- (10) Insert the supplied CD-ROM into the CD-ROM drive of your computer, then select “Browse...” → “My Computer” → “ImageMixer” → “sonyhcb.sys”, and click the “OK” button.

When the installation is complete, go to “Installing ‘PIXELA ImageMixer Ver.1.0 for Sony’” on page 100.

If you cannot install the USB driver

The USB driver has been registered incorrectly as your computer was connected to your camcorder before installation of the USB driver was completed. Perform the following procedure to correctly install the USB driver.

Step 1: Uninstall the incorrect USB driver

- ① Turn on your computer and allow Windows to load.
- ② Connect the USB connector on your computer to the USB jack on your camcorder using the USB cable supplied with your camcorder.
- ③ Connect the AC power adaptor, and set the POWER switch to CAMERA or VCR.

Viewing images recorded on a tape on your computer (Windows users only)

④ Open your computer's "Device Manager".

For Windows XP:

Select "Start" → "Control Panel" → "System" → "Hardware" tab, and click the "Device Manager" button.

If there is no "System" inside "Pick a Category" after clicking "Control Panel", click "Switch to Classic View" instead.

For Windows 2000 Professional:

Select "My Computer" → "Control Panel" → "System" → "Hardware" tab, and click the "Device Manager" button.

For Windows 98SE/Windows Me:

Select "My Computer" → "Control Panel" → "System", and click the "Device Manager" button.

⑤ Select and delete the underlined devices below.

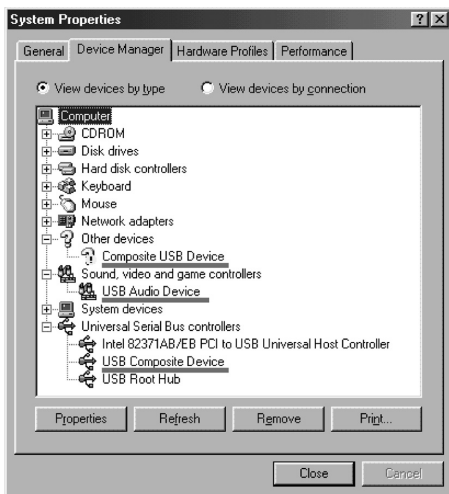

Windows 98SE

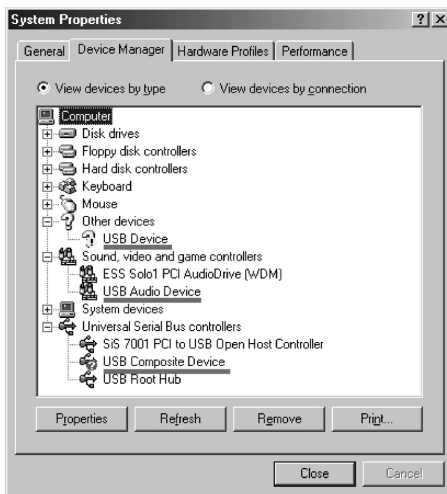

Windows Me

Viewing images recorded on a tape on your computer (Windows users only)

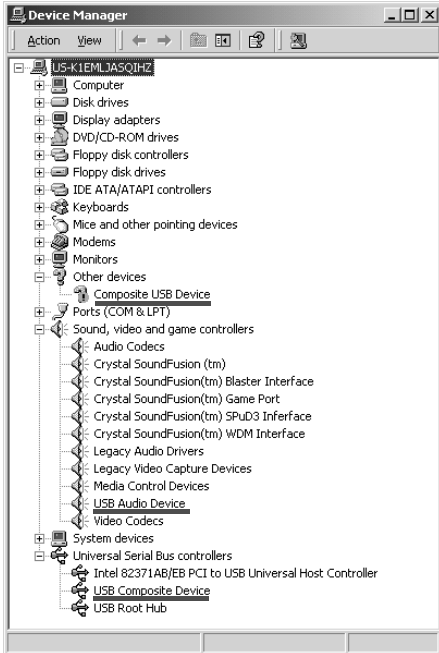

Windows 2000 Professional

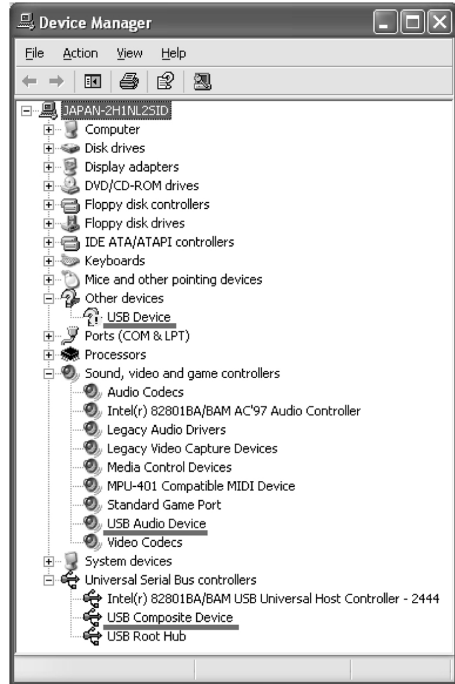

Windows XP

- ⑥ Set the POWER switch to OFF (CHG) on your camcorder, and then disconnect the USB cable.
- ⑦ Restart your computer.

Step 2: Install the USB driver on the CD-ROM

Perform the entire procedure described in "Installing the USB driver" on page 96.

Installing "PIXELA ImageMixer Ver.1.0 for Sony"

Install "PIXELA ImageMixer Ver.1.0 for Sony" on your computer. "PIXELA ImageMixer Ver.1.0 for Sony" is packaged on the CD-ROM supplied with your camcorder. "PIXELA ImageMixer Ver.1.0 for Sony" allows you to easily view images on your camcorder on your computer for your enjoyment.

To install and use this software in Windows 2000 Professional, you must be authorized as a Power User or Administrator. For Windows XP, you must be authorized as an Administrator.

- (1) Turn on your computer and allow Windows to load.
If you are using your computer, close all running applications.
- (2) Insert the supplied CD-ROM into the CD-ROM drive of your computer.
The application software screen appears. If the application software screen does not appear, double-click "My Computer" and then "ImageMixer" (CD-ROM Drive). The application software screen appears after a while.



- (3) Move the cursor to "PIXELA ImageMixer" and click.
The language selection dialog box appears.
- (4) Select the language for installation.
- (5) Follow the on-screen messages.

Follow the directions on the screen to install DirectX. DirectX 8.0 will be installed.

Viewing images recorded on a tape on your computer (Windows users only)

Capturing images with "PIXELA ImageMixer Ver.1.0 for Sony"

To use this software in Windows 2000 Professional, you must be authorized as a Power User or Administrator. For Windows XP, you must be authorized as an Administrator.

Viewing images

Viewing images recorded on a tape

- (1) Turn on your computer and allow Windows to load.
- (2) Connect one end of the USB cable to the ψ (USB) jack on your camcorder and the other end to the USB connector on your computer.

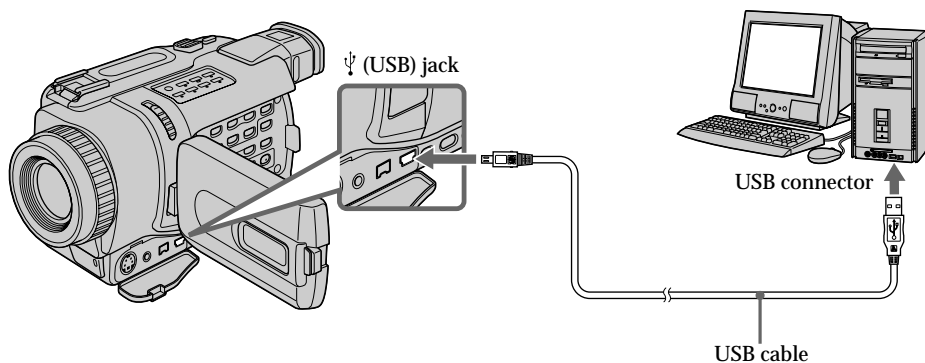

- (3) Connect the AC power adaptor to your camcorder and then to a wall outlet, and insert a cassette into your camcorder.
- (4) Set the POWER switch to VCR.
Select USB STREAM to ON in  in the menu settings (p. 105).
- (5) Select "Start" → "Program" → "PIXELA" → "ImageMixer" → "ImageMixer Ver.1.0 for Sony" on Windows.

Viewing images recorded on a tape on your computer (Windows users only)

- (6) Click  on the screen.



The “PIXELA ImageMixer Ver.1.0 for Sony” startup screen appears on your computer.

- (7) Click .

Preview window

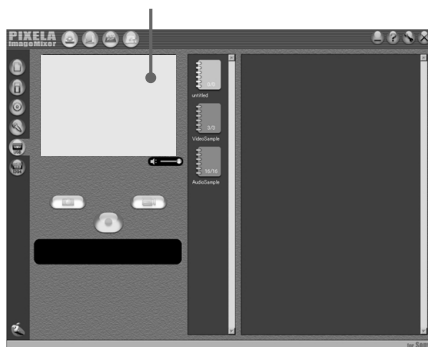

- (8) Start playback on your camcorder.
The image from the tape appears in the preview window.

Viewing images recorded on a tape on your computer (Windows users only)

Viewing images live from your camcorder

- (1) Follow the steps (1), (2) on page 101, then connect the AC power adaptor to your camcorder and then to a wall outlet.
- (2) Set the POWER switch to CAMERA.
Select USB STREAM to ON in  in the menu settings (p. 105).
- (3) Follow the steps (5) to (7) on page 101, 102.

The image from your camcorder appears live in the preview window.



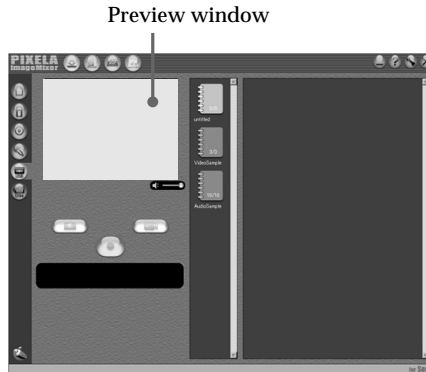

Capturing images



Capturing still images

- (1) Click .
- (2) Click  at the point to capture using the preview window. The captured image appears on the thumbnail list window.

Capturing moving pictures

- (1) Click .
- (2) Click  at the start point to capture using the preview window.
The  changes to . Then click  at the stop point to capture. The captured image appears on the thumbnail list window.

Viewing images recorded on a tape on your computer (Windows users only)

Notes

- When you view images on your computer with the USB connection, the following may occur. This is not a malfunction:
 - The image may fluctuate
 - The image may contain noise, etc.
 - The image does not appear properly if the TV color system used for the image signal differs to the system used on your camcorder.
- When your camcorder is in the standby mode with a cassette inserted, it turns off automatically after three minutes.
- We recommend setting DEMO MODE to OFF in the menu settings when your camcorder is in the standby mode, and no cassette is inserted.
- Indicators in the camcorder LCD screen do not appear on images that are captured into your computer.

If image data cannot be transferred by the USB connection

The USB driver has been registered incorrectly as your computer was connected to your camcorder before installation of the USB driver was completed. Reinstall the USB driver following the procedure on page 97.

If any trouble occurs

Close all running applications, then restart it.

Carry out the following operations after quitting the application:

- Disconnect the USB cable
- Change the POWER switch setting or set it to OFF (CHG)

Seeing the on-line help (operating instructions) of "PIXELA ImageMixer Ver.1.0 for Sony"

"PIXELA ImageMixer Ver.1.0 for Sony" is provided with on-line help (operating instructions).

- (1) Click  button located in the upper-right corner of the screen.
The "ImageMixer's Manual" screen appears.
- (2) You can access the desired topics from the contents.

To close on-line help

Click  located in the upper-right corner of the "ImageMixer's Manual" screen.

If you have any questions about "PIXELA ImageMixer Ver.1.0 for Sony" "ImageMixer Ver.1.0 for Sony" is a trademark of PIXELA corporation. Refer to the information web site at: "<http://www.imagemixer.com>".

Notes on using your computer

Communications with your computer

Communications between your camcorder and your computer may not recover after recovering from Suspend, Resume, or Sleep.

Changing the menu settings

To change the mode settings in the menu settings, select the menu items with the SEL/PUSH EXEC dial. The default settings can be partially changed. First, select the icon, then the menu item and then the mode.

- (1) In CAMERA, VCR or MEMORY (except DCR-TRV240) mode, press MENU to display the menu settings.
- (2) Turn the SEL/PUSH EXEC dial to select the desired icon, then press the dial to set.
- (3) Turn the SEL/PUSH EXEC dial to select the desired item, then press the dial to set.
- (4) Turn the SEL/PUSH EXEC dial to select the desired mode, and press the dial to set.
- (5) If you want to change other items, select \leftarrow RETURN and press the dial, then repeat steps from 2 to 4.



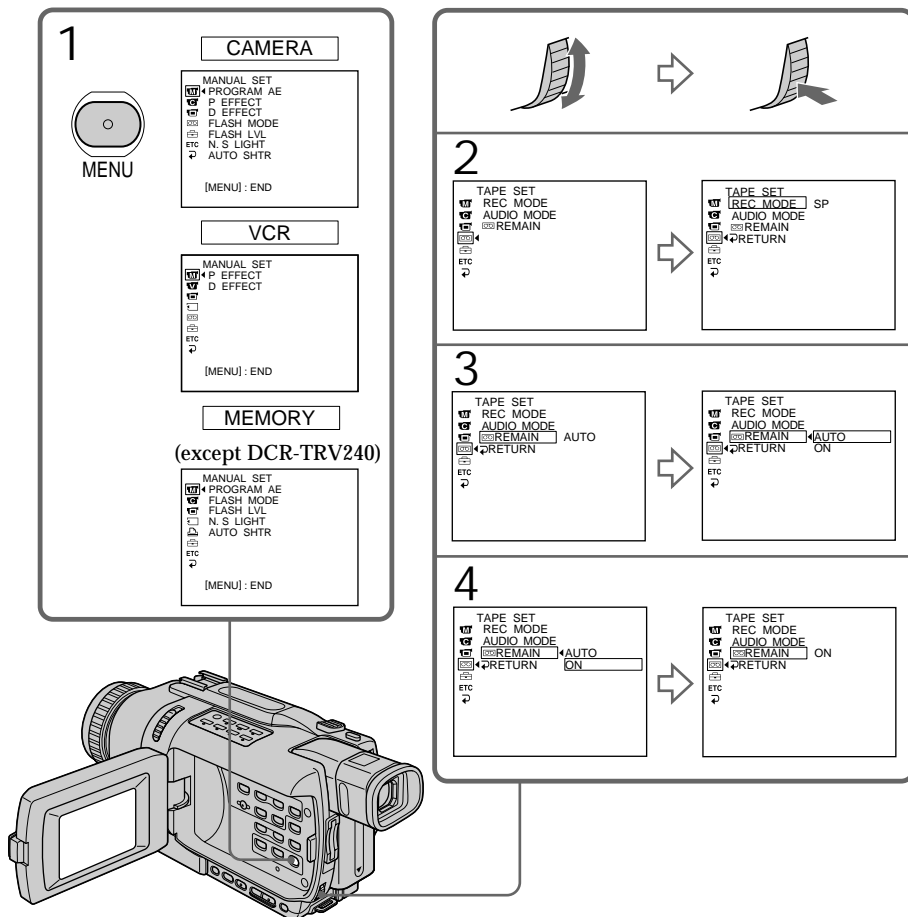





For details, see “Selecting the mode setting of each item” (p. 106).



Changing the menu settings

To make the menu display disappear
Press MENU.

Menu items are displayed as the following icons:

-  MANUAL SET
-  CAMERA SET
-  VCR SET
-  LCD/VF SET
-  MEMORY SET (except DCR-TRV240)
-  PRINT SET (except DCR-TRV240)
-  TAPE SET
-  SETUP MENU
-  OTHERS

Selecting the mode setting of each item ● is the default setting.

Menu items differ depending on the position of the POWER switch.
The screen shows only the items you can operate at the moment.

Icon/item	Mode	Meaning	POWER switch
 PROGRAM AE	—	To suit your specific shooting requirement (p. 51)	CAMERA MEMORY
P EFFECT	—	To add special effects like those in films or on the TV to images (p. 47, 63)	CAMERA VCR
D EFFECT	—	To add special effects using the various digital functions (p. 48, 64)	CAMERA VCR
FLASH MODE	● ON	To fire the flash (optional) regardless of the brightness of the surroundings	CAMERA MEMORY
	AUTO	The flash fires automatically.	
	AUTO ●	To fire the flash before recording to reduce the red-eye	
FLASH LVL	HIGH	Makes the flash level higher than normal.	CAMERA MEMORY
	● NORMAL	Normal setting	
	LOW	Makes the flash level lower than normal.	
N.S. LIGHT	● ON	To use the NightShot Light function (p. 29)	CAMERA MEMORY
	OFF	To cancel the NightShot Light function	
AUTO SHTR	● ON	To automatically activate the electronic shutter when shooting in bright conditions	CAMERA MEMORY
	OFF	To not automatically activate the electronic shutter even when shooting in bright conditions	

Notes on FLASH MODE and FLASH LVL

- You cannot adjust FLASH MODE or FLASH LVL if the flash (optional) is not compatible with FLASH MODE or FLASH LVL.
- FLASH MODE and FLASH LVL are displayed only when an external flash (optional) is connected to the intelligent accessory shoe.

Changing the menu settings

Icon/item	Mode	Meaning	POWER switch
 SELFTIMER*	● OFF	To not use the self-timer function	CAMERA MEMORY
	ON	To use the self-timer function	
D ZOOM (DCR-TRV240/ TRV340)	● OFF	To deactivate the digital zoom. Up to 25× zoom is performed.	CAMERA MEMORY
	50×	To activate the digital zoom. More than 25× to 50× zoom is performed digitally (p. 24).	
	700×	To activate the digital zoom. More than 25× to 700× zoom is performed digitally (p. 24).	
D ZOOM (DCR-TRV740/ TRV840)	● OFF	To deactivate the digital zoom. Up to 15× zoom is performed.	CAMERA
	30×	To activate the digital zoom. More than 15× to 30× zoom is performed digitally (p. 24).	
	420×	To activate the digital zoom. More than 15× to 420× zoom is performed digitally (p. 24).	
PHOTO REC*	● MEMORY	To record still images on "Memory Stick"s in CAMERA mode while you are in the standby mode or recording moving pictures to tape by pressing PHOTO (p. 124)	CAMERA
	TAPE	To record still images on tape in CAMERA mode while you are in the standby mode or recording moving pictures to tape by pressing PHOTO (p. 39)	
16:9WIDE	● OFF	—	CAMERA
	ON	To record a 16:9 wide picture (p. 42)	
STEADYSHOT	● ON	To compensate for camera-shake	CAMERA MEMORY**
	OFF	To cancel the SteadyShot function. Natural pictures are produced when shooting a stationary object with a tripod.	
FRAME REC	● OFF	To deactivate the frame recording	CAMERA
	ON	To activate the frame recording (p. 57)	
INT. REC	ON	To activate the interval recording function (p. 55)	CAMERA
	● OFF	To deactivate the interval recording function	
	SET	To set INTERVAL and REC TIME for interval recording	

* Except DCR-TRV240

** DCR-TRV340 only

Notes on the SteadyShot function





- The SteadyShot function will not correct excessive camera-shake.
- Attachment of a conversion lens (optional) may influence the SteadyShot function.

If you cancel the SteadyShot function

The SteadyShot off indicator  appears on the screen. Your camcorder prevents excessive compensation for camera-shake.

(continued on the following page)

Changing the menu settings

Icon/item	Mode	Meaning	POWER switch
 HIFI SOUND	<input checked="" type="radio"/> STEREO	To play back a stereo tape or dual sound track tape with main and sub sound (p. 188)	VCR
	1	To play back a stereo tape with the left sound or a dual sound track tape with main sound	
	2	To play back a stereo tape with the right sound or a dual sound track tape with sub sound	
TBC*	<input checked="" type="radio"/> ON	To correct jitter	VCR
	OFF	To not correct jitter. Set TBC to OFF when playing back a tape on which you have dubbed over and recorded the signal of a TV game or similar machine.	
TBC stands for "Time Base Corrector".			
DNR*	<input checked="" type="radio"/> ON	To reduce picture noise	VCR
	OFF	To reduce a conspicuous afterimage when the picture has a lot of movement	
DNR stands for "Digital Noise Reduction".			
AUDIO MIX	—	To adjust the balance between the stereo 1 and stereo 2	VCR
			
A/V → DV OUT	<input checked="" type="radio"/> OFF	To output digital images and sound in analog format using your camcorder	VCR
	ON	To output analog images and sound in digital format using your camcorder (p. 88)	
PB MODE	<input checked="" type="radio"/> AUTO	To automatically select the system (Hi8/standard 8 or Digital8 ) that was used to record on the tape, and play back the tape	VCR
	 	To play back a tape that was recorded in the Hi8/standard 8 system when your camcorder does not automatically distinguish the recording system	

* When you play back tapes recorded in the Hi8/standard 8 system only

Notes on AUDIO MIX



- When playing back a tape recorded in the 16-bit mode, you cannot adjust the balance.
- You can adjust the balance only for tapes recorded in the Digital8  system.

Note on PB MODE

The mode will return to the default setting when:

- you remove the battery pack or power source.
- you turn the POWER switch.

Changing the menu settings

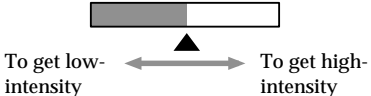
Icon/item	Mode	Meaning	POWER switch
 LCD BRIGHT	—	To adjust the brightness on the LCD screen with the SEL/PUSH EXEC dial.	CAMERA VCR MEMORY
			
LCD B. L.	● BRT NORMAL	To set the brightness on the LCD screen to normal	CAMERA VCR MEMORY
	BRIGHT	To brighten the LCD screen	
LCD COLOR	—	To adjust the color on the LCD screen, turning the SEL/PUSH EXEC dial to adjust the following bar	CAMERA VCR MEMORY
			
VF B.L.	● BRT NORMAL	To set the brightness on the viewfinder screen to normal	CAMERA VCR MEMORY
	BRIGHT	To brighten the viewfinder screen	



Notes on LCD B.L. and VF B.L.

- When you select BRIGHT, battery life is reduced by about 10 percent during recording.
- When you use power sources other than the battery pack, BRIGHT is automatically selected.

Even if you adjust LCD BRIGHT, LCD B.L., LCD COLOR and/or VF B.L.
The recorded picture will not be affected.

(continued on the following page)

Changing the menu settings

Icon/item	Mode	Meaning	POWER switch
¹⁾  STILL SET			
BURST (DCR-TRV740/ TRV840 only)	● OFF	To not record continuously	MEMORY
	NORMAL	To record continuously	
	EXP BRKTG	To record three images consecutively with different exposures	
	MULTI SCR N	To record nine images continuously, display the images on a single page divided into nine boxes.	
PIC MODE (DCR-TRV340 only)	● SINGLE	To not record continuously	MEMORY
	MULTI SCR N	To record nine images continuously, display the images on a single page divided into nine boxes.	
QUALITY	● ²⁾ SUPER FINE (DCR-TRV740/ TRV840 only)	To record still images in the finest image quality mode (p. 119)	VCR MEMORY
	● ²⁾ FINE	To record still images in the fine image quality mode (p. 119)	
	STANDARD	To record still images in the standard image quality mode	
FLD/F RAME (DCR-TRV340 only)	● FIELD	To record moving subjects correcting jitter (p. 124)	MEMORY
	F RAME	To record stopping subjects in high quality	
IMAGESIZE (DCR-TRV740 /TRV840 only)	● 1152 × 864	To record still images in 1152 × 864 size (p. 121)	VCR MEMORY
	640 × 480	To record still images in 640 × 480 size	
MOVIE SET			
IMAGESIZE	● 320 × 240	To record moving pictures at 320 × 240 size (p. 121)	VCR MEMORY
	160 × 112	To record moving pictures at 160 × 112 size	
 REMAIN	● AUTO	To display the remaining capacity of the "Memory Stick" in the following cases: <ul style="list-style-type: none"> • For five seconds after inserting a "Memory Stick" into your camcorder • When the capacity of the "Memory Stick" is less than one minute in MEMORY mode • For five seconds after completing a moving picture recording 	VCR MEMORY
	ON	To always display the remaining capacity of the "Memory Stick"	
PRINT MARK	ON	To write a print mark on recorded still images you want to print out later (p. 174)	VCR MEMORY
	● OFF	To cancel print marks on still images	

¹⁾ Except DCR-TRV240

²⁾ For DCR-TRV740/TRV840, the default setting is SUPER FINE.

Changing the menu settings

Icon/item	Mode	Meaning	POWER switch
*  PROTECT	ON	To protect selected images against accidental erasure (p. 170)	VCR MEMORY
	● OFF	To not protect images	
SLIDE SHOW	---	To play back images in a continuous loop (p. 168)	MEMORY
PHOTO SAVE	---	To copy still images on tape onto "Memory Stick" (p. 138)	VCR
FILE NO.	● SERIES	To assign numbers to file in sequence even if the "Memory Stick" is changed	VCR MEMORY
	RESET	To reset the file numbering each time the "Memory Stick" is changed	
DELETE ALL	● RETURN	To cancel deleting all images	MEMORY
	OK	To delete all unprotected images	
FORMAT	● RETURN	To cancel formatting	MEMORY
	OK	To format an inserted "Memory Stick" 1. Select FORMAT with the SEL/PUSH EXEC dial, then press the dial. 2. Select OK with the SEL/PUSH EXEC dial, then press the dial. 3. After EXECUTE appears, press the SEL/PUSH EXEC dial. FORMATTING flashes during formatting. COMPLETE appears when formatting is finished.	

Notes on formatting *

- Supplied "Memory Stick"s have been formatted at factory. Formatting "Memory Stick"s on your camcorder is not required.
- Do not do any of the following while FORMATTING is displayed:
 - Switch the POWER switch
 - Operate buttons
 - Remove the "Memory Stick"
- You cannot format the "Memory Stick" if the write-protect tab on the "Memory Stick" is set to LOCK.
- Format the "Memory Stick" when " FORMAT ERROR" is displayed.

Formatting erases all information on the "Memory Stick" *



Check the contents of the "Memory Stick" before formatting.

- Formatting erases sample images on the "Memory Stick."
- Formatting erases protected image data on the "Memory Stick."

* Except DCR-TRV240

(continued on the following page)

Changing the menu settings

Icon/item	Mode	Meaning	POWER switch
*  9PIC PRINT	● RETURN	To cancel prints of split screens	MEMORY
	SAME	To make prints of the same split screen (p. 176)	
	MULTI	To make prints of different split screens	
	MARKED	To make prints of images with print marks in recording order	
DATE/TIME	● OFF	To make prints without the recording date and time	MEMORY
	DATE	To make prints with the recording date	
	DAY&TIME	To make prints with the recording date and time (p. 176)	
 REC MODE	● SP	To record in the SP (Standard Play) mode	CAMERA VCR
	LP	To increase the recording time to 1.5 times the SP mode	
AUDIO MODE	● 12BIT	To record in the 12-bit mode (two stereo sounds)	CAMERA VCR**
	16BIT	To record in the 16-bit mode (one stereo sound with high quality)	
 REMAIN	● AUTO	To display the remaining tape bar: <ul style="list-style-type: none"> • For about eight seconds after your camcorder is turned on and calculates the remaining amount of tape • For about eight seconds after a cassette is inserted and your camcorder calculates the remaining amount of tape • For about eight seconds after ► is pressed in VCR mode • For about eight seconds after DISPLAY is pressed to display the screen indicators • For the period of tape rewinding, forwarding or picture search in VCR mode 	CAMERA VCR
	ON	To always display the remaining tape bar	

Note on PRINT SET *

9PIC PRINT and DATE/TIME are displayed only when an external printer (optional) is connected to the intelligent accessory shoe.

Notes on the LP mode

- When you record a tape in the LP mode on your camcorder, we recommend playing back the tape on your camcorder. When you play back the tape on other camcorders or VCRs, noise may occur in pictures or sound.
- When you record in the LP mode, we recommend using a Sony cassette so that you can get the most out of your camcorder.
- When you record in the SP and LP modes on one tape or you record some scenes in the LP mode, the playback picture may be distorted or the time code may not be written properly between scenes.

Note on AUDIO MODE

When playing back a tape recorded in the 16-bit mode, you cannot adjust the balance in AUDIO MIX.

* Except DCR-TRV240

** To dub a tape to another VCR

You cannot select AUDIO MODE for tapes recorded in the Digital8  system. You, however, can select AUDIO MODE when you dub tapes recorded in the Hi8/standard 8 system to another VCR using the i.LINK cable.

Changing the menu settings

Icon/item	Mode	Meaning	POWER switch
 CLOCK SET	—	To set the date or time (p. 18)	CAMERA MEMORY
USB STREAM	● OFF	To deactivate the USB Streaming function	CAMERA VCR
	ON	To activate the USB Streaming function	
USBCONNECT*	● NORMAL	To select normal USB connection	MEMORY
	PTP	To select USB connection supporting Picture Transfer Protocol (compatible with Windows XP)	
LTR SIZE	● NORMAL	To display selected menu items in normal size	CAMERA VCR MEMORY
	2×	To display selected menu items at twice the normal size	
LANGUAGE	● ENGLISH	To display the following information indicators in English: REC, STBY, min, CAPTURE, END SEARCH and VOL, etc.	CAMERA VCR MEMORY
	FRANÇAIS	To display the information indicators in French	
	ESPAÑOL	To display the information indicators in Spanish	
	PORTUGUÊS	To display the information indicators in Portuguese	
	中文	To display the information indicators in Chinese	
	한국어	To display the information indicators in Korean	
DEMO MODE	● ON	To make the demonstration appear	CAMERA
	OFF	To cancel the demonstration mode	

* DCR-TRV740/TRV840 only

Notes on DEMO MODE

- You cannot select DEMO MODE when a cassette is inserted in your camcorder.
- The DEMO MODE default setting is STBY (Standby), and the demonstration starts about 10 minutes after you have set the POWER switch to CAMERA without a cassette inserted.
To cancel the demonstration, insert a cassette, set the POWER switch to other than CAMERA, or set DEMO MODE to OFF. To set to STBY (Standby) again, leave the DEMO MODE at ON in the menu settings, turn the POWER switch to OFF (CHG), and return the POWER switch to CAMERA.
- When NIGHTSHOT is set to ON, the "NIGHTSHOT" indicator appears on the screen and you cannot select DEMO MODE in the menu settings.

(continued on the following page)

Changing the menu settings

Icon/item	Mode	Meaning	POWER switch
 DATA CODE	● DATE/CAM	To display date, time and recording data during playback	VCR MEMORY
	DATE	To display date and time during playback	
WORLD TIME	—	To set the clock to the local time Turn the SEL/PUSH EXEC dial to set a time difference. The clock changes by the time difference you set here. If you set the time difference to 0, the clock returns to the originally set time.	CAMERA MEMORY
BEEP	● MELODY	To output the melody when you start/stop recording or when an unusual condition occurs on your camcorder	CAMERA VCR MEMORY
	NORMAL	To output the beep instead of the melody	
	OFF	To cancel all sound including shutter sound	
COMMANDER	● ON	To activate the Remote Commander supplied with your camcorder	CAMERA VCR MEMORY
	OFF	To deactivate the Remote Commander to avoid erroneous remote control operation caused by other VCR's remote control	
DISPLAY	● LCD	To show the display on the LCD screen and in the viewfinder	CAMERA VCR MEMORY
	V-OUT/LCD	To show the display on the TV screen, LCD screen and in the viewfinder	

Note

If you press DISPLAY with DISPLAY set to V-OUT/LCD in the menu settings, the picture from a TV or VCR will not appear on the screen even when your camcorder is connected to outputs on the TV or VCR. (Except when your camcorder is connected with the i.LINK cable)

In more than five minutes after removing the power source
The AUDIO MIX, FLASH LVL, COMMANDER and HiFi SOUND settings are returned to their default settings.

Other menu settings are held in memory even when the battery is removed.

Changing the menu settings

Icon/item	Mode	Meaning	POWER switch
[ETC] REC LAMP	● ON	To light up the camera recording lamp at the front of your camcorder	CAMERA MEMORY
	OFF	To turn the camera recording lamp off so that the person is not aware of the recording	
VIDEO EDIT	● RETURN*	To cancel video editing	VCR
	TAPE*	To make a program and perform video editing (p. 74)	
	MEMORY*	To make a program and perform MPEG editing (p. 146)	
INDICATOR	● BL OFF	To turn off the backlight on display window	CAMERA VCR MEMORY
	BL ON	To turn on the backlight on display window	

* Except DCR-TRV240

When recording a close subject

When REC LAMP is set to ON, the red camera recording lamp on the front of the camcorder may reflect on the subject if it is close. In this case, we recommend that you set REC LAMP to OFF.

Notes on INDICATOR

- When you select BL ON, battery life is reduced by about 10 percent during recording.
- When you use power sources other than the battery pack, BL ON is automatically selected.

Using “Memory Stick” – Introduction

– Except DCR-TRV240

You can record and play back images on a “Memory Stick” supplied with your camcorder. You can easily play back, record or delete images. You can exchange image data with other equipment such as your computer etc., using the USB cable for “Memory Stick” supplied with your camcorder.

On file format

Still image (JPEG)

Your camcorder compresses image data in JPEG format (extension .jpg).

Moving picture (MPEG)

Your camcorder compresses picture data in MPEG format (extension .mpg).

Typical image data file name

Still image

100-0001: This file name appears on the screen of your camcorder.

Dsc00001.jpg: This file name appears on the display of your computer.

Moving picture

MOV00001: This file name appears on the screen of your camcorder.

Mov00001.mpg: This file name appears on the display of your computer.

Using a “Memory Stick”

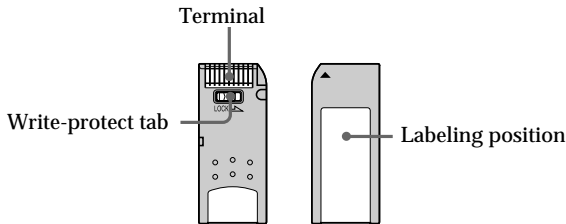

- You cannot record or erase images when the write-protect tab on the “Memory Stick” is set to LOCK.
- The position and shape of the write-protect tab may be different depending on the model.
- We recommend backing up important data on the hard disk of your computer.
- Image data may be damaged in the following cases:
 - If you remove the “Memory Stick” or turn the power off during reading or writing.
 - If you use “Memory Stick”s near static electricity or magnetic fields.
- Prevent metallic objects or your finger from coming into contact with the metal parts of the terminal.
- Stick the label at the labeling position.
- Do not bend, drop or apply strong shock to “Memory Stick”s.
- Do not disassemble or modify “Memory Stick”s.
- Do not let “Memory Stick”s become wet.
- Do not use or keep “Memory Stick”s in locations that are:
 - Extremely hot such as in a car parked in the sun or under the scorching sun
 - Under direct sunlight
 - Very humid or subject to corrosive gases
- When you carry or store a “Memory Stick,” put it in its case.

“Memory Stick” s formatted on computer

“Memory Stick” s formatted on Windows OS or Macintosh computers are not guaranteed compatible with your camcorder.

Notes on image data compatibility

- Image data files recorded on “Memory Stick” s by your camcorder conform with the Design Rules for Camera File Systems universal standard established by the JEITA (Japan Electronics and Information Technology Industries Association). You cannot play back on your camcorder still images recorded on other equipment (DCR-TRV890E/TRV900/TRV900E or DSC-D700/D770) that does not conform with this universal standard. (These models are not sold in some areas.)
- If you cannot use the “Memory Stick” that is used with other equipment, format it with this camcorder (p. 111). However, formatting erases all information on the “Memory Stick.”

-
- “Memory Stick” and  are trademarks of Sony Corporation.
 - Windows and Windows Media are either registered trademarks or trademarks of Microsoft Corporation in the United States and/or other countries.
 - Macintosh and Mac OS, QuickTime are trademarks of Apple Computer, Inc.
 - RealPlayer is either a registered trademark or trademark of RealNetworks, Inc. in the United States and/or other countries.
 - Pentium is either registered trademark or trademark of Intel Corporation.
 - All other product names mentioned herein may be the trademarks or registered trademarks of their respective companies.

Furthermore, “™” and “®” are not mentioned in each case in this manual.

Inserting "Memory Stick"

Insert a "Memory Stick" in the "Memory Stick" slot as far as it can go with the ◀ mark facing toward the "Memory Stick" slot as illustrated.

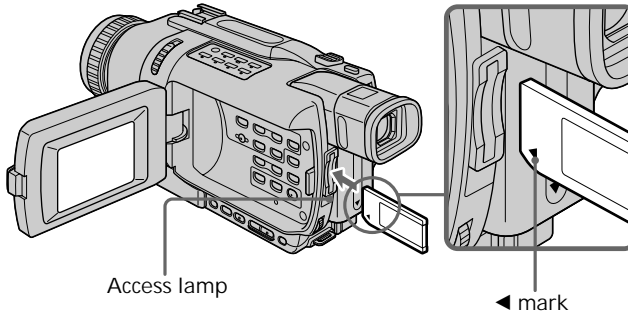

Ejecting the "Memory Stick"

Press the "Memory Stick" once lightly.

When the access lamp is lit or flashing

Do not shake or knock your camcorder because your camcorder is reading the data from the "Memory Stick" or recording the data on the "Memory Stick". Do not turn the power off, eject the "Memory Stick" or remove the battery pack. Otherwise, image data may become damaged.

If "MEMORY STICK ERROR" is displayed

Reinsert "Memory Stick" a few times. The "Memory Stick" may be damaged if the indicator is still displayed. If this occurs, use another "Memory Stick."

Selecting the still image quality mode

You can select the image quality mode in still image recording. The default setting is SUPER FINE (DCR-TRV740/TRV840), or FINE (DCR-TRV340).

- (1) Set the POWER switch to VCR or MEMORY. Make sure that the LOCK switch is set to the left (unlock) position.
- (2) Press MENU to display the menu settings.
- (3) Turn the SEL/PUSH EXEC dial to select STILL SET in , then press the dial.
- (4) Turn the SEL/PUSH EXEC dial to select QUALITY, then press the dial.
- (5) Turn the SEL/PUSH EXEC dial to select the desired image quality, then press the dial.

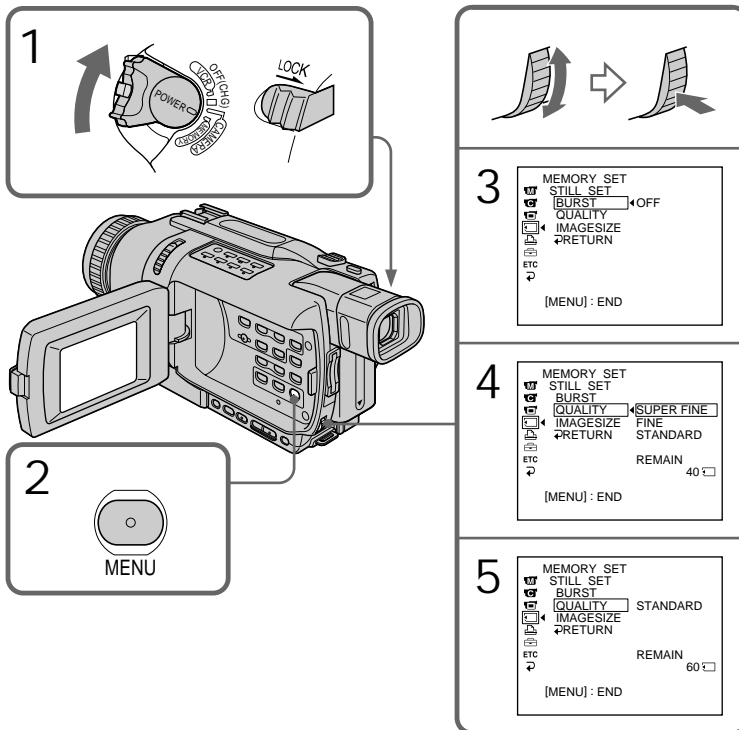

Note

In some cases, changing the image quality mode may not affect the image quality, depending on the type of images you are shooting.

Image quality settings

Setting	Meaning
SUPER FINE (SFN) (DCR-TRV740/ TRV840 only)	This is the highest image quality in your camcorder. The number of still images you can record is less than in FINE mode. The image is compressed to about 1/3.
FINE (FINE)	Use this mode when you want to record high quality images. Fine images are compressed to about 1/6.
STANDARD (STD)	This is the standard image quality. Standard images are compressed to about 1/10.

Note

In some cases, changing the image quality mode may not affect the image quality, depending on the types of images you are shooting.

Differences in image quality mode

Recorded images are compressed in JPEG format before being stored into memory. The memory capacity allotted to each image varies depending on the selected image quality mode and image size. Details are shown in the tables below. (You can select 1152 × 864 or 640 × 480 image size in the menu settings. (DCR-TRV740/TRV840 only))

1152 × 864 image size (DCR-TRV740/TRV840 only)

Image quality mode	Memory capacity
SUPER FINE	About 600 KB
FINE	About 300 KB
STANDARD	About 200 KB

640 × 480 image size

Image quality mode	Memory capacity
SUPER FINE (DCR-TRV740/TRV840 only)	About 190 KB
FINE	About 100 KB
STANDARD	About 60 KB

Image quality mode indicator

The image quality mode indicator is not displayed during playback.

When you select image quality

The number of images you can shoot in the currently selected image quality appears on the screen.

Selecting the image size

You can select either of two image sizes

Still images (DCR-TRV740/TRV840 only): 1152 × 864 or 640 × 480.



The default setting is 1152 × 864.

Moving pictures: 320 × 240 or 160 × 112

The default setting is 320 × 240.

- (1) Set the POWER switch to MEMORY. Make sure that the LOCK switch is set to the left (unlock) position.
- (2) Press MENU to display the menu settings.
- (3) Turn the SEL/PUSH EXEC dial to select STILL SET (still image) (DCR-TRV740/TRV840 only) or MOVIE SET (moving picture) in , then press the dial.
- (4) Turn the SEL/PUSH EXEC dial to select IMAGESIZE, then press the dial.
- (5) Turn the SEL/PUSH EXEC dial to select the desired image size, then press the dial.

The indicator changes as follows:

Still images (DCR-TRV740/TRV840 only):  ↔ 
 Moving pictures:  ↔ 

1

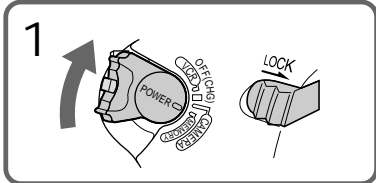



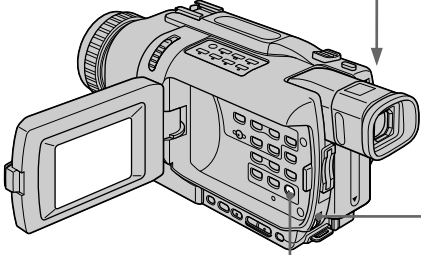

MENU

4

STILL SET
(DCR-TRV740/
TRV840 only)

MEMORY SET	MEMO
STILL SET	
BURST	
QUALITY	
IMAGESIZE	1152×864
RETURN	640×480
REMAIN	12
[MENU]: END	

MOVIE SET

MEMORY SET	MEMO
MOVIE SET	
IMAGESIZE	320×240
RETURN	160×112
REMAIN	40sec
[MENU]: END	

5

STILL SET
(DCR-TRV740/
TRV840 only)







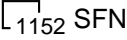

MEMORY SET	MEMO
STILL SET	
BURST	
QUALITY	
IMAGESIZE	640×480
RETURN	
REMAIN	60
[MENU]: END	

MOVIE SET

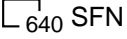
MEMORY SET	MEMO
MOVIE SET	
IMAGESIZE	160×112
RETURN	
REMAIN	2 min
[MENU]: END	

Using "Memory Stick" – Introduction

Image size settings

Setting	Meaning	Indicator	
		Recording	Playback
1152 × 864*	Records 1152 × 864 still images.		
640 × 480*	Records 640 × 480 still images.		
320 × 240	Records 320 × 240 moving pictures.		
160 × 112	Records 160 × 112 moving pictures.		

* DCR-TRV740/TRV840 only

Maximum recording time of moving pictures (DCR-TRV340 only)

Image size	Maximum recording time
320 × 240	15 seconds
160 × 112	60 seconds

Using "Memory Stick" – Introduction

Approximate number of still images you can record on a "Memory Stick"

The number of images you can record varies depending on which image quality you select and the complexity of the subject.

Image quality	Image size	Type of "Memory Stick"s				
		8MB (supplied)	16MB (optional)	32MB (optional)	64MB (optional)	128MB (optional)
SUPER FINE*	1152 × 864	12 images	25 images	51 images	100 images	205 images
	640 × 480	40 images	80 images	160 images	325 images	650 images
FINE	1152 × 864*	25 images	50 images	100 images	205 images	415 images
	640 × 480	80 images	160 images	325 images	650 images	1310 images
STANDARD	1152 × 864*	37 images	74 images	150 images	300 images	600 images
	640 × 480	120 images	240 images	485 images	980 images	1970 images

*DCR-TRV740/TRV840 only

Approximate time of moving pictures you can record on a "Memory Stick"

The time of moving pictures you can record varies depending on which image size you select and the complexity of the subject.

Image size	Type of "Memory Stick"s				
	8MB (supplied)	16MB (optional)	32MB (optional)	64MB (optional)	128MB (optional)
160 × 112	5 min. 20 sec.	10 min. 40 sec.	21min. 20 sec.	42min. 40 sec.	85min. 20 sec.
	320 × 240	1 min. 20 sec.	2 min. 40 sec.	5 min. 20 sec.	10min. 40 sec.

The table above shows approximate number of still images and times of moving pictures you can record on a "Memory Stick" formatted on your camcorder.

Recording still images on “Memory Stick” s – Memory Photo recording

– Except DCR-TRV240

You can record still images on “Memory Stick” s.

Before operation

Insert a “Memory Stick” into your camcorder.

- (1) Set the POWER switch to MEMORY. Make sure that the LOCK switch is set to the left (unlock) position.
 - (2) Keep pressing PHOTO lightly until the desired still image appears. The green ● mark stops flashing, then lights up. The brightness of the image and focus are adjusted, being targeted for the middle of the image and are fixed. Recording does not start yet.
 - (3) Press PHOTO deeper.
- Recording is complete when the bar scroll indicator disappears. The image when you pressed PHOTO deeper will be recorded on the “Memory Stick.”

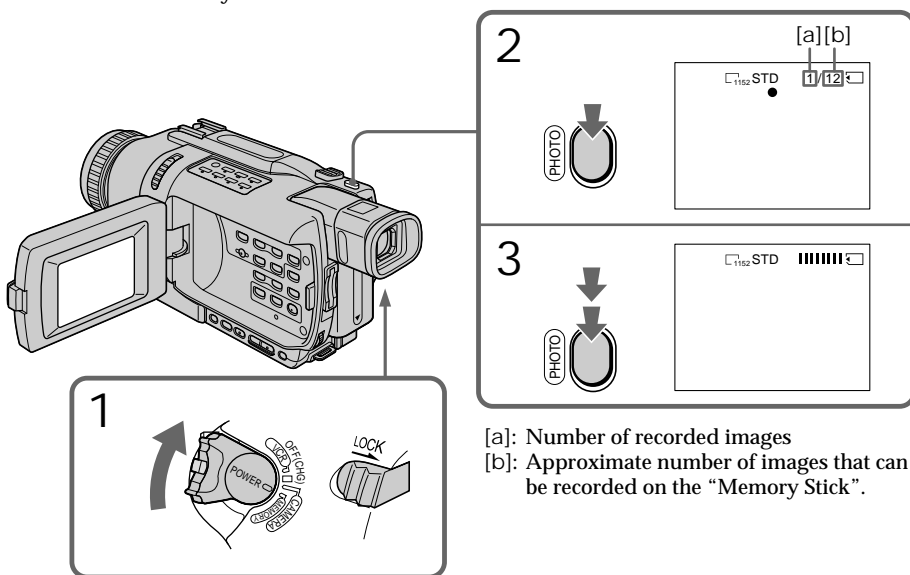

For DCR-TRV340 only

You can select the FIELD or FRAME mode in still image recording. Your camcorder compensates for camera-shake when recording moving subjects in the FIELD mode. Your camcorder records still images in high quality in the FRAME mode. Select the FIELD or FRAME in the menu settings (p. 105).

Notes

- When recording fast-moving subjects in the FRAME mode, the recorded image blurry. (DCR-TRV340 only)
- When recording in the FRAME mode, your camcorder may not correct camera-shake. We recommend that you shoot objects with a tripod. (DCR-TRV340 only)
- When recording still images at step 2 with PHOTO pressed lightly, the image momentarily flickers. This is not a malfunction.

Recording still images on “Memory Stick”s – Memory Photo recording

When the POWER switch is set to MEMORY

The following functions do not work:

- Wide mode
- SUPER NIGHTSHOT
- Color Slow Shutter
- Fader
- Picture effects
- Digital effects
- Titles
- Digital zoom (DCR-TRV740/TRV840 only)
- SteadyShot (DCR-TRV740/TRV840 only)
- Sports lesson (DCR-TRV740/TRV840 only)

When you press PHOTO lightly in step 2

The image momentarily flickers. This is not a malfunction.

While you are recording a still image

You can neither turn off the power nor press PHOTO.

When you press PHOTO on the Remote Commander

Your camcorder immediately records the image that is on the screen when you press the button.

Recording data

The recording data (date/time or various settings when recorded) are not displayed while recording. However, they are recorded automatically onto the “Memory Stick.” To display the recording data, press DATA CODE on the Remote Commander during playback.

You can record still images on “Memory Stick”s in CAMERA mode, even while you are in the standby mode or recording moving pictures to tape

Set PHOTO REC to MEMORY in the menu settings before operation. (The default setting is MEMORY.)

Press PHOTO to record still images on “Memory Stick”s in CAMERA mode, while you are standing by for recording or recording moving pictures to tape.

You cannot record still images on “Memory Stick”s in CAMERA mode in the following functions:

- Fader
- Wide mode
- Super NightShot
- Color Slow Shutter
- Picture effects
- Digital effects
- MEMORY MIX

While recording still images on “Memory Stick”s in CAMERA mode

- While the title is displayed, images can be recorded but titles cannot.
- The image is recorded in the FIELD mode automatically even you select FRAME in the menu settings. (DCR-TRV340 only)
- The image size is automatically set to 640 × 480, even if you set IMAGESIZE to 1152 × 864 in the menu settings. (DCR-TRV740/TRV840 only)

Recording images continuously

You can record still images continuously. Select one of the three modes described below before recording.

NORMAL [a] (DCR-TRV740/TRV840 only)

Your camcorder shoots up to four still images in 1152 × 864 size or 13 still images in 640 × 480 size at about 0.5 sec intervals. ()

EXP BRKTG (Recording image size is 640 × 480) (DCR-TRV740/TRV840 only)

Your camcorder automatically shoots three images at about 0.5 sec intervals at different exposure. (**BRK**)

MULTI SCR N (Recording image size is 640 × 480) [b]

Your camcorder shoots nine still images at about 0.4 sec intervals and displays the images on a single page divided into nine boxes. ()

[a]



[b]



- (1) Set the POWER switch to MEMORY. Make sure that the LOCK switch is set to the left (unlock) position.
- (2) Press MENU to display the menu settings.
- (3) Turn the SEL/PUSH EXEC dial to select STILL SET in , then press the dial.
- (4) Turn the SEL/PUSH EXEC dial to select BURST (DCR-TRV740/TRV840 only) /PIC MODE (DCR-TRV340 only), then press the dial.
- (5) Turn the SEL/PUSH EXEC dial to select the desired setting, then press the dial.
- (6) Press MENU to make the menu settings disappear.
- (7) Press PHOTO deeper.

Recording still images on “Memory Stick” - Memory Photo recording

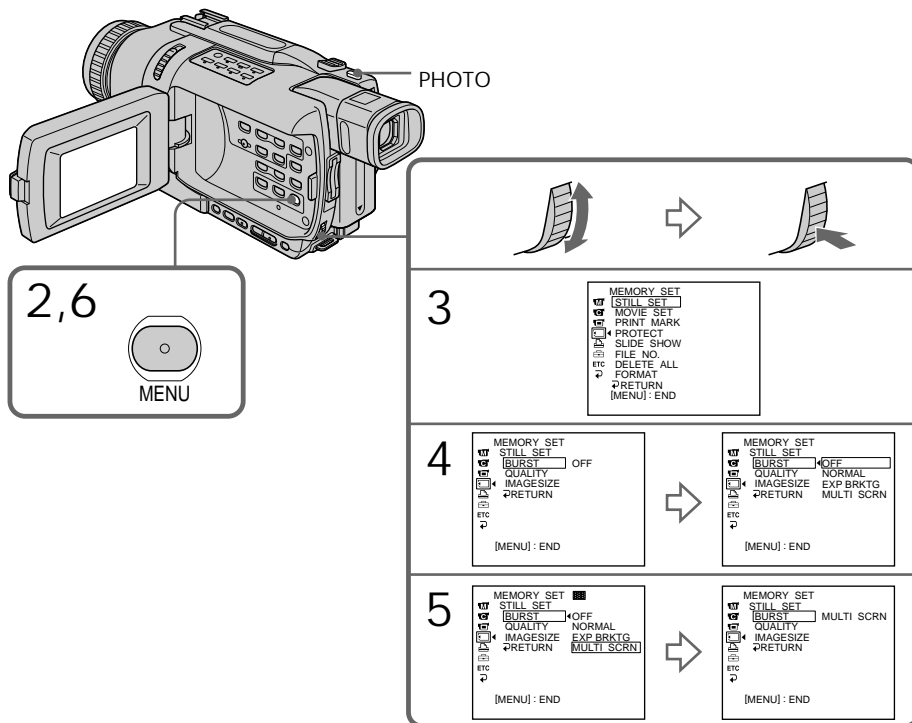

If the capacity of the “Memory Stick” becomes full
“FULL” appears on the screen and you cannot record still images on the “Memory Stick”.

When recording in the multi screen mode

The image is recorded in the FIELD mode automatically even you select FRAME in the menu settings. (DCR-TRV340 only)

The number of images in continuous shooting

The number of images you can shoot continuously varies depending on the image size and the capacity of the “Memory Stick.” (DCR-TRV740/TRV840 only)

When shooting with the self-timer function or the Remote Commander

Your camcorder automatically records up to the maximum recordable number of still images. (DCR-TRV740/TRV840 only)

When selecting NORMAL (DCR-TRV740/TRV840 only)

Recording continues up to the maximum number of still images during pressing PHOTO deeper. Release PHOTO to stop recording.

When recording images continuously

You cannot zoom images.

When selecting MULTI SCR, the image size is automatically set to 640 × 480, even if you set IMAGESIZE to 1152 × 864 in the menu settings. (DCR-TRV740/TRV840 only)

Recording still images on “Memory Stick” s – Memory Photo recording

Self-timer memory photo recording

You can record images on “Memory Stick” s with the self-timer.
You can use the Remote Commander for this operation.

- (1) Set the POWER switch to MEMORY. Make sure that the LOCK switch is set to the left (unlock) position.
- (2) In the standby mode, press MENU to display the menu settings.
- (3) Turn the SEL/PUSH EXEC dial to select SELFTIMER in , then press the dial.
- (4) Turn the SEL/PUSH EXEC dial to select ON, then press the dial.
- (5) Press MENU to make the menu settings disappear.
- (6) Press PHOTO deeper.

Self-timer starts counting down from 10 with a beep. In the last two seconds of the countdown, the beep gets faster, then recording starts automatically.

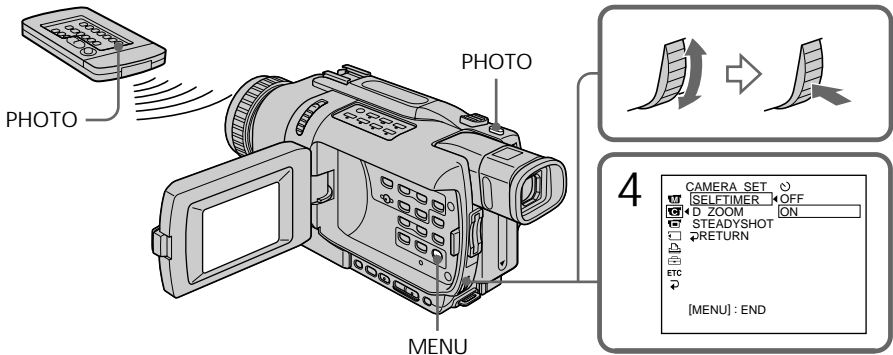

To record moving pictures on “Memory Stick” s with the self-timer

Press START/STOP in step 6. To cancel recording, press START/STOP again.

To cancel self-timer recording

Set SELFTIMER to OFF in the menu settings while your camcorder is in the standby mode. You cannot cancel self-timer recording with Remote Commander.

Note

The self-timer recording mode is automatically canceled when:

- Self-timer recording is finished.
- The POWER switch is set to OFF (CHG) or VCR.

To check the image to be recorded

You can check the image by lightly pressing PHOTO, then press it deeper to start self-timer recording.

Superimposing a still image in the "Memory Stick" on an image – MEMORY MIX

– Except DCR-TRV240

You can superimpose a still image you have recorded on the "Memory Stick" on the moving picture you are recording. You can record the superimposed images on a tape or a "Memory Stick". (However, you can record only superimposed still images on the "Memory Stick".)

M. CHROM (memory chroma key)

You can swap a blue area of a still image such as an illustration or a frame with a moving picture.

M. LUMI (memory luminance key)

You can swap a brighter area of a still image such as a handwritten illustration or title with a moving picture. Record a title on the "Memory Stick" before a trip or event for convenience.

C. CHROM (camera chroma key)

You can superimpose a moving picture on a still image such as an image can be used as background. Shoot the subject against a blue background. The blue area of the moving image will be swapped with a still image.

M. OVERLAP* (memory overlap)

You can make a moving picture fade in on top of a still image recorded on the "Memory Stick" as the overlap function.

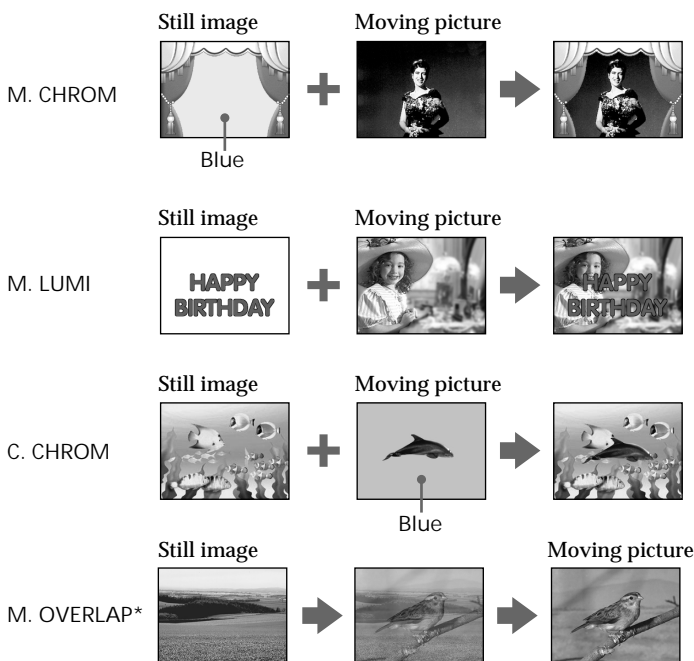

* The superimposed image using Memory overlap function can be recorded on tapes only.

Superimposing a still image in the "Memory Stick" on an image - MEMORY MIX

Recording superimposed images on a tape

Before operation

- Insert a tape for recording into your camcorder.
- Insert a "Memory Stick" is recorded still images into your camcorder.

- (1) Set the POWER switch to CAMERA.
- (2) In the standby mode, press MEMORY MIX.
The last recorded or last composed image appears on the lower part of the screen as a thumbnail image.
- (3) Press MEMORY+/- to select the still image you want to superimpose.
To see the previous image, press MEMORY -. To see the next image, press MEMORY+.
- (4) Turn the SEL/PUSH EXEC dial to select the desired mode.
The mode changes as follows:
M. CHROM ↔ M. LUMI ↔ C. CHROM ↔ M. OVERLAP
- (5) Press the SEL/PUSH EXEC dial.
The still image is superimposed on the moving picture.
- (6) Turn the SEL/PUSH EXEC dial to adjust the effect.

M. CHROM - The color (blue) scheme of the area in the still image which is to be swapped with a moving picture

M. LUMI - The color (bright) scheme of the area in the still image which is to be swapped with a moving picture

C. CHROM - The color (blue) scheme of the area in the moving picture which is to be swapped with a still image

M. OVERLAP - No adjustment necessary

The fewer bars there are on the screen, the stronger the effect becomes.

- (7) Press START/STOP to start recording.

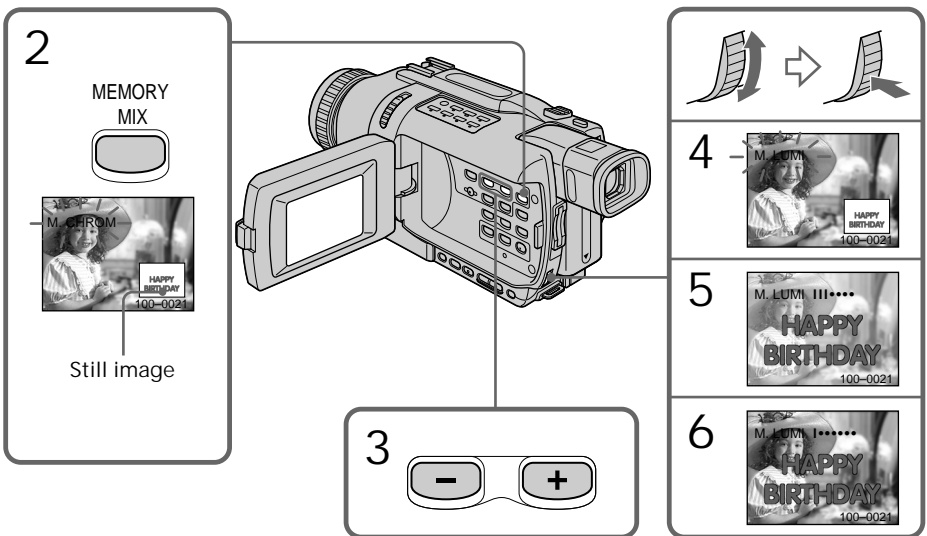

Superimposing a still image in the “Memory Stick” on an image - MEMORY MIX

To change the still image to superimpose

Do either of the following:

- Press MEMORY+/- before step 7.
- Press the SEL/PUSH EXEC dial before step 7, and repeat the procedure from step 4.

To change the mode setting

Press the SEL/PUSH EXEC dial before step 7, and repeat the procedure from step 4.

To cancel MEMORY MIX

Press MEMORY MIX.

Notes

- You cannot use the MEMORY MIX function for moving pictures recorded on “Memory Stick”s.
- When the overlapping still image has a large amount of white, the thumbnail image of the picture may not be clear.

Image data modified on your computer or shot with other equipment

You may not be able to play modified images back with your camcorder.

When you select M. OVERLAP

You cannot change the still image or the mode setting.

During recording

You cannot change the mode setting.

To record the superimposed image as a still image

Press PHOTO deeper in step 7.

Images processed by MEMORY MIX

You cannot record the images on “Memory Stick”s in CAMERA mode.

Record them in MEMORY mode. (p. 132)

Recording superimposed images on a “Memory Stick” as a still image

Before operation

Insert a “Memory Stick” is recorded still images into your camcorder.

- (1) Set the POWER switch to MEMORY. Make sure that the LOCK switch is set to the left (unlock) position.
- (2) Press MEMORY MIX.
The last recorded or last composed image appears on the lower part of the screen as a thumbnail image.
- (3) Press MEMORY+/- to select the still image you want to superimpose.
To see the previous image, press MEMORY -. To see the next image, press MEMORY+.
- (4) Turn the SEL/PUSH EXEC dial to select the desired mode.
The mode changes as follows:
M. CHROM ↔ M. LUMI ↔ C. CHROM
- (5) Press the SEL/PUSH EXEC dial.
The still image is superimposed on the moving picture.
- (6) Turn the SEL/PUSH EXEC dial to adjust the effect.
M. CHROM – The color (blue) scheme of the area in the still image which is to be swapped with a moving picture
M. LUMI – The color (bright) scheme of the area in the still image which is to be swapped with a moving picture
C. CHROM – The color (blue) scheme of the area in the moving picture which is to be swapped with a still image

The fewer bars there are on the screen, the stronger the effect becomes.
- (7) Press PHOTO deeper to start recording.
The image displayed on the screen will be recorded on a “Memory Stick.”
Recording is complete when the bar scroll indicator disappears.

Superimposing a still image in the "Memory Stick" on an image - MEMORY MIX

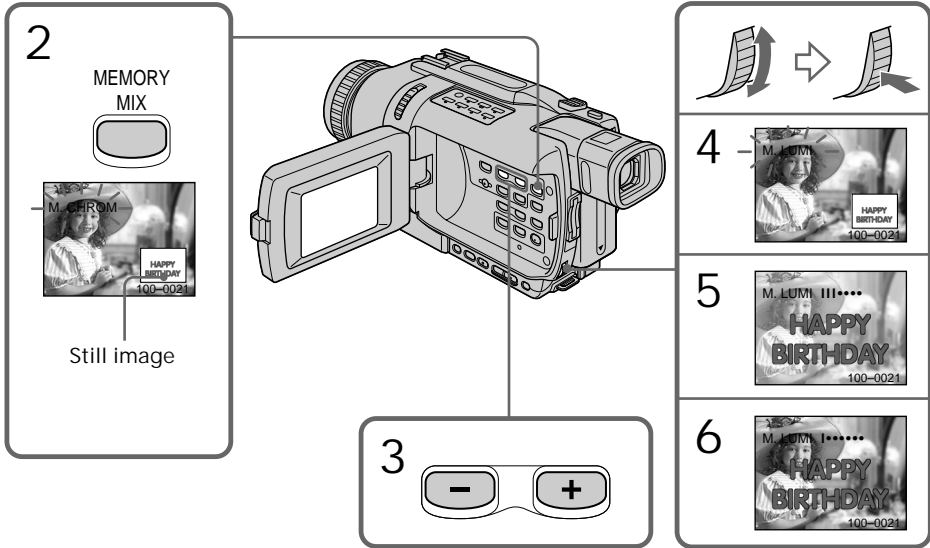

To change the still image to superimpose

Do either of the following:

- Press MEMORY+/- before step 7.
- Press the SEL/PUSH EXEC dial before step 7, and repeat the procedure from step 4.

To change the mode setting

Press the SEL/PUSH EXEC dial before step 7, and repeat the procedure from step 4.

To cancel MEMORY MIX

Press MEMORY MIX.

Superimposing a still image in the “Memory Stick” on an image – MEMORY MIX

Notes

- You cannot use the MEMORY MIX function for moving pictures recorded on “Memory Stick”s.
- When the overlapping still image has a large amount of white, the thumbnail image of the picture may not be clear.

Image data modified on your computer or shot with other equipment
You may not be able to play modified images back with your camcorder.

During recording

You cannot change the mode setting.

When recording images on a “Memory Stick” using the MEMORY MIX function
The PROGRAM AE function does not work. (The indicator flashes.)

The “Memory Stick” supplied with your camcorder is already stored with 20 images

- For M. CHROM: 18 images (such as a frame) 100-0001~100-0018
- For C. CHROM: two images (such as a background) 100-0019~100-0020

Sample images

Sample images stored in the “Memory Stick” supplied with your camcorder are protected (p. 170).

While using the MEMORY MIX function

- The image is recorded in the FIELD mode automatically even you select FRAME in the menu settings. (DCR-TRV340 only)
- The image size is automatically set to 640 × 480, even if you set IMAGESIZE to 1152 × 864 in the menu settings. (DCR-TRV740/TRV840 only)

Recording images from a tape as still images

– Except DCR-TRV240

Your camcorder can read moving image data recorded on a tape recorded in the Digital8  system, and record it as a still image on a “Memory Stick.”

Your camcorder can also capture moving image data through the input connector and record it as a still image on a “Memory Stick.”

Before operation

- Insert a tape recorded in the Digital8  system into your camcorder.
- Insert a “Memory Stick” into your camcorder.

- (1) Set the POWER switch to VCR.
- (2) Press . Moving pictures recorded on the tape are played back.
- (3) Keep pressing PHOTO lightly until the picture from the tape freezes. “CAPTURE” appears on the screen. Recording does not start yet.
- (4) Press PHOTO deeper. The image displayed on the screen will be recorded on the “Memory Stick”. Recording is complete when the bar scroll indicator disappears.

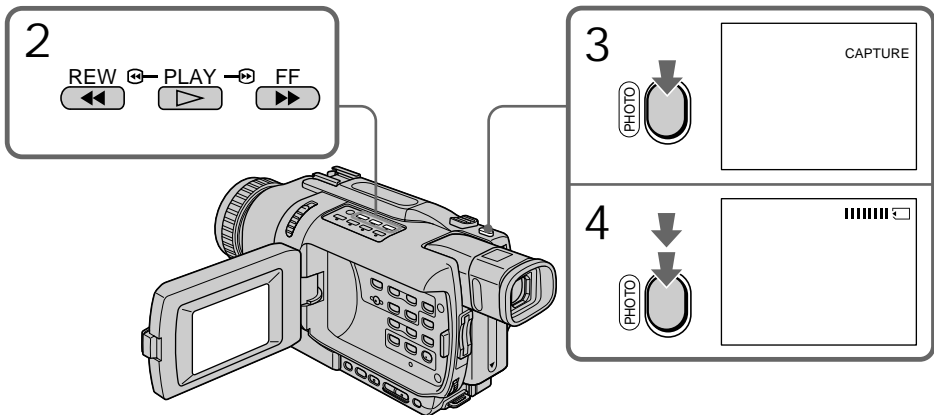

When the access lamp is lit or flashing

Do not shake or knock the unit. Also do not turn the power off, eject the “Memory Stick” or remove the battery pack. Otherwise, image data may become damaged.

If  appears on the screen

The inserted “Memory Stick” is incompatible with your camcorder because its format does not conform with your camcorder. Check the format of the “Memory Stick.”

If you press PHOTO lightly in the playback mode

Your camcorder stops momentarily.

Sound recorded on a tape

You cannot record audio from a tape.

“Memory Stick” operations

Recording images from a tape as still images

When you press PHOTO on the Remote Commander

Your camcorder immediately records the image that is on the screen when you press the button.

Titles superimposed on tapes

You cannot record titles on the "Memory Stick." However, you can record titles which have already been recorded on tapes.

Recording date/time

The recording data (date/time) when it is recorded on "Memory Stick" is recorded. Various settings are not recorded.

While recording still images from a tape as still images

- The image is recorded in the FIELD mode automatically even you select FRAME in the menu settings. (DCR-TRV340 only)
- The image size is automatically set to 640 × 480, even if you set IMAGESIZE to 1152 × 864 in the menu settings. (DCR-TRV740/TRV840 only)

Recording a still image from external equipment

Before operation

Set DISPLAY to LCD in the menu settings. (The default setting is LCD.)

- (1) Set the POWER switch to VCR.
- (2) Play back the recorded tape, or turn the TV on to see the desired program.
The picture from TV or VCR appears on the screen of your camcorder.
- (3) Follow the steps 3 and 4 on page 135.

Using the A/V connecting cable

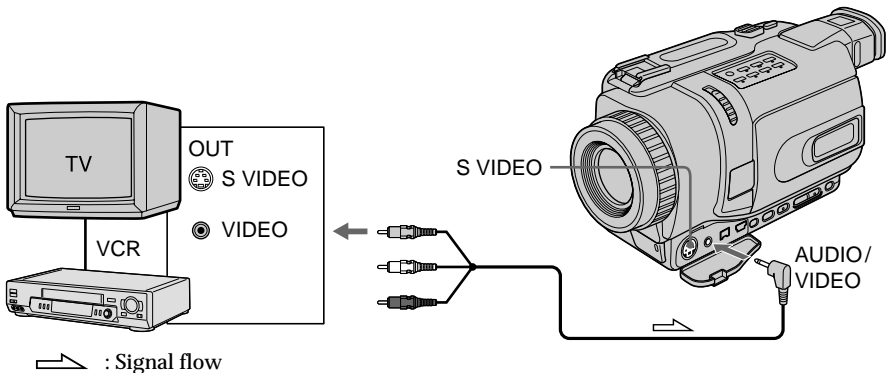

Connect the yellow plug of the A/V connecting cable to the video jack on the VCR or the TV.

If your TV or VCR has an S video jack

Pictures can be reproduced more faithfully by using an S video cable (optional).

With this connection, you do not need to connect the yellow (video) plug of the A/V connecting cable.

Connect an S video cable (optional) to the S video jacks of both your camcorder and the TV or VCR.

Recording images from a tape as still images

Using the i.LINK cable (DV connecting cable)

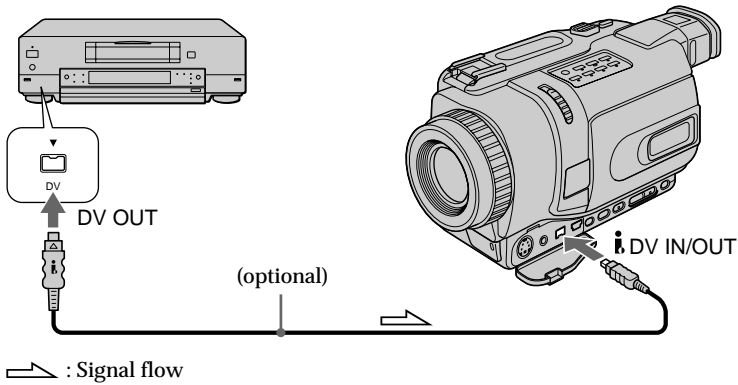

Note

In the following instances, "□ REC ERROR" is displayed and recording is not possible. Record undistorted images.

- When recording on a tape in a poor recording state, for example, on a tape that has been repeatedly used for dubbing
- Between scenes or in the various playback modes on the tape recorded in Hi8/standard 8 system
- When attempting to input images that are distorted due to poor radio wave reception when a TV tuner unit is in use

Copying still images from a tape – PHOTO SAVE

– Except DCR-TRV240

Using the search function, you can automatically capture only still images from tapes recorded in the Digital8  system and record them on a “Memory Stick” in sequence.

Before operation

- Insert a tape recorded in the Digital8  system and rewind the tape.
- Insert a “Memory Stick” into your camcorder.

- (1) Set the POWER switch to VCR.
- (2) Press MENU to display the menu settings.
- (3) Turn the SEL/PUSH EXEC dial to select PHOTO SAVE in , then press the dial.

PHOTO BUTTON appears on the screen.

- (4) Press PHOTO deeper. The still image from the tape is recorded on the “Memory Stick.” The number of still images copied is displayed. END is displayed when copying ends.

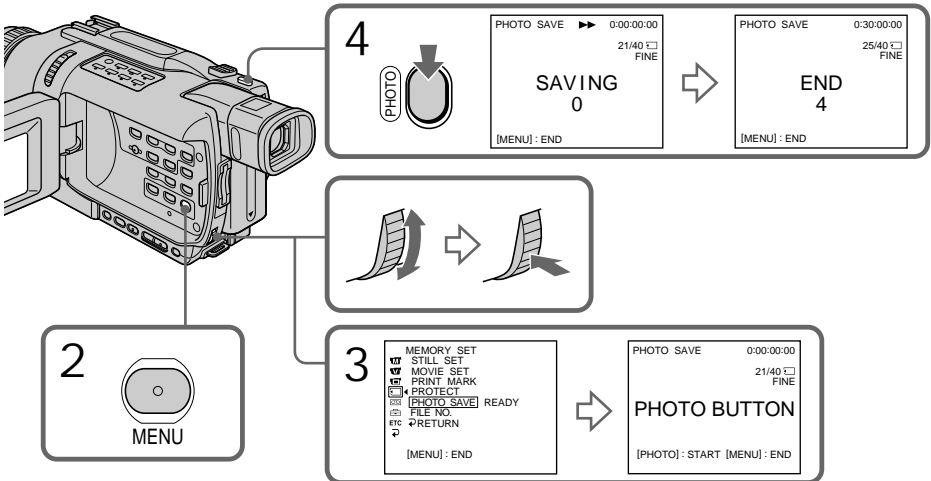

To stop copying

Press MENU.

When the “Memory Stick” becomes full

“MEMORY FULL” appears on the screen, and copying stops. Insert another “Memory Stick” and repeat the procedure from step 2.

When the access lamp is lit or flashing

Do not shake or knock your camcorder. As well do not turn the power off, eject the “Memory Stick” or remove the battery pack. Otherwise, image data may become damaged.

If the write-protect tab on the “Memory Stick” is set to LOCK

“NOT READY” appears on the screen when you select PHOTO SAVE in the menu settings.

When you change the “Memory Stick” during copying

Your camcorder resumes copying from the last image recorded on the previous “Memory Stick”.

While copying still images from a tape

- The image is recorded in the FIELD mode automatically even you select FRAME in the menu settings. (DCR-TRV340 only)
- The image size is automatically set to 640 × 480, even if you set IMAGESIZE to 1152 × 864 in the menu settings. (DCR-TRV740/TRV840 only)

Recording moving pictures on “Memory Stick” s – MPEG movie recording

– Except DCR-TRV240

You can record moving pictures with sound on “Memory Stick”s.

Before operation

Insert a “Memory Stick” into your camcorder.

(1) Set the POWER switch to MEMORY. Make sure that the LOCK switch is set to the left (unlock) position.

(2) Press START/STOP. Your camcorder starts recording. The camera recording lamp located on the front of your camcorder lights up.

For DCR-TRV340 only:

When IMAGESIZE in the menu settings is set to 320×240 , the maximum recording time is 15 seconds. However, when IMAGESIZE in the menu settings is set to 160×112 , the maximum recording time is 60 seconds.

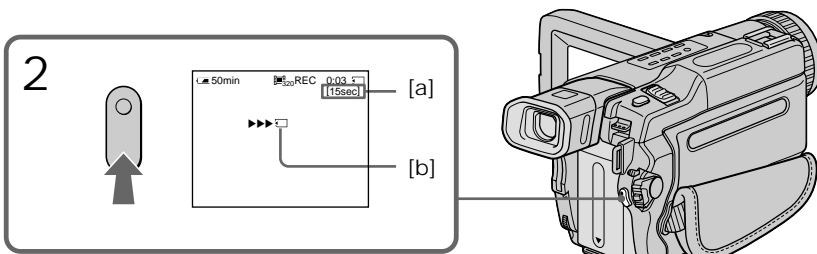

[a]: The recording time can be recorded on the “Memory Stick”

[b]: This indicator is displayed for five seconds after pressing START/STOP. This indicator is not recorded.

To stop recording

Press START/STOP.

Note

Sound is recorded in monaural.

When the POWER switch is set to MEMORY

The following functions do not work:

- Wide mode
- SUPER NIGHTSHOT
- Color Slow Shutter
- Fader
- Picture effects
- Digital effects
- Titles
- Digital zoom (DCR-TRV740/TRV840 only)
- SteadyShot (DCR-TRV740/TRV840 only)
- Sports lesson (The indicator flashes) (DCR-TRV740/TRV840 only)

Recording moving pictures on “Memory Stick” s – MPEG movie recording

When the POWER switch is set to MEMORY

The angle of view is slightly larger compared with the angle of view in CAMERA mode.

When using an external flash (optional)

Turn the power of the external flash off when recording moving pictures on “Memory Stick” s.

Otherwise, the charging sound for the flash may be recorded.

Recording date/time

The date/time are not displayed while recording. However, they are automatically recorded onto the “Memory Stick.”

To display the recording date/time, press DATA CODE on the Remote Commander during playback. Various settings cannot be recorded.

During recording on “Memory Stick”

Do not eject the cassette tape from your camcorder. During ejecting the tape, sound is not recorded on the “Memory Stick.”

Recording pictures from a tape as moving pictures

– Except DCR-TRV240

Your camcorder can read moving picture data recorded on tapes and record it as a moving picture on a “Memory Stick.” Your camcorder can also capture moving picture data through the input connector and record it as a moving picture on a “Memory Stick.”

Before operation

- Insert a recorded tape into your camcorder.
- Insert a “Memory Stick” into your camcorder.

- (1) Set the POWER switch to VCR.
- (2) Press **▶**. The picture recorded on the tape is played back.
And press **⏸** at the scene where you want to start recording from.
- (3) Press START/STOP on your camcorder.

For DCR-TRV340 only:

When IMAGESIZE in the menu settings is set to 320×240 , the maximum recording time is 15 seconds. However, when IMAGESIZE in the menu settings is set to 160×112 , the maximum recording time is 60 seconds.

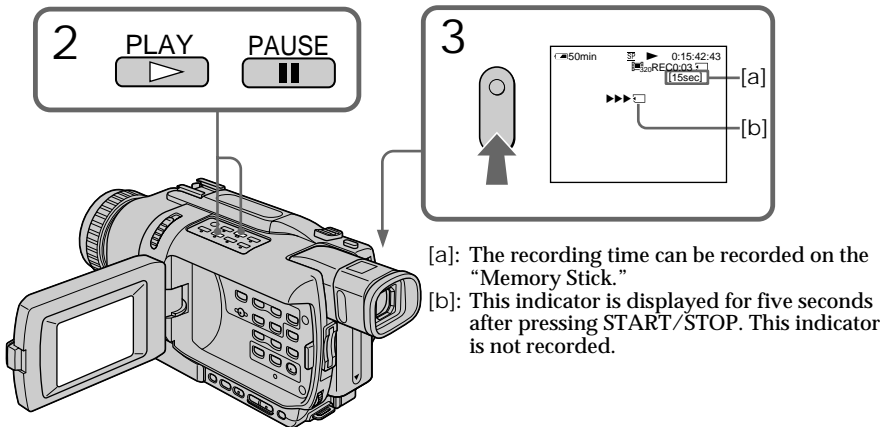

To stop recording
Press START/STOP or **■**.

Recording pictures from a tape as moving pictures

Notes

- Sound recorded in 48 kHz is converted to 32 kHz sound when recording pictures from a tape to “Memory Stick”s.
- Sound recorded in stereo is converted to monaural sound when recording from tape.

When the access lamp is lit or flashing

Do not shake or knock the unit. Also, do not turn the power off, eject a “Memory Stick” or remove the battery pack. Otherwise, image data may become damage.

If “ AUDIO ERROR” is displayed

Sound that cannot be recorded by your camcorder has been recorded. Connect the A/V connecting cable to input images from external equipment used to play back the image (p. 144).

Recording date/time

The recording data (date/time) when it is recorded on “Memory Stick” is recorded. Various settings are not recorded.

The picture may be recorded on the “Memory Stick” incorrectly if:

- You turn the POWER switch during recording
- You press any video control buttons during recording
- Between the scenes recorded in the Digital8  system and in the Hi8/standard 8 system.

Moving pictures processed by PB ZOOM

You cannot record them on “Memory Stick”s.

Recording pictures from a tape as moving pictures

Recording a moving picture from external equipment

Before operation

Set DISPLAY to LCD in the menu settings. (The default setting is LCD.)

- (1) Set the POWER switch to VCR.
- (2) Play back the recorded tape, or turn the TV on to see the desired program.
The picture of the other equipment is displayed on the LCD screen or viewfinder.
- (3) Follow the procedure on page 142 from step 3 onwards at the point where you want to start recording from.

Using the A/V connecting cable

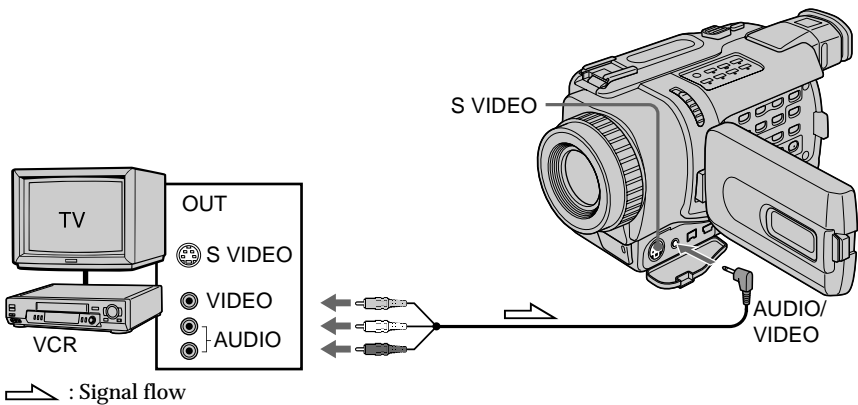

Connect the yellow plug of the A/V connecting cable to the video jack on the VCR or the TV.

If your TV or VCR has an S video jack

Pictures can be reproduced more faithfully by using an S video cable (optional).

With this connection, you do not need to connect the yellow (video) plug of the A/V connecting cable.

Connect an S video cable (optional) to the S video jacks of both your camcorder and the TV or VCR.

Recording pictures from a tape as moving pictures

Using the i.LINK cable (DV connecting cable)

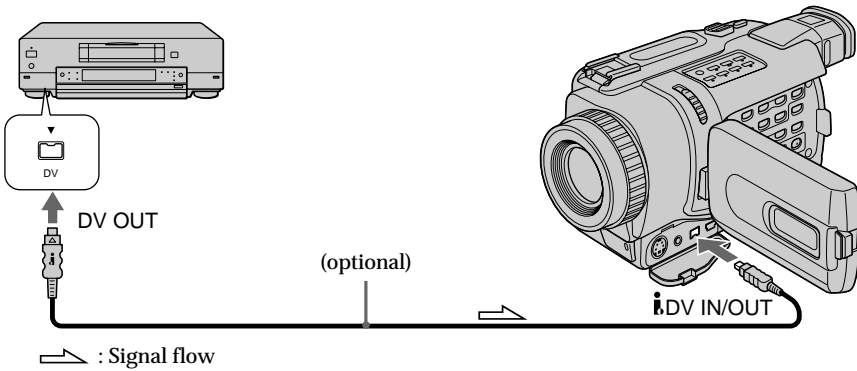

Note

In the following instances, recording is discontinued.

- When recording on a tape in a poor recording state, for example, on a tape that has been repeatedly used for dubbing
- Between scenes or in the various playback modes on the tape recorded in Hi8/standard 8 system
- When attempting to input images that are distorted due to poor radio wave reception when a TV tuner unit is in use
- The recording stops automatically if the picture is disrupted.
- When the input signal is cut off

When "REC ERROR" is displayed

Recording is discontinued, and image data is not saved.

During recording on "Memory Stick"

Do not eject the cassette tape from your camcorder. During ejecting the tape, sound is not recorded on the "Memory Stick."

Recording edited pictures as a moving picture – Digital program editing (on “Memory Stick” s)

– Except DCR-TRV240

You can duplicate selected scenes (programs) for editing onto “Memory Stick”s.

Making the program

- (1) Set the POWER switch to VCR on your camcorder.
- (2) Insert the tape for playback, and a “Memory Stick” for recording into your camcorder.
- (3) Press MENU to display the menu settings.
- (4) Turn the SEL/PUSH EXEC dial to select VIDEO EDIT in , then press the dial.
- (5) Turn the SEL/PUSH EXEC dial to select MEMORY, then press the dial.
- (6) Turn the SEL/PUSH EXEC dial to select IMAGESIZE, then press the dial.
- (7) Search for the beginning of the first scene you want to insert using the video operation buttons, then pause playback.
You can fine-adjust one frame at a time with EDITSEARCH.
- (8) Press the SEL/PUSH EXEC dial.
The IN point of the first program is set, and the top part of the program mark changes to light blue.
- (9) Search for the end of the first scene you want to insert using the video operation buttons, then pause playback.
- (10) Press the SEL/PUSH EXEC dial.
The OUT point of the first program is set, then the bottom part of the program mark changes to light blue.
- (11) Repeat steps 7 to 10, then set the program.
When one program is set, the program mark changes to light blue.
You can set 20 programs in maximum.

Recording edited pictures as a moving picture - Digital program editing (on "Memory Stick" s)

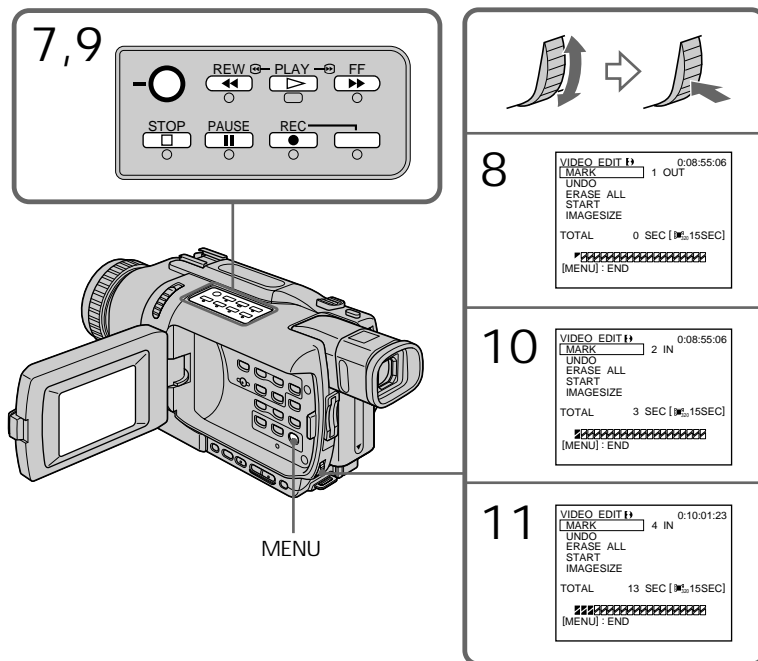

Erasing the program you have set
Erase OUT first and then IN from of the last program.

- (1) Turn the SEL/PUSH EXEC to select UNDO, then press the dial.
- (2) Turn the SEL/PUSH EXEC to select EXECUTE, then press the dial.

To cancel erasing
Select RETURN in step 2.

Erasing all programs

- (1) Select VIDEO EDIT in the menu settings. Turn the SEL/PUSH EXEC dial to select MEMORY, then press the dial.
- (2) Select ERASE ALL in the menu settings. Turn the SEL/PUSH EXEC dial to select EXECUTE, then press the dial.

To cancel erasing all programs
Select RETURN in step 2.

To cancel a program you have set
Press MENU.

The program is stored in memory until the tape is ejected.

Recording edited pictures as a moving picture – Digital program editing (on “Memory Stick” s)

Notes

- Digital program editing works only for tapes recorded in the Digital8  system.
- You cannot dub the titles or display indicators.
- You cannot operate recording during Digital program editing on “Memory Stick” s.
- You cannot set IN or OUT on a blank portion of the tape.
- If there is a blank portion between IN and OUT on the tape, the total time code may not be displayed correctly.

During making a program

If you eject the cassette, NOT READY appears on the screen. The program will be erased.

If you set over the maximum recording time (DCR-TRV340 only)

The program mark changes to yellow, and OVER 15 SEC LIMIT appears when IMAGESIZE is set to 320 × 240, or OVER 60 SEC LIMIT appears when IMAGESIZE is set to 160 × 112. However, you can record up to the maximum recording time.

Performing the program (Dubbing a "Memory Stick")

- (1) Select VIDEO EDIT in the menu settings. Turn the SEL/PUSH EXEC dial to select MEMORY, then press the dial.
- (2) Select START in the menu settings. Turn the SEL/PUSH EXEC dial to select EXECUTE, then press the dial.
Search for the beginning of the first program, then start dubbing.
The program mark flashes.
The SEARCH indicator appears during search, the EDITING indicator appears during writing of data on your camcorder, and REC appears during dubbing on the screen.
The program mark changes to light blue after dubbing is complete.
When the dubbing ends, your camcorder automatically stops.

To stop dubbing during editing

Press ■ using the video operation buttons.

The program you made is recorded on a "Memory Stick" up to the place where you pressed ■.

To end the Digital program editing function

Your camcorder stops when the dubbing ends. Then the display returns to VIDEO EDIT in the menu settings.

Press MENU to end the Digital program editing function.

NOT READY appears on the LCD screen when:

- The program to operate Digital program editing has not been made.
- The "Memory Stick" is not inserted.
- The write-protect tab on the "Memory Stick" is set to LOCK.
- "Memory Stick" does not have enough space to record.

When "Memory Stick" does not have enough space to record
LOW MEMORY appears on the screen. However, you can record pictures up to the time indicated.

If you set over the maximum recording time
OVER MEMORY LIMIT appears on the screen. However, you can record moving pictures up to the maximum recording time.

Viewing still images

- Memory Photo playback

- Except DCR-TRV240

You can play back still images recorded on a "Memory Stick". You can also play back six images including moving pictures in order at a time by selecting the index screen.

Before operation

Insert a "Memory Stick" into your camcorder.

- (1) Set the POWER switch to MEMORY or VCR. Make sure that the LOCK switch is set to the left (unlock) position.
- (2) Press MEMORY PLAY. The last recorded image is displayed.
- (3) Press MEMORY +/- to select the desired still image. To see the previous image, press MEMORY -. To see the next image, press MEMORY +.

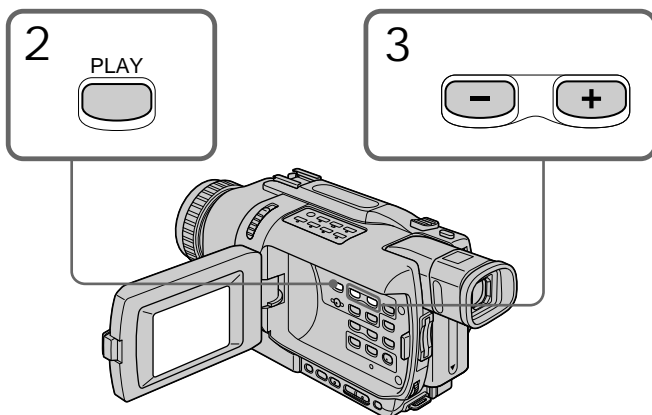

To stop memory photo playback

Press MEMORY PLAY.

Note

You may not be able to play back images with your camcorder:

- When playing back image data modified on your computer.
- When playing back image data shot with other equipment.

Notes on the file name

- The directory number may not be displayed and only the file name may be displayed if the structure of the directory does not conform to the DCF standard.
- "📁 ➡ DIRECTORY ERROR" may appear on the screen if the structure of the directory does not conform to the DCF standard. While this message appears, you can play back images but cannot record them on the "Memory Stick."
- The file name flashes on the screen if the file is corrupted or the file is unreadable.

Viewing still images – Memory Photo playback

To play back recorded images on a TV screen

- Before operation connect your camcorder to the TV with the A/V connecting cable supplied with your camcorder.
- When operating memory photo playback on a TV or the LCD screen, image quality may appear to have deteriorated. This is not a malfunction. The image data is as good as ever.
- Turn the audio volume of the TV down before operation, or noise (howling) may be output from the TV speakers.

When no still image is recorded on the “Memory Stick”

The message “ NO FILE” appears.

Screen indicators during still image playback

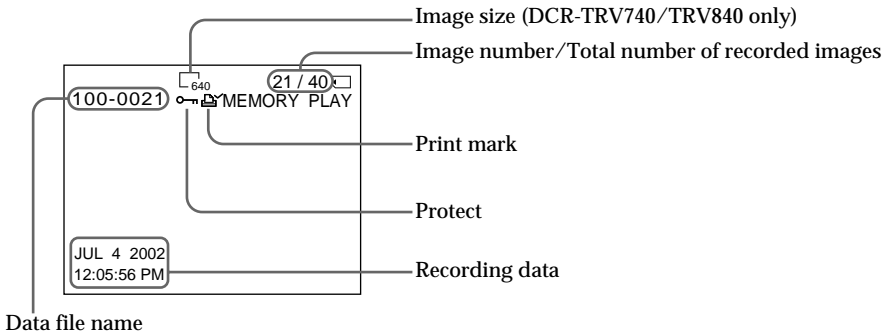

“Memory Stick” operations

Recording data

You can view recording data (date/time or various settings when recorded) by pressing DATA CODE on the Remote Commander.

Playing back six recorded images at a time (index screen)

You can play back six recorded images at a time. This function is especially useful when searching for a particular image.

- (1) Set the POWER switch to MEMORY or VCR. Make sure that the LOCK switch is set to the left (unlock) position.
- (2) Press MEMORY INDEX to display the index screen.

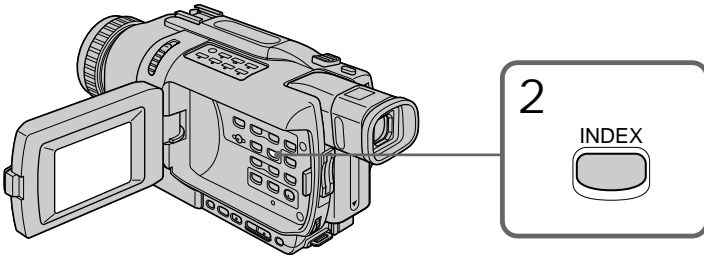

A red ► mark appears above the image that is displayed before changing to the index screen mode.

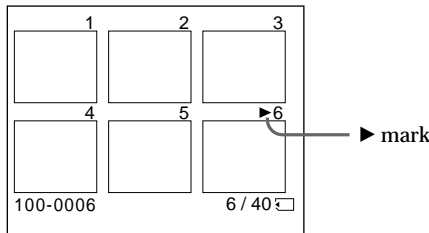

- To see the next six images, keep pressing MEMORY +.
- To see the previous six images, keep pressing MEMORY -.

To return to the normal playback screen (single screen)

Press MEMORY +/- to move the ► mark to the image you want to display on full screen, then press MEMORY PLAY.

Note

When displaying the index screen, the number appears above each image. This indicates the order in which images are recorded on the “Memory Stick”. These numbers are different from the data file names (p. 116).

Image data modified on your computer or shot with other equipment
These files are sometimes not displayed on the index screen.

Viewing moving pictures – MPEG movie playback

– Except DCR-TRV240

You can play back moving pictures recorded on a “Memory Stick.” You can also play back six images including still images in order at a time by selecting the index screen.

Before operation

Insert a “Memory Stick” into your camcorder.

- (1) Set the POWER switch to MEMORY or VCR. Make sure that the LOCK switch is set to the left (unlock) position.
- (2) Press MEMORY PLAY. The last recorded image is displayed.
- (3) Press MEMORY +/- to select the desired moving pictures. To see the previous picture, press MEMORY -. To see the next picture, press MEMORY +.
- (4) Press MPEG ► || to start playback.

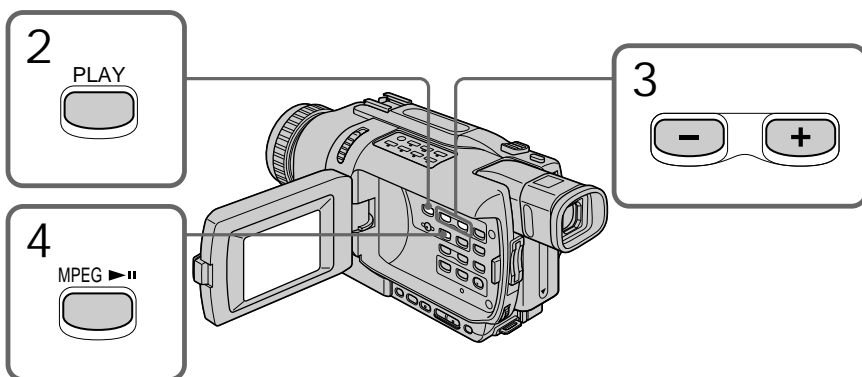

“Memory Stick” operations

To stop MPEG movie playback

Press MPEG ► || .

Note

You may not be able to play back images with your camcorder:

- When playing back image data modified on your computer.
- When playing back image data shot with other equipment.

To play back recorded images on a TV screen

- Before operation, connect your camcorder to the TV with the A/V connecting cable supplied with your camcorder.
- Turn the audio volume of the TV down before operation, or noise (howling) may be output from the TV speakers.

When no image is recorded on the “Memory Stick”

The message “ NO FILE” appears.

Screen indicators during moving picture playback

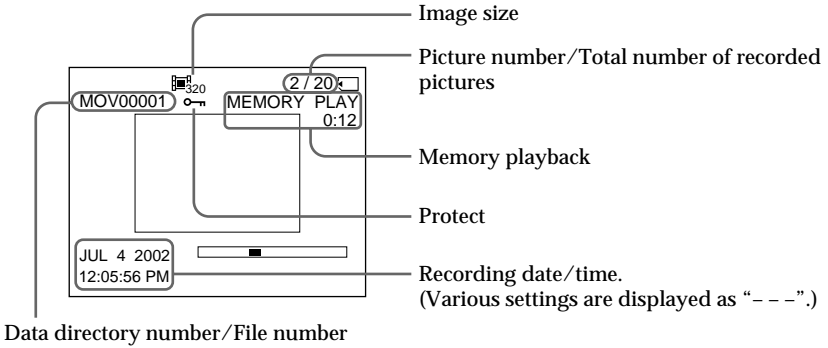

Recording date/time
You can view recording date/time by pressing DATA CODE on the Remote Commander during playback.

Viewing images recorded on “Memory Stick” s on your computer

– Except DCR-TRV240

You can view data recorded on the “Memory Stick” on your computer.

Note

Data recorded on the “Memory Stick” is stored in the following formats. Make sure that applications that support these file formats are installed on your computer.

- Still images: JPEG format
- Moving pictures/audio: MPEG format

Viewing images using computer

For Windows users (p. 156)

For Macintosh users (p. 160)

Notes

- Operations are not guaranteed for either the Windows or Macintosh environment if you connect two or more USB equipment to a single computer at the same time, or when using a hub.
- Some equipment may not operate depending on the type of USB equipment that is used simultaneously.
- Operations are not guaranteed for all the recommended computer environments mentioned above.
- All other product names mentioned herein may be the trademarks or registered trademarks of their respective companies. Furthermore, “™” and “®” are not mentioned in each case in this manual.

Viewing images recorded on “Memory Stick”s on your computer

For Windows users

Recommended Windows environment

OS: Microsoft Windows 98, Windows 98SE, Windows Me, Windows 2000 Professional, Windows XP Home Edition or Windows XP Professional standard installation is required.

However, operation is not assured if the above environment is an upgraded OS.

CPU: MMX Pentium 200 MHz or faster

The USB connector must be provided as standard.

Windows Media Player must be installed (to play back moving pictures).

Installing the USB driver

Before connecting your camcorder to your computer, install the USB driver on the computer. The USB driver is packaged together with application software for viewing images on the CD-ROM supplied with your camcorder.

If you installed the USB driver in “Viewing images recorded on tape on your computer” (p. 96), start from step 5.

For Windows XP users

The USB driver needs not be installed. Your computer is automatically recognized as a driver just by connecting your computer using the USB cable.

For Windows 98/98SE/Me, Windows 2000 Professional users

If you are using Windows 2000 Professional, log in with permission of administrator.

Start the following operation without connecting the USB cable to your computer.

Connect the USB cable in step 6.

If the USB driver has been registered incorrectly because your computer was connected to your camcorder before installation of the USB driver was completed. Reinstall the USB driver following the procedure on page 158.

- (1) Turn on the power of your computer and allow Windows to load.
- (2) Insert the supplied CD-ROM into the CD-ROM drive of your computer. The application software screen appears.

Viewing images recorded on “Memory Stick” s on your computer

- (3) Move the cursor to “USB Driver” and click. This starts USB driver installation.



- (4) Follow the on-screen messages to install the USB driver.
- (5) Insert a “Memory Stick” into your camcorder, connect the AC power adaptor and set the POWER switch to MEMORY.
- (6) Connect the Ψ (USB) jack on your camcorder with the USB connector on your computer using the supplied USB cable.
- USB MODE appears on the LCD screen of your camcorder. Your computer recognizes the camcorder, and the Windows Add Hardware Wizard starts.
- (7) Follow the on-screen messages to make the Add Hardware Wizard recognize the hardware. The Add Hardware Wizard starts two times because two different USB drivers are installed. Be sure to allow each installation to complete without interrupting them.

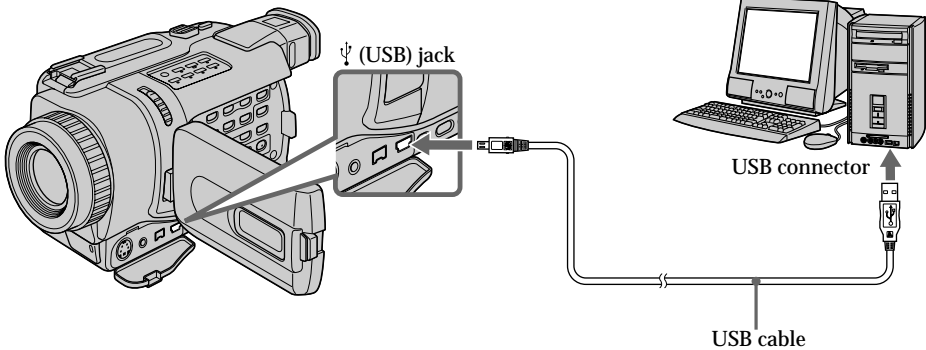

Note

You cannot install the USB driver if a “Memory Stick” is not in your camcorder. Be sure to insert a “Memory Stick” into your camcorder before installing the USB driver.

Viewing images recorded on “Memory Stick” s on your computer

If you cannot install the USB driver

The USB driver has been registered incorrectly as your computer was connected to your camcorder before installation of the USB driver was completed. Perform the following procedure to correctly install the USB driver.

Step1: Uninstall the incorrect USB driver

- ① Turn on your computer and allow Windows to load.
- ② Insert a “Memory Stick” into your camcorder.
- ③ Connect the AC power adaptor, and set the POWER switch to MEMORY.
- ④ Connect the USB connector on your computer to the Ψ (USB) jack on your camcorder using the USB cable supplied with your camcorder.
- ⑤ Open your computer’s “Device Manager”.

Windows 2000 Professional:

Select “My Computer” → “Control Panel” → “Hardware” tab, and click the “Device Manager” button.

Other OS:

Select “My Computer” → “Control Panel” → “System”, and click “Device Manager”.

- ⑥ Select “Other devices”.
Select the device prefixed with the “?” mark and delete.
Ex: (?)Sony Camcorder
- ⑦ Turn the POWER switch to OFF (CHG), and then disconnect the USB cable.
- ⑧ Restart your computer.

Step2: Install the USB driver on the CD-ROM

Perform the entire procedure described in “Installing the USB driver” on page 156.

Viewing images recorded on “Memory Stick” s on your computer

Viewing images on Windows

An application such as Windows Media Player must be installed to play back moving pictures in Windows environment.

- (1) Turn on your computer and allow Windows to load.
- (2) Insert a “Memory Stick” into your camcorder, and connect the AC power adaptor to your camcorder and then to a wall outlet.
- (3) Set the POWER switch to MEMORY.
- (4) Connect one end of the USB cable to the ψ (USB) jack on the camcorder and the other end to the USB connector on your computer.
USB MODE appears on the screen of your camcorder.
- (5) Open “My Computer” on Windows and double-click the newly recognized drive (Example: “Removable Disk (E:)”).
The folders inside the “Memory Stick” are displayed.
- (6) Select and double-click the desired image file from the folder.
For the detailed folder and file name, see “Image file storage destinations and image files” (p. 163).

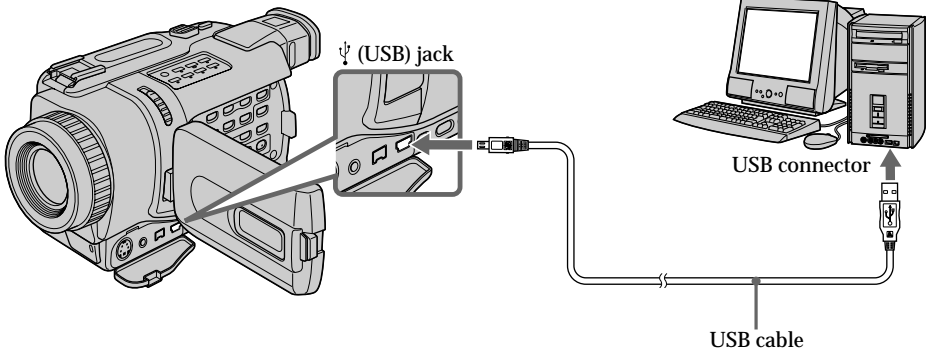

Desired file type	Double-click in this order
Still image	“Dcim” folder → “100msdcf” folder → Image file
Moving picture*	“Msson” folder → “Moml0001” folder → Image file*

* Copying a file to the hard disk of your computer before viewing it is recommended. If you play back the file directly from the “Memory Stick,” the image and sound may break off.

Unplug the USB cable or eject the “Memory Stick”

– For Windows 2000 Professional/Me, Windows XP users

To unplug the USB cable or eject the “Memory Stick,” follow the procedure below.

- (1) Move the cursor to the “Unplug or Eject Hardware” icon on the Task Tray and click to cancel the applicable drive.
- (2) A message to remove the device from the system appears, then unplug the USB cable or eject the “Memory Stick.”
- (3) Set the POWER switch of your camcorder to OFF(CHG).

For Macintosh users

Recommended Macintosh environment

Mac OS 8.5.1/8.6/9.0/9.1/9.2 or Mac OS X (v10.0/v10.1) standard installation is required.

However, note that the update to Mac OS 9.0/9.1 should be used for the following models.

- iMac with the Mac OS 8.6 standard installation and a slot loading type CD-ROM drive
- iBook or Power Mac G4 with the Mac OS 8.6 standard installation

The USB connector must be provided as standard.

Installing the USB driver

Before connecting your camcorder to your computer, install the USB driver on the computer. The USB driver is packaged together with application software for viewing images on the CD-ROM supplied with your camcorder. Do not connect the USB cable to your computer before installation of the USB driver is completed.

For Mac OS 9.1/9.2/Mac OS X (v10.0/v10.1)

The USB driver need not be installed. Your Mac is automatically recognized as a driver just by connecting your Mac using the USB cable.

For Mac OS 8.5.1/8.6/9.0 users

- (1) Turn on your computer and allow the Mac OS to load.
- (2) Insert the supplied CD-ROM into the CD-ROM drive of your computer.
The application software screen appears.



Viewing images recorded on “Memory Stick” s on your computer

- (3) Click “USB Driver” to open the folder containing the six files related to “Driver”.

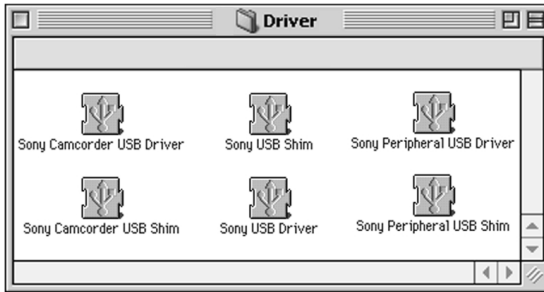

- (4) Select all six files, and drag and drop them into the System Folder.
- (5) When the message appears, click “OK.”
- (6) Restart your computer.

Viewing images recorded on “Memory Stick” s on your computer

Viewing images on Macintosh

QuickTime 3.0 or newer must be installed to play back moving pictures in Macintosh environment.

- (1) Turn on your computer and allow Mac OS to load.
- (2) Insert a “Memory Stick” into your camcorder, and connect the AC power adaptor to your camcorder and then to a wall outlet.
- (3) Set the POWER switch to MEMORY.
- (4) Connect one end of the USB cable to the Ψ (USB) jack on the camcorder and the other end to the USB connector on your computer.
USB MODE appears on the screen of your camcorder.
- (5) Double click the newly recognized icon on the desktop.
The folders inside the “Memory Stick” are displayed.
- (6) Select and double-click the desired image file from the folder.

Desired file type	Double-click in this order
Still image	“Dcim” folder → “100msdcf” folder → Image file
Moving picture*	“Mssony” folder → “Moml0001” folder → Image file*

* Copying a file to the hard disk of your computer before viewing it is recommended. If you play back the file directly from the “Memory Stick,” the image and sound may break off.

Unplug the USB cable or eject the “Memory Stick”

To unplug the USB cable or eject the “Memory Stick”, follow the procedure below.

- (1) Close all running applications.
Make sure that the access lamp of the hard disk is not lit.
- (2) Drag and drop the “Memory Stick” icon to the Trash or select Eject under the Special menu.
- (3) Unplug the USB cable or eject the “Memory Stick.” Set the POWER switch of your camcorder to OFF(CHG).

For Mac OS X (v10.0) users

Shutting down your computer, then unplug the USB cable or eject the “Memory Stick”.

Viewing images recorded on “Memory Stick” s on your computer

Notes on using your computer

“Memory Stick”

- “Memory Stick” operations on your camcorder cannot be assured if a “Memory Stick” formatted on your computer is used on your camcorder, or if the “Memory Stick” in your camcorder was formatted from your computer when the USB cable was connected.
- Do not compress the data on the “Memory Stick.” Compressed files cannot be played back on your camcorder.

Software

- Depending on your application software, the file size may increase when you open a still image file.
- When you load an image modified using retouching software from your computer to your camcorder or when you directly modify the image on your camcorder, the image format will differ so a file error indicator may appear and you may be unable to open the file.

Communications with your computer

Communications between your camcorder and your computer may not recover after recovering from Suspend, Resume, or Sleep.

Image file storage destinations and image files

Image files recorded with your camcorder are grouped in folders by recording mode. The meanings of the file names are as follows. □□□□ stands for any number within the range from 0001 to 9999.

For Windows Me users

(The drive recognizing your camcorder is [E:].)

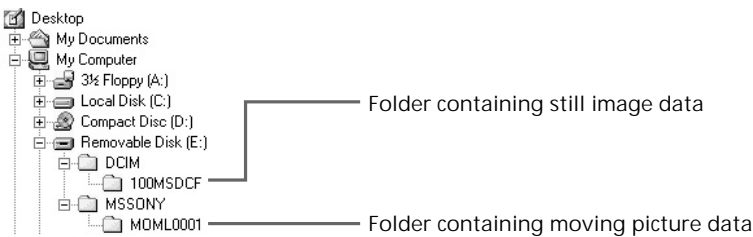

Folder	File	Meaning
100MSDCF	DSC0□□□□.JPG	Still image file
MOML0001	MOV0□□□□.MPG	Moving picture file

Copying images recorded on "Memory Stick"s to tape

- Except DCR-TRV240

You can copy still images recorded on "Memory Stick"s and record them to tapes.

Before operation

- Insert a tape for recording into your camcorder.
- Insert a "Memory Stick" into your camcorder.

- (1) Set the POWER switch to VCR.
- (2) Using the video control buttons, search a point where you want to record the desired still image. Set the tape to playback pause mode.
- (3) Press ● REC and the button on its right simultaneously on your camcorder. The tape is set to the recording pause mode.
- (4) Press MEMORY PLAY. The last recorded image is displayed.
- (5) Press MEMORY+/- to select the desired image.
To see the previous image, press MEMORY-. To see the next image, press MEMORY+.
- (6) Press ■ to start recording and press ■ again to stop.
● appears on the screen during recording.
- (7) If you have more to copy, repeat steps 4 to 6.

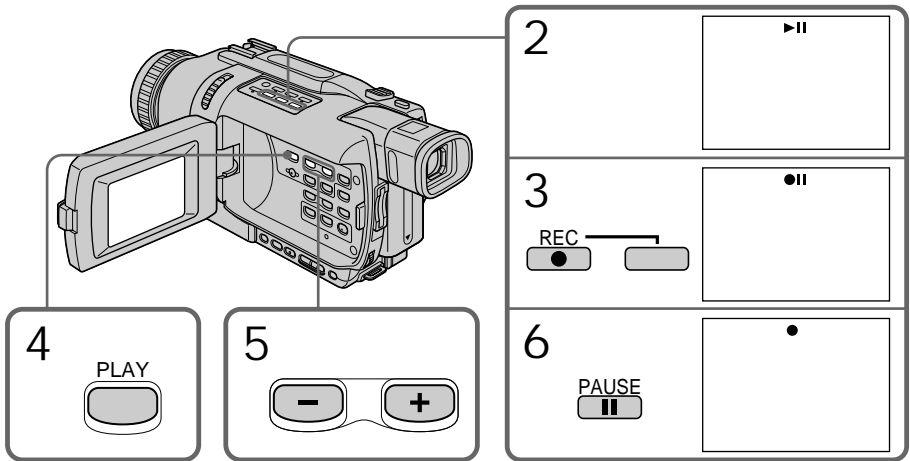

To stop copying
Press ■.

Copying images recorded on "Memory Stick" s to tape

During copying

You cannot operate the following buttons:

- MEMORY PLAY
- MEMORY INDEX
- MEMORY DELETE
- MEMORY MIX
- MEMORY +/-

Note on the index screen

You cannot record the index screen.

If you press EDITSEARCH during pause mode

Memory playback stops.

Image data modified on your computer or shot with other equipment

You may not be able to copy modified images with your camcorder.

If you press DISPLAY in the standby or recording mode

You can see memory playback and the file name indicators in addition to the indicators pertinent to tapes, such as the time code indicator.

Enlarging still images recorded on "Memory Stick" s – Memory PB ZOOM

– Except DCR-TRV240

You can enlarge still images recorded on a "Memory Stick." You can select and view a desired part from the enlarged still image. Also, you can copy the desired part of the enlarged still image to tapes or "Memory Stick" s.

Before operation

Insert a "Memory Stick" into your camcorder.

- (1) Set the POWER switch to MEMORY or VCR. Make sure that the LOCK switch is set to the left (unlock) position.
- (2) Press PB ZOOM on your camcorder while you are playing back images recorded on "Memory Stick." The still image is enlarged, and \uparrow / \downarrow indicators showing the direction to move the image appear on the screen.
- (3) Turn SEL/PUSH EXEC dial to move the enlarged image, then press the dial.
 - \uparrow : The image moves downward.
 - \downarrow : The image moves upward.
 - \leftarrow \rightarrow becomes available.
- (4) Turn SEL/PUSH EXEC dial to move the enlarged image, then press the dial.
 - \leftarrow : The image moves rightward. (Turn the dial downward.)
 - \rightarrow : The image moves leftward. (Turn the dial upward.)
- (5) Adjust the zoom ratio by the power zoom lever.

You can enlarge the image from 1.1 times up to five times its size.

W : Decreases the zoom ratio.

T : Increase the zoom ratio.

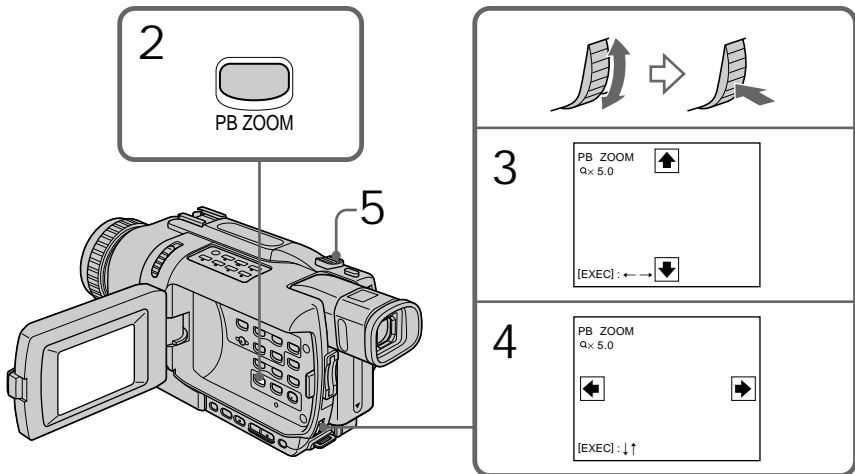

Enlarging still images recorded on "Memory Stick"s - Memory PB ZOOM

To cancel memory PB ZOOM mode

Press PB ZOOM.

The PB ZOOM mode is canceled when the following buttons are pressed:

- MENU
- MEMORY PLAY
- MEMORY INDEX
- MEMORY +/-

Moving pictures recorded on "Memory Stick"s

The PB ZOOM mode does not work.

To record an image processed by PB ZOOM on "Memory Stick"s

Press PHOTO to record the image processed by PB ZOOM.

To record an image processed by PB ZOOM on tape

Press REC to record the image processed by Memory PB ZOOM.

Playing back images in a continuous loop – SLIDE SHOW

– Except DCR-TRV240

You can automatically play back images in sequence. This function is useful especially when checking recorded images or during a presentation.

Before operation

Insert a “Memory Stick” into your camcorder.

- (1) Set the POWER switch to MEMORY. Make sure that the LOCK switch is set to the left (unlock) position.
- (2) Press MENU to display the menu settings.
- (3) Turn the SEL/PUSH EXEC dial to select SLIDE SHOW in , then press the dial.
- (4) Press MEMORY PLAY. Your camcorder plays back the images recorded on the “Memory Stick” in sequence.

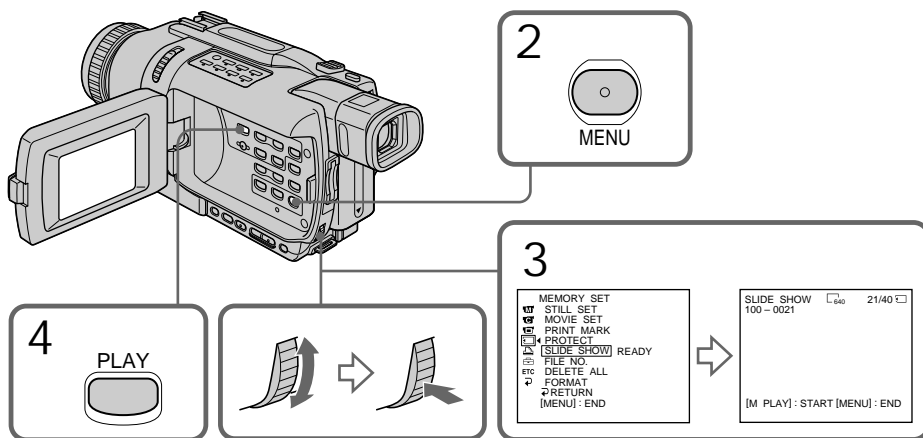

To stop the slide show

Press MENU.

To pause during a slide show

Press MEMORY PLAY.

To start the slide show from a particular image

Select the desired image using MEMORY +/- buttons before step 2.

Playing back images in a continuous loop – SLIDE SHOW

To view recorded images on TV

Before operation, connect your camcorder to a TV with the A/V connecting cable supplied with your camcorder.

If you change the “Memory Stick” during operation

The slide show function does not operate. If you change the “Memory Stick”, be sure to follow the steps again from the beginning.



Preventing accidental erasure – Image protection

– Except DCR-TRV240

You can protect selected images, to prevent accidental erasure of important images.

Before operation

Insert a “Memory Stick” into your camcorder.

- (1) Set the POWER switch to MEMORY or VCR. Make sure that the LOCK switch is set to the left (unlock) position.
- (2) Play back the image you want to protect.
- (3) Press MENU to display the menu settings.
- (4) Turn the SEL/PUSH EXEC dial to select PROTECT in , then press the dial.
- (5) Turn the SEL/PUSH EXEC dial to select ON, then press the dial.
- (6) Press MENU to make the menu settings disappear. The  mark is displayed beside the data file name of the protected image.

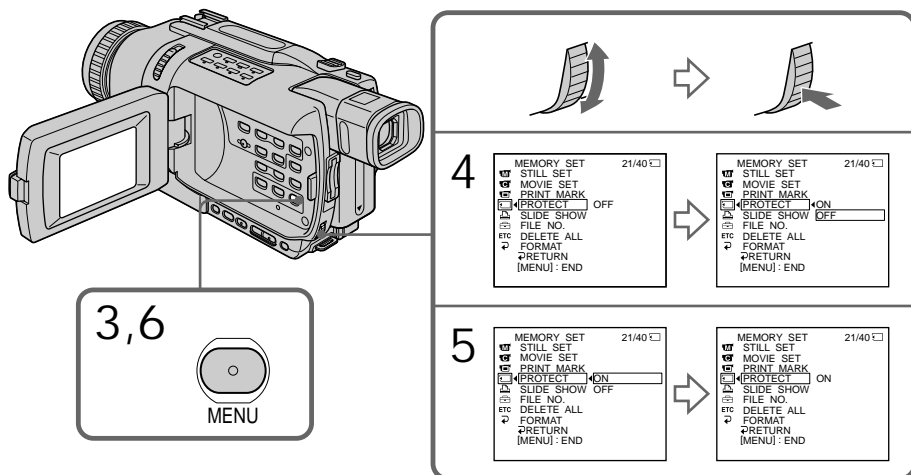

To cancel image protection

Select OFF in step 5, then press the SEL/PUSH EXEC dial.

Note

Formatting erases all information on the “Memory Stick”, including the protected image data. Before formatting a “Memory Stick”, check its contents.

If the write-protect tab on the “Memory Stick” is set to LOCK

You cannot protect images.

Deleting images – DELETE

– Except DCR-TRV240

You can delete images stored in a “Memory Stick.” You can delete all images or only selected images.

Deleting selected images

Before operation

Insert a “Memory Stick” into your camcorder.

- (1) Set the POWER switch to MEMORY or VCR. Make sure that the LOCK switch is set to the left (unlock) position.
- (2) Play back the image you want to delete.
- (3) Press MEMORY DELETE. “DELETE?” appears on the screen.
- (4) Press MEMORY DELETE again. The selected image is deleted.

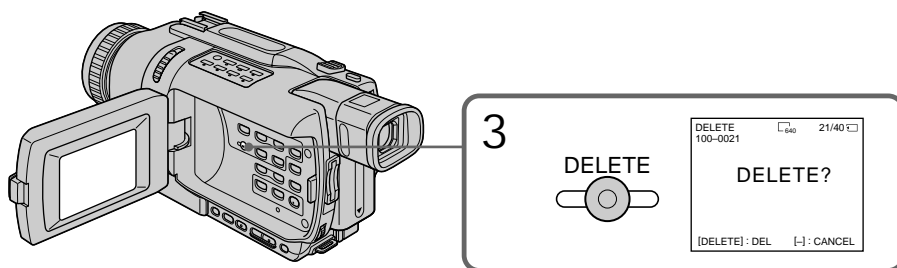

To cancel deleting an image

Press MEMORY – in step 4.

To delete an image displayed on the index screen

Press MEMORY +/- to move the ► indicator to the image and follow steps 3 and 4.

Notes

- You cannot delete a protected image. To delete a protected image, first cancel image protection.
- Once you delete an image, you cannot restore it. Before deleting an image, carefully check the image.

If the write-protect tab on the “Memory Stick” is set to LOCK

You cannot delete images.

Deleting all images

You can delete all unprotected images in the “Memory Stick.”

Before operation

Insert a “Memory Stick” into your camcorder.

- (1) Set the POWER switch to MEMORY. Make sure that the LOCK switch is set to the left (unlock) position.
- (2) Press MENU to display the menu settings.
- (3) Turn the SEL/PUSH EXEC dial to select DELETE ALL in , then press the dial.
- (4) Turn the SEL/PUSH EXEC dial to select OK, then press the dial. OK changes to EXECUTE.
- (5) Turn the SEL/PUSH EXEC dial to select EXECUTE, then press the dial. DELETING appears on the screen. When all unprotected images are deleted, COMPLETE is displayed.

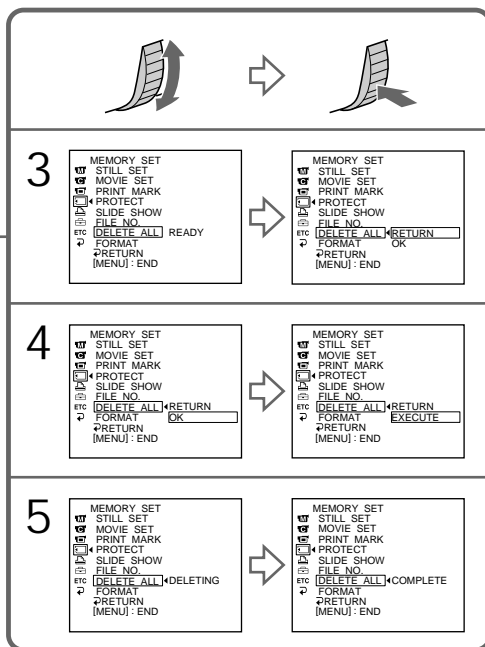
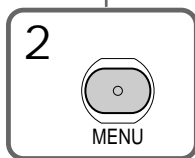
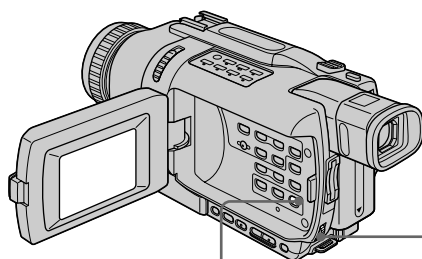

Deleting images – DELETE

To cancel deleting all the images in the “Memory Stick”
Select RETURN in step 4, then press the SEL/PUSH EXEC.

While DELETING appears

Do not turn the POWER switch or press any buttons.

If the write-protect tab on the “Memory Stick” is set to LOCK
You cannot delete images.

Writing a print mark – PRINT MARK



– Except DCR-TRV240

You can specify a recorded still image to print out by writing a print mark. This function is useful for printing out still images later.

Your camcorder conforms to the DPOF (Digital Print Order Format) standard for specifying still images to print out.

Before operation

Insert a “Memory Stick” into your camcorder.

- (1) Set the POWER switch to MEMORY or VCR. Make sure that the LOCK switch is set to the left (unlock) position.
- (2) Play back the still image you want to write a print mark on.
- (3) Press MENU to display the menu settings.
- (4) Turn the SEL/PUSH EXEC dial to select PRINT MARK in , then press the dial.
- (5) Turn the SEL/PUSH EXEC dial to select ON, then press the dial.
- (6) Press MENU to make the menu settings disappear. The  mark is displayed beside the data file name of the image with a print mark.

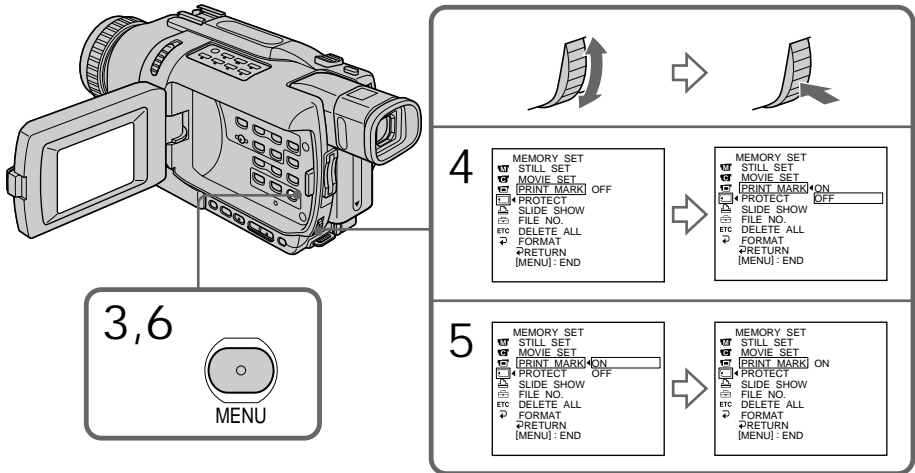

To cancel writing of print marks

Select OFF in step 5, then press the SEL/PUSH EXEC dial.

Writing a print mark – PRINT MARK

If the write-protect tab on the “Memory Stick” is set to LOCK
You cannot write print marks on still images.

Moving pictures

You cannot write print marks on moving pictures.

While the file name is flashing

You cannot write the print mark on the still image.

Using the optional printer

– Except DCR-TRV240

You can use the printer (optional) on your camcorder to print images on print paper.

For details, refer to the operating instructions of the printer.

There are various ways of printing still images. The following, however, describes how to print by selecting  in the menu settings on your camcorder. (p. 105)

Before operation

- Insert a recorded “Memory Stick” into your camcorder.
- Attach the optional printer to your camcorder.

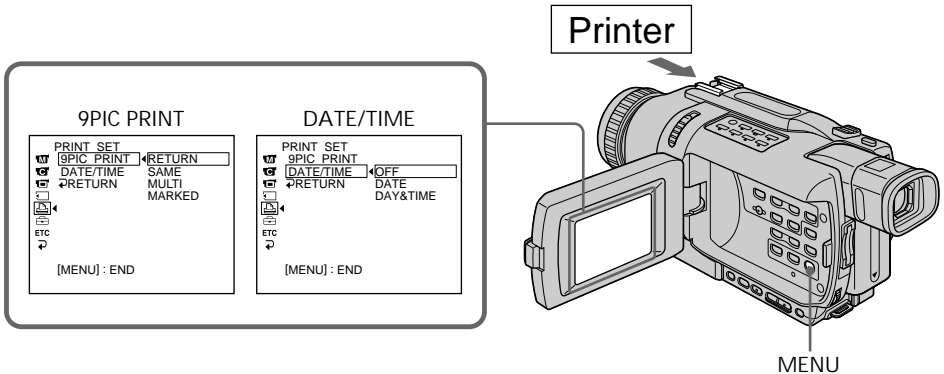

You can print nine still images on the 9-split print paper. Select the desired mode in the menu settings.

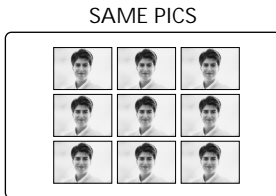

* Nine still images with print marks are printed together.

You can make prints with the recording date and/or recording time. Select the desired mode in the menu settings.

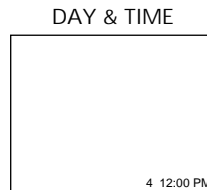
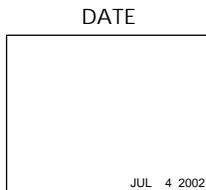

Using the optional printer

Images recorded in the multi screen mode

You cannot print images recorded in the multi screen mode on sticker type print paper.

Moving pictures recorded on "Memory Stick"

You cannot print moving pictures.

When "Memory Stick" has no files

" NO STILL IMAGE FILE" appears on the screen.

When there are no files with a PRINT MARK

" NO PRINT MARK" appears on the screen.

Types of trouble and how to correct trouble

If you run into any problem using your camcorder, use the following table to troubleshoot the problem. If the problem persists, disconnect the power source and contact your Sony dealer or local authorized Sony service facility. If “C:□□:□□” appears on the screen or the display window, the self-diagnosis display function has worked. See page 184.

In the recording mode

Symptom	Cause and/or Corrective Actions
START/STOP does not operate.	<ul style="list-style-type: none"> • The POWER switch is not set to CAMERA. → Set it to CAMERA (p. 21). • The tape has run out. → Rewind the cassette or insert a new one (p. 20, 34). • The write-protect tab is set to expose the red mark. → Use a new tape or slide the tab (p. 20). • The tape is stuck to the drum (moisture condensation). → Remove the cassette and leave your camcorder for at least one hour to acclimatize (p. 194).
The power goes off.	<ul style="list-style-type: none"> • While being operated in CAMERA mode, your camcorder has been in the standby mode for more than three minutes. → Set the POWER switch to OFF (CHG) and then to CAMERA again (p. 21). • The battery pack is dead or nearly dead. → Install a charged battery pack (p. 12, 13).
The image on the viewfinder screen is not clear.	<ul style="list-style-type: none"> • The viewfinder lens is not adjusted. → Adjust the viewfinder lens (p. 25).
The SteadyShot function does not work.	<ul style="list-style-type: none"> • STEADYSHOT is set to OFF in the menu settings. → Set it to ON (p. 105). • 16:9WIDE is set to ON in the menu settings. → Set it to OFF (p. 105) (DCR-TRV240/TRV340 only).
The autofocus function does not work.	<ul style="list-style-type: none"> • The setting is the manual focus mode. → Set FOCUS to the autofocus mode (p. 54). • Shooting conditions are not suitable for autofocus. → Adjust for manual focusing (p. 54).
The picture does not appear in the viewfinder.	<ul style="list-style-type: none"> • The LCD panel is open. → Close the LCD panel (p. 23).
A vertical band appears when you shoot a subject such as lights or a candle flame against a dark background.	<ul style="list-style-type: none"> • The contrast between the subject and background is too high. This is not a malfunction.
A vertical band appears when you shoot a very bright subject.	<ul style="list-style-type: none"> • This is not a malfunction.
Some tiny white spots appear on the screen.	<ul style="list-style-type: none"> • Slow shutter, Super NightShot or Color Slow Shutter mode is activated. This is not a malfunction.
You cannot record still images on tapes	<ul style="list-style-type: none"> • PHOTO REC is set to MEMORY in the menu settings. → Set it to TAPE (p. 105) (except DCR-TRV240)

Types of trouble and how to correct trouble



Symptom	Cause and/or Corrective Actions
An unknown picture is displayed on the screen.	<ul style="list-style-type: none"> • If 10 minutes elapse after you set the POWER switch to CAMERA or DEMO MODE is set to ON in the menu settings without a cassette inserted, your camcorder automatically starts the demonstration. → Insert a cassette and the demonstration stops. You can also cancel DEMO MODE (p. 105).
The picture is recorded in incorrect or unnatural colors.	<ul style="list-style-type: none"> • NIGHTSHOT is set to ON. → Set it to OFF (p. 29).
Picture appears too bright, and the subject does not appear on the screen.	<ul style="list-style-type: none"> • NIGHTSHOT is set to ON in a bright place. → Set it to OFF (p. 29). • The backlight function is active. → Set it off (p. 28).
The shutter does not sound.	<ul style="list-style-type: none"> • BEEP is set to OFF in the menu settings. → Set it to MELODY or NORMAL (p. 105).
A horizontal black band appears when shooting a TV screen or a computer screen.	<ul style="list-style-type: none"> • Set STEADYSHOT to OFF in the menu setting (p. 105).
An external flash (optional) does not work.	<ul style="list-style-type: none"> • The power of the external flash is off or the power source does not installed. → Turn on the external flash or install the power source. • Two or more external flashes are attached. → Only one external flash can be attached. • AUTO is selected in FLASH MODE in the menu settings while recording in a bright place. → Set it to ON (p. 105).

In the playback mode

Symptom	Cause and/or Corrective Actions
The tape does not move when a video control button is pressed.	<ul style="list-style-type: none"> • The POWER switch is not set to VCR. → Set it to VCR (p. 34).
The playback button does not work.	<ul style="list-style-type: none"> • The cassette has run out of tape. → Rewind the tape (p. 34).
There are horizontal lines on the picture, or the playback picture is not clear or does not appear.	<ul style="list-style-type: none"> • The video heads may be dirty. → Clean the heads using the Sony V8-25CLD cleaning cassette (optional) (p. 195).
No sound or only a low sound is heard when playing back a tape.	<ul style="list-style-type: none"> • The stereo tape is played back with HiFi SOUND set to 2 in the menu settings. → Set it to STEREO (p. 105). • The volume is turned to minimum. → Press VOLUME + (p. 34). • AUDIO MIX is set to the ST2 side in the menu settings. → Adjust AUDIO MIX (p. 105).
The date search does not work correctly.	<ul style="list-style-type: none"> • The tape has a blank portion between recorded portion (p. 68).
The picture which is recorded in the Digital8 system is not played back.	<ul style="list-style-type: none"> • PB MODE is set to Hi8/8 in the menu settings. → Set it to AUTO (p. 105).
The tape which is recorded in the Hi8 /standard 8 system is not played back correctly.	<ul style="list-style-type: none"> • Set PB MODE to Hi8/8 in the menu settings (p. 105).

Types of trouble and how to correct trouble

In the recording and playback modes

Symptom	Cause and/or Corrective Actions
The power does not turn on.	<ul style="list-style-type: none">• The battery pack is not installed, or is dead or nearly dead. → Install a charged battery pack (p. 12, 13).• The AC power adaptor is not connected to a wall outlet. → Connect the AC power adaptor to a wall outlet (p. 17).
The end search function does not work.	<ul style="list-style-type: none">• The tape was ejected after recording.• You have not recorded on the new cassette yet.
The end search function does not work correctly.	<ul style="list-style-type: none">• The tape has a blank portion at the beginning or midway.
The battery pack is quickly discharged.	<ul style="list-style-type: none">• The operating temperature is too low.• The battery pack is not charged enough. → Charge the battery pack fully again (p. 13).• The battery pack is completely dead, and cannot be recharged. → Replace with a new battery pack (p. 12).
The remaining battery time indicator does not indicate the correct time.	<ul style="list-style-type: none">• You have used the battery pack in an extremely hot or cold environment for a long time.• The battery pack is completely dead, and cannot be recharged. → Replace with a new battery pack (p. 12).• The battery is dead. → Use a fully charged battery pack (p. 12, 13).• A deviation has occurred in the remaining battery time. → Charge the battery pack fully so that the remaining battery time indicator indicates correct time (p. 13).
The power goes off although the remaining battery time indicator indicates that the battery pack has enough power to operate.	<ul style="list-style-type: none">• A deviation has occurred in the remaining battery time. → Charge the battery pack fully so that the remaining battery time indicator indicates correct time (p. 13).
The cassette cannot be removed from the holder.	<ul style="list-style-type: none">• The power source is disconnected. → Connect it firmly (p. 12, 17).• The battery is dead. → Use a charged battery pack (p. 12, 13).
The  and  indicators flash and no functions except for cassette ejection work.	<ul style="list-style-type: none">• Moisture condensation has occurred. → Remove the cassette and leave your camcorder for at least one hour to acclimatize (p. 194).

Types of trouble and how to correct trouble

When operating using the "Memory Stick"

– Except DCR-TRV240

Symptom	Cause and/or Corrective Actions
The "Memory Stick" does not function.	<ul style="list-style-type: none">• The POWER switch is not set to MEMORY. → Set it to MEMORY (p. 124).• The "Memory Stick" is not inserted. → Insert a "Memory Stick" (p. 118).
Recording does not function.	<ul style="list-style-type: none">• The "Memory Stick" is full. → Delete unnecessary images and record again (p. 171).• The "Memory Stick" formatted incorrectly is inserted. → Format the "Memory Stick" on your camcorder or use another "Memory Stick" (p. 111, 118).• The write-protect tab on the "Memory Stick" is set to LOCK. → Release the lock (p. 116).
The image cannot be deleted.	<ul style="list-style-type: none">• The image is protected. → Cancel image protection (p. 170).• The write-protect tab on the "Memory Stick" is set to LOCK. → Release the lock (p. 116).
You cannot format the "Memory Stick".	<ul style="list-style-type: none">• The write-protect tab on the "Memory Stick" is set to LOCK. → Release the lock (p. 116).
Deleting all the images cannot be carried out.	<ul style="list-style-type: none">• The write-protect tab on the "Memory Stick" is set to LOCK. → Release the lock (p. 116).
You cannot protect the image.	<ul style="list-style-type: none">• The write-protect tab on the "Memory Stick" is set to LOCK. → Release the lock (p. 116).• The image to protect is not played back. → Press MEMORY PLAY to play back the image (p. 150).
You cannot write a print mark on the still image.	<ul style="list-style-type: none">• The write-protect tab on the "Memory Stick" is set to LOCK. → Release the lock (p. 116).• The image to write a print mark to is not played back. → Press MEMORY PLAY to play back the image (p. 150).• You are trying to write a print mark on a moving picture. → Print marks cannot be written on a moving picture.
The photo save function does not work.	<ul style="list-style-type: none">• The write-protect tab on the "Memory Stick" is set to LOCK. → Release the lock (p. 116).
You cannot record still images on "Memory Stick"s while in the standby mode or while moving pictures are being recorded to tape	<ul style="list-style-type: none">• PHOTO REC is set to TAPE in the menu settings. → Set it to MEMORY (p. 105)

(continued on the following page)

Types of trouble and how to correct trouble

Others

Symptom	Cause and/or Corrective Actions
Digital program editing to a tape does not function.	<ul style="list-style-type: none">• The input selector on the VCR is not set correctly. → Check the connection and set the input selector on the VCR again (p. 75)• Your camcorder is connected to DV equipment of other than Sony using the i.LINK cable (DV connecting cable). → Set it to IR (p. 75).• You have attempted to set a program on a blank portion of the tape. → Set the program again on a recorded portion (p. 84).• Your camcorder and the VCR are not synchronized. → Adjust the synchronization (p. 82).• The IR SETUP code is incorrect. → Set the correct code (p. 77).• PB MODE is set to Hi / Lo in the menu settings. → Set it to AUTO. (p. 105)
Digital program editing to a "Memory Stick" does not function. (except DCR-TRV240)	<ul style="list-style-type: none">• Setting program on a blank portion of the tape is attempted. → Set the program again on a recorded portion (p. 146).
The Remote Commander supplied with your camcorder does not work.	<ul style="list-style-type: none">• COMMANDER is set to OFF in the menu settings. → Set it to ON (p. 105).• Something is blocking the infrared rays. → Remove the obstacle.• The batteries are inserted with + and - incorrectly matching + and - inside the battery compartment. → Insert the batteries correctly (p. 207).• The batteries are dead. → Insert new ones (p. 207).
The picture from a TV or VCR does not appear on the screen even when your camcorder is connected to outputs on the TV or VCR.	<ul style="list-style-type: none">• DISPLAY is set to V-OUT/LCD in the menu settings. → Set it to LCD (p. 105).
The melody or beep sounds for five seconds.	<ul style="list-style-type: none">• Moisture condensation has occurred. → Remove the cassette and leave your camcorder for at least one hour to acclimatize (p. 194).• Some trouble have occurred in your camcorder. → Remove the cassette and insert it again, then operate your camcorder.
You cannot charge the battery pack.	<ul style="list-style-type: none">• The POWER switch is not set to OFF (CHG). → Set it to OFF (CHG).
While charging the battery pack, the backlight of the display window does not light.	<ul style="list-style-type: none">• Charging is completed.• The AC power adaptor is disconnected. → Connect it firmly (p. 13).• Something is wrong with the battery pack. → Contact your Sony dealer or local authorized Sony service facility.

Types of trouble and how to correct trouble

Others

Symptom	Cause and/or Corrective Actions
While charging the battery pack, the remaining battery time indicator flashes.	<ul style="list-style-type: none">• The battery pack is not properly installed. → Install it properly.• Something is wrong with the battery pack. → Contact your Sony dealer or local authorized Sony service facility.
No function works though the power is on.	<ul style="list-style-type: none">• Disconnect the power cord of the AC power adaptor or remove the battery, then reconnect it in about one minute. Turn the power on. If the functions still do not work, open the LCD panel and press the RESET button under TITLE button using a sharp-pointed object (If you press the RESET button, all the settings including the date and time return to their defaults.) (p. 203).
Image data cannot be transferred by the USB connection.	<ul style="list-style-type: none">• The USB cable was connected before installation of the USB driver was completed. → Uninstall the incorrect USB driver and re-install the USB driver (p. 97, 158).

Self-diagnosis display

Your camcorder has a self-diagnosis display function.

This function displays the current state of your camcorder as a 5-digit code (a combination of a letter and figures) on the screen or in the display window.

If a 5-digit code is displayed, check the following list of codes. The last two digits (indicated by □□) differ depending on the state of your camcorder.

LCD screen, viewfinder or display window

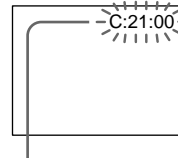

Self-diagnosis display

- C:□□:□□

You can service your camcorder yourself.

- E:□□:□□

Contact your Sony dealer or local authorized Sony facility.

Five-digit display	Cause and/or Corrective Actions
C:04:□□	<ul style="list-style-type: none"> • You are using a battery pack that is not an "InfoLITHIUM" battery pack. → Use an "InfoLITHIUM" battery pack (p. 14, 189).
C:21:□□	<ul style="list-style-type: none"> • Moisture condensation has occurred. → Remove the cassette and leave your camcorder for at least one hour to acclimatize (p. 194).
C:22:□□	<ul style="list-style-type: none"> • The video heads are dirty. → Clean the heads using the Sony V8-25CLD cleaning cassette (optional) (p. 195).
C:31:□□ C:32:□□	<ul style="list-style-type: none"> • A malfunction other than the above that you can service has occurred. → Remove the cassette and insert it again, then operate your camcorder. → Disconnect the power cord of the AC power adaptor or remove the battery pack. After reconnecting the power source, operate your camcorder.
E:20:□□ E:61:□□ E:62:□□	<ul style="list-style-type: none"> • A malfunction that you cannot service has occurred. → Contact your Sony dealer or local authorized Sony service facility and inform them of the 5-digit code. (example: E:61:10)

If you are unable to rectify the problem even if you try corrective actions a few times, contact your Sony dealer or local authorized Sony service facility.

Warning indicators and messages

If indicators and messages appear on the screen or in the display window, check the following.

See the page in parentheses “()” for more information.

Warning indicators

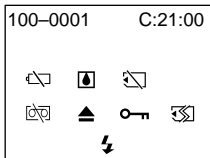

100-0001 Warning indicator as to file
(except DCR-TRV240)

Slow flashing:

- The file is corrupted.
- The file is unreadable.
- You are trying to use the MEMORY MIX function on a moving picture (p. 131).

C:21:00 Self-diagnosis display (p. 184).

⚡ Warning indicator as to battery

Slow flashing:

- The battery is nearly dead.
The ⚡ indicator sometimes flashes even if the remaining battery time is about five to 10 minutes depending on the operating conditions, environment and battery condition.

Fast flashing:

- The battery is dead.

☁ Moisture condensation has occurred*

Fast flashing:

- Eject the cassette, turn off your camcorder, and leave it for about one hour with the cassette compartment open (p. 194).

⊞ Warning indicator as to “Memory Stick”* (except DCR-TRV240)

Slow flashing:

- No “Memory Stick” is inserted.

⊞ Warning indicator as to “Memory Stick” formatting (except DCR-TRV240)

Fast flashing:

- “Memory Stick” data is corrupted (p. 116).*
- “Memory Stick” is not formatted correctly (p. 111).

⊞ Warning indicator as to tape

Slow flashing:

- The tape is near the end.
- No tape is inserted.*
- The write-protect tab on the cassette is exposed (red) (p. 20).*

Fast flashing:

- The cassette has run out of tape.*

▲ You need to eject the cassette*

Slow flashing:

- The write-protect tab on the cassette is exposed (red) (p. 20).

Fast flashing:

- Moisture condensation has occurred (p. 194).
- The cassette has run out of tape.
- The self-diagnosis display function is activated (p. 184).

⊞ The image is protected*
(except DCR-TRV240)

Slow flashing:

- The image is protected (p. 170).





















⚡ Warning indicator as to the flash (optional)

Fast flashing:

- There is something wrong with the external flash (optional).

* You hear the melody or beep.

Warning messages



- **CLOCK SET** Set the date and time (p. 18).
- **FOR “InfoLITHIUM” BATTERY ONLY** Use an “InfoLITHIUM” battery pack (p. 189).
-  **TAPE END** The cassette has run out of tape.*
-  **NO TAPE** Insert a cassette tape.*
-  **CLEANING CASSETTE** The video heads are dirty. (The  indicator and “ CLEANING CASSETTE” message appear one after another on the screen.) (p. 195)
- **COPY INHIBIT** You tried to record a picture that has a copyright control signal* (p. 187).
-  **FULL**** The “Memory Stick” is full* (p. 127).
-   **LOCK**** The write-protect tab on the “Memory Stick” is set to LOCK* (p. 116).
-  **NO FILE**** No still image is recorded on the “Memory Stick”* (p. 151).
-  **NO MEMORY STICK**** No “Memory Stick” is inserted.*
-  **AUDIO ERROR**** You are trying to record an image with sound that cannot be recorded by your camcorder on “Memory Stick”* (p. 143).
-  **MEMORY STICK ERROR**** The “Memory Stick” data is corrupted* (p. 118).
-  **FORMAT ERROR**** Check the type of formatting* (p. 111).
-   **DIRECTORY ERROR**** The “Memory Stick” has more than one directory such as 100msdcf* (p. 150).
-  **PLAY ERROR**** The image cannot be played back. Reinsert the “Memory Stick”, then playback the image again.
-  **REC ERROR**** Check the input signal before retrying recording* (p. 137, 145).
-  **NO PRINT MARK**** You selected MARKED in 9PIC PRINT in the menu settings using a “Memory Stick” contains no image with a print mark* (p. 177).
-  **NO STILL IMAGE FILE**** You selected MULTI in 9PIC PRINT in the menu settings using a “Memory Stick” contains no still image* (p. 177).
- **DELETING**** You have pressed PHOTO during deleting all images on “Memory Stick.”*
- **FORMATTING**** You have pressed PHOTO during formatting a “Memory Stick.”*
-  **NOW CHARGING** Charging an external flash (optional) does not work correctly.*

* You hear the melody or beep.

** Except DCR-TRV240





Digital8 system, recording and playback



What is the “Digital8 system”?

This video system has been developed to enable digital recording to Hi8 /Digital8  video cassette.



Usable cassette tapes

We recommend using Hi8 /Digital8  video cassette.*

The recording time when you use your Digital8  system camcorder on Hi8 /standard 8  tape is half the recording time when using the conventional Hi8 /standard 8  system camcorder. (120 minutes of recording time becomes 60 minutes in the SP mode.)

* If you use standard 8  tape, be sure to play back the tape on this camcorder. Mosaic pattern noise may appear when you play back standard 8  tape on other VCRs (including other DCR-TRV240/TRV340/TRV740/TRV840).

Note



Tapes recorded in the Digital8  system cannot be played back on Hi8 /standard 8  (analog) system machine.



 is a trademark.

 is a trademark.



 is a trademark.







Playback system







The Digital8  system or Hi8 /standard 8  system is automatically detected before the tape is played back.

During playback of tapes recorded in the Hi8 /standard 8  system, digital signals are output as the image signals from the  DV IN/OUT jack.

Display during automatic detection of system

The Digital8  system or Hi8 /standard 8  system is automatically detected, and the playback system is automatically switched to. During switching of systems, the screen turns blue, and the following displays appear on the screen. A hissing noise also sometimes can be heard.

 → /: During switching from Digital8  to Hi8 /standard 8 

/ → : During switching from Hi8 /standard 8  to Digital8 

Copyright signal

When you play back

Using any other video camera recorder, you cannot record on a tape that has recorded copyright control signals for copyright protection of software which is played back on your camcorder.

When you record

You cannot record software on your camcorder that contains copyright control signals for copyright protection of software.

COPY INHIBIT appears on the LCD screen, in the viewfinder or on the TV screen if you try to record such software. Your camcorder does not record copyright control signals on the tape when it records.

When you playback a dual sound track tape

When you use tapes recorded in the Digital8  system

When you play back a Digital8  system tape which is dubbed from a dual sound track tape recorded in the DV system, set HiFi SOUND to the desired mode in the menu settings (p. 105).

Sound from speaker

HiFi Sound Mode	Playing back a stereo tape	Playing back a dual sound track tape
STEREO	Stereo	Main sound and sub sound
1	Lch	Main sound
2	Rch	Sub sound

When you use a tape recorded in the Hi8/standard 8 system

When you play back a dual sound track tape recorded in an AFM HiFi stereo system, set HiFi SOUND to the desired mode in the menu settings (p. 105).

Sound from speaker

HiFi Sound Mode	Playing back a stereo tape	Playing back a dual sound track tape
STEREO	Stereo	Main sound and sub sound
1	Monaural	Main sound
2	Unnatural Sound	Sub sound

You cannot record dual sound programs on your camcorder.

About the “InfoLITHIUM” battery pack

What is the “InfoLITHIUM” battery pack?

The “InfoLITHIUM” battery pack is a lithium-ion battery pack that has functions for communicating information related to operating conditions between your camcorder and an AC adaptor/charger (optional).

The “InfoLITHIUM” battery pack calculates the power consumption according to the operating conditions of your camcorder, and displays the remaining battery time in minutes.

Charging the battery pack

- Be sure to charge the battery pack before you start using your camcorder.
- We recommend charging the battery pack in an ambient temperature of between 10°C to 30°C (50°F to 86°F) until the backlight of the display window goes out, indicating that the battery pack is fully charged. If you charge the battery outside of this temperature range, you may not be able to efficiently charge the battery pack.
- After charging is completed, either disconnect the cable from the DC IN jack on your camcorder or remove the battery pack.

Effective use of the battery pack

- Battery pack performance decreases in low-temperature surroundings. So, the time that the battery pack can be used is shorter in cold places. We recommend the following to ensure longer battery pack use:
 - Put the battery pack in a pocket to warm it up, and insert it in your camcorder immediately before you start taking shots.
 - Use the large-capacity battery pack (NP-FM70/QM71/FM90/FM91/QM91, optional).
- Frequently using the LCD panel or frequently operating playback, fast-forward or rewind wears out the battery pack faster. We recommend using the large-capacity battery pack (NP-FM70/QM71/FM90/FM91/QM91, optional).
- Be sure to turn the POWER switch to OFF (CHG) when not taking shots or playing back on your camcorder. The battery pack is also consumed when your camcorder is in the standby mode or playback is paused.
- Have spare battery packs handy for two or three times the expected recording time, and make a trial recordings before taking the actual recording.
- Do not expose the battery pack to water. The battery pack is not water-resistant.

Remaining battery time indicator

- If the power may go off although the remaining battery time indicator indicates that the battery pack has enough power to operate, charge the battery pack fully again so that the indication on the remaining battery time indicator is correct. Note, however, that the correct battery indication sometimes will not be restored if it is used in high temperatures for a long time or left in a fully charged state, or the battery pack is frequently used. Regard the remaining battery time indication as the approximate shooting time.
- The  mark indicating that there is little remaining battery time sometimes flashes depending on the operating conditions or ambient temperature and environment even if the remaining battery time is about five to 10 minutes.

How to store the battery pack

- If the battery pack is not used for a long time, do the following procedure once per year to maintain proper function.
 1. Fully charge the battery.
 2. Discharge on your electronic equipment.
 3. Remove the battery from the equipment and store it in a dry, cool place.
- To use the battery pack up on your camcorder, leave your camcorder in the standby mode until the power goes off without a cassette inserted.

Battery life

- The battery life is limited. Battery capacity drops little by little as you use it more and more, and as time passes. When the available battery time is shortened considerably, a probable cause is that the battery pack has reached the end of its life. Buy a new battery pack.
- The battery life varies according to how it is stored and operating conditions and environment for each battery pack.

About i.LINK

The DV jack on this unit is an i.LINK-compliant DV input/output jack. This section describes the i.LINK standard and its features.

What is "i.LINK"?

i.LINK is a digital serial interface for handling digital video, digital audio and other data in two directions between equipment having the i.LINK jack, and for controlling other equipment.

i.LINK-compatible equipment can be connected by a single i.LINK cable. Possible applications are operations and data transactions with various digital AV equipment. When two or more i.LINK-compatible equipment are connected to this unit in a daisy chain, operations and data transactions are possible with not only the equipment that this unit is connected to but also with other devices via the directly connected equipment.

Note, however, that the method of operation sometimes varies according to the characteristics and specifications of the equipment to be connected, and that operations and data transactions are sometimes not possible on some connected equipment.

Note

Normally, only one piece of equipment can be connected to this unit by the i.LINK cable (DV cable). When connecting this unit to i.LINK-compatible equipment having two or more i.LINK jacks (DV jacks), refer to the operating instructions of the equipment to be connected.

About the name "i.LINK"

i.LINK is a more familiar term for IEEE 1394 data transport bus proposed by SONY, and is a trademark approved by many corporations. IEEE 1394 is an international standard standardized by the Institute of Electrical and Electronic Engineers.

i.LINK baud rate

i.LINK's maximum baud rate varies according to the equipment. Three maximum baud rates are defined:

S100 (approx. 100 Mbps*)

S200 (approx. 200 Mbps)

S400 (approx. 400 Mbps)

The baud rate is listed under "Specifications" in the operating instructions of each equipment. It is also indicated near the i.LINK jack on some equipment.

The maximum baud rate of equipment on which it is not indicated such as this unit is "S100".

When units are unit is connected to equipment having a different maximum baud rate, the baud rate sometimes differs from the indicated baud rate.

* What is "Mbps"?

Mbps stands for megabits per second, or the amount of data that can be sent or received in one second. For example, a baud rate of 100 Mbps means that 100 megabits of data can be sent in one second.

i.LINK functions on this unit

For details on how to dub when this unit is connected to other video equipment having DV jacks, see page 72, 137.

This unit can also be connected to other i.LINK (DV) compatible equipment made by SONY (e.g. VAIO series personal computer) other than video equipment.

Before connecting this unit to a personal computer, make sure that application software supported by this unit is already installed on the personal computer.

For details on precautions when connecting this unit, also refer to the operating instructions of the equipment to be connected.

Required i.LINK cable

Use the Sony i.LINK 4-pin-to-4-pin cable (during DV dubbing).

i.LINK and  are trademarks.

Using your camcorder abroad

Using your camcorder abroad

You can use your camcorder in any country or area with the AC power adaptor supplied with your camcorder within 100 V to 240 V AC, 50/60 Hz.

When charging the battery pack, use a commercially available AC plug adaptor [a], if necessary, depending on the design of the wall outlet [b].

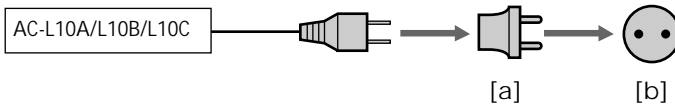

Your camcorder is an NTSC system based camcorder. If you want to view the playback picture on a TV, it must be an NTSC system based TV with VIDEO/AUDIO input jack. The following shows TV color systems used overseas.

NTSC system

Bahama Islands, Bolivia, Canada, Central America, Chile, Colombia, Ecuador, Jamaica, Japan, Korea, Mexico, Peru, Surinam, Taiwan, the Philippines, the U.S.A., Venezuela, etc.

PAL system

Australia, Austria, Belgium, China, Czech Republic, Denmark, Finland, Germany, Great Britain, Holland, Hong Kong, Italy, Kuwait, Malaysia, New Zealand, Norway, Portugal, Singapore, Slovak Republic, Spain, Sweden, Switzerland, Thailand, etc.

PAL-M system

Brazil

PAL-N system

Argentina, Paraguay, Uruguay

SECAM system



Bulgaria, France, Guyana, Hungary, Iran, Iraq, Monaco, Poland, Russia, Ukraine, etc.

Simple setting of clock by time difference

You can easily set the clock to the local time by setting a time difference. Select WORLD TIME in the menu settings. See page 105 for more information.

Maintenance information and precautions

Moisture condensation

If your camcorder is brought directly from a cold place to a warm place, moisture may condense inside your camcorder, on the surface of the tape, or on the lens. In this state, the tape may stick to the head drum and be damaged or your camcorder may not operate correctly. If there is moisture inside your camcorder, the beep sounds and the  indicator flashes. When the  indicator flashes at the same time, the cassette is inserted in your camcorder. If moisture condenses on the lens, the indicator will not appear.

If moisture condensation has occurred

None of the functions except cassette ejection will work. Eject the cassette, turn off your camcorder, and leave it for about one hour with the cassette compartment open. Your camcorder can be used again if the  indicator does not appear when the power is turned on again.

Note on moisture condensation

Moisture may condense when you bring your camcorder from a cold place into a warm place (or vice versa) or when you use your camcorder in a hot place as follows:

- You bring your camcorder from a ski slope into a place warmed up by a heating device.
- You bring your camcorder from an air-conditioned car or room into a hot place outside.
- You use your camcorder after a squall or a shower.
- You use your camcorder in a high temperature and humidity place.

How to prevent moisture condensation

When you bring your camcorder from a cold place into a warm place, put your camcorder in a plastic bag and tightly seal it. Remove the bag when the air temperature inside the plastic bag has reached the surrounding temperature (after about one hour).



Maintenance information

Cleaning the video heads

To ensure normal recording and clear pictures, clean the video heads.

When you playback/record in the Digital8 **D** system

The video head may be dirty when:

- Mosaic-pattern noise appears on the playback picture.
- Playback pictures do not move.
- Playback pictures are hardly visible.
- Playback pictures do not appear.
- The  indicator and “ CLEANING CASSETTE” message appear one after another.



or



When you play back in the Hi8/Standard 8 (analog) system

The video head may be dirty when:

- Playback pictures contain noise.
- Playback pictures are hardly visible.
- Playback pictures do not appear.



or

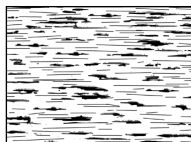

If the above problem occurs, clean the video heads with the Sony V8-25CLD cleaning cassette (optional). Check the picture and if the above problem persists, repeat cleaning.

Cleaning the LCD screen

If fingerprints or dust make the LCD screen dirty, we recommend using the LCD Cleaning Kit (optional) to clean the LCD screen.

Charging the built-in rechargeable battery

Your camcorder is supplied with a built-in rechargeable battery installed to retain the date and time, etc., regardless of the setting of the POWER switch. The built-in rechargeable battery is always charged as long as you are using your camcorder. The battery, however, will become discharged gradually if you do not use your camcorder. It will be completely discharged in about half a year if you do not use your camcorder at all. Even if the built-in rechargeable battery is not charged, it will not affect camcorder operation. To retain the date, time, and other information, charge the battery if the battery is discharged.

Charging the built-in rechargeable battery:

- Connect your camcorder to wall outlet using the AC power adaptor supplied with your camcorder, and leave your camcorder with the POWER switch turned off for more than 24 hours.
- Or, install a fully charged battery pack in your camcorder, and leave your camcorder with the POWER switch set to OFF (CHG) for more than 24 hours.

Precautions

Camcorder operation

- Operate your camcorder on 7.2 V (battery pack) or 8.4 V (AC power adaptor).
- For DC or AC operation, use the accessories recommended in these operating instructions.
- If any solid object or liquid gets inside the casing, unplug your camcorder and have it checked by a Sony dealer before operating it any further.
- Avoid rough handling or mechanical shock. Be particularly careful of the lens.
- Keep the POWER switch set to OFF (CHG) when you are not using your camcorder.
- Do not wrap your camcorder with a towel, for example, and operate it. Doing so might cause heat to build up inside.
- Keep your camcorder away from strong magnetic fields or mechanical vibration. Noise may appear on the image.
- Do not touch the LCD screen with your fingers or a sharp-pointed object.
- If your camcorder is used in a cold place, a residual image may appear on the screen. This is not a malfunction.
- While using your camcorder, the back of the LCD screen may heat up. This is not a malfunction.

On handling tapes

- Do not insert anything into the small holes on the rear of the cassette. These holes are used to sense the type and thickness of the tape and if the recording tab is in or out.
- Do not open the tape protect cover or touch the tape.

Camcorder care

- Remove the tape, and periodically turn on the power, operate the CAMERA and VCR sections and play back a tape for about three minutes when your camcorder is not to be used for a long time.
- Clean the lens with a soft brush to remove dust. If there are fingerprints on the lens, remove them with a soft cloth.
- Clean the camcorder body with a dry soft cloth, or a soft cloth lightly moistened with a mild detergent solution. Do not use any type of solvent which may damage the finish.
- Do not let sand get into your camcorder. When you use your camcorder on a sandy beach or in a dusty place, protect it from the sand or dust. Sand or dust may cause your camcorder to malfunction, and sometimes this malfunction cannot be repaired.

Connection to your computer

When inputting the image recorded by Hi8/standard 8 system into Sony VAIO The Program Capture function of DVgate motion doesn't work. To use this function, dub the image into a Digital8  or DV tape first, and then input it into your Sony VAIO.

AC power adaptor

- Unplug the unit from the wall outlet when you are not using it for a long time. To disconnect the power cord, pull it out by the plug. Never pull the power cord itself.
- Do not operate the unit with a damaged cord or if the unit has been dropped or damaged.
- Do not bend the power cord forcibly, or place a heavy object on it. This will damage the cord and may cause fire or electric shock.
- Prevent metallic objects from coming into contact with the metal parts of the connecting section. If this happens, a short may occur and the unit may be damaged.
- Always keep metal contacts clean.
- Do not disassemble the unit.
- Do not apply mechanical shock or drop the unit.
- While the unit is in use, particularly during charging, keep it away from AM receivers and video equipment. AM receivers and video equipment disturb AM reception and video operation.
- The unit becomes warm during use. This is not a malfunction.
- Do not place the unit in locations that are:
 - Extremely hot or cold
 - Dusty or dirty
 - Very humid
 - Vibrating

About care and storage of the lens

- Wipe the surface of the lens clean with a soft cloth in the following instances:
 - When there are fingerprints on the lens surface
 - In hot or humid locations
 - When the lens is used in environments susceptible to salt such as the seaside
- Store the lens in a well-ventilated location subject to little dirt or dust.

To prevent mold from occurring, periodically perform the above.

We recommend turning on and operating your camcorder about once per month to keep your camcorder in an optimum state for a long time.

Battery pack

- Use only the specified charger or video equipment with the charging function.
- To prevent accident from a short circuit, do not allow metal objects to come into contact with the battery terminals.
- Keep the battery pack away from fire.
- Never expose the battery pack to temperatures above 60°C (140°F), such as in a car parked in the sun or under direct sunlight.
- Keep the battery pack dry.
- Do not expose the battery pack to any mechanical shock.
- Do not disassemble nor modify the battery pack.
- Attach the battery pack to the video equipment securely.
- Charging while some capacity remains does not affect the original battery capacity.

Notes on dry batteries

To avoid possible damage from battery leakage or corrosion, observe the following:

- Be sure to insert the batteries with the + and – correctly matching the + and – inside the battery compartment.
- Dry batteries are not rechargeable.
- Do not use a combination of new and old batteries.
- Do not use different types of batteries.
- Current flows from batteries when you are not using them for a long time.
- Do not use leaking batteries.

If batteries are leaking

- Wipe off the liquid in the battery compartment carefully before replacing the batteries.
- If you touch the liquid, wash it off with water.
- If the liquid gets into your eyes, wash your eyes with a lot of water and then consult a doctor.

If any problem occurs, unplug your camcorder and contact your nearest Sony dealer.

Specifications

Video camera recorder

System

Video recording system
2 rotary heads
Helical scanning system
Audio recording system
Rotary heads, PCM system
Quantization: 12 bits (Fs 32 kHz, stereo 1, stereo 2), 16 bits (Fs 48 kHz, stereo)
Video signal
NTSC color, EIA standards
Recommended cassette
Hi8/Digital8 video cassette
Recording/playback time (using 120 min. Hi8 video cassette)
SP mode: 1 hour
LP mode: 1 hour and 30 minutes
Fast-forward/rewind time (using 120 min. Hi8 video cassette)
Approx. 5 min.
Viewfinder
Electric Viewfinder, Monochrome
Image device
DCR-TRV240/TRV340:
3 mm (1/6 type) CCD
(Charge Coupled Device)
Gross: Approx. 460 000 pixels
Effective: Approx. 290 000 pixels
DCR-TRV740/TRV840:
4.5 mm (1/4 type) CCD
(Charge Coupled Device)
Gross: Approx. 1 070 000 pixels
Effective: Approx. 690 000 pixels
(Camera mode)
Approx. 1 000 000 pixels
(Memory mode)

Lens
Combined power zoom lens
Filter diameter 37 mm (1 1/2 in.)
DCR-TRV240/TRV340:
25× (Optical), 700× (Digital)
DCR-TRV740/TRV840:
15× (Optical), 420× (Digital)
Focal length
DCR-TRV240/TRV340:
2.4 – 60 mm (1/8 – 2 3/8 in.)
When converted to a 35 mm still camera
42 – 1 050 mm (1 11/16 – 41 3/8 in.)
DCR-TRV740/TRV840:
3.6 – 54 mm (5/32 – 2 1/4 in.)
When converted to a 35 mm still camera
Camera mode:
48 – 720 mm (1 15/16 – 28 3/8 in.)

Memory mode:
40 – 600 mm (1 5/8 – 23 5/8 in.)
Color temperature
Auto
Minimum illumination
DCR-TRV240/TRV340:
4 lx (lux) (F 1.6)
DCR-TRV740/TRV840:
7 lx (lux) (F1.6)
0 lx (lux) (in the NightShot mode)*
* Objects unable to be seen due to the dark can be shot with infrared lighting.

Input/output connectors

S video input/output
4-pin mini DIN
Luminance signal: 1 Vp-p,
75 Ω (ohms), unbalanced
Chrominance signal: 0.286 Vp-p,
75 Ω (ohms), unbalanced
Audio/Video input/output
AV MINIJACK, 1 Vp-p, 75 Ω
(ohms), unbalanced, sync negative
327 mV, (at output impedance
more than 47 kΩ (kilohms))
Output impedance with less than
2.2 kΩ (kilohms)/Stereo minijack
(ø 3.5 mm)
Input impedance more than 47 kΩ
(kilohms)
Headphone jack
Stereo minijack (ø 3.5 mm)
USB jack
mini-B
LANC jack
Stereo mini-minijack (ø 2.5 mm)
MIC jack
Stereo minijack (ø 3.5 mm)
DV input/output
4-pin connector

LCD screen

Picture
DCR-TRV240/TRV340/TRV740:
6.2 cm (2.5 type)
50.3 × 37.4 mm (2 × 1 1/2 in.)
DCR-TRV840:
8.8 cm (3.5 type)
72.2 × 50.4 mm (2 7/8 × 2 in.)
Total dot number
DCR-TRV240/TRV340/TRV740:
61 600 (280 × 220)
DCR-TRV840:
123 200 (560 × 220)

General

Power requirements
7.2 V (battery pack)
8.4 V (AC power adaptor)
Average power consumption
(when using the battery pack)
During camera recording using
LCD
DCR-TRV240/TRV340:
3.8 W
DCR-TRV740:
4.3 W
DCR-TRV840:
4.5 W
Viewfinder
DCR-TRV240/TRV340:
3.0 W
DCR-TRV740/TRV840:
3.5 W
Operating temperature
0°C to 40°C (32°F to 104°F)
Recommended charging
temperature
10°C to 30°C (50°F to 86°F)
Storage temperature
–20°C to +60°C (–4°F to +140°F)
Dimensions (approx.)
DCR-TRV240/TRV340:
206 × 101 × 85 mm
(8 1/8 × 4 × 3 3/8 in.)
(w/h/d)
DCR-TRV740/TRV840:
207 × 101 × 85 mm
(8 1/4 × 4 × 3 3/8 in.)
Mass (approx.)
DCR-TRV240:
890 g (1 lb 15 oz)
DCR-TRV340/TRV740:
900 g (1 lb 15 oz)
DCR-TRV840:
930 g (2 lb)
excluding the battery pack,
cassette, lens cap and shoulder
strap
DCR-TRV240:
1 030 g (2 lb 4 oz)
DCR-TRV340/TRV740:
1 040 g (2 lb 4 oz)
DCR-TRV840:
1 070 g (2 lb 5 oz)
including the battery pack
(NP-FM30 or NP-FM50), 120min.
Hi8 cassette, lens cap and shoulder
strap
Supplied accessories
See page 5.

Specifications

AC power adaptor

Power requirements
100 – 240 V AC, 50/60 Hz
Power consumption
23 W
Output voltage
DC OUT: 8.4 V, 1.5 A in the
operating mode
Operating temperature
0°C to 40°C (32°F to 104°F)
Storage temperature
-20°C to + 60°C (-4°F to + 140°F)
Dimensions (approx.)
125 × 39 × 62 mm
(5 × 1 9/16 × 2 1/2 in.) (w/h/d)
excluding projecting parts
Mass (approx.)
280 g (9.8 oz)
excluding power cord

Battery pack

Maximum output voltage
DC 8.4 V
Mean output voltage
DC 7.2 V
Capacity
NP-FM30:
5.0 Wh (700 mAh)
NP-FM50:
8.5 wh (1 180 mAh)
Operating temperature
0°C to 40°C (32°F to 104°F)
Dimensions (approx.)
38.2 × 20.5 × 55.6 mm
(1 9/16 × 13/16 × 2 1/4 in.)
(w/h/d)
Mass (approx.)
NP-FM30:
65 g (2.3 oz)
NP-FM50:
76 g (2.7 oz)
Type
Lithium ion

“Memory Stick”

(except DCR-TRV240)
Memory
Flash memory
8MB: MSA-8A
Operating voltage
2.7 – 3.6 V
Power consumption
Approx. 45 mA in the operating
mode
Approx. 130 µA in the standby
mode
Dimensions (approx.)
50 × 2.8 × 21.5 mm
(2 × 1/8 × 7/8 in.) (w/h/d)
Mass (approx.)
4 g (0.14 oz)

Design and specifications are
subject to change without notice.

Identifying parts and controls

Camcorder

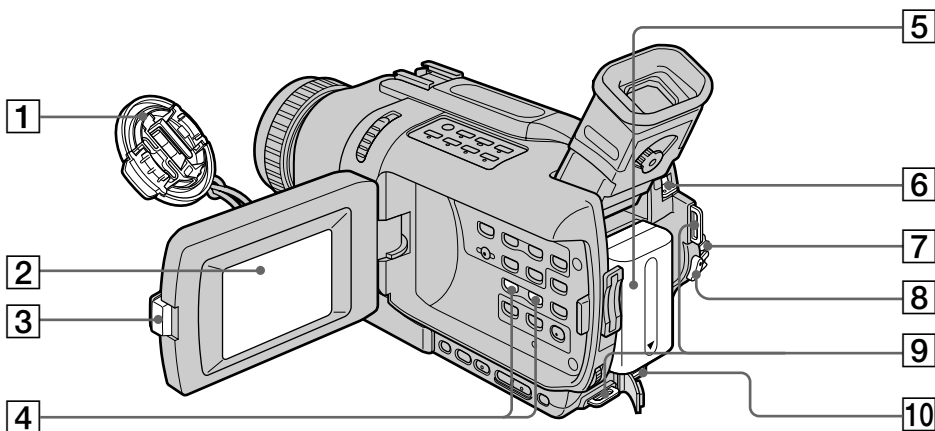

- | | |
|-----------------------------|--|
| 1 Lens cap (p. 21) | 6 BATT (battery) release lever (p. 12) |
| 2 LCD screen (p. 21) | 7 POWER switch (p. 21) |
| 3 OPEN button (p. 21) | 8 START/STOP button (p. 21) |
| 4 VOLUME +/- button (p. 34) | 9 Hooks for shoulder strap |
| 5 Battery pack (p. 12) | 10 DC IN jack (p. 13) |

Attaching the shoulder strap

Attach the shoulder strap supplied with your camcorder to the hooks for the shoulder strap.

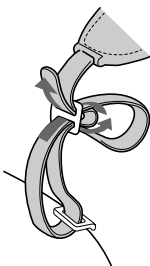

Identifying parts and controls

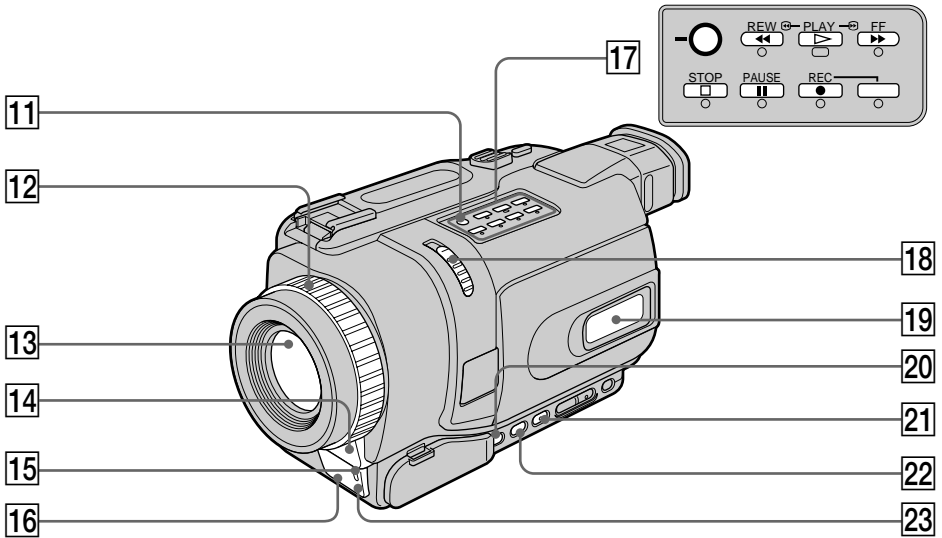

11 SUPER NS/COLOR SLOW S button
(p. 29)

12 Focus ring (p. 54)

13 Lens

14 Microphone

15 Camera recording lamp (p. 21)

16 Infrared rays emitter (p. 29)

17 Video control buttons (p. 34, 36)

■ STOP (stop)

◀ REW (rewind)

▶ PLAY (playback)

▶▶ FF (fast-forward)

|| PAUSE (pause)

● REC (recording)

18 NIGHTSHOT switch (p. 29)

19 Display window (p. 208)

20 FOCUS button (p. 54)

21 FADER button (p. 45)

22 BACK LIGHT button (p. 28)

23 Remote sensor

Identifying parts and controls

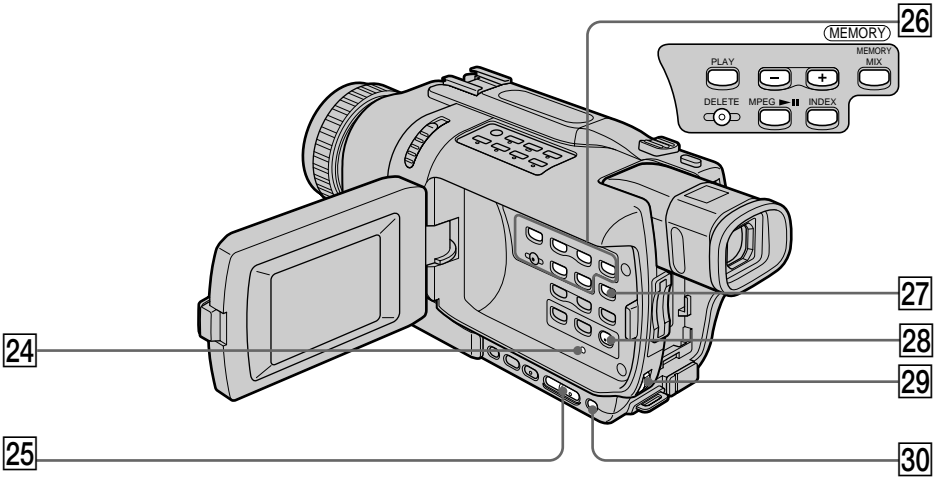

- 24 RESET button (p. 183)
- 25 EDITSEARCH button (p. 32)
- 26 MEMORY operation buttons*
 - MEMORY PLAY button (p. 150)
 - MEMORY - button (p. 150)
 - MEMORY + button (p. 150)
 - MEMORY MIX button (p. 130)
 - MEMORY DELETE button (p. 171)
 - MPEG ►|| button (p. 153)
 - MEMORY INDEX button (p. 152)
- 27 DISPLAY button (p. 35)
- 28 MENU button (p. 105)
- 29 SEL/PUSH EXEC dial (p. 105)
- 30 EXPOSURE button (p. 53)

* Except DCR-TRV240

Attaching the lens cap
Attach the lens cap to the grip strap as illustrated.

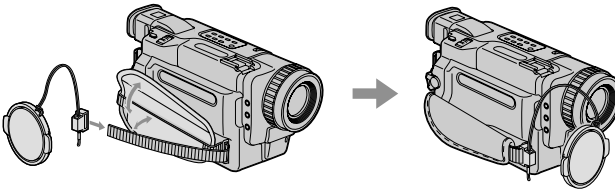

Identifying parts and controls

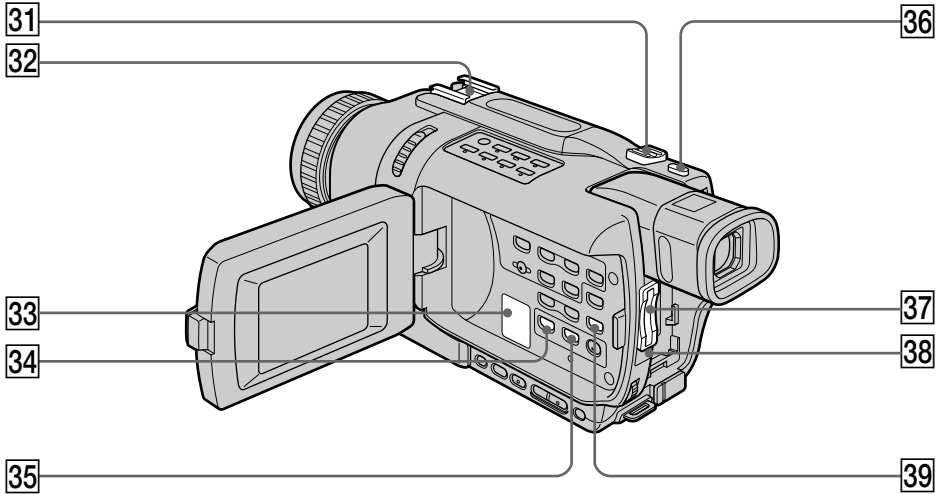

31 Power zoom lever (p. 24)

32 Intelligent accessory shoe

33 Speaker

34 PB ZOOM button (p. 65, 166)

35 TITLE button (p. 58)

36 PHOTO button (p. 39, 124)

37 "Memory Stick" slot* (p. 118)

38 Access lamp* (p. 118)

39 END SEARCH button (p. 32, 37)

* Except DCR-TRV240

Intelligent Accessory Shoe

Notes on the intelligent accessory shoe

- The intelligent accessory shoe supplies power to optional accessories such as a video light or microphone or printer (except DCR-TRV240).
- The intelligent accessory shoe is linked to the POWER switch, allowing you to turn the power supplied by the shoe on and off. Refer to the operating instructions of the accessory for further information.
- The intelligent accessory shoe has a safety device for fixing the installed accessory securely. To connect an accessory, press down and push it to the end, and then tighten the screw.
- To remove an accessory, loosen the screw, and then press down and pull out the accessory.

Identifying parts and controls

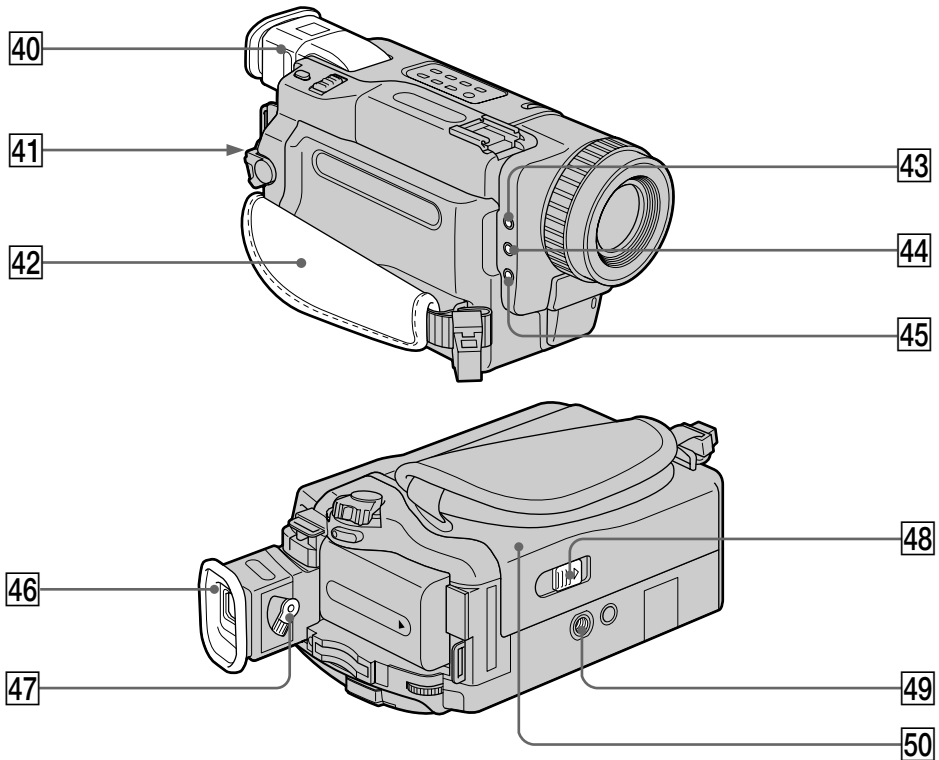

40 Viewfinder (p. 25)

41 LOCK switch* (p. 21)

42 Grip strap

43 MIC (PLUG IN POWER) jack
Connect an external microphone (optional). This jack also accepts a “plug-in-power” microphone.

44 ♪ (headphones) jack

45 LANC ⏪ jack
LANC stands for Local Application Control Bus System. The LANC control jack is used for controlling the tape transport of video equipment and other peripherals connected to the video equipment. This jack has the same function as the jack indicated as CONTROL L or REMOTE.

46 Eyecup

47 Viewfinder lens adjustment lever (p. 25)

48 OPEN/EJECT switch (p. 20)

49 Tripod receptacle (base)
Make sure that the length of the tripod screw is less than 5.5 mm (7/32 inch). Otherwise, you cannot attach the tripod securely and the screw may damage your camcorder.

50 Cassette compartment (p. 20)

* Except DCR-TRV240

Identifying parts and controls

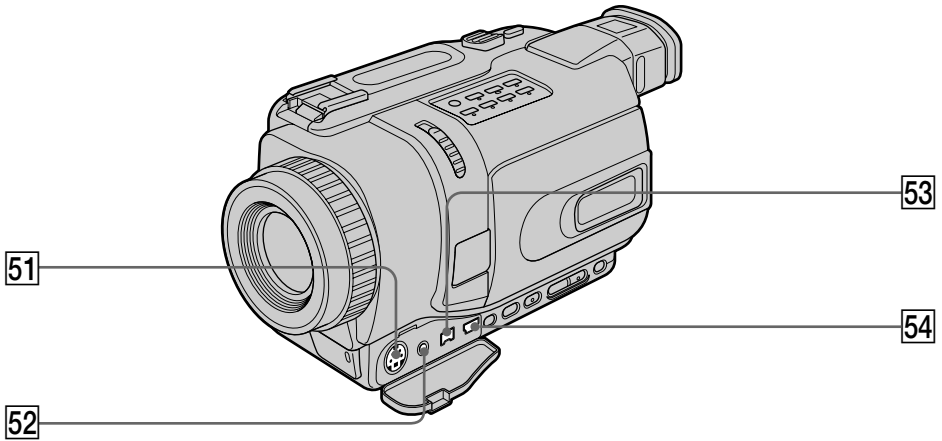

51 S VIDEO jack (p. 38, 71, 136)

52 AUDIO/VIDEO jack (p. 38, 71, 136)

53 DV IN/OUT jack (p. 72, 137)
The DV IN/OUT jack is i.LINK compatible.

54 Ψ (USB) jack (p. 97, 157)

Fastening the grip strap

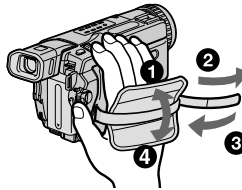

Fasten the grip strap firmly.

Remote Commander

The buttons that have the same name on the Remote Commander as on your camcorder function identically to the buttons on your camcorder.

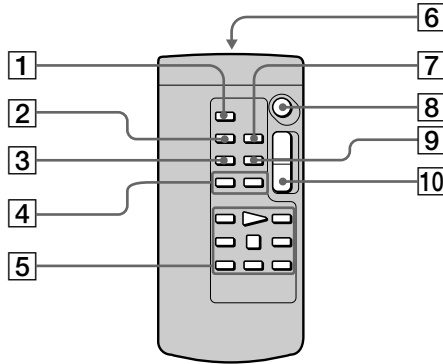

- | | |
|---|---|
| 1 PHOTO button (p. 39, 124) | 7 ZERO SET MEMORY button (p. 67) |
| 2 DISPLAY button (p. 35) | 8 START/STOP button (p. 21) |
| 3 SEARCH MODE button (p. 68, 69) | 9 DATA CODE button (p. 35) |
| 4 ◀◀/▶▶ buttons (p. 68, 69) | 10 Power zoom button (p. 24) |
| 5 Tape transport buttons (p. 36) | |
| 6 Transmitter
Point toward the remote sensor to control the camcorder after turning on the camcorder. | |

To prepare the Remote Commander

Insert 2 size AA (R6) batteries by matching the + and - on the batteries to the + and - in the battery compartment.

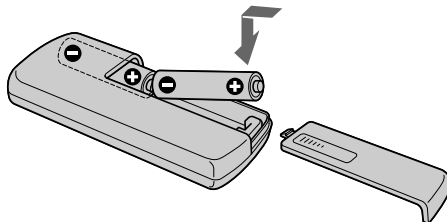

Notes on the Remote Commander

- Point the remote sensor away from strong light sources such as direct sunlight or overhead lighting. Otherwise, the Remote Commander may not function properly.
- Your camcorder works in the Commander mode VTR 2. Commander modes 1, 2 and 3 are used to distinguish your camcorder from other Sony VCRs to avoid erroneous remote control operation. If you use another Sony VCR in the Commander mode VTR 2, we recommend changing the Commander mode or covering the sensor of the VCR with black paper.

Operation indicators

LCD screen and Viewfinder

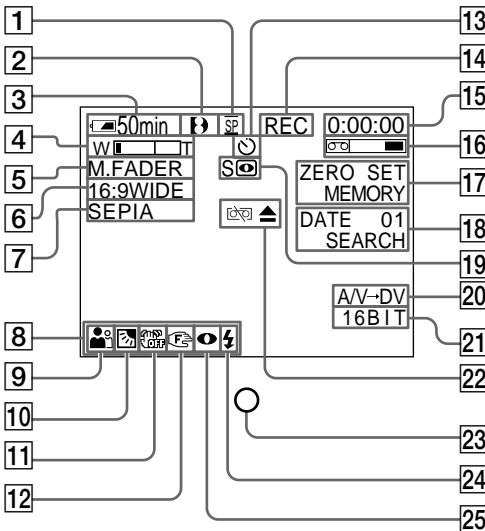

Display window

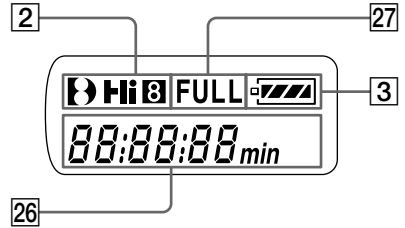

- 1 Recording mode (p. 21)
/Mirror mode (p. 26)
- 2 Format (p. 187)
H, **Hi8** or **8** indicator appears.
- 3 Remaining battery time
(p. 27, 35)
- 4 Zoom (p. 24)/Exposure (p. 53)
- 5 Fader (p. 45)/Digital effect (p. 49, 64)
- 6 Wide mode (p. 42)/FRAME indicator
(except DCR-TRV240) (p. 124)
- 7 Picture effect (p. 47, 63)
- 8 Volume (p. 34)/Data code (p. 35)
- 9 PROGRAM AE (p. 52)
- 10 Backlight (p. 28)
- 11 SteadyShot off (p. 107)
- 12 Manual focusing (p. 54)
- 13 Self-timer (except DCR-TRV240)
(p. 31, 41, 128)
- 14 STBY/REC (p. 21)/Video control mode
(p. 36)
- 15 Tape counter (p. 27)/Time code
(p. 27)/Self-diagnosis display (p. 184)/
Tape Photo recording (p. 39)
- 16 Remaining tape (p. 27)
- 17 ZERO SET MEMORY (p. 67)
- 18 Search mode (p. 32, 68, 69)
- 19 NIGHTSHOT (p. 29)/SUPER NIGHTSHOT
(p. 29)/COLOR SLOW SHUTTER (p. 29)
- 20 A/V → DV (p. 88)/DV IN (p. 91)
- 21 Audio mode (p. 112)
- 22 Warning (p. 185)
- 23 Recording lamp (p. 21)
This indicator appears in the viewfinder.
- 24 Video flash ready (p. 106)
This indicator appears when you use the
video flash light (optional).
- 25 Video flash mode (p. 106)
This indicator appears when you use the
video flash light (optional).
- 26 Tape counter (p. 27)/Time code
(p. 27)/Self-diagnosis display (p. 184)/
Remaining battery time (p. 14)
- 27 FULL charge (p. 14)

Index

A, B

AC power adaptor 13
Adjusting viewfinder 25
AFM HiFi Sound 188
AUDIO MIX 108
AUDIO MODE 112
A/V connecting cable
..... 38, 71, 136
BACK LIGHT 28
Battery pack 13
BEEP 114
BOUNCE 44

C, D

Camera chromakey 129
Charging battery 13
Charging built-in rechargeable
battery 196
Clock set 18
Color Slow Shutter 29
Continuous 126
Data code 35
Date search 68
DEMO 113
DIGITAL EFFECT 48, 64
Digital8 system 187
Digital program editing
..... 74, 146
DISPLAY 35
DOT 44
Dual sound track tape 188
DV connecting cable 72, 137

E

EDITSEARCH 32
END SEARCH 32, 37
EXP BRKTG 126
Exposure 53

F, G, H

FADER 44
Fade in/out 44
FLASH MOTION 48
FOCUS 54
Format 111
Frame recording 57
Full charge 13
Grip strap 205
Ⓜ (Headphones jack) 205
Heads 195
HiFi SOUND 108

I, J, K, L

i.LINK 191
Image protection 170
Image quality mode 119
Image size 121
Index screen 152
“InfoLITHIUM” battery 189
Infrared rays emitter 29
Insert editing 92
Intelligent accessory shoe
..... 204
Interval recording 55
JPEG 116
LANC jack 205
LUMINANCEKEY 48

M, N

Main sound 188
Manual focus 54
Memory chromakey 129
Memory luminancekey 129
MEMORY MIX 129
Memory overlap 129
Memory PB ZOOM 166
Memory photo recording 124
“Memory Stick” 116
Menu settings 105
Mirror mode 26
Moisture condensation 194
Monaural 38
MONOTONE 44
M.FADER 44
MPEG 116
MPEG movie recording 140
MULTI SCR.N 126
NIGHTSHOT 29
NTSC system 193

O, P, Q

OLD MOVIE 48
Operation indicators 208
OVERLAP 44
Photo scan 70
Photo search 69
PICTURE EFFECT 47, 63
Picture search 36
Playback pause 36
Playing time 16
Power zoom 24
Print mark 174
PROGRAM AE 51

R

Recording time 15
Rec Review 32
Remaining battery time
indicator 27, 36
Remaining tape indicator 27
Remote Commander 207
Remote sensor 202
RESET 183

S

Self-diagnosis display 184
Self-timer recording
..... 31, 41, 128
Shoulder strap 201
Signal convert function 88
Skip scan 37
Slide show 168
Slow playback 37
SLOW SHUTTER 48
STEADYSHOT 107
Stereo tape 188
STILL 48
Sub sound 188
SUPER NIGHTSHOT 29
S VIDEO jack 38

T, U, V

Tape counter 27
Tape PB ZOOM 65
Tape photo recording 39
Telephoto 24
Time code 27
Title 58
TRAIL 48
Transition 22
TV color systems 193
Ⓜ (USB) 97, 157

W, X, Y, Z

Warning indicators 185
Wide-angle 24
Wide mode 42
WIPE 44
WORLD TIME 114
Write-protect tab 20
Zero set memory 67
Zoom 24

Printed on 100% recycled paper using VOC
(Volatile Organic Compound)-free vegetable
oil based ink.

<http://www.sony.net/>

Sony Corporation Printed in Japan

