

SONY®

3-866-564-12(1)

Color Rear Video Projector

Operating Instructions

Free Layout PinP

FLASH FOCUS

Parental Control

Twin View™

KP-48V80

KP-53V80

KP-61V80

© 1999 by Sony Corporation

WARNING

To prevent fire or shock hazard, do not expose the TV to rain or moisture.

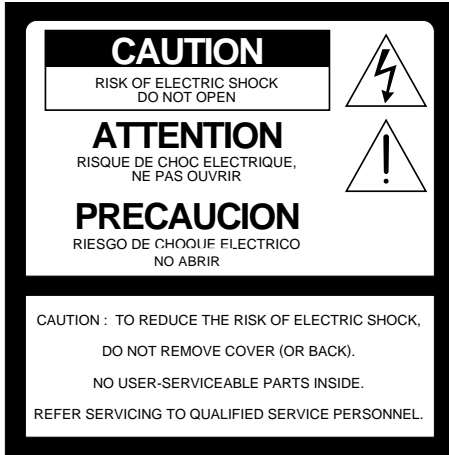

This symbol is intended to alert the user to the presence of uninsulated "dangerous voltage" within the product's enclosure that may be of sufficient magnitude to constitute a risk of electric shock to persons.



This symbol is intended to alert the user to the presence of important operating and maintenance (servicing) instructions in the literature accompanying the appliance.

CAUTION

To prevent electric shock, do not use this polarized AC plug with an extension cord, receptacle or other outlet unless the blades can be fully inserted to prevent blade exposure.

CAUTION

When using TV games, computers and similar products with your projection TV, or viewing a TV station whose logo always stays on the screen, keep the brightness and contrast functions at low settings. If a fixed (non-moving) pattern such as a station logo is left on the screen for long periods of time, especially at a high brightness or contrast setting, the image can be permanently imprinted onto the screen. These types of imprints are not covered by your warranty because they are the result of misuse.

Note on Caption Vision

This television receiver provides display of television closed captioning in accordance with §15.119 of the FCC rules.

Note on convergence adjustment

Before you use your projection TV, make sure to adjust convergence. For details, see page 20.

Note to CATV system installer

This reminder is provided to call the CATV system installer's attention to Article 820-40 of the NEC that provides guidelines for proper grounding and, in particular, specifies that the cable ground shall be connected to the grounding system of the building, as close to the point of cable entry as practical.

Use of this television receiver for other than private viewing of programs broadcast on UHF or VHF or transmitted by cable companies for the use of the general public may require authorization from the broadcaster/cable company and/or program owner.

NOTIFICATION

This equipment has been tested and found to comply with the limits for a Class B digital device pursuant to Part 15 of the FCC Rules. These limits are designed to provide reasonable protection against harmful interference in a residential installation. This equipment generates, uses, and can radiate radio

frequency energy and, if not installed and used in accordance with the instructions, may cause harmful interference with radio communications. However, there is no guarantee that interference will not occur in a particular installation. If this equipment does cause harmful interference to radio or television reception, which can be determined by turning the equipment off and on, the user is encouraged to try to correct the interference by one or more of the following measures:

- Reorient or relocate the receiving antennas.
- Increase the separation between the equipment and receiver.
- Connect the equipment into an outlet on a circuit different from that to which the receiver is connected.
- Consult the dealer or an experienced radio/TV technician for help.

You are cautioned that any changes or modifications not expressly approved in this manual could void your authority to operate this equipment.

This document is for the remote control RM-Y905
MODELS: KP-48V80, KP-53V80, KP-61V80

Please keep this notice with the instruction manual.



As an ENERGY STAR Partner, Sony Corporation has determined that this product meets the ENERGY STAR guidelines for energy efficiency.

ATTENTION

Pour prévenir les chocs électriques, ne pas utiliser cette fiche polarisée avec un prolongateur, une prise de courant ou une autre sortie de courant, sauf si les lames peuvent être insérées à fond sans en laisser aucune partie à découvert.

Remote Control

In the instructions that follow, we will refer to the buttons on your remote control. Keep this flap unfolded and use this page for reference.

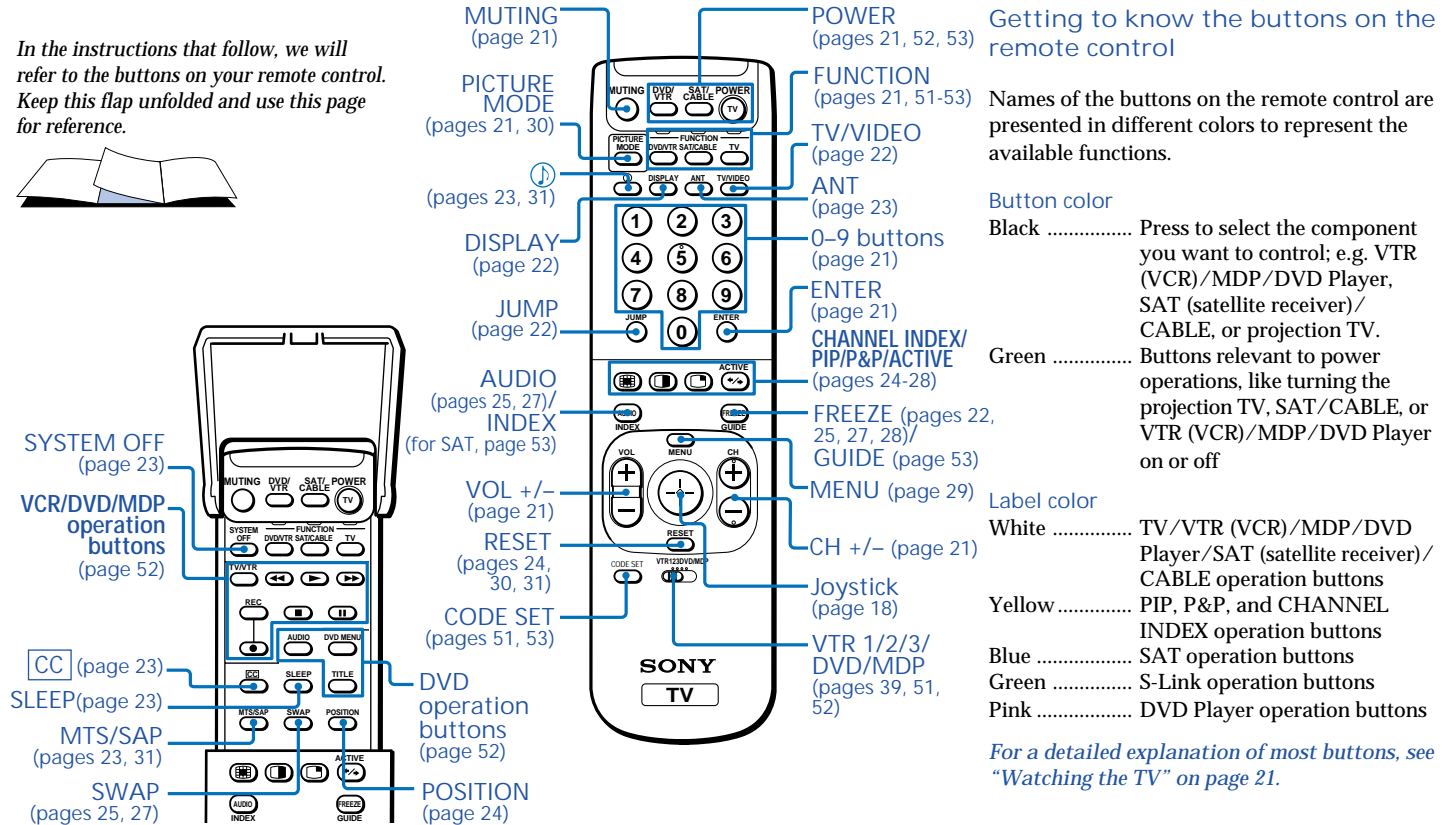
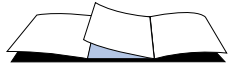







Table of Contents

<i>Welcome!</i>	1
<i>Using This Manual</i>	2
<i>Precautions</i>	2
<hr/>	
<i>Installing and Connecting the Projection TV</i>	3
Carrying Your Projection TV	3
Installing the Projection TV	3
Connector Types	4
Making Connections	4
Connecting directly to a cable or an antenna	4
Cable or antenna	5
Cable and antenna	5
Connecting a cable box	5
Cable box and cable	5
Connecting a cable TV system/ antenna to a VCR	6
Connecting a VCR and projection TV to a cable box	6
Connecting a satellite receiver (SAT) ..	7
Connecting a satellite receiver (SAT) and a VCR	8
Connecting a DTV (digital television) receiver	9

Connecting a camcorder	10
Connecting two VCRs for tape editing	11
Connecting a DVD Player	12
Connecting a DVD Player with component video output connectors	12
Connecting an AV receiver	13
Connecting an audio system	14
Connecting a Sony SAVA series speaker system	14
Connecting an amplifier that supports Dolby Pro Logic decoder	15
Using the S-Link Function	16
Using the S-Link function without a Sony AV receiver	16
Using the S-Link function with a Sony AV receiver	17

<i>Basic Set Up</i>	18
Using the Remote Control	18
Setting Up the Projection TV Automatically	19
Adjusting the Convergence Automatically (FLASH FOCUS)	20

<i>Using Your New Projection TV</i>	21
Watching the TV	21
Watching Two Programs at One Time — PIP	24
Watching Two Programs at One Time — P&P (Twin View™)	26
Using CHANNEL INDEX	28
<hr/>	
<i>Adjusting Your SET UP (menus)</i> ...	29
Learning Menu Selection	29
 Using the Video Menu	30
 Using the Audio Menu	31
 Using the Timer Menu	33
 Using the Channel Set Up Menu	34
Setting and Selecting Favorite Channel ..	36
 Using the Set Up Menu	38
Using the Parental Control Feature	40
Activating the Parental Control Feature	40
Selecting a Custom Rating in U.S.A.	42
Selecting a Custom Rating in Canada	45
Changing the Password	46

Welcome!

What the Ratings Mean	47
Ratings in U.S.A.	47
Ratings in Canada	49

<i>Operating Video Equipment</i>	51
--	----

Setting the Manufacturer's Code	51
---------------------------------------	----

<i>Operating a Cable Box or Satellite Receiver (SAT)</i>	53
--	----

Setting the Manufacturer's Code	53
---------------------------------------	----

<i>Troubleshooting</i>	54
------------------------------	----

<i>Specifications</i>	56
-----------------------------	----

<i>Index</i>	57
--------------------	----

Owner's Record

The model and serial numbers are located at the rear of the projection TV, below the Sony logo, on the sticker, and also on the TV box (white label). Record these numbers in the spaces provided below. Refer to them whenever you call upon your Sony dealer regarding this product.

Model No. _____

Serial No. _____

Thank you for purchasing the Sony Color Rear Video Projection TV.

This manual is for models KP-48V80, KP-53V80 and KP-61V80.

Model KP-53V80 is used for illustration purposes.

The features you will enjoy include:

- FLASH FOCUS, allowing you to adjust convergence automatically.
- Parental Control, enabling you to block programs that you feel are unsuitable for your children.
- Picture & Picture (P&P) (Twin View™), allowing you to view two channels simultaneously both in a reduced size.
- Picture-in Picture (PIP), allowing you to view another TV channel, video or cable image as a window picture.
- CHANNEL INDEX, allowing you to view and choose from twelve programs
- Favorite Channel, allowing you to view and choose from eight of your favorite channels
- S-Link™, allowing you to control some operations of your projection TV by other Sony components.

- Two Y/P_B/P_R inputs for DVD Player and DTV receiver connections.
- Three AUDIO/VIDEO/S VIDEO inputs.

Manufactured under license from Dolby Laboratories Licensing Corporation. Additionally licensed under Canadian patent number 1,037,877. "Dolby," the double-D symbol , "Pro Logic," "VIRTUAL DOLBY and DIGITAL" are trademarks of Dolby Laboratories Licensing Corporation.

SRS (●)® (SOUND RETRIEVAL SYSTEM)

The SRS (●)® (SOUND RETRIEVAL SYSTEM) is manufactured by Sony Corporation under license from SRS Labs, Inc. It is covered by U.S. Patent No. 4,748,669. Other U.S. and foreign patents pending.

The word SRS and the SRS symbol (●) are registered trademarks of SRS Labs, Inc.

Using This Manual

We recommend that you carefully review the contents of the following four sections in the order provided to ensure that you fully understand the operation of your new projection TV.

1 Installing and Connecting the Projection TV

This section guides you through your initial set up. It shows you how to install your projection TV, to connect your new components and to connect to the antenna and cable.

2 Basic Set Up

This section teaches you the basic skills needed to operate your new projection TV, including Auto Set Up. It shows you how to operate the remote control's special functions.

3 Using Your New Projection TV

This section shows you how to begin using your new projection TV. It shows you how to use your remote control's features.

4 Adjusting Your Set Up (menus)

This section teaches you how to access on-screen menus and adjust your projection TV's settings.

Instructions in this manual are written for the remote control. Similar controls may be found on the projection TV console.

Precautions

Safety

- Operate the projection TV only on 120 V AC.
- The plug is designed, for safety purposes, to fit into the wall outlet only one way. If you are unable to insert the plug fully into the outlet, contact your dealer.
- If any liquid or solid object should fall inside the cabinet, unplug the projection TV immediately and have it checked by qualified service personnel before operating it further.
- If you will not be using the projection TV for several days, disconnect the power by pulling the plug itself. Never pull on the cord.

For details concerning safety precautions, see the supplied leaflet "IMPORTANT SAFEGUARDS."

Note on cleaning

Clean the cabinet of the projection TV with a dry soft cloth. To remove dust from the screen, wipe it gently with a soft cloth. Stubborn stains may be removed with a cloth slightly dampened with solution of mild soap and warm water. Never use strong solvents such as thinner or benzine for cleaning.

If the picture becomes dark after using the projection TV for a long period of time, it may be necessary to clean the inside of the projection TV. Consult qualified service personnel.

Installing and Connecting the Projection TV

Installing

- To prevent internal heat buildup, do not block the ventilation openings.
- Do not install the projection TV in a hot or humid place, or in a place subject to excessive dust or mechanical vibration.
- Avoid operating the projection TV at temperatures below 5° C (41° F).
- If the projection TV is transported directly from a cold to a warm location, or if the room temperature changes suddenly, the picture may be blurred or show poor color. In this case, please wait a few hours to let the moisture evaporate before turning on the projection TV.
- To obtain the best picture, do not expose the screen to direct illumination or direct sunlight. It is recommended to use spot lighting directed down from the ceiling or to cover the windows that face the screen with opaque drapery. It is desirable to install the projection TV in a room where the floor and walls are not of a reflective material.

Carrying Your Projection TV

Carrying the projection TV requires three or more people.

The projection TV has been equipped with casters for easy movement on a hard surface. Please move your projection TV using the casters.

Installing the Projection TV

Recommended viewing area (Horizontal)

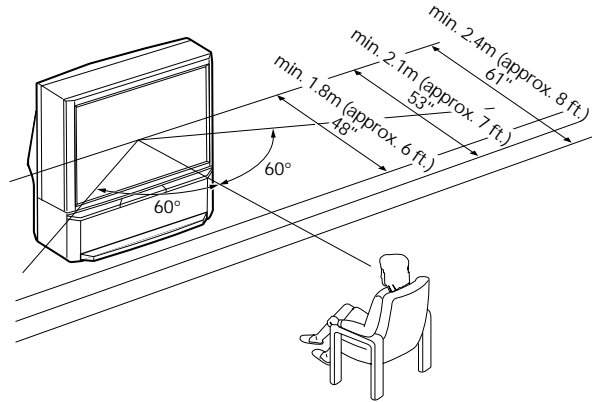

Recommended viewing area (Vertical)

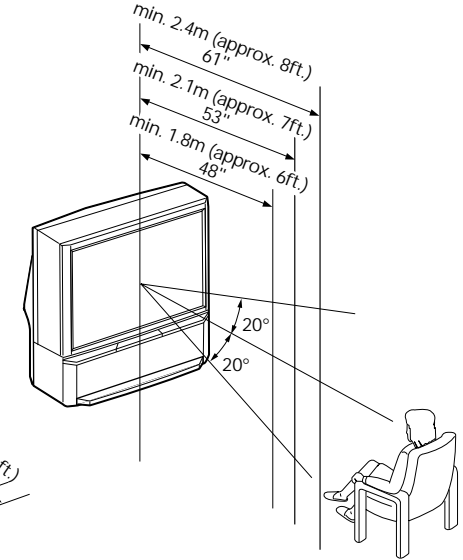

Installing and Connecting the Projection TV (continued)

Connector Types

You may find it necessary to use some of the following connector types during set up.

Coaxial cable

Standard TV cable and antenna cable

Plug Type



Screw-on Type



S Video cable

High quality video cable for enhanced picture quality



Audio/Video cable



Video - Yellow

Audio (Left) - White

Audio (Right) - Red

Some DVD Players and DTV Receivers are equipped with the following three video connectors.

Y - Green

P_B (C_B, C_b or B-Y) - Blue

P_R (C_R, C_r or R-Y) - Red

S-Link/CONTROL S cable

Sony cable for S-Link and CONTROL S connections. These features are exclusive to Sony products and allow greater control of all Sony equipment.



Note:

- For S-Link and CONTROL S connections, you can use the combined S-Link/CONTROL S cable provided with some Sony video equipment, or you can purchase a separate S-Link/CONTROL S cable (RK-G69HG).

About the CONTROL S OUT jack

To control other Sony equipment with the projection TV's remote control, connect the CONTROL S IN jack of the equipment to the CONTROL S OUT jack on the projection TV with the CONTROL S cable.

(Rear of projection TV)

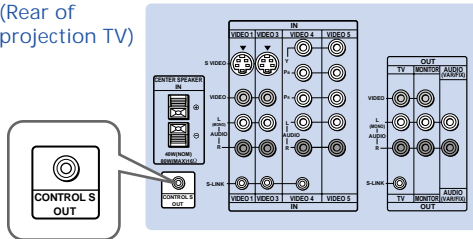

Making Connections

Connecting directly to a cable or an antenna

The connection you choose will depend on the cable found in your home. Newer homes will be equipped with standard coaxial cable (see A); older homes will probably have 300-ohm twin lead cable (see B); still other homes may contain both (see C). Use 75-ohm coaxial cable for improved picture quality (see A).

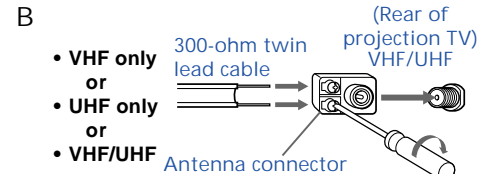
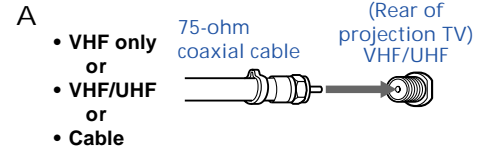

C

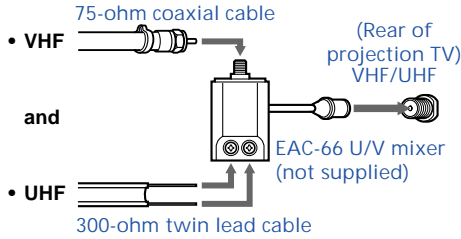

Cable or antenna

This is the simplest connection. Connection is made directly from the cable or antenna to the projection TV.

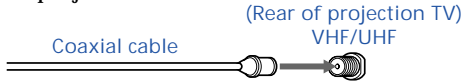

Cable and antenna

You may find it convenient to use the following set up if your cable provider does not feature local channels that you are able to receive using an antenna.

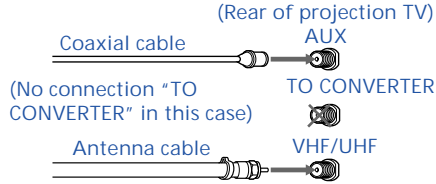
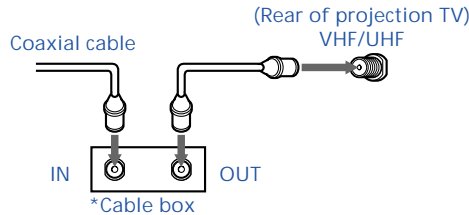

Select Cable or ANT mode by pressing ANT on the remote control.

Connecting a cable box

Some pay cable TV systems use scrambled or encoded signals that require a cable box* to view all channels.

Also, set "Cable" to "On" in the Channel Set Up menu (page 35).

Cable box and cable

Some pay cable TV systems use scrambled or encoded signals requiring a cable box* only for certain channels (e.g. HBO, SHOWTIME, etc.)

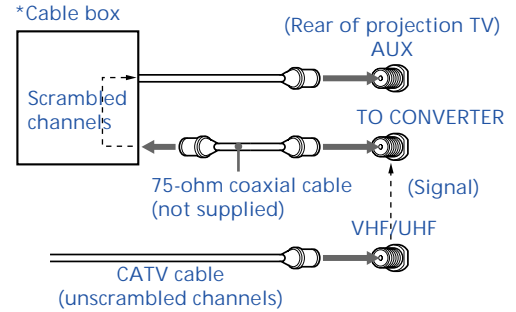

For this set up, you can switch between scrambled channels (through your cable box), and normal (CATV) channels by pressing ANT on your remote control.

Notes:

- You may be able to program your Sony remote control to operate your cable box. (see "Operating a Cable Box or Satellite Receiver (SAT)" on page 53)
- During PIP, P&P, CHANNEL INDEX or Favorite Channel viewing, the AUX input can only be viewed in the main picture.

Installing and Connecting the Projection TV (continued)

Connecting a cable TV system/
antenna to a VCR

- 1 Attach the coaxial cable from the incoming cable connection or antenna to VHF/UHF IN on the VCR.
- 2 Using a coaxial cable, connect VHF/UHF OUT on the VCR to VHF/UHF on the projection TV.
- 3 Using AUDIO and S VIDEO* cables, connect AUDIO and S VIDEO OUT on the VCR to AUDIO and S VIDEO IN on the projection TV (White-AUDIO Left, Red-AUDIO Right**).

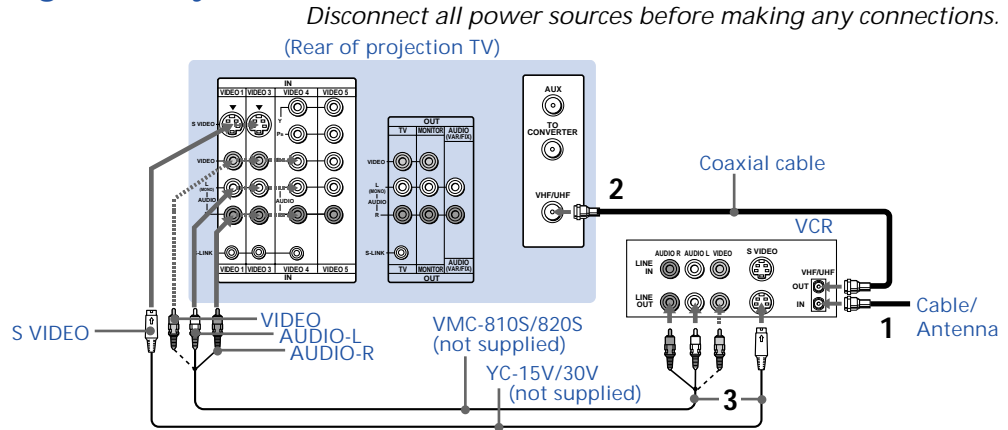

Connecting a VCR and projection
TV to a cable box

- 1 Connect the single (input) jack of the splitter to the incoming cable connection, and connect the other two (output) jacks (using the coaxial cable) to IN on the cable box and VHF/UHF on the projection TV.
- 2 Using a coaxial cable, connect OUT on the cable box to VHF/UHF IN on the VCR.
- 3 Using AUDIO and S VIDEO* cables, connect AUDIO and S VIDEO OUT on the VCR to AUDIO and S VIDEO IN on the projection TV (White-AUDIO Left, Red-AUDIO Right**).

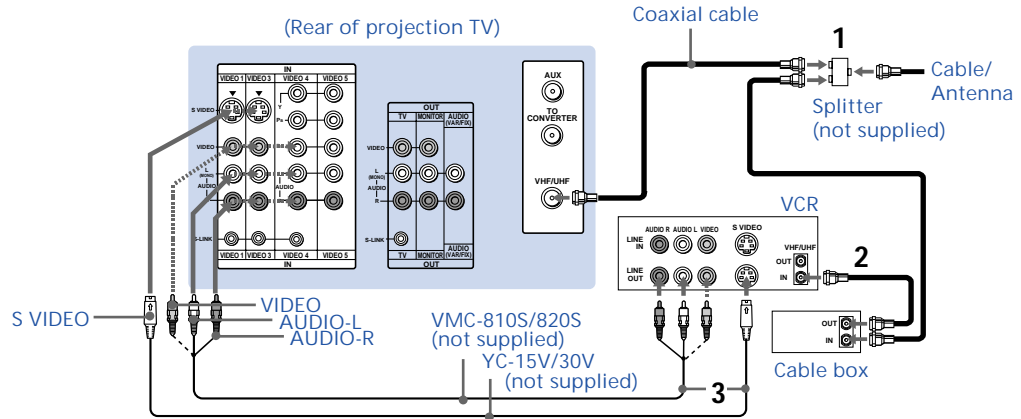

Disconnect all power sources before making any connections.

Note:

- To view scrambled channels through the cable box, select the video input which the cable box is connected to by pressing TV/VIDEO.
- * If your VCR is not equipped with S VIDEO, use a VIDEO cable (yellow) instead of the S VIDEO cable.
- ** If you are connecting a monaural VCR, connect only the single audio output to the left (MONO) input on the projection TV.

Connecting a satellite receiver (SAT)

- 1 Connect the cable from the satellite antenna to the satellite receiver.
- 2 Attach the coaxial cable from the incoming cable connection or antenna to VHF/UHF on the projection TV.
- 3 Using AUDIO and S VIDEO cables, connect AUDIO and S VIDEO OUT on the satellite receiver to AUDIO and S VIDEO IN on the projection TV (White-AUDIO Left, Red-AUDIO Right).

Note:

- To view input from the satellite receiver, select the video input which the satellite receiver is connected to by pressing TV/VIDEO on the remote control.

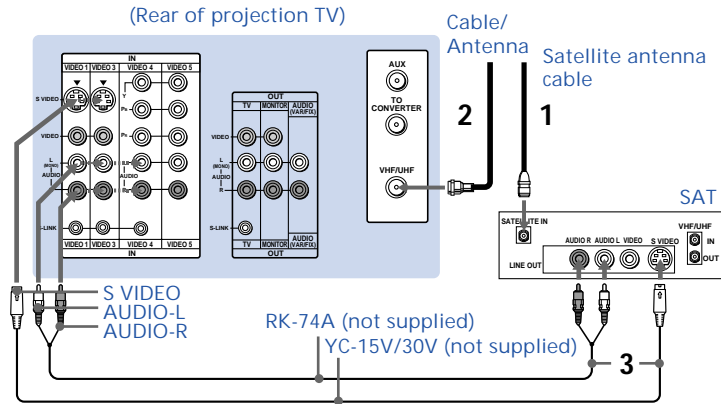

Installing and Connecting the Projection TV (continued)

Disconnect all power sources before making any connections.

Connecting a satellite receiver (SAT) and a VCR

- 1 Connect the cable from the satellite antenna to the satellite receiver.
- 2 Attach the coaxial cable from the incoming cable connection or antenna to VHF/UHF IN on the VCR.
- 3 Using a coaxial cable, connect VHF/UHF OUT on the VCR to VHF/UHF on the projection TV.
- 4 Using AUDIO and S VIDEO* cables, connect AUDIO and S VIDEO OUT on the satellite receiver to AUDIO and S VIDEO IN on the VCR.
- 5 Using AUDIO and S VIDEO* cables, connect AUDIO and S VIDEO OUT on the VCR to AUDIO and S VIDEO IN on the projection TV (White-AUDIO Left, Red-AUDIO Right).

* If your VCR is not equipped with S VIDEO, use a VIDEO cable (yellow) instead of the S VIDEO cable.

Note:

- To view input from the satellite receiver or VCR, select the video input which your satellite receiver or VCR is connected to by pressing TV/VIDEO on the remote control.

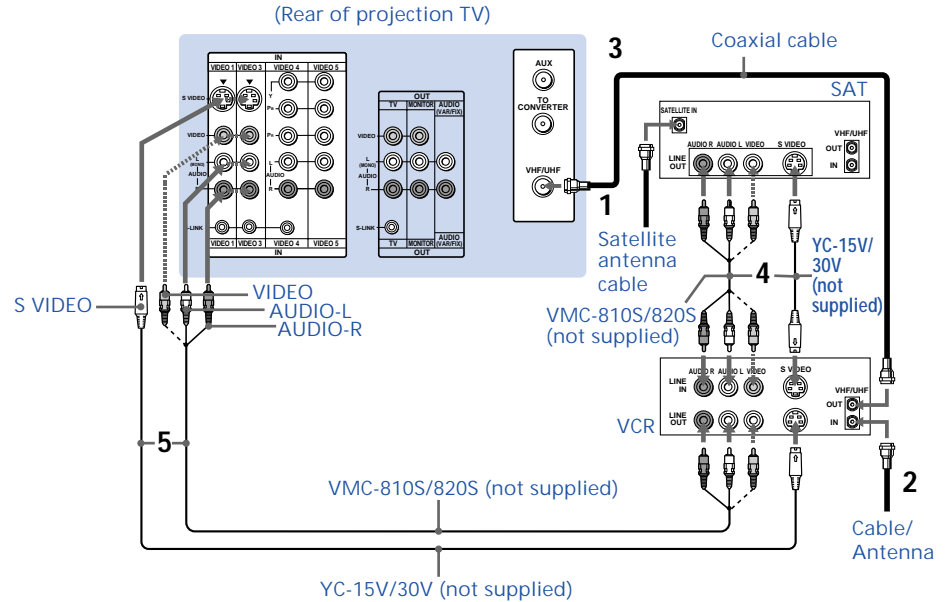

Connecting a DTV (digital television) receiver

Before connecting, be sure to read the Operating Instructions of the DTV receiver.

- 1 Attach the coaxial cable from the roof antenna to VHF/UHF on the DTV receiver.
- 2 Using three yellow VIDEO cables, connect Y, P_B and P_R of VIDEO OUT on the DTV receiver to Y, P_B and P_R of VIDEO 4 or 5 IN on the projection TV.
- 3 Using an AUDIO cable, connect AUDIO OUT on the DTV receiver to AUDIO of VIDEO 4 or 5 IN on the projection TV (White-AUDIO Left, Red-AUDIO Right).
- 4 Set the DOWN CONVERTER ON/OFF switch on the DTV receiver to ON.

Disconnect all power sources before making any connections.

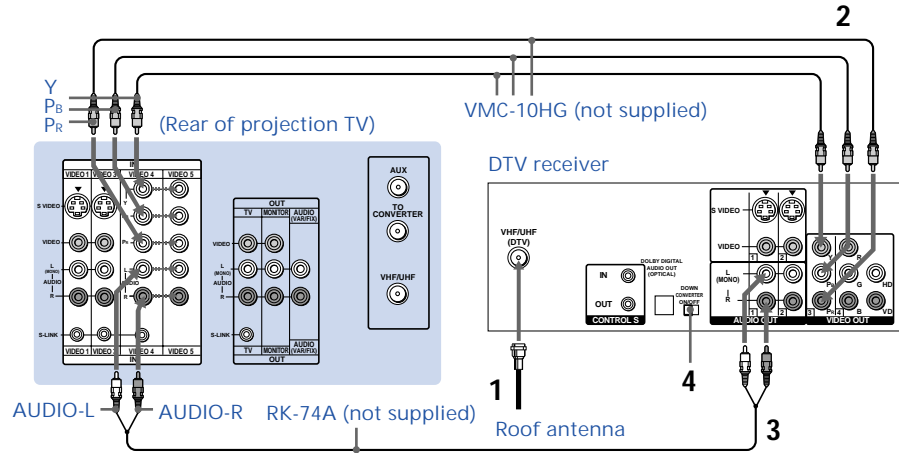

Installing and Connecting the Projection TV (continued)

Connecting a camcorder

Use this connection to view a picture directly from your camcorder.

1 Using AUDIO and S VIDEO* cables, connect AUDIO and S VIDEO OUT on the camcorder to AUDIO and S VIDEO IN inside the drop-down panel on the front of the projection TV (White-AUDIO Left, Red-AUDIO Right**).

2 Press VIDEO 2 to select the video inputs from a camcorder.

* If your camcorder is not equipped with S VIDEO, use a VIDEO cable (yellow) instead of the S VIDEO cable.

** If you are connecting a monaural camcorder, connect only the single audio output to the left (MONO) input on the projection TV.

Disconnect all power sources before making any connections.

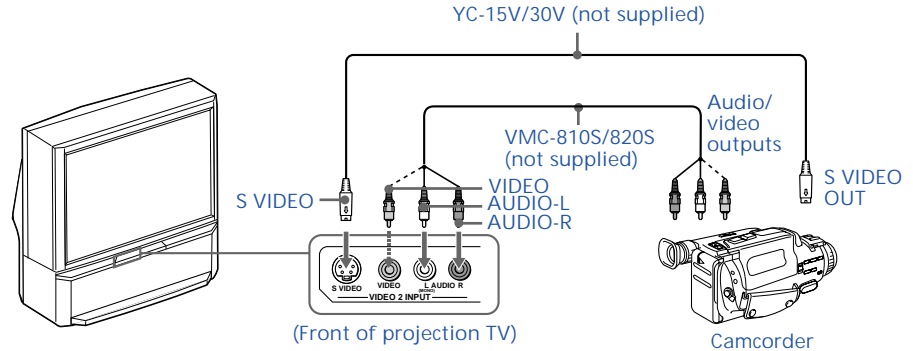

Connecting two VCRs for tape editing

By connecting a second VCR to MONITOR OUT, you can record a program being played by the primary VCR to the second VCR or perform tape editing and dubbing.

- 1 Connect the VCR intended for playback using the connection instructions on page 6 of this manual.
- 2 Using an AUDIO/VIDEO cable, connect AUDIO and VIDEO IN on the VCR intended for recording to AUDIO and VIDEO OUT of MONITOR OUT on the projection TV.

Notes:

- Do not change the input signal while editing through MONITOR OUT.
- When connecting a single VCR to the projection TV: if VCR LINE OUT is connected to VIDEO IN on the projection TV, *do not* connect MONITOR OUT on the projection TV to the VCR LINE INPUT (see right). Doing so will cause program interference and other viewing problems.

Disconnect all power sources before making any connections.

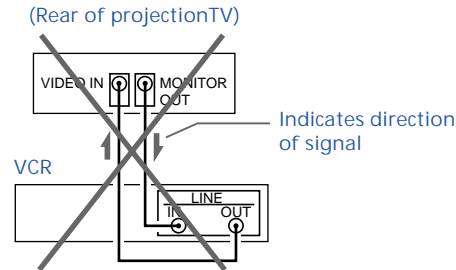
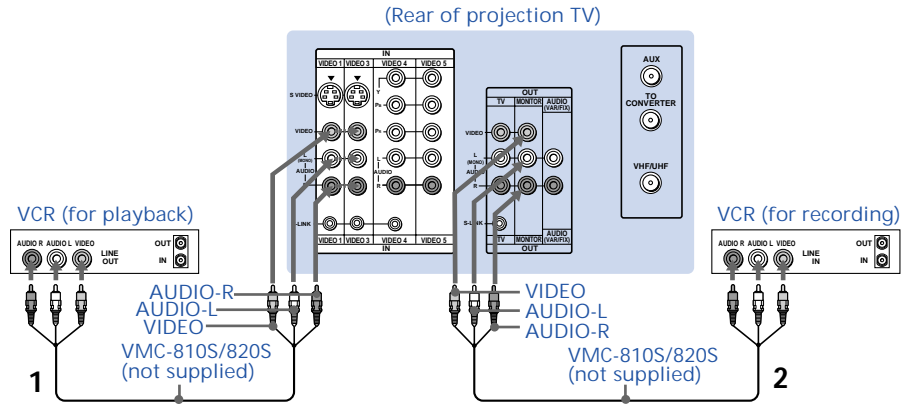

Installing and Connecting the Projection TV (continued)

Connecting a DVD Player (Upper illustration)

Using an AUDIO and S VIDEO cables, connect AUDIO and S VIDEO IN on the projection TV to AUDIO and S VIDEO OUT on the DVD Player (White-AUDIO Left, Red-AUDIO Right).

Connecting a DVD Player with component video output connectors (Lower illustration)

- Using an AUDIO cable, connect AUDIO of LINE OUT on the DVD Player to AUDIO of VIDEO 4 or 5 IN on the projection TV (White-AUDIO Left, Red-AUDIO Right).
- Using three yellow VIDEO cables, connect Y, PB, and PR of COMPONENT VIDEO OUT on the DVD Player to Y, PB, and PR of VIDEO 4 or 5 IN on the projection TV.

Notes:

- Since the high quality pictures on a DVD disc contain a lot of information, picture noise may appear. In this case, adjust “Noise Reduction” in the Video menu. (see “Noise Reduction” on page 30)
- Some DVD Player terminals may be labeled differently. If so, connect as follows:
 Connect Y (green) to Y.
 Connect PB (blue) to CB, Cb or B-Y.
 Connect PR (red) to CR, Cr or R-Y.

Disconnect all power sources before making any connections.

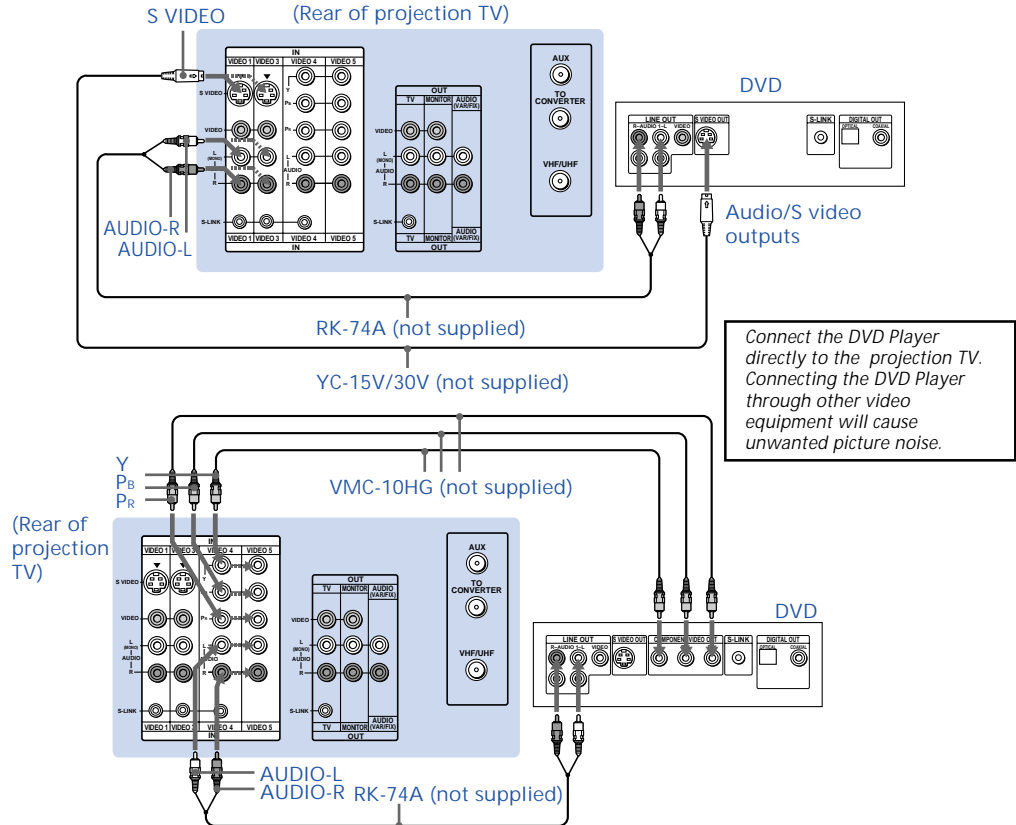

Connecting an AV receiver

For greater control of all audio and video equipment, connect an AV receiver.

- 1-2** Perform as described in “Connecting a cable TV system/antenna to a VCR” on page 6.
- 3** Using a VIDEO cable, connect VIDEO 1 IN on the projection TV to MONITOR OUT on the AV receiver.
- 4** Using an AUDIO/VIDEO cable, connect TV OUT on the projection TV to VIDEO 2 IN on the AV receiver.
- 5** Using an AUDIO/VIDEO cable, connect the video equipment to the AV receiver.

Disconnect all power sources before making any connections.

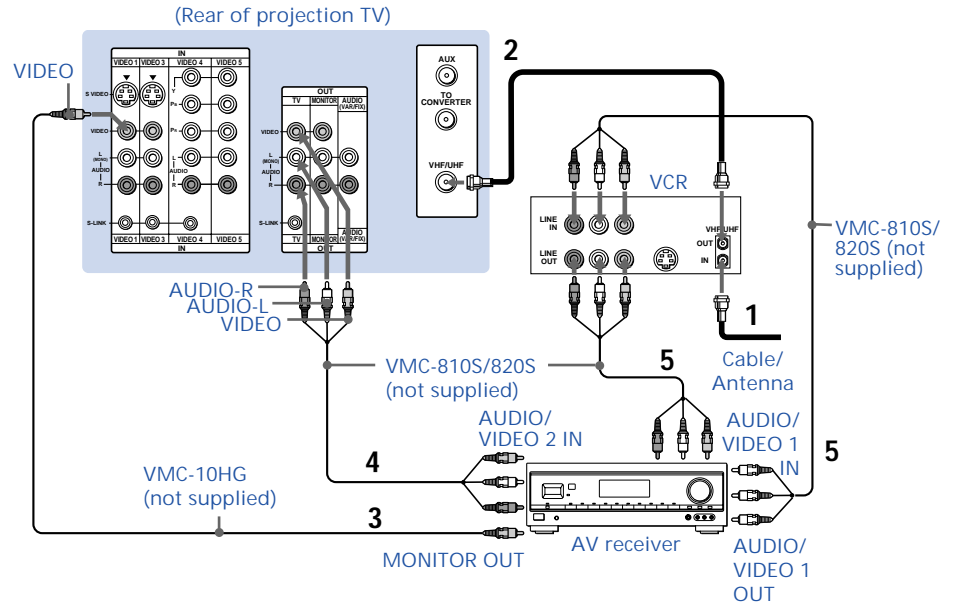

Installing and Connecting the Projection TV (continued)

Disconnect all power sources before making any connections.

Connecting an audio system

For more dynamic sound, connect an audio system to the projection TV.

- 1 Using an AUDIO cable, connect AUDIO (VAR/FIX) OUT on the projection TV to one of the unused Line inputs (e.g. Tape-2, AUX1, etc.) on the stereo.
- 2 Set the stereo to the chosen Line input and use the Audio menu to set the audio output and switch the TV's speakers off. (see "Audio Out" and "Speaker" on page 32)

Note:

- You can adjust VOLUME, "Bass," "Treble," "Balance," "MTS/SAP" and "Effect" with the supplied remote control. The control items except VOLUME can be adjusted only when "Audio Out" is set to "Variable" in the Audio menu. (see "Audio Out" on page 32)

Connecting a Sony SAVA series speaker system

Use this connection to control the speaker's Dolby Pro Logic surround system and super woofer mode with the remote control. (see "Speaker" and "SAVA SP Control" on page 32)

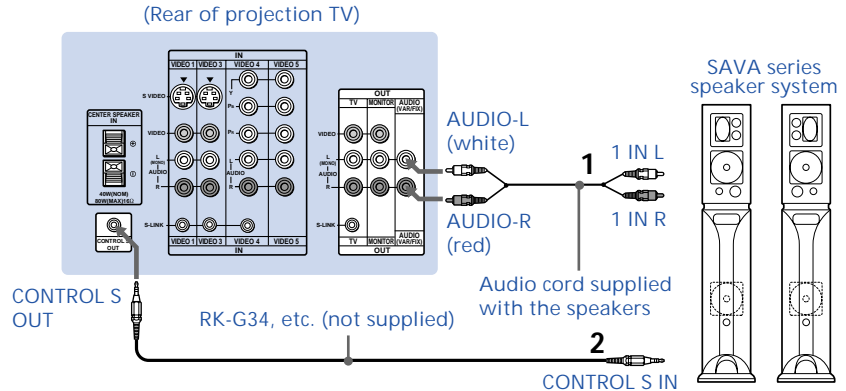
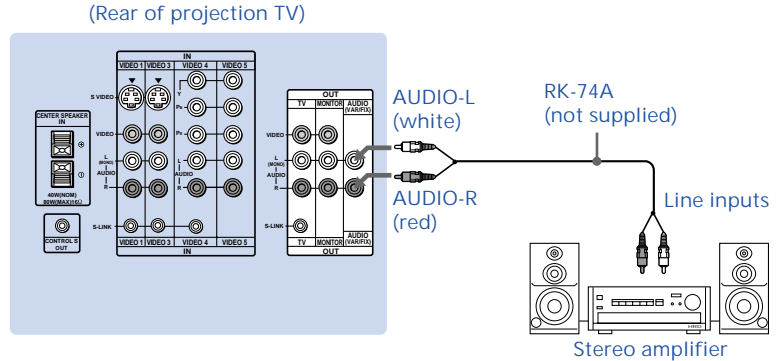

- 1 Using the AUDIO cable supplied with the speaker to AUDIO (VAR/FIX) OUT on the projection TV.
- 2 Using the CONTROL S cable, connect CONTROL S IN on the speaker to CONTROL S OUT on the projection TV.

Connecting an amplifier that supports Dolby Pro Logic decoder

If you use an amplifier with a Dolby Pro Logic decoder instead of the projection TV's audio system, you can still use the projection TV's center speaker.

- 1 Using the speaker cords (supplied with the amplifier), connect the speaker terminals on the amplifier to CENTER SPEAKER IN +/- on the projection TV.
- 2 Using an AUDIO cable, connect AUDIO (VAR/FIX) OUT on the projection TV to one of the unused Line inputs (e.g. Tape-2, AUX1, etc.) on the amplifier (White-AUDIO Left, red-AUDIO Right).
- 3 Set the amplifier to the chosen Line input and use the Audio menu to set "Speaker" to "Center" on the projection TV. (see "Speaker" on page 32)

Disconnect all power sources before making any connections.

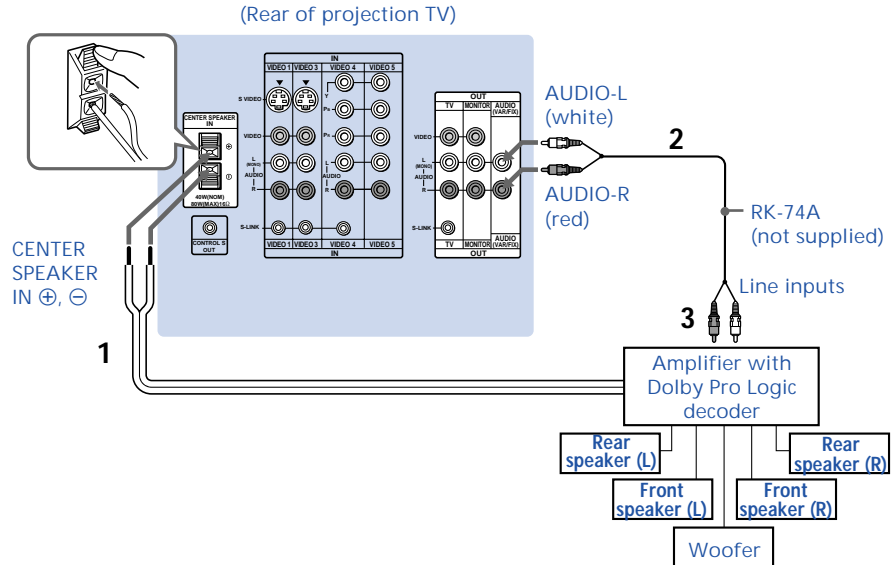

Installing and Connecting the Projection TV (continued)

Disconnect all power sources before making any connections.

Using the S-Link Function

S-Link is a Sony innovation designed to make the Sony components work together. It allows you to automatically switch the projection TV's input mode to video when you press the play button on the Sony S-Link VCR.

Using the S-Link function without a Sony AV receiver

- 1 Connect the Sony VCR (DVD). (see "Connecting a cable TV system/antenna to a VCR" on page 6 or "Connecting a DVD Player with component video output connectors" on page 12)
- 2 Using an S-LINK cable, connect the S-LINK jacks on the VCR (DVD) and the projection TV. Ensure that both ends are seated firmly and that the projection TV's S-LINK jack is in the same row as the AUDIO/VIDEO cable extending from the Sony VCR (DVD).

Refer also to the Operating Instructions supplied with the VCR, satellite receiver, DVD player, LD player and other Sony video equipment for details.

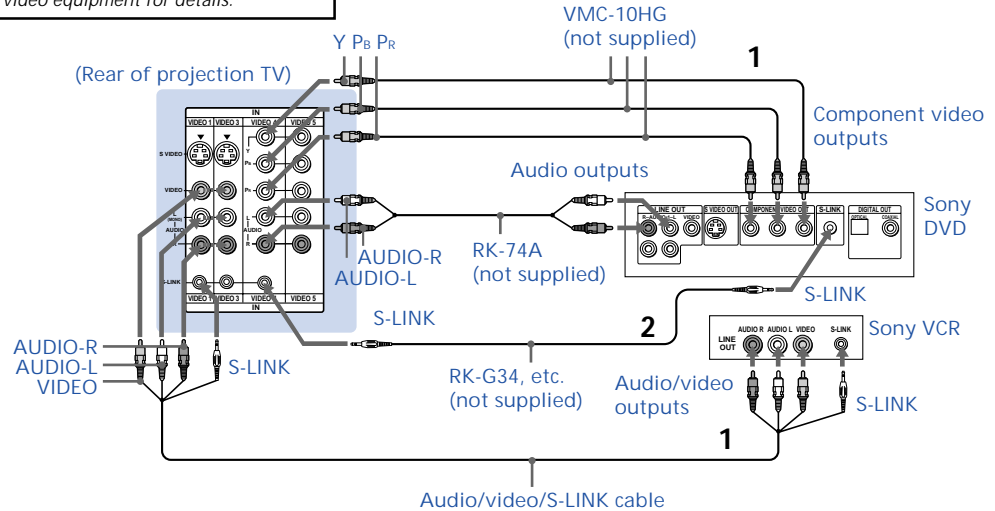

Using the S-Link function with a Sony AV receiver

- 1 Using a VIDEO cable, connect VIDEO 1 IN on the projection TV to MONITOR OUT on the Sony AV receiver.
- 2 Using an AUDIO/VIDEO cable, connect TV OUT on the projection TV to TV AUDIO and VIDEO IN on the AV receiver.
- 3 Using an S-LINK cable, connect S-LINK on the VIDEO 1 IN panel on the projection TV and S-LINK on MONITOR OUT on the AV receiver.
- 4 Using an S-LINK cable, connect S-LINK on the TV OUT panel on the projection TV to S-LINK on TV IN on the AV receiver.
- 5 Using AUDIO/VIDEO and S-LINK cables, connect the Sony video equipment to the AV receiver.
- 6 Use the Audio menu to set "Speaker" to "Off" or "Center." (see "Speaker" on page 32)
- 7 Press CH (CHANNEL) +/- to activate the S-Link function.

Disconnect all power sources before making any connections.

Refer also to the Operating Instructions supplied with the VCR, satellite receiver, DVD player, LD player and other Sony video equipment for details.

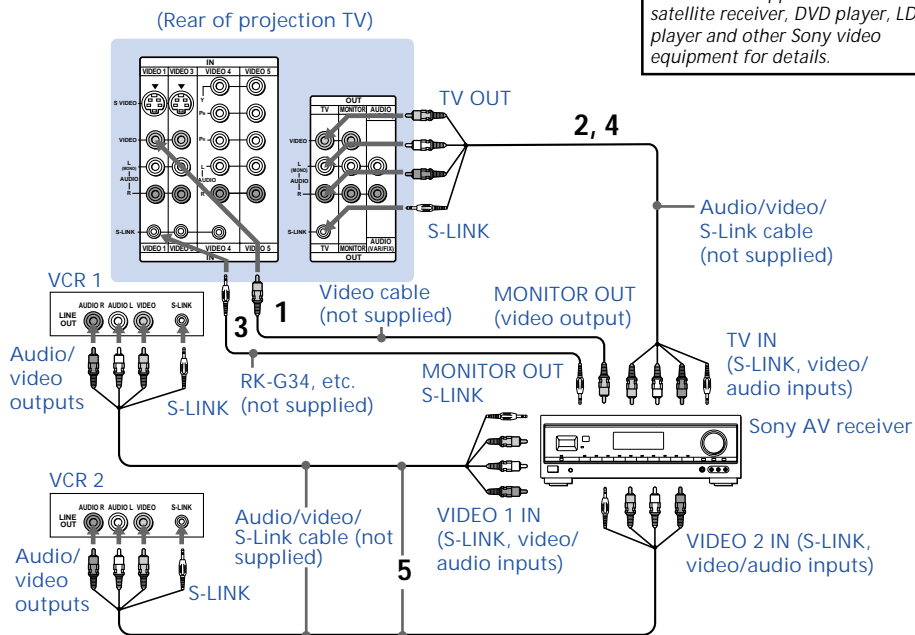

Using the Remote Control

Inserting the batteries

Insert two size AA (R6) batteries (supplied) by matching the + and - on the batteries to the diagram inside the remote control's battery compartment.

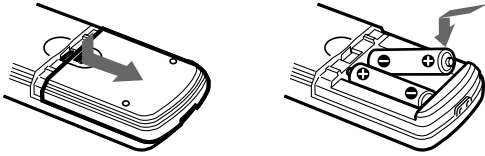

Notes:

- Remove the batteries to avoid damage from possible battery leakage whenever you anticipate that the remote control will not be used for an extended period.
- Handle the remote control with care. Avoid dropping it, getting it wet, or placing it in direct sunlight, near a heater or where the humidity is high.
- Your remote control can be programmed to operate most video equipment. (see “Operating Video Equipment” on page 51)

Using the remote control joystick

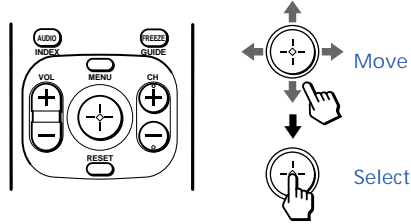

The supplied remote control has a joystick which moves the on-screen selector in four directions. In most cases, moving the joystick up, down, left or right will cause the selector to *move* in the selected direction.

In some cases, the selector may move in four directions according to the function. Pressing down on the center of the joystick (⊕) will *activate* the selected item.

You may also move the joystick right to activate a selected item. (There are some exceptions to this option.)

Adjusting Sliders

When menu items present a slider (— or —), move the joystick up, down, left or right to adjust the setting.

On Line Help/Instructions

Several menu windows will provide prompts and instructions to assist you in navigating through the different functions.

Setting Up the Projection TV Automatically

The AUTO SET UP feature will allow you to set the on-screen language and set all receivable channels.

The AUTO SET UP feature does not apply for installations that use a cable box for all channel selection.

You can also set up the projection TV manually. (see "Using the Channel Set Up menu" on pages 34 and 35)

Notes:

- Before you perform AUTO SET UP again, make sure that the input from ANT (not AUX) is selected by pressing ANT until "AUX" does not appear next to the channel number.
- Perform this function during the day, with the antenna and/or cable properly connected, to ensure that all available channels will be broadcasting and receivable.
- When you perform AUTO SET UP, all the settings in the Video, and Audio menus are reset to the factory settings.

Using the buttons on the front panel and inside the drop-down panel on the projection TV:

Front panel:

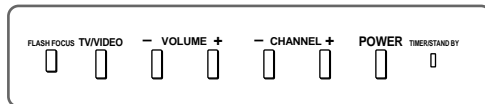

Inside the drop-down panel:

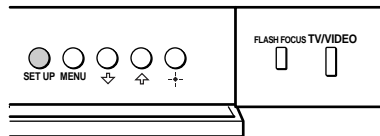

- 1 Press POWER to turn on the projection TV.



- 2 Press SET UP inside the drop-down panel. The AUTO SET UP screen appears.

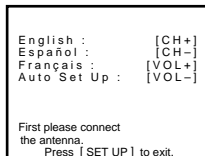

- 3 Press CHANNEL + to select English, CHANNEL - to select Español or VOLUME + to select Français.

The screen will change to reflect your choice.

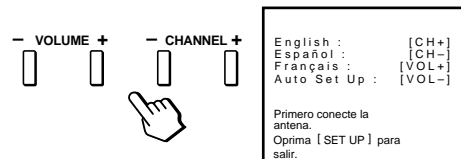

- 4 Press VOLUME - to continue.

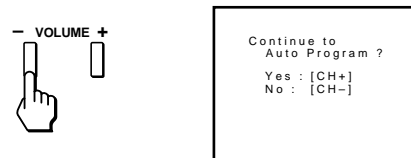

(continued)

Basic Set Up (continued)

- 5 Press CHANNEL + to preset channels automatically.

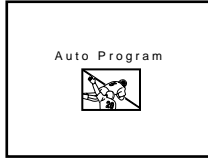
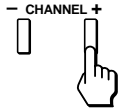

“Auto Program” appears and the projection TV starts scanning and presetting channels automatically. While scanning, the received channel will be displayed on the sub screen. When all the receivable channels are stored, the lowest numbered channel is displayed.

To perform AUTO SET UP again

Press SET UP inside the drop-down panel on the projection TV and perform steps 3-5 on pages 19 and 20.

Press SET UP again to exit.

Adjusting the Convergence Automatically (FLASH FOCUS)

The projection tube image appears on the screen in three layers (red, green and blue). If they do not converge, the color is poor and the picture blurs.

Before you use your projection TV, be sure to adjust the convergence.

The FLASH FOCUS feature allows you to adjust the convergence automatically.

Tips

- It is recommended to perform FLASH FOCUS about 30 minutes after the projection TV is first turned on.
- You can also perform FLASH FOCUS using the Set Up menu on page 39.

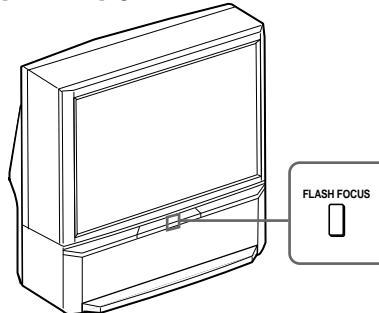

Press FLASH FOCUS.



The cross pattern appears and FLASH FOCUS begins to work. The adjustment is completed when the cross pattern becomes white.

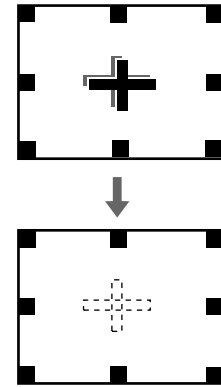

Note:



- FLASH FOCUS is canceled if you perform any other function while FLASH FOCUS is working.

Watching the TV

Many TV features can be accessed directly through the remote control. The following chart will explain the function of some buttons found on your remote control.



REFER TO THE
ILLUSTRATION OF THE
REMOTE CONTROL ON THE
INSIDE FRONT COVER OF
THIS MANUAL AS YOU
REVIEW THIS CHART

Using the White Labeled Buttons for Projection TV Operations	
TV (FUNCTION)	Activates the remote control for use with the projection TV.
TV POWER	Turns the projection TV on and off. If a video input indication (e.g., VIDEO 1, VIDEO 2) appears on the screen, press TV/VIDEO until a channel number appears.
 -  and ENTER	Use for direct channel selection. Press 0-9 to select a channel (for example, to select channel 10, press 1 and 0). The channel will change after 2 seconds, or you can press ENTER for immediate selection.
CH +/-	Press to scan through the channels (+ up or - down). Speed Surf 1 Press and hold CH + or - to change the channel number rapidly. 2 Release to display the desired channel.
VOL +/-	Press to adjust the volume (+ up or - down).
MUTING	Press to mute the sound. "Muting" will appear on the screen and will dim three seconds later. To restore sound, press again or press VOL +.

(continued)

PICTURE MODE

Press PICTURE MODE repeatedly to directly choose one of five different video modes that best suits the program you are watching.

Vivid: Select for enhanced picture contrast and sharpness.

Standard: Select to display a standard picture for normal viewing environments.

Movie: Select to display a finely detailed picture for low light environments.

Personal 1, Personal 2: Select to customize the "Picture Adjustment" of the Video menu according to your personal preference.

When you select "Movie," "Personal 1" and "Personal 2," you can also perform the "Picture Adjustment" (such as "Brightness," "Color," etc.) to suit your taste. For details, see "Mode" on page 30.

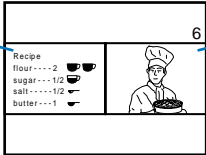

Using Your New Projection TV (continued)

Using the White Labeled Buttons for Projection TV Operations	
TV/VIDEO	<p>Press repeatedly to scroll through available video inputs: TV, VIDEO 1, VIDEO 2, VIDEO 3, VIDEO 4 and VIDEO 5.</p> <p>If you select "Skip" as a "Video Label" in the Set Up menu, your projection TV will skip the video input you selected. (see "Video Label" on page 39)</p>
JUMP	<p>Press to alternate or <i>jump</i> back and forth between two channels. The projection TV will jump between the current channel and the last channel selected using the 0-9 buttons.</p>
FREEZE <i>(yellow labeled button)</i>	<p>This is useful when you need to copy down information that appears on the TV's screen.</p> <p>Press to <i>freeze</i> the desired picture. The frozen picture is displayed on the left of the screen while viewing the normal picture of the current channel on the right.</p> <div style="text-align: center;">  </div> <p>Press again to display the normal picture.</p>
DISPLAY	<p>Press to display the channel number, current time, channel caption (if set), and MTS mode (if SAP is selected). The SAP indication disappears and the other indications dim three seconds later.</p> <p>To turn the display off, press DISPLAY again.</p>

Tip

Some control buttons are located under the cover on the top of the remote control. They are indicated with (under the cover) in the table.

Using the White Labeled Buttons for Projection TV Operations

<p> <i>(under the cover)</i></p>	<p>Press repeatedly to scroll through available displays: XDS (Extended Data Service) Displays a network name, program name, program type, program length, program description, call letters and time of the show if the broadcaster offers this service. Caption Vision Displayed on the screen if the broadcaster offers this service. (see "Caption Vision" on page 38) No display "Off" appears and the display is canceled.</p>
<p>SLEEP <i>(under the cover)</i></p>	<p>Press repeatedly until the projection TV displays the approximate time in minutes (30, 60, or 90) that you want the projection TV to remain on before shutting off automatically. Cancel by pressing until "Sleep Off" appears.</p>
<p>ANT <i>(AUX input)</i></p>	<p>Press to change between the VHF/UHF input and the AUX input. (for detailed connection information, see "Cable and antenna" or "Cable box and cable" on page 5)</p>
<p>MTS/SAP <i>(under the cover)</i></p>	<p>Press to scroll through the Multi-channel TV Sound (MTS) options: Stereo, SAP, Mono and Auto SAP. (see "MTS/SAP" on page 31)</p>
<p></p>	<p>Press to select an audio option: Trusurround, Simulated and Effect Off. (see "Effect" on page 31)</p>
<p>TV/VTR <i>(under the cover)</i></p>	<p>Press when you are finished using a VCR and you want to switch to the TV input. The VCR power will remain on.</p>
<p>SYSTEM OFF <i>(under the cover)</i></p>	<p>Press to turn off the projection TV and all other equipment connected with S-Link. (see page 16)</p>



REFER TO THE
 ILLUSTRATION OF THE
 REMOTE CONTROL ON THE
 INSIDE FRONT COVER OF
 THIS MANUAL AS YOU
 REVIEW THIS CHART

Using Your New Projection TV (continued)

Watching Two Programs at One Time — PIP

The Picture-in-Picture (PIP) feature allows you to view two channels simultaneously, one in the full size “main” picture and one in a smaller “window” picture.

You can move the window picture to any location on the screen.

The symbol “➔” or “➜” indicates which picture’s TV channel or input source can be changed.

The symbol “♪” indicates which picture’s sound is being received.

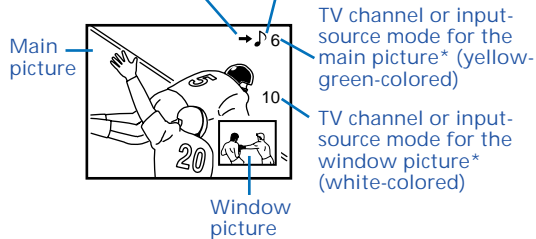







* It will dim in about 3 seconds.





Tip

If you press **RESET** in PIP mode, the window picture will move to the bottom right (factory-preset location).

Using the Yellow Labeled Buttons for PIP Operations

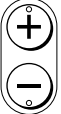
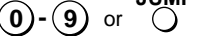
	<p>Press to display a window picture.</p> <p>Each time you press this button, the picture size will change (1/4 → 1/9 → 1/16 → no display).</p> <p style="text-align: center;">↑</p> <p>To close the window picture, press  repeatedly until it disappears.</p>
<p>POSITION</p>  <i>(under the cover)</i>	<p>Press to change the location of the window picture (counterclockwise) around the main picture.</p>
<p>ACTIVE</p> 	<p>Press to select either the main or window picture in order to change the TV channel or video source using the white labeled buttons below. The symbol “➔” (or “➜”) will appear to indicate which picture’s channel or input mode can be changed.</p>
 <i>(white labeled button)</i>	<p>To change the location of the window picture, move the joystick in any direction and release it when the picture is in the desired location.</p>
<p>TV/VIDEO</p>  <i>(white labeled button)</i>	<p>Press repeatedly to scroll through the available video inputs for the picture on which the symbol “➔” (or “➜”) is displayed. (see “TV/VIDEO” on page 22)</p>

Using the Yellow Labeled Buttons for PIP Operations

<p>CH</p>  <p>or 0-9 or JUMP</p>  <p>and ENTER</p> <p><i>(white labeled button)</i></p>	<p>Press to select the TV channel on which the symbol “➔” is displayed. (for details, see “Watching the TV” on page 21)</p> <p>Speed Surf</p> <ol style="list-style-type: none"> 1 Press and hold CH + or – to change the channel number rapidly. 2 Release to display the desired channel.
<p>ANT</p>  <p><i>(white labeled button)</i></p>	<p>Press to change between the VHF/UHF input and the AUX input for the picture on which the symbol “➔” (or “⚡”) is displayed.</p>
<p>AUDIO INDEX</p> 	<p>Press to alternate sound between the main picture and the window picture. The symbol “🎵” will appear for a few seconds to indicate which picture's sound is being received.</p>
<p>FREEZE GUIDE</p> 	<p>This is useful when you need to copy down information of the main picture. Press to freeze the desired scene in the main picture. The frozen picture is displayed in the window picture while viewing the normal picture in the main picture. The window picture size is automatically changed to 1/4 if it was 1/9 or 1/16. Press again to resume normal PIP viewing.</p>
<p>SWAP</p>  <p><i>(under the cover)</i></p>	<p>Press to switch the audio and video of the main picture and the window picture. Each time you press SWAP, the picture and sound of the two will be exchanged.</p>



REFER TO THE ILLUSTRATION OF THE REMOTE CONTROL ON THE INSIDE FRONT COVER OF THIS MANUAL AS YOU REVIEW THIS CHART

Note:

- If one of the pictures received through PIP is snowy, the entire screen may become unstable. In this case, erase the snowy channel. (see “Channel Skip/Add” on page 35)





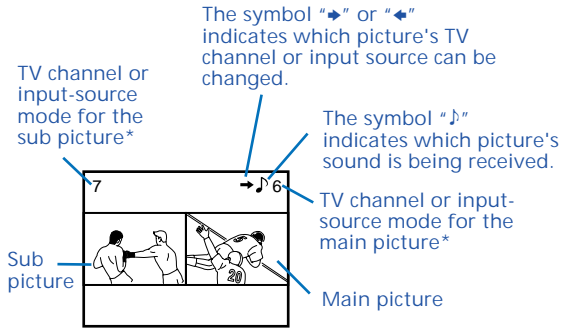

Using Your New Projection TV (continued)

Watching Two Programs at One Time — P&P (Twin View™)

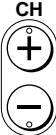

The Picture-and-Picture (P&P) feature allows you to view two channels simultaneously, both in a reduced size screen. The main picture will appear on the right.



* It will dim in about 3 seconds.

Using the Yellow Labeled Buttons for P&P Operations	
	Press to display right (main) and left (sub) pictures. Press again to close the sub picture.
	Press to select either the right or left picture in order to change the TV channel or video source using the white labeled buttons below. The symbol "↔" (or "←") will appear to indicate which picture's channel or input mode can be changed.
 <i>(white labeled button)</i>	Press repeatedly to scroll through the available video inputs for the picture on which the symbol "↔" (or "←") is displayed. (see "TV/VIDEO" on page 22)
 or  or  <i>(white labeled button)</i>	Press to select the TV channel on which the symbol "↔" (or "←") is displayed. (for details, see "Watching the TV" on page 21) Speed Surf 1 Press and hold CH + or – to change the channel number rapidly. 2 Release to display the desired channel.
 <i>(white labeled button)</i>	Press to change between the VHF/UHF input and the AUX input for the picture on which the symbol "↔" (or "←") is displayed.

Using the Yellow Labeled Buttons for P&P Operations

	<p>Press to alternate sound between the right and left pictures. The symbol “♪” will appear for a few seconds to indicate which picture’s sound is being received.</p>
	<p>This is useful when you need to copy down information that appears on the TV’s screen. Press to freeze both the right and left pictures. Press again to resume P&P viewing.</p>
<p>SWAP  <i>(under the cover)</i></p>	<p>Press to switch the audio and video of the right and left pictures. Each time you press SWAP, the picture and sound of the two will be exchanged.</p>



REFER TO THE
ILLUSTRATION OF THE
REMOTE CONTROL ON THE
INSIDE FRONT COVER OF
THIS MANUAL AS YOU
REVIEW THIS CHART

Notes:

- The sound of the left (sub) picture is monaural.
- Caption Vision is displayed for the right (main) picture only.
- If one of the pictures received through P&P is snowy, the entire screen may become unstable. In this case, erase the snowy channel. (see “Channel Skip/Add” on page 35)

Using Your New Projection TV (continued)

Using CHANNEL INDEX

You can use the CHANNEL INDEX feature to display multiple channels and select one directly.

Channels used for CHANNEL INDEX will come directly from the TV's list of receivable channels (those set during Auto Program or through the Channel Set Up menu).

1 Press .

The current channel will be reduced in size and displayed in the center of the screen in normal motion picture format. The first twelve receivable channels will appear one after another, clockwise, around the center picture. These small pictures are updated in intervals of one second. The channel number and channel caption (if set) on the second and later appearances will dim.

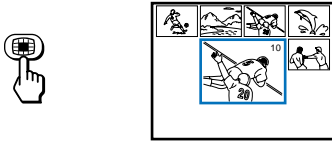

A yellow-colored frame will appear to indicate current channel selection.

2 Move the joystick in any direction to move the yellow frame to the picture that you wish to view.



3 Press .

The selected picture will be enlarged for normal viewing.

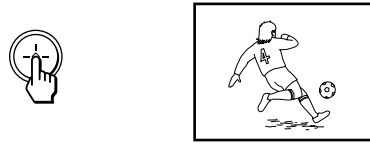

To cancel CHANNEL INDEX

Press  again, or select a TV channel using the 0-9 and ENTER buttons.

Tips

- To cycle through the receivable channels at a time, press CH +/-.
- To freeze the center picture, press FREEZE. Press it again to resume normal center picture viewing.

Notes:

- The projection TV will continually update each of the surrounding pictures while the CHANNEL INDEX screen is displayed.
- Sound will only be heard from the center picture.
- If one of the pictures received through CHANNEL INDEX is snowy, the entire screen may become unstable. In this case, erase the snowy channel. (see "Channel Skip/Add" on page 35)
- If you leave the CHANNEL INDEX screen displayed for about 20 minutes without any additional operation, CHANNEL INDEX is canceled and the normal picture reappears.

Adjusting Your SET UP (menus)

Learning Menu Selection

Use the MENU button to access a menu and use the joystick to alter the settings. Use the following example to learn how to modify settings.

- 1 Press the MENU button.
The main menu appears.

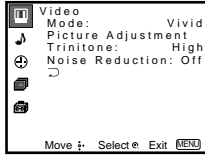

- 2 Move the joystick up or down to highlight the desired menu and press \oplus (press down on the center of the joystick) to activate it.

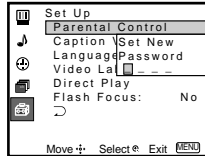
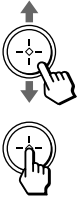

You may also move the joystick right to activate your selection.

- 3 Move the joystick up or down to highlight the desired option.



- 4 Press \oplus (press down on the center of the joystick).
Options for your selection (Pop-up menu or Adjusting menu) will be displayed.

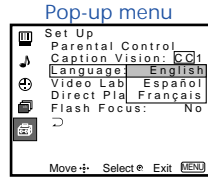

- 5 Move the joystick up or down to make your selection and press \oplus to activate it. The previous screen will reappear.

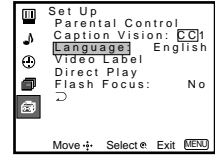

Some adjustment menus may require further operations. For details, see each menu option.

To return to the previous screen (except for the slider adjustment menus), choose " \curvearrowright " at the bottom of the menu and press \oplus or move the joystick left.

- 6 Once you have completed all menu corrections, press MENU to exit the menu screens.



To exit from the menus at any time

Press MENU.

Tip 

You can also use the MENU, \uparrow/\downarrow and \leftarrow buttons inside the front drop-down panel of the projection TV for the menu selection.

Adjusting Your SET UP (menus) (continued)

Using the Video Menu

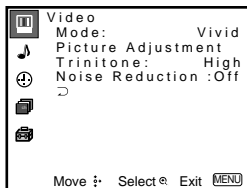

For detailed information on using the remote control to modify menu settings, refer to “Learning Menu Selection” on page 29.

To select the Video  menu:

Display  Highlight   Select

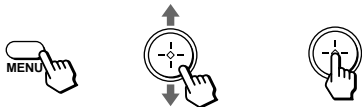

To restore the factory settings
Press RESET on the remote control while the Video menu is selected. To restore each “Mode” to the factory setting, press RESET after selecting the mode to be reset.

<p>Mode <i>Customized picture viewing</i></p>	<p>You can choose one of five different video modes that best suits the program you are watching. You can also perform the “Picture Adjustment” (such as “Brightness,” “Color,” etc.) for “Movie,” “Personal 1” or “Personal 2” to suit your taste.</p> <p>Vivid: Select for enhanced picture contrast and sharpness.</p> <p>Standard: Select to display a standard picture for normal viewing environments.</p> <p>Movie: Select to display a finely detailed picture for low light environments.</p> <p>Personal 1, Personal 2: Select to customize the “Picture Adjustment” of the Video menu according to your personal preference.</p> <p><i>Press PICTURE MODE on the remote control for direct selection of a “Mode” setting.</i></p>
<p>Picture Adjustment <i>Picture adjustment</i></p>	<p>First select “Movie,” “Personal 1” or “Personal 2” from “Mode,” then highlight the desired option using the joystick and press  to display the adjusting slider of the selected option.</p> <p>Picture: Adjust slider right (up) to increase picture contrast; left (down) to decrease it.</p> <p>Brightness: Adjust slider right (up) to brighten the picture; left (down) to darken it.</p> <p>Color: Adjust slider right (up) to increase color intensity; left (down) to decrease it.</p> <p>Hue: Adjust slider right (up) to increase the green tones; left (down) to increase the red tones.</p> <p>Sharpness: Adjust slider right (up) to sharpen the picture; left (down) to soften it.</p>
<p>Trinitone <i>White intensity adjustment</i></p>	<p>High: Select to give the white colors a blueish tint.</p> <p>Medium: Select to give the white colors a neutral tint.</p> <p>NTSC Standard: Select to give the white colors a reddish tint.</p>
<p>Noise Reduction <i>Noise reduction</i></p>	<p>Select On to reduce picture noise. Select Off to cancel the feature.</p> <p><i>“Noise Reduction” can be set separately from the “Mode” settings of the Video menu.</i></p>

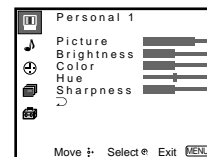

Using the Audio Menu

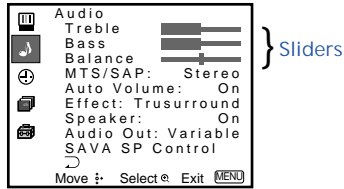

For detailed information on using the remote control to modify menu settings, refer to “Learning Menu Selection” on page 29.

To select the Audio menu:

Display Highlight Select

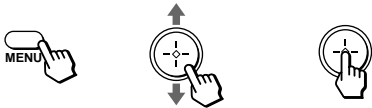

To restore the factory settings

Press RESET on the remote control while the Audio menu is selected.

Treble <i>Sound adjustment</i>	Adjust slider right (up) to increase high pitched sounds. Adjust slider left (down) to decrease high pitched sounds.
Bass <i>Sound adjustment</i>	Adjust slider right (up) to increase low pitched sounds. Adjust slider left (down) to decrease low pitched sounds.
Balance <i>Sound adjustment</i>	Adjust slider right (up) to emphasize right speaker volume. Adjust slider left (down) to emphasize left speaker volume.
MTS/SAP <i>Enjoy stereo, bilingual and mono programs.</i>	When the sound is intermittent due to poor reception conditions, select “Stereo” or “SAP.” Stereo: Select for stereo reception when viewing a program broadcast in stereo. SAP: Select to listen to a bilingual broadcast. (non-SAP programs will be muted when this feature is selected) Mono: Select for mono reception. (use to reduce noise during stereo broadcasts) Auto SAP: Select to listen to SAP when a SAP program is broadcast and return to stereo reception automatically for non-SAP programs. Quick MTS access: Press on the remote control to cycle through the “MTS/SAP” options as follows: Stereo → SAP → Mono → Auto SAP.
Auto Volume <i>Adjust the sound level.</i>	On: Sound output coming from TV speakers have the volume level equalized for all channel audio inputs when broadcasts have different sound transmission levels. Off: Sound output coming from the TV speakers varies according to the received channel.
Effect <i>Customizes surround sound effects based on the program's audio type.</i>	“Effect” can only be set when “Speaker” is set to “On” or “Off.” Trusurround: Produces a virtual surround effect for Dolby-surround encoded programs. Simulated: Adds a surround-like effect to mono programs. Off: Normal stereo or mono reception. Quick Effect access: Press on the remote control to cycle through the “Effect” options as follows: Trusurround → Simulated → Effect Off.

(continued)

Adjusting Your SET UP (menus) (continued)

<p>Speaker <i>Custom selection of audio output source</i></p>	<p>On: Select to listen to the sound from the projection TV speakers alone. Off: Select to turn off the projection TV speakers and listen to the projection TV's sound only through an external audio system's speakers. SAVA SP: Select to turn off the projection TV speakers and listen to the projection TV's sound only through the Sony SAVA series speaker system. You can adjust volume, muting, "Surround Mode," and "Super Woofer Mode" with the projection TV's remote control. (see "SAVA SP Control" below) Center: Select to use the projection TV as center speaker when you connect an amplifier with a Dolby Pro Logic decoder. (see "Connecting an amplifier that supports Dolby Pro Logic decoder" on page 15)</p>
<p>Audio Out <i>Easy control of volume adjustment</i></p>	<p>"Audio Out" can only be set when "Speaker" is set to "Off." Fixed: Sound output is held at a fixed level through the audio system. Use the AV receiver's remote control to adjust the volume. Variable: Sound output varies according to the TV settings. Useful when you want to use your remote control to control the output of a separate audio system.</p>
<p>SAVA SP Control <i>Controls Sony SAVA speaker's mode.</i></p>	<p>"SAVA SP Control" can only be set when Sony SAVA speaker system is connected to the AUDIO (VAR/FIX) OUT connectors and "Speaker" is set to "SAVA SP." (see "Speaker" above) You can also adjust the SAVA speaker's volume using VOL +/- of the projection TV's remote control. Surround Mode: Select to activate the SAVA Speaker's surround mode. Super Woofer Mode: Select to activate the SAVA Speaker's super woofer mode.</p>

⌚ Using the Timer Menu

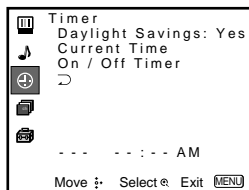

After setting the clock you can use the timer to turn the projection TV on and off.

For detailed information on using the remote control to modify menu settings, refer to “Learning Menu Selection” on page 29.

To select the Timer ⌚ menu:

Display → Highlight ⌚ → Select

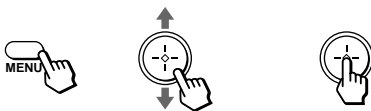

Tip 💡

Set daylight saving time before setting the clock. Any loss of power will cause these settings to be erased.

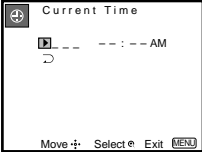
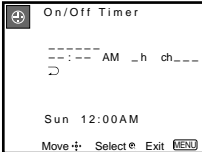
<p>Daylight Savings <i>Automatically adjusts the time.</i></p>	<p>Spring: Select Yes to compensate for Daylight Saving Time. The current time automatically moves ahead one hour. Fall: Select No at the end of Daylight Saving Time. The current time moves back one hour.</p>
<p>Current Time <i>Necessary for the Timer.</i></p>	<ol style="list-style-type: none"> 1 Press \oplus, then move the joystick up or down until the current day (Sun - Sat) is displayed, and press \oplus. 2 Move the joystick up or down until the current hour (1-12) and AM/PM is displayed, and press \oplus. 3 Move the joystick up or down until the current minute (00-59) is displayed, and press \oplus. The clock has now started. Press MENU to exit. 
<p>On/Off Timer <i>Wake up or scheduled viewing.</i></p>	<ol style="list-style-type: none"> 1 Move the joystick up or down until the desired day or range of days (Every Sun-Sat, Every Mon-Fri, Sunday, Monday, ...Saturday, Every Sunday, ...Every Saturday) is displayed, and press \oplus. 2 Move the joystick up or down until the time (hours and minutes) that you want the projection TV to remain on is displayed, and then press \oplus. 3 Move the joystick up or down to set the time duration (maximum of 6 hours) and press \oplus. 4 Move the joystick up or down to select the desired channel and press \oplus. The timer is now set. The TIMER/STAND BY indicator on your projection TV will be lit. Press MENU to exit. To cancel your timer setting, press RESET while in the On/Off Timer window. Performing Auto Program will erase all Timer settings. 

Adjusting Your SET UP (menus) (continued)

Using the Channel Set Up Menu

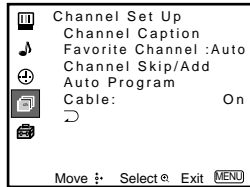

For detailed information on using the remote control to modify menu settings, refer to “Learning Menu Selection” on page 29.

To select the Channel Set Up menu:

Display → Highlight → Select

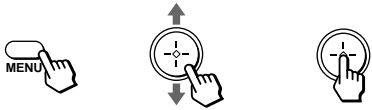

Channel Caption

Easy recognition of the channel you are watching

You can add a caption for up to 32 channels of VHF/ UHF input.

With the Channel Caption window open:

- 1 Press \oplus and then move the joystick up or down to select the desired channel. You can view the channel that is selected with the Channel Caption menu in the sub screen.
- 2 Press \oplus .
- 3 Move the joystick up or down to display the first letter or number of the caption and press \oplus to select it. Repeat until up to five digits are selected.
- 4 Press \oplus .

To erase a caption, press RESET.

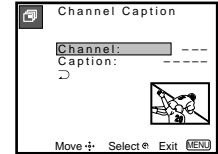



Favorite Channel

User's favorite channels

The Favorite Channel feature enables easy access to the eight channels that you preset (or the last channel that you were watching).

(for details on how to set up this feature, see “Setting and Selecting Favorite Channel” on page 36)

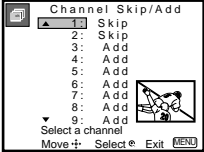
<p>Channel Skip/Add <i>Skips unnecessary channels.</i></p>	<p>After AUTO SET UP, you can erase unnecessary channels from the channel preset memory. With the Channel Skip/Add window open:</p> <ol style="list-style-type: none"> 1 Move the joystick up or down to select the desired channel. You can view the channel that is selected with the Channel Skip/Add menu in the sub screen. You can also use CH +/- or 0-9 and ENTER buttons. 2 Press . 3 Move the joystick up or down to select Skip, and press . <p>The selected channel will be erased. If you want to re-enter the skipped channel, follow the steps above and select Add.</p> 
<p>Auto Program <i>Automatic channel presetting</i></p>	<p>Select Yes to signal the projection TV to automatically program all receivable channels. When all the receivable channels are stored, the lowest numbered channel is displayed. Select No to cancel Auto Program.</p>
<p>Cable <i>Cable system setting</i></p>	<p>Select On if your projection TV is connected to a cable system. Select Off if your projection TV is connected to an antenna.</p>

Adjusting Your SET UP (menus) (continued)

Setting and Selecting Favorite Channel

The Favorite Channel feature of your projection TV enables easy access to the eight channels that you preset (or the last channel that you were watching).

Your Favorite Channel options can be set automatically or manually.

The factory setting for “Favorite Channel” is “Auto.”

When “Favorite Channel” is set to “Auto,” the last eight channels selected with the 0–9 buttons will be set as Favorite Channel options. If you want to input your own selections as Favorite Channel settings, set to “Manual.”

Setting Favorite Channel manually

- 1 Select “Favorite Channel” from the Channel Set Up menu. (see page 34)

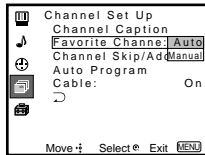

- 2 Move the joystick up or down to select “Manual” and press \oplus .

The Favorite Channel menu will appear. If you set Channel Caption names (e.g. CNN, HBO), they will also be displayed. (see “Channel Caption” on page 34)

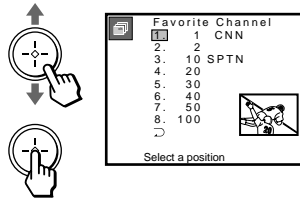

- 3 Move the joystick up or down to select a position (1–8), and press \oplus .

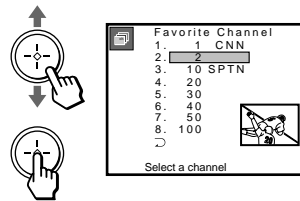

- 4 Move the joystick up or down to select a channel.

You have now selected a favorite channel.

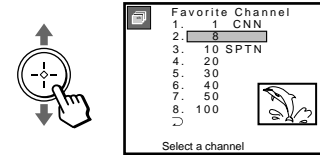

- 5 Press \oplus and use the joystick to program other favorite channels. (Follow steps 3 and 4.)
- 6 Press MENU when you have finished. Your favorite channels are now ready for use.

Changing Favorite Channel choices

You have the option of returning to the Favorite Channel screen to adjust any of your favorite channel choices.

Simply proceed as described in “Setting Favorite Channel manually” (skip step 2 if “Manual” is already selected).

When you reach step 3, select the position you want to change and press \oplus . Move the joystick up or down to select a new channel.

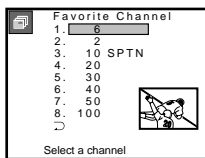

Press MENU when you are done.

Note:

- The Favorite Channel feature is not available for the picture input from AUX.

Using Favorite Channel

You can use the Favorite Channel feature to directly select the channel you want to watch.

- 1 Press \oplus once.

The favorite channel menu and a window picture will be superimposed over the current channel. The window picture displays the channel selected from the menu.

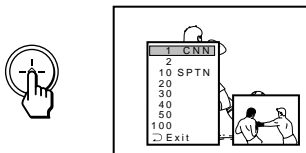

- 2 Move the joystick up or down to select the channel that you wish to view from the menu.

The picture of the selected channel will be displayed in the window picture.

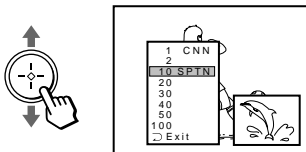

- 3 Press \oplus to select the channel.

The selected channel will be displayed for normal viewing.



To cancel the favorite channel menu before selecting a channel, move the joystick up or down to select “Exit” at the bottom of the menu and press \oplus .

Adjusting Your SET UP (menus) (continued)

Using the Set Up Menu

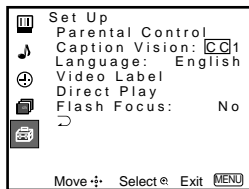

For detailed information on using the remote control to modify menu settings, refer to “Learning Menu Selection” on page 29.

To select the Set Up menu:

Display → Highlight → Select

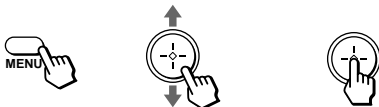

<p>Parental Control <i>Blocks programs unsuitable for children.</i></p>	<p>Allows you to block TV programs that you feel are unsuitable for your children. (see “Using the Parental Control Feature” on page 40 for details)</p>
<p>Caption Vision <i>Television closed caption display</i></p>	<p>Some programs are broadcast with Caption Vision. To display Caption Vision, select CC1, CC2, CC3, CC4, TEXT1, TEXT2, TEXT3 or TEXT4 from the menu. Then press the CC button until “Caption Vision” is displayed. CC1, CC2, CC3 or CC4 displays a printed version of the dialogue or sound effects of a program. (The mode should be set to CC1 for most programs.) TEXT1, TEXT2, TEXT3, or TEXT4 displays network/station information presented using either half or the whole screen.</p> <p>Notes:</p> <ul style="list-style-type: none"> Poor reception of TV programs can cause errors in Caption Vision and XDS. Captions may appear with a white box or other errors instead of the intended text. XDS, Caption Vision, and the status display cannot be used at the same time.
<p>Language <i>Preferred language</i></p>	<p>Select from available languages (English, Español or Français) to display all menus in your language of choice.</p>

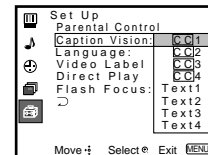

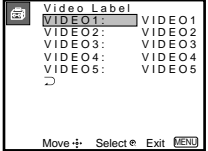
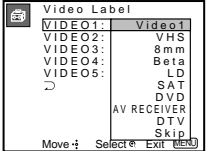
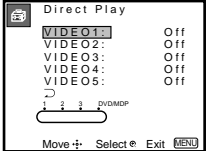
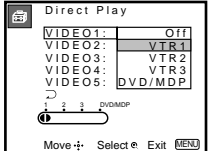
<p>Video Label <i>Easy recognition of connected equipment (e.g. SAT, VHS, etc.)</i></p>	<p>This feature allows you to label each input mode so that you can easily identify the connected equipment (e.g. you can label VIDEO 1 IN as VHS).</p> <p>With the Video Label window open:</p> <ol style="list-style-type: none"> 1 Move the joystick up or down to select the input mode you want to label and press +. 2 Move the joystick up or down to select the label and press +. <p>Video Label Options: VIDEO 1: VIDEO 1, VHS, 8mm, Beta, LD, SAT, DVD, AV RECEIVER, DTV, Skip VIDEO 2/3: VIDEO 2/VIDEO 3, VHS, 8mm, Beta, LD, SAT, DVD, DTV, Skip VIDEO 4/5: VIDEO 4/VIDEO 5, SAT, DVD, DTV, Skip <i>If you select "Skip," your projection TV will skip this connection when you scan through video sources using the TV/VIDEO button.</i></p>	 
<p>Direct Play <i>Easy operation of a connected VCR</i></p>	<p>This feature allows you to switch the input mode from the TV to a Sony VCR (MDP or DVD) and start playing by only pressing the ▶ (playback) button on the remote control. You have to set the VTR1/2/3/DVD/MDP switch on the remote control (e.g., you connect your VCR to the VIDEO 3 IN jacks and set the VTR1/2/3/DVD/MDP switch to VTR 3).</p> <p>With the Direct Play window open:</p> <ol style="list-style-type: none"> 1 Move the joystick up or down to select the input to which your video equipment is connected, and press +. 2 Move the joystick up or down to select the position of the VTR 1/2/3/DVD/MDP switch, and press +. 	 
<p>Flash Focus <i>Automatic convergence adjustment</i></p>	<p>Select Yes and press + to start Flash Focus adjustment. When the adjustment is completed, the cross pattern on the screen becomes white. (for details, see page 20)</p> <p>Select No to cancel Flash Focus.</p>	

Adjusting Your SET UP (menus) (continued)

Using the Parental Control Feature

The TV programs and movies shown on TV are given a rating signal based on the following rating systems.

In U.S.A.: U.S. Television Parental Guidelines to rate television programs (U.S. TV ratings), and Motion Picture Association of America (MPAA) Guidelines to rate movies including those shown on TV (movie ratings)

In Canada: Canadian English Language ratings to rate television programs in English, and Canadian French Language ratings to rate those in French.

To block programs you feel are unsuitable for your children, you need to set the TV for the desired rating systems. Sony's predetermined ratings are also available.

See pages 47 to 50 for a description of the ratings.

The Parental Control feature of the TV functions by receiving the rating signal from your local broadcasting station or cable service provider.

Activating the Parental Control Feature

First, set a password, then select your desired rating from Sony's predetermined ratings.

- 1 Select "Parental Control" from the Set Up menu. (see page 38)

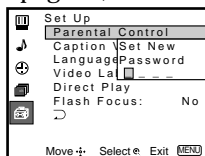

- 2 Enter a four digit password* using the 0-9 buttons.

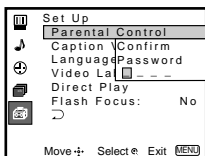

* Do not enter "4357" corresponding to "HELP" on a phone number pad. (see page 47)

- 3 To confirm the password, re-enter the same password with the 0-9 buttons. Your password is stored and the Parental Control menu automatically appears. If you want to change the password, see page 46.

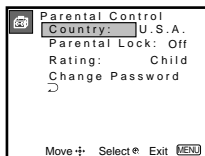

- 4 Make sure that "Country" is highlighted, and press \oplus .

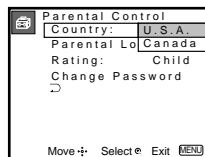

- 5 Move the joystick up or down to select your country (U.S.A. or Canada), and press \oplus .

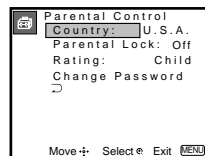

- 6 Move the joystick up or down to select "Parental Lock," and press \oplus .

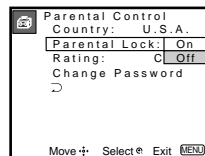

(continued)

- 7 Move the joystick up or down to select “On,” and press **+**.

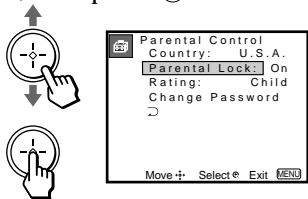

- 8 Move the joystick up or down to select “Rating,” and press **+**.

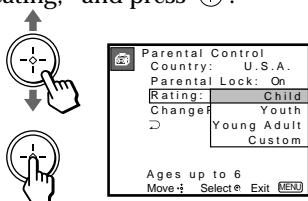

- 9 Move the joystick up or down to select a desired rating (“Child,” “Youth” and “Young Adult”), and press **+**.

If you want to select the ratings from “Custom,” go to step 4 of “Selecting a Custom Rating in U.S.A.” on page 42 or “Selecting a Custom Rating in Canada” on page 45, according to your “Country” setting.

- 10 Press MENU to exit the menu.

To deactivate the Parental Control feature

If you set “Parental Lock” in the Parental Control menu to “Off,” the Parental Control feature will not work and you can view all TV programs and movies shown on TV.

- 1 Select “Parental Control” from the Set Up menu. (see page 38)

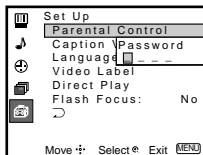

- 2 Enter your four digit password using the 0-9 buttons.

The Parental Control menu appears.

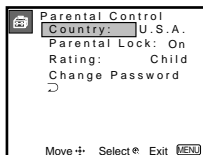

- 3 Move the joystick up or down to select “Parental Lock,” and press **+**.

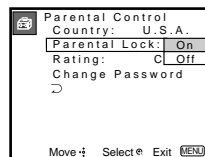

- 4 Move the joystick up or down to select “Off,” and press **+**.

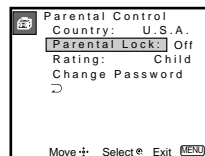

- 5 Press MENU to exit the menu.

Adjusting Your SET UP (menus) (continued)

To unlock the Parental Control feature temporarily

When you select a Parental Control program, no sound or picture except for a channel number will appear. The  indicator is displayed. To view the program, follow the steps below.

- 1 Press ENTER to display the “Password” screen.
- 2 Enter your password using the 0–9 buttons. Parental Control will be canceled (“Parental Lock” set to “Off”) until you turn your projection TV off.

Selecting a Custom Rating in U.S.A.

If you want to select the ratings to be blocked from “Custom” once you have activated the Parental Control feature (page 41), follow the procedure below.

For a detailed description of each rating, see “What the Ratings Mean” on pages 47 to 49.

- 1 Select “Parental Control” from the Set Up menu. (see page 38)

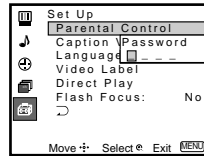

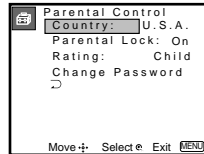

- 2 Enter your four digit password using the 0–9 buttons.

The Parental Control menu appears. Make sure that “Country” is set to “U.S.A.”

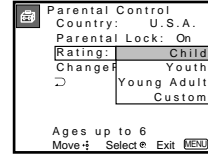

- 3 Move the joystick up or down to select “Rating,” and press  .



- 4 Move the joystick up or down to select “Custom,” and press  .

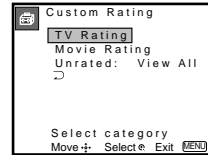

First, select a TV rating.

- 5 Move the joystick up or down to select “TV Rating,” and press \oplus .

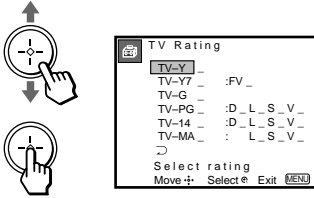

- 6 Move the joystick up or down to select the TV rating to be blocked, and press \oplus .

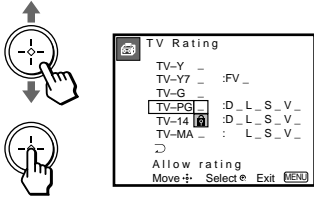

- 7 Move the joystick up or down to select “ \oplus ,” and press \oplus . The \oplus indicator automatically appears beside the selected rating and all “higher” ratings, indicating that the programs that match the ratings will be blocked.

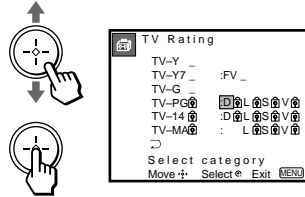

Some ratings have additional content ratings called “extenders.” The extenders are defined as follows: D (sexually suggestive Dialog), FV (Fantasy Violence), L (coarse Language), S (Sexual situations) and V (Violence). By setting the extenders, you can define additional viewing limits. For more details of extenders, see page 49.

All of the extenders included in the selected ratings will be blocked. If you wish to allow any of them to be viewed, go to step 8.

- 8 Move the joystick left or right to select the extender to be viewed, and press \oplus .

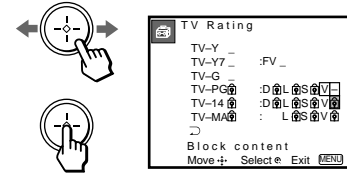

- 9 Move the joystick up or down to select “-,” and press \oplus .

“-” appears beside the selected extender, indicating that the programs that match the extender can be viewed.

If you select “ \oplus ,” \oplus is displayed to show that the programs that match the extender will be blocked again.

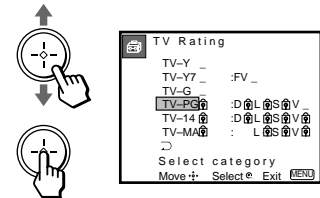

(continued)

Adjusting Your SET UP (menus) (continued)

10 Repeat steps 8 and 9 for other extenders.

All programs that match the ratings you select and higher, except for the extenders that were canceled, will be blocked.

11 After setting of the TV rating is complete, move the joystick up or down to select “▷,” and press .

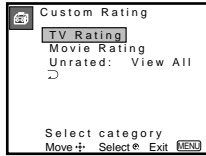

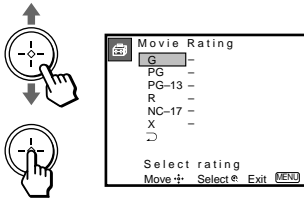

Second, select a movie rating.

12 Move the joystick up or down to select “Movie Rating,” and press .

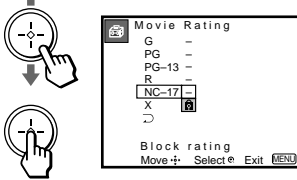

13 Move the joystick up or down to select the movie rating to be blocked, and press .



14 Move the joystick up or down to select “.

The  indicator automatically appears beside the selected rating and all “higher” ratings, indicating that the programs that match the ratings will be blocked.

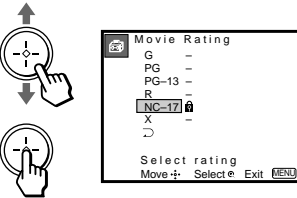

15 Press MENU to exit the menu.

To block TV programs and/or movies for which a rating signal is not given (NR and N/A)

For a description of the NR and N/A ratings, see page 48.

- 1 Perform steps 1–4 of “Selecting a Custom Rating in U.S.A.” on page 42.
- 2 Move the joystick up or down to select “Unrated,” and press .

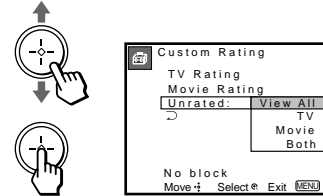

- 3 Move the joystick up or down to select the type of programs to be blocked, and press \oplus .

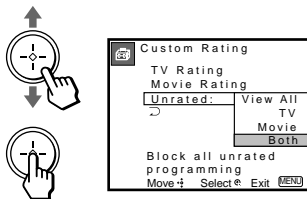

To block ...	Select ...
No program (to view any unrated TV program and movie)	View All
Unrated TV programs	TV
Unrated movies	Movie
Unrated TV programs and movies	Both

- 4 Press MENU to exit the menu.

Selecting a Custom Rating in Canada

If you want to select the ratings to be blocked from “Custom” once you have activated the Parental Control feature (page 41), follow the procedure below.

For a detailed description of each rating, see “What the Ratings Mean” on pages 49 and 50.

- 1 Select “Parental Control” from the Set Up menu. (see page 38)

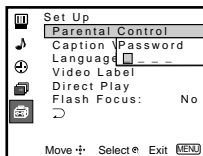

- 2 Enter your four digit password using the 0–9 buttons.

The Parental Control menu appears. Make sure that “Country” is set to “Canada.”

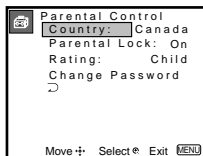

- 3 Move the joystick up or down to select “Rating,” and press \oplus .

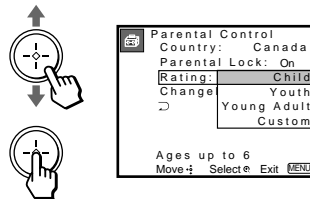

- 4 Move the joystick up or down to select “Custom,” and press \oplus .

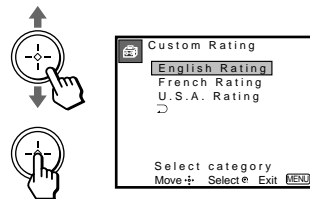

(continued)

Adjusting Your SET UP (menus) (continued)

- 5 Move the joystick up or down to select the rating you want to block, and press \oplus .

The selected rating appears.

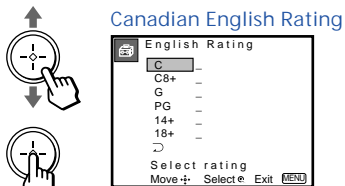

Canadian French Rating U.S. TV Rating

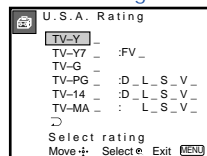
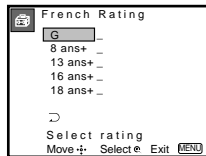

- 6 Move the joystick up or down to select the TV rating to be blocked, and press \oplus .

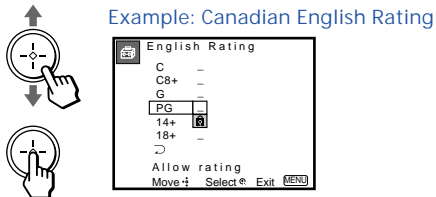

- 7 Move the joystick up or down to select “ \oplus ,” and press \oplus .

The \oplus indicator automatically appears beside the selected rating and all “higher” ratings, indicating that the programs that match the ratings will be blocked.

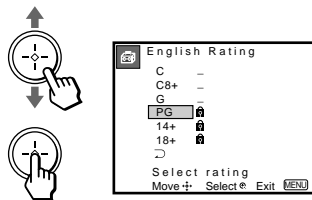

Some U.S. TV ratings have additional content ratings called “extenders,” such as D, FV, L, S and V. By setting a Custom Rating in U.S.A.” on pages 43 and 44. For more details of extenders, see page 49.

All of the extenders included in the selected ratings will be blocked. If you wish to allow any of them to be viewed, go to step 8.

- 8 Press MENU to exit the menu.

Changing the Password

- 1 Select “Parental Control” from the Set Up menu. (see page 38)

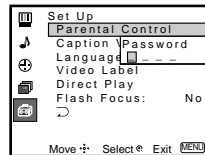

- 2 Enter your four digit password using the 0-9 buttons. The Parental Control menu appears.

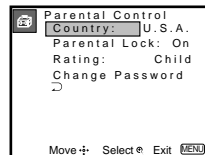

- 3 Move the joystick up or down to select “Change Password,” and press \oplus .

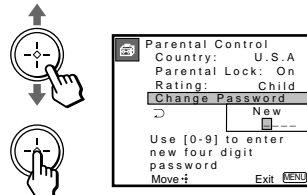

- 4 Enter a new four digit password using the 0–9 buttons.

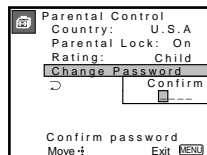

- 5 Enter the password set in step 4 again to confirm.

If you entered it incorrectly, “Password incorrect” appears.

Re-enter the correct password.

- 6 Press MENU to exit the menu.

If you have forgotten your password

In step 2 of “Changing the Password” on page 46, enter the master password “4357” (corresponding to “HELP” on a phone number pad). You can then store a new password.

Notes:

- If you entered “4357” as your password the first time, you cannot store a new password. (see step 2 of “Activating the Parental Control Feature” on page 40)
- When you select a Parental Control program and the  indicator is displayed on the screen, you cannot view that program even if you enter “4357.” (see “To unlock the Parental Control feature temporarily” on page 42)

What the Ratings Mean

Ratings in U.S.A.

Sony’s predetermined ratings

These are original ratings that Sony predetermined according to the viewer’s age. Each rating allows you to view the certain programs, as follows.

See pages 48 and 49 for a description of each rating.

Child: Suitable for children under the age of 6.

Viewable U.S. movie ratings: G, NR, and N/A

Viewable U.S. TV ratings: TV-Y, TV-G, and TV-NR

Youth: Suitable for children aged 7 and older. Viewable U.S. movie ratings: G, PG, NR, and N/A

Viewable U.S. TV ratings: TV-Y, TV-Y7, TV-G, TV-PG, and TV-NR

Young Adult: Suitable for children aged 13 and older.

Viewable U.S. movie ratings: G, PG, PG-13, NR, and N/A

Viewable U.S. TV ratings: TV-Y, TV-Y7, TV-G, TV-PG, TV-14, and TV-NR

(continued)

Adjusting Your SET UP (menus) (continued)

U.S. movie ratings

U.S. movie ratings are for movies (including those shown on TV) rated according to the Motion Picture Association of America (MPAA) Guidelines.

G (General Audiences—All Ages Admitted): In G-rated films no strong words are used, the violence is at a minimum, nudity and sex scenes are not present, nor is there any drug use.

PG (Parental Guidance Suggested. Some Material May Not Be Suitable For Children): This is a film which may need to be monitored first by parents.

PG-13 (Parents Strongly Cautioned. Some Material May Be Inappropriate For Children Under 13): Parents are alerted to be very careful about the attendance of their under-teenage children when viewing.

R (Restricted, Under 17 Require Accompanying Parent Or Adult Guardian): This film includes hard language, tough violence, nudity, drug abuse or other elements of concern.

NC-17 or X (No One 17 Or Under Admitted.): This is a film that most parents would consider not suitable for children aged 17 and under. There may be violence, sex, aberrational behavior, drug abuse or other elements of concern.

NR (Not Rated): This is a film that a producer has not rated, intending to have his film widely released.

N/A (Not Applicable): This is a film that a producer considers outside the scope of the MPAA ratings.

Note:

- NR and N/A ratings are shown together as “Unrated” in the menu.

U.S. TV ratings

U.S. TV ratings are for TV programs rated according to the U.S. Television Parental Guidelines.

TV-Y (All Children): This program is designed for young children aged 2–6 and is appropriate for all children.

TV-Y7 (Directed to Older Children): This program is designed for children aged 7 and above. Themes and elements in this program may include mild fantasy violence or slapstick violence, or may frighten children under the age of 7.

TV-G (General Audience): Most parents would find this program suitable for all ages. It contains little or no violence, no strong language and little or no sexual dialog or situations.

TV-PG (Parental Guidance Suggested): This program contains some material that parents may find unsuitable for younger children.

TV-14 (Parents Strongly Cautioned): This program contains some material that many parents would find unsuitable for children under the age of 14.

TV-MA (Mature Audience Only): This program is specifically designed to be viewed by adults and therefore may be unsuitable for children under the age of 17.

TV-NR (Not Rated/Unrated): This is a program broadcast without any rating, such as news, news flashes or sports.

Note:

The TV-NR rating is shown as “Unrated” in the menu.

About the extenders of U.S. TV ratings

TV-Y7, TV-PG, TV-14 and TV-MA ratings have additional content ratings called “extenders” to define additional viewing limits. The extenders are defined as follows:

D (sexually suggestive Dialog): Programs containing suggestive dialog, or sexual innuendo

FV (Fantasy Violence): Programs containing cartoon violence occurring in TV-Y7 programs only

L (coarse Language): Programs containing coarse language

S (Sexual situations): Programs containing sexual content

V (Violence): Programs containing violence
There may be some profanity, violence or brief nudity in these programs.

Ratings in Canada

Sony’s predetermined ratings

These are original ratings that Sony predetermined according to the viewer’s age. Each rating allows you to view the certain programs, as follows.

See the right column to page 50 for a description of each rating.

Child: Suitable for children under the age of 7.

Viewable Canadian English Language ratings: C and G

Viewable Canadian French Language ratings: G

Viewable U.S. TV ratings: TV-Y, TV-G, and TV-NR

Youth: Suitable for children aged 8 and older.

Viewable Canadian English Language ratings: C, G, C8+ and PG

Viewable Canadian French Language ratings: G and 8 ans+

Viewable U.S. TV ratings: TV-Y, TV-Y7, TV-G, TV-PG, and TV-NR

Young Adult: Suitable for children aged 14 and older.

Viewable Canadian English Language ratings: C, G, C8+, PG and 14+

Viewable Canadian French Language ratings: G, 8 ans+, 13 ans+

Viewable U.S. TV ratings: TV-Y, TV-Y7, TV-G, TV-PG, TV-14, and TV-NR

Canadian English Language ratings

The Canadian English Language Ratings are for TV programs in English broadcast in Canada.

C (Programming intended for children under age 8): There will be no realistic scenes of violence or no offensive language, nudity or sexual content. Careful attention is paid to themes, which could threaten children’s sense of security and well-being.

C8+ (Programming generally considered acceptable for children 8 years and over to watch on their own): Violence will not be portrayed as the preferred, acceptable, or only way to resolve conflict; or encourage children to imitate dangerous acts which they may see on television. There will be no profanity, nudity or sexual content.

(continued)

Adjusting Your SET UP (menus) (continued)

G (General Audience): Will contain very little violence, either physical or verbal or emotional. There may be some inoffensive slang, no profanity and no nudity.

PG (Parental Guidance): Programming intended for a general audience but which may not be suitable for younger children. Parents may consider some content inappropriate for unsupervised viewing by children aged 8 - 13.

14+ (Programming contains themes or content which may not be suitable for viewers under the age of 14): Parents are strongly cautioned to exercise discretion in permitting viewing by pre-teens and early teens.

18+ (Adult): May contain violence integral to the development of the plot, character or theme, intended for adult audiences. May contain graphic language and explicit portrayals of nudity and/or sex.

E (Exempt): Exempt programming includes: news, sports documentaries and other information programming: talk shows, music videos, and variety programming.

Note:

The E (Exempt) rating is not shown in the menu.

Canadian French Language ratings

The Canadian French Language Ratings are for TV programs in French broadcast in Canada.

G (General): Programming intended for audience of all ages. Contains no violence, or the violence it contains is minimal or is depicted appropriately with humor or caricature or in an unrealistic manner.

8 ans+ (8+ General - Not recommended for young children): Programming intended for a broad audience but contains light or occasional violence that could disturb young children. Viewing with an adult is recommended for young children (under the age of 8).

13 ans+ (Programming may not suitable for children under the age of 13): Viewing with an adult is strongly recommended for children under 13.

16 ans+ (Programming is not suitable for children under the age of 16): Contains frequent scenes of violence or intense violence.

18 ans+ (Programming restricted to adults): Contains constant violence or scenes of extreme violence.

E (Exempt): Exempt programming.

Note:

The E (Exempt) rating is not shown in the menu.

Operating Video Equipment

Setting the Manufacturer's Code

You can use the supplied remote control to operate Sony or non-Sony video equipment that has an infrared sensor.

- 1 Set the VTR 1/2/3/DVD/MDP switch to the input through which you would like to access your video equipment.

The following Sony equipment is preset to each input as shown below:

VTR1 (303)	Beta, ED Beta VCRs
VTR2 (302)	8 mm VCR
VTR3 (301)	VHS VCR
DVD/MDP (751)	DVD Player

- 2 Press CODE SET, DVD/VTR (FUNCTION), and the 0-9 buttons to enter the manufacturer's code number (see the following chart), then press ENTER.

For example, to operate a Sony 8mm VCR:



If the remote control doesn't work

- See the tips on page 53.

VCR manufacturer code numbers

Manufacturer	Code
Sony	301, 302, 303
Aiwa	338
Admiral (M. Ward)	327
Audio Dynamic	314, 337
Bell & Howell (M. Ward)	330
Broksonic	319, 317
Canon	309, 308
Citizen	332
Craig	302, 332
Curtis Mathis	304, 338, 309
Daewoo	341, 312, 309
DBX	314, 336, 337
Dimensia	304
Emerson	319, 320, 316, 317, 318, 341
Fisher	330, 335
Funai	338
General Electric	329, 304, 309
Go Video	340, 339, 322
Goldstar	332
Hitachi	306, 304, 305, 338
Instant Replay	309, 308
JC Penney	309, 305, 304, 330, 314, 336, 337
JVC	314, 336, 337
Kenwood	314, 336, 332, 337
LXI (Sears)	332, 305, 330, 335, 338
Magnavox	308, 309, 310
Marantz	314, 336, 337
Marta	332
Memorex	309, 335
Minolta	305, 304
Mitsubishi/MGA	323, 324, 325, 326
Multitech	325, 338, 321
NEC	314, 336, 337
Olympic	309, 308
Optimus	327

Panasonic	308, 309, 306, 307
Pentax	305, 304
Philco	308, 309
Philips	308, 309, 310
Pioneer	308
Quasar	308, 309, 306
RCA/PROSCAN	304, 305, 308, 309, 311, 329, 312, 313, 310
Realistic	309, 330, 328, 335, 324, 338
Sansui	314
Samsung	322, 313, 321
Sanyo	330, 335
Scott	312, 313, 321, 335, 323, 324, 325, 326
Sharp	327, 328
Signature 2000 (M. Ward)	338, 327
Sylvania	308, 309, 338, 310
Symphonic	338
SV2000	338
Tashiro	332
Tatung	314, 336, 337
Teac	314, 336, 338, 337
Technics	309, 308
Teknica	338
Toshiba	312, 311
Wards	327, 328, 335, 331, 332
Yamaha	330, 314, 336, 337
Zenith	331

MDP manufacturer code numbers

Manufacturer	Code
Sony	701
Panasonic	704, 710
Mitsubishi	702

Operating Video Equipment (continued)

DVD Player manufacturer code numbers

Manufacturer	Code
Sony	751
Panasonic	753
Pioneer	752
RCA	755
Toshiba	754









Tips

- In some rare cases, you may not be able to operate your non-Sony video equipment with the supplied remote control. In this case, please use the equipment's own remote control.
- When you remove the batteries, the code number may revert to the factory setting.



To operate video equipment



- 1 Set the VTR1/2/3/DVD/MDP switch to the input through which you would like to access your video equipment.
- 2 Press DVD/VTR (FUNCTION).
- 3 Use the VCR/DVD/MDP operation buttons indicated in the following tables.

Operating a VCR using the remote control





To turn On/Off	Press DVD/VTR (POWER). [Green Button]
To select a channel	Press the 0 – 9 buttons.
To change channels	Press CH +/-.
To record	Press  while pressing  (REC) (upper).
To play	Press  .
To stop	Press  .
To fast forward	Press  .
To rewind the tape	Press  .
To pause	Press  . Press again to resume normal playback.
To search the picture forward or backward	Press  or  during playback. Release to resume normal playback.
To change input mode	Press TV/VTR.

Operating an MDP using the remote control

To turn On/Off	Press DVD/VTR (POWER). [Green Button]
To play	Press  .
To stop	Press  .
To pause	Press  . Press again to resume normal playback.

To search the picture forward or backward	Press  or  during playback. Release to resume normal playback.
To search a chapter forward or backward	Press CH +/-.

Operating a DVD Player using the remote control

To turn On/Off	Press DVD/VTR (POWER). [Green Button]
To play	Press  .
To stop	Press  .
To pause	Press  . Press again to resume normal playback.
To step through different tracks of an audio disc	Press  to step forward or  to step backward.
To step through different chapters of a video disc	Press CH + to step forward or CH – to step backward.
To display the Title menu	Press TITLE.
To select DVD multilingual sound	Press AUDIO repeatedly. [Pink Labeled Button]
To display the DVD menu	Press DVD MENU.
To select tracks directly	Press 0-9 buttons.
To display the menu (Set up)	Press MENU.

Operating a Cable Box or Satellite Receiver (SAT)

Setting the Manufacturer's Code

You can program the supplied remote control to operate a cable box or satellite receiver.

Press CODE SET, SAT/CABLE (FUNCTION), and the 0-9 buttons to enter the manufacturer's code number (see the following chart), then press ENTER.

For example, to operate a Sony satellite receiver:



Manufacturer code numbers (cable box)

Manufacturer	Code
Hamlin/Regal	222, 223, 224, 225, 226
Jerrold/G. I.	201, 202, 203, 204, 205, 222, 206, 207, 208, 218
Oak	227, 228, 229
Panasonic	219, 220, 221
Pioneer	214, 215
Scientific Atlanta	209, 210, 211
Tocom	216, 217
Zenith	212, 213

Manufacturer code numbers (satellite receiver)

Manufacturer	Code number
Sony	801 (preset code for remote control)
General Electric	802, 808
Hitachi	805
Hughes	804
Panasonic	803
RCA/PROSCAN	802
Toshiba	806, 807

To operate the cable box or satellite receiver (SAT)

- 1 Press SAT/CABLE (POWER) [Green Button] to turn on/off the cable box or satellite receiver.
- 2 Press SAT/CABLE (FUNCTION).
- 3 For other operations, refer to the operating instructions that come with the equipment.
The GUIDE and INDEX (blue-labeled) buttons can be used only with a satellite receiver.

If the remote control doesn't work

- Try repeating the set up procedures using the other codes listed for your equipment.

To operate the projection TV

Press TV (FUNCTION). Then use the projection TV control buttons to control the projection TV.

Tips

- If more than one code number is listed, try entering them one by one until you come to the correct code for your equipment.
- If you enter a new code number, the code number you previously entered at that setting is erased.
- In some rare cases, you may not be able to operate your equipment with the supplied remote control. In this case, use the equipment's own remote control unit.
- Whenever you remove the batteries — to replace them, for example — if too much time is taken, the code numbers may revert to the factory setting and must be reset.

If, after reading the following instructions, you have additional questions related to the use of your Sony projection TV, please call one of the following numbers (English only).

Customers in the continental United States contact the Direct Response Center at: 1-800-222-SONY (7669)

Customers in Canada contact the Customer Relations Center at: (416) 499-SONY (7669)

The picture turns off and the TIMER/STAND BY indicator on the front panel flashes (self-diagnosis function)	<ul style="list-style-type: none"> • The projection TV is equipped with a self-diagnosis function. If there is a problem with your projection TV, the TIMER/STAND BY indicator on the front panel will flash repeatedly. Counting the number of flashes helps you inform qualified Sony personnel of the projection TV's condition. • Press POWER on the projection TV to turn it off, then inform qualified Sony personnel or the above Direct Response Center of the number of flashes.
No picture (screen not lit), no sound	<ul style="list-style-type: none"> • Make sure the power cord is plugged in. • Operate with the buttons on both the projection TV and the remote control. • Check to see if the TV/VIDEO setting is correct: when watching TV, set to TV, and when watching video tapes, set to VIDEO 1, 2, 3, 4 or 5. • Try another channel. <i>It could be station trouble.</i> • Perform AUTO SET UP again using the SET UP button to return to the factory preset condition. (see "To perform AUTO SET UP again" on page 20) • The Parental Control feature is activated. (see "To deactivate the Parental Control feature" on page 41)
Remote control does not operate	<ul style="list-style-type: none"> • Batteries could be weak. Replace the batteries. • Press TV (FUNCTION) when operating your projection TV. • Make sure the projection TV's power cord is connected securely to the wall outlet. • Locate the projection TV at least 3-4 feet away from fluorescent lights. • Check the S-Link connection. (see "Using the S-Link Function" on page 16) • Check the polarity of the batteries.
Dark, poor or no picture (screen lit), good sound	<ul style="list-style-type: none"> • Adjust "Picture" in the Video menu. (see "Picture Adjustment" on page 30) • Adjust "Brightness" in the Video menu. (see "Picture Adjustment" on page 30) • Check antenna/cable connections. • Perform AUTO SET UP again using the SET UP button to return to the factory preset condition. (see "To perform AUTO SET UP again" on page 20) • Adjust the convergence again using the FLASH FOCUS button. (see "Adjusting the Convergence Automatically (FLASH FOCUS)" on page 20)
Good picture, no sound	<ul style="list-style-type: none"> • Press MUTING so that "Muting" disappears from the screen. (see "MUTING" on page 21) • Check the "MTS/SAP" setting in the Audio menu. (see "MTS/SAP" on page 31) • Make sure "Speaker" is set to "On" in the Audio menu. (see "Speaker" on page 32) • Perform AUTO SET UP again using the SET UP button to return to the factory preset condition. (see "To perform AUTO SET UP again" on page 20)

Cannot receive upper channels (UHF) when using an antenna	<ul style="list-style-type: none"> • Make sure "Cable" is "Off" in the Channel Set Up menu. (see "Cable" on page 35) • Use "Auto Program" to add receivable channels that are not presently in the TV's memory. (see "Auto Program" on page 35)
No color	<ul style="list-style-type: none"> • Adjust "Color" in the Video menu. (see "Picture Adjustment" on page 30) • Black and white programs cannot be seen in color. • Perform AUTO SET UP again using the SET UP button to return to the factory preset condition. (see "To perform AUTO SET UP again" on page 20)
Only snow and noise appear on the screen	<ul style="list-style-type: none"> • Check the "Cable" setting in the Channel Set Up menu. (see "Cable" on page 35) • Check the antenna/cable connections. • Make sure the channel is broadcasting programs. • Press ANT to change the input mode. (see "ANT" on page 23)
Dotted lines or stripes	<ul style="list-style-type: none"> • Adjust the antenna. • Keep the projection TV away from noise sources such as cars, neon signs or hair-dryers.
TV is fixed to one channel	<ul style="list-style-type: none"> • Use "Auto Program" to add receivable channels that are not presently in TV's memory. (see "Auto Program" on page 35)
Double images or ghosts	<ul style="list-style-type: none"> • Use a highly directional outdoor antenna or a cable (when the problem is caused by reflections from nearby mountains or tall buildings).
Cannot operate the menu	<ul style="list-style-type: none"> • If the item you want to choose appears in gray, you cannot select it. • Press the projection TV's power button off and on again.
Cannot receive any channels when using cable TV	<ul style="list-style-type: none"> • Make sure "Cable" is "On" in the Channel Set Up menu. (see "Cable" on page 35) • Use "Auto Program" to add receivable channels that are not presently in the TV's memory. (see "Auto Program" on page 35)
Cannot gain enough volume when using a cable box	<ul style="list-style-type: none"> • Increase the volume at the cable box. Then press TV (FUNCTION) and adjust the projection TV's volume.
Projection TV malfunctions when using the S-Link function	<ul style="list-style-type: none"> • Make sure the projection TV's power cord is connected securely to the wall outlet. • Check the S-Link connection. (see "Using the S-Link Function" on page 16)
CHANNEL INDEX does not display all available channels	<ul style="list-style-type: none"> • Make sure "Cable" is "On" in the Channel Set Up menu. (see "Cable" on page 35) • Use "Auto Program" to add receivable channels that are not presently in the TV's memory. (see "Auto Program" on page 35)
Favorite Channel does not display your choices	<ul style="list-style-type: none"> • Verify that "Favorite Channel" is set to "Manual" in the Channel Set Up menu. (see "Setting Favorite Channel manually" on page 36)
Some video sources do not appear when you press TV/VIDEO	<ul style="list-style-type: none"> • Ensure that "Video Label" is not set to "Skip." (see "Video Label" on page 39)
Recording through MONITOR OUT does not function properly when recording in PIP or P&P mode	<ul style="list-style-type: none"> • MONITOR OUT will not record both images in PIP or P&P. Only the main picture will be recorded. • If you are recording the main picture and you switch to the sound of the sub picture using the AUDIO button, the main picture will be recorded with sound from the other program.
Cannot play shooting games	<ul style="list-style-type: none"> • Some shooting games which involve pointing a light beam at the TV screen with an electronic gun or rifle cannot be used with this projection TV. For details, see the instruction manual supplied with the video game software.

Specifications

Projection system

3 picture tubes, 3 lenses, horizontal in-line system

Picture tube

7-inch high-brightness monochrome tubes (6.3 raster size), with optical coupling and liquid cooling system

Projection lenses

High performance, large diameter hybrid lens F1.05

Television system

American TV standard

Channel coverage

VHF: 2-13/UHF: 14-69/CATV: 1-125

Antenna

75 ohm external terminal for VHF/UHF

Screen size (measured diagonally)

48 inches (KP-48V80)

53 inches (KP-53V80)

61 inches (KP-61V80)

Inputs/outputs

VIDEO 1/3 IN

VIDEO 2 INPUT

S VIDEO IN (4-pin mini DIN):

Y: 1 Vp-p, 75-ohms unbalanced, sync negative

C: 0.286 Vp-p (Burst signal), 75 ohms

VIDEO (phono jack): 1 Vp-p, 75-ohms unbalanced, sync negative

AUDIO (phono jacks): 500 mVrms (100% modulation), Impedance: 47 kilohms

VIDEO 4/5 IN

Y: 1 Vp-p, 75 ohms, sync negative

P_B: 0.7 Vp-p, 75 ohms

P_R: 0.7 Vp-p, 75 ohms

AUDIO (phono jacks): 500 mVrms (100% modulation), Impedance: 47 kilohms

TV OUT/MONITOR OUT

VIDEO (phono jack): 1 Vp-p, 75-ohms unbalanced, sync negative

AUDIO (phono jacks): 500 mVrms (100% modulation), Impedance: 470 ohms

AUDIO (VAR/FIX) OUT (phono jacks): 500 mVrms (100% modulation), Impedance: 470 ohms

S-LINK: minijacks

CONTROL S OUT: minijack

Speaker

Tweeter: 66 mm (2⁵/₈") × 2

Woofers: 130 mm (5¹/₈") × 2 (KP-48V80/53V80)
160 mm (6³/₈") × 2 (KP-61V80)

Speaker output

20 W × 2

Power requirement

120 V AC, 60 Hz

Power consumption

In use (Max.): 170 W

In standby: 1 W

Dimensions (W/H/D)

1,105 × 1,338 × 579 mm (43¹/₂ × 52⁵/₈ × 22³/₄ inches) (KP-48V80)

1,216 × 1,417 × 632 mm (47⁷/₈ × 55³/₄ × 24⁷/₈ inches) (KP-53V80)

1,370 × 1,560 × 670 mm (54 × 61³/₈ × 26³/₈ inches) (KP-61V80)

Mass

68.8 kg (151 lbs 11 oz) (KP-48V80)

76.0 kg (167 lbs 9 oz) (KP-53V80)

93.6 kg (206 lbs 6 oz) (KP-61V80)

Supplied accessories

Remote control RM-Y905 (1)

Batteries (2) size AA (R6)

Optional accessories





Connecting cables

RK-G34, RK-74A, RK-G69HG, VMC-10HG,

VMC-720M, VMC-810S/820S, YC-15V/30V







U/V mixer EAC-66

Design and specifications are subject to change without notice.

A	CHANNEL INDEX	28	DISPLAY button	22	Video	30
Adjusting sliders	Channel Set Up menu		DVD			
ANT button	operations 	34, 35	connection	12	M	
Antenna cable	Channel Skip/Add	35	operation	52	Manufacturer code numbers	51-53
Antenna connector	Coaxial cable	4, 5	DVD/VTR (FUNCTION)	51, 52	MDP operation	52
Audio button 	Color	30	E		MENU button	29
AUDIO/INDEX button	Connecting Projection TV to		Editing using MONITOR OUT	11	Menu selection	29
Audio menu operations 	amplifier that supports Dolby Pro		Effect	31	Mode	21, 30
Audio Out	Logic decoder	15	(Trusurround/Simulated/Off)		(Vivid/Standard/Movie/ Personal 1/Personal 2)	
(Fixed/Variable)	antenna	4	F, G		Movie rating	44
Audio/Video Cable	audio system	14	Factory settings	30, 31	MTS/SAP	23, 31
Auto Program	AV receiver	13	Favorite Channel		(Stereo/SAP/Mono/Auto SAP)	
AUTO SET UP	cable	4	Selecting	37	MUTING button	21
Auto Volume	cable box	5	Setting	36	N	
AUX Hookup	cable box and VCR	6	FLASH FOCUS	20, 39	Noise Reduction	30
	camcorder	10	FREEZE/GUIDE		O	
B	DTV receiver	9	button	22, 25, 27, 28, 53	On Line Help	18
Balance	DVD Player	12	H, I		On/Off Timer	33
Bass	satellite receiver (SAT)	7	Hook Ups	4	Operating video equipment	51
Battery installation	satellite receiver (SAT) and		Hue	30	P, Q	
Brightness	VCR	8	J, K		Parental Control	38, 40
C	Sony SAVA series speaker		Joystick	18, 29	Parental Control menu	
Cable	system	14	JUMP button	22	Change Password	46
Cable box	two VCRs	11	L		Country	40
connection	VCR	6	Language	38	Custom Rating	42, 45
operation	CONTROLS OUT jack	4	Learning menus		Parental Lock	40, 41
Caption Vision 	Convergence	20	Audio	31	Rating	41
CATV cable	Current Time	33	Channel Set Up	34	Password	40
CH +/-	D		Set Up	38		
CHANNEL +/-	Daylight Savings	33	Timer	33		
Channel Caption	Direct Play	39				

(continued)

Index (continued)

Picture	30	S	Surround	31	V, W		
Picture Adjustment	30	S-Link cable	4	SWAP button	25, 27	VCR	
(Picture/Brightness/Color/Hue/ Sharpness)		S-Link connector	16, 17			connection	6, 8, 11
Picture and Picture (P&P)	26	S-Link function	16	T, U		operation	52
Picture-in-Picture (PIP)	24	S Video cable	4	Timer menu operations 	33	Video Label	39
PICTURE MODE button	21	Safety	2	Treble	31	Video menu operations 	30
PIP/P&P operations		SAP	31	Trinitone	30	VOL +/-	21
ACTIVE 	24, 26	SAT/CABLE (FUNCTION)	53	Troubleshooting	54, 55	VOLUME +/-	19
AUDIO	25, 27	Satellite receiver (SAT) operation ...	53	TV (FUNCTION) button	21	X	
CH+/-	25, 26	SET UP button	19	TV POWER button	21	XDS	23
CHANNEL INDEX	28	Set Up menu operations 	38, 39	TV rating	43	Y, Z	
FREEZE	25, 27	Setting Up the Projection TV		TV/VIDEO button	22	Y/P _B /P _R	9, 12, 16
 (P & P)	26	Automatically	19	TV/VTR button	23		
 (PIP)	24	Sharpness	30				
POSITION	24	Skip/Add	35				
SWAP	25, 27	SLEEP button	23				
TV/VIDEO	24, 26	Sliders	18				
R		Speaker	32				
Remote control	18	(On/Off/SAVA SP/Center)					
Graphic Illustration ... (inside cover)		Specifications	56				
RESET button	24, 30, 31	Splitter	6				
		SYSTEM OFF button	23				

Sony  line <http://www.world.sony.com/>

Printed in U.S.A.

If, after reading this instruction manual, you have additional questions related to the use of your Sony projection TV, please call one of the following numbers (English only).

Customers in the continental United States contact the Direct Response Center at:
1-800-222-SONY (7669)

Customers in Canada contact the
Customer Relations Center at:
(416) 499-SONY (7669)