

SONY

3-866-072-21

Trinitron[®] Color TV

Operating Instructions

KV-13M42
KV-13M52
KV-13M53
KV-20M42
KV-20S42
KV-20S43

L

© 1999 by Sony Corporation

Contents

Introduction

Trinitron® Color TV Features	1
Batteries for the Remote Control.....	2
About this Manual	2





Connecting Your TV

Basic Connections.....	3
Connecting Additional Equipment	4

Using the Remote Control and Basic Functions

Setting Up the TV Automatically.....	10
Quick Start to the Menus.....	11

Using the Menus

Using the VIDEO  menu	13
Using the AUDIO  menu	14
Using the TIMER  menu	15
Using the SET UP  menu.....	16
Using PARENTAL CONTROL	18

Other Information

Troubleshooting	25
Specifications.....	27

Index	29
--------------------	----

Introduction

Congratulations on your purchase of the Sony Trinitron® Color TV. Before you begin using this manual, please check the model number located on the front cover of this instruction manual.

The menu and illustrations used in these instructions are for KV-20S42 to show the maximum number of features available. Differences in operation or features will be indicated in the text, for example, "KV-20S42 only."

Trinitron® Color TV Features

Depending on your TV, some of the features you will enjoy include:

- ❑ **PARENTAL CONTROL** — A tool for parents to help monitor what their children watch on TV by establishing rating limits.
- ❑ **FAVORITE CHANNEL** — Instant access to your favorite channels with the touch of a button.
- ❑ **Energy Star** — A recognized symbol of energy efficiency.
- ❑ **Headphone Jack** — For undisturbed audio enjoyment.
- ❑ **Direct MTS** — Allows direct access to changing your Multi-Channel TV Sound: STEREO, SAP (Second Audio Programming) or MONO, with the touch of a button (KV-20S42, 20S43 only).
- ❑ **Front A/V inputs** — A quick connection for video games, camcorders or stereo equipment, (except KV-13M42).
- ❑ **ON/OFF TIMER** — Program your TV for scheduled viewing, (except KV-13M42).

Batteries for the Remote Control

Insert two AA (R6) batteries (supplied) into the remote control using the following illustration as a guide.

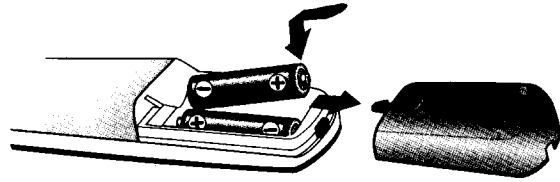

- Under normal conditions, batteries will last up to six months. If the remote control does not operate properly, the batteries might be worn out.
- Remove the batteries to avoid possible damage from battery leakage if you will not be using the remote control for an extended period of time.

About this Manual

This manual provides instructions to help you enjoy your new TV. It shows you how to connect to an antenna or cable, cable box, VCR or camcorder. Once you're connected, follow the instructions to learn how to use the remote control to access the on-screen menus.

Connecting Your TV

Read this chapter before setting up your TV for the first time. This section covers basic connections in addition to any optional equipment you may be connecting.

Basic Connections

TV with indoor or outdoor antenna, or CATV cable

Depending on the cable available in your home, choose one of the connections below:

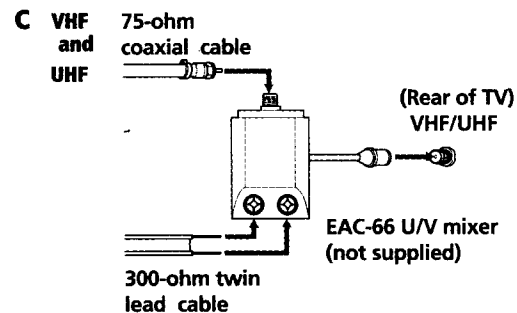
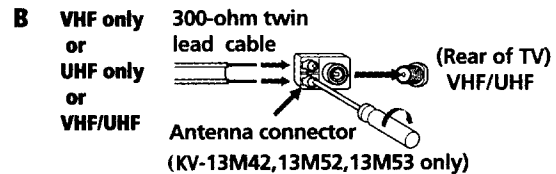
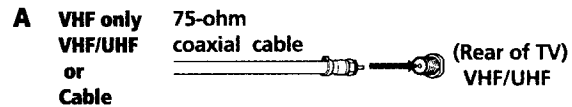

 If you are connecting to an indoor or outdoor antenna, it will be necessary to adjust the orientation of the antenna for best reception.

Connecting Additional Equipment

TV and VCR

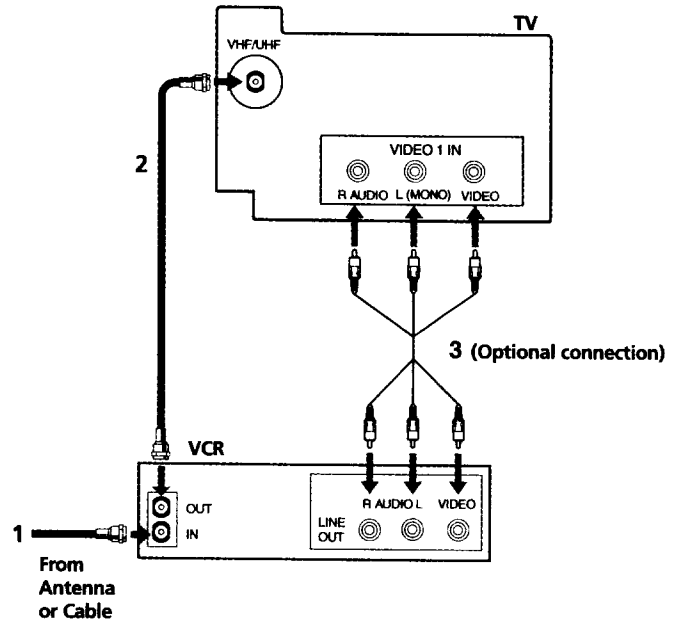

- 1** Connect the coaxial cable from your TV antenna or cable TV to the IN jack on your VCR.
- 2** Connect a coaxial cable (not supplied) from the OUT jack on your VCR to the VHF/UHF IN jack on the TV.

 To watch video programs from your VCR, tune your TV to channel 3 or 4 (as set on the rear of your VCR).

(Optional Connection)

- 3** If your VCR is equipped with video inputs, for best picture quality you should connect A/V connectors to AUDIO/VIDEO OUT on your VCR to AUDIO/VIDEO IN on your TV. You can use the  button to switch between the TV and VCR inputs.

4

TV and Cable Box

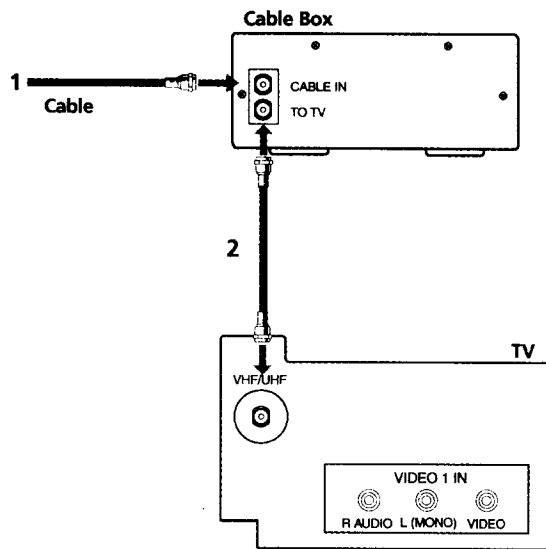

- 1** Connect the coaxial cable from the wall to the IN jack on your cable box.
- 2** Connect a coaxial cable (not supplied) from the OUT jack on your cable box to the VHF/UHF IN jack on the TV.

 To view channels from your cable box, tune your TV to channel 3 or 4 (as set on the rear panel of your cable box) and use the cable box's remote control to change channels.

 If you will be controlling all channel selection through your cable box, you should consider using the CHANNEL FIX feature on page 17.

TV, VCR, and Cable box

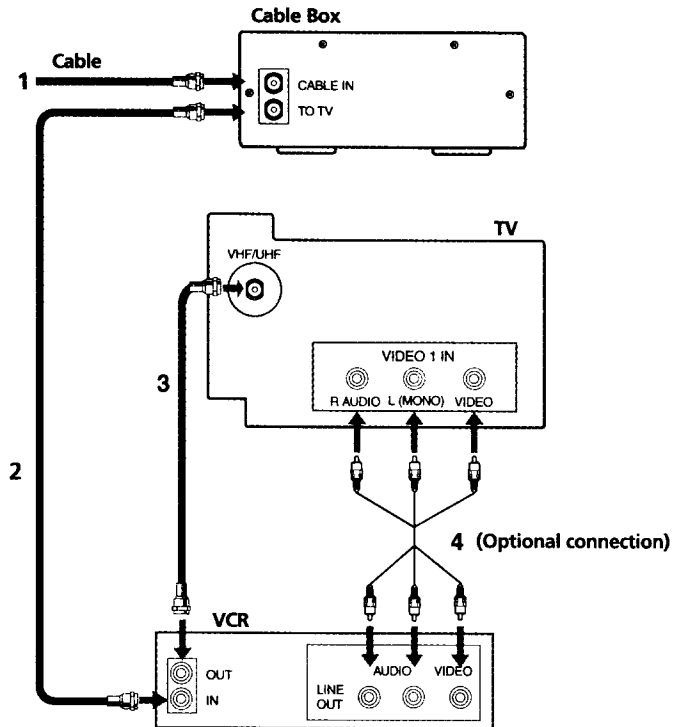

- 1** Connect the coaxial cable from the wall to the IN jack on your cable box.
- 2** Connect a coaxial cable (not supplied) from the OUT jack on your cable box to the IN jack on your VCR.
- 3** Connect a coaxial cable from OUT on your VCR to VHF/UHF IN on your TV.

 If you will be controlling all channel selection through your cable box, you should consider using the CHANNEL FIX feature on page 17.

(Optional Connection)

- 4** If your VCR is equipped with video inputs, for best picture quality you should connect A/V connectors to AUDIO/VIDEO OUT on your VCR to AUDIO/VIDEO IN on your TV. You can use the  button to switch between the TV and VCR inputs.

Connecting a Camcorder

Using A/V cables, connect AUDIO and VIDEO OUT on your camcorder to AUDIO and VIDEO IN on your TV.

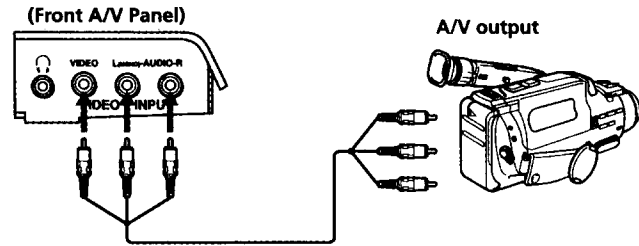



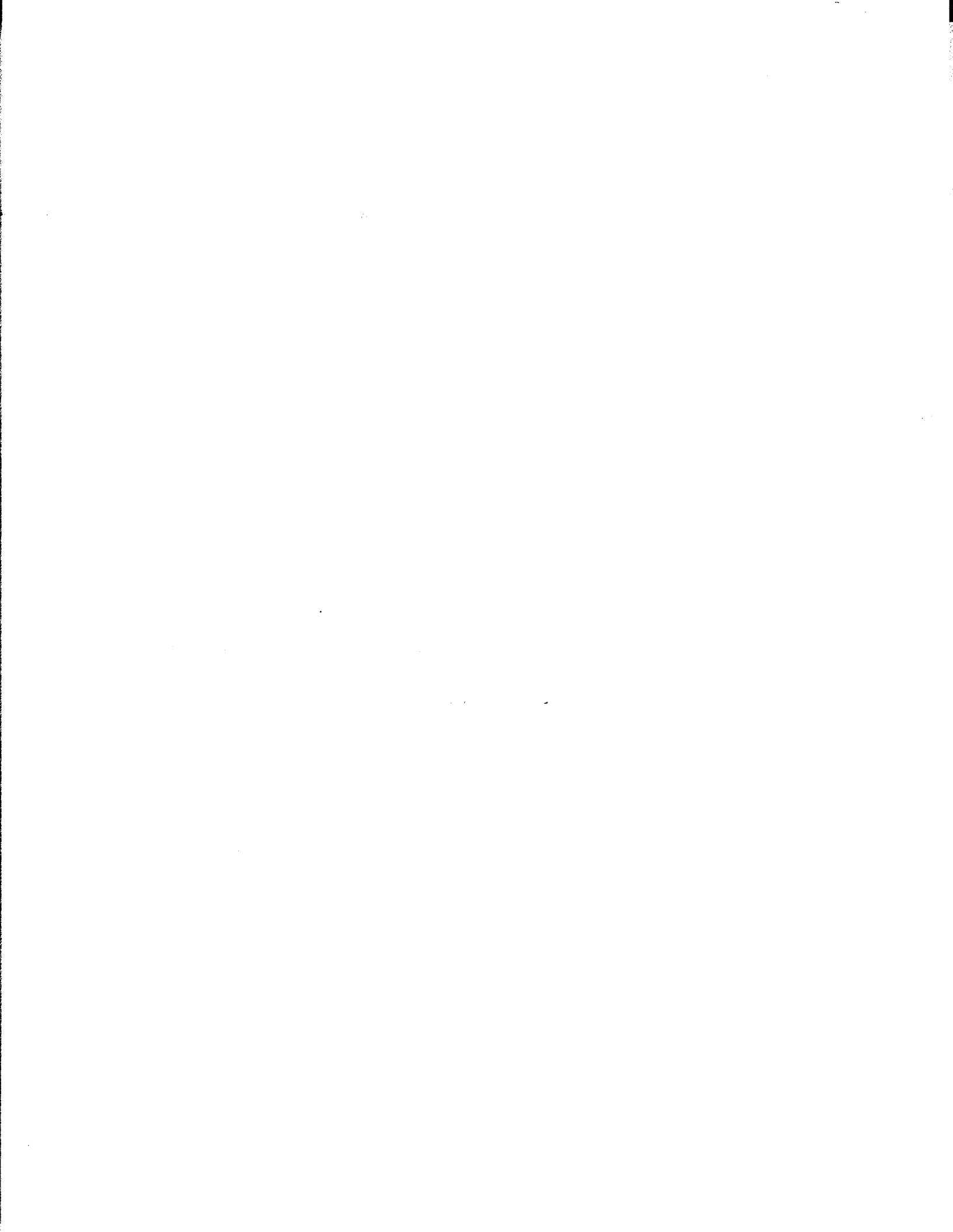











➤ For model KV-13M42, this connection can be made to the A/V input located on the rear of the TV.



Using the Remote Control and Basic Functions

This section shows you how to use more advanced buttons on the remote control and how to use the on-screen menus.

	Turns the TV off automatically in approximately 30, 60 or 90 minutes. Cancel by pressing until SLEEP OFF appears.
	Instantly turns off the sound. Press again or press  to restore sound.
	Cycles through the available video inputs.
	Press once to show current time, (if set) and channel number. Press again to activate CAPTION VISION settings, if available. To cancel, press again until DISPLAY OFF appears.
	Cycles through the Multi-Channel TV Sound (MTS) options: STEREO, SAP (Second Audio Programming) and MONO, (KV-20S42, 20S43 only).
	Press for channel selection, the channel will change after 2 seconds.
	Press after selecting a channel using the  buttons to immediately activate selection.
	Alternates back and forth between the last two channels selected with the  buttons.
	Displays the on-screen menu. Press again to exit the menu at any time.
	Activates highlighted selections in the on-screen menu.
	Moves the cursor in the on-screen menu.
	Press to restore factory settings while in the on-screen menu.

 Buttons shown are for remote control RM-Y155, your remote control may not look exactly like the one illustrated.

Setting Up the TV Automatically

After you have finished connecting your TV, you will want to run AUTO PROGRAM to set up your channels, (KV-13M42, 13M52, 13M53 see page 17 for information on AUTO PROGRAM).

For models KV-20M42, 20S42, 20S43 only

- 1 Press  to turn on the TV, the Auto Setup screen appears.

(U.S. models only)

ENGLISH	[CH+]
ESPAÑOL	[CH-]
AUTO SET UP	[VOL+]
DEMO	[VOL-]
MENU	[TV/VIDEO]

First please connect
cable/antenna
Press [SET UP] to exit

(Canadian models only)

ENGLISH:	[CH+]
ESPAÑOL:	[CH-]
FRANÇAIS:	[VOL+]
AUTO SET UP:	[VOL-]
DEMO:	[TV/VIDEO]

First please connect
cable/antenna
Press [SET UP] to exit



- 2 Make your language selection, the on-screen menus will change to reflect your choice.
- 3 Follow the on-screen instructions to continue AUTO SET UP or for a DEMO of the menus.

For U.S. models only

- 4 Press  to operate the on-screen menus without the remote control. Follow the on-screen instructions to make adjustments to your TV settings.

To perform Auto Setup again

- Press the  button on the front panel of the TV and follow steps 2-4.

 To reset your TV to factory settings, turn the TV on. Then, while pressing the  button on the remote control, press POWER on the TV. The TV will turn itself off, then back on, the original settings will be restored.

Quick Start to the Menus

The following settings are available in your on-screen menus:

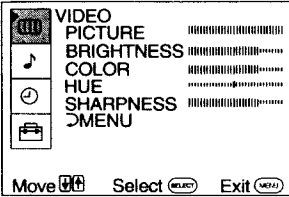
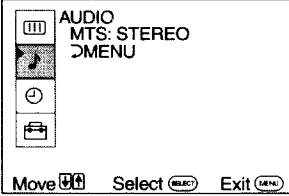
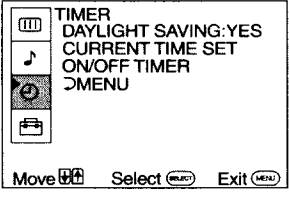
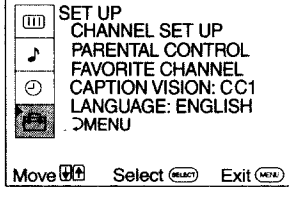
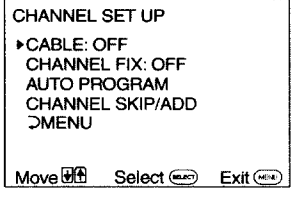
Menu	Allows you to
	Make adjustments to your picture settings.
	Choose from available audio features, such as Multi-Channel Sound, (KV-20S42, 20S43 only).
	Set the clock on your TV (CURRENT TIME SET) and program scheduled viewing (ON/OFF TIMER) (Except KV-13M42).
	<p>Program your channels, set TV rating, or select menu language.</p>
	<p>The CHANNEL SET UP menu is a sub-menu that provides further options for setting up your channels.</p>

 The menus shown are for KV-20S42. Your menus may not look like those illustrated.

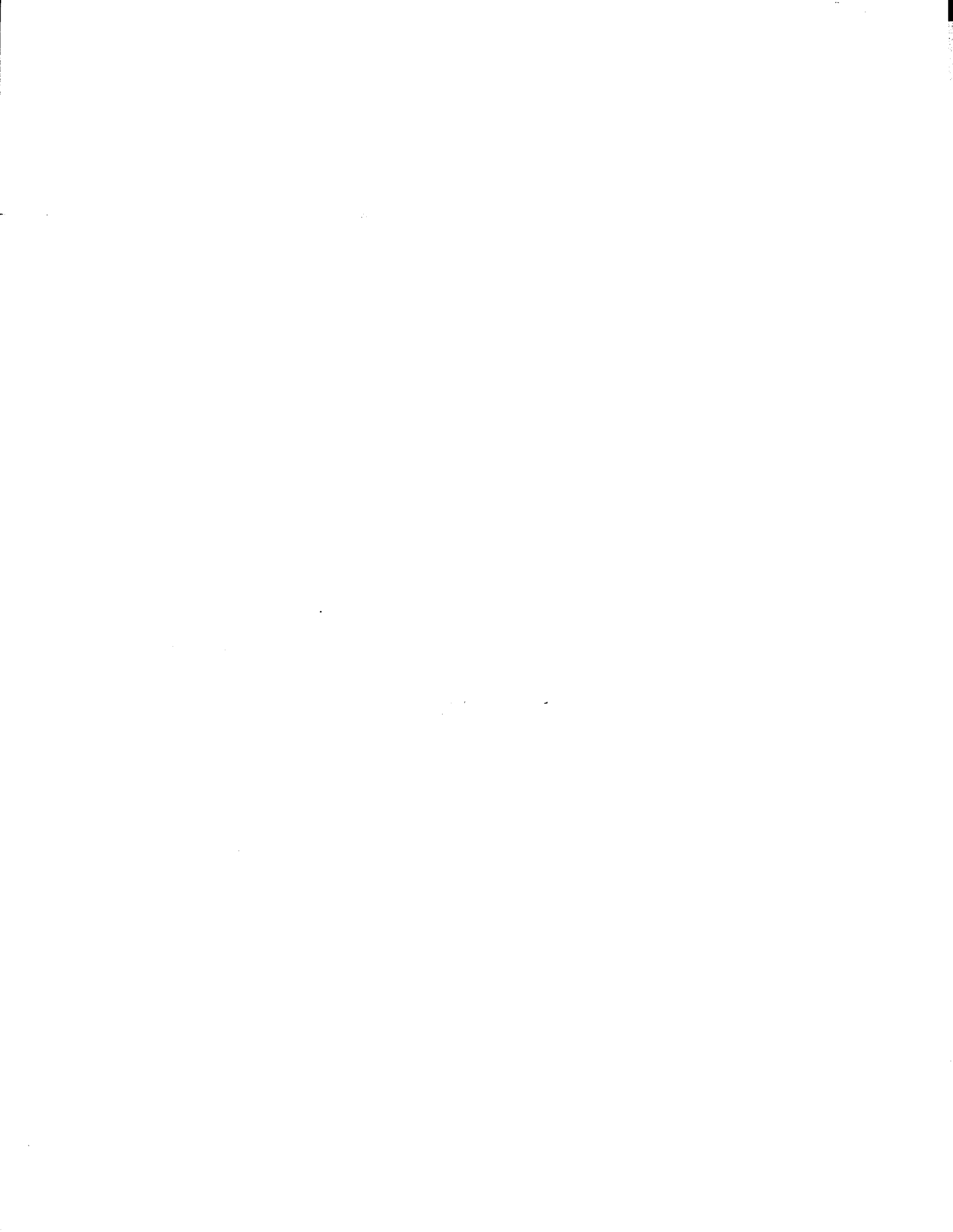

Using the Menus

This chapter shows the options available for setting up and adjusting your TV.

To access a menu

- 1 Press **MENU**.
- 2 Use the **↑** or **↓** buttons to highlight a menu.
- 3 Press **SELECT** to access the menu.

Using the VIDEO **VIDEO** menu

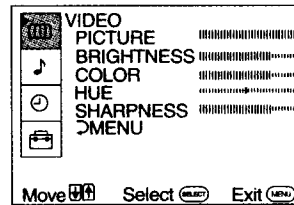

Item	Press ↓ to	Press ↑ to
PICTURE	Decrease picture contrast	Increase picture contrast
BRIGHTNESS	Darken the picture	Brighten the picture
COLOR	Decrease color intensity	Increase color saturation
HUE	Increase the red tones	Increase the green tones
SHARPNESS	Soften the picture	Sharpen the picture

Using the AUDIO 🎵 menu

KV-20S42, 20S43 only

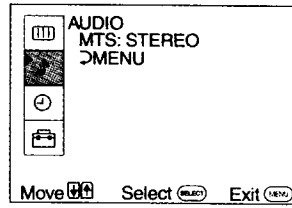

MTS
*Multi-Channel
TV Sound*

STEREO: Select when viewing a broadcast in stereo.
SAP: Listen to bilingual or other Second Audio Programs (SAP).
MONO: Select to reduce noise in areas with poor reception.

🔑 If your TV is set to SAP, all non-SAP programs will be muted. If your TV does not have sound, check your AUDIO settings.

🔑 For direct MTS settings, press the  button on your remote control.

Using the **TIMER** menu

Except KV-13M42

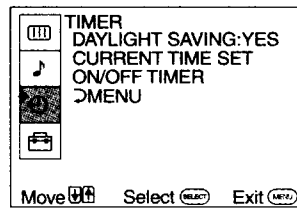





DAYLIGHT SAVING

YES: Select in spring to compensate for Daylight Savings.
NO: Select in fall at the end of Daylight Savings.

CURRENT TIME SET

With the menu open:





- 1 Press .
- 2 Press \uparrow or \downarrow to cycle through the days, then press .
- 3 Press \uparrow or \downarrow until the current hour is displayed, then press .
- 4 Press \uparrow or \downarrow until the current minute is displayed, then press .

ON/OFF TIMER

Scheduled viewing

CURRENT TIME SET must be programmed before the ON/OFF TIMER is available.

With the menu open:



- 1 Press .
- 2 Press \uparrow or \downarrow until the desired day or range of days is displayed, then press .
- 3 Indicate the time that you want the TV to turn on by pressing \uparrow or \downarrow and the , (for hour and minutes).
- 4 Press \uparrow or \downarrow to set the duration, up to 6 hours, then press .
- 5 Press \uparrow or \downarrow to set the channel and press .

 When you perform AUTO PROGRAM, all ON/OFF TIMER settings will be cleared.

 Any loss of power will cause the ON/OFF TIMER settings to be cleared.

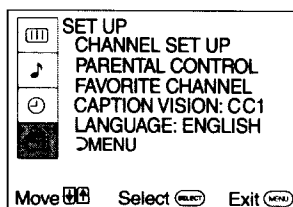
Using the SET UP menu

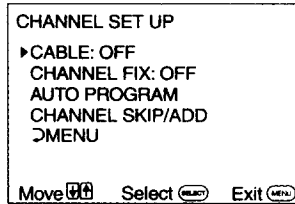

PARENTAL CONTROL	The PARENTAL CONTROL feature provides parents several options for programming the TV to block shows based on their rating, (see page 18).
FAVORITE CHANNEL <i>Quick access to favorite channels</i>	<p>With the FAVORITE CHANNEL menu open:</p> <ol style="list-style-type: none"> 1 Use the \uparrow or \downarrow buttons to select AUTO or MANUAL, (selecting AUTO will display the last five channels accessed by the 0-9 buttons). 2 Select the position (1-5) where you want to program a channel. 3 Using the \uparrow or \downarrow buttons, select the desired channel. 4 Press SELECT, the TV will change to the channel entered.
<p> To use FAVORITE CHANNEL: Exit all menus and press SELECT. A window picture will display your favorite channel numbers. Move the cursor to a channel number and press SELECT to view.</p>	
CAPTION VISION <i>Closed-captioning</i>	<p>CC1, 2, 3, 4: Displays printed dialogue of a program. TEXT1, 2, 3, 4: Displays network/station information. XDS (Extended Data Services): Displays information about the network and current program, if available.</p>
<p> Press the DISPLAY button to activate your CAPTION VISION setting.</p>	
LANGUAGE	<p>Display all menus in your language of choice.</p> <ol style="list-style-type: none"> 1 Point cursor at LANGUAGE and press SELECT. 2 Using the \uparrow or \downarrow buttons, highlight the desired language and press SELECT.

CHANNEL SET UP menu

CABLE **ON:** Select if you are receiving cable channels with a CATV cable.

OFF: Select if you are using an antenna.

After changing your CABLE settings, you will need to run AUTO PROGRAM.

CHANNEL FIX **2-6:** Select when you want to control all channel selection through a cable box. Select the appropriate channel (usually 3 or 4) and use the cable box's remote control for channel selection.

VIDEO: Select from available inputs when you have connected video equipment (e.g. satellite receiver) and you want your TV fixed to it.

FAVORITE CHANNEL cannot be used when CHANNEL FIX is set.

AUTO PROGRAM Run AUTO PROGRAM whenever setting up your TV. It will cycle through all available channels and program any receivable channels.

CHANNEL SKIP/ADD Use this feature after you run AUTO PROGRAM to skip unwanted channels or add new ones.

1 Use the or buttons to access the desired channel.

2 Press to SKIP or ADD (only one option will be available).

Using PARENTAL CONTROL

The PARENTAL CONTROL feature is designed to help parents monitor what their children watch on television. This section shows you the different rating systems available and how to set your TV's rating.

Overview of the Ratings

Once you have become familiar with these rating systems, you should be ready to set your TV's rating.

TV RATINGS

The TV ratings are divided into two groups: age-based and content-based.

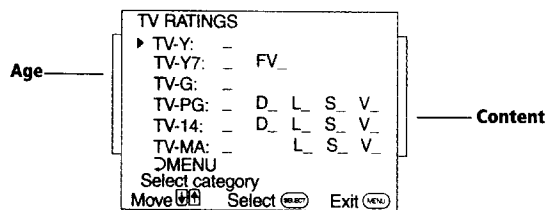

Age	Defined as	Contents	Defined as
TV-Y	All children	FV	Fantasy Violence
TV-Y7	Directed to older children	D	Suggestive dialogue
TV-G	General audience	L	Strong language
TV-PG	Parental Guidance suggested	S	Sexual situations
TV-14	Parents Strongly cautioned	V	Violence
TV-MA	Mature Audience only		

 The content ratings will increase depending on the level of the age-based rating. For example, a program with a TV-PG V (Violence) rating may contain moderate violence, while a TV-14 V (Violence) rating may contain more intense violence.

MOVIE RATINGS

(U.S. models only)

This system defines the rating levels of movies shown on the big screen and those on prime cable channels.

Rating	Defined as
G	General audience
PG	Parental Guidance suggested
PG-13	Parents Strongly cautioned
R	Restricted
NC-17	No one 17 and under admitted
X	No one 17 and under admitted

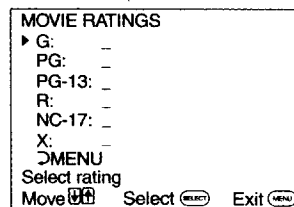
**UNRATED**

(U.S. models only)

You have the option of blocking TV programs or movies that are not rated.

Rating	Defined as
VIEW ALL	No block
BLOCK TV	Block all unrated TV programs
BLOCK MOVIE	Block all unrated movies
BLOCK ALL	Block all unrated programming

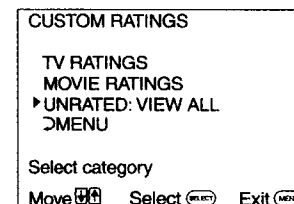

! If you choose to block unrated TV programs, please be aware the following programs may be blocked: emergency broadcasts, political programs, sports, news, public service announcements, religious programs and weather.

ENGLISH RATINGS

(Canadian models only)

These ratings are for Canadian programs that are broadcast in English.

Rating	Defined as
C	Children
C8+	Children 8 years and older
G	General programming
PG	Parental Guidance
14+	Viewers 14 and older
18+	Adult programming

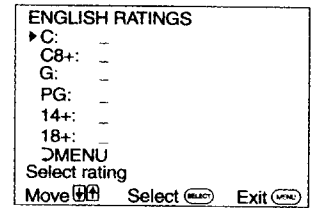

FRENCH RATINGS

(Canadian models only)

These ratings are for Canadian programs that are broadcast in French.

Rating	Defined as
G	General
8 ans+	Not recommended for younger children
13 ans+	Not recommended for children under age 13
16 ans+	Not recommended for ages under 16
18 ans+	This program is restricted to adults

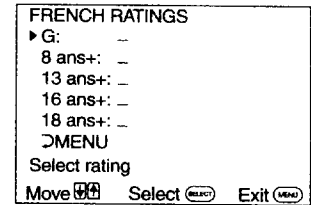





U.S.A RATINGS

(Canadian models only)

For programs from the United States. Please see, "TV RATINGS" on page 18 for information on U.S.A RATINGS.

Initial access into PARENTAL CONTROL

- 1 In the SET UP  menu, point the cursor to PARENTAL CONTROL and press , (you will be asked to set 4-digit password for any future access into PARENTAL CONTROL).
- 2 Press , then use the  buttons to enter a 4-digit password.

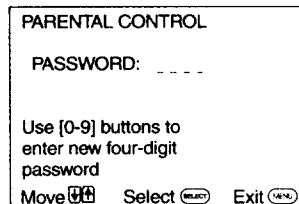

-  Keep this instruction manual in a safe place. In the event that you forget your password, please see pag e26.

- 3 Confirm your password by entering it again.

Once your password is set correctly, you will be taken into the PARENTAL CONTROL menu.

Activating PARENTAL LOCK



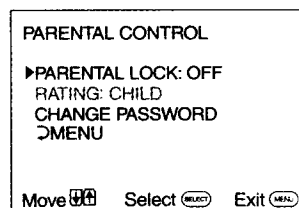

In order to change the RATING, you will need to set PARENTAL LOCK to ON.



- 1 Point the cursor to PARENTAL LOCK and press .
- 2 Using the  or  buttons, highlight ON and press  to activate.

Setting the RATING

If you are not familiar with the Parental Guidelines rating system, you should use one of the following preselected categories: CHILD, YOUTH or YOUNG ADULT.



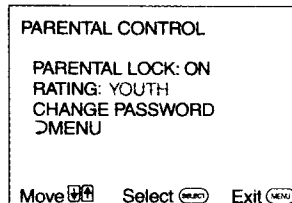











- 1 Point the cursor to RATING and press .
- 2 Using the  or  buttons, select the desired rating and press .



Rating	TV will allow a maximum rating of:
CHILD	TV-Y, TV-G, G (U.S. models only), G (Canadian models only)
YOUTH	TV-PG, PG (U.S. models only), PG (Canadian models only)
YOUNG ADULT	TV-14, PG-13 (U.S. models only), 14+ (Canadian models only)
CUSTOM	Select to set more restrictive ratings, (see next section).

Using the CUSTOM menu

You should be familiar with the rating systems before attempting to set CUSTOM ratings. Refer to pages 18-20, "Overview of the Ratings," for a description of the available rating systems.

- 1 In the RATING option, use  or  to highlight CUSTOM and press .
- 2 Using the  or  buttons, select the desired rating category and press .
- 3 Use  or  to select the maximum rating or content and press .
- 4 Press  or  to block () or unblock () the rating or content and press .



 Once you have blocked a rating or content, all higher ratings or contents will be automatically blocked.

Resetting your password

- 1 Use the \uparrow or \downarrow buttons to move the cursor to CHANGE PASSWORD and press .
- 2 Follow the directions for, "Initial Access into Parental Control," on page 21, for information on changing your password.

Information for Parents

To view a program that exceeds the TV rating

- Press  on the remote control, then use the $\textcircled{0}$ - $\textcircled{9}$ buttons to enter your password.
-  Entering your password to view a blocked program will temporarily turn PARENTAL LOCK to OFF. To reactivate your PARENTAL LOCK settings, turn the TV off then back on; the TV will return to the settings that you have selected.

Other Information

Troubleshooting

If you are having a problem with your TV, try the suggestions below. If the problem persists, contact your nearest Sony dealer.

No picture, no sound	<ul style="list-style-type: none"> <input type="checkbox"/> Make sure the power cord is plugged in. <input type="checkbox"/> If a red light is flashing on the front of your TV for more than a few minutes, call your local service center. <input type="checkbox"/> Check the TV/VIDEO settings: when watching TV, set to TV; when watching video equipment, set to VIDEO (page 13). <input type="checkbox"/> Check your PARENTAL CONTROL settings, (see pages 22-23). <input type="checkbox"/> Make sure the batteries have been inserted correctly into the remote control. <input type="checkbox"/> Try another channel, it could be station trouble.
Poor or no picture, good sound	<ul style="list-style-type: none"> <input type="checkbox"/> Adjust PICTURE in the VIDEO menu (page 13). <input type="checkbox"/> Adjust BRIGHTNESS in the VIDEO menu (page 13). <input type="checkbox"/> Check the antenna and/or cable connections (page 3).
Good picture, no sound	<ul style="list-style-type: none"> <input type="checkbox"/> Press MUTING so that MUTING disappears from the screen (page 9). <input type="checkbox"/> Check your AUDIO settings. Your TV may be set to SAP (page 14).
No color	<ul style="list-style-type: none"> <input type="checkbox"/> Adjust COLOR in the VIDEO menu (page 13).
Only snow appears on the screen	<ul style="list-style-type: none"> <input type="checkbox"/> Check the CABLE setting in the CHANNEL SET UP menu (page 17). <input type="checkbox"/> Check the antenna and/or cable connections (page 3). <input type="checkbox"/> Make sure the channel selected is currently broadcasting.
Dotted lines or stripes	<ul style="list-style-type: none"> <input type="checkbox"/> Adjust the antenna. <input type="checkbox"/> Move the TV away from other electronic equipment. Some electronic equipment can create electrical noise, which can interfere with TV reception.
Double images or ghosts	<ul style="list-style-type: none"> <input type="checkbox"/> Check your outdoor antenna or call your cable service.

Cannot receive higher number channels (UHF) when using an antenna	<ul style="list-style-type: none"> <input type="checkbox"/> Make sure CABLE is set to OFF in the CHANNEL SET UP menu (page 17). <input type="checkbox"/> Use AUTO PROGRAM to add channels that are not presently in the memory (page 17).
Cable stations don't seem to work	<ul style="list-style-type: none"> <input type="checkbox"/> Make sure CABLE is set to ON in the CHANNEL SET UP menu (page 16). <input type="checkbox"/> Use AUTO PROGRAM to add channels that are not presently in the memory (page 17).
Remote control does not operate	<ul style="list-style-type: none"> <input type="checkbox"/> Batteries could be weak. Replace them (page 2). <input type="checkbox"/> Move the TV 3-4 feet away from fluorescent lights.
The TV needs to be cleaned	<ul style="list-style-type: none"> <input type="checkbox"/> Clean the TV with a soft dry cloth. Never use strong solvents such as thinner or benzine, which might damage the finish of the cabinet.
Lost password for PARENTAL CONTROL	<ul style="list-style-type: none"> <input type="checkbox"/> In the password screen, enter the following master password: 4357. After using the master password, you must create a new password, it cannot be used to unlock currently blocked programs.

If, after reading these operating instructions, you have additional questions related to the use of your Sony television, please call our Direct Response Center at 1-800-222-SONY (7669) (U.S. customers only) or (416) 499-SONY (7669) (Canadian customers only).

Specifications

For all models (except as noted)

Television system	American TV standard/NTSC
Channel coverage	VHF: 2-13/UHF: 14-69/CATV: 1-125
Antenna	75-ohm external antenna terminal for VHF/UHF
Picture tube	Trinitron® tube
Power requirements	120 V, 60 Hz
Supplied Accessories	Size AA (R6) batteries (2) Antenna connector (except KV-20M42, 20S42, 20S43) Remote Control RM-Y155 (1) (KV-20S43, 20S42) Remote Control RM-Y156 (1) (KV-13M42, 13M52, 13M53, 20M42) Antenna dipole (KV-13M42, 13M52, 13M53 only)
Optional Accessory	Antenna dipole (KV-20M42, 20S42, 20S43)

KV-13M42, 13M52, 13M53

Screen size	Visible screen size: 13 in. measured diagonally Actual tube size: 14 in. measured diagonally
Inputs/outputs	1 video, 1 audio (KV-13M42) 2 video, 2 audio (KV-13M52, 13M53) 1 headphone jack
Speaker output	3 W
Power Consumption	75 W when in use 1 W in standby
Dimensions (W/H/D)	358 x 355 x 401.4 mm (14 1/8 x 14 x 15 7/8 in.)
Mass	10 kg (22 lbs.)

KV-20M42, 20S42, 20S43

Screen size	Visible screen size: 20 in. measured diagonally Actual tube size: 21 in. measured diagonally
Inputs/outputs	2 video, 2 audio 1 headphone jack
Speaker output	3 W (KV-20M42) 3W x 2 (KV-20S42, 20S43)
Power Consumption	80 W when in use (KV-20M42) 90 W when in use (KV-20S42, 20S43) 1 W in standby
Dimensions (W/H/D)	522 x 477 x 479 mm (20 5/8 x 18 13/16 x 18 7/8 in.)
Mass	21.6 kg (48 lbs.)

Design and specifications are subject to change without notice.

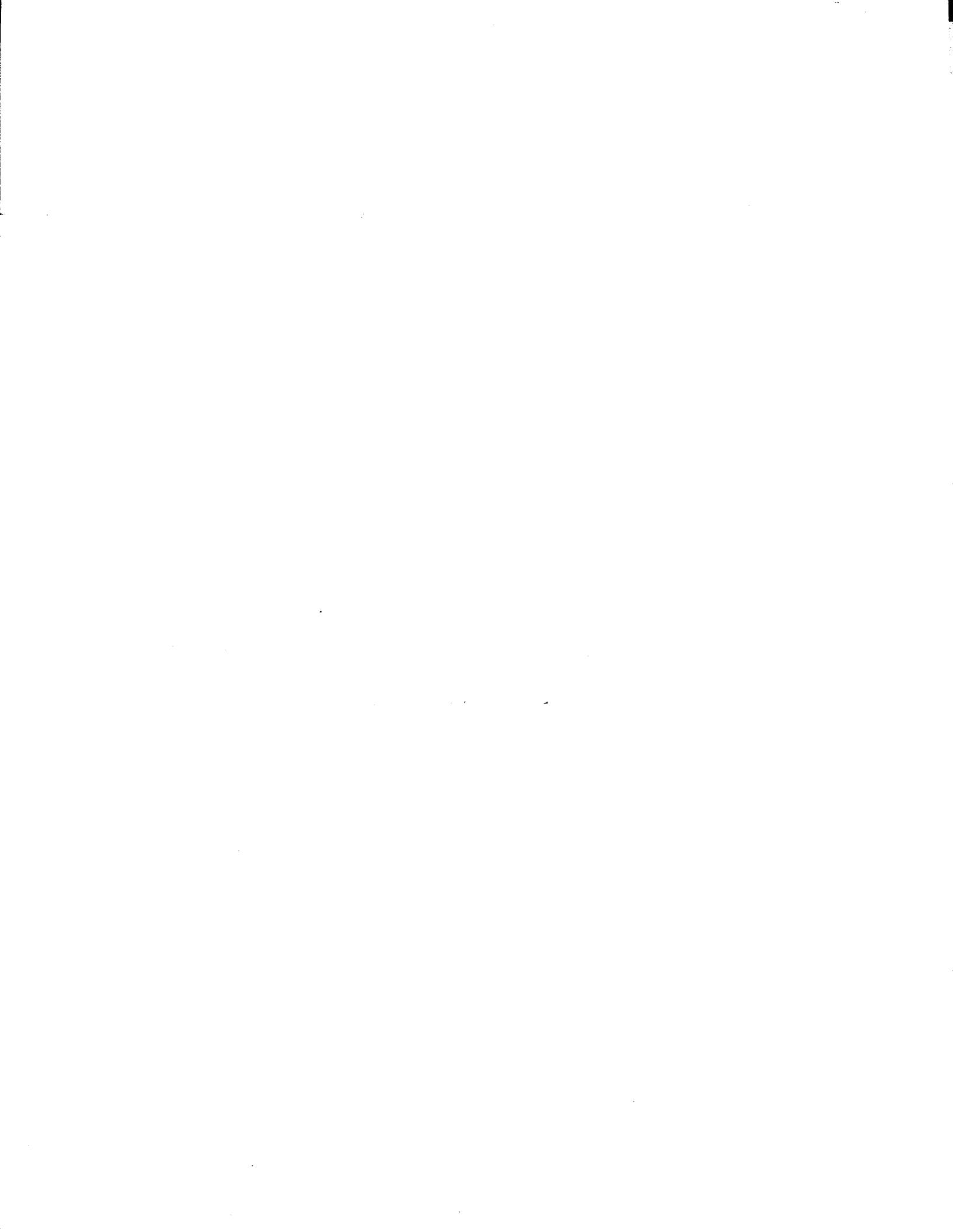

Index

A

AUDIO 🎵 menu 14
 AUTO PROGRAM 17

B

Battery Installation 2
 BRIGHTNESS 13

C

CAPTION VISION 16
 CHANNEL FIX 17
 CHANGE PASSWORD 23
 CHANNEL SET UP 17
 COLOR 13
 Connections
 Antenna/Cable 3
 TV and Cable Box 5
 TV and VCR 4
 TV, VCR, and Cable box 6
 Connecting a Camcorder 7
 CURRENT TIME SET 15

D

DAYLIGHT SAVING 15
 Direct MTS 14

E

ENGLISH RATINGS 20

F

FAVORITE CHANNEL 1, 16
 FRENCH RATINGS 20

H

Headphone Jack 1
 HUE 13

L

LANGUAGE 16

M

Menus 13
 AUDIO 🎵 14
 SET UP 📺 16

TIMER ⏰ 15
 VIDEO 📺 13
 Menu Selection 11
 MOVIE RATING 19
 MTS 14
 MONO 14
 SAP 14
 STEREO 14

O

ON/OFF TIMER 1, 15

P

PARENTAL CONTROL 1, 18
 Password 21
 Entering 21
 Lost 26
 PICTURE 13

R

RATINGS 18
 ENGLISH 20
 FRENCH 20
 MOVIE 19
 TV 18
 UNRATED 19
 Remote Control 9

S

SET UP 📺 menu 16
 SHARPNESS 13
 Specifications 27

T

TIMER ⏰ menu 15
 Troubleshooting 25
 TV Features 1
 TV RATING 18

U

U.S.A. RATINGS 20
 UNRATED 19

V

VIDEO 📺 menu 13