

SONY

Trinitron® Color TV

Operating Instructions

KV-32S40 *KV-32V40* *KV-35S40* *KV-35V65*
KV-32S45 *KV-32V65* *KV-35S45*
KV-32S65 *KV-35S65*

© 1998 by Sony Corporation

Remote Control

In the instructions that follow, we will refer to the buttons on your remote control. Model shown is RM-Y167, your remote control may not look like the one illustrated.

Keep this flap unfolded and look to this page for reference.

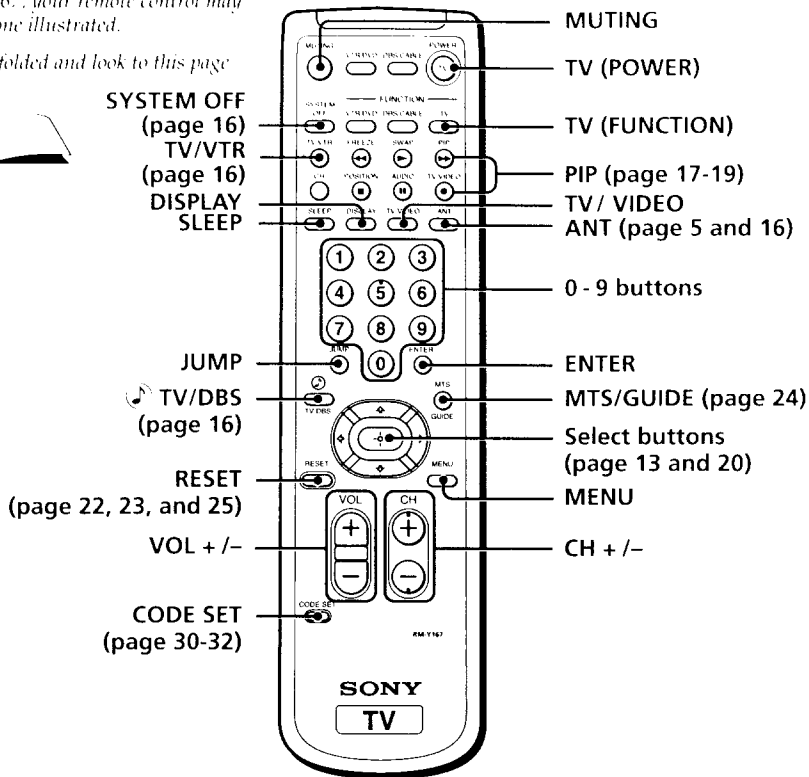
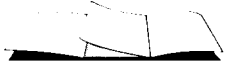

Getting to know the buttons on the remote control

Names of the buttons on the remote control are presented in different colors to represent the available functions.

Button color

- Transparent Press to select the component you want to control; e.g. VTR (VCR)/DVD, DBS (Direct Broadcast Satellite)/CABLE, or TV
- Green Buttons relevant to power operations, like turning the TV, DBS (Direct Broadcast Satellite)/CABLE, or VTR (VCR)/DVD on or off

Label color

- White TV/VTR (VCR)/DVD/DBS (Direct Broadcast Satellite)/CABLE operation buttons
- Yellow PIP operation buttons
- Blue DBS (Direct Broadcast Satellite) operation buttons
- Green SYSTEM OFF operation button

For a detailed explanation of most buttons, see "Watching the TV" on page 15.

WARNING

To prevent fire or shock hazard, do not expose the TV to rain or moisture.

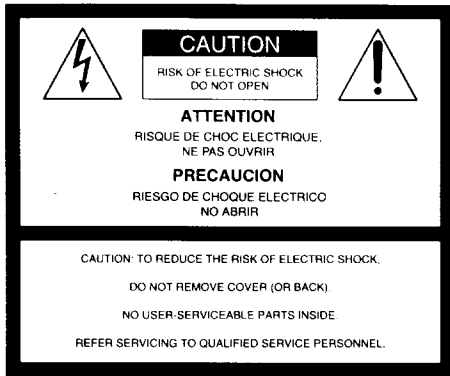

This symbol is intended to alert the user to the presence of uninsulated "dangerous voltage" within the product's enclosure that may be of sufficient magnitude to constitute a risk of electric shock to persons.



This symbol is intended to alert the user to the presence of important operating and maintenance (servicing) instructions in the literature accompanying the appliance.

CAUTION

TO PREVENT ELECTRIC SHOCK, DO NOT USE THIS POLARIZED AC PLUG WITH AN EXTENSION CORD, RECEPTACLE, OR OTHER OUTLET UNLESS THE BLADES CAN BE FULLY INSERTED TO PREVENT BLADE EXPOSURE.

CAUTION

When using TV games, computers, and similar products with your TV, keep the brightness and picture contrast functions at low settings. If a fixed (non-moving) pattern is left on the screen for long periods of time at a high brightness or picture contrast setting, the image can be permanently imprinted onto the screen. Continuously watching the same program can cause the imprint of station logos onto the TV screen. These types of imprints are not covered by your warranty because they are the result of misuse.

Note on Caption Vision

This television receiver provides display of television closed captioning in accordance with §15.119 of the FCC rules.

Note on cleaning the TV

Clean the TV with a soft dry cloth. Never use strong solvents such as thinner or benzene, which might damage the finish of the cabinet.

Note to CATV system installer

This reminder is provided to call the CATV system installer's attention to Article 820-40 of the NEC that provides guidelines for proper grounding and, in particular, specifies that the cable ground shall be connected to the grounding system of the building, as close to the point of cable entry as practical.

Use of this television receiver for other than private viewing of programs broadcast on UHF or VHF or transmitted by cable companies for the use of the general public may require authorization from the broadcaster/cable company and/or program owner.

NOTIFICATION

This equipment has been tested and found to comply with the limits for a Class B digital device pursuant to Part 15 of the FCC Rules. These limits are designed to provide reasonable protection against harmful

interference in a residential installation. This equipment generates, uses, and can radiate radio frequency energy and, if not installed and used in accordance with the instructions, may cause harmful interference with radio communications. However, there is no guarantee that interference will not occur in a particular installation. If this equipment does cause harmful interference to radio or television reception, which can be determined by turning the equipment off and on, the user is encouraged to try to correct the interference by one or more of the following measures:

- Reorient or relocate the receiving antennas.
- Increase the separation between the equipment and receiver.
- Connect the equipment into an outlet on a circuit different from that to which the receiver is connected.
- Consult the dealer or an experienced radio/TV technician for help.

You are cautioned that any changes or modifications not expressly approved in this manual could void your authority to operate this equipment.

This document is for the remote controls RM-Y165/Y167.





MODELS: KV-32S40, 32S45, 32S65, 32V40, 32V65, 35S40, 35S45, 35S65, 35V65



As an ENERGY STAR® Partner, Sony has determined that this product or product models meets the ENERGY STAR® guidelines for energy efficiency.

ENERGY STAR® is a U.S. registered mark.

Table of Contents

Welcome!	3	Additional Connections	9	Using Your Menus	
Precautions	3	Connecting a DVD Player	9	Learning menu selection	20
Using This Manual	3	Connecting an audio system	9	Quick start to the menus	21
Connecting and Installing the TV					
Making Connections	4	Connecting an A/V receiver	10	Using the VIDEO  menu	22
Cable or Antenna Connections	5	Connecting two VCRs	10	Using the AUDIO  menu	23
Connecting directly to cable		Connecting a camcorder	11	Using the TIMER  menu	25
or an antenna	5	S-link Connections	12	Using the SET UP  menu	26
Cable and antenna	5	Connecting S-Link to a VCR	12	Using the BASIC  menu	29
Cable Box Connections	6	Connecting S-Link to a DBS	12	<hr/>	
Cable box	6	Basic Set Up		Operating Video Equipment	
Cable box and cable	6	Inserting batteries	13	Programming the remote control	30
VCR Connections	7	Using the remote control move &		<hr/>	
Connecting an antenna/cable TV		select buttons	13	Operating a Cable Box or DBS	
system with a VCR	7	On-screen help/instructions	13	Receiver	
Connecting a VCR and TV with a		<hr/>			
cable box	7	Using Your New TV		Programming the remote control	32
DBS Connections	8	Setting up the TV automatically	14	<hr/>	
Connecting a DBS receiver	8	Watching the TV	15	Troubleshooting	33
Connecting a DBS receiver		Watching two programs at one		Specifications	34
and a VCR	8	time-PIP	17	Index	36
		Single Tuner PIP	17		
		Dual Tuner PIP	19		

Welcome!

Thank you for purchasing the Sony Trinitron® Color TV. This manual is written for the models listed below. Before reading, check the model number located on the front of this manual or on the rear of your TV.

Model KV-35S45 is used for menu and illustration purposes. Differences in operation are indicated in the text; for example, "KV-35S45 only".

Model Number	Simple tuner (CRT required for PIP)	Dual tuner (Ready to Use - PIP)	SRS	SURROUND	FAVORITE CHANNEL with Preview	AUTO VOLUME Control
KV-32S40				•		
KV-32S45	•			•		
KV-32S65		•		•	•	
KV-32V40			•			•
KV-32V65		•	•		•	•
KV-35S40				•		
KV-35S45	•			•		
KV-35S65		•		•	•	
KV-35V65		•	•		•	•

Precautions

Safety

- Operate the TV only with 120 V AC.
- The plug is designed, for safety purposes, to fit in the wall outlet only one way. If you are unable to insert the plug fully into the outlet, contact your dealer.
- If any liquid or solid object should fall inside the cabinet, unplug the TV immediately and have it checked by qualified personnel before operating it further.
- If you will not be using the TV for several days, disconnect power by pulling the plug itself. Never pull on the cord.

For details concerning safety precautions, see the supplied leaflet "IMPORTANT SAFEGUARDS".

Installing

- To prevent internal heat build-up, do not block the ventilation openings.
- Do not install the TV in a hot or humid place, or in a place subject to excessive dust or mechanical vibration.

Using This Manual

This manual is divided into four major sections. We recommend that you carefully review the contents of each section in the order presented to ensure that you fully understand the operation of your new TV.

1 Connecting and Installing the TV

This section guides you through your initial set up. It shows how to connect to your antenna or cable, and connect any accessories or components.

2 Basic Set Up

This section teaches you the basic skills needed to operate your new TV. It shows you how to operate special functions of the remote control.

3 Using your New TV

This section shows you how to begin using your new TV. It shows how to use the Easy Set Up Guide feature, and how to use your remote control.

4 Using your Menus

This section teaches you how to access on-screen menus and adjust your TV's settings.

Instructions in this manual are written for the remote control. Similar controls may be found on the TV console.

Making Connections

Refer to the table below, it will direct you to the diagram suitable to the components you will be connecting.

If you will be connecting	See page
Cable or antenna only	5
Cable and antenna (KV-32S65, 32V65, 35S65, 35V65 only)	5
Cable box	6
Cable box and cable to view scrambled channels (KV-32S65, 32V65, 35S65, 35V65 only)	6
VCR and cable or antenna	7
VCR and cable box	7
Direct Broadcast Satellite Receiver (DBS)	8
VCR and Direct Broadcast Satellite Receiver (DBS)	8
Digital Versatile Disc player (DVD)	9
Audio system	9
A/V receiver	10
Two VCR's for tape editing (KV-32V40, 32V65, 35V65 only)	10
Camcorder to view tapes	11
S-Link connections (KV-32S65, 32V65, 35S65, 35V65 only)	12

Cable or Antenna Connections

Connecting directly to cable or an antenna

The connection you choose will depend on the cable found in your home. Newer homes will be equipped with standard coaxial cable (see **A**); older homes will probably have 300-ohm twin lead cable (see **B**); still other homes may contain both (see **C**).

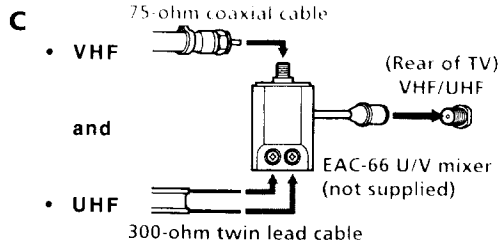
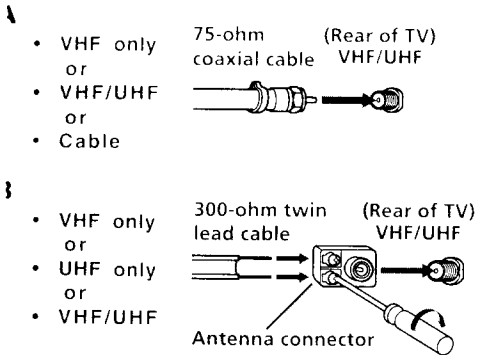

Note

- In order to receive channels with an antenna, you will need to turn your CABLE to OFF (see page 26) and perform the AUTO PROGRAM function.

Cable and antenna

- KV-32S65, 32V65, 35S65, 35V65 only

If your cable provider does not feature local channels, you may find this set up convenient for viewing both local and cable channels.

Select cable or antenna mode by pressing ANT on the remote control. You will be able to alternate between the two input sources.

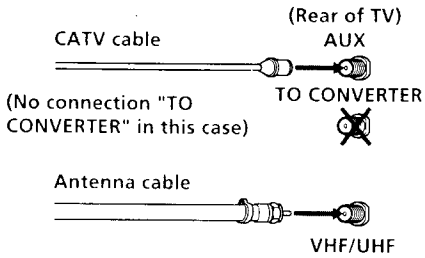

Cable Box Connections

Some pay cable TV systems use scrambled or encoded signals that require a cable box to view all channels.

Cable box

- 1 Connect the coaxial connector from your cable to the IN on your cable box.
- 2 Using a coaxial cable, connect OUT on your cable box to VHF/UHF on your TV.

If you will be controlling all channel selection through your cable box, you should consider using the CHANNEL FIX feature discussed on page 26.

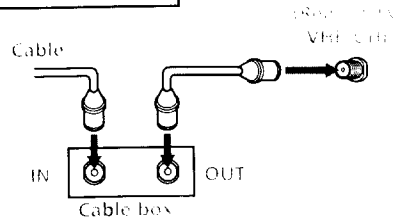

Cable box and cable

- KV-32S65, 32V65, 35S65, 35V65 only

For this set up, you can switch between scrambled channels (through your cable box), and normal (CATV) channels by pressing ANT on your remote control.

Notes

- Your Sony remote control can be programmed to operate your cable box. (see page 32)
- When using PIP, you cannot view the AUX input in the window picture.

Tip

Pressing ANT switches between these inputs.

If you are connecting a cable box through the AUX input and would like to switch between the AUX and normal (CATV) input you should consider using the CHANNEL FIX feature discussed on page 26.

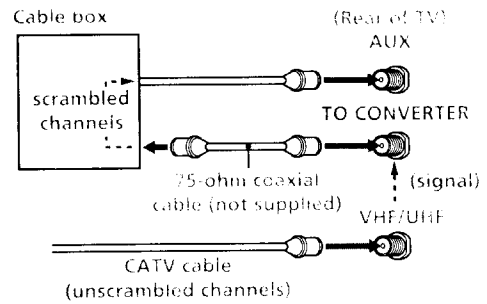

VCR Connections

Connecting an antenna/cable TV system with a VCR

- 1 Attach the coaxial connector from your cable or antenna to IN on your VCR.
- 2 Using A/V connectors, connect AUDIO and VIDEO OUT on your VCR to AUDIO and VIDEO IN on your TV.*
- 3 Using a coaxial connector, connect OUT on your VCR to VHF/UHF on your TV.

If you are connecting a monaural VCR, connect only the single white audio output to the left input on your TV.

VCR must be connected and turned on to operate PIP (KV-32S45, 35S45 only).

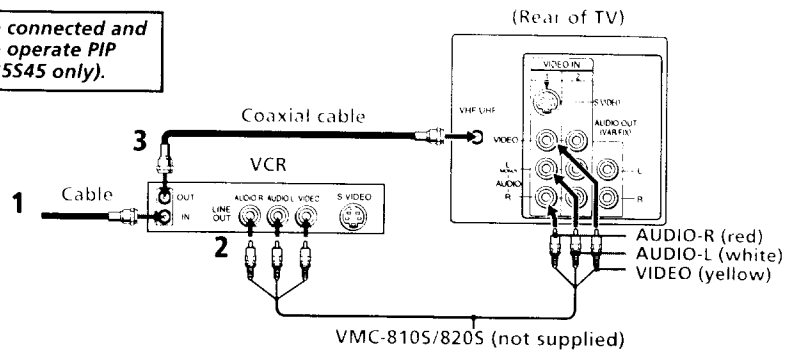

Connecting a VCR and TV with a cable box

You will need a splitter (not supplied) for the following connection.

- 1 Connect the single (input) jack of the splitter to your incoming cable connection. Connect the other two (output) jacks (using coaxial cable) to IN on your cable box and VHF/UHF on your TV.
- 2 Using a coaxial connector, connect OUT on your cable box to IN on your VCR.
- 3 Using A/V connectors, connect AUDIO and VIDEO OUT on your VCR to AUDIO and VIDEO IN on your TV.

For optimum picture quality, use S VIDEO instead of the yellow A/V cable. S Video does not provide sound, your audio connectors must still be connected.

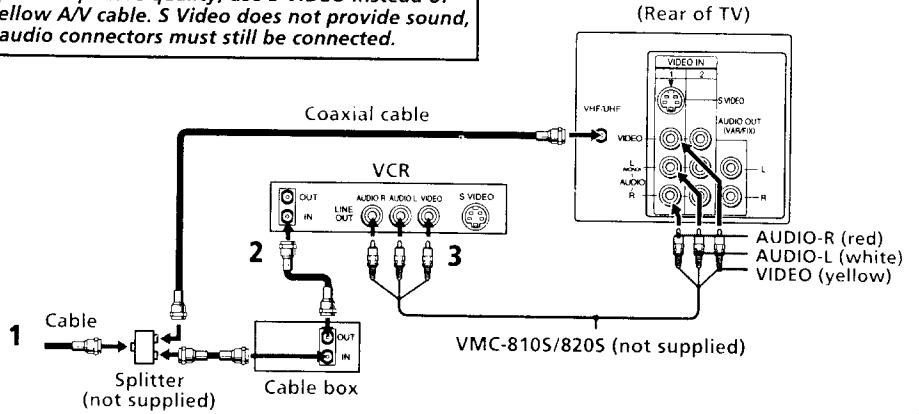

Disconnect all power sources before making any connections

DBS Connections

Connecting a DBS (Direct Broadcast Satellite) receiver

- 1 Connect the cable from your satellite antenna to your DBS receiver.
- 2 Attach the coaxial connector from your cable or antenna to VHF/UHF on your TV.
- 3 Using A/V connectors, connect AUDIO and VIDEO OUT on your DBS receiver to AUDIO and VIDEO IN on your TV.

For optimum picture quality, use S VIDEO instead of the yellow A/V cable. S Video does not provide sound, your audio connectors must still be connected.

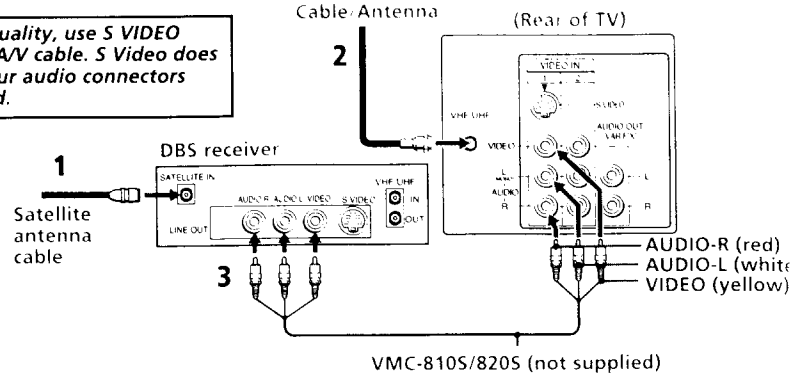

Connecting a DBS (Direct Broadcast Satellite) receiver and a VCR

- 1 Connect the cable from your satellite antenna to your DBS receiver.
- 2 Attach the coaxial connector from your cable or antenna to VHF/UHF IN on your VCR.
- 3 Using a coaxial connector, connect VHF/UHF OUT on your VCR to VHF/UHF on your TV.
- 4 Using A/V connectors, connect AUDIO and VIDEO OUT on your DBS receiver to AUDIO and VIDEO IN on your VCR.
- 5 Using A/V connectors, connect AUDIO and VIDEO OUT on your VCR to AUDIO and VIDEO IN on your TV.

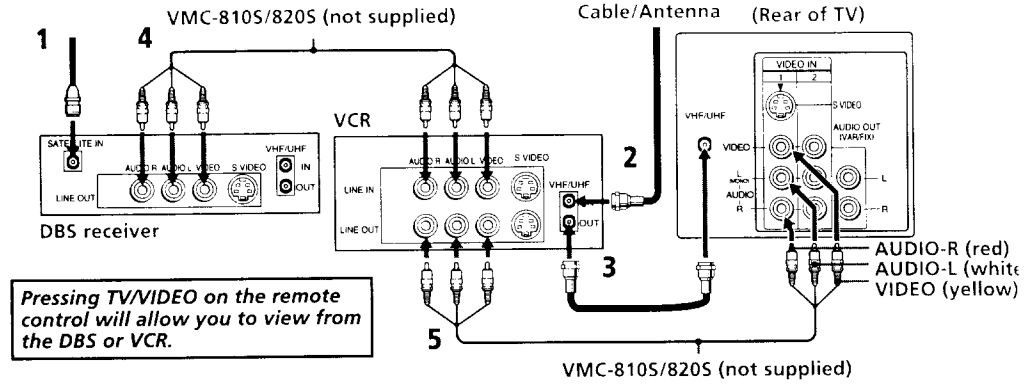

Pressing TV/VIDEO on the remote control will allow you to view from the DBS or VCR.

Disconnect all power sources before making any connections.

Additional Connections

The following connections are for accessories that will enhance your viewing options.

Connecting a DVD Player

- 1 Using A/V connectors, connect LINE OUT on your DVD to VIDEO IN on your TV.

For optimum picture quality, use S VIDEO instead of the yellow A/V cable. S Video does not provide sound, your audio connectors must still be connected.

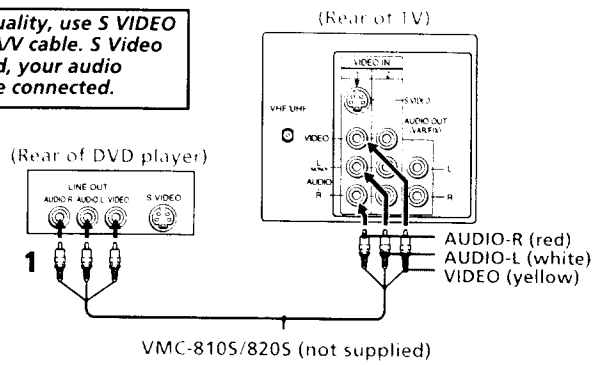

Connecting an audio system

For enhanced sound, connect your audio system to your TV.

- 1 Using AUDIO connectors, connect AUDIO OUT on your TV to one of the unused line inputs (e.g. TV, AUX, TAPE 2) on your stereo.
- 2 Set your stereo to the chosen line input. Refer to page 24 of this manual for additional audio setup instructions.

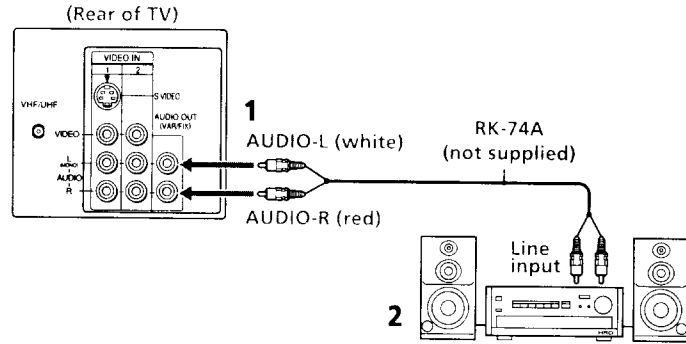

Connecting an A/V receiver

• KV-32V65, 35V65 only

- 1 Using A/V cables, connect TV OUT on your TV to TV IN on your A/V receiver.
- 2 Using a single video connector, connect Monitor OUT on your A/V receiver to VIDEO 1 IN on your TV.

Tip You may want to use CHANNEL FIX to set your TV's input to the A/V receiver. See page 26.

Disconnect all power sources before making any connections

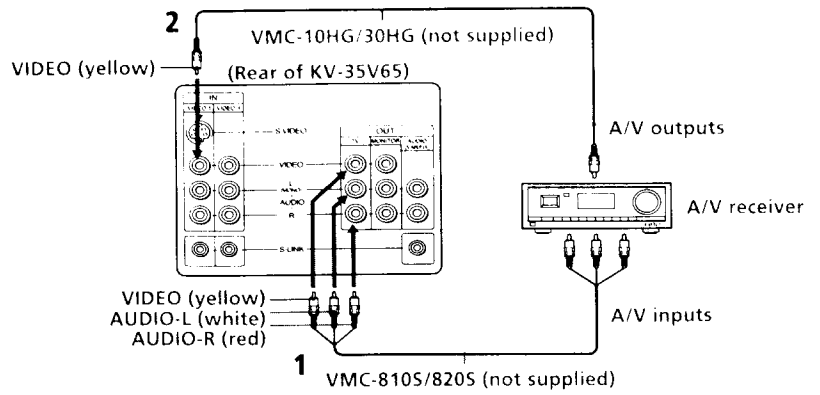

Connecting two VCRs

• KV-32V40, 32V65, 35V65 only

MONITOR OUT gives you the ability to use a second VCR to record a program being played by the primary VCR or to perform tape editing and dubbing.

- 1 Connect the VCR intended for playback using the setup instructions on page 7 of this manual.
- 2 Using A/V connectors, connect AUDIO and VIDEO IN on your VCR intended for recording to MONITOR AUDIO and VIDEO OUT on your TV.

You cannot change video inputs while editing using MONITOR OUT.

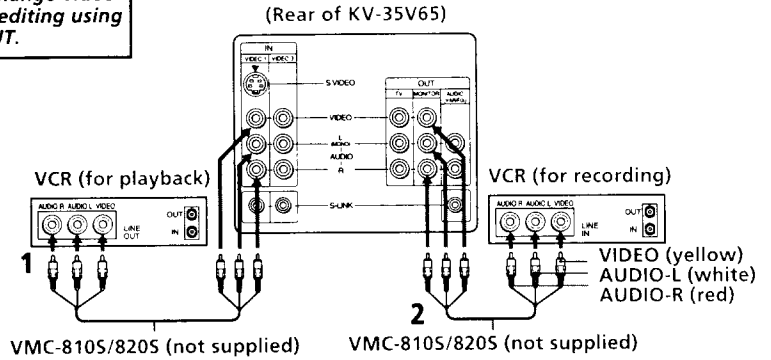

Connecting a camcorder

This connection is convenient for viewing a picture directly from your camcorder.

Using A/V connectors, connect AUDIO and VIDEO OUT on your camcorder to AUDIO and VIDEO IN on your TV.

Connection can also be made directly to your A/V input located on the rear of your TV.

Note

- If you are connecting a monaural camcorder, connect only the single white audio output to the left input on your TV.

Disconnect all power sources before making any connections.

If you have an S VIDEO equipped camcorder, you can use an S Video cable for optimum picture quality.

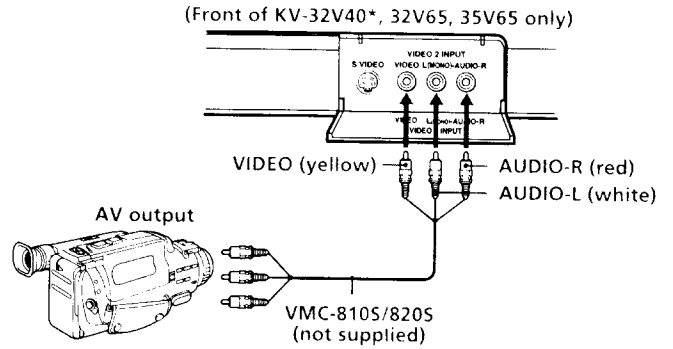

* KV-32V40 does not have S VIDEO on the front panel.

Disconnect all power sources before making any connection

S-Link connections

- KV-32S65, 32V65, 35S65, 35V65 only

S-Link is designed to allow your Sony components to "communicate".

Connecting S-Link to a VCR

S-Link will automatically power on the TV and switch to the correct video input when a tape is inserted in the VCR.

- 1 Using A/V connectors, connect AUDIO and VIDEO OUT on your VCR to AUDIO and VIDEO IN on your TV.
- 2 Using an S-Link connector (mono mini plug), connect S-LINK/CONTROL S-IN on your VCR to S-LINK on your TV.

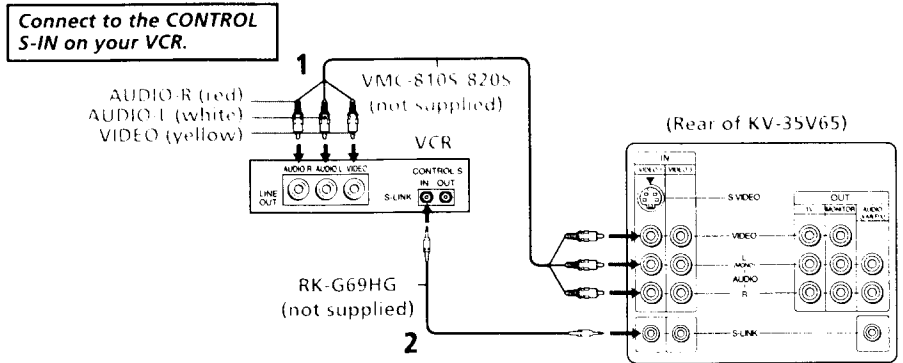

Connecting S-Link to a DBS

S-Link will automatically power on the TV and switch to the correct video input when you power on the DBS.

- 1 Using A/V connectors, connect AUDIO and VIDEO OUT on your DBS to AUDIO and VIDEO IN on your TV.
- 2 Using an S-Link connector (mono mini plug), connect S-LINK on your DBS to S-LINK on your TV.

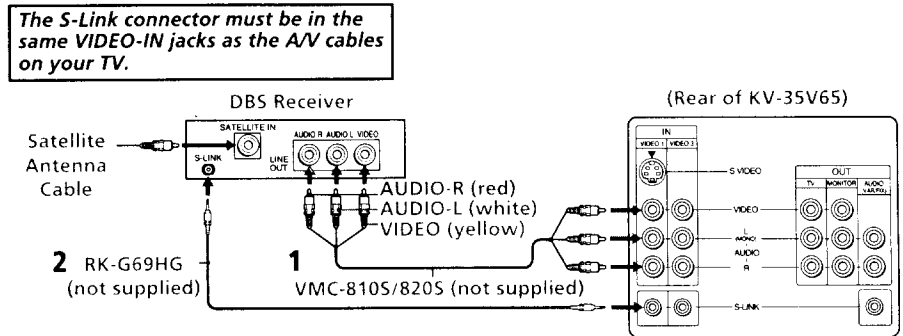

Inserting batteries

Insert two size AA (R6) batteries (supplied) by matching the + and - on the batteries to the diagram inside the battery compartment.

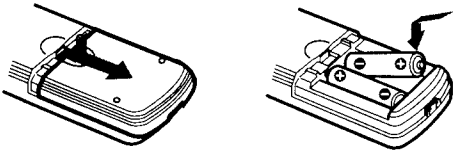

Notes

- Remove the batteries to avoid damage from possible battery leakage whenever you anticipate that the remote control will not be used for an extended period.
- Handle the remote control with care. Avoid dropping it, getting it wet, or placing it in direct sunlight, near a heater, or where the humidity is high.
- Your remote control can be programmed to operate most video equipment. (see page 30)

Using the remote control move & select buttons

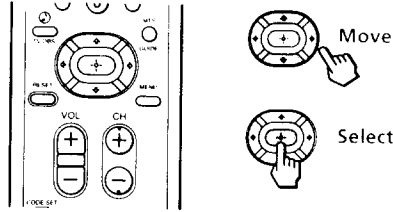

The supplied remote control has "arrow" buttons (↑, ↓, ←, →) which allow for movement of the on-screen selector. Pressing on the outer buttons will cause the selector to *move* in the corresponding direction. Pressing the center button (○) will *select* the item.

Adjustment bars

When menu items present an adjustment bar (▬ or ▬), use the arrow buttons to change the setting.

On-screen help/instructions

Several menu windows will provide prompts and instructions to assist you in navigating through the different functions. *When presented, use these to supplement the instructions in this manual.*

Setting up the TV automatically

The Easy Setup Guide allows you to set the on-screen language and set all receivable channels in one step.

The Easy Setup Guide feature does not apply for installations that use a cable box for all channel selection.

To set up the TV manually, refer to "Using the SET UP menu" on page 26.

Tips

- Perform this function during the day, with the antenna and/or cable properly connected, to ensure that all available channels will be broadcasting and receivable.
- The TV must be set to the TV input to execute AUTO PROGRAM. Press TV/VIDEO until a channel number appears.
- If your cable or antenna is connected to AUX, press ANT until AUX appears next to the channel number. (KV-32S65, 32V65, 35S65, 35V65 only)

Using the buttons on the front of the TV:



For KV-32V65, 35V65, the control buttons are located on the top of the TV.

- 1 Press POWER to turn on the TV. The Easy Setup Guide screen appears.

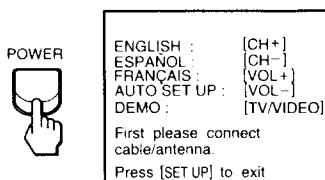

- 2 Press CH + to select ENGLISH screens, CH - to select ESPAÑOL screens or VOL + to select FRANÇAIS screens.

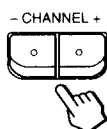

- 3 Press VOL - to continue or TV/VIDEO for a DEMO of functions and menus.

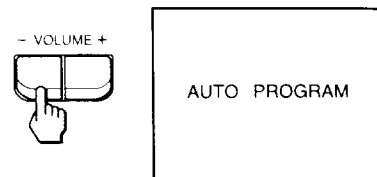

AUTO PROGRAM appears and the TV starts scanning and presetting channels automatically. If the TV receives cable TV channels, CABLE is set ON automatically.

To perform AUTO SET UP again

Press the SET UP button on the TV and follow steps 2-3.

Notes







- When you perform AUTO PROGRAM, your CHANNEL FIX, CHANNEL BLOCK and ON/OFF TIMER settings will be erased.
- To reset your TV to factory settings, turn the TV on. Then, while pressing the RESE button on your remote control, press the POWER key on your TV. The TV will turn itself off, then back on.



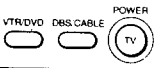
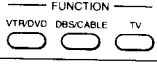

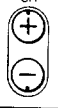

Watching the TV

All of the TV features can be accessed via the remote control. The following chart will explain the function of the buttons found on your remote control.

REFER TO THE
ILLUSTRATION OF THE
REMOTE CONTROL ON THE
INSIDE FRONT COVER OF
THIS MANUAL AS YOU
REVIEW THIS CHART

Using the White Labeled Buttons for TV Operations

	<p>Press when you want to turn equipment on and off.</p>
	<p>Press when you want to control connected components with your remote control. (see pages 30-32 for instructions on programming your remote control)</p>
	<p>Use for direct channel selection. Press 0-9 to select a channel, the channel will change after 2 seconds, or you can press ENTER for immediate selection.</p>
	<p>Press to scan through the channels. <i>Keeping the CH + or - pressed allows you to rapidly scan to the desired channel.</i></p>
	<p>Press to alternate or <i>jump</i> back and forth between two channels. You can jump between the last two channels selected with the 0-9 keys.</p>
	<p>Press to mute the sound (MUTING will appear on the screen). Press again or press VOL + to restore sound.</p>
	<p>Press repeatedly until the TV displays the approximate time in minutes (30, 60, or 90) that you want the TV to remain on before shutting off automatically. Cancel by pressing until SLEEP OFF appears.</p>

Using the White Labeled Buttons for TV Operations	
 DISPLAY	Press repeatedly to cycle through available displays: Status Channel number, current time, channel caption (if set) are displayed. CAPTION VISION Closed Captioning will be displayed if the broadcaster offers this service. (see right) To cancel the display, press DISPLAY until DISPLAY OFF appears.
 TV VIDEO	Press repeatedly to cycle through available video inputs: TV and VIDEO 1 (KV-32S40 only) TV, VIDEO 1 and VIDEO 2 (KV-32S45, 32S65, 35S40, 35S45, 35S65 only) TV, VIDEO 1, VIDEO 2 and VIDEO 3 (KV-32V40, 32V65, 35V65 only)
 ANT (AUX input)	Press to change the VHF/UHF input to the AUX input. (KV-32S65, 32V65, 35S65, 35V65 only) Press to change to the TV input. (KV-32S40, 32S45, 32V40, 35S40, 35S45 only) For detailed connection information, see "Cable and antenna" or "Cable box and cable" on pages 5-6.
 TV/VTR	Press when you are finished using a VCR and you want to switch to the TV input. Your VCR power will remain on.
 MTS GUIDE	Press this button to cycle through the Multi-channel TV Sound (MTS) options: STEREO, SAP, MONO. (see page 24) GUIDE is a feature of DBS, refer to your DBS operation instructions.
 SYSTEM OFF	The SYSTEM OFF button allows you to power off all Sony equipment at once. (KV-32S45, 32S65, 32V65, 35S45, 35S65, 35V65 only)
 TV DBS	Press to turn ON or OFF one of the following audio effects: SURROUND: KV-32S40, 32S45, 32S65, 35S40, 35S45, 35S65 only AUTO VOLUME: KV-32V40, 32V65, 35V65 only See page 23 for more information on AUDIO settings. TV/DBS is a feature of DBS, refer to your DBS operating instructions.

CAPTION VISION
Closed Captioning

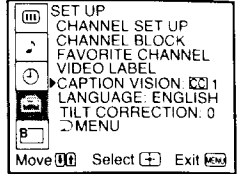

CAPTION VISION can be used for programs that are broadcast with closed caption.

CC1, 2, 3 or 4

Shows you a printed version of the dialog or sound effects of a program. (The mode should be set to CC1 for most programs)

TEXT1, 2, 3 or 4

Shows you network/station information presented using either half or the whole screen.

XDS (Extended Data Service)

Shows a network name, program name, program length, and time of the show if the broadcaster offers this service.

Note

- Poor reception of TV programs can cause errors in CAPTION VISION and XDS. Captions may appear with a white box or other errors instead of intended text.

Watching two programs at one time - PIP

The Picture-in-Picture (PIP) feature allows you to view two channels simultaneously, one in the full size "main" picture and one in a smaller "window" picture.

Single Tuner PIP

• **KV-32S45, 35S45 only**

If you have model KV-32S65, 32V65, 35S65 or 35V65, see page 19.

These models are equipped with a single tuner. This simply means that a VCR must be connected and turned on for PIP to operate.

To ensure a correct single tuner PIP connection make sure the following list is complete before using PIP:

- A cable or antenna is connected to the VCR
- The VCR is connected to your TV (see pages 5-7)
- The VCR is turned on
- The remote control has been programmed to operate the VCR (see page 30)

Note

- You must press TV (FUNCTION) before you can control PIP with the yellow labeled buttons.





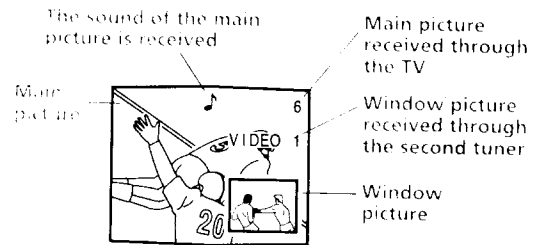

REFER TO THE ILLUSTRATION OF THE REMOTE CONTROL ON THE INSIDE FRONT COVER OF THIS MANUAL AS YOU REVIEW THIS CHART

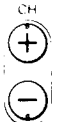

Use the Yellow Labeled Buttons for PIP Operations

<p>PIP</p>	<p>Press once to display the window picture (1/9 size). Press again to reduce the size of the window picture (1/16 size). Press a third time to remove the window picture.</p>
<p>TV/VIDEO</p>	<p>Press repeatedly to cycle through available video inputs in the window: TV, VIDEO 1, VIDEO 2</p>
<p>TV/VIDEO</p>	<p>Press repeatedly to cycle through available video inputs in the main picture: TV, VIDEO 1, VIDEO 2</p>
<p>AUDIO</p>	<p>Press to alternate sound between the main picture and the window picture. A ♪ will appear for a few seconds to indicate which picture is receiving sound.</p>

Use the Yellow Labeled Buttons for PIP Operations

	Press to change the channel. You must press VTR/DVD (FUNCTION), then use the main CH +/- buttons to change channels in the window picture. (see right)
POSITION 	Press to move the location of the window picture (counterclockwise) around the main picture.
FREEZE 	Press to freeze the window picture. Great for copying down phone numbers, addresses, recipes, etc. <i>Press FREEZE again to restore the picture.</i>
SWAP 	Press to switch the audio and video of the main picture and the window picture. Each time you press SWAP, the picture and sound of the two will be <i>swapped</i> .

CHANGING CHANNELS

- 1 Press TV/VIDEO until you reach the TV input.
- 2 Press PIP (the window picture appears).

To change the window picture:

- 1 Press VTR/DVD (FUNCTION).
- 2 Press the main CH +/- buttons to change channels.

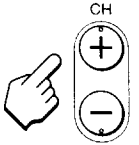

To change the main picture:

- 1 Press TV (FUNCTION).
- 2 Press the main CH +/- buttons to change channels.

Notes

- If you have the same program in both the window and the main picture and cannot change the channel in the window; press TV/VIDEO until you reach the TV input in the main picture.
- Your remote control must be programmed to operate the VCR. (see page 30)

Watching two programs at one time - PIP (continued)

Dual Tuner PIP

•KV-32S65, 32V65, 35S65, 35V65 only

If you have model KV-32S45 or 35S45, see pages 17-18.

These models are equipped with dual tuners. This means that PIP is "ready to use".

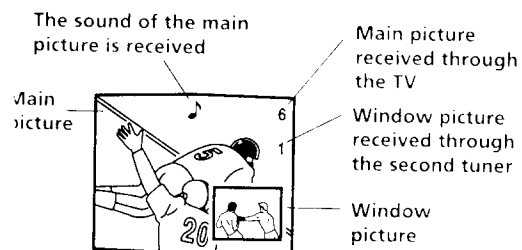

Notes

You must press TV (FUNCTION) before you can control PIP with the yellow labeled buttons.

The AUX input cannot be viewed in the window picture.

Use the Yellow Labeled Buttons for PIP Operations

PIP 	Press once to display the window picture (1/9 size). Press again to reduce the size of the window picture (1/16 size). Press a third time to remove the window picture.
TV/VIDEO 	Press repeatedly to cycle through available video inputs: TV, VIDEO 1, VIDEO 2, VIDEO 3
AUDIO 	Press to alternate sound between the main picture and the window picture. A musical note will appear for a few seconds to indicate which picture is receiving sound.
TV/VTR + CH - 	Press to change the TV channel in the window picture.
POSITION 	Press to move the location of the window picture (counterclockwise) around the main picture.
FREEZE 	Press to freeze the window picture. Great for copying down phone numbers, addresses, recipes, etc. <i>Press FREEZE again to restore the picture.</i>
SWAP 	Press to switch the audio and video of the main picture and the window picture. Each time you press SWAP, the picture and sound of the two will be <i>swapped</i> .

Learning menu selection

Use the MENU button to access a menu and use the arrow buttons (▲ or ▼) to alter settings. Use the following example, in which we activate the CABLE, to learn how to modify settings.

1 Press the MENU button.

The main menu appears.

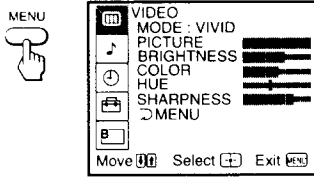

2 Press ▲ or ▼ to highlight the desired menu (in this case SET UP) and press ◀ to select it.

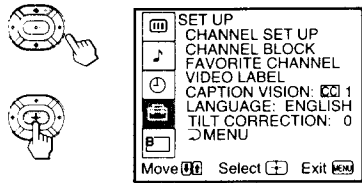

3 Press ▲ or ▼ to move to the desired option.

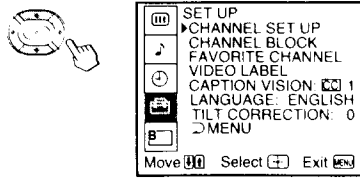

4 Press ▶.

Options for your selection will be highlighted.

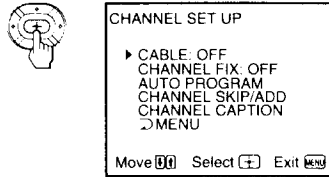

5 Press ▲ or ▼ to make your selection and press ◀.

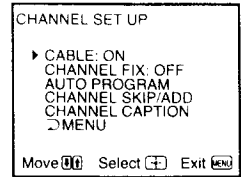

When you are finished making changes to the selected menu, choose ▶ MENU to return to the main menu.

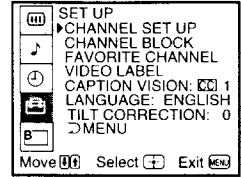

Notes

- Pressing MENU on the remote control will allow you to exit from the menus at any time.
- If any menu items are "grayed out", press the ANT button on your remote control until a channel number appears.

Quick start to the menus

The following is a guide to your menus. It will give you a quick start to the options available for setting up your TV.

The menus shown are for model KV-35S45, your menus may look different from those illustrated.

For detailed information on using the remote control to modify menu settings, refer to "Learning menu selection" on page 20.

To select a menu:

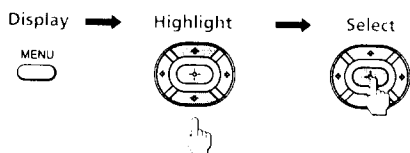

	<p>The VIDEO menu will allow you to make adjustments to your picture settings. It will also allow you to customize the picture MODE based on the type of program you are viewing.</p>
	<p>The AUDIO menu offers enhanced audio options such as listening to second audio programming (SAP), or customizing the EFFECT of the sound on your TV.</p>
	<p>The TIMER menu sets the clock on your TV and allows you to program your TV for scheduled viewing using the ON/OFF TIMER.</p>
	<p>The SET UP menu provides several options for setting up your channels, labeling your TV/VIDEO inputs, and selecting the LANGUAGE of your menus.</p> <p>The CHANNEL SET UP menu is a sub-menu which provides further options for setting up your TV.</p> <div data-bbox="1347 645 1542 792" style="border: 1px solid black; padding: 5px;"> <p>CHANNEL SET UP</p> <p>▶ CABLE: ON</p> <p>CHANNEL FIX: OFF</p> <p>AUTO PROGRAM</p> <p>CHANNEL SKIP/ADD</p> <p>CHANNEL CAPTION</p> <p>▶ MENU</p> <p>Move [Left] Select [Enter] Exit [Exit]</p> </div>
	<p>The Basic Menu provides quick access to frequently used settings.</p> <div data-bbox="1347 833 1542 967" style="border: 1px solid black; padding: 5px;"> <p>▶ VIDEO MODE: VIVID</p> <p>PICTURE: [Bar]</p> <p>AUDIO: SURROUND OFF</p> <p>ADVANCED MENU</p> <p>Move [Left] Select [Enter] Exit [Exit]</p> </div>

Using the VIDEO menu

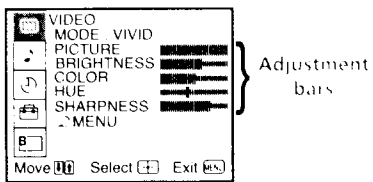

For detailed information on using the remote control to modify menu settings, refer to "Learning menu selection" on page 20.

To select the VIDEO menu:

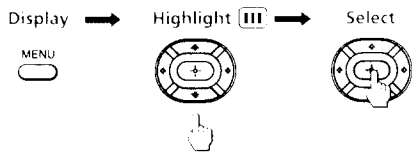

To restore the factory VIDEO settings

Press RESET while the VIDEO menu is displayed.

MODE <i>Customize picture viewing</i>	VIVID: Select for a vivid, bright picture for daytime viewing. STANDARD: Select to receive a standard picture. MOVIE: Select for night time movie viewing.
PICTURE <i>Picture contrast</i>	Adjust left to decrease picture contrast and soften the color. Adjust right to increase picture contrast and create more vivid color.
BRIGHTNESS <i>Picture adjustment</i>	Adjust left to darken the picture. Adjust right to brighten the picture.
COLOR <i>Color saturation</i>	Adjust left to decrease color intensity or saturation. Adjust right to increase color intensity or saturation.
HUE <i>Color tones</i>	Adjust left to increase the red tones. Adjust right to decrease the red tones.
SHARPNESS <i>Picture detail</i>	Adjust left to soften the picture detail. Adjust right to sharpen the picture detail.

Using the AUDIO menu

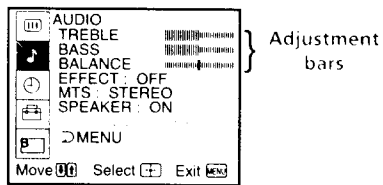



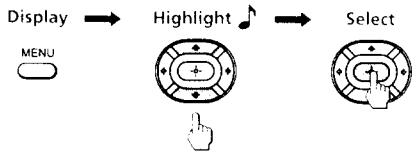

For detailed information on using the remote control to modify menu settings, refer to "Learning menu selection" on page 20.

To select the AUDIO menu:



To restore the factory AUDIO settings

Press RESET while the AUDIO menu is displayed.

TREBLE	Adjust left or right to decrease or increase higher pitched sound.
BASS	Adjust left or right to decrease or increase low pitched sounds.
BALANCE	Adjust left or right to emphasize right and left speaker volume.
AUTO VOLUME <i>Stabilizes volume</i>	(KV-32V40, 32V65, 35V65 only) ON: Select to stabilize the volume. OFF: Select to turn AUTO VOLUME off. Press  for direct selection of AUTO VOLUME settings.
EFFECT <i>Enhanced audio options</i>	Press  or  to select one of these customized effects: SURROUND: Simulates theater quality sound (only for stereo programs). (KV-32S40, 32S45, 32S65, 35S40, 35S45, 35S65 only) Press  for direct selection of SURROUND settings. SIMULATED: Adds a stereo-like effect to mono programs. (KV-32V40, 32V65, 35V65 only) SRS: Produces a dynamic three dimensional sound for stereo audio signals. (KV-32V40, 32V65, 35V65 only)

Using the AUDIO menu (continued)

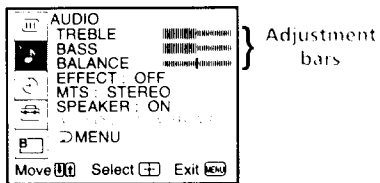

For detailed information on using the remote control to modify menu settings, refer to "Learning menu selection" on page 20.

To select the AUDIO menu:

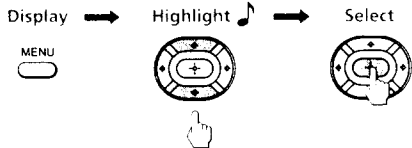

<p>MTS <i>Use to select through language programs</i></p>	<p>MTS: Press \blacktriangle or \blacktriangledown to select one of the following options: STEREO: Select when viewing a broadcast in stereo. SAP: Select to listen to bilingual broadcast. (Non-SAP programs will be muted when this feature is selected) MONO: Select to reduce noise during stereo broadcasts for areas of weak reception. Quick MTS access: Press MTS on your remote control to cycle through the MTS options.</p>
<p>SPEAKER <i>Custom selection of audio output source</i></p>	<p>ON: Select to listen to the sound from the TV speakers with or without a separate stereo system. OFF: Select to turn off the TV speakers and listen to the TV's sound only through external audio system speakers.</p>
<p>AUDIO OUT <i>Use to control the TV's volume through a stereo</i></p>	<p>AUDIO OUT can only be set when SPEAKER is set to OFF. VARIABLE: Sound output varies according to the TV settings. Useful when you want to use your TV's remote control to adjust the output of a separate audio system. FIXED: Sound output is held at a fixed level through your stereo. Use your A/V receiver's remote control to adjust the volume.</p>

Using the TIMER ⌚ menu

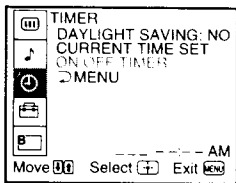

For detailed information on using the remote control to modify menu settings, refer to "Learning menu selection" on page 20.

To select the TIMER ⌚ menu:

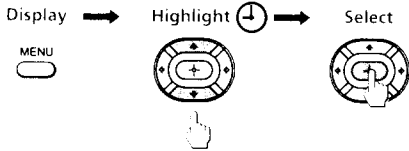

To cancel the ON/OFF TIMER function

Press RESET while the ON/OFF TIMER menu is displayed.



At DAYLIGHT SAVING time before setting the clock.

<p>DAYLIGHT SAVING <small>ALWAYS ADVISES PREVIOUS</small></p>	<p>Spring: Select YES to compensate for Daylight Saving Time. <i>The current time moves one hour ahead.</i> Fall: Select NO at the end of Daylight Saving Time. <i>The current time moves back one hour.</i></p>
<p>CURRENT TIME SET <small>Necessary for the ON/OFF TIMER</small></p>	<p>With the CURRENT TIME SET menu open:</p> <ol style="list-style-type: none"> 1 Press [Enter]. 2 Press ↑ or ↓ until the current day is displayed. Press [Enter] to select. 3 Press ↑ or ↓ until the current hour and AM/PM is displayed. Press [Enter] to select. 4 Press ↑ or ↓ until the current minute is displayed, press [Enter]. <p>The clock is set. Press MENU to exit. <i>Any loss of power will cause these settings to be erased.</i></p> <div data-bbox="1317 290 1549 465" style="border: 1px solid black; padding: 5px;"> <p>CURRENT TIME SET --:-- AM >MENU Move [Left/Right] Select [Enter] Exit [Exit]</p> </div>
<p>ON/OFF TIMER <small>Wake up or scheduled viewing</small></p>	<p>With the ON/OFF TIMER menu open:</p> <ol style="list-style-type: none"> 1 Press [Enter]. 2 Press ↑ or ↓ until the desired day or range of days is displayed. Press [Enter] to select. 3 Indicate the time that you want the TV to turn on by pressing ↑ or ↓ and then [Enter]. 4 Set the time duration (maximum of 6 hours) by pressing ↑ or ↓ and then [Enter]. 5 Press ↑ or ↓ until you reach the desired channel. Press [Enter] to select. <p>The ON/OFF TIMER is now set. Press MENU to exit. <i>When you perform AUTO PROGRAM, all ON/OFF TIMER settings will be erased.</i></p> <div data-bbox="1312 612 1544 787" style="border: 1px solid black; padding: 5px;"> <p>ON/OFF TIMER --:-- AM _h CH_-- >MENU SUN 12:00 AM Move [Left/Right] Select [Enter] Exit [Exit]</p> </div>

Using the SET UP menu



For detailed information on using the remote control to modify menu settings, refer to "Learning menu selection" on page 20.

To select the SET UP menu:

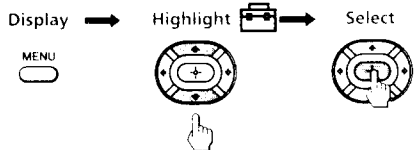

Notes

- The FAVORITE CHANNEL feature is not available for the AUX input.
- Your remote control can be programmed to operate your cable box. (see page 32)
- After setting CABLE; you will need to run AUTO PROGRAM.
- ON/OFF TIMER and CHANNEL BLOCK settings will be erased when CHANNEL FIX is set.

CHANNEL SET UP

Basic setup options for viewing

With the CHANNEL SET UP menu open: Press \uparrow or \downarrow to access a feature, then press \rightarrow .

CABLE: Select ON if your TV is connected to a cable system.

CHANNEL FIX: Press \uparrow or \downarrow to set the TV's input to one of the following options:

2-6: When a cable box is connected to the VHF/UHF input. Press DBS/CABLE (FUNCTION) and then CH +/- to change channels through your cable box.

AUX 2-6: When a cable box is connected to AUX and a cable or antenna is connected to VHF/UHF. You can alternate between the two inputs by pressing ANT on the remote control. (KV-32S65, 32V65, 35S65, 35V65 only)

VIDEO 1: When you have connected video equipment (e.g. A/V receiver) and you want the TV input fixed to it. You will be able to alternate between video sources using the A/V receiver.

OFF: When you want to turn CHANNEL FIX off.

AUTO PROGRAM: Instructs the TV to program all receivable channels.

CHANNEL SKIP/ADD: With the CHANNEL SKIP/ADD window open:

- 1 Select the desired channel.
- 2 Press \rightarrow to SKIP or ADD (only one option will be available).

CHANNEL CAPTION: Label up to 12 channels with their call letters (up to four letters).

With the CHANNEL CAPTION menu open:

- 1 Press \rightarrow and then \uparrow or \downarrow to access the desired channel, and press \rightarrow again.
- 2 Press \uparrow or \downarrow to display the first letter or number of the caption and press \rightarrow to select it.
- 3 Press \rightarrow to activate. To erase a caption, press RESET.

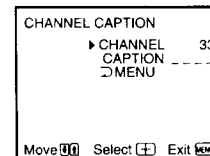
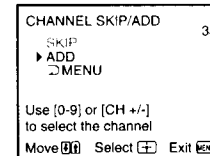
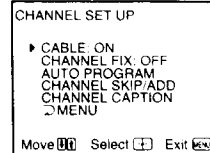

CHANNEL BLOCK
Prevent child access to certain channels

With the CHANNEL BLOCK window open:
1 Choose 1 or 2 and press **[OK]**.
2 Press **▲** or **▼** to display the channel you want to block, press **[OK]** to activate.
 When you select the blocked channel, BLOCKED will appear on the screen.
When you perform AUTO PROGRAM, your CHANNEL BLOCK settings will be erased.
To erase the CHANNEL BLOCK settings, press RESET while the CHANNEL BLOCK menu is displayed.

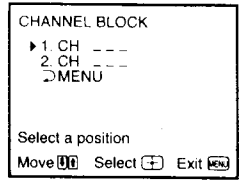

FAVORITE CHANNEL
Quick access to favorite channels

Setting FAVORITE CHANNEL:
1 Press **[OK]** and then **▲** or **▼** to select AUTO or MANUAL. (Selecting AUTO will display the last five channels chosen with the remote control's 0-9 buttons.)
2 Press **▲** or **▼** to move the cursor to 1, 2, 3, 4 or 5 and press **[OK]**.
3 Press **▲** or **▼** to access the desired channel and press **[OK]**.
For KV-32S65, 32V65, 35S65, 35V65 only, you can preview your favorite channels in the window picture.
To do so, set PREVIEW to ON.

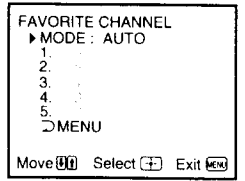

Using FAVORITE CHANNEL:
1 Press **[OK]** when in normal viewing mode. Your FAVORITE CHANNEL options will appear.
2 Press **▲** or **▼** to access the channel you want to watch, and press **[OK]**.
For models KV-32S65, 32V65, 35S65, 35V65 only, if PREVIEW is ON, a window picture displays your favorite channels as you cycle through the options.

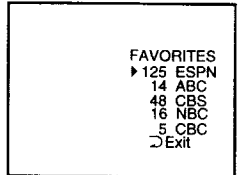

Using the SET UP menu (continued)

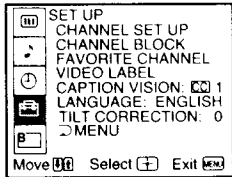

For detailed information on using the remote control to modify menu settings, refer to "Learning menu selection" on page 20.

To select the SET UP menu:

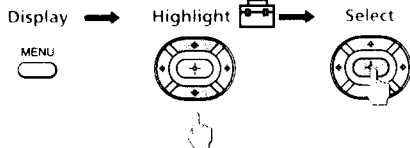

<p>VIDEO LABEL</p> <p>VIDEO LABEL</p> <p>VIDEO LABEL</p> <p>VIDEO LABEL</p>	<p>With the VIDEO LABEL window open:</p> <ol style="list-style-type: none"> 1 Press \blacktriangle or \blacktriangledown to access the input mode you want to label and press \blacktriangleright. 2 Press \blacktriangle or \blacktriangledown to choose the label and press \blacktriangleright. <p>VIDEO LABEL Options:</p> <p>VIDEO 1: VHS, 8mm, BETA, LD, GAME, DBS, DVD, WEB, RECEIVER, DTV.</p> <p>VIDEO 2/3: VHS, 8mm, BETA, LD, GAME, DBS, DVD, WEB, RECEIVER, DTV, SKIP.</p> <p><i>When VIDEO LABEL is set to WEB, the picture will darken, creating an ideal picture for WebTV viewing. If you select SKIP, your TV will skip this connection when you cycle through video sources using the TV/VIDEO button.</i></p>	
<p>LANGUAGE</p>	<p>Select from available languages to display all menus in your language of choice.</p>	
<p>TILT CORRECTION</p>	<p>(KV-35S40, 35S45, 35S65, 35V65 only)</p> <p>Press \blacktriangle or \blacktriangledown to correct any tilt of the picture between +5 and -5 and press \blacktriangleright.</p>	

Using the Basic Menu

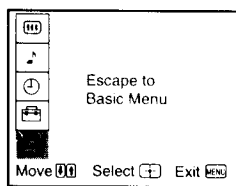

For detailed information on using the remote control to modify menu settings, refer to "Learning menu selection" on page 20.

How to select the Basic Menu:

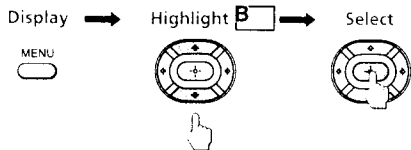

Note

- The TV automatically displays the last menu used when MENU is pressed.

Basic Menu

Quick access to frequently used settings

With the Basic Menu window open:

- Press \uparrow or \downarrow to access the feature you want to change.
- Press \rightarrow to select.

VIDEO MODE: Press \uparrow or \downarrow to set the TV to one of the following settings:

VIVID, STANDARD, MOVIE (see page 22)

PICTURE: Press \uparrow or \downarrow to adjust the picture contrast. (see page 22)

AUDIO: Press \uparrow or \downarrow to set your audio to one of the following settings: (see page 23)

SURROUND: KV-32S40, 32S45, 32S65, 35S40, 35S45, 35S65 only

SRS/SIMULATED: KV-32V40, 32V65, 35V65 only

ADVANCED MENU: Select when you want to return to the main menus.

▶VIDEO MODE: VIVID
PICTURE:
AUDIO: SURROUND OFF
ADVANCED MENU
Move \leftarrow Select \rightarrow Exit B

Programming the remote

You can use the supplied remote control to operate Sony or non-Sony video equipment.

- 1 Press CODE SET.
- 2 Press VTR/DVD (FUNCTION).
- 3 Use the 0-9 buttons to key in the manufacturer's code number from the following chart.
- 4 Press ENTER.

VCR code numbers

Manufacturer	Code
Sony	301, 302, 303
Admiral (M. Ward)	327
Aiwa	338, 344
Audio Dynamic	314, 337
Broksonic	319, 317
Canon	309, 308
Citizen	332
Craig	302, 332
Criterion	315
Curtis Mathis	304, 338, 309
Daewoo	341, 312, 309
DBX	314, 336, 337
Dimensia	304
Emerson	319, 320, 316, 317, 318, 341
Fisher	330, 335
Funai	338
General Electric	329, 304, 309
Go Video	322, 339, 340

Goldstar	332
Hitachi	306, 304, 305, 338
Instant Replay	309, 308
JC Penney	309, 305, 304, 330, 314, 336, 337
JVC	314, 336, 337, 345, 346, 347
Kenwood	314, 336, 332, 337
LXI (Sears)	332, 305, 330, 335, 338
Magnavox	308, 309, 310
Marantz	314, 336, 337
Marta	332
Memorex	309, 335
Minolta	305, 304
Mitsubishi/MGA	323, 324, 325, 326
Multitech	325, 338, 321
NEC	314, 336, 337
Olympic	309, 308
Optimus	327
Panasonic	308, 309, 306, 307
Pentax	305, 304
Philco	308, 309
Philips	308, 309, 310
Pioneer	308
Quasar	308, 309, 306
RCA/PROSCAN	304, 305, 308, 309, 311, 312, 313, 310, 329
Realistic	309, 330, 328, 335, 324, 338
Sansui	314
Samsung	322, 313, 321
Sanyo	330, 335
Scott	312, 313, 321, 335, 323, 324, 325, 326
Sharp	327, 328
Shintom	315
Signature 2000 (M. Ward)	338, 327
SV2000	338
Sylvania	308, 309, 338, 310
Symphonic	338

Tashiro	332
Tatung	314, 336, 337
Teac	314, 336, 338, 337
Technics	309, 308
Toshiba	312, 311
Wards	327, 328, 335, 331, 332
Yamaha	314, 330, 336, 337
Zenith	331

Operating a VCR	Buttons on the remote control
To turn on or off	Press VTR/DVD (POWER).
To select a channel directly	Press the 0 - 9 buttons.
To change channels	Press CH +/-.
To record	Press ▶ and ● simultaneously.
To play	Press ▶ .
To stop	Press ■ .
To fast forward	Press ▶▶ .
To rewind the tape	Press ◀◀ .
To pause	Press . To resume normal playback, press again or press ▶ .
To scan	Press ▶▶ or ◀◀ during playback. To resume normal playback, release the button.
To change input mode	Press TV/VTR.

Tips 

- In some rare cases, you may not be able to operate your non-Sony video equipment with the supplied remote control. In this case, please use the equipment's own remote control.
- When you remove the batteries, the code number may revert to the factory setting.
- The code numbers for Sony VCR's are assigned at the factory as follows:

VHS VCR	301
(preset code for the supplied remote control)	
8 mm VCR	302
Beta, ED Beta VCRs	303

MDP (Multi Disc Player) code numbers

Manufacturer	Code
Sony	701
Panasonic	704, 710
Pioneer	702

Operating an MDP Buttons on the remote control

To turn on or off	Press VTR/DVD (POWER).
To play	Press ▶ .
To stop	Press ■ .
To pause	Press ⏸ . To resume normal playback, press again or press ▶ .
To scan	Press ⏮ or ⏭ during playback. To resume normal playback, press ▶ .
To search the chapter forward or backward	Press CH +/-.

Tip 

If you will not be programming a DBS or cable box into the DBS/CABLE input, you can use it to program other video equipment (e.g. DVD, MDP, or second VCR). (see page 30)

DVD (Digital Versatile Disc) code numbers

Manufacturer	Code
Sony	751
Panasonic	753
Pioneer	752
RCA	755
Toshiba	754

Operating a DVD player Buttons on the remote control

To turn on or off	Press VTR/DVD (POWER).
To play	Press ▶ .
To stop	Press ■ .
To pause	Press ⏸ . To resume normal playback, press again or press ▶ .
To scan	Press ⏮ or ⏭ during playback. To resume normal playback, press ▶ .
To search the chapter forward or backward	Press CH +/-.
To select chapters directly	0-9 + ENTER.
MENU	Press to display DVD menu.
To move cursor in menu	Use your arrow buttons ⬆ , ⬇ , ⬅ , ➡ .

Programming the remote

You can program the supplied remote control to operate a cable box or DBS receiver.

- 1 Press CODE SET.
- 2 Press DBS/CABLE (FUNCTION).
- 3 Use the 0-9 buttons to key in the manufacturer's code number from the following chart.
- 4 Press ENTER.

For more details on operating the cable box or DBS receiver

Refer to the operating instructions that were supplied with the equipment.

If the remote control doesn't work

- First, try repeating the setup procedures using the other codes listed for your equipment.

Tips

- *If more than one code number is listed, try entering them one by one until you come to the correct code for your equipment.*
- *If you enter a new code number, the code number you previously entered at that setting is erased.*
- *In some rare cases, you may not be able to operate your equipment with the supplied remote control. In this case, use the equipment's supplied remote control.*
- *Whenever you remove the batteries the code numbers may revert to the factory setting.*

Cable box code numbers

Manufacturer	Code
Hamlin/Regal	222, 223, 224, 225, 226
Jerrold/G. I.	201, 202, 203, 204, 205, 206, 207, 208, 218
Oak	227, 228, 229
Panasonic	219, 220, 221
Pioneer	214, 215
Scientific Atlanta	209, 210, 211
Tocom	216, 217
Zenith	212, 213

DBS receiver code numbers

Manufacturer	Code
Sony	801 (preset code for remote control)
General Electric	802
Hitachi	805
Hughes	804
Panasonic	803
RCA/PROSCAN	802, 808
Toshiba	806, 807

Troubleshooting

Consult the table below; it suggests solutions to specific problems.

Problem	What it could be	What you can do
Cannot operate single tuner PIP (KV-32S45, 35S45)	<ul style="list-style-type: none"> VCR may not be connected to your TV properly. VCR may not be turned on. The remote control may not be programmed to operate the VCR. 	<ul style="list-style-type: none"> Ensure that you have set your VCR correctly. (see page 7) Program your remote control to operate the VCR. (see page 30)
A red light keeps flashing on the TV for more than a few seconds	<ul style="list-style-type: none"> Your TV may need service. 	<ul style="list-style-type: none"> Call your local Sony service center.
TV makes a noise when turned on	<ul style="list-style-type: none"> This is a normal function of your TV. 	
Screen is not lit and there is no sound	<ul style="list-style-type: none"> Power cord may not be plugged in. Batteries may not have been placed with the correct polarity. TV/VIDEO setting may be incorrect. 	<ul style="list-style-type: none"> Press TV/VIDEO until you receive a channel.
Poor or no picture (screen lit), good sound	<ul style="list-style-type: none"> VIDEO menu settings may not be adjusted correctly. Antenna/cable connections may be faulty. VIDEO LABEL inputs may be set to WEB. (This label darkens the screen for ideal WebTV viewing) 	<ul style="list-style-type: none"> Readjust your VIDEO menu settings. (see page 22) Check your VIDEO LABEL settings. (see page 28)
Good picture, no sound	<ul style="list-style-type: none"> Sound may be set to MUTE. Your TV may be set to SAP. Speaker may not be set correctly. 	<ul style="list-style-type: none"> Press MUTE. Check the MTS setting in the AUDIO menu. (see page 23) Check your SPEAKER settings. (see page 24)
No color	<ul style="list-style-type: none"> Color settings may not be adjusted correctly. 	<ul style="list-style-type: none"> Adjust the COLOR settings in the VIDEO menu. (see page 22)

Problem	What it could be	What you can do
Only snow and noise appear on the screen	<ul style="list-style-type: none"> • CABLE may not be set correctly in the SET UP menu. • Antenna/cable connections may not be correct. • TV may be set to AUX mode. 	<ul style="list-style-type: none"> • Ensure that you have selected the correct CABLE mode in the SET UP menu. (see page 26) • Press ANT on your remote control to change the input mode. (see page 16)
Cannot receive upper channels (UHF) when using an antenna	<ul style="list-style-type: none"> • CABLE setting may not be correct in the SET UP menu. 	<ul style="list-style-type: none"> • Ensure that CABLE is set to OFF in the SET UP menu. (see page 26) • Use AUTO PROGRAM to add receivable channels that are not presently in TV memory. (see page 26)
Cannot receive any channels when using cable	<ul style="list-style-type: none"> • CABLE setting may not be set correctly in the SET UP menu. 	<ul style="list-style-type: none"> • Ensure that CABLE is set to ON in the SET UP menu. (see page 26) • Use AUTO PROGRAM to add receivable channels that are not presently in TV memory. (see page 26)
Cannot gain enough volume when using a cable box	<ul style="list-style-type: none"> • Volume may not be adjusted on your cable box. 	<ul style="list-style-type: none"> • Press TV (FUNCTION) and adjust the TV's volume.
TV is fixed to one channel	<ul style="list-style-type: none"> • CHANNEL FIX settings may not be correct. 	<ul style="list-style-type: none"> • Check your CHANNEL FIX settings. (see page 26)

If, after reading these operating instructions, you have additional questions related to the use of your Sony television, please call our Direct Response Center at 1-800-222-SONY (7669). (U.S. residents only)

Supplied accessories

Remote control RM-Y165 (1)
(KV-32S40, 32V40, 35S40 only)

Remote control RM-Y167 (1)
(KV-32S45, 32S65, 32V65, 35S45, 35S65, 35V65 only)

Batteries size AA (R6) (2)

Optional accessories

Connecting cables
VMC-810S/820S, VMC-720M,
YC-15V/30V, RK-74A

TV Stand SU-32A3, SU-35A3

U/V mixer EAC-66

	KV- 32S40	32S45	32S65	32V40	32V65	35S40	35S45	35S65	35V65
Power requirements	120 V, 60 Hz	120 V, 60 Hz	120 V, 60 Hz	120 V, 60 Hz	120 V, 60 Hz	120 V, 60 Hz	120 V, 60 Hz	120 V, 60 Hz	120 V, 60 Hz
Number of inputs/outputs									
Video ¹⁾	1	2	2	3	3	2	2	2	3
S Video ²⁾	1	1	1	1	2	1	1	1	2
Audio ³⁾	1	2	2	3	3	2	2	2	3
Audio out ⁴⁾	1	1	1	1	1	1	1	1	1
Monitor out ¹⁾	—	—	—	1	1	—	—	—	1
TV out ^{1) 3)}	—	—	—	—	1	—	—	—	1
S-Link	—	—	Yes	—	Yes	—	—	Yes	Yes
Speaker output (W)	5W x 2	5W x 2	5W x 2	5W x 2	10W x 2	5W x 2	5W x 2	5W x 2	10W x 2
Power consumption (W)									
In use (Max.)	180W	180W	180W	180W	200W	210W	210W	210W	230W
In standby	2W	2W	2W	2W	2W	2W	2W	2W	2W
Dimensions (W/H/D)									
(mm)	791 x 707 x 604.5 mm	791 x 707 x 604.5 mm	791 x 707 x 604.5 mm	821 x 675.3 x 587 mm	821 x 675.3 x 587 mm	870 x 761 x 653 mm	870 x 761 x 653 mm	870 x 761 x 653 mm	920 x 730.8 x 641.8 mm
(in)	31 x 27 13/16 x 23 3/4 in.	31 x 27 13/16 x 23 3/4 in.	31 x 27 13/16 x 23 3/4 in.	32 3/8 x 26 5/8 x 23 1/8 in.	32 3/8 x 26 5/8 x 23 1/8 in.	34 1/4 x 30 x 25 5/8 in.	34 1/4 x 30 x 25 5/8 in.	34 1/4 x 30 x 25 5/8 in.	36 1/4 x 28 3/4 x 25 1/4 in.
Weight (kg)	71.4 kg	72.7 kg	73 kg	70 kg	70 kg	83 kg	83 kg	83 kg	90 kg
(lbs)	157 lbs	160 lbs	160.5 lbs	154 lbs	154 lbs	183 lbs	183 lbs	183 lbs	203 lbs

Television system

American TV standard, NTSC

Channel coverage

VHF: 2-13/UHF: 14-69/CATV: 1-125

Picture tube

Trinitron® tube

Visible screen size

32-inch picture measured diagonally (KV-32S40, 32S45, 32S65, 32V40, 32V65 only)

35-inch picture measured diagonally (KV-35S40, 35S45, 35S65, 35V65 only)

Actual screen size

34-inch picture measured diagonally (KV-32S40, 32S45, 32S65, 32V40, 32V65 only)

37-inch picture measured diagonally (KV-35S40, 35S45, 35S65, 35V65 only)

Antenna

75 ohm external terminal for VHF/UHF

Notes

¹⁾ 1 Vp-p, 75 ohms unbalanced, sync negative

²⁾ Y: 1 Vp-p, 75 ohms unbalanced, sync negative

C: 0.286 Vp-p (Burst signal), 75 ohms

³⁾ 500 mVrms Impedance: 47 kilohms

⁴⁾ More than 408 mVrms at the maximum volume setting (variable)

More than 408 mVrms (fix)

Impedance: 50 kilohms



Design and specifications are subject to change without notice.



(●)® SRS (SOUND RETRIEVAL SYSTEM)

The (●) SRS (SOUND RETRIEVAL SYSTEM) is manufactured by Sony Corporation under license from SRS Labs, Inc. It is covered by U.S. Patent No. 4,748,669. Other U.S. and foreign patents pending.

The word 'SRS' and the SRS symbol (●) are registered trademarks of SRS Labs, Inc.

Licensed by BBE Sound, Inc. under USP 4638258.4482866. BBE and BBE symbol are trademarks of BBE Sound, Inc.

A		CAPTION VISION (closed caption) 16		E	
Adjusting your menus 20	ANT 16	CATV cable 5	Coaxial cable 5	CH +/- 15	Easy Setup Guide 14
Antenna cable 5	Antenna connector 5	CHANNEL SKIP/ADD 26	CHANNEL BLOCK 27	CHANNEL CAPTION 26	Editing using MONITOR OUT 10
AUDIO  button 23	AUDIO menu operations 	CHANNEL FIX 26	COLOR 22	Connecting TV to	EFFECT
AUDIO OUT 24	AUTO VOLUME 23	Antenna 5	Audio system 9	A/V receiver 10	SIMULATED 23
BALANCE 23	BASS 23	Cable 5	Cable box and cable 6	Camcorder 11	SRS 23
EFFECT 23	MTS 24	Cable box and cable 6	DBS receiver 8	DVD receiver and VCR 8	SURROUND 23
SPEAKER 24	TREBLE 23	DBS receiver 8	DVD player 9	S-Link 12	F
AUDIO OUT	FIXED 24	Two VCRs 10	VCR 7	CURRENT TIME SET 25	Factory settings 22, 23
VARIABLE 24	AUTO PROGRAM 26	D	DAYLIGHT SAVING 25	DBS receiver operation 32	FAVORITE CHANNEL 27
AUX Hookup 5	A/V receiver 10	DISPLAY	CAPTION VISION 16	Status 16	FAVORITE CHANNEL w/preview 27
B	BALANCE 23	XDS 16	DVD operation 31	E	FREEZE button 18, 19
Basic Menu  29	BASS 23	Battery installation 13	BRIGHTNESS 22	H	I, J, K
C	CABLE 26	Cable box 6	operation 32	HUE 22	JUMP button 15
Cable box 6	operation 32	L	Language selection 14, 28	Learning menus	L
operation 32	36	AUDIO 23	Basic Menu 29	SET UP 26	TIMER 25
		VIDEO 22			

M, N			
MDP operation	31	SWAP	18, 19
Menu selection	20	TV/VIDEO	17, 19
Mode		Programming the remote	30, 31
MOVIE	22	R	
STANDARD	22	Remote control	13, 15
VIVID	22	FUNCTION buttons	15
MONITOR OUT	10	Illustration	inside front cover
Mono	24	S	
MTS		SAP	24
MONO	24	Safety	3
SAP	24	Select buttons	13
STEREO	24	Adjustment bars	13
MUTING button	15	SET UP menu 	26
O		AUTO PROGRAM	26
On-Screen Help	13	CABLE	26
ON/OFF TIMER	25	CHANNEL SKIP/ADD	26
Operating video equipment	30	CHANNEL CAPTION	26
P, Q		CHANNEL BLOCK	27
Picture-in-Picture (PIP)		FAVORITE CHANNEL	27
Main picture	17	TILT CORRECTION	28
Window picture	17	Setting up TV	14
PIP connections (single tuner)	17	SHARPNESS	22
PIP connections (dual tuner)	19	SLEEP button	16
PIP operations		S-Link Connections	12
AUDIO	17, 19	SPEAKER	
CH+/-	18, 19	ON	24
FREEZE	18, 19	OFF	24
PIP	17, 19	Specifications	34, 35
POSITION	18, 19	Splitter	7
		SWAP button	18, 19
		SYSTEM OFF button	16
		T, U	
		TILT CORRECTION	28
		TIMER menu operations 	
		CURRENT TIME SET	25
		DAYLIGHT SAVING	25
		ON/OFF TIMER	25
		TREBLE	23
		Troubleshooting	33, 34
		TV (FUNCTION) button	15
		TV POWER button	15
		TV/VIDEO button	16
		TV OUT	10
		V, W, X, Y, Z	
		VCR	7
		VCR manufacturer code numbers	30
		VCR operation	30
		VIDEO LABEL	28
		VIDEO menu operations 	
		BRIGHTNESS	22
		COLOR	22
		HUE	22
		MODE	22
		PICTURE	22
		SHARPNESS	22
		VOL +/-	14
		VTR	30
		XDS	16